

THR30II Wireless THR10II Wireless THR10II

Reference Manual



Contents

Introduction	2
Main Features	2
Accessories	2
Names and Functions	3
Control Panel	3
Rear Panel	6
Connection	7
Connection Example (on THR30II Wireless)	7
Power	8
Connecting to guitar by wireless (THR-II Wireless only)	9
Connecting to a smart device	10
Connecting to a computer	12
Troubleshooting	14
Specifications	16
Technical Specifications	16
THR30II Wireless, THR10II Wireless*	
Power Button LED status list	17
Signal Flow Diagrams	18
Amp Modeling List	19

Introduction

Thank you for purchasing this Yamaha product.

This product is an exceptionally versatile and compact guitar amplifier designed for use in your home, rehearsal spaces, and other places—virtually anywhere you want it!

We recommend that you read this manual carefully so that you can fully take advantage of the advanced and convenient functions of the product. We also recommend that you keep this manual for future reference.

Main Features

- **Sophisticated guitar amplifier utilizing advanced amp modeling, made possible with Yamaha's original VCM technology.**
- **Built-in wireless receiver works with the Line 6 Relay G10T transmitter for wireless use (THR30II Wireless and THR10II Wireless only).**
- **Bluetooth® capability enables playing music and editing sound settings from a smart device and a computer.**
- **Built-in rechargeable battery enables use without power adaptor (THR30II Wireless and THR10II Wireless only).**
- **Yamaha's original Extended Stereo technology enables an exceptionally wide stereo image, much wider than the unit's compact size.**
- **The audio interface capability enables recording your guitar to computer via USB.**
- **Incorporates a chromatic tuner.**

* **What is VCM Technology?**

An original physical modeling technology developed by Yamaha, VCM Technology reproduces the characteristics of analog circuitry at the component level to accurately reproduce the sound of the modeled equipment.

Accessories

- **Power Adaptor**
- **Quick Guide**
- **Safety Instructions Sheet**
- **Service Offices list**
- **Cubase AI Download Information**

* In this document, the THR30II Wireless, THR10II Wireless and THR10II are collectively called THR-II. The THR30II Wireless and THR10II Wireless are called THR-II Wireless.

* The LINE 6 wireless transmitters described in this document refer to the Relay G10T and the Relay G10TII (hereinafter abbreviated as the Relay G10T.)

Names and Functions

Control Panel

THR30II Wireless

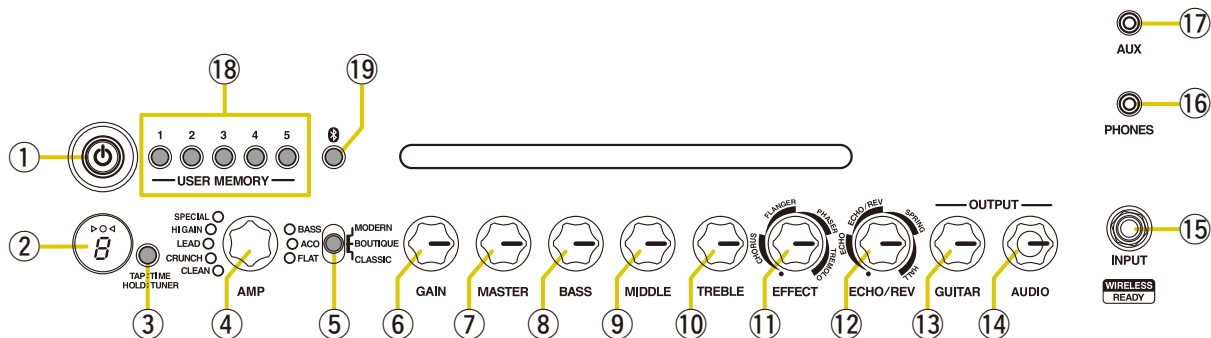

THR10II Wireless THR10II

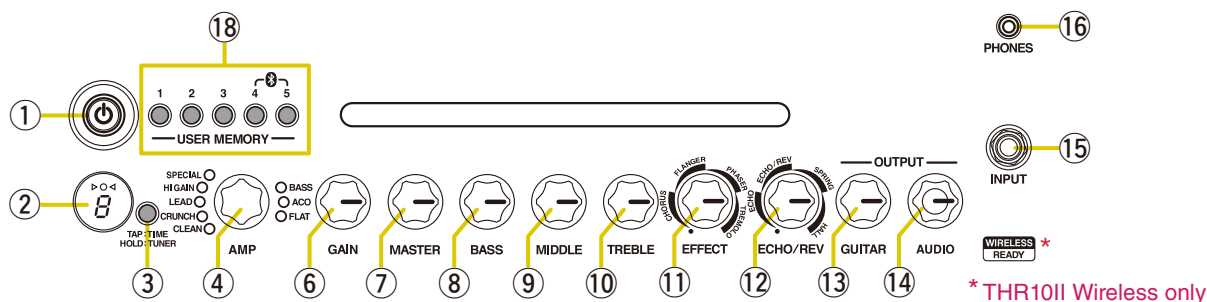

① [⏻] (Power Button) / Power Button LED

This is the unit's power button.

When the power is ON, the Power Button LED, the lamp corresponding to the selected amp type and the Power Lamp in the speaker cabinet light up.

② LED Display

Indicates each of the THR-II's settings and conditions.

③ [TAP/TUNER] button

■ Tuner Function

Holding the switch for 1 second engages the tuner function and lights the ▷ ◯ ◀ indicators.

The tuner is calibrated to A4=440Hz. Tune the guitar until the desired pitch appears in the LED display.

When only the circle (○) in the center of the ▷ ◯ ◀ display is visible, tuning is accurate.

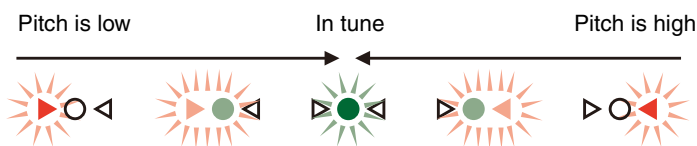

Press the [TAP/TUNER] button (less than one second) to turn OFF the tuner function.

* When the tuner function is set to ON, the guitar sound to the main speaker, [PHONES] jack, and [USB] jack is muted. The sounds from the [AUX] jack, [USB] jack and Bluetooth are output to the main speaker and [PHONES] jack.

■ Tap Tempo Function

When an ECHO or ECHO/REV effect is selected with the [ECHO/REV] knob ⑫ control, the tempo of the delay can be set by tapping (more than twice) on the switch.

■ Extended Stereo Setting

Hold the switch for more than three seconds to switch the Extended Stereo* function ON/OFF.

ON: “#” on LED Display ② is off (default setting).

OFF: “#” on LED Display ② is lit.

* Extended Stereo: The Extended Stereo function produces a much wider stereo field. Extended Stereo affects the sounds from the [AUX] jack, [USB] jack and Bluetooth as well as the reverb effect.

* The Extended Stereo setting (ON/OFF) is saved when the power is turned OFF.

④ [AMP] knob

Selects the amp type. The lamp for the corresponding amp type lights.

* When the power is turned ON, the most recent amp type is selected.

■ Tips on Creating Sound

Using the [GAIN] knob ⑥ and [MASTER] knob ⑦ in combination gives you broad control over the sound for each amp type, except ACO and FLAT. Setting the [GAIN] knob and [MASTER] knob adjusts the amount of preamp and power amp saturation. Once you have the desired sound, use the [GUITAR] knob ⑬ to set the overall volume of the guitar sound.

⑤ [AMP] switch (THR30II Wireless only)

Selects the amp mode. Selects the amp modeling by combination of amp mode and amp type. The [AMP] knob ④ lamp lights for the corresponding amp mode color.

For further details of amp modeling settings that can be selected by combining the amp mode and amp type, refer to the Amp Modeling List ([page 19](#))

⑥ [GAIN] knob

Adjusts the amount of preamp gain. Turn the knob clockwise to increase the amount of gain.

* When ACO is selected with the [AMP] knob ④, the modeled sound is a mixture of the front-mic'd sound and pickup sound of an acoustic electric guitar. (Minimum setting produces the direct pickup sound only. Maximum setting produces the mic sound only.)

⑦ [MASTER] knob

Adjusts the volume for the guitar sound. Turn the knob clockwise to increase the volume and create power amp distortion and change in the low-range frequency.

* When BASS, ACO or FLAT is selected with the [AMP] knob ④, this only adjusts the volume.

⑧ [BASS] knob

Tone adjustment for the guitar's sound. Turn the knob clockwise to enhance the low-range frequencies.

⑨ [MIDDLE] knob

Tone adjustment for the guitar's sound. Turn the knob clockwise to enhance the mid-range frequencies.

⑩ [TREBLE] knob

Tone adjustment for the guitar's sound. Turn the knob clockwise to enhance the high-range frequencies.

⑪ [EFFECT] knob

Selects one of four different effects: CHORUS, FLANGER, PHASER, or TREMOLO. Turn the knob clockwise to increase the amount of each effect.

* Turn the knob fully counterclockwise to set the effect OFF.

12 [ECHO /REV] knob

Selects one of four different effects: ECHO (tape echo), ECHO/REV (tape echo/reverb), SPRING (spring reverb), and HALL (hall reverb).

Turn the knob clockwise to increase the amount of each effect.

- * Turn the knob fully counterclockwise to set the effect OFF.
- * When ECHO or ECHO/REV is selected, the [TAP/TUNER] button ③ can be used to set the delay time.

13 [GUITAR] knob

Adjusts the overall volume of the guitar sound.

- * This knob's setting has no effect on the signal sent to the [USB] jack ⑳.
- * The volume output to the [LINE OUT] [L] [R] jack (THR30II Wireless only) is constant regardless of the setting of the [GUITAR] knob.

14 [AUDIO] knob

Adjusts the audio playback volume for audio from the computer connected to the [USB] jack ⑳, an audio device connected to the [AUX] jack ⑰, or a smart device connected by Bluetooth (page 10).

15 [INPUT] jack

This is a standard phone jack used to connect a guitar to the THR-II.

- * Connecting the Relay G10T to the [INPUT] jack starts charging that device automatically. (THR-II Wireless only)
- * The optimal channel is set automatically by connecting the Relay G10T to the [INPUT] jack for at least 10 seconds. (THR-II Wireless only)

16 [PHONES] jack

This is a stereo mini phone jack used to connect stereo headphones to the THR-II.

- * Speaker sound is muted when a plug is inserted into the [PHONES] jack.

17 [AUX] jack

This is a stereo mini phone jack used to connect an external audio device to the THR-II.

- * The signal received at the [AUX] jack is not sent to the [USB] jack ⑳.

18 [USER MEMORY] [1] [2] [3] [4] [5] button

Saves up to five sets of amp section controller settings (GAIN, MASTER, BASS, MIDDLE, TREBLE, EFFECT, ECHO/REV).

Press and hold the number of the desired [USER MEMORY] button for saving your settings to (about 2 seconds). The save operation is complete when the memory number for the button being pushed appears in the LED Display

②. Press one of the numbered buttons (less than 2 seconds) to recall the saved settings.

- * On the THR10II Wireless and THR10II, enable Bluetooth by pressing the [USER MEMORY] button [4] and [5] simultaneously. (Same as [Bluetooth] button ⑲)

19 [Bluetooth] button (THR30II Wireless only)

Set the Bluetooth. Press and hold for three seconds to activate Bluetooth pairing. The LED display ② will flash in green. For further details, refer to the section "Connecting to a smart device" on page 10.

Rear Panel

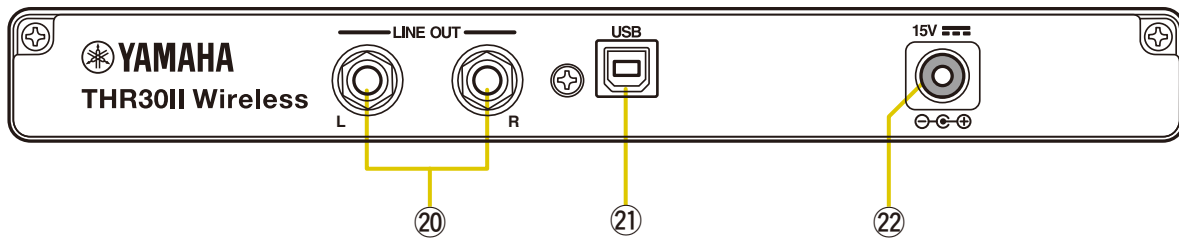

②① [LINE OUT] [L] [R] jack (THR30II Wireless only)

The line outputs are impedance-balanced phone jacks for connection to external devices. These jacks can be connected to TRS phone or mono-type phone plugs.

②② [USB] jack

This jack is used to connect THR-II to a computer via a USB cable.

②③ [15V] DC IN connector

Connects the supplied power adaptor.

About the Default Settings

To reset all contents stored in the user memory, switch on the power while holding down [USER MEMORY] buttons [1], [3], and [5].

NOTICE

All contents stored in the user memory will return to factory defaults when the unit is initialized.

Hold down switches [1], [3], and [5].

Switch on the power.

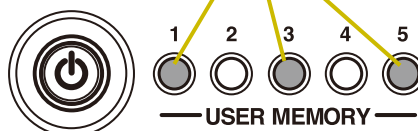

Connection

The THR-II can be used either with a conventional wired connection with an appropriate cable, or with a wireless connection.

Connection Example (on THR30II Wireless)

- Make sure that all devices to be connected to the unit by cable are turned off.
- When connecting the unit to an external device, always use an appropriate cable that matches the jack's specifications and connect it securely.

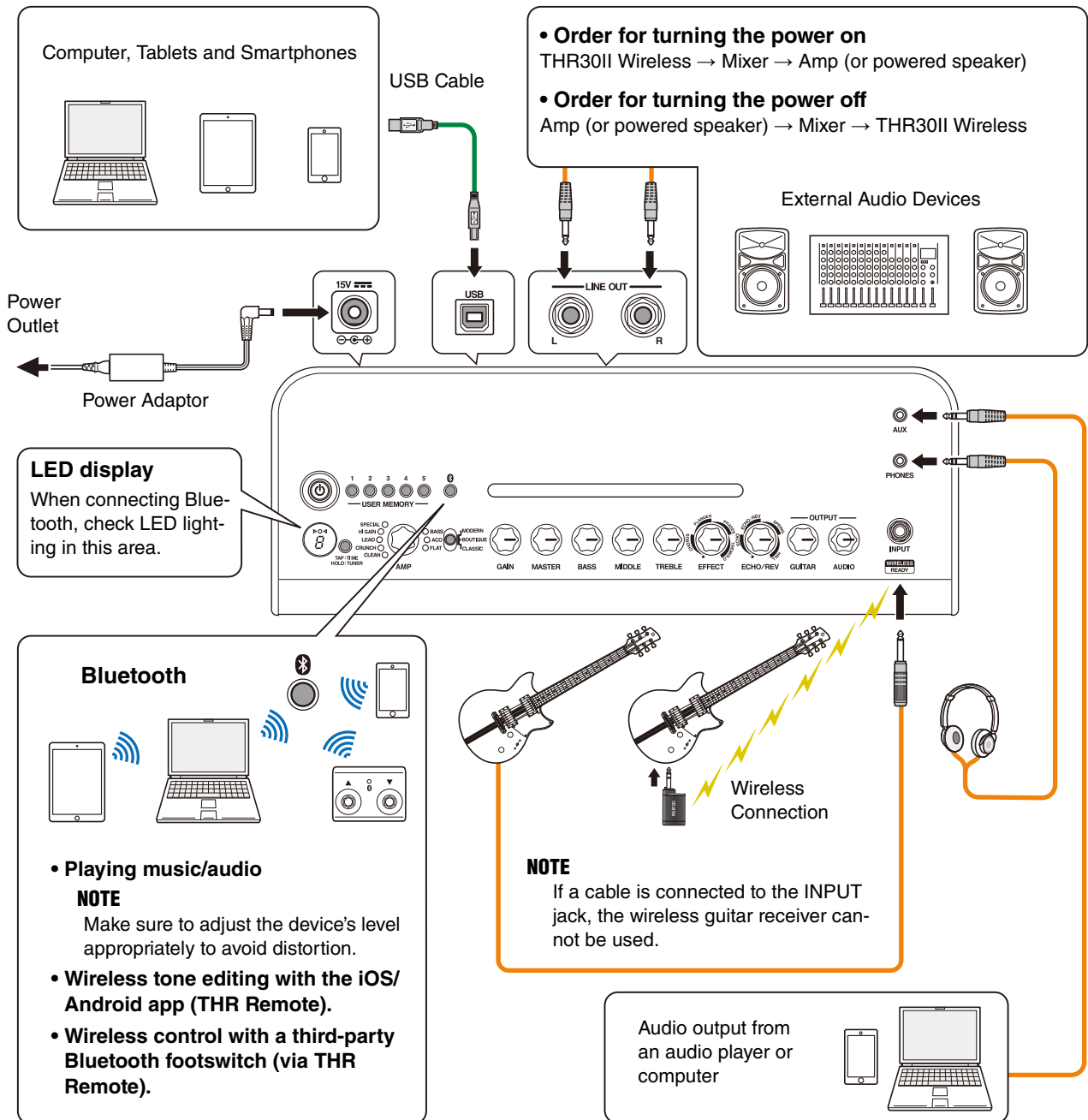

* The illustrations and LCD screens as shown in this manual are for instructional purposes only, and may appear somewhat different from those on your instrument.

Precautions for using the USB jack

Make sure to follow the points at next page when connecting a computer to the THR-II USB jack, to avoid loss of data by the computer and prevent the THR-II from freezing or shutting down.

NOTICE

- Use an AB type USB cable of less than 3 meters. USB 3.0 cables cannot be used.
- Be sure to wake the computer from suspended/sleep/standby mode before connecting a computer to the USB jack.
- Always quit all applications that are running on the computer before connecting or disconnecting the USB cable and set the volume output on the computer to its minimum level.
- When connecting or disconnecting the USB cable, be sure to set the OUTPUT controls ([GUITAR] knob and [AUDIO] knob) on the THR-II to their minimum levels.
- Wait at least 6 seconds between connecting or disconnecting the USB cable.

Power

The THR-II Wireless can operate on either DC power (via the power adaptor) or with the built-in rechargeable battery. The THR10II can operate on DC power (via the power adaptor).

* When you use the THR-II Wireless with the built-in rechargeable battery, the maximum output volume is reduced. (page 16)

■ When using the power adaptor

Connect the supplied power cord to the power adaptor. Connect the supplied power adaptor to the [15V] DC IN jack located on the rear panel of the THR-II. Connect the AC plug to a power outlet.

* Follow the bundled Safety Instruction Sheet before making connections.

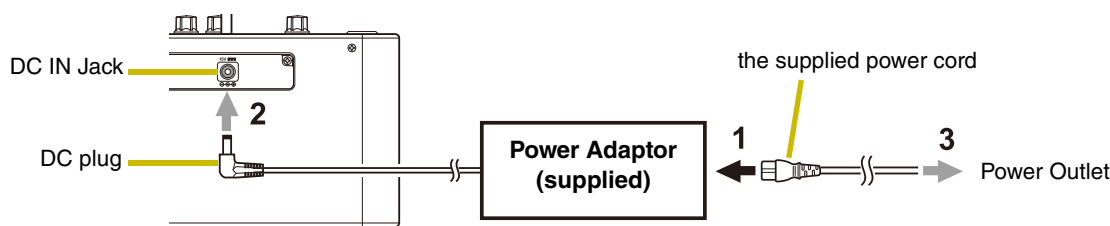

■ Turning the power on and off

Press the [⏻] power button on the top of THR-II for one second to turn the power on. The LED of the power button lights when turning the power button on. The LED of the THR-II Wireless lights in green while charging. Otherwise, it lights in red.

* Follow the bundled Safety Instruction Sheet before making connections.

■ Checking the battery level (THR-II Wireless only)

Press the [⏻] button on top of the THR-II Wireless for less than one second to check the battery level. The remaining battery capacity is displayed in four levels of 3, 2, 1 and L (Low).

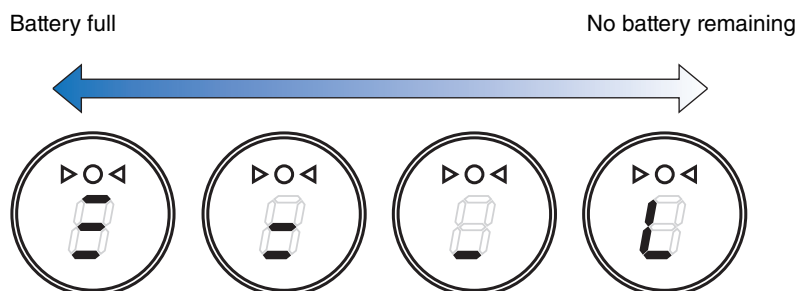

■ Charging the built-in battery (THR-II Wireless only)

Connect the supplied power adaptor to the DC IN jack located on the rear side of the THR-II Wireless. The LED of the power button lights in green while charging.

* For further details of the Power Button LED state, refer to the THR30II Wireless, THR10II Wireless* Power Button LED status list (page 17).

NOTICE

- When you use the THR-II Wireless in an environment of extreme temperatures, charging may not be possible.
- Charge the built-in rechargeable battery once every six months to maintain the function.

■ Charging the Relay G10T (THR-II Wireless only)

Connect the Relay G10T *1 to the [INPUT] jack located on the top of the THR-II Wireless. The built-in rechargeable battery starts *2 charging automatically. If you have disconnected the Relay G10T from the [GUITAR] jack of the THR-II Wireless and want to resume charging, wait for more than two seconds before reconnecting the device to the [GUITAR] jack.

*1 Refer to the manual of Relay G10T for explanations of LED display indications on the Relay G10T.

*2 If the supplied power adapter is not connected to the THR-II Wireless, charging of the Relay G10T will not start.

NOTICE

- After charging, unplug the Relay G10T from the THR-II Wireless.
- When the THR-II Wireless is turned off and the power adapter is connected, the Relay G10T is charged by simply connecting. However, the THR-II Wireless is set to stop supplying power to the Relay G10T when the Relay G10T charging is finished. In this state, leaving the Relay G10T connected to the THR-II Wireless may result in depletion of the Relay G10T's battery power. Turn off the THR-II Wireless's ECO setting to prevent this.

● Changing the Relay G10T's ECO setting *1 *2

1. Switch on the power of THR-II Wireless
2. Switch off the power of THR-II Wireless while holding the [TAP/TUNER] button *3

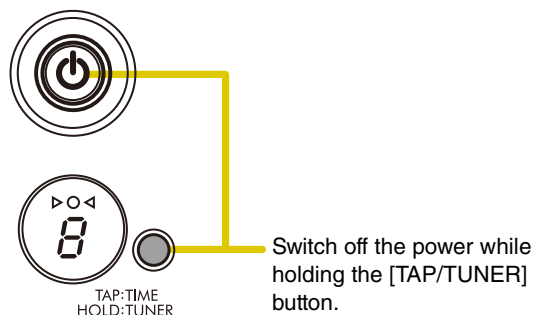

*1 You can change the ECO setting from the THR Remote.

*2 ECO on and ECO off are toggle. When you change the ECO setting, perform the steps 1 to 2 again.

*3 Since the ECO setting changes to ECO off when charging is started on the Relay G10T, "C" will appear on the LED display.

Connecting to guitar by wireless (THR-II Wireless only)

The THR-II Wireless can connect with the Relay G10T wireless guitar transmitter (made by Line 6) by wireless. Moreover, the optimal channel is set automatically by connecting the Relay G10T to the [INPUT] jack located on the top of the THR-II Wireless for at least 10 seconds. For details on wireless connection, refer to the Relay G10T's manual.

Connecting to a smart device

By connecting a smart device to the THR-II, you can:

- Play audio files from a smart device via Bluetooth.
- Edit effect and tone controls from a smart device.

■ Playing audio files on a smart device via Bluetooth

To play audio from a smart device via Bluetooth, configure Bluetooth on the smart device while in the pairing mode.

● Setting the THR-II to pairing mode

1. Check that the  at the top of the LED DISPLAY is unlit (disconnected).
2. Press and hold the [Bluetooth] button* located on the top of the THR-II for three seconds.
3. Check that the LED DISPLAY flashes in green (pairing mode).

● Configuring Bluetooth on the smart device

4. Complete the Bluetooth configuration of the smart device within 3 minutes after entering pairing mode.

* For details on Bluetooth configuration, refer to the manual of your smart device.

5. Check that the LED DISPLAY is lightning in green (connected).

Confirm sound output from the THR-II by playing music from the smart device.

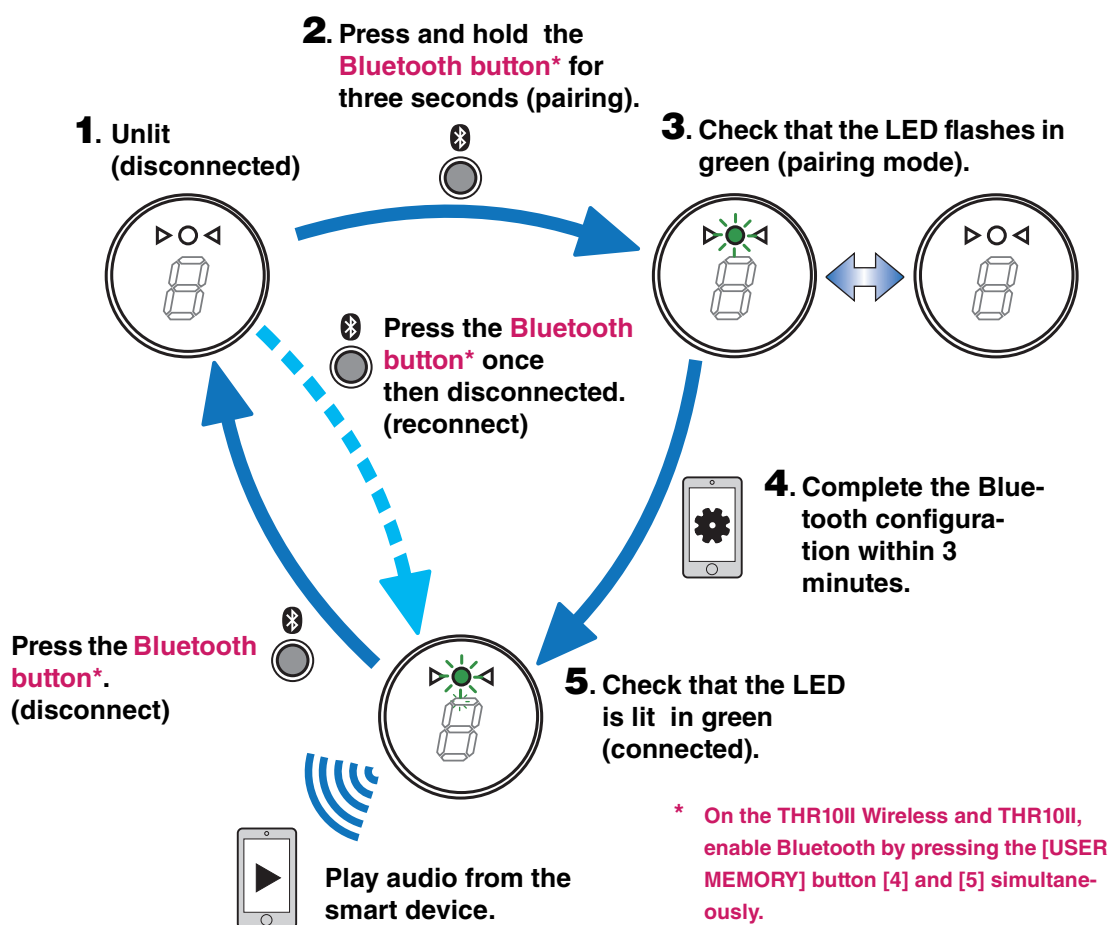

NOTE

- When the Bluetooth connection record remains on both the THR-II and smart device, they will reconnect automatically when the THR-II power is turned on.

■ Editing effects and tone controls on a smart device

Install the THR Remote app to the smart device to allow editing of effects and tone controls on that device.

● Installing THR Remote (Android, iOS)

1. Access the app distribution service on the smart device.
Android devices: Google Play*
iOS devices: App Store
2. Search for the THR Remote app.
3. Download and install the THR Remote app following the onscreen instructions.

● Configuring Bluetooth MIDI

1. Start the THR Remote.
2. Touch the Bluetooth icon on the display.
3. Connect to LE_THR11 following the onscreen instructions.

● Starting the THR Remote app

Start the THR Remote app on the smart device.

Press the desired [USER MEMORY] button for 2 seconds to save the settings made with THR Remote to the THR-II's built-in user memory ([page 5](#)).

- For connecting Android devices, refer to “Smart Device Connection Manual for Android.”
- For connecting iOS devices, refer to “iPhone/iPad Connection Manual.”

Yamaha Downloads. <https://download.yamaha.com/>

* Google Play and the Google Play logo are trademarks of Google LLC.

Connecting to a computer

Connecting a computer to the THR-II makes the following possible:

- **Playing back audio files from a computer through the THR-II.**
- **Recording with Cubase AI.**
- **Editing amp and effect settings using the THR Remote desktop editor.**

■ Playing back audio files from a computer through the THR-II.

● Configuring and Operating

Select the model name (THR30II WIRELESS, THR10II WIRELESS, THR10II) of the connected THR-II as the computer's audio output setting.

Windows

Control Panel → Sound → "Sound" tab

Macintosh

System Preferences → Sound → "Output" tab

Connect the computer's USB connector to the USB connector on the THR-II as shown in the diagram below.

USB Connection diagram

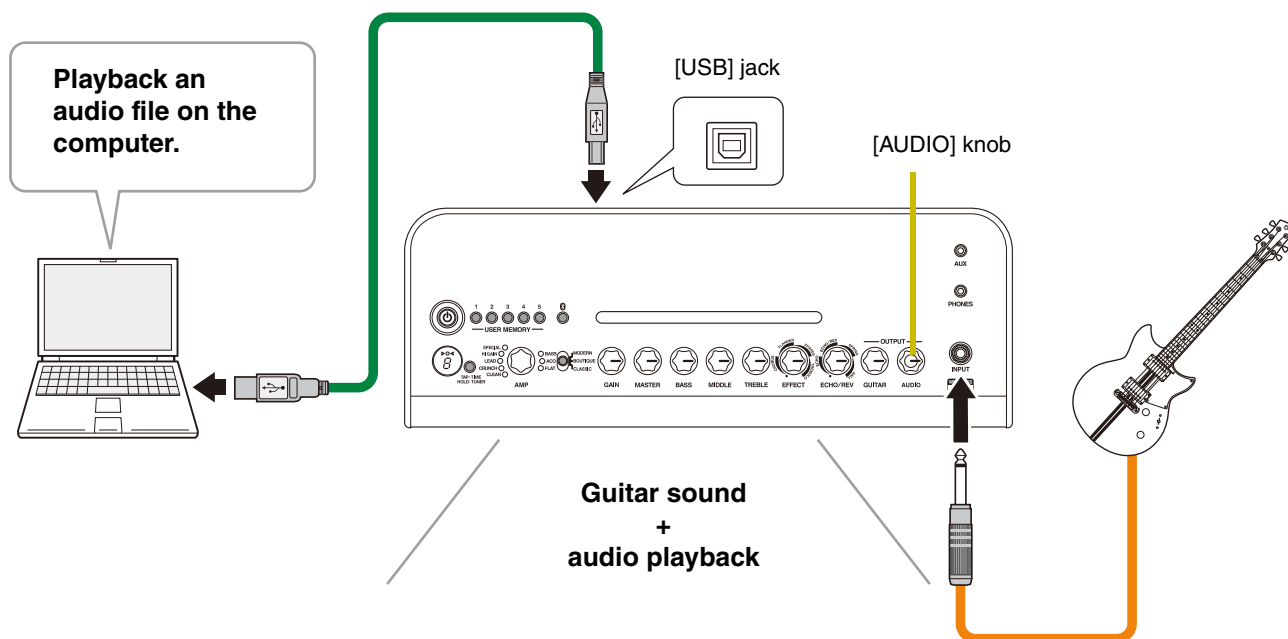

You can play a guitar along to the audio played on the computer.

Use the [AUDIO] knob to adjust the volume of the audio played from a computer.

■ Recording with Cubase AI

● Installing Cubase AI

A download access code for Cubase AI music production software is included with the THR-II. Cubase AI enables you to record, edit, mix and play back audio through your THR-II.

Cubase AI System Requirements

For the latest information, refer to the Steinberg website below.

<https://www.steinberg.net/>

Installing Cubase AI

To install Cubase AI, an active Internet connection is required. Follow the instructions provided in the “Cubase AI Download Information” sheet to download, install and activate the software.

● Connecting to the THR-II

Connect the computer's USB connector to the USB connector on the THR-II as shown in the diagram below. (See the USB Connection diagram on [page 12](#).)

* For more information on operating, refer to the Cubase AI's Help Menu (see the illustration below).



■ Editing effects and tone controls on a computer

● Installing the THR Remote app (Windows, Mac)

1. Access the following website and extract the THR Remote file after downloading.

<https://download.yamaha.com/>

* Check the above website for information on system requirements.

* The THR Remote may be updated without notice. Check the above website for the latest details and updates.

2. Install the THR Remote app to your computer.

● Configuring and Operating after Installing

Connect the computer's USB connector to the [USB] connector on the THR-II as shown in the diagram below. (See the USB Connection diagram on [page 12](#).)

Press the desired [USER MEMORY] button for 2 seconds to save the settings made with THR Remote to the THR-II's built-in user memory ([page 5](#)).

Troubleshooting

No power

- Connect the power adaptor properly (see [page 8](#)).
- Make sure that the THR-II Wireless been properly charged, when the power adapter is disconnected (see [page 8](#)).

No sound

No guitar sound is output (wired connection)

- Connect the guitar to [INPUT] jack properly (see [page 7](#)).
- Make sure that the volume control on the guitar is turned up properly.
- Make sure that the [GAIN] knob, [MASTER] knob and [GUITAR] knob are not set to minimum (see [pages 4, 5](#)).
- When the [AMP] knob is set to CLEAN, make sure that all of the [BASS] knob, [MIDDLE] knob and [TREBLE] knobs are not set to minimum (see [page 4](#)).
- Don't connect the headphones to [PHONES] jack to outputs from the speaker on THR-II (see [page 5](#)).
- Make sure that the COMPRESSOR Level is not set to 0 on the THR Remote app (see [pages 11, 13](#)).
- Set the Tuner function OFF (see [page 3](#)).
- Make sure that the cable connecting the guitar is not damaged.

No guitar sound is output (wireless connection)

- Use the Relay G10T. THR-II Wireless cannot connect to any guitar wireless transmitter other than the Relay G10T.
- Connect the Relay G10T to the INPUT jack located on the top of the THR-II Wireless for at least 10 seconds. The appropriate channel is set automatically.
- Make sure that the volume control on the guitar is turned up.
- Set the Tuner function OFF (see [page 3](#)).

No audio sound is output by Bluetooth

- Confirm the status of LED display. When the LED is unlit or flashing in green, the devices are not connected via Bluetooth (see [page 17](#)).
- When the Bluetooth configuration on the smart device is ON, turn it OFF once and configure "Playing audio files on a smart device via Bluetooth" (see [page 10](#)).
- Delete the Bluetooth registration once on the Bluetooth configuration screen on the smart device and configure "Playing audio files on a smart device via Bluetooth" (see [page 10](#)).
- Move the smart device and the THR-II closer together.
- Turn off the power of the THR-II. (see [page 8](#))
- Restart the smart device.
 - * For details on Bluetooth configuration, refer to the manual of the smart device.
- Disconnect any other Wi-Fi and Bluetooth devices. The connection may be broken due to the influence of other nearby Wi-Fi or Bluetooth devices.

No audio sound is output from a computer by USB connection

- Connect the USB cable properly (see [page 12](#)).
- Confirm the configuration of the audio output port on the computer (see [page 12](#)).
- Confirm the configuration of the computer on the computer or that audio is not muted on the application.
- Make sure the [AUDIO] knob is turned up (see [page 5](#)).
- Make sure the USB cable connecting the devices is not damaged.

No audio sound is output from an external device by AUX connection

- Connect the cable to the external device properly (see [page 7](#)).
- Make sure that the volume control on the external device is turned up.
- Make sure the [AUDIO] knob is turned up (see [page 5](#)).
- Make sure the cable connecting the devices is not damaged.

Others

Tap Tempo cannot be set

- Select ECHO or ECHO/REV. The tap tempo cannot be set with SPRING or HALL (see [page 4](#)).

A “#” appears in the LED display

- When Extended Stereo is set to OFF, a “#” appears in the LED display (see [page 4](#)).

THR-II Wireless cannot be charged

- Keep the THR-II Wireless at room temperature and don't use it until the built-in rechargeable battery reaches a suitable temperature. If charging cannot be performed after a sufficient time, there may be a problem with the built-in rechargeable battery. If the problem persists, consult your Yamaha dealer (see [page 17](#)).

Relay G10T cannot be charged

- When Relay G10T is disconnected from the [INPUT] jack, connect to the [INPUT] jack on THR-II Wireless again after 2 seconds.

Volume is low

- Keep the THR-II Wireless at room temperature and don't use it until the built-in rechargeable battery reaches a suitable temperature. For safety reasons, the built-in rechargeable battery is designed to limit the volume when the built-in rechargeable battery's temperature rises.

The built-in rechargeable battery charge does not last

- THR-II Wireless's built-in rechargeable battery may have reached the end of its life. If the problem persists, consult your Yamaha dealer.
 - Charge the battery every six months to maintain the battery power function.
 - The built-in rechargeable battery has a limited lifetime. The capacity decreases gradually with the number of times of use and the passage of time.
 - The lifetime of the built-in rechargeable battery depends on the storage method, usage and environment.

Specifications

Technical Specifications

Digital Section

Built-in Amp Simulations

CLEAN, CRUNCH, LEAD, HI GAIN, SPECIAL, BASS, ACO*, FLAT

There is an amp mode MODERN, BOUTIQUE, and CLASSIC for each amp type (THR10II Wireless and THR10II can switch the amp mode by THR Remote)

* Mic simulation

Built-in Effects

- CHORUS, FLANGER, PHASER, TREMOLO
- ECHO, ECHO/REVERB, SPRING REVERB, HALL REVERB

In addition to the above, Room and Plate reverbs are also available in the THR Remote editor.

- COMPRESSOR*
- NOISE GATE*

* Only available from THR Remote.

Built-in Chromatic Auto Tuner

Knob/Switch

AMP, GAIN, MASTER, BASS, MIDDLE, TREBLE, EFFECT, ECHO/REV, GUITAR, AUDIO, USER MEMORY button x 5, TAP/TUNER button, Amp switch*, Bluetooth button*

* Only THR30II Wireless

Display

LED x 1

Connections

INPUT (standard mono-type phone jack, unbalanced), LINE OUT (standard phone jack, impedance-balanced), PHONES (stereo mini jack), AUX (stereo mini jack), USB TYPE B, DC IN (15V)

A/D Converter

24-bit + 3 Bit Floating

D/A Converter

24-bit

Sampling Frequency

48 kHz

Memory Allocations

User Memory: 5

Input Level

GUITAR IN : -10 dBu
AUX IN : -10 dBu

PHONES Output Level

10 mW

Rated Output

THR30II Wireless: 30 W (15 W + 15 W)
THR10II Wireless, THR10II: 20 W (10 W + 10 W)

Maximum output during built-in rechargeable battery operation

THR30II Wireless, THR10II Wireless:
15 W (7.5W + 7.5W)

Power Source

Power Adaptor or built-in rechargeable battery

Power Adaptor (YNT345-1530)

Built-in rechargeable battery

Battery life*: About 5 hours

* Depends on usage situation

Power Consumption

THR30II Wireless, THR10II Wireless: 22 W
THR10II: 11 W

Dimensions (W x H x D)

THR30II Wireless:
420 x 195 x 155 mm (16.5" x 7.7" x 6.1")
THR10II Wireless, THR10II:
368 x 183 x 140 mm (14.5" x 7.2" x 5.5")

Weight

THR30II Wireless: 4.3 kg (9 lbs. 8 oz.)
THR10II Wireless: 3.2 kg (7 lbs)
THR10II: 3.0 kg (6 lbs. 1 oz.)

Accessories

- Power Adaptor (YNT345-1530)
- Quick Guide
- Safety Instructions Sheet
- Service offices list
- Cubase AI Download Information

Bluetooth

Bluetooth Version: Bluetooth Ver. 4.2
Supported Profile: A2DP
Compatible Codec: SBC
RF Output Power: Bluetooth class 2
Maximum Communication Range: 10m (33ft) (without obstacles)

* The contents of this manual apply to the latest specifications as of the publishing date. To obtain the latest manual, access the Yamaha website then download the manual file. Since specifications, equipment or separately sold accessories may not be the same in every locale, please check with your Yamaha dealer.

THR30II Wireless, THR10II Wireless* Power Button LED status list

* Since the THR-10II does not have a built-in rechargeable battery, the power button LED status is only red (ON) and off (OFF).

■ When not using the power adaptor

Red



The power is ON

Unlit



The power is OFF

■ When using the power adaptor

Green



Charging

Red



The battery is full and the power is ON

Unlit



The battery is full and the power is OFF

Charging error indication

**Flashes
(green ↔ red)**

When the power is on



Indicates charging error

**Flashes
(green ↔ unlit)**

When the power is off



Indicates charging error

If the built-in rechargeable battery has a charging error, immediately turn off the THR-II Wireless power, unplug the power adaptor, and consult your Yamaha dealer.

Signal Flow Diagrams

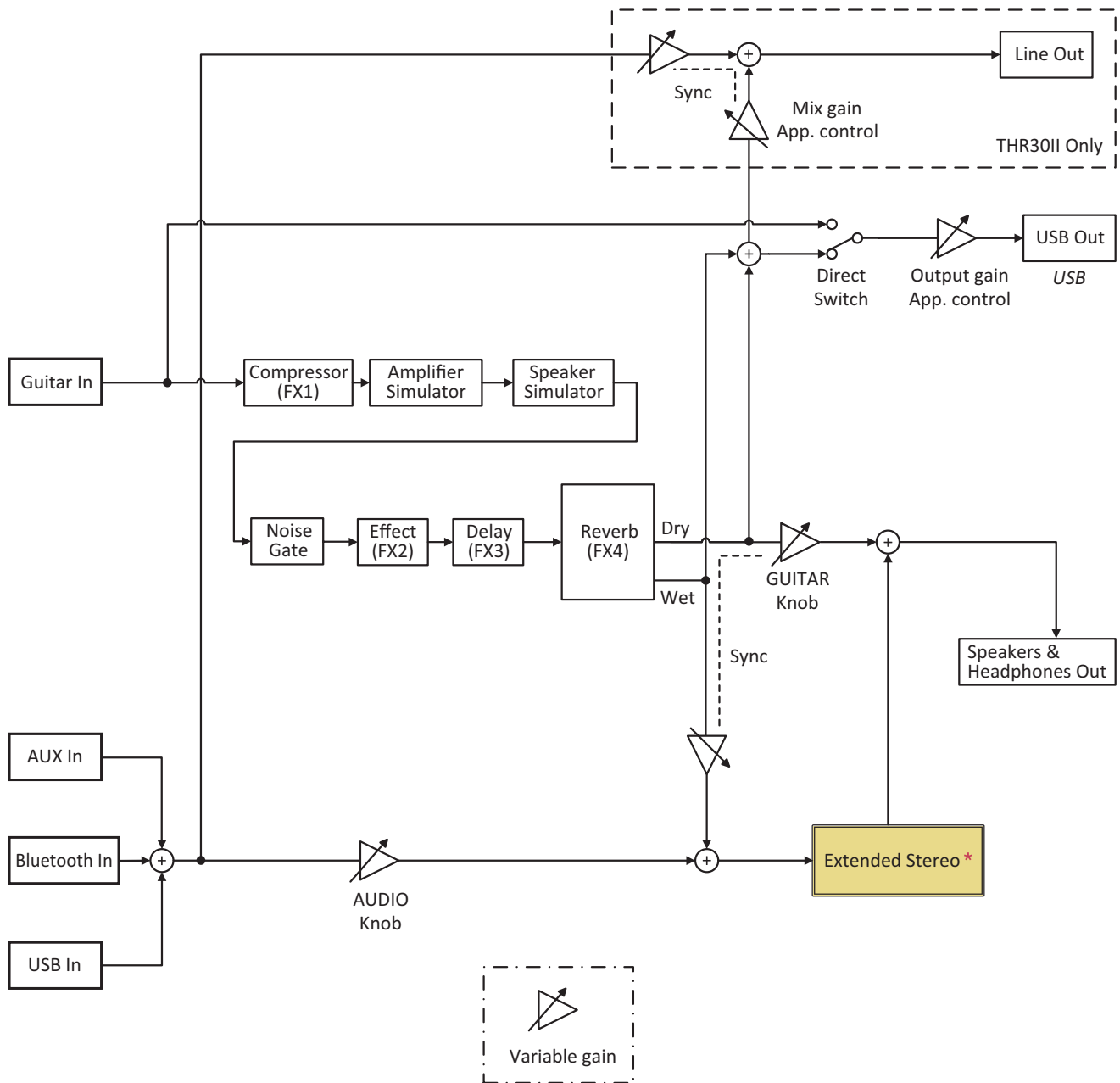

* Extended Stereo is turned off when headphones are connected.

Amp Modeling List

Mode	Amp Type	Description
Classic	Clean	A low-gain preamp for sparkling American-style cleans, with 6L6 tubes in the output stage for brightness and a strong midrange.
	Crunch	EL84 power tubes in a true Class-A configuration with a highly responsive EQ for rich, complex harmonic tones and warm overdrive. Inspired by British chime.
	Lead	A low-gain preamp with an EL34-based power section that breaks into classic British overdrive as the master volume is pushed.
	Hi Gain	Powerful modern distortion that fills out as the high-gain preamp is pushed. Tread carefully after 12 o'clock.
	Special	12AX7 and 6L6 tubes in pursuit of the "Brown" sound. Set the gain around 11 o'clock for classic rock crunch, or crank it for saturated rhythm tones.
	Bass	Woody, vintage tone with late breakup.
	Acoustic	Designed for acoustic-electric guitar, modeling the response of a boutique condenser microphone.
Boutique	Flat	A neutral tone with no amp or speaker modeling. Great for connecting other instruments to your THR.
	Clean	A low-watt EL34 design. Turning up the preamp gain will thicken up the cleans, then push into bluesy overdrive.
	Crunch	A deceptively simple amp circuit with just a single 12AX7 and EL84. A full, no-frills tone that is highly responsive to picking dynamics.
	Lead	A version of the Classic/Lead circuit, modified for extra gain with a darker tone and scooped mids.
	Hi Gain	ECC83s into 6L6s for high gain with a highly responsive EQ, inspired by German engineering.
	Special	Four 12AX7 preamp tubes into 6L6 output tubes. Tight, fast tracking for crushing high-gain.
	Bass	Full, modern tone that breaks into a fuzz-like overdrive when pushed hard.
Modern	Acoustic	Designed for acoustic-electric guitar, modeling the response of a boutique tube microphone.
	Flat	A neutral tone with no amp or speaker modeling, and a slight bass boost. Great for connecting other instruments to your THR.
	Clean	A boutique, low-watt EL84 design that adds fullness and sustain as the master volume is turned up. A great match for neck pickups.
	Crunch	A mid-volume boutique design with 6550 power tubes. Listen for tight bass response and a singing sustain.
	Lead	A high-gain design with 12AX7s into EL34s, for the tone that defined 1980s hard rock and heavy metal.
	Hi Gain	A boosted version of the Classic/Special amp, with even more gain for aggressive rhythms or searing leads.
	Special	A classic overdrive circuit before the preamp tightens low-frequency response and provides even more gain. Ideal for extended-range guitars.
Bass	Vintage voicing with early breakup for overdrive that works well with bass or guitar.	
Acoustic	Designed for acoustic-electric guitar, modeling the response of a boutique dynamic microphone.	
Flat	A neutral tone with no amp or speaker modeling, and a slight mid scoop. Great for connecting other instruments to your THR.	

Manual Development Department
© 2019 Yamaha Corporation
Published 3/2022 PO-C0