

# TASCAM

## TEAC Professional Division

# SX-1

## Digital Audio Production Environment

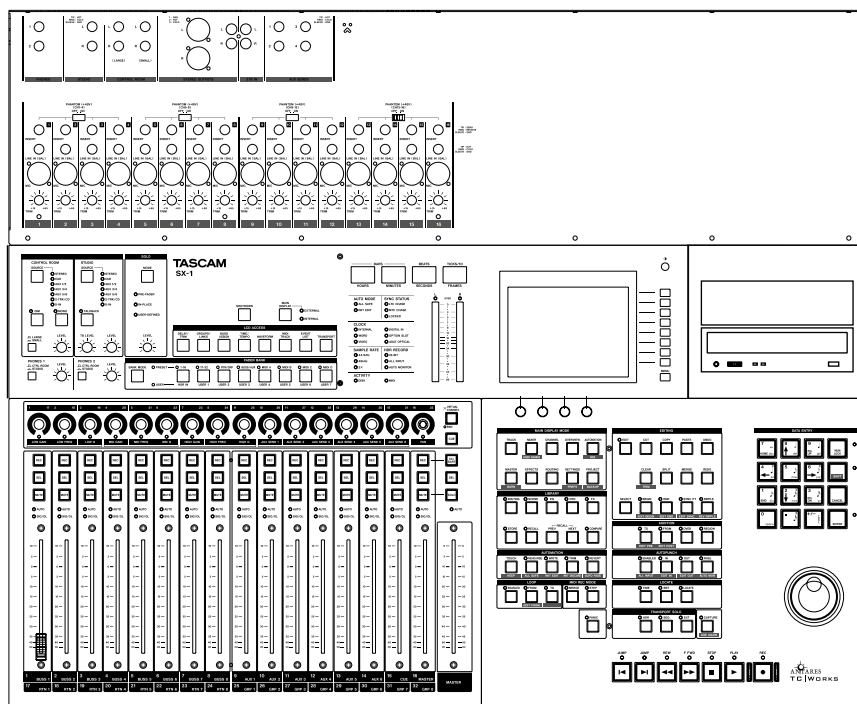

## REFERENCE MANUAL



**CAUTION**  
RISK OF ELECTRIC SHOCK  
DO NOT OPEN



**CAUTION:** TO REDUCE THE RISK OF ELECTRIC SHOCK, DO NOT REMOVE COVER (OR BACK). NO USER-SERVICEABLE PARTS INSIDE. REFER SERVICING TO QUALIFIED SERVICE PERSONNEL.



The lightning flash with arrowhead symbol, within an equilateral triangle, is intended to alert the user to the presence of uninsulated "dangerous voltage" within the product's enclosure that may be of sufficient magnitude to constitute a risk of electric shock to persons.



The exclamation point within an equilateral triangle is intended to alert the user to the presence of important operating and maintenance (servicing) instructions in the literature accompanying the appliance.

This appliance has a serial number located on the rear panel. Please record the model number and serial number and retain them for your records.

Model number \_\_\_\_\_  
Serial number \_\_\_\_\_

**WARNING: TO PREVENT FIRE OR SHOCK HAZARD, DO NOT EXPOSE THIS APPLIANCE TO RAIN OR MOISTURE.**

## TASCAM<sup>®</sup> Software License Agreement

THIS SOFTWARE LICENSE AGREEMENT (“LICENSE”) IS AN AGREEMENT BETWEEN YOU AND TASCAM, A DIVISION OF TEAC AMERICA INC. (“TASCAM”). TASCAM IS WILLING TO LICENSE THE ENCLOSED SOFTWARE TO YOU ONLY UPON THE CONDITION THAT YOU ACCEPT ALL OF THE TERMS CONTAINED IN THIS LICENSE. PLEASE READ THIS LICENSE CAREFULLY BEFORE USING THE SOFTWARE. BY USING THE SOFTWARE YOU INDICATE THAT YOU AGREE TO BE BOUND BY THE TERMS OF THIS LICENSE. IF YOU DO NOT AGREE TO THE TERMS OF THIS LICENSE, TASCAM IS UNWILLING TO LICENSE THE SOFTWARE TO YOU, AND YOU SHOULD PROMPTLY RETURN THE UNUSED SOFTWARE TO THE PLACE WHERE YOU OBTAINED IT FOR A REFUND.

**1. Grant of License.** The application, system and all other software accompanying this License, whether on CD-ROM or any other media (the “Software”), and the related documentation, are licensed to you by TASCAM solely for your own internal purposes, and only as described in the documentation, on a single compatible microcomputer. If the Software is to be used on two or more microcomputers, a separate license must be obtained. Use on a network is not permitted. If this Software is an upgrade to a prior version, then you must be licensed to use the prior version of the Software in order to exercise the license rights granted hereunder, and you may only use the prior version or the upgrade but not both.

**2. Restrictions.** The Software contains copyrighted material, trade secrets, and other proprietary material of TASCAM and its licensors. You agree that in order to protect those proprietary materials, you will not decompile, reverse engineer, disassemble or otherwise reduce all or any part of the Software to human-readable form. You may not modify, rent, lease, loan, sub-license, distribute or create derivative works based upon the Software in whole or in part. You may not copy the Software except to make one additional copy of the Software in the form in which it is provided to you, only for backup purposes and provided you reproduce on such copy the TASCAM copyright notices and any other proprietary legends that are on the original copy of the Software. You may copy the documentation solely for your personal use. You may transfer the Software and related

documentation, and all your license rights thereto, to another party by transferring to that party both the original media on which the Software and related documentation were provided and a copy of this License, and provided that the other party reads and agrees to accept the terms and conditions of this License. Immediately upon transfer, you have no further rights to use or own copies of the Software or related documentation and must destroy all copies in your possession or control. Any transfer of the Software must include all prior versions of the Software.

**3. Ownership.** The Software and documentation are licensed, not sold, to you for use only under the terms of this License, and TASCAM reserves all rights not expressly granted to you in this License. You own the media on which the Software and documentation are recorded but TASCAM and/or TASCAM's licensors retain title to and ownership of the Software and related documentation, and all intellectual property rights therein, including, without limitation, copyright, patent rights and trade secrets.

**4. Termination.** This License is effective until terminated. You may terminate this License at any time by destroying all copies of the Software and related documentation in your possession or control. This License will terminate immediately without notice from TASCAM if you fail to comply with any provision of this License. Upon termination you must destroy all copies of the Software and related documentation in your possession or control.

**5. Export Law Assurances.** You agree and certify that neither the Software nor any other technical data received from TASCAM will be exported outside the United States except as authorized and as permitted by the laws and regulations of the United States. If the Software has been rightfully obtained by you outside of the United States, you agree that you will not re-export the Software nor any other technical data received from TASCAM except as permitted by the laws and regulations of the United States and the laws and regulations of the jurisdiction in which you obtained the Software.

**6. Government End Users.** If you are acquiring the Software on behalf of any unit or agency of the United States Government, the following provisions apply. The Software constitutes a “commercial item”, as that term is defined at 48 C.F.R. 2.101, consisting of “commercial computer software” and “commercial computer software documentation”, as such

terms are used in 48 C.F.R. 12.212, and is provided to the U.S. Government only as a commercial end item. Consistent with 48 C.F.R. 12.212 and 48 C.F.R. 227.7202-1 through 227.7202-4, all U.S. Government End Users acquire the Software with only those rights set forth herein.

**7. Limited Warranty on Media.** TASCAM warrants the media on which the Software is recorded to be free from defects in materials and workmanship under normal use for a period of ninety (90) days from the date of purchase as evidenced by a copy of the receipt. TASCAM's entire liability and your exclusive remedy will be replacement of the media not meeting TASCAM's limited warranty returned to TASCAM with a copy of the receipt. TASCAM will have no responsibility to replace any media damaged by accident, abuse or misapplication. ANY IMPLIED WARRANTIES ON THE MEDIA, INCLUDING THE IMPLIED WARRANTIES OF MERCHANTABILITY AND FITNESS FOR A PARTICULAR PURPOSE, ARE LIMITED IN DURATION TO NINETY (90) DAYS FROM THE DATE OF DELIVERY. THIS WARRANTY GIVES YOU SPECIFIC LEGAL RIGHTS, AND YOU MAY ALSO HAVE OTHER RIGHTS WHICH VARY BY JURISDICTION.

**8. Disclaimer of Warranty.** THE SOFTWARE AND RELATED DOCUMENTATION ARE PROVIDED "AS IS" AND WITHOUT WARRANTY OF ANY KIND. YOU EXPRESSLY ACKNOWLEDGE AND AGREE THAT USE OF THE SOFTWARE AND RELATED DOCUMENTATION IS AT YOUR SOLE RISK. SHOULD THE SOFTWARE OR RELATED DOCUMENTATION PROVE DEFECTIVE, YOU (AND NOT TASCAM OR ANY TASCAM'S REPRESENTATIVE) ASSUME THE ENTIRE COST OF ALL NECESSARY SERVICING, REPAIR OR CORRECTION. TASCAM OR ANY TASCAM'S LICENSORS EXPRESSLY DISCLAIM ALL OTHER WARRANTIES WITH RESPECT TO THE SOFTWARE AND RELATED DOCUMENTATION, WHETHER SUCH WARRANTIES ARE EXPRESS OR IMPLIED, INCLUDING, BUT NOT LIMITED TO, THE IMPLIED WARRANTIES OF MERCHANTABILITY, FITNESS FOR A PARTICULAR PURPOSE AND NON-INFRINGEMENT. WITHOUT LIMIT-

ING THE GENERALITY OF THE FOREGOING, TASCAM AND TASCAM'S LICENSORS MAKE NO WARRANTY OR REPRESENTATION THAT THE FUNCTIONS CONTAINED IN THE SOFTWARE WILL MEET YOUR REQUIREMENTS, THAT THE OPERATION OF THE SOFTWARE WILL BE UNINTERRUPTED OR ERROR-FREE, THAT DEFECTS IN THE SOFTWARE WILL BE CORRECTED, OR THAT THE SOFTWARE AND RELATED DOCUMENTATION WILL BE CORRECT, ACCURATE, OR RELIABLE. NO ORAL OR WRITTEN INFORMATION OR ADVICE GIVEN BY TASCAM OR ANY OF ITS EMPLOYEES, REPRESENTATIVES, OR RESELLERS SHALL CREATE ANY WARRANTY IN ADDITION TO THOSE GIVEN HEREIN. SOME JURISDICTIONS DO NOT ALLOW THE EXCLUSION OF IMPLIED WARRANTIES, SO THE ABOVE EXCLUSION MAY NOT APPLY TO YOU.

**9. Limitation of Liability.** UNDER NO CIRCUMSTANCES SHALL TASCAM BE LIABLE FOR ANY INCIDENTAL, SPECIAL OR CONSEQUENTIAL DAMAGES THAT RESULT FROM THE USE OR INABILITY TO USE THE SOFTWARE OR RELATED DOCUMENTATION UNDER ANY THEORY, INCLUDING CONTRACT, TORT, OR NEGLIGENCE, EVEN IF TASCAM HAS BEEN ADVISED OF THE POSSIBILITY OF SUCH DAMAGES. SOME JURISDICTIONS DO NOT ALLOW THE LIMITATION OR EXCLUSION OF LIABILITY FOR INCIDENTAL OR CONSEQUENTIAL DAMAGES SO THE ABOVE LIMITATION OR EXCLUSION MAY NOT APPLY TO YOU.

IN NO EVENT SHALL TASCAM'S LIABILITY TO YOU FOR DAMAGES, LOSSES, AND CAUSES OF ACTION (WHETHER IN CONTRACT, TORT (INCLUDING NEGLIGENCE) OR OTHERWISE), IF ANY, EXCEED THE AMOUNT PAID BY YOU FOR THE SPECIFIC LICENSE OF THE SOFTWARE AND RELATED DOCUMENTATION TO WHICH THE LIABILITY IS RELATED.

YOU ARE URGED TO FREQUENTLY BACK-UP YOUR DATA AND YOU ASSUME FULL RESPONSIBILITY FOR FAILURE TO DO SO.

**10. Controlling Law and Severability.** THIS LICENSE SHALL BE GOVERNED BY AND CONSTRUED IN ACCORDANCE WITH THE LAWS OF THE UNITED STATES AND THE STATE OF CALIFORNIA, EXCEPT FOR ITS CONFLICT OF LAWS PRINCIPLES. If for any reason a court of competent jurisdiction finds any provision of this License, or portion thereof, to be unenforceable, that provision of the License shall be enforced to the maximum extent permissible so as to effect the intent of the parties, and the remainder of this License shall continue in full force and effect.

**11. Complete Agreement.** This License constitutes the entire agreement between the parties with respect to the use of the Software and related documentation and supersedes all prior or contemporaneous understandings or agreements, written or oral, regarding such subject matter. No amendment to or modification of this License will be binding unless in writing and signed by an authorized officer of TASCAM.



## Part I — Manuals & Conventions

### Chapter 1 – The Manuals

Manual Descriptions .....	10
Owner's Manual .....	10
Quick Start Guide.....	10
Manual Organization .....	10
Documentation Conventions.....	11
Tips.....	11

### Chapter 2 – Operating Conventions

Front Panel .....	12
Multi-Function Keys.....	12
Data Entry .....	12
Keypad.....	12
Ancillary Keys .....	13
Jog/Shuttle Wheel .....	13
Virtual Channel Pots .....	13
Fader Banks .....	14
LCD Display .....	14
VGA or LCD.....	14
LCD Navigation .....	14
Common Soft Knobs & Keys.....	15

Soft Keys .....	15
Soft Knobs .....	15
VGA Display.....	15
Screen Navigation .....	15
Tracks Display .....	16
Mouse Conventions .....	16
Tabs .....	17
Main Menu Items .....	17
Zoom & Scroll.....	17
Main Menu Bar Elements.....	17
Transport & Record Keys .....	17
MIDI Panic .....	17
Tool Select.....	17
Grid Select.....	18
Nudge & Grid Settings .....	18
Edit Length Grids.....	18
Time Signature Selector.....	18
Tempo & Click Management .....	18
Project & Mix Menus .....	19
Main Time Code Display .....	19
Common buttons .....	20

## Part II — Monitoring Signals and Selecting Screens

### Chapter 3 – Monitoring Audio

Output Control .....	21
Monitor Section .....	21
CONTROL ROOM.....	21
STUDIO Section .....	22
TALKBACK Select.....	22
Monitor Level.....	23
SOLO Section.....	23
HEADPHONES.....	23
TRANSPORT SOLO.....	24

### Chapter 4 – Metering & Indicators

Reading LED Meters.....	25
Master Meter Section.....	25

### Chapter 5 – Selecting Screens

Screen Controls .....	27
Main Display Key.....	27
Main Display Mode Section.....	27
View Menu.....	28
LCD ACCESS Section .....	29
LCD Screen .....	29

## Part III — Locate, Transport, & Surround

### Chapter 6 – Transport, Loop, Auto Punch

Transport Controls .....	31
Front Panel .....	31
JUMP KEY MODE .....	31
VGA Transport .....	32
LCD Transport .....	32
ADD .....	33
EDIT .....	33
P2 Remote Machine Control in the SX-1... 34	
The Philosophy.....	34
General SX-1 Transport Controls.....	34
Customizing the Devices .....	34

Working with External Timecode Sources ... 35	
LOOP Section .....	37
Auto Record Controls (AUTOPUNCH Section)37	

### Chapter 7 – Locate Points

Creating Locate Points.....	38
Create a Locate Point .....	38
Recalling & Editing Locate Points.....	38
VGA Locate Control .....	39
LCD Locate Control .....	40
LOCATE POINTS .....	40
REGISTERS.....	40

# Table of Contents

<b>Chapter 8 – Surround</b>			
Setting Up Surround .....	41	Surround Modes Explained .....	41
Making the Change to Surround.....	41	Understanding the Changes .....	42
LCD Access to Surround .....	41	VGA Channel .....	42
		Routing Surround Busses .....	44
<hr/>			
<b>Part IV — Mixer Controls</b>			
<b>Chapter 9 – Channel Control</b>			
Front Panel.....	45	LCD Routing Displays.....	59
Channel Strips.....	45	Inserts – how they work and how to route them.....	59
Master Channel .....	45	VGA .....	60
Virtual Channel .....	46	Actually routing the insert to a mixer channel .....	61
Screen Control (VGA Channel Display) .....	47	LCD .....	62
CONTROL .....	47	Actually routing the insert to a mixer channel .....	62
POSITION .....	48	ANALOG IN .....	63
GROUPS .....	48	Bussing .....	63
AUX SEND .....	48	VGA Controls .....	63
EQ .....	49	Buss Masters .....	64
DYNAMICS .....	49	LCD Buss: Controls .....	64
Compressor & Expander .....	50	MACRO .....	65
Gate .....	50	Buss Assign .....	65
LCD Channel Display .....	51	Aux Sends & Returns.....	65
DYN .....	51	VGA Aux Send Controls.....	65
Aux ON/OFF .....	51	Aux Send Masters .....	66
AUX Pre/Post .....	51	LCD Aux Send Controls.....	66
Links .....	51	VGA Aux Return Masters.....	67
Buss Routing .....	52	Routing Library Displays .....	68
INPUT button .....	52	VGA Routing Library Display.....	68
INSERT button .....	52	LCD Routing Library Display.....	68
TRIM/CH DELAY Screen .....	52		
EQ, Dynamics and Scene Libraries - The Library			
Feature .....	53		
VGA Displays.....	53	<b>Chapter 12 – Fader Links, Groups, &amp; Banks</b>	
LCD Displays.....	53	Links.....	69
DYNAMICS LIBRARY .....	53	VGA Fader Links .....	69
Scene library .....	54	LCD Fader Links .....	69
VGA Scene Tab.....	54	MACRO .....	70
LCD SCENE LIBRARY Screen .....	55	LINKS .....	70
IMPORT .....	55	Groups .....	71
		VGA Fader Groups.....	71
<b>Chapter 10 – Library Overview</b>		LCD Fader Groups.....	71
Understanding the Library Feature .....	56	Understanding Group Masters.....	72
Library Section .....	56	Fader Banks .....	73
		Fader Bank Section.....	73
<b>Chapter 11 – Routing &amp; Bussing</b>		VGA Fader Banks.....	74
Working With the SX-1's Routing Pages ...	57	USER Fader Banks.....	75
The philosophy .....	57	Creating a User Fader bank (VGA) .....	75
VGA Routing Displays .....	57	User Fader Banks (LCD).....	76
Panel Routing .....	57	VGA Bank Menu .....	76
Mixer Routing .....	58	Channel Overview Screens .....	77
Before we continue, a word about mixer Bypass and Loopback .....	58	VGA Buss Overview Screen .....	77
HDR Routing .....	58	LCD Buss Overview Screen .....	78
Effects Routing .....	58	LCD Mixer Overview Screen.....	78
Insert Presets .....	59	VGA Input Overview Screen.....	79

## Chapter 13 – Automation

Understanding Modes & States.....	80
Controller States.....	80
Automatic (Auto).....	80
Static.....	80
Write.....	80
Trim.....	81
Safe.....	81
Off.....	81
Global Modes.....	81
Global Write.....	81
Trim.....	81
Init Edit.....	82
Rehearse Functionality.....	83
Global Controls.....	84
Mix Displays.....	84
VGA Mix Tab.....	84
LCD MIX Screen.....	85
Automation Controls.....	86
Front Panel Controls.....	86
VGA Automation Screen.....	88
Automation Track Area.....	89
Auto Track.....	89
Edit Operations (Region/Event select).....	90
When nothing is selected.....	90
A region is selected.....	90

Events selected.....	90
Edit Operations (Pencil Tool).....	90
Edit Operations (Curve Tool).....	90
LCD CHANNEL screen.....	91
Automation Events & History Screens.....	91
Event List Tab.....	91
Edit Operation.....	91
History Tab.....	92
VGA Automation Global Tab.....	92
Dynamic Automation.....	92
LCD GLOBAL Screen.....	94
Operations Examples.....	95
Writing Mix Moves.....	95
Revert Time.....	95
Writing Switch Events.....	100
Revert Time.....	100
Disabling Control Sense Timeout.....	102
Trimming Mix Moves.....	102
Revert Time.....	103
Automating Library Recall.....	104
Writing Library Recall Events Over Existing Static Control Positions.....	104
Combining Library Recall With Dynamic Mix Moves.....	105
Automating Groups.....	105

## Part V — Effects

### Chapter 14 – Working with Effects

The Philosophy – how it works.....	106
VGA Effects Screens.....	106
Routing Effects Screens.....	107
VGA EFFECTS SLOT/ROUTING Module.....	107
Effect Slot.....	107
LCD Effects Routing Screen.....	107
EFFECTS.....	107
Effects Controls Displays.....	108
VGA EFFECTS CONTROLS Screen.....	108
LCD EFFECTS Control Screen.....	108
Effects Library Displays.....	109
VGA EFFECTS LIBRARY Screen.....	109
LCD FX LIBRARY Screens.....	110
Routing Effect Examples.....	111
Aux Send & Return.....	111
Inserting an Effect.....	111

### Chapter 15 – Examples of Effect Algorithms

Categories.....	112
Common Effect Parameters.....	112
Examples.....	113
Antares Mic Modeler.....	113
Signal Flow.....	113
Input Section.....	113
Source Mic Section.....	114
Modeled Mic Section.....	115
Preserve Source.....	116
Tube Saturation.....	116
Antares Speaker Modeler.....	117
Tascam DeEssor.....	117
Tascam Exciter (Stereo).....	118
Tascam/Nemesys HD1 Dither.....	118
Type.....	118
TC SX-1 Reverb.....	119
Level Mix Controls.....	119
Time Editor.....	120

## Part VI — Audio tracks

### Chapter 16 – Working with Audio Regions

Essential Tools.....	122
Tool Select Menu.....	122
VGA Waveform Tab.....	122
Edit Operation.....	123
Event Editor.....	123

HyperSelect.....	123
Move.....	123
Render.....	123
Repeat Selection.....	123
Reverse.....	123
Gain/Fade.....	123
Normalize.....	123

# Table of Contents

Remove DC .....	123
LCD WAVEFORM Screen.....	124
SELECT .....	124
Managing Audio Takes .....	124
VGA Take Browser Tab .....	125
Audio Clips.....	125
VGA Clip Browser Tab .....	125

## Chapter 17 – Editing Audio

Edit Controls.....	127
EDIT .....	127
NUDGE SETTING .....	127
Editing.....	128
VGA Edit Menu .....	131
Auditioning Edits .....	132
AUDITION Section .....	132

## Part VII — MIDI Sequencing

### Chapter 18 – Essential Controls

MIDI Sequencer .....	133
MIDI REC MODE Section.....	133
VGA Tracks Display of MIDI.....	133
MIDI Tracks.....	133
LCD Tracks Display of MIDI.....	134
VGA MIDI Channel Display .....	135
LCD MIDI Channel Display .....	136
Global Controls.....	136
VGA Global Tab .....	136
MIDI Input Settings .....	138
LCD MIDI Settings Screen.....	139
VGA MIDI Track Tab .....	139
Transpose .....	144
Transpose Mode .....	144
Track Offset.....	145
RELATED LCD screens .....	145
Step Record Mode .....	146
Step Parameters.....	146
Step Recording.....	147
TIME/TEMPO Management .....	148
VGA Control.....	148
Accent .....	148
Non Accent .....	148
LCD TIME/TEMPO Screens.....	149
Managing MIDI Takes .....	150
VGA Take Browser Tab .....	150
Managing MIDI Files .....	150
Standard MIDI Files .....	151
VGA SMF Management Tab.....	151
VGA Main Menu SMF Commands .....	151
MIDI Monitoring.....	152
MIDI Overview Screen.....	152
LCD MIDI In Overview Screen.....	153
LCD MIDI Out Overview Screen.....	153
MIDI Naming Tab.....	154

### Chapter 19 – MIDI Editing

Tools & Screens .....	155
-----------------------	-----

A recap — onscreen tools for working with MIDI events .....	155
Using the Tools.....	155
MIDI Piano Roll Screens.....	159
VGA Piano Roll .....	159
Edit Operation .....	159
Add Note .....	159
Add Program Change .....	159
Adjust Duration .....	159
Adjust Velocity .....	159
Crescendo .....	160
Event Editor .....	160
HyperSelect.....	160
Move .....	160
Quantize .....	161
Randomize Duration .....	161
Randomize Time .....	161
Randomize Velocity .....	161
Repeat Selection.....	161
Reverse.....	161
Set Duration .....	161
Set Min/Max Duration .....	161
Set Min/Max Velocity .....	162
Set Velocity.....	162
Smooth Events .....	162
Split Notes .....	162
Step Record.....	162
Transpose.....	162
Trim Duration .....	162
Trim Velocity.....	162
LCD Piano Roll .....	163
Event Lists .....	163
VGA Event List.....	163
Edit Operations .....	164
Add Lyric .....	164
Add Time Signature .....	164
Tempo Change .....	164
LCD Event List.....	165
FILTER .....	165
JUMP .....	165
OPTION .....	165

## Part VIII — Data Entry, System & File Management

### Chapter 20 – Project Management

Important Screens .....	166
New Project Screens.....	166

VGA New Project Tab.....	166
LCD New Project Screen.....	167
Manage Project screens.....	167
VGA Manage Project Tab.....	167

“Safe” startup .....	168	Quick general behavior.....	178
LCD Manage Screen.....	168	Backing Up.....	179
FUNCTIONS .....	168	Backup Displays.....	179
LCD Open Screen .....	169	VGA Project Backup Tab .....	179
Main Menu Bar Project Commands .....	169	LCD Backup Screen .....	180
<b>Chapter 21 – Mixdown, Author, Backup</b>		Drive Settings.....	180
The SX-1 and Mixdown Mode .....	170	VGA Drive Setup Tab .....	180
Philosophy – how it works.....	170	LCD Drives Screen.....	181
Stereo Mixdown – printing your final mix or comping tracks.....	170	<b>Chapter 22 – System Settings</b>	
On the VGA .....	170	Preferences .....	182
On the LCD .....	171	Preferences Screens .....	182
In Surround Mode – what changes? .....	172	VGA UI Settings Tab.....	182
On the VGA .....	172	LCD Meter Screen .....	183
On the LCD .....	172	LCD Miscellaneous Screen .....	183
Working With the CD Burner .....	173	LCD Time Screen .....	184
ISO Data CD .....	173	About your SX-1 .....	184
Red Book Audio CD .....	174	The SX-1 Menu .....	185
The SX-1 and Hard Drives .....	175	System Settings.....	185
Care and feeding, and audio file behavior... 175		System Settings Screens .....	185
The Philosophy – drives in general..... 175		VGA Global Tab System Settings .....	185
Drives and the SX-1 .....	176	LCD Hard Drive (HDR) Screen .....	186
What is actually put on the drive .....	176	VGA Clock Settings Tab .....	187
What is happening when the SX-1 is recording .....	177	LCD Clock Settings Screen .....	188
The way the SX-1 handles data .....	177	LCD EXTERNAL DEVICES Settings Screen..... 189	
Explanation of Disk Cleanup and Low Level Format .....	178	Digital I/O Settings .....	190
How the Backup file is made .....	178	LCD Digital I/O Screens .....	190
		Option Card Settings .....	191
		Front Panel SHUTDOWN Key .....	191
<hr/>			
<b>Part IX — Connections and Ports</b>			
<b>Chapter 23 – Inputs and Outputs</b>			
Top Panel .....	192	INPUTS.....	192
OUTPUTS .....	192	Rear Panel.....	193
<hr/>			
<b>Part X — Specifications, etc.</b>			
<b>Appendix A – PS/2 Keyboard &amp; Mouse</b>		<b>Appendix C – Block Diagrams (i)</b>	
Shortcuts		Block Diagram (ii).....	200
In General.....	195	<b>Appendix D – Level diagram</b>	
Track Management .....	195	<b>Appendix E – Specifications</b>	
Piano Roll Management.....	195	Physical specifications .....	202
TrackScale View (the grey zooming bar)..	195	Dimensional drawing.....	202
Ruler .....	196	Audio specifications.....	203
Transport.....	196	I/O (analog).....	203
<b>Appendix B – Control Surface Shortcuts</b>		I/O (digital).....	204
SHIFT Key .....	197	Synchronization, etc. I/O .....	204
CANCEL Key .....	197	Other connections, etc. ....	204
Transport Key Combinations.....	197	Performance .....	205
Channel Select Key Special Functionality .	198	<b>Appendix F – MIDI Implementation Chart</b>	
DIM, MONO & TALKBACK Special Functionality .....	198		

# Chapter 1 – The Manuals

---

## Manual Descriptions

---

There are two different manuals shipped with the SX-1: a *Quick Start Guide* and an *Owner's Manual* (this manual). If you are missing either of these man-

uals, you should contact the authorized TASCAM dealer where you purchased your SX-1. The contents and purpose of each manual are described below.

---

### Owner's Manual

The *Owner's Manual* covers all of the SX-1's many features, controls, and parameters in detail. Its explanations assume that you have a certain knowledge-base about recording and MIDI. If you find yourself confused by the subjects and terms presented in this

manual, you should refer to an introductory handbook on engineering. This manual does not explain how to set up and begin using the SX-1; for that you should refer to the *Quick Start Guide*.

---

### Quick Start Guide

This guide covers all the basics on setting up your SX-1: unpacking, connecting speakers, listening to the demo, setting recording levels, and connecting MIDI. If you are not familiar with setting up record-

ing equipment (and even if you are) beginning with the *Quick Start Guide* is a good idea. For more detailed explanations on individual features and functions, refer to the *Owner's Manual*.

---

## Manual Organization

---

The *Owner's Manual* is divided into sections called Parts, and each Part is divided into chapters. The Parts are designated by Roman numerals (I, II, III, IV, etc.) while the chapters are designated by Arabic numerals (1, 2, 3, 4, etc.). Each chapter contains relevant figures of the SX-1's front panel, and screen shots of the LCD and VGA displays.

Each Part covers a specific portion of the SX-1 (for example, the Mixer or the MIDI Sequencer). The chapters address individual features (such as mixer automation or editing MIDI data). As such, learning about a specific section of the SX-1's functionality is as simple as reading the appropriate Part.

There are ten Parts.. The following is a brief description of what you can expect to find in each Part.

### I, "Manuals & Conventions" (page 10)

This introductory Part explains the organization and documentation conventions of the *Owner's Manual*. It also covers the SX-1's general operating conventions for all three control interfaces: the front panel, onboard LCD screen, and a connected VGA display.

**II, "Monitoring Signals and Selecting Screens" (page 21)** There are lots of ways to monitor signals on the SX-1. The front panel meters and LED indicators are one way, and many of the

display screens also provide comprehensive metering. This Part covers the SX-1's many meters and indicators and explains how to recall the different display screens.

**III, "Locate, Transport, & Surround" (page 31)** Understanding how to navigate through your project quickly and efficiently is key to getting the most out of your SX-1. This Part explains the SX-1's transport and locate controls as well as its recording conventions.

**IV, "Mixer Controls" (page 45)** The SX-1 has a full-featured mixer with a host of powerful features. Routing for the mixer is available pre- and post- the mixer channels, the channels themselves have built-in EQ and dynamics, the buss and return architecture is extremely flexible, and practically every parameter can be automated and archived. This section explains the mixer's structure and operations.

**V, "Effects" (page 106)** Each onboard effect has its own unique set of parameters. This Part explains these parameters for all the currently available effect algorithms.

**VI, "Audio tracks" (page 122)** Everything you need to know about working with and editing audio regions can be found in this Part. This includes

an explanation of different editing features, how to use the audio editing tools, and selecting and displaying waveforms.

**VII, “MIDI Sequencing” (page 133)** The SX-1’s onboard MIDI sequencer is as comprehensive as a dedicated software-based MIDI sequencer (like the type you might install on a desktop computer). This Part covers all of the MIDI sequencer’s features and addresses working with and editing MIDI note and continuous controller data.

**VIII, “Data Entry, System & File Management” (page 166)** Different applications require different system setups: sample rates, bit depths, synchronization, storage, and the like.

This Part covers the SX-1’s system parameters as well as backing up and project management.

### **IX, “Connections and Ports” (page 192)**

There are a variety of jacks and connectors located on the top and back of the SX-1. There are also several expansion ports on the unit’s rear. This part of the manual explains the purpose behind each of these connections.

**X, “Specifications, etc.” (page 195)** All the specifications you need to know about the SX-1 are found in this Part: reference diagrams, keyboard commands and shortcuts, and technical specs.

---

## Documentation Conventions

---

The names for all of the SX-1’s keys, knobs, and connections are printed in this manual exactly as their labels appear on the SX-1 itself. They are set apart from normal text with brackets. For example, the Play button is written **PLAY**. In the case where a key has more than one function (for example, a main and shift function—the Shift function is explained in “Multi-Function Keys” on page 12), it is written as, **ENABLED/ ALL INPUT** (the main function is listed first and the shift function second).

The SX-1’s face is organized into different areas for each of its various functions. These areas are labeled and their names also appear in this manual exactly as they are printed on the SX-1 (for example, **EDITING**).

Areas of the SX-1 that are not labeled, but have a specific purpose, are written in conventional title form (such as, **Faders**).

In order to differentiate LED labels from area and control labels, LED names are in angle brackets (for example, **<DISK>**). To distinguish software buttons and menu names that appear on the LCD or the external VGA displays from their hardware counterparts, these names are in a lighter typeface (like, the **LOAD** key or the **EQ LIBRARY** screen).

All the manuals and guides for the SX-1 adhere to these documentation conventions. Diagrams and illustrations are presented whenever possible to augment the manual’s text descriptions.

Windows is a trademark of Microsoft Corporation.

Mac and Macintosh are trademarks of Apple Computers.

Be is the trademark of Be Incorporated.

All other trademarks mentioned here are the property of their respective owners.

---

### Tips

Important notes, that are in addition to general instructions and definitions, are set apart from the manual’s normal text titled **TIP** (see the example here). These important tips call your attention to special situations and offer helpful operating suggestions.

#### **TIP**

*While reading the SX-1 Owner’s Manual, keep your eyes peeled for special operating tips and helpful suggestions like this.*

## Chapter 2 – Operating Conventions

### Front Panel

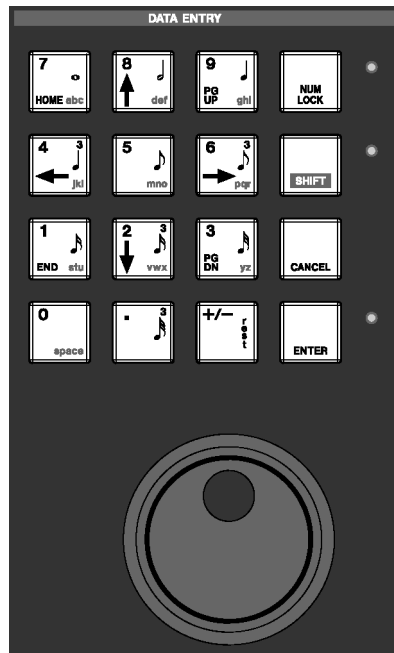

### Multi-Function Keys

Some keys have multiple functions. A key's primary function is accessed by simply pressing the key. Secondary functions are accessed by entering Shift mode. Press the **SHIFT** key on the Numeric Keypad,

and then press the multi-function key to reach its secondary function. Think of the **SHIFT** key just like the shift key of a standard PS/2 keyboard—it serves a similar purpose.

### Data Entry

Only the **Keypad** is actually labeled **DATA ENTRY**. The **Keypad** is used for entering numbers and letters directly into a text field, and enabling the Shift func-

tion (as described above), up/down and left/right cursor navigation, and entering MIDI step record note values.

### Keypad

The **Keypad** has four distinct uses, which change according to the LCD's current display screen and selected text or number field. These are: cursor control (navigation), numeric, note value, and alphabet character entry. Four ancillary keys support these uses: **NUM LOCK**, **SHIFT**, **CANCEL**, and **ENTER**.

**Numeric Entry** When the cursor is in a value field (in the LCD screen only), the **Keypad** enters numbers.

**Navigation Function** For the LCD screen, the **Keypad's** navigation keys (the up/down and left/

right arrows) let you move the cursor between text fields, scroll through menus, and select objects.

**Note Value Entry** In the MIDI Step Record mode, in both the LCD and VGA Step Record screens, the keys with notation marks let you quickly assign note values to your stepped MIDI notes.

**Character Entry** On the LCD screen, when the cursor is in a text field, the **Keypad** enters letters (like a push-button telephone, where subsequent key presses cycle through the letters listed on the keys). After entering a letter, the cursor will, after a small delay, autoadvance to the next space.



## Ancillary Keys

**NUM LOCK** Use the **NUM LOCK** key to fix the **Keypad**'s operation to only enter numbers.

**SHIFT** For front panel keys that have a Shift function, press the **SHIFT** key to enable this function. The Shift key is also a part of a number of special multiple-key commands (see “PS/2 Keyboard & Mouse Shortcuts” on page 195).

### TIP

*An example of a handy multiple-key command is the ability to copy your main mix to the cue mix. By holding down **SHIFT** and pressing the **CUE** key (to the right of*

*the Virtual Channel knobs) you can copy the Master L/R mix to the Cue layer. This move can save valuable time when you need to quickly create a mix for an overdubbing musician.*

**CANCEL** Use the **CANCEL** key to terminate an action. This key is also part of a number of multiple-key shortcuts. For example, holding down **CANCEL** and touching a fader or other control will set that control to default.

**ENTER** Use the **ENTER** key to complete an action.

## Jog/Shuttle Wheel

The **Jog/Shuttle Wheel** is used for moving the transport back and forth.

**Jog Dial** Jogging is controlled by the inside dial of the Jog/Shuttle control. Spin the dial clockwise to play audio and MIDI forward, and spin the dial counterclockwise to play audio and MIDI backwards. Playback speed is determined by how fast you spin the Jog Dial. (The Jog Dial is sometimes referred to as the Scrub Wheel, and similarly, jogging is sometimes called scrubbing.)

**Shuttle Wheel** Shuttleing is controlled by the outside ring of the Jog/Shuttle control. Turn the wheel to the right to shuttle audio and MIDI forwards in time, and turn the wheel to the left to shuttle audio and MIDI backwards. How far you push the wheel, left or right (backwards and forwards, respectively), determines the speed of playback. The wheel is spring-loaded, and upon release it pops back to center position and normal play speed.

## Virtual Channel Pots

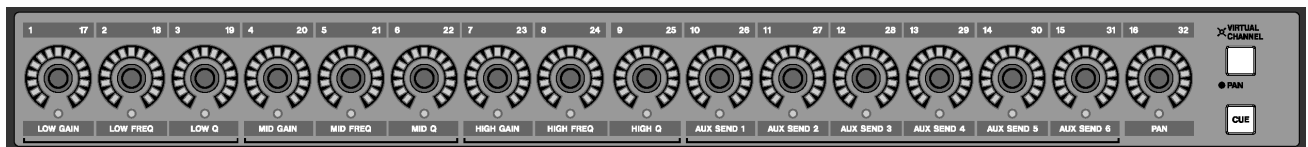

The knobs at the top of the channel strips (above the faders) are multi-function, infinitely rotating potentiometers (pots for short).

Depending on their currently selected mode (accessed by the **PAN/ VIRTUAL CHANNEL** or **CUE** keys), these controls serve as pan pots for all chan-

nels, EQ, Aux sends and pan for a selected channel, or pan for the Cue Mix. The virtual pots are surrounded by a ring of LEDs, which indicate their current setting. For example, a pan pot that is hard left will have its far left LED illuminated, or an AUX send that is full open will have all of its LEDs lit.

## Fader Banks

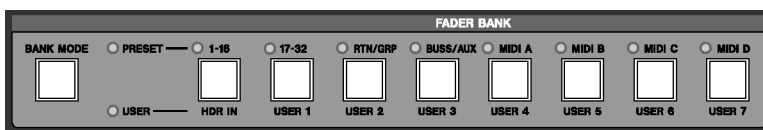

It's important to remember that the SX-1's faders control more than just one group of levels. Besides the first 16 mixer channels, at default the faders also control: inputs 17-32, the cue mix, MIDI tracks, sends, returns, and busses. Different groups of faders,

called *fader banks*, are accessed by the keys in the **FADER BANKS** section on the SX-1's slanted front panel, and the cue mix bank is reached via the **CUE** key to the right of the virtual channel strip.

## LCD Display

### VGA or LCD

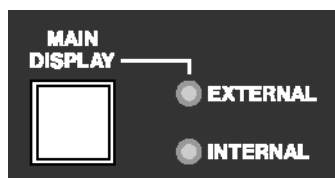

You have a choice of using the LCD or an VGA display as your main screen. The LCD display always follows the selection keys in the **MAIN DISPLAY MODES** section. To have an external VGA follow

these keys, press the **MAIN DISPLAY** key above the **LCD ACCESS** section (on the SX-1's slanted front panel). The **<EXTERNAL>** LED should light.

## LCD Navigation

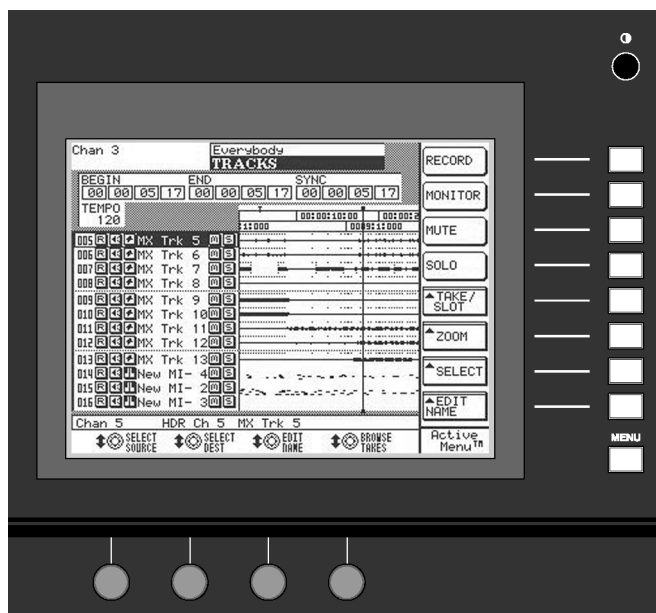

The LCD display is surrounded by several knobs and buttons. The function of these controls change according to the display on the LCD. We refer to these controls as “soft” knobs and keys because their functions are directly related to the SX-1's software.

The soft knobs and soft keys line up with onscreen knobs and keys to indicate their current function. Each of the LCD's screens has a different set of these virtual controls. Some keys are single function while others are of a pop-up menu style. Most of the soft

knobs, upon turning, display a selection of choices in a pop-up style menu.

To scroll up/down and left/right in an LCD window, use the up/down and left/right arrow keys of the

Numeric Keypad. And to adjust the viewing angle and contrast of the LCD, use the small  knob to the top right of the LCD.

## Common Soft Knobs & Keys

There are several soft knobs and keys which are common to many of the LCD screens. How these controls operate are always identical, even if the parameters they adjust, or select, are different.

### TIP

*Explaining the common virtual knobs and keys here means that not every soft key and knob is explained for every LCD menu. If you are looking at an LCD menu and don't see all the items explained next to the manual's illustration, the missing controls are likely explained here.*

## Soft Keys

ACTIVE MENU	This virtual key toggles the LCD screen's soft key menu bar on and off in order to expand the visible screen area (this is not necessary for all screens). ACTIVE MENU is always tied to the MENU soft key (the very bottom soft key).
<b>Arrow Icon</b>	When you see an arrow icon on a virtual key, pressing its associated soft key will open a menu.
NAME	Opens a dialog for naming the currently selected field.
DELETE	Removes last entry.
OK or ACCEPT	Enters current field's new value.
COMPARE	Press this key to compare your current settings with your last saved settings.
CANCEL	Escapes current action.
CLEAR	Clears entire field.
SELECT	Opens parameter selection menu.
CURSOR -->	Moves cursor right.
<-- CURSOR	Moves cursor left.
BACK SPACE	Moves cursor back one space.
Notes	A field to write text in that is saved with the patch.
SET TO DEFAULT	This sets the associated controller's value back to its factory default value.

## Soft Knobs

CURSOR	Moves the cursor.
EDIT NAME	Opens change name menu.
CHANGE CHAR	Scrolls through characters.
SELECT (PARM or OP)	Opens parameter selection menu.
DEST	Opens destination assign menu (for example, where the track will return).
IMPORT	Opens an import dialog from which you can bring settings from other projects into your current project.

## VGA Display

### Screen Navigation

Getting around on a connected VGA Display is just like using a regular computer because the same mouse and PS/2 keyboard rules apply. For example, use the mouse to click on a field and open a pull-down menu, or enter names and values in text fields with the PS/2 keyboard.

### NOTE

*Where Windows machines typically use the Control key, and Macintosh systems use the Command key with other keys as keyboard shortcuts, the SX-1 uses the Alt key together with other keys for this purpose.*

## Part I—Manuals & Conventions

A Main Menu Bar at the top of the VGA display allows access to all of the SX-1's screens and many primary functions. Just like with a wholly computer based application, you can use the Main Menu Bar to change windows, select editing tools, save projects,

and set preferences. But unlike a wholly software based computer device, the SX-1 also gives you real world hardware control of its software right from its front panel.

### Tracks Display

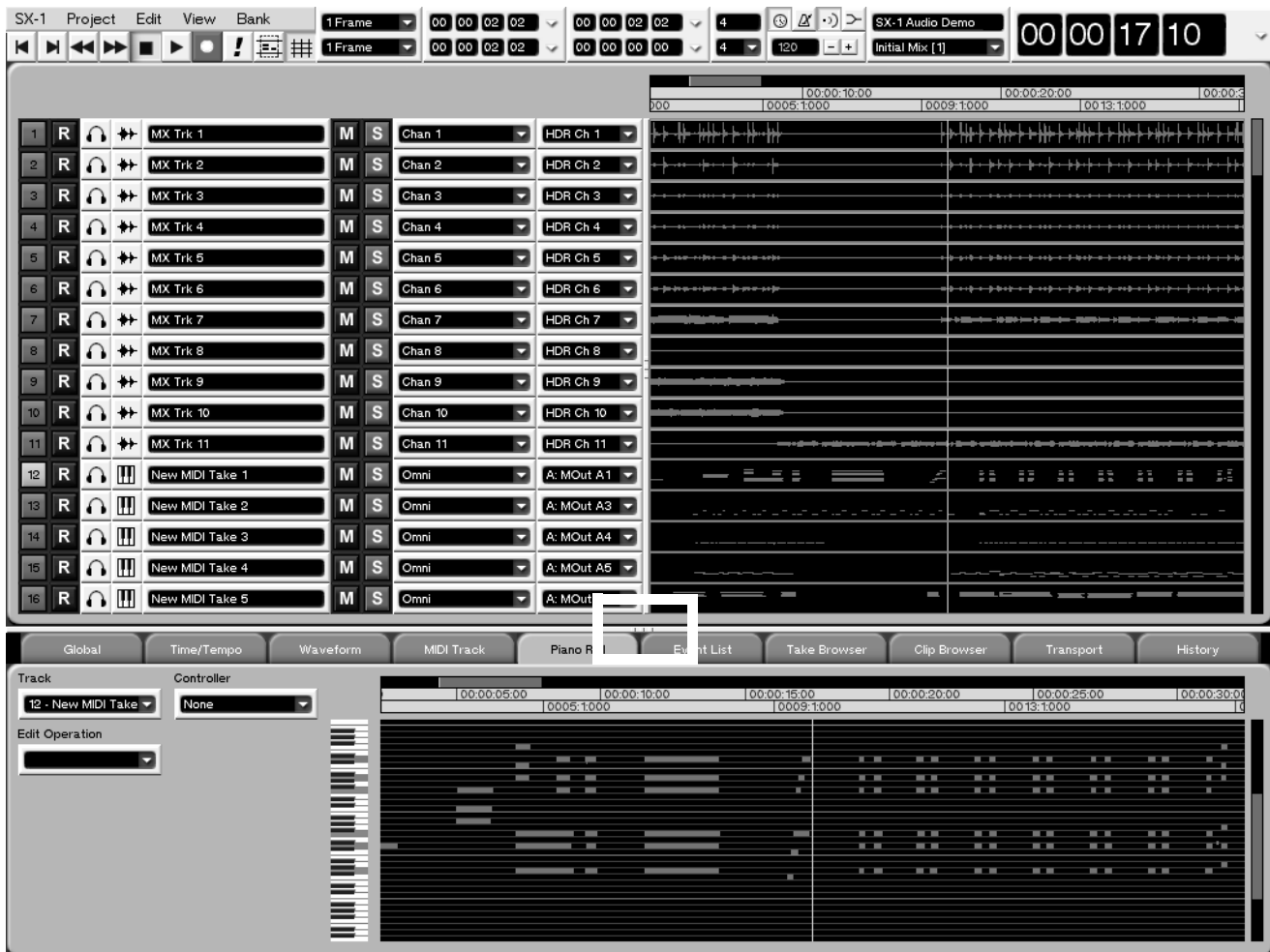

The SX-1 has many different VGA screens that you will use over the course of a project. However, the Track screen (pictured here) is possibly the most commonly accessed screen. Here, you will find a number of essential elements for working with and managing your project. You can get a clear picture of all the tracks in your project and perform a variety of tasks

including: creating audio and MIDI tracks, assigning takes, selecting regions for editing, arming and soloing mixer channels, and choosing editing and preference tabs.

#### TIP

To see the other nine main VGA screens, press ALT plus a number key from 0-9 on the connected PS/2 keyboard.

### Mouse Conventions

**Pop-Up Menus** Click on the arrow icon (▾) next to a control (this might be anything, from a text field to a button) to display pop-up menus.

#### TIP

If clicking normally on an arrow only selects the control, but doesn't let you edit it, try right-clicking on it.

**Resizing Windows** The Tracks and tabs areas can be resized by clicking and dragging on the three dots on the divider bars (as shown above). Click and drag horizontally to resize the Tracks area, and click and drag vertically to resize the tabs area.

## Tabs



To reach the various layered operations windows in different screens, click on their labeled “tabs” (just like flipping through folders in a file cabinet).

Tabs without a label are unassigned.

## Main Menu Items

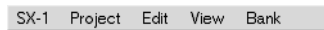

To open the main menu items on the menu bar, click once on an item.

Then drag the mouse downward over the pop-up menu to make your selection. The menu items’ respective commands are covered throughout this manual (for example, the SX-1 commands, which are

system oriented, are addressed in “System Settings” on page 182, while the Edit commands are covered in the chapters on editing audio and MIDI regions— “Audio tracks” on page 122 and “MIDI Sequencing” on page 133).

## Zoom & Scroll

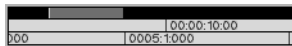

Right click and drag over the gray horizontal bar above the timeline (in the TRACK and AUTOMATION screens, and respective Waveform and Audio Track tabs) to zoom in or out. Left click and drag the gray bar to scroll, horizontally (in time), through the project. And, left clicking to the left or right of the gray bar

moves the playhead back or forward, respectively, by one screen.

### TIP

You can zoom in or out on the VGA screen by pressing *Alt* and the *[ ]* keys. Additional key commands and shortcuts are listed in Appendix 2.

## Main Menu Bar Elements

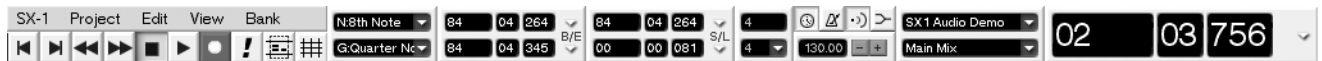

## Transport & Record Keys



These keys mirror the SX-1’s hardware Transport and Record Keys.

They can be used in place of their hardware counterparts if desired.

## MIDI Panic



Use this button or the hardware **PANIC** key to clear stuck MIDI notes and other such MIDI log jams (it sends All Notes Off messages, and then Note Off messages on all channels) as well as dimming the audio outputs by

20dB and stopping the transport. This is a latching button, and the front panel **PANIC** indicator pulses while the panic mode is active. Press either the soft PANIC button or the hardware **PANIC** key to exit the panic mode.

## Tool Select



Press this button to choose a cursor selection tool. There are four choices: Region, Event, Pencil, and Curve (the tools’ func-

tions are explained in “Essential Tools” on page 122).

### TIP

You can use the PS/2 keyboard's Escape key to choose the tool.

### Grid Select



Use this button to toggle the “snap-to-grid” feature on and off. The grid is represented by vertical lines that intersect the tracks in the Tracks screen (they also appear in other related screens, such as the VGA Waveform tab). When

snap-to-grid is on, events (audio and MIDI) will always align to the nearest grid intersection when moved by the mouse. When the grid is off, events are not constrained to the grid lines.

### Nudge & Grid Settings

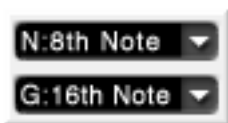

The top field (designated by N) adjusts your nudge amount. Select an event (audio or MIDI) and use a connected PS/2 keyboard's +/- keys to move the event forward or backward in time by the Nudge value.

The bottom field (designated by G) sets your “snap-to” grid size (as described above). Both values can be either SMPTE, hours:minutes:seconds, bars:beats:ticks, feet:frames, or samples.

### Edit Length Grids



The left displays show a selection's Edit In and Out points. The top right display shows the selection's sync point, while the bottom right display shows the

selection's length. Readouts for each display can be in SMPTE, hours:minutes:seconds, bars:beats:ticks, feet:frames, or samples.

### Time Signature Selector

The top value represents the number of divisions in a bar (the beats per measure). Almost any value can be entered directly into this field from a connected PS/2 keyboard. The bottom value represents the type of note assigned to the bar divisions (the note that

equals one beat). This value is chosen from the pull down menu (click on the arrow). Note values range from a whole note (semibreve) to a 64th note (hemidemisemiquaver).

### Tempo & Click Management

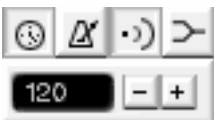

These buttons are for adjusting the project's tempo and click, and enabling or disabling MIDI echo and merge.



Use this button to toggle the current project's Conductor track on and off. The Conductor track contains the project's

tempo map and can be viewed and edited (using the appropriate function—“Tempo Change” on page 164). When the button is depressed, the project's tempo follows the Conductor track. When the button is up, tempo follows the Main Menu Bar's

tempo setting (the field to the left of the “-/+” keys, pictured to the left and described below).



This button turns the MIDI metronome on and off.



This button turns MIDI echo on and off.



This button turns MIDI merge on and off.



Use these buttons to adjust a project’s tempo when the Conductor track is not enabled. A value can also be entered directly into the adjacent tempo field from the PS/2 keyboard.

**TIP**

*To learn more about MIDI functionality, see Part VII.*

## Project & Mix Menus



The top field displays the name of your current project. If you click the arrow in this field you can display the remaining record time (for the drive that the current Project is loaded on). The bottom field

shows the name of your current Mix (the SX-1 allows multiple mix files to be associated with a project). Mixes are managed from the VGA’s Mix Tab in the Automation screen.

## Main Time Code Display



This Time Code display mirrors the SX-1’s main LED Time Code display on its slanted front panel. It can display time in SMPTE, hours:minutes:seconds, bars:beats:ticks, feet:frames, and samples.

**NOTE**

*Changing this field changes all of the registers in both user interfaces - except the Nudge and Grid values. You can think of this control as a sort of “master display*

*type” if you wish. After changing the view type to another of the choices, you can always change any of the individual fields to display whatever you like.*

*This parameter can also be changed by holding the surface **SHIFT** key and pressing the **MAIN DISPLAY** key on the slanted front panel - repeated pressings will scroll through the available four choices*

### Common buttons

There are several virtual keys (buttons) that are common to many of the VGA screens and tabs. How these controls operate are always identical, even if the parameters that they adjust, or select, are different.

#### NOTE

*Explaining the common VGA buttons here means that not every virtual key is explained for every VGA screen and tab. If you are looking at an VGA display and don't see all the items explained next to the manual's illustration, the missing controls are likely explained here.*

Name field	Displays the name of the currently selected parameter or item. You can also change an item's name by entering text directly into this field and pressing <b>ENTER</b> on the <b>Keypad</b> .
NEW	Creates a new entry for the currently selected parameter or item.
RECALL	Restores from memory the currently selected (highlighted) parameter or item.
STORE	Saves to memory the currently loaded parameter or item.
DELETE	Deletes the currently selected (highlighted) parameter or item.
DONE	This key is found in all Edit Operations screens. Press the key to complete the edit operation.
EDIT NAME	Enables you to change the name of the currently selected patch or preset.
Library	A field where the names of the Library presets appear.
Notes	A text field where notes can be saved along with the preset.
COMPARE	Press this key to compare your current settings with your last saved settings.
IMPORT	Opens an import dialog from which you can bring settings from other projects into your current project.
SET TO DEFAULT	This sets the associated controller's value back to its factory default value.



## Chapter 3 – Monitoring Audio

### Output Control

#### Monitor Section

This section houses controls for the Control Room and Studio monitor outputs (these connections are on the SX-1's top panel).



#### CONTROL ROOM

This section provides controls for the Control Room monitor outputs.

**SOURCE Select** The **SOURCE** key allows you to choose the source signal that you want to monitor through your Control Room speakers. Multiple presses of this key allow you to toggle through the following sources:

**<STEREO>** When the **<STEREO>** LED is illuminated, the source monitored is the Master L/R output (post the Master Fader).

**<CUE>** When the **<CUE>** LED is on, the source monitored is the Cue mix.

**<AUX 1/2>** When the **<AUX 1 / 2>** LED is on, the source monitored is the Aux 1 and 2 sends.

**<AUX 3/4>** With the **<AUX 3 / 4>** LED illuminated, the source monitored is the Aux 3 and 4 sends.

**<AUX 5/6>** When the **<AUX 5 / 6>** LED is on, the source monitored is the Aux 5 and 6 sends.

For the Aux sends, pressing once will select the odd-numbered aux send of the pair (the light will flash in a single pattern) and pressing again will select the even-numbered aux send (the light will flash in a double pattern).

**<2 -TRACK/CD>** When the **<2 -TRACK/ CD>** LED is on, you are monitoring the signal coming into the **2 TR IN** stereo input (located on the unit's top panel).

**<D-IN>** With the **<D- IN>** LED illuminated, you are monitoring the unit's digital inputs (found on the unit's rear).

Press once for **D-IN 1** (the light will flash in a single pattern), and press twice for **D-IN 2** (the light will flash in a double pattern).

## Part II—Monitoring Signals and Selecting Screens

### TIP

When the Aux sends are linked for stereo operation, pressing **SOURCE** accesses both the odd and even Aux channels as a stereo pair. If the Aux sends are not linked, pressing **SOURCE** will first monitor the odd, and then the even Aux channels of a pair.

**Monitor DIM** Press the **DIM** key to momentarily lower the output level of your Control Room Monitors by a set amount. The default is -12 dB, but this value can be as much as -50 db. The attenuation amount is adjusted from the LCD PREFERENCES screen (**SHIFT+SETTINGS/ PREFS**). This is a “smart” key.

### TIP

When monitoring at levels that make having a conversation difficult, use **DIM** to get a quick word in without having to touch the master output levels.

## STUDIO Section

This section provides controls for the Studio monitor outputs (which can be used to feed a set of speakers in the tracking room) and the Talkback mic.

**SOURCE Select** The **SOURCE** key allows you to choose the source signal that you want to monitor through your Studio speakers. Multiple presses of this key allow you to toggle through the following sources:

**<STEREO>** When the **<STEREO>** LED is illuminated, the source monitored is the Master L/R output (post the Master Fader).

**<CUE>** When the **<CUE>** LED is on, the source monitored is the Cue mix.

**<AUX 1/2>** When the **<AUX 1 / 2>** LED is on, the source monitored is the Auxiliary 1 and 2 sends.

**MONO Select** Press **MONO** to hear the source currently selected in mono (instead of stereo). The key is of a “smart” type.

**Speaker Select** The Speaker Select switch, labeled **LARGE/ SMALL**, lets you quickly switch between two different sets of speakers (for example, large and small control room monitors). The **LARGE** and **SMALL** speaker connections are located on the top panel of the SX-1.

**Monitor LEVEL** The **LEVEL** knob controls the volume of your control room monitors. You can pre-set the control’s starting level (if for instance, the initial output seems too loud) from the LCD PREFERENCES screen (**SHIFT+SETTINGS/ PREFS**). The default output is +4dBu.

**<AUX 3/4>** With the **<AUX 3 / 4>** LED illuminated, the source monitored is the Auxiliary 3 and 4 sends.

**<AUX 5/6>** When the **<AUX 5 / 6>** LED is on, the source monitored is the Auxiliary 5 and 6 sends.

For the Aux sends, pressing once will select the odd-numbered aux send of the pair (the light will flash slowly) and pressing again will select the even-numbered aux send (the light will flash quickly).

**<2 -TRACK/CD>** When the **<2 -TRACK/ CD>** LED is on, you are monitoring the signal coming into the **2 TR IN** stereo input (located on the unit’s top panel).

**<D-IN>** With the **<D-IN>** LED illuminated, you are monitoring the unit’s digital inputs (found on the unit’s rear).

Press once for **D-IN 1** (the light will flash slowly), and press twice for **D-IN 2** (the light will flash quickly).

## TALKBACK Select

The **TALKBACK** key engages the Talkback mic located on the left side of the SX-1’s slanted front panel. Use the Talkback mic to communicate with musicians and other talent over the Studio outputs.

The **TALKBACK** key, together with the **MONO** and **DIM** keys, is a “smart” key. Press and release these keys briefly to latch them on and off. Press and hold

them for longer before releasing to use them as non-latching keys.

### TIP

When the **SHIFT** key is held together with the **TALKBACK** key, the **TALKBACK** key acts as a slate key.

**Talkback Level** The **TB LEVEL** knob adjusts the volume of the Talkback mic.

## Monitor Level

This **LEVEL** knob controls the volume of your Studio monitors.

## SOLO Section

This section contains controls for the mixer's Solo function. Pressing the **SOLO** key on the Master Fader engages the solo mode for the Channel Strip's **MUTE** keys.

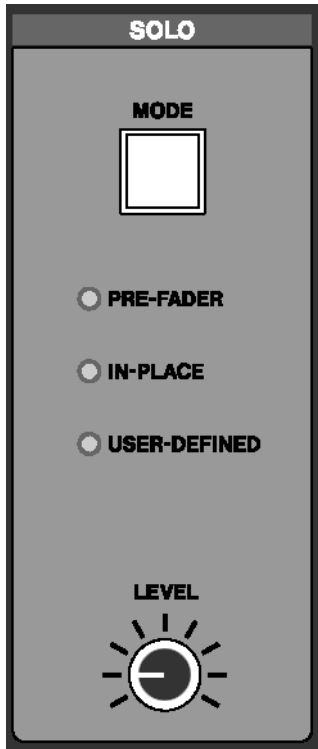

**MODE Select** The **MODE** key lets you choose how the SX-1's solo function will operate. There are three options:

**<PRE-FADER>** When the **<PRE-FADER>** LED is illuminated, the Pre-Fader solo feature is engaged. This lets you solo a source at its input, before it reaches a channel's gain stages. The pre-fader output is sent out of the Solo buss.

**<IN-PLACE>** When the **<IN-PLACE>** LED is on, the In-Place solo feature is engaged. This feature allows a soloed signal to retain the same settings as heard in the main mix (this is accomplished by muting everything going to the Master L/R buss except the soloed channel).

**<USER-DEFINED>** In operating system (OS) Version 1.0, when the **<USER-DEFINED>** LED is on, the solo mode monitors signal directly after the fader (After Fader Level). Signal is fed to the Solo buss without effects. In future OS revisions, the User-Defined feature will be expanded to include a number of enhancements.

**Solo LEVEL** This [level] knob controls the level of the Solo buss, and hence the volume of the Solo output in PFL and AFL modes (pre-fader and after-fader levels).

## HEADPHONES

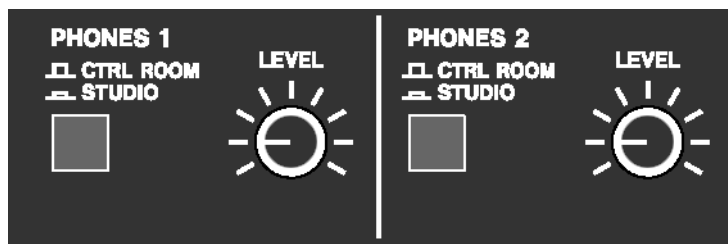

This section contains level and source controls for the two separate headphone outputs found on the SX-1's top panel.

**PHONES 1** The **CTRL ROOM/ STUDIO** key selects whether Headphone 1 receives the Control Room or Studio mix.

**LEVEL 1** This **LEVEL** knob controls the volume for Headphone 1.

**PHONES 2** This **CTRL ROOM/ STUDIO** key selects whether Headphone 2 receives the Control Room or Studio mix.

**LEVEL 2** This **LEVEL** knob controls the volume for Headphone 2.

### TRANSPORT SOLO

The keys in this section provide a way to globally solo individual components (like the HDR or the Sequencer) of your studio with a single button press.

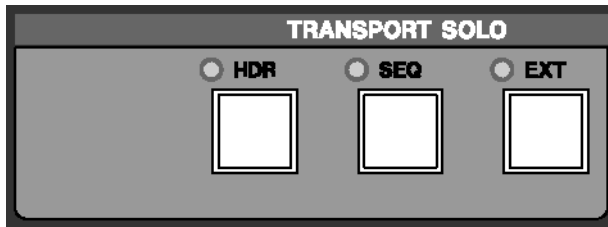

**HDR** Press **HDR** to hear just the hard disc recorder. All other audio inputs to the console will be muted.

**SEQ** Press **SEQ** to hear just the MIDI sequencer. The HDR tracks will be muted.

**EXTERNAL** Press **EXTERNAL** to hear an external device that is slaved and has its audio outputs connected to the SX-1.

## Chapter 4 – Metering & Indicators

### Reading LED Meters

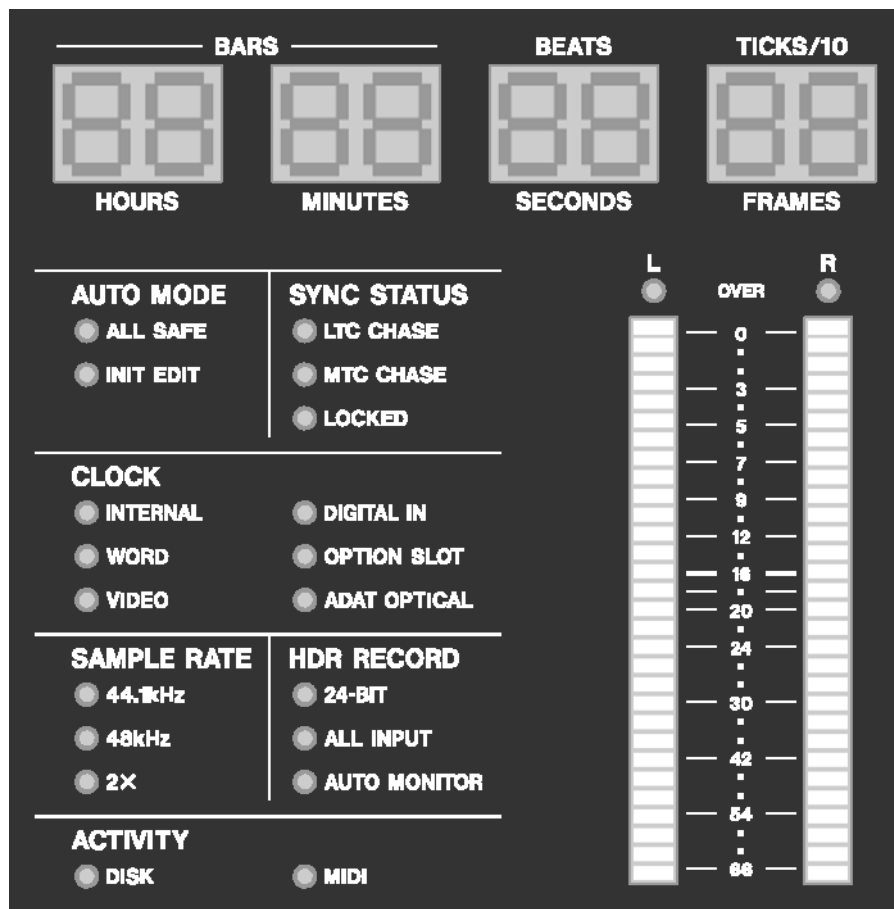

### Master Meter Section

This section houses the main Time Code display, master L/R LED meters, and a variety of indicator LEDs illustrating the SX-1's current state.

**LED Time Code Display** The Time Code display shows either hours:minutes:seconds:frames or bars:beats:ticks, feet:frames and samples.

Changing the Time Code Display's readout can be done from the VGA's Main Menu Bar Time Code Display, or by holding the surface **SHIFT** key and pressing the **MAIN DISPLAY** button on the slanted front panel.

**AUTO MODE** These LED indicators reflect the SX-1's current automation status.

<**ALL SAFE**> Indicates that automation will not be recorded.

<**INIT EDIT**> Indicates that the automation system is in Init Edit mode.

**SYNC STATUS** These LED indicators reflect the SX-1's current synchronization state.

<**LTC CHASE**> Indicates that the SX-1 is chasing incoming Longitudinal Time Code (LTC).

<**MTC CHASE**> Shows that the SX-1 is chasing incoming MIDI Time Code (MTC).

<**LOCKED**> Indicates that the SX-1 is locked to incoming time code.

**CLOCK** These LED indicators reflect the SX-1's current clock status.

<**INTERNAL**> Indicates that the SX-1's internal clock is the master clock source.

<**WORD**> Shows that incoming Word Clock is the master clock source.

<**VIDEO**> Shows that incoming video sync is the master clock source.

## Part II—Monitoring Signals and Selecting Screens

**<DIGITAL IN>** Indicates that the digital input connected to one of the rear digital input ports is the master clock source.

**<OPTION SLOT>** Indicates that a device connected to an optional card installed in one of the Option Slots is the master clock source.

**<ADAT OPTICAL>** Shows that incoming ADAT Optical (on the rear panel) is the master clock source.

**SAMPLE RATE** These LED indicators reflect the SX-1's current sample rate.

**<44.1KHZ>** Indicates that the current sample rate is 44.1 kHz.

**<48KHZ>** Indicates that the current sample rate is 48 kHz.

**<2X>** Shows that the current sample rate is one of the two high sample rate settings (88.1 kHz or 96 kHz). For example, at 88.2 kHz, both the 44.1kHz and 2X indicators will light. *High sampling rates will be available in Version 2.*

**HDR RECORD** These LED indicators reflect the Hard Disk Recorder's resolution, input and record monitoring states.

**<24 -BIT>** Indicates that the SX-1 is set to record at 24-bit resolution.

**<ALL INPUT>** Shows that the All Input monitor mode is selected.

**<AUTO MONITOR>** Shows that the Auto Monitor mode is selected.

**ACTIVITY** These LED indicators display hard disk and MIDI activity.

**<DISK>** Indicates that the hard drive is accessing.

**<MIDI>** Indicates the existence of incoming or outgoing MIDI data. The actual operation depends on the MIDI LED setting on the LCD Preferences page.

**Master Stereo Meter** The Master Stereo Meter provides a visual cue of your master output buss. It is a 30-segment LED that goes from -60 to 0 dB and features peak LED indicators to show digital "overs."

### TIP

*To see discrete meters for each mixer channel, go to the Overview screen by pressing **OVERVIEW** in the **MAIN DISPLAY MODES** section.*

## Chapter 5 – Selecting Screens

### Screen Controls

You have a choice of using the onboard LCD or a connected VGA display as your main screen.

#### Main Display Key

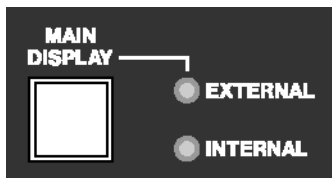

The **MAIN DISPLAY** key selects between the SX-1's onboard LCD screen or an external VGA monitor as your main display. The LCD always follows the selection keys in the **MAIN DISPLAY MODES** section.

To have an external VGA follow these keys, press **MAIN DISPLAY** and make the associated **<EXTERNAL>** LED light. The LED indicator settings are as follows:

**<INTERNAL>** When the **<INTERNAL>** LED is illuminated, the screens recalled by the keys in the **MAIN DISPLAY MODES** section appear on the LCD. If an VGA screen is connected, its display will not follow the **MAIN DISPLAY MODE** keys.

**<EXTERNAL>** When the **<EXTERNAL>** LED is on, the screens recalled by the **MAIN DISPLAY MODES** keys appear on both the LCD and the external VGA display at the same time.

#### TIP

VGA screens can also be changed, independently of the LCD, by pressing **ALT** and a number key on a connected PS/2 keyboard.

This option is available regardless of the **MAIN DISPLAY** key's setting.

The LCD also has its own set of dedicated controls in the **LCD ACCESS** section.

#### Main Display Mode Section

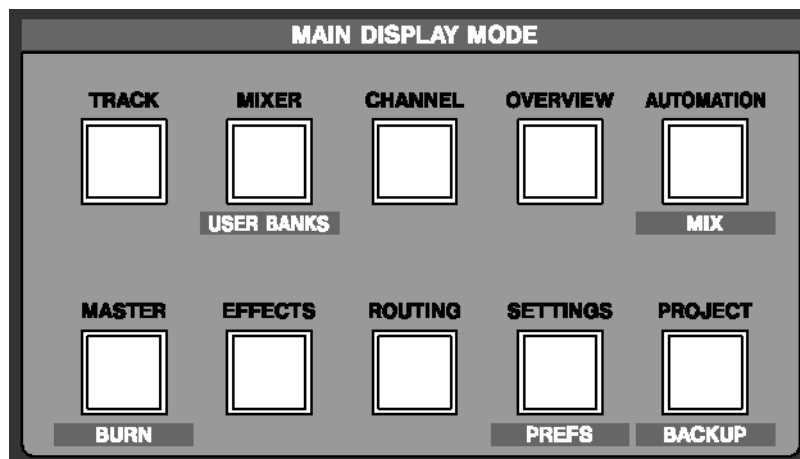

The controls in this section recall different screens. These screens appear on both the LCD and a connected VGA display (when the **MAIN DISPLAY** key is set to **EXTERNAL**).

**TRACK** The **TRACK** key recalls the TRACK screen, where tracks are created and edited.

**MIXER** The **MIXER** key recalls the MIXER screen, which shows a full console view on the VGA, along with a channel-at-once view on the LCD.

**CHANNEL** The **CHANNEL** key recalls the MIXER CHANNEL screen, which shows all of the parameters for a selected channel.

## Part II—Monitoring Signals and Selecting Screens

**OVERVIEW** The **OVERVIEW** key recalls the OVERVIEW screen, which can be used as a graphic meter bridge.

**AUTOMATION/MIX** The **AUTOMATION/ MIX** key recalls the AUTOMATION screen, and pressing **SHIFT+AUTOMATION/ MIX** recalls the MIX screen.

**MASTER/BURN** The **MASTER/ BURN** key recalls the MASTER screen where backup CD-Rs can be created and managed.

**EFFECTS** The **EFFECTS** key recalls the EFFECTS screen, where plug-ins are assigned to the SX-1's four effect quadrants.

**ROUTING** The **ROUTING** key recalls the ROUTING screen.

**SETTINGS/PREFS** The **SETTINGS/ PREFS** key recalls the SETTINGS screen which holds all of the controls for clock reference, and pressing **SHIFT + SETTINGS/ PREFS** recalls the PREFERENCES screen where a number of other settings can be stored (such as meter ballistics).

**PROJECT/BACKUP** The **PROJECT/ BACKUP** key recalls the PROJECT screen, and pressing **SHIFT + PROJECT/ BACKUP** recalls the BACKUP screen.

### TIP

*The VGA screen can also be switched by pressing ALT and a number key on the PS/2 keyboard. This option is available regardless of the MAIN DISPLAY key's setting.*

### View Menu

The VGA display's menu bar also provides a View menu, which mirrors the hardware keys of the **MAIN DISPLAY MODE** section. Zoom commands are also available if you prefer an alternative to the click-and-drag zoom method.

Track	ALT	1
Mixer	ALT	2
Channel	ALT	3
Overview	ALT	4
Automation	ALT	5
Master	ALT	6
Effects	ALT	7
Routing	ALT	8
Settings	ALT	9
Project	ALT	0
<hr/>		
Zoom In	ALT	]
Zoom Out	ALT	[
Zoom All	ALT	\
<hr/>		
Vertical Zoom In	SHIFT ALT	]
Vertical Zoom Out	SHIFT ALT	[
<hr/>		
Master Channel	ALT	M

**Screen Recall Commands** Each command recalls its associated screen for the VGA. Explanations of these screens are found in the relevant chapters (such as, the Automation screen is found in the chapter that addresses automation, Chapter 12).

**Zoom In** Magnifies (zooms in) data horizontally, relative to time, on the TRACK and AUTOMATION screens, and "Waveform" and Auto Track tab views.

**Zoom Out** Expands (zooms out) data horizontally, relative to time, on the TRACK and AUTOMATION screens, and Waveform and Auto Track tab views.

### TIP

*Another way of zooming in and out is the ALT + [ ] PS/2 Keyboard command. Waveform height can also be changed with SHIFT+ALT+[ ].*

**Zoom All** Zooms all the way out to show the entire project in the TRACK and AUTOMATION screens, and Waveform and Auto Track tab views.

**Master Channel** Recalls the Master stereo output CHANNEL screen. This command is identical to pressing **CHANNEL** from the **MAIN DISPLAY MODE** section and then selecting the Master fader channel (by pressing its **SEL** key).

### TIP

*Each command's associated PS/2 keyboard shortcut is listed in the menu (right after the command's title).*



## LCD ACCESS Section

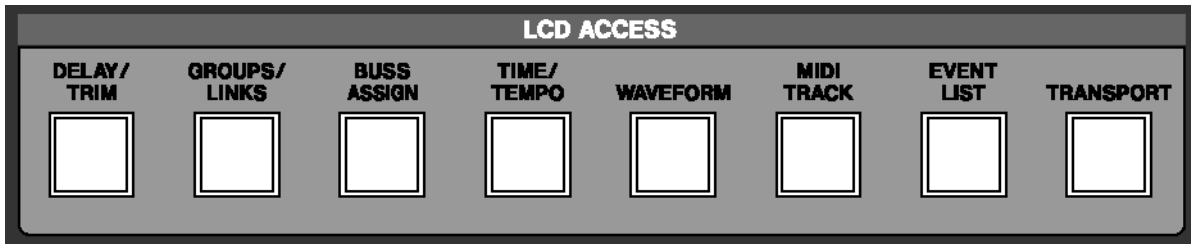

The controls in this section recall screens for the SX-1's LCD display. Many of these screens reflect the tabs of the VGA screens (for example, the Track screen's tabs).

**DELAY/TRIM** The **DELAY/TRIM** key recalls the Delay/Trim screen, which houses individual channel delay and level trim controls.

**GROUPS/LINKS** The **GROUPS/LINKS** key recalls the Groups/Links screen, where fader groups and linked parameters and channels are managed.

**BUSS ASSIGNMENT** The **BUSS ASSIGNMENT** key recalls the Buss Assignment screen, which handles all buss routing for the console.

**TIME/TEMPO** The **TIME/TEMPO** key recalls the Time/Tempo screen, where a project's Tempo and metronome settings may be modified.

**WAVEFORM** The **WAVEFORM** key recalls the Waveform screen, where a selected channel's sample-accurate waveforms can be viewed and edited on the LCD.

**MIDI TRACK** The **MIDI TRACK** key recalls the MIDI Track screen which contains a Piano Roll display.

**EVENT LISTS** The **EVENT LISTS** key recalls the Event Lists screen where individual events may be viewed and edited.

**TRANSPORT** The **TRANSPORT** key recalls the Transport screen where external devices are controlled, locate points are managed, and parameters like frame rate are set on the LCD.

## LCD Screen

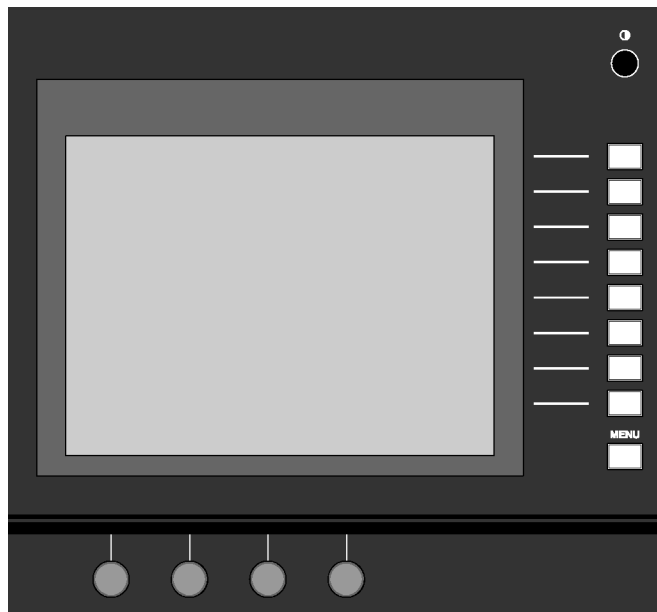

The onboard LCD provides access to all the necessary operating screens. In situations where an external VGA display is not available, the SX-1's

software components can be reached directly through the LCD. The LCD can also work in tandem with the VGA to provide a second display.

## Part II—Monitoring Signals and Selecting Screens

**LCD Contrast** This knob  adjusts the viewing angle and contrast of the LCD screen.

**Soft Keys** The functions of these keys change according to the current LCD screen.

**MENU** The **MENU** soft key is dedicated to turning the soft keys' ACTIVE MENU on and off.

**Soft Knobs** The functions of these knobs change according to the current LCD screen.

## Chapter 6 – Transport, Loop, Auto Punch

### Transport Controls

#### Front Panel

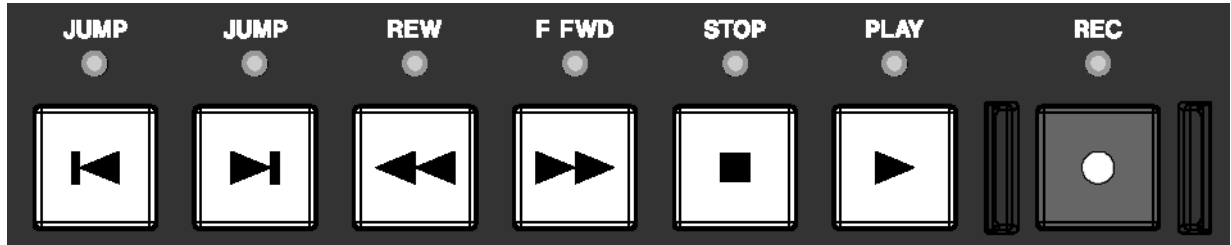

These keys provide standard tape-style transport controls for navigating through the currently loaded project.

**JUMP Back** By default, the left **JUMP** key moves the playhead to the beginning of the first event in the project. However, it is possible to set this **JUMP** key to function differently. These settings are made in the LCD TRANSPORT screen (pictured below).

**JUMP Forward** By default, the right **JUMP** key moves the playhead to the end of the last event in the project. However, it is possible to set this **JUMP** key to function differently. These settings are made on one of the LCD's PREFERENCES screens (the TRANSPORT screen pictured below).

**LCD Jump Controls** There are controls on the LCD's TRANSPORT screen for setting Jump functionality.

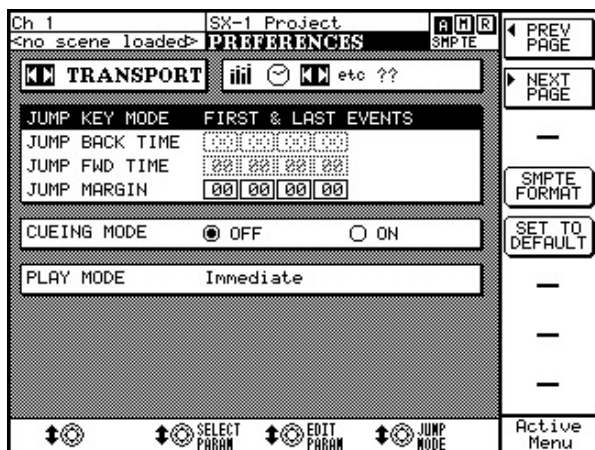

Press **SHIFT**, then, from the **LCD ACCESS MODE** section, press **SETTINGS/ PREFS**. Use the **NEXT PAGE** soft key to scroll to this screen.

**JUMP KEY MODE** The Jump Keys can operate in one of 3 different modes:

**FIRST LAST** With this setting selected, the **JUMP** Left key will locate the playhead to the beginning of the first event in the project. The **JUMP** Right key will locate the playhead to the end of the last event in the project (this is how the TASCAM MX-2424 works).

**ABSOLUTE** With this setting selected, the **JUMP** Left and **JUMP** Right keys jump to specific values. These values are entered in the Jump Left and Jump Right registers located directly below.

**LCT POINTS** With this setting enabled, the SX-1 will scroll through all Locate Points stored in the project in chronological order, upon repeated presses of the **JUMP** keys, even if they are not sequentially numbered that way.

**JUMP LEFT & JUMP RIGHT** Settings entered here will dictate where the playhead locates after a Jump Left or Jump Right in Absolute Jump Mode.

**OFFSET** This setting acts much like a pre-roll for the Jump commands. If the value is anything other than zero, the playhead will locate to the point dictated by the Jump mode, adding or subtracting the Offset value from the original location.

**CUEING MODE** This setting causes Fast Forward and Rewind to operate audibly at up to a maximum 1.5 times the play speed while monitoring audio. The effect is much like Scrub, and is useful for situations when an external video deck is chasing the SX-1.

**PLAY MODE** This determines the behavior of the transport after any locate operation. There are three modes:

## Part III—Locate, Transport, & Surround

**Immediate** In this mode, the SX-1 stops after any locate operation.

**Automatic** In this mode, the SX-1's transport will immediately engage PLAY after any locate operation.

**Deferred** When the SX-1 is controlling external devices, pressing PLAY during a locate operation results in playback starting after the locate operation is complete.

**REWIND** This key ◀◀ rewinds the project.

**FAST FOWARD** This key ▶▶ fast forwards the project.

**STOP** This key ■ stops playback.

**PLAY** This key ▶ starts playback and punches out of Record.

**RECORD** With a track record enabled and the transport in PLAY, press this key ● to punch in.

### VGA Transport

Transport controls that mirror the front panel **Transport Keys** are available in the VGA screens' Main

Menu Bar. The Record key displays an "M" when Mixdown Mode is enabled.



### LCD Transport

A variety of external devices can have their transports controlled directly from the SX-1's **Transport Keys**.

**LOCATE POINTS** Opens the screen where you can manage Locate Points ("Locate Points" on page 38).

**REGISTER** Opens the REGISTERS screen where you can view and adjust Loop, Autopunch, and Audition points.

**EXTERNAL DEVICES** Use this screen to manage the SX-1's transport communication with external devices.

**FRAME RATE** This knob sets the project frame rate. Rates of 30, 29.97, 29.97 Drop, 25, and 24 frames per second (fps) are available. To change the current frame rate, you must select Accept or Cancel from the tab that appears at the right of the screen.

**SMPT/TIMECODE OFFSET** This parameter determines the amount of offset from incoming and outgoing timecode. Values can be entered by using the keypad.

Turning the knob accomplishes two things: the knob now acts as a cursor for the offset register (moving the cursor from hours to minutes to seconds, for instance), and it opens a dialog strip on the right side of the LCD screen:

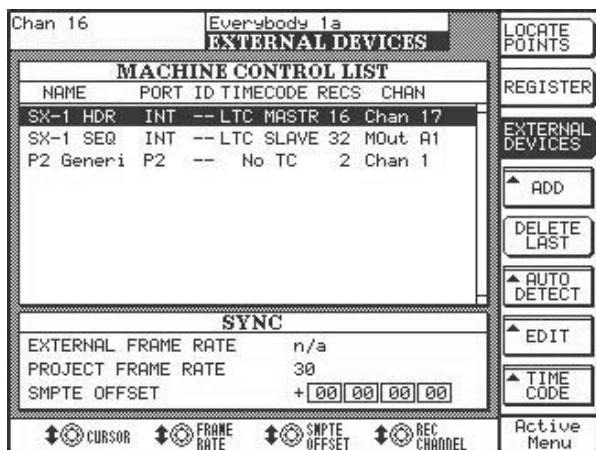

**REC CHANNEL** This parameter determines which channel strip on the SX-1 will act as the first channel for remote track arming. The above example has Channel 17 set for this value.

**TOGGLE SIGN** When this key is pressed, the offset value changes from a positive offset (+) to a negative offset (-), meaning that an offset of +00:00:02:00 would play back two seconds later than the device generating the timecode, and that an offset of -00:00:02:00 would play back two seconds earlier.

**CURSOR <---** Moves the cursor to the left by one value.

**CURSOR --->** Moves the cursor to the right by one value.

**SMPT/FORMAT** This key toggles the offset display to show one of the four timecode choices available in the SX-1.

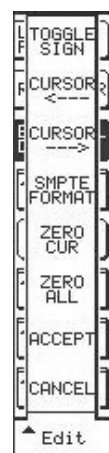

**ZERO CURSOR** This key clears any value that the cursor is currently selecting.

**ZERO ALL** This key clears the contents of the entire register.

**ACCEPT** Accepts the change.

**CANCEL** Declines the change.

**ADD** This key opens the ADD dialog. Use these selections to add the devices you want to control from the SX-1:

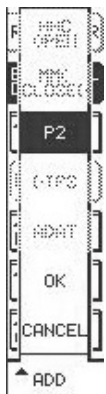

**MMC OPEN** Use this to add devices that accept Open Loop MIDI Machine Control Protocol to the list. *This selection will be available in Version 1.5.*

**MMC CLOSED** Use this to add devices that require Closed Loop MIDI Machine Control Protocol to the list. *This selection will be available in Version 1.5*

**P2** This selection adds a generic P2 device. Generic transport, jog/shuttle wheel and track arming is available. With Auto Detect on, the SX-1 will sense from the P2 connection what kind of device is present, and should update its display accordingly.

**DTRS** This selection will add a DTRS tape machine (this family of machines includes the TASCAM DA-88 and DA-78HR) to the list. *This function will be available in Version 1.5.*

**ADAT** Use this selection to create a device profile for controlling a connected ADAT. *This selection will be available in Version 1.5.*

**EDIT** This key opens the EDIT dialog:



**RECS** This selection sets the number of record channels that a device supports for remote track arming.

**NAME** With this selection you can name the devices in your list.

**CHASE MODE** This key opens the CHASE MODE dialog. Use these selections to specify whether the SX-1 will operate as a master or slave, and the type of time code it will generate or recognize:

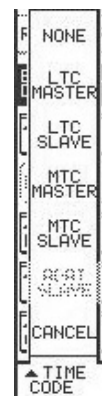

**NONE** No time code is generated or recognized.

**LTC MASTER** Specifies that the SX-1 will generate Longitudinal Time Code.

**LTC SLAVE** Specifies that the SX-1 will chase incoming Longitudinal Time Code.

**MTC MASTER** Specifies that the SX-1 will send MIDI Time Code out its MIDI Out jacks. You can select the MIDI ports that are used to send MTC.

This parameter is found in the Global tab of the VGA Tracks screen.

**MTC SLAVE** Specifies that the SX-1 will chase incoming MIDI Time Code at its **MTC IN** jack.

---

### P2 Remote Machine Control in the SX-1

---

The SX-1 has full support for the Sony P2 Protocol for controlling video decks and other multitrack audio devices. Together with the Transport SOLO

function, seamless video post-production edit integration is possible.

---

#### The Philosophy

The SX-1 will always try to send transport commands to the machine that is the current Timecode Master. The settings in the Machine Control List (LCD TRANSPORT Screen) and the state of the Transport **SOLO** keys determine which machine is the master.

The SX-1 will always contain 2 machines in this list, i.e. the HDR and the Sequencer/Automation. For simplicity, you are allowed to choose the Timecode

master/slave state of the HDR only, because the Sequencer and Automation engine is always locked to the HDR's current time.

In order to use the P2 remote control port, it is necessary to add a machine to the 2 internal machines already in the Machine Control List. This is possible by manually adding a device, or using the auto-detect feature of the SX-1.

---

#### General SX-1 Transport Controls

The SX-1 has a number of transport controls that are generally used for the internal HDR recorder and sequencer, but which also work when an external device is the Transport Master.

- Main Transport Keys
- Locate buttons.
- Jog/Shuttle
- Auto Play Mode
- Cueing Mode
- Record Arms.

---

#### Customizing the Devices

It is possible to change the name of the device that appears in the list, or if the Auto-Detect function is used, the name will automatically be chosen to match the detected device. Similarly, the number of Rec Arm channels is user selectable, but auto-detect will attempt to match the capabilities of the detected device.

The Sony P2 protocol allows designating up to 4 tracks as Analog, and any number as digital tracks. Most Analog VTRs only have 2 audio channels, so if the number of Rec Arm channels is set to 2, the SX-1 will use Analog track commands to tell the external device which channels to arm. 4 Channel devices are also treated as analog, but once you select 8 or more Rec-arm channels for a device, the P2 Digital channel Rec-Arm protocol will be used. Multi-track audio recorders such as the Tascam DTRS and MX-2424 series use this extensively, but the DA-88 notably has a programmable Rec-Arm assignment that includes a hybrid analog/digital mix. Such a mixed setting will be unusable with the SX-1, so set the DA-88 to use all Digital P2 Rec-Arm designations.

If you have a device that has just 4 Digital channels, you will need to set the device to 8 channels in order

to use the digital Rec-arm assignments in the P2 Protocol.

The user can specify which **REC-Arm** button on the SX-1 front panel starts the **REC-Arm** functions of each device. The Internal HDR, for example, defaults to channel 17, because that is where the default routing places the return signal from the HDR. If the starting channel places the last channel of the selected device off the end of the front panel, then the **REC-arm** assignment continues onto the next logical bank, i.e. it wraps around. This is useful if you have a MX-2424 selected that you wish to dump a whole session to in real-time, you will always be able to access all of the 24 record arm function buttons, even though the front panel shows 16 at any one time.

Select the start channel according to where the first signal from the external device is routed into the SX-1's mixer, or alternatively to the buss or channel that's direct out feeds the first audio input of the external device.

If two machines overlap in their Rec-arm function assignments, then the SX-1's front panel channel strips will show and operate the **REC-Arm** belonging

to the first machine in the Machine Control List that contains that channel.

To customize a device, select it in the Machine Control List with the up and down arrows on the front surface (**DATA ENTRY** keys) or the left most encoder knob. Press the EDIT soft menu button and then you will have the following choices.

**IDS:** Changes the ID number assigned to the external device, not used for P2 devices.

**RECS:** Toggles the number of REC-ARM channels between the supported values, which are 2, 4, 8, 16, 24, 48 and 64. The other possible values of 4, 32, 40 and 56 are only available if the Auto-Detect feature recognizes the external machine as having that number of tracks to control.

## Working with External Timecode Sources

Most of the time, the only reason to want to control an external device from the SX-1 is when it is the Timecode Master, and you want the SX-1's HDR and Sequencer to follow the external Video, for example. The SX-1 is capable of chasing and locking to Longitudinal and MIDI Timecode variations (LTC and MTC). Since MTC is a low-precision signal that is further compromised by sharing the Midi data stream with regular note and controller information, the SX-1 provides an MTC only input to pipe the Timecode information directly into the synchronization hardware. If the MTC source is the same as your other MIDI data, then you can set the MTC input to be the regular MIDI Input.

The SX-1 will inspect the contents of the Machine Control List, and send the transport commands, jog/shuttle speed and locate commands to the device that is the Timecode master, favoring LTC Master over MTC master if both exist. The exception to this rule is the Record button. Pressing Record (from any of the front panel, VGA UI or foot switch sources) will enable record for all of the devices in the list, if there is a channel for that device Rec-Arm enabled. Similarly, exiting record by any means will exit record on all machines, not just the "Transport Master".

If after enabling Record, the **RECORD** Transport LED remains blinking, then you know that no **REC-**

**NAME:** Allows editing the displayed name of the device. Only the first 9 characters will be visible in the LCD screen.

To change the starting channel for the Rec-Arm assignment, turn the 4th encoder under the LCD screen to bring up a popup of the possible choices.

Note that the SX-1 internal Sequencer shows 64 Rec channels. This is because there are 64 output MIDI channels (4 outputs at 16 channels each). The sequencer itself has 128 tracks, and each of these tracks can be routed to any of the 64 outputs. The SX-1 uses a smart algorithm to determine which Sequencer track to **REC-Arm**, given the MIDI output track **REC-arm** channel pressed.

Arm controls are ON for the devices in the machine control list.

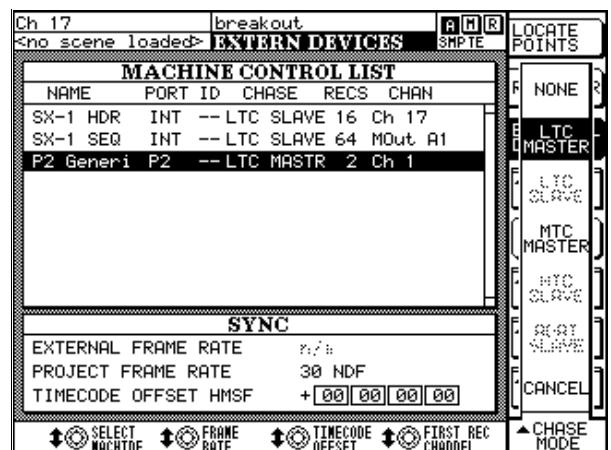

To Select the P2 device as your LTC master, first highlight the P2 device in the Machine Control List and then press the Chase Mode Soft Menu button. Pressing the LTC Master soft menu button will set the external machine to be the LTC Master. The SX-1 will automatically change the HDR's chase mode to LTC SLAVE for you.

From this point on, the SX-1 Front Panel will indicate with the **SYNC STATUS LTC CHASE** LED On, and the **LOCKED** LED will be blinking, indicating that the SX-1 HDR and sequencer will lock and chase the external timecode. Note that the 7-seg display will advance a little, about 22 frames at 30NonDrop, because the HDR "parks" 32000 samples ahead of the current Timecode. This is so the HDR can count and verify the incoming Timecode when it starts to move, and be ready to lock at play speed as soon as possible.

The P2 device could be your MTC master as well, just select MTC Master from the Chase Mode soft menu. The **SYNC STATUS** LEDs will change to **MTC SLAVE**.

If you just wish to have the SX-1 follow the external Timecode but not send out P2 commands, then you can just set the HDR Chase mode to LTC SLAVE or MTC SLAVE directly. In this case, the SX-1 does not know where to send Transport commands, but you will be able to do one clever operation by latching the Record button.

Normally, when the HDR is set to Chase Mode LTC or MTC Slave, the transport buttons are assigned to no device. When the external Timecode starts moving, the HDR will chase and lock, and the PLAY LED will light solid. In this situation, you can use the Record button to punch in record channels on the HDR. If the Timecode was not moving, there is no way for the SX-1 to start recording. In this case, pressing the Record button will “latch” your request to go into record, and as soon as the HDR locks to the external Timecode, it will automatically do the punch in. This is useful if you have a project in a PC DAW

that you wish to transfer to the SX-1 over MIDI and Audio. Set the SX-1 to MTC SLAVE, hit record and then go to your PC and press play. The SX-1 will chase and then automatically record for you.

Note that the SX-1 has a restriction in this operation. If the external Timecode starts before midnight (00:00:00:00), then the SX-1 is unable to do the automatic record for you more than 20 seconds before midnight. In this case, the user will have to wait until the SX-1 has reached within 20 seconds of 00:00:00:00 before pressing the Record button. Even in this case, the actual recording will not start until exactly 00:00:00:00, as no events may start before that time.

The SX-1’s Timecode chase hardware can correctly follow Timecode that crosses 00:00:00:00 (midnight). It does this by treating any Timecode in the range 23:00:00:00 to 23:59:59:29 as being –1:00:00:00 to –00:00:00:01. This allows a Timecode source to preroll and play back over the 00:00:00:00 midnight boundary without the SX-1 jumping forwards a whole day.



## LOOP Section

Tracks can be looped during playback, rehearsal, and recording. The keys for setting the loop are found in this section.

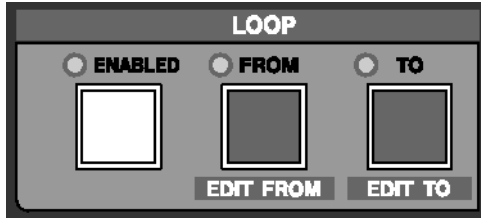

**ENABLED** Press the **ENABLED** key to activate loop playback.

**FROM/EDIT FROM** After using **CAPTURE** to grab a time value, use the **FROM/EDIT FROM** key to store the loop start point, and **SHIFT+FROM / EDIT FROM** to adjust the loop start point.

**TO/EDIT TO** After using **CAPTURE** to grab a time value, use the **TO/EDIT TO** key to capture the loop end point, and **SHIFT+TO/EDIT TO** to adjust the loop end point.

### TIP

Use the **CAPTURE** key in conjunction with the **FROM/EDIT FROM** and **TO/EDIT TO** keys to set the loop points. Press **CAPTURE** and then the key for the loop point you want to set.

## Auto Record Controls (AUTOPUNCH Section)

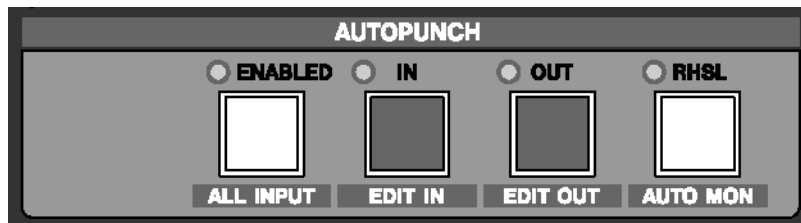

The keys in this section are for setting the automatic punch in and out recording points.

### NOTE

*It is important to note that once Autopunch is enabled, it is not necessary to press the transport's **RECORD** key, as the SX-1 will automatically drop into record when the transport passes the Autopunch In point. When Autopunch is enabled, the transport's **RECORD** key flashes as an additional indication.*

**ENABLED/ALL INPUT** Press the **ENABLED/ ALL INPUT]** key to activate Autopunch mode, and **SHIFT+ENABLED/ ALL INPUT** to activate the All Input monitor mode during Autopunch.

**IN/EDIT IN** Use the **IN/ EDIT IN** key to store the Autopunch input point, and **SHIFT+IN/ EDIT IN** to fine-tune the Autopunch input point.

**OUT/EDIT OUT** After using **CAPTURE** to grab a time value, use the **OUT/ EDIT OUT** key to store the Autopunch output point, and **SHIFT + OUT/ EDIT OUT** to fine tune the Autopunch output point.

### TIP

Use the **CAPTURE** key in conjunction with the **IN/ EDIT IN** and **OUT/ EDIT OUT** keys to set the Autopunch points. Press **CAPTURE** and then the key for the Autopunch point you want to set.

**REHEARSAL/AUTO MON** Pressing the **REHEARSAL/ AUTO MON** key allows you to practice the Autopunch without actually recording. Pressing **SHIFT+REHEARSAL/ AUTO MON** enables All Input monitoring during an autopunch when the Rehearsal mode is active.

## Chapter 7 – Locate Points

### Creating Locate Points

#### CAPTURE Key

All edit and location memory points are set using the **CAPTURE/ USE AGAIN** key. Registers that require this key to set memory points are listed below:

Locate Points	LOOP	EDITING	AUTO PUNCH
keypad 0-999	FROM/ EDIT FROM	BEGIN/ EDIT BEGIN	IN/ EDIT IN
	TO/ EDIT TO	END/ EDIT END	OUT/ EDIT OUT
		SYNC POINT/ EDIT SYNC	

**CAPTURE/USE AGAIN** When **CAPTURE/ USE AGAIN** is pressed, the playhead's current location is captured as a time value. To assign this location to a register, follow these steps:



- 1 Press **CAPTURE**.
- 2 An LED next to the keys whose functions can be assigned the captured location point will flash. Press one of these keys and the captured point will be assigned to that register.

### Create a Locate Point

- 1 Cue the SX-1 to the spot where you want to capture a locate point.
- 2 Press **CAPTURE**. The key's associated LED will light to show that the SX-1 has captured the time value.

The SX-1 will auto-number locate points for you if you wish. Simply press **ENTER** on the numeric keypad instead of first entering a

- number. The SX-1 will store the new locate point, incrementing any existing number by one digit.
- 3 Press a number on the numeric keypad in the Data Entry section to assign the captured value to a memory slot/locate point.
- 4 Press **ENTER** on the keypad to store the location to that slot.

### Recalling & Editing Locate Points

**LOCATE Section** These keys provide a way of locating directly to a specific position within the current project.

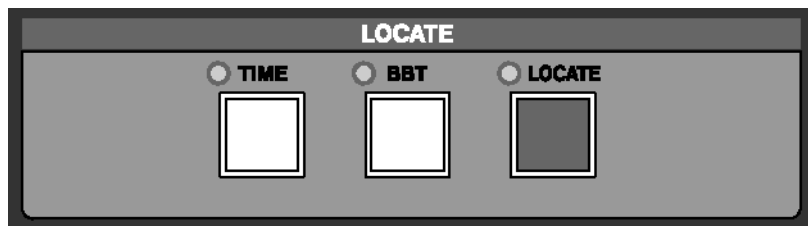

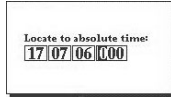

**TIME** Press the **TIME** key to open a time register window on the LCD screen (pictured left). Enter a value from the keypad and press

**ENTER** to move the transport to that location.

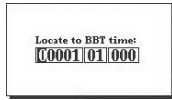

**BBT** Press the **BBT** key to open a bars:beats:ticks register window on the LCD screen (pictured left). Enter a value from the Keypad and

press **ENTER** to move the transport to that location.

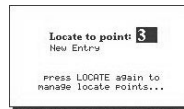

**LOCATE** Use the **LOCATE** key to recall saved locate points and to enable the creation of new ones. Press the key once and a locate point register window

appears on the LCD screen (pictured left). Use the Keypad to enter a stored locate point and press **ENTER** to move the transport to that location. Pressing the key twice in rapid succession will bring up the TRANSPORT screen's Locate window where points can be named and managed.

## VGA Locate Control

To reach this tab, press the **TRACK** key in the **MAIN DISPLAY MODE** section to recall the Track screen. Then click once on the Transport tab.

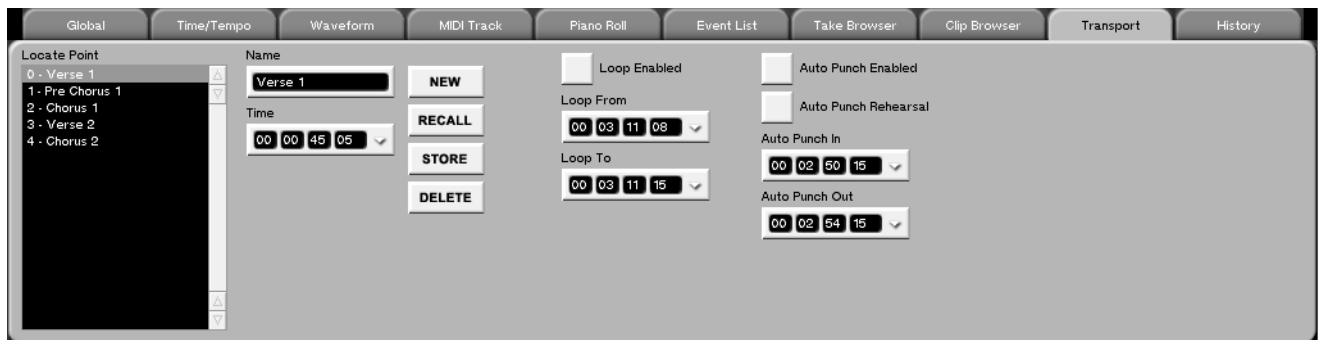

**Locate Point** This window allows you to see and select locate points associated with your current project.

**Time** This field has two functions. Firstly, it displays the time stamp of the currently selected (highlighted) locate point. Secondly, the selected locate point's time stamp can be changed by entering a new time and pressing the STORE button.

**Loop Enabled** Turns the Loop function on. With Loop enabled, the SX-1 will play from the Loop From point to the Loop To point continuously.

**Loop From** Sets the Loop In point. Remember that for this location point, as well as all of the following time-based points, pressing **CAPTURE** first will grab the time value. From there you can store that value in any register (as indicated by the prompt indicators after you press **CAPTURE**).

**Loop To** Sets the Loop Out point.

**Auto Punch Enabled** Turns the Auto Punch function on. In this mode, with the transport in motion and in record, the SX-1 will automatically punch into the record enabled track when the transport crosses the Auto Punch In point, and will punch out of record when the transport crosses the Auto Punch Out point.

**Auto Punch Rehearsal** Places the Auto Punch function in Rehearsal mode. In this mode, the SX-1 will simulate an Auto Punch action (by switching to Input monitor at the Auto Punch In point and back to disk playback at the Auto Punch Out point). This allows you fine-tune your punch points for accuracy before recording anything.

**Auto Punch In** Sets the Auto Punch In point.

**Auto Punch Out** Sets the Auto Punch Out point.

## LCD Locate Control

Direct access locate controls are also available through the LCD screen.

### LOCATE POINTS

On this screen you can manage, create, recall, and edit your current project's locate points.

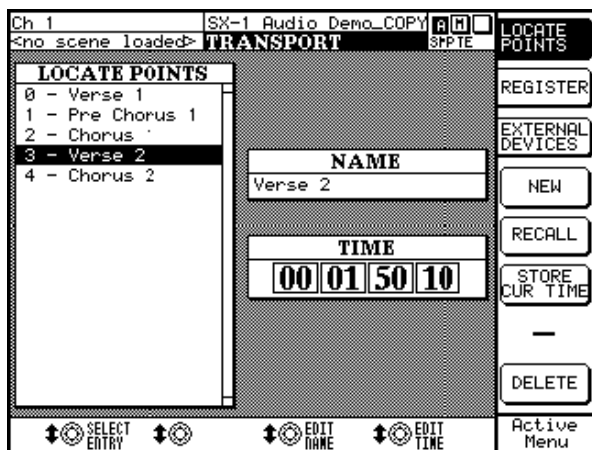

From the **LCD ACCESS** section, press **TRANSPORT**, then press the soft key next to **LOCATE POINTS** to recall this screen. Or, just hit the **LOCATE** button on the surface twice, in rapid succession.

**SELECT ENTRY** Scrolls through the locate points in the **LOCATE POINTS** window.

**EDIT TIME** Opens the **EDIT TIME** dialog and allows the selected locate point's position (its time stamp) to be changed.

### REGISTERS

On this screen you can enter values for a variety of location based settings directly from the keypad.

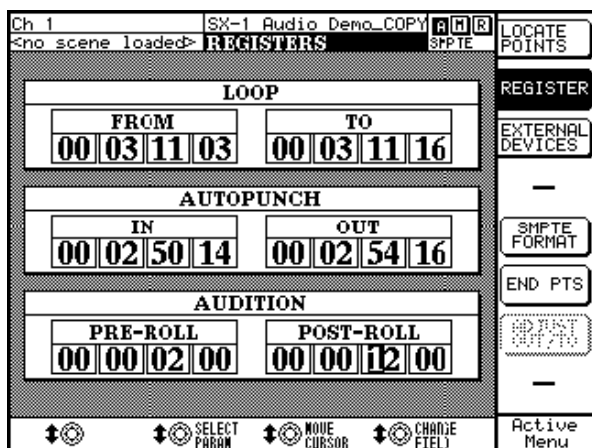

**SMPTE FORMAT** Switches between the different possible timecode displays: SMPTE, hours:minutes:seconds, bars:beats:ticks, feet:frames, or samples.

**END PTS & DURATION** Switches the Loop TO and the Auto Punch OUT fields between endpoint and duration (the length of the current selection) displays.

**ADJUST IN/FROM & ADJUST OUT/TO** This parameter becomes active when the Loop and Autopunch Duration fields are active. This setting allows the editing of the In/From and Out/To points separately. For example, this means that while lengthening Duration, you can decide whether to move the Out point to the right (further down the timeline), or the In point to the left (earlier on the timeline)—as one of them has to move to lengthen a duration.

**SELECT PARAM** Moves the cursor between the different location fields.

**CHANGE FIELD** Changes the value of the selected field.

From the **LCD ACCESS** section, press **TRANSPORT**, then press the soft key next to **REGISTER** to recall this screen.

## Chapter 8 – Surround

### Setting Up Surround

The SX-1 has full surround mix capabilities. Switching from the default stereo mode of operation to a surround mode changes a number of screens and

parameters. This chapter details these changes and explains how to select the surround mix mode that's right for your project and setup.

### Making the Change to Surround

Switching to surround can be done from both the VGA and the LCD screen.

From the VGA, go to the Global tab of the Tracks screen. Here, you will find a field labeled Surround

Mode. In this field you can choose the surround mode that matches your setup: Quad, LCRS Surround, or 5.1 Surround.

### LCD Access to Surround

On the LCD there is a screen dedicated to choosing the surround mode. If you are not familiar with the speaker positions of the various surround modes, this screen presents a helpful illustration.

To reach this screen, press the **SETTINGS/ PREFS** key in the **MAIN DISPLAY MODE** section. Then, use the NEXT PAGE soft key to scroll to the SETTINGS screen labeled SURROUND. To change the surround mode, use the left and right arrow keys of the keypad.

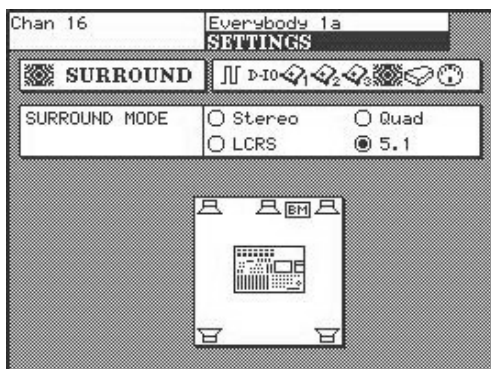

### Surround Modes Explained

**5.1 Surround** A panning/routing scenario where six speakers are used. Three speakers are positioned along the front wall, while two more are positioned along the back wall behind the mix position. In addition, there is also a subwoofer speaker. The five regular speakers refer to the “5” in 5.1, while the “.1” in the name refers to the subwoofer.

The speakers are labeled Left Front, Center, Right Front, Left Rear, Right Rear, and Boom (for the LFE/subwoofer), and are normally arranged similarly to the setup on the LCD screen (pictured above).

**Quad** A panning/routing scenario where four speakers are used. The speaker positions in Quad are basically the same as in 5.1, minus the center channel and subwoofer.

**LCRS Surround** A panning/routing scenario where four speakers are used. The speaker configuration consists of three speakers on the front wall, with only one behind the mix position. “LCRS” refers to speakers arranged as Left, Right, Center, and Surround.

## Understanding the Changes

### VGA Channel

Several key adaptations are made to the mixer channels in order to accommodate the selected surround mode. These changes are reflected in both the Channel and the Mixer screens.

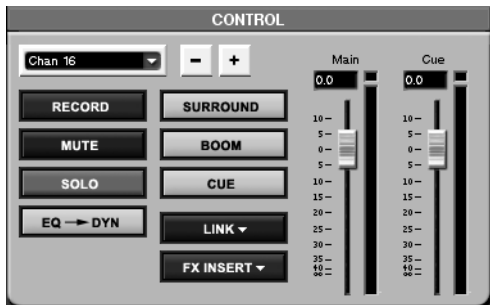

On the Channel screen, the CONTROL and POSITION modules (pictured here) are updated. As well, on the Mixer screen, the pan and buss modules for each channel are also updated.

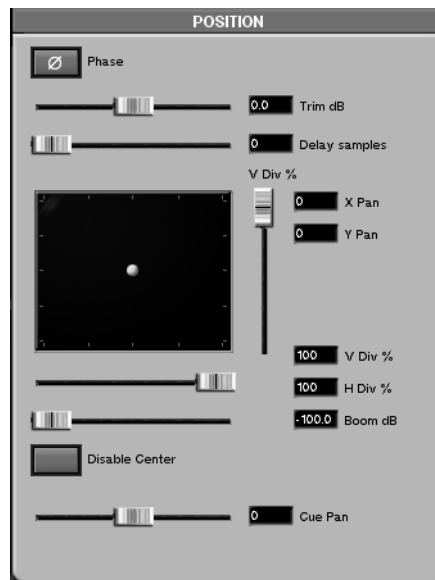

**Surround Panner** The Panner becomes a dot that can be pulled, using the mouse, in a 360 degree field. In traditional surround mixing for film, the center channel is reserved for dialog only. This ensures that the dialog is always easily understood, because no music or effects are sent to that channel. The Disable Center key removes the Center channel as a possible output (thus ensuring that none of your music or effects bleeds into your dialog channel). Once Disable Center is selected, the panning paradigm for the channel becomes Quad (with the exception that the Boom send still works).

There is a slider labeled Boom dB which is the send for the subwoofer or LFE (Low Frequency Extension). In the VGA Mixer channels, this slider resides immediately below the Surround Panner control.

The two sliders to the right and bottom of the pan field are for Vertical and Horizontal divergence.

Taken individually, Vertical divergence sets the distance from the front speakers to the rear speakers, while Horizontal divergence sets the distance from side to side. It acts as if at a lower divergence setting you were physically moving the speakers closer together, and that at a higher setting you were physically moving the speakers further apart.

#### TIP

*To illustrate this, set both the vertical and horizontal divergence to zero. You can pull the dot wherever you wish, but the actual signal moves nowhere.*

**Tracks Screen** On the Tracks screen you'll notice that the buss assignments are now surround mix buses. For example, the updated buss output assignments for 5.1 Surround mode include the surround output, boom, and cue.



## Routing Surround Busses

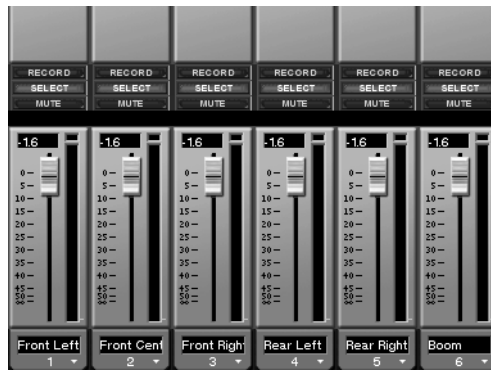

The surround busses can be assigned to any available output (for example, an Option Slot, Aux Send jack, Control Room, Studio, SPDIF, etc.).

All the routing pages and menus will update to reflect the currently selected Surround Mode. The image here shows how the Fader Bank Mixer Buss screen appears in 5.1 mode (notice there are 6 busses where there were previously 8 in stereo mode). The surround busses are also reflected on the LCD screen

(pictured here). To reach this screen, with surround enabled, press **OVERVIEW** and then the BUSS softkey.

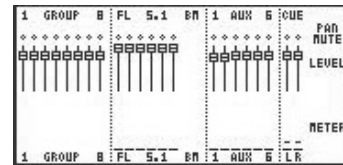



## Chapter 9 – Channel Control

### Front Panel

#### Channel Strips

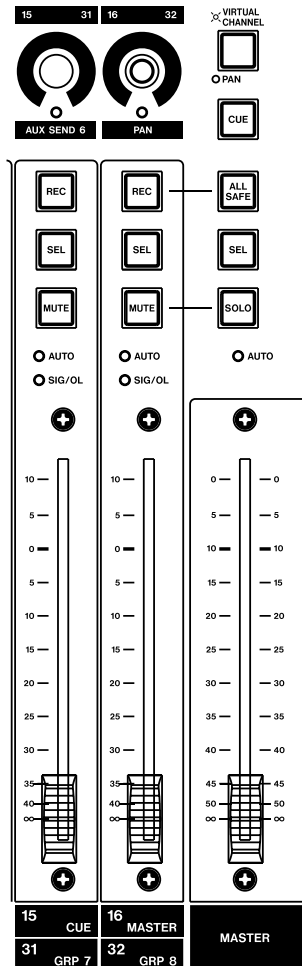

There are 16 Channel Strips, each with its own fader and associated control keys. The Channel Strips are fully assignable, allowing them control over any of the mixer's 40 inputs as well as groups, master faders, MIDI tracks, and busses.

#### Channel Fader

Fader for controlling the channel's level. The SX-1's faders are motorized and touch-sensitive for dynamic automation.

**REC** Use this key to arm a track for recording. This can be an HDR or a MIDI track, depending on what the strip is assigned to.

**SEL** The **SEL** key selects the mixer channel for editing of

its individual parameters (such as, EQ, effects, and automation).

**MUTE** The **MUTE** key works either as a channel mute or a solo button. If the **SOLO** key on the Master Fader is not lit, then the **MUTE** key mutes the channel. If the **SOLO** key on the master fader is depressed (and glowing red), the **MUTE** key solos the channel (the Master Fader **SOLO** key is described here).

**<AUTO>** The **<AUTO>** LED indicators glow solid red to show Write automation Ready. They blink red when writing automation data for their associated channel strip.

**<SIG/OL>** The **<SIG/OL>** LEDs light green to indicate that a signal is present at the channel's input and red on peaks.

#### NOTE

*When turning on the SX-1, the faders move as they are automatically calibrated. Make sure that nothing is resting on the surface, and that the faders are free to perform their "fader dance" as the SX-1 starts up.*

**Master Channel** There is one Master Channel for controlling the mixer's main stereo output. The Master Channel's keys also dictate how the Channel Strips' associated keys and the Virtual Channel Strip will function.

**Master Fader** The Master Fader controls the level for the master stereo buss output (and the busses in surround modes).

#### TIP

*The Master Fader Channel screen can be recalled on the VGA or LCD by pressing the **CHANNEL** key (from the **MAIN DISPLAY MODE** section). Then select the Master Fader by pressing its **SEL** key.*

**ALL SAFE** Use the **ALL SAFE** key to disable the **REC** key on all channels. This prevents the record arming of audio and MIDI tracks.

#### TIP

*The All Safe mode here refers to the recorder, and is not to be confused with the All Safe automation mode ("Automation" on page 80). This recorder All Safe mode is ideal for safeguarding a project from accidental erasures and changes.*

**SEL** This **SEL** key selects the Master Fader channel for editing of its individual parameters (such as, EQ, effects, and automation).

**SOLO** The **SOLO** key determines the mode of the channel strips' **MUTE** keys. When depressed, the key lights red to show that the Solo mode is active. This causes the **MUTE** keys to function as solo keys.

## Part IV–Mixer Controls

**<AUTO>** This LED indicator lights solid red to show Write automation ready for the Master Fader. It blinks red when writing automation data for the Master Fader.

### Virtual Channel

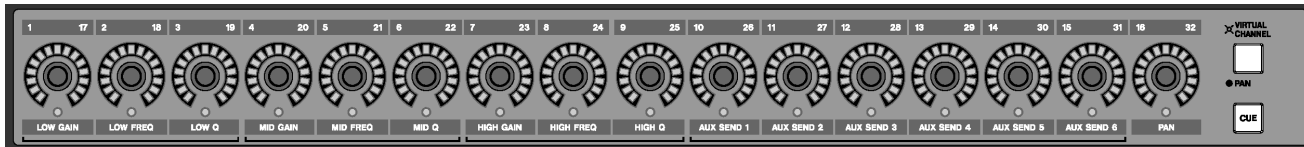

The Virtual Channel is the horizontal row of 16 knobs (called “virtual pots”) above the Channel Strips.

**Virtual Pots** These pots are multi-function, infinitely rotating controls. They serve as the channels’ pan pots, EQ controls, Aux sends, or pan pots for the cue mix. They are surrounded by a ring of LEDs which indicate their current setting. For example, a pan pot that is hard left will have its far left LED illuminated, or an AUX send that is full open will have

all of its LEDs lit. The virtual pots’ functions are determined by the **VIRTUAL CHANNEL/PAN** and **CUE** key settings.

**VIRTUAL CHANNEL/PAN** The **VIRTUAL CHANNEL/PAN** key determines whether the virtual pots will function as EQ, Aux Sends, and a pan pot for the selected Channel Strip (the channel whose **SEL** key is active), or as individual pan pots for each of the 16 Channel Strips.

#### VIRTUAL CHANNEL ON (the key is lit)

1/17	2/18	3/19	4/20	5/21	6/22	7/23	8/24	9/25	10/26	11/27	12/28	13/29	14/30	15/31	16/32
Low Gain	Low Freq	Low Q	Mid Gain	Mid Freq	Mid Q	High Gain	High Freq	High Q	Aux Send 1	Aux Send 2	Aux Send 3	Aux Send 4	Aux Send 5	Aux Send 6	Pan

#### PAN ON (the key is unlit)

1/17	2/18	3/19	4/20	5/21	6/22	7/23	8/24	9/25	10/26	11/27	12/28	13/29	14/30	15/31	16/32
Pan	Pan	Pan	Pan	Pan	Pan	Pan	Pan	Pan	Pan	Pan	Pan	Pan	Pan	Pan	Pan

**CUE** The **CUE** key enables each Channel Strip to control its respective channel’s cue mix. When **CUE** is illuminated, the faders control the channels’ cue

send levels, and each channel’s associated virtual pot controls the cue mix pannings.

Screen Control (VGA Channel Display)

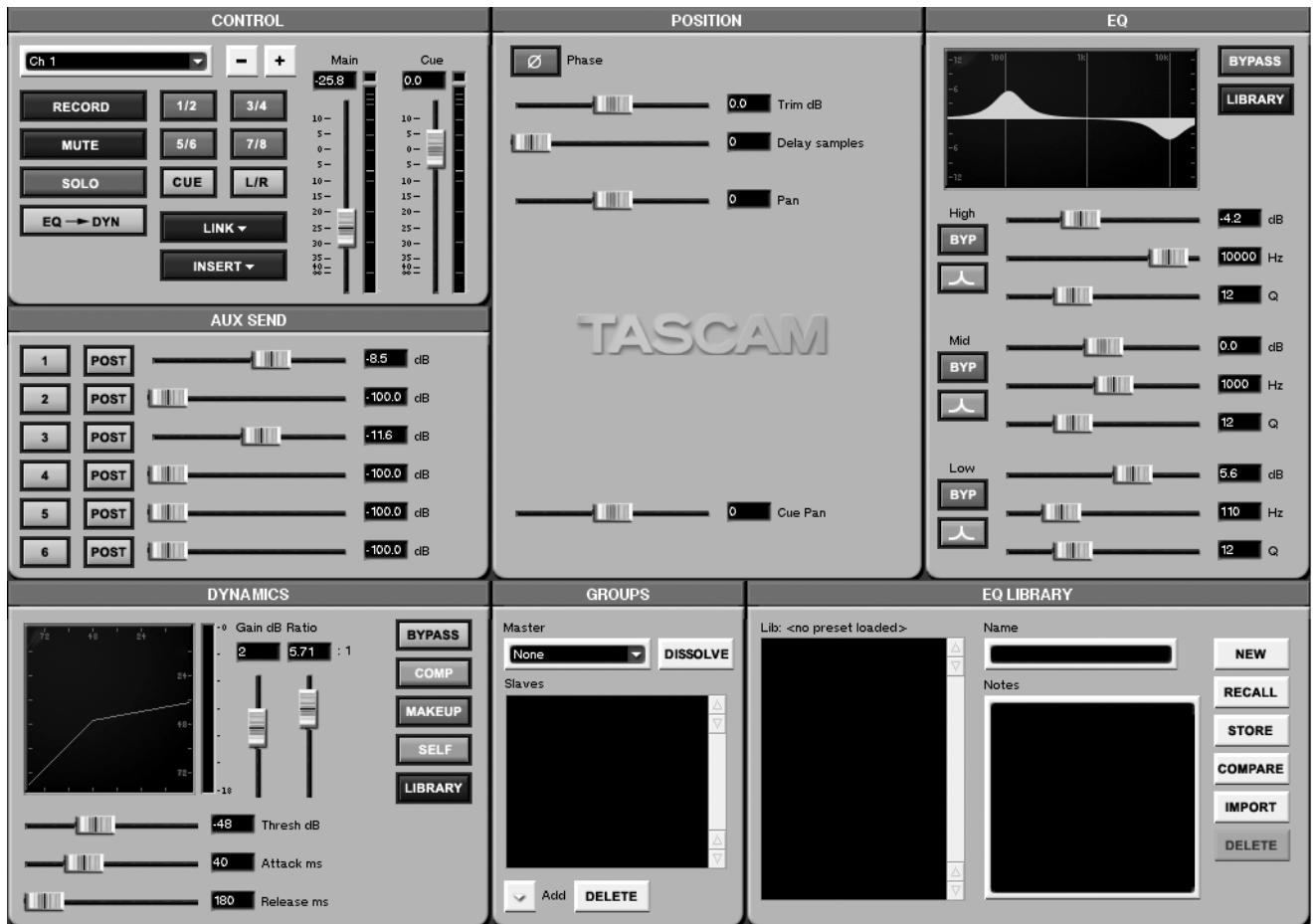

Press the **CHANNEL** key in the **MAIN DISPLAY MODE** section to recall the Channel screen. The mixer channel displayed is determined by the Channel Strip’s **SEL** key. The Channel display provides onscreen access and control of all the selected channel’s features in a single display.

**CONTROL** The CONTROL module contains the selected channel’s basic level, routing, bussing, and monitoring controls. It is also possible to select a channel for display directly from within this module.

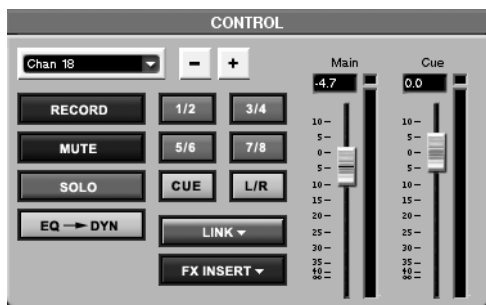

**Channel Select** Click on the  next to the channel name (top left corner) to access a pop-up window of all the mixer’s channels, groups, returns, and sends.

Select the channel you want to see and the entire Channel screen will update to show that selection.

**+/- keys** Click on the +/- keys to step through the mixer’s channels, groups, returns, and sends one at a time.

**TIP**

*The Channel Select field and +/- keys have the same effect as actually pressing the SEL key on a Channel Strip.*

**RECORD** The RECORD enable key is identical to the REC enable key on a Channel Strip.

**MUTE** The MUTE key is identical to the MUTE key on a Channel Strip.

**SOLO** The SOLO key solos the selected channel. It works the same way as a Channel Strip’s MUTE key does in solo mode.

**EQ → DYN** Press this key to toggle the order of the selected channel’s EQ and dynamics setup. The choices are EQ pre- or post- the dynamics processing.

**1/2, 3/4, 5/6, 7/8** These keys assign the selected channel to the 8 busses.

## Part IV—Mixer Controls

**CUE** Press this key to assign the selected channel to the Cue buss.

**L/R** Press this key to send the selected channel to the master stereo buss out.

**LINK** The LINK key allows the selected channel to be ganged with an adjacent channel (the next even channel if the selected channel is odd, and the previous odd channel if the selected channel is even) for stereo operation. Right-click on the key and select which functions are linked (aux send, dynamics, EQ, faders, trim/delay, stereo pan, and cue pan).

**FX INSERT** Use this key to enable or disable one of the SX-1's eight inserts. Right-click on the key's arrow to select or configure an insert source.

**Main** This onscreen fader mirrors the selected channel's physical fader.

**Cue** This onscreen fader mirrors the selected channel's physical fader for its cue level.

### TIP

Exact numerical values can be entered directly into the text field above the Main and Cue faders. Click once in the field to highlight the text, then enter a value using the PS/2 keyboard's number keys and press "enter" to set the value.

**POSITION** The POSITION module determines the channel's position in the stereo (or surround) field.

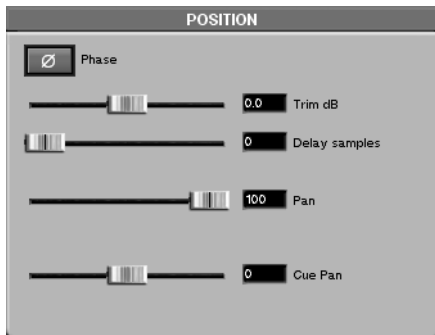

**Phase** This button reverses the selected channel's phase by 180°.

**Trim dB** Use this fader to trim the selected channel's audio  $\pm 20$ dB.

**Delay Samples** Use this fader to delay the selected channel's audio by a set number of samples (up to 8191 samples).

**Pan** This fader mirrors the selected channel's physical pan pot.

**Cue Pan** This fader mirrors the selected channel's Cue mix pan pot.

**GROUPS** The GROUPS module gives you direct access to the selected channel's associated fader groups.



**Master** This window displays the master fader associated with the selected channel.

**Add** Press the  key (under either the Master or the Slaves windows) to add a fader to its associated group.

**DISSOLVE** Dissolves the group when the Master channel is selected.

**Slaves** This window displays the slave faders associated with the selected channel and its Master fader.

**AUX SEND** The AUX SEND module houses controls for all six of the channel's aux sends.

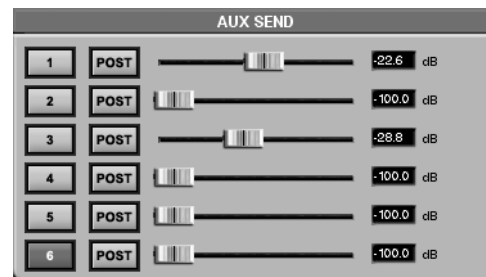

**Keys 1 to 6** These keys enable or disable, the selected channel's aux sends.

**PRE/POST** The PRE/POST keys select whether their associated aux sends will operate before (pre) or after (post) the selected mixer channel's fader level.

**Faders** These faders mirror the Virtual Channel's Aux Send pots and the Mixer screen's Aux faders.

**EQ** The EQ module houses the selected Channel Strip's controls for all three bands of equalization. The faders mirror the Virtual Channel's EQ pots.

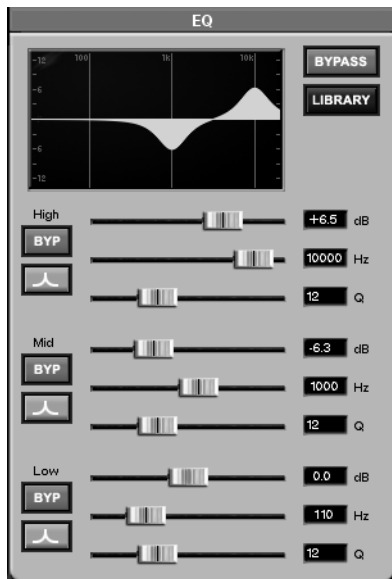

**BYPASS** Press this key to turn the EQ module on and off for the selected channel.

**LIBRARY** Use this key to display the EQ Library. For example, if the LIBRARY window currently shows the Dynamics Library, pressing this key will override that display and recall the EQ Library instead.

**HIGH, MID, & LOW dB** These faders provide gain ( $\pm 15$  dB) control for their respective EQ bands.

**HIGH, MID, & LOW Hz** These faders control the center frequency of the EQ bell (20Hz to 20kHz).

**HIGH, MID, & LOW Q** These faders control the width of the EQ bell curve (these values are expressed in semitones here, although the LCD CHANNEL screen also provides the traditional Q value). They are only active with the Parametric and Notch EQ curves.

**BYP** These keys bypass their associated EQ band (not the entire EQ module).

**Curve Key** For each EQ band, you have a choice of Parametric, Notch, Low Pass, High Pass, Low Shelf, and High Shelf curves. Click on the keys immediately below each BYP key to select from a menu of these curves.

**DYNAMICS** The DYNAMICS module houses the dynamics controls for the selected channel. Several of these controls mirror the LCD MIXER CHANNEL screen for the AUX DYN settings.

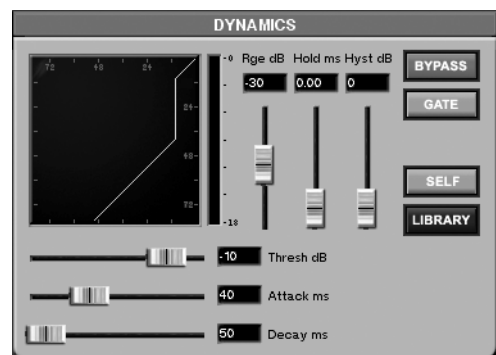
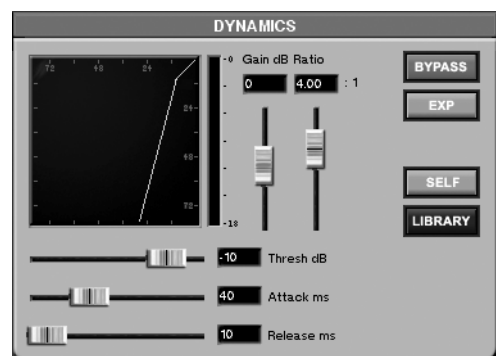
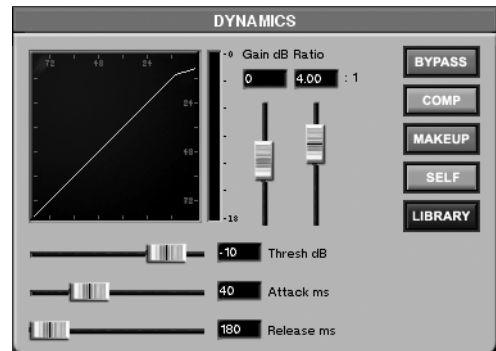

There are three different types of dynamics processors available to each mixer channel (all 40 inputs). These are: Compressor, Expander, and Gate (all of which are pictured here). One of these processors can be used at a time, per channel. Click on the key where the dynamics processor's name appears (either COMP, EXP, or GATE) to select the processor you want to use.

**Compressor & Expander** The following parameters apply to both the Compressor and the Expander. The only difference is that compression limits levels above the threshold setting while expansion lowers levels below the threshold setting.

**Gain dB** Use this fader to adjust the selected channel's gain ( $\pm 20$  dB) post dynamics processing.

**Ratio** This fader adjusts the compression ratio (from 1:1 to infinite). For example, with a setting of 4:1, for every 4 dB of input gain above the threshold, 1 dB of gain is output.

**Threshold dB** Use this fader to set the threshold at which the dynamics processing is active.

**Attack ms** This fader sets the attack time (0 to 125 ms) for the dynamics processor. Higher values produce slower attack times, thus allowing more of the transient through.

**Release ms** This fader sets the release time (1 to 5000 ms) for the dynamics processor.

### TIP

To gain control of the DYNAMICS module's faders via the LCD's soft knobs, recall the LCD's MIXER CHANNEL press CHANNEL in the MAIN DISPLAY MODE SECTION. Then press the AUX DYN soft key to reach the AUX DYN control screen.

**BYPASS** Press this key to turn dynamics processing on and off for the selected channel.

**Gate** The following three parameters are unique to the gate algorithm:

**Rge dB** This slider determines the range of the gate, which is the amount of attenuation when the gate closes. The default is  $-30$  dB, but the range is from 0 to  $-60$  dB.

**Hold ms** Determines the duration that the gate will remain open without being re-triggered.

**Hyst dB** Short for Hysteresis, this parameter provides a way of fine-tuning the clamping action of the gate. The higher the value, the less "gate chatter", which often happens with gates as the input signal remains very close to the gate threshold.

**COMP** Use this key to select the type of dynamics processing you want on the selected channel: compressor, expander, or gate. The key's label changes according to the selection. Use your mouse to click on the key and bring up the dynamics menu.

**MAKEUP** Use this key to compensate for level lost during compression.

**SELF** This key selects a trigger source for the selected channel's dynamics processor (the audio signal that dictates how the dynamics will behave). The selections are: Self, Side, or Both.

**Self** This setting uses the selected channel's audio to trigger the dynamics processor. It is the default setting.

**Side** This setting uses an adjacent channel's (the channel that would be part of a linked pair—see "Links" on page 69) audio to trigger the dynamics processor. This is commonly referred to as a "side-chain". It is important to note that while the dynamics processor's input is being controlled by the other channel in this case, the selected channel's audio is the one affected by the processing.

**Both** This setting uses the audio from both channels to trigger the dynamics processor. The effect is like having a linked pair strapped to one compressor setting, with the exception that the audio from the channel providing the "Side" input is not affected.

**LIBRARY** Use this key to display the Dynamics Library. For example, If the LIBRARY window currently shows the EQ Library, pressing this key will override that display and recall the Dynamics Library instead.

### LCD Channel Display

This screen's functions parallel the VGA Channel screen. Many of the controls found on this screen are identical to the controls found in the VGA Channel screen's modules as explained on the previous pages. Only those controls that are unique to this LCD screen are explained here.

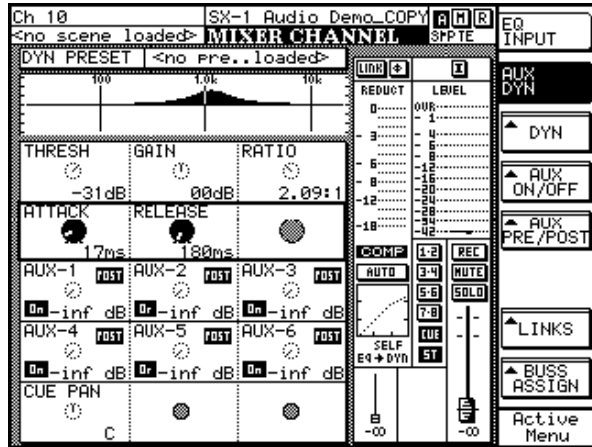

Pressing either the **MIXER/ USER BANKS** keys in the **MAIN DISPLAY MODE** section of the front panel recalls the MIXER CHANNEL screen. Pressing the **CHANNEL** key recalls the dynamics processor screen.

**EQ INPUT** Press this button to recall the controls for the selected channel's EQ, trim, pan, and delay.

**AUX DYN** Press this button to recall the controls for the selected channel's dynamics, aux sends 1 through 6, and cue pan (pictured above).



**DYN** This button opens the selected channel's Dynamics dialog:

**TYPE/COMP** Use this button to select the type of dynamics processing you want on the selected channel: compressor, expander, or gate.

**MAKEUP/AUTO** Use this button to compensate for level lost during compression.

**TRIG SELF** Use this button to select a trigger source for the selected channel's dynamics processor (the audio signal that dictates how the dynamics will behave). The selections are: Self, Side, or Both.



**Aux ON/OFF** This button opens the selected channel's Aux On/Off dialog:

**AUX1/On to AUX6/On** These buttons turn their respective aux sends, for the selected channel, on and off.



**AUX Pre/Post** This button opens the selected channel's Aux Pre/Post dialog:

**AUX1/Pre to AUX6/Pre** These buttons toggle the aux sends for the selected channel pre- or post-fader.

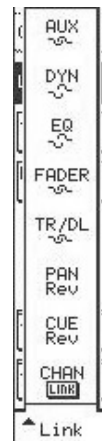

**Links** This key opens the selected channel's Link dialog, where you can choose which of the channel's parts are ganged together when a pair of channels is linked:

**AUX** Turns the Aux Sends link feature on and off.

**DYN** Turns the Dynamics link feature on and off.

**EQ** Turns the EQ link feature on and off.

**FADER** Turns the Fader link feature on and off.

**TR/DL** Turns the Trim/Delay link feature on and off.

**PAN** Turns the Stereo Pan link feature on and off.

**CUE/Rev** Turns the Cue Pan link feature on and off and lets you select how the link pan controls will operate. There are three settings: Mono (the pan controls operate independently), Position/Width (one pan knob controls the channels' pan position while the other pan knob controls the width of the channels' stereo pan field), or Reverse (the pans are reversed relative to each other).

**CHAN/LINK** Turns the channel linking feature on and off. That is, it makes or breaks the link to the adjacent channel.

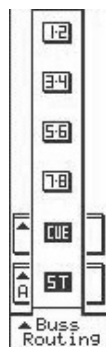

**Buss Routing** This button opens the selected channel's Buss Routing dialog:

**1-2 to 7-8** Use these buttons to send signals from the selected channel to busses 1-8.

**CUE** Use this button to send signal from the selected channel to the Cue buss.

**ST** Use this button to send signal from the selected channel to the Master stereo buss.

**INPUT button** This menu houses the controls for phase polarity and EQ/dynamics order.

**INSERT button** This menu houses the controls for switching the insert on and off, insert number and point selection.

**TRIM/CH DELAY Screen** Trim and channel delay controls are available from the LCD. The trim controls are different from the pre-mixer channel input trim controls found on the top of the SX-1. These trim controls allow you to adjust the level of mixer channels from -20 to +20 dB before it reaches

the fader. The delay function lets you delay individual channels from 0 to 8191 samples. On the VGA, the trim and delay controls are found on the POSITION module of the Channel screen.

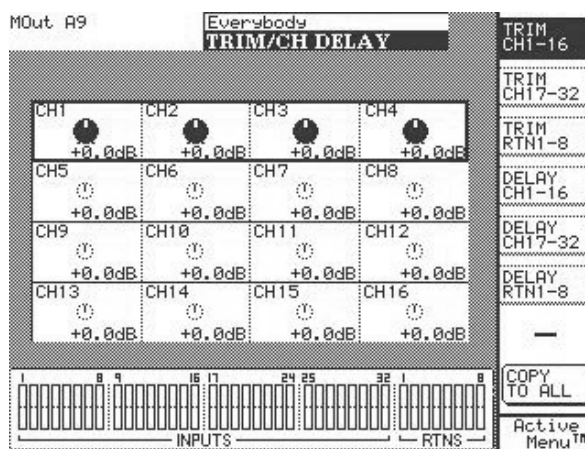

To reach this screen, press the **DELAY/ TRIM** key in the **LCD ACCESS** section. To reach a channel, press the soft key next to the Trim or Delay group that the channel belongs to. To select a channel for editing, use the keypad's up/down arrow keys.

**COPY TO ALL** Use this key to copy the delay and trim settings of the currently selected channel to all of the mixer's channels.



## EQ, Dynamics and Scene Libraries - The Library Feature

A Library feature is available for saving your custom EQ and Dynamics setups (the Library also works for saving routing configurations, among other things—Library information is covered after each relevant section). Dedicated LCD and VGA screens are avail-

able for accessing this feature. You can press the LIBRARY buttons in the VGA CHANNEL display or the hardware keys in the LIBRARY section to reach the LCD screens.

### VGA Displays

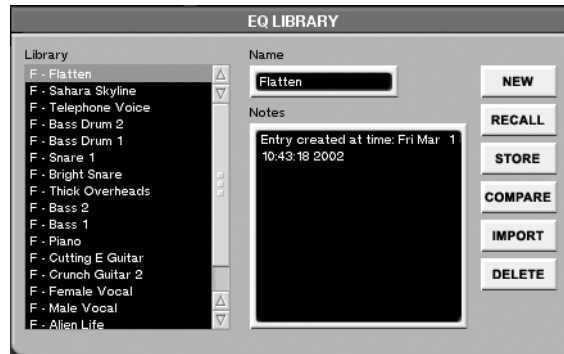

This window is part of the Channel screen. Here you can create, edit and store EQ and Dynamics channel settings.

**Library** The Library window lists the EQ or Dynamics currently available library settings.

**Name** The name of the currently selected library entry appears in this text field. Click once in the text field to highlight and change it. Type in a new name and press [ENTER] from the PS/2 keyboard.

**Notes** Each library setting can have important commentaries saved along with the preset. These notes can be edited at any time from the PS/2 keyboard.

**IMPORT** This key lets you import a library setting from another project. Press IMPORT and browse through the available projects listed in the Import Project window. Select the library file you want to import and press OK (or CANCEL to escape the action).

**TIP**

*If you press IMPORT and don't see any project files in the Import Project window, be sure the proper hard drive (the drive where your project files are stored) is selected in the Import Volume menu.*

### LCD Displays

There are several Library screens to address the many functions that can have their discrete parameters stored and recalled. The Dynamics (shown below) and EQ Library screens are shown in the VGA's Channel screen and can be recalled on the LCD via the EQ and DYN keys in the LIBRARY section (on the front panel).

**DYNAMICS LIBRARY** From the LIBRARY section, press the DYN key to recall the DYNAMICS LIBRARY

LCD screen. This screen's function parallels the Channel screen's Dynamics Library module on the VGA.

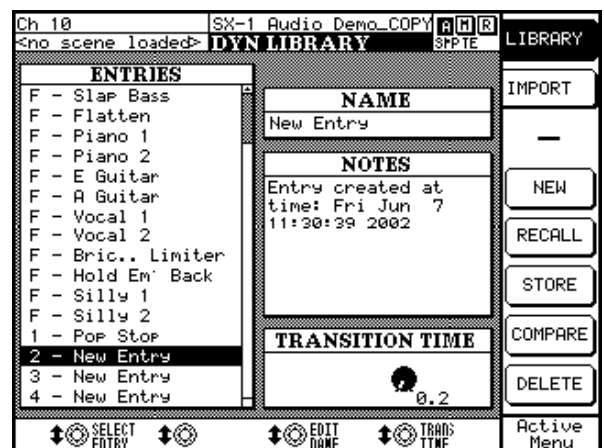

## Part IV—Mixer Controls

**IMPORT** Opens the IMPORT screen. From here you can import the settings of the dynamics (or EQ, if you are on that screen) from another project, to your current project.

**COMPARE** Compares the channel's current EQ or dynamics state to the last loaded (or saved) version.

**TRANS TIME** The amount of time it takes for parameters to move from their current state to the settings of a library preset that has just been recalled.

---

### Scene library

---

In addition to being able to save multiple mixes with a project, you can also save Scenes, or “snapshots,” of the mixer's current state. A Scene includes all of a

channel's controllers, buss assignments, and effect plug-in settings.

---

### VGA Scene Tab

From the AUTOMATION screen, click on the Scene tab. Here, you can name, save, and recall scenes.



**Library** In this window, you can see the scenes that are associated with your current project. Highlight a scene and press RECALL to load the scene, or DELETE to remove the scene from the list. Type directly into the name field to rename the scene library entry.

**NEW** Press this key to save the mixer's current state as a scene. Use the Name field to edit the scene's name.

**IMPORT** This key lets you import a scene setting from another project. Press IMPORT and browse through the available projects listed in the Import Project window. Select the scene file you want to import and press OK (or CANCEL to escape the action).

**COMPARE** Compares the mixer's current scene to the last loaded (or saved) scene.

## LCD SCENE LIBRARY Screen

The SCENE LIBRARY screen mirrors the Scene tab of the AUTOMATION screen. Most of the parameters found on this screen are identical to the parameters found in the SCENE LIBRARY automation tab and are explained on the previous pages. Only those parameters that are unique to this LCD screen are explained here.

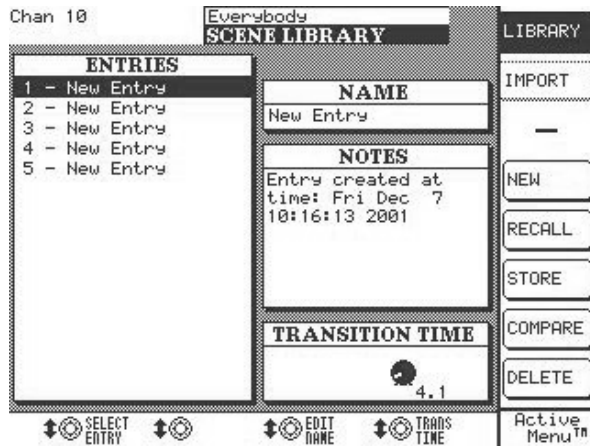

From the **LIBRARY** section, press the **SCENE** key, and then the LIBRARY soft key.

**TRANS TIME** The amount of time it takes to move from the mixer's current scene to a scene that has just been recalled.

**IMPORT** Recalls the screen where you can import scenes from other projects.

Commands include:

**SELECT** Selects the scene you want to import.

**SEL ALL** Selects all the scenes associated with the project highlighted in the PROJECT window.

**SEL NONE** If any scenes are selected, pressing this key de-selects all of them.

**SELECT VOLUME** Select a mounted storage drive from which to view a project's associated scenes.

**SELECT PROJECT** Select a project from which to import scenes.

# Chapter 10 – Library Overview

## Understanding the Library Feature

The SX-1 has five different libraries for saving five different types of settings: routings, scenes, EQ, dynamics, and effects. Each of these categories can

have their unique parameters saved as a preset for later recall.

## Library Section

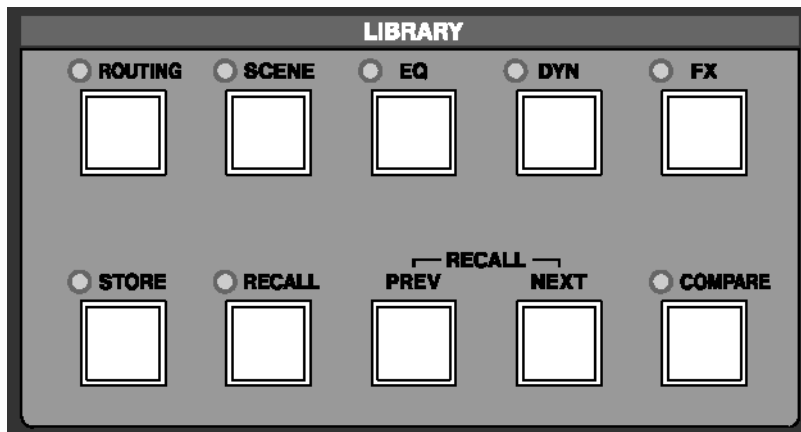

The keys in this section are for saving and recalling Library presets. The top five keys recall an associated LCD screen, and the bottom five keys provide functionality.

### TIP

*Before saving a library preset, you must first press one of the top five keys. This tells the SX-1 what type of library preset you want to save. After pressing **STORE**, a prompt to give the preset a patch number will appear on the LCD screen. Type a number on the kKeypad and press **ENTER**.*

**ROUTING** This key recalls the ROUTING library screen from which you can name, store, and recall the mixer's patch setups.

**SCENE** This key recalls the SCENE library screen from which you can name, store, and recall mixer Scenes.

**EQ** This key recalls the EQ library screen from which you can name, store, and recall the mixer's EQ setups.

**DYN** This key recalls the DYNAMICS library screen from which you can name, store, and recall the mixer's dynamics setups.

**FX** This key recalls the EFFECTS library screen from which you can name, store, and recall effects patches.

**STORE** With the LIBRARY screen open to the type of library you want to save, press **STORE** to save a preset of the mixer's current settings for that feature.

**RECALL** With the LIBRARY screen open to the type of library you want to recall, press **RECALL** to load the selected (highlighted) preset.

**PREV** Press to recall the last preset in the currently open Library screen.

**NEXT** Press to recall the next preset in the currently open Library screen.

**COMPARE** Compares a current set of parameters with the last loaded (or saved) set of like parameters.

## Chapter 11 – Routing & Bussing

### Working With the SX-1’s Routing Pages

The SX-1 has a very extensive routing matrix, with the native ability to send signals a number of different places. As such, it is important to understand how

to route audio using the VGA and LCD Routing windows.

#### The philosophy

Understanding how to route signals on the SX1 can take a moment to understand, because the machine has tremendous capabilities in this area. The potential for confusion lies in the fact that the unit can separate its physical I/O from their default routings.

What this means is that inputs and outputs can be used for various purposes, not only the ones they are labeled with or assigned to by default. For example, although there are four jacks on the top panel labeled **AUX OUTS 1-4**, these jacks can serve other purposes. There is no reason that the jack labeled **AUX OUT 1** could not send out Direct Out 12, or Buss 1 Out, or Mixer Bypass 1 Out, or any number of other sources.

This means that you can use any combination of relevant I/O to solve a number of different tasks, including creating an external insert (which will be discussed in a moment). As well, you could send the same signal to a number of different outputs, or create different monitor mixes, by using the aux outs in combination with the stereo outs, ADAT I/O or the expansion slots.

The possibilities are extensive, and the fact that you can store any routing configuration as a preset means you can manage your I/O effectively.

#### VGA Routing Displays

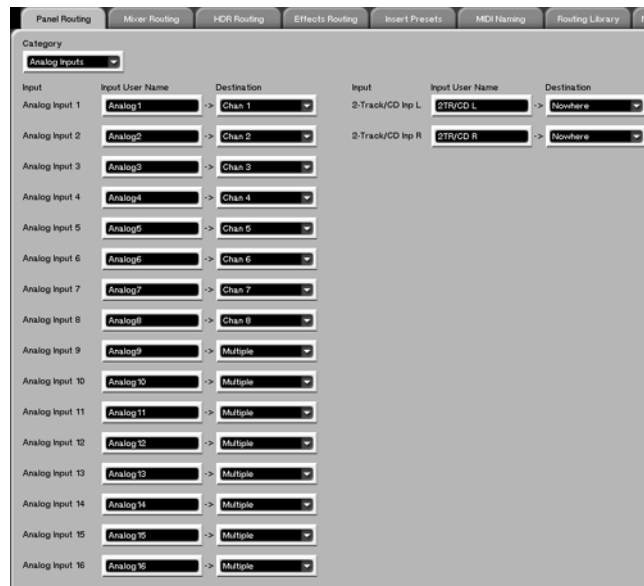

In the **MAIN DISPLAY MODE** area, press the **ROUTING** key to recall the ROUTING VGA screen.

inputs to the mixer’s 32 inputs, 8 returns, or 8 inserts. In this tab, you can also give your analog inputs custom names.

**Panel Routing** To reach this tab, first press the **ROUTING** key in the **MAIN DISPLAY MODES** section. Then click on the Panel Routing tab. This tab contains both the pre- and post-mixer patch bay. From this screen you can route any of the SX-1’s physical



## Part IV—Mixer Controls

**Category** Selects between viewing the routings for: Analog Inputs, Outputs, Digital I/O, and Option Slots 1-3.

**Input User Name** Use this field to type in a custom name for the input. This feature is useful if you leave the same device plugged into an input all the time, or to remind yourself of devices that were connected to the SX-1 when returning to a previous mix.

**Destination** Selects the input's routing destination.

**Mixer Routing** To reach this tab, press the **ROUTING** key in the **MAIN DISPLAY MODES** section. Then click on the Mixer Routing tab. This is the mixer patch bay. Use this tab to route sources to and from the mixer's channels.



**Category** Selects between viewing the routings for: Input Channels, Aux Returns, Direct Outs, Bypass, Loopback, and Busses.

### TIP

*The Bypass and Loopback categories allow you to route 16 channels each without actually using up a mixer channel. Mixer Bypass routes 16 channels from the pre-patchbay to the post-patchbay, and Mixer Loopback routes 16 channels from the post-patchbay back to the pre-patchbay—without using up a channel strip. For example, use Bypass to go from an analog input directly to an analog output. Or, use Loopback to go directly out of a channel and back into a return, without using up a mixer channel strip.*

**Source** Selects the input's feed.

## Before we continue, a word about mixer Bypass and Loopback

Sometimes it is desirable to route signals directly from inputs to outputs, or directly from outputs to inputs. Mixer Bypass and Loopback accomplish these tasks, by providing audio streams outside of the normal mixing console environment.

Mixer Bypass can send up to 16 channels directly from an input to an output, without using up a mixer channel – hence the name “Bypass”. Mixer Loopback can send up to 16 channels directly from an output to an input (thus loopback), again eliminating the need for a channel to do this. This might come in handy if you were using all of the available channels for inputs, but still needed to plug in a microphone and send the signal to an external recorder. In that case, you could use Bypass to route the signal directly from the input to a specified output connected to your external recorder.

**HDR Routing** To reach this tab, press the **ROUTING** key in the **MAIN DISPLAY MODES** section. Then click on the HDR Routing tab. This is where the SX-1's Hard Disk Recorder tracks are patched and routed (along with the actual slots on the Track

screen). HDR Inputs and outputs are handled from this tab.



**Take Name** Displays the name of the HDR tracks' currently loaded Take.

**Effects Routing** To reach this tab, press the **ROUTING** key in the **MAIN DISPLAY MODES** section. Then click on the Effects Routing tab. This tab (as well as the VGA Effects screen) is where you route the SX-1's internal effects.



**Plugin Name** Displays the name of the effect plug-in that is selected for that quadrant on the Effects screen.

### TIP

*You must first assign an effect to one of the four effect quadrants on the “Effects” screen before a plug-in will appear on this tab.*

**Insert Presets** To reach this tab, press the **ROUTING** key in the **MAIN DISPLAY MODES** section. Then click on the Insert Presets tab. From this tab, you configure the routing for the mixer’s effect inserts. You can have up to eight possible insert effect presets spread across any of the mixer’s 32 full featured channels, as well as the 8 mix busses and Master L/R buss.



**Insert Send** This field determines where the insert send goes. Notice that external ports are available, making external inserts possible.

**User Name** Use this field to name your insert preset.

**Insert Receive** This field determines where the insert’s return is coming from (see “Routing Effects Screens” on page 107 for instructions on routing effects).

## LCD Routing Displays

On the LCD, there is a set of Routing screens that parallel the VGA Routing tabs. Press the **ROUTING** key in the MAIN DISPLAY MODE section to reach these screens. These routing screen choices are listed here.

- ANALOG IN
- ANALOG OUT
- DIGITAL IN
- DIGITAL OUT
- OPTION CARD IN 1
- OPTION CARD IN 2
- OPTION CARD IN 3
- OPTION CARD OUT 1
- OPTION CARD OUT 2

- OPTION CARD OUT 3
- MIXER IN
- DIRECT OUT
- BYPASS
- LOOP BACK
- BUSSES
- HDR
- EFFECTS
- INSERT

**TIP**

*To learn the functions of the individual routing screens, see the definitions for the VGA equivalent tabs. These are covered on the preceding pages.*

## Inserts – how they work and how to route them

The SX1 has eight inserts that can be used across the entire mixing console. Each of the 32 inputs has an insert point, as well as the 8 return channels and the master L/R buss. Unlike a great many other digital consoles, the inserts can be external as well as internal, meaning you can physically strap that pair of 1176’s or BA6A’s across the stereo buss if you want.

The eight inserts are completely separate from one another, meaning that Insert 1 can be an internal

effect processor, while Insert 2 could be an external EQ.

Essentially, you can configure eight separate inserts, and choose where they are applied on the Mixer and Channel pages. You can remember how this works by imagining eight mono effects units that you have configured. This adds powerful functionality to the SX1’s routing abilities.

### VGA

If you navigate to the Insert Preset tab on the VGA ROUTING screen, you'll see this:



The three fields for each insert show Insert Send, Insert Name, and Insert Receive. The Insert Send field determines where the Insert gets its input from, as the Insert Receive determines where it sends its output. These fields DO NOT determine which channel the insert is applied to (that happens on the Mixer or Channel pages), they only set the I/O for the Insert itself.

Here are two examples that will help to explain the behavior of the Inserts:

**External Effects Insert** With an external compressor handy, plug a cable from the Aux 1 output on the top of the SX1 to the input of your compressor, and plug the output of the compressor to Input 1 on the SX1's top panel. In the Insert Send field, select Analog Aux Out 1, and in the Insert Receive field select Analog Input 1. If this Insert were inserted on Mixer Channel 1, the result would be the following: signal from channel 1 would be sent out the Insert (via the

Aux 1 jack) to the input of the compressor. Output from the compressor would be returned to Analog Input 1, and thus back to Mixer channel 1 via the Insert Receive.

**Internal Effects Insert** With the TASCAM Delay plug-in loaded into Quadrant 1, choose Effects Input 1-1 as the Insert Send. Choose Effects Output 1-1 as the Insert Receive. The Insert Send field will now display TASCAM Delay Left, and the Insert Receive field will display TASCAM Delay Left as well. This means that if Insert 1 was inserted on Mixer channel 1, the following would happen: signal from Channel 1 would be sent out to the TASCAM Delay input. Signal would pass through the delay and be sent to the output of the Delay, and then it would be returned to Mixer Channel 1 via Insert 1's return.



## Actually routing the insert to a mixer channel

Once you have created an insert on the insert routing page, you'll want to actually insert it on a mixer channel to hear it. While you can do this in a few different places on the VGA, the manner of selection is the same for all of them.

Go back to the Mixer page (**MIXER** key in the **MAIN DISPLAY MODES** section of the surface, or press Alt+2 on the PS/2 keyboard), and look at the top of a channel strip for the Insert button:



The same button can be viewed on the VGA Channel screen, as seen to the right.

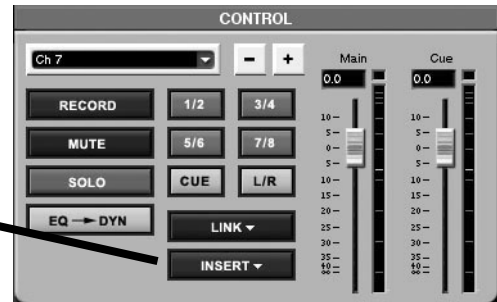

Right-clicking on the Insert button will bring up this dialog:

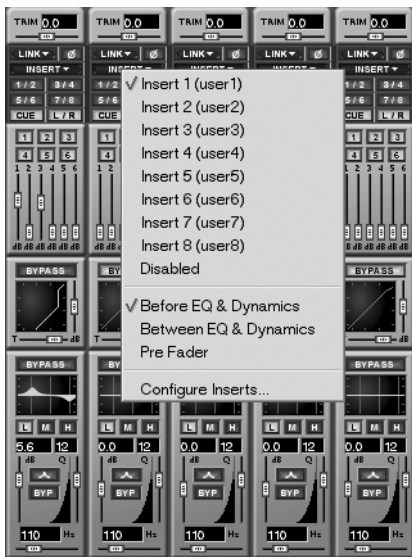

Here, you can select which insert the channel in question actually uses – as well as determining whether the insert is pre- or post-EQ. Each channel can access one insert at a time, and the last selection will send the view back to the Routing screen's Insert Presets tab.

To use the insert, click the insert button normally (with the left mouse button). The button will light red to indicate that the insert is active.

## LCD

The implementation on the LCD screen is nearly identical to the VGA, only soft knobs are used for the pull-down menus instead of the mouse.

The screen looks like this:

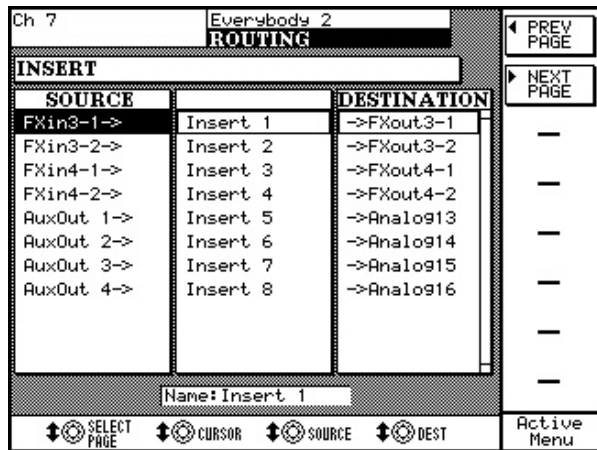

The Source field is the same as the VGA's Insert Send field, as the Destination pull-down is the same as the VGA's Insert Receive display. The Node list is simply the default name of the Insert, as it is not possible to name inserts from the LCD screen (although the LCD will display the name of the insert directly below the Node field).

To determine the Insert's Source or "send", use the SOURCE knob on the bottom of the LCD screen. To determine the Insert's Destination or "receive", use the DEST (destination) knob at the bottom of the screen. Otherwise, the functionality of the inserts is the same as the VGA.

## Actually routing the insert to a mixer channel

After you have configured your insert, and you wish to enable it on a mixer channel, hit the **CHANNEL** key (in the **MAIN DISPLAY MODES** section) and then select the channel on which you would like to use the insert.

Once you've selected the LCD Channel screen and pressed the Insert soft key, you should see this screen:

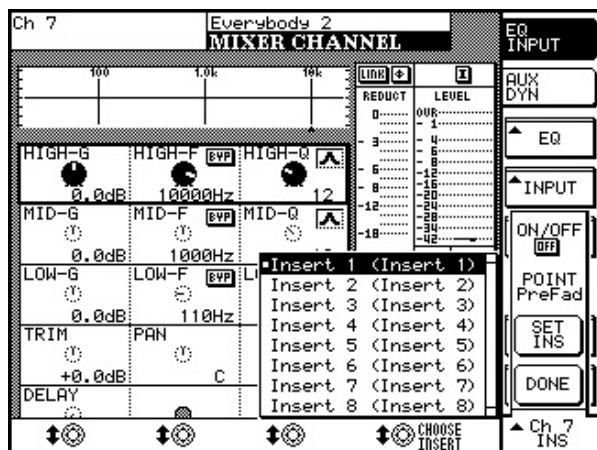

The knob at the bottom right of the screen labeled CHOOSE INSERT scrolls through the list of eight inserts, while the SET INS button selects the insert when it is chosen. The ON/OFF soft button to the right actually enables or disables the insert selected, and the POINT button selects where in the signal chain the insert occurs.

### ANALOG IN

The ANALOG IN screen is an example of how all the ROUTING screens appear. The controls found in these screens directly parallel the controls of the VGA Routing tabs.

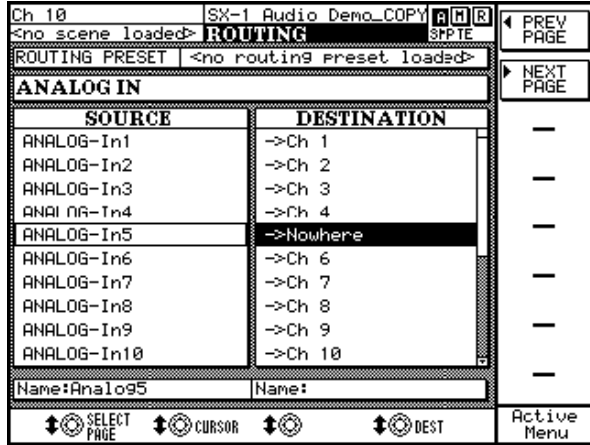

**PREV PAGE** Moves backward through the routing screens.

**NEXT PAGE** Moves forward through the routing screens.

### Bussing

The mixer has a total of eight busses, not including the Cue, monitor (Studio and Control Room outs), and Master L/R busses.

### VGA Controls

A channel can be assigned to the busses via the VGA’s Channel screen, in the CONTROL module, and directly on a channel in the Mixer screen.

**Buss Assign Keys** These are the buss assign keys from the CONTROL module of the Channel screen. They

look very similar to the assign keys on the mixer channels in the Mixer screen.



## Part IV—Mixer Controls

**Buss Masters** Master levels for the busses are reached through the Fader Banks. To see the busses on the VGA, make sure the Mixer screen is selected (press **MIXER** in the **MAIN DISPLAY MODE**). From the **FADER BANK** section, press **BANK MODE** so that the **<PRESET>** LED is on. Then press **BUSS/AUX** to reach this screen.

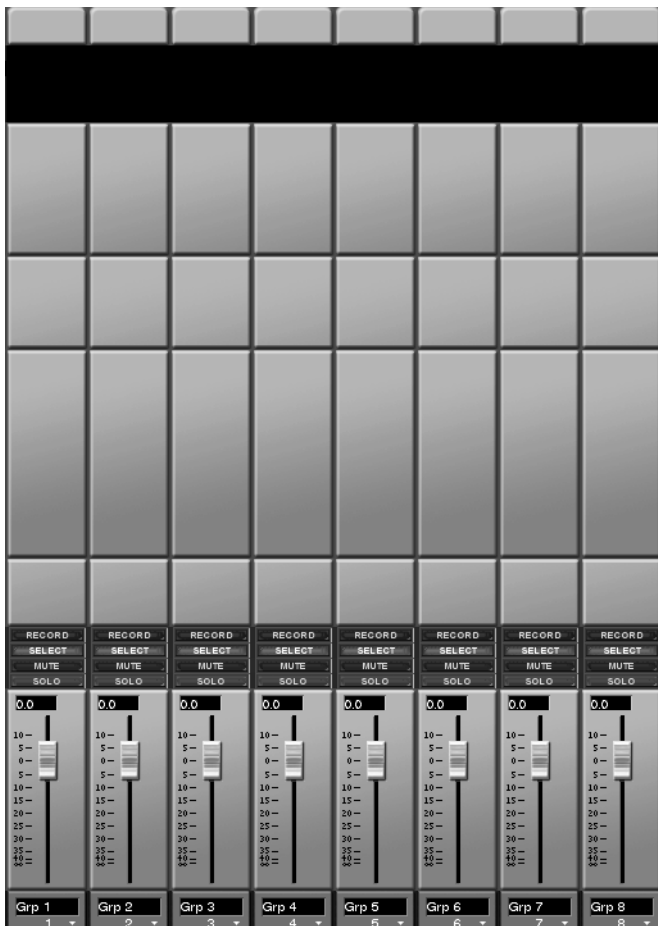

### TIP

Keep in mind that it's not necessary to have a Fader screen up just to move a buss level. If the buss fader bank has been recalled to the surface, you can just move the faders directly on the mixer while leaving a different screen on the display.

## LCD Buss: Controls

From this screen you can assign the mixer channels and effects returns to any of the eight stereo busses, along with the Cue and L/R busses.

To reach the BUSS ASSIGN screens on the LCD, press the **BUSS ASSIGN** key in the **LCD ACCESS** section.

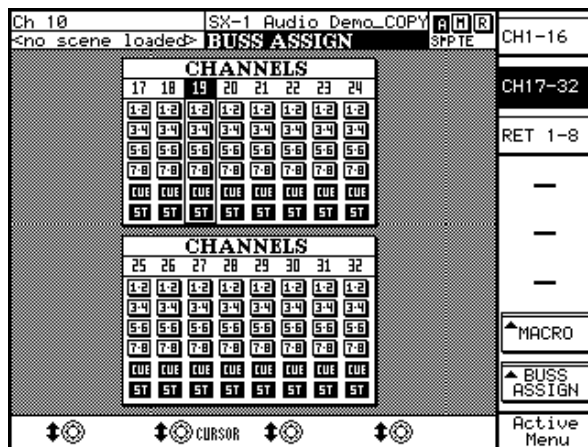

**CH 1-16 and CH 17-32** The bussing pages are set up in two groups of 16 channels each. These keys select the channels you want to view.



**MACRO** These “macro” commands allow busses on all the channels to be turned on or off at the press of a single soft key.

**1-8/ALL OFF** Turns any of the eight stereo busses that are on, off (does not include the Cue buss).

**ST/ALL OFF** Unassigns all of the mixer channels from going to the stereo Master L/R buss.

**ST/ALL ON** Assigns all of the mixer channels to the Master L/R buss.

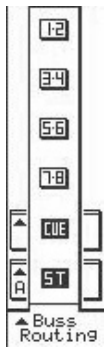

**Buss Assign** Press the Buss Assign soft key to open the buss select menu for the selected mixer channel. (Select the mixer channel by pressing **SEL** on the channel in question, or by using the Left/Right arrow keys of the Keypad).

**1-2 to 7-8** These keys assign the selected mixer channel to their respective busses.

**CUE** This key assigns the selected mixer channel to the Cue output.

**ST** This key assigns the selected mixer channel to the Master L/R output.

**RET 1-8** This screen shows the return assignments, as well as the assignment of the busses to the stereo buss.

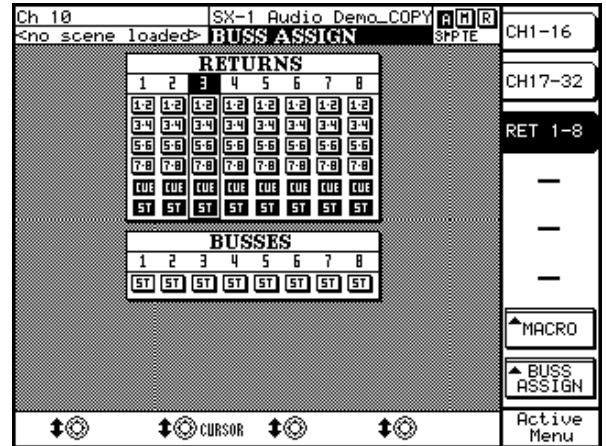

## Aux Sends & Returns

The mixer features six Aux Sends and eight Returns. The Aux Send controls are available from the surface, the VGA, and the LCD screens. Aux sends can be routed internally, or externally to the four Aux Send jacks on the top panel (and, for that matter, any

other external jack using the SX-1’s flexible routing). The Returns can accept input from nearly any source, internal or external. Routing for the Returns is configured in the Mixer Routing tab of the VGA Routing screen.

## VGA Aux Send Controls



Aux send levels can be controlled from the VGA Channel screen in the AUX SEND module and from the LCD MIXER CHANNEL page. Identical controls (pictured left) are also found on the channels in the Mixer screen. All 6 Aux Sends are also part of the Virtual Channel Strip for each channel.

## Part IV—Mixer Controls

### Aux Send Masters

Master levels for the Aux Sends are reached through the Fader Banks. To see them on the VGA, make sure the Mixer screen is selected (press **MIX** in the **MAIN DISPLAY MODE**). From the **FADER BANK** section, press **BANK MODE** so that the **<PRESET>** LED is on.

Then press **BUSS/ AUX** to reach this screen.

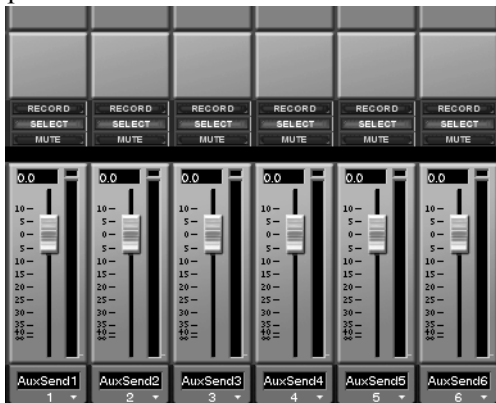

### TIP

*Keep in mind that it's not necessary to have a Fader screen up just to move an Aux send level. If the Aux send fader bank has been recalled to the surface, you can just move the faders directly on the mixer while leaving a different screen on the display.*

### LCD Aux Send Controls

Aux Send controls on the LCD are available directly on the MIXER CHANNEL screen.

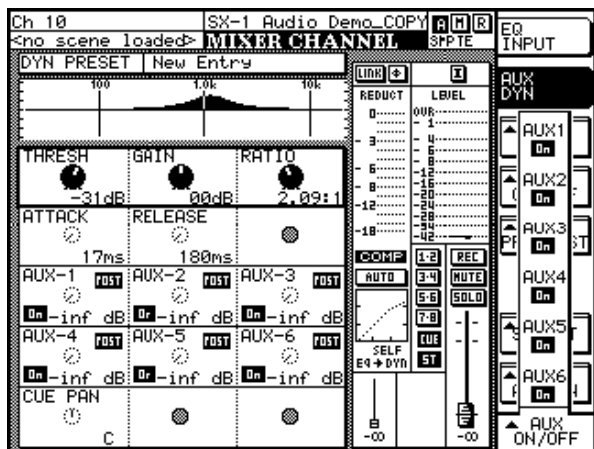

Press either **MIXER** or **CHANNEL** in the **MAIN DISPLAY MODE** section. Use the keypad's arrow keys to scroll to the Aux Send field you want to adjust. Then use the soft knobs to adjust the Aux Sends.

## VGA Aux Return Masters

Master levels for the Aux Returns are reached through the Fader Banks. To see the return levels on the VGA, make sure the Mixer screen is selected (press **MIX** in the **MAIN DISPLAY MODE**). From the **FADER BANK** section, press **BANK MODE** so that the **<PRESET>** LED is on. Then press **RTN/ GRP** to reach this screen.

### TIP

*Keep in mind that it's not necessary to have a Fader screen up just to move an aux return level. If the Aux return fader bank has been recalled to the surface, you can just move the faders directly on the mixer while leaving a different screen on the display.*



## Routing Library Displays

A Library feature is available for saving your custom routing configurations (such that making a library routing entry saves all configurable routing parameters).

Dedicated LCD and VGA screens are available for accessing these features.

### VGA Routing Library Display

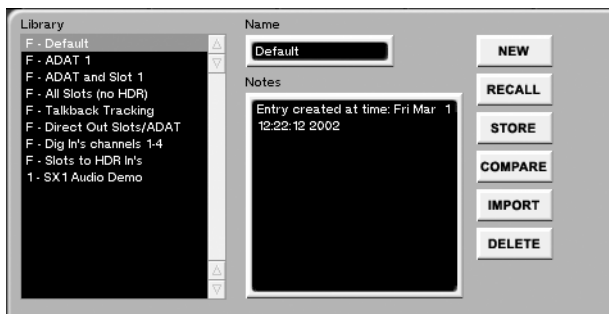

From the VGA ROUTING screen, click on the Routing Library tab. Here you can create, edit and import routing settings.

**Library** The **Library** window lists the currently available library routing entries.

**Name** The name of the currently selected library entry appears in this text field. Click once in the text field to highlight the selected library preset's name. Type in a new name and press [ENTER] on the PS/2 keyboard.

**Notes** Each library setting can have important commentaries saved right along with the preset. These notes can be edited at any time from the PS/2 keyboard.

**IMPORT** This key lets you import a library entry from another project. Press IMPORT and browse through the available projects listed in the Import Project window. Select the library file you want to import and press OK (or CANCEL to escape the action).

**COMPARE** Compares the SX-1's current routing state to the last loaded (or saved) routing library preset.

### LCD Routing Library Display

From the **LIBRARY** section, press the **ROUTING** key to recall the ROUTING LIBRARY LCD screen. This screen parallels the Routing Library tab in the ROUTING screen of the VGA. Use the controls on this screen to store, recall, and name custom routing presets.

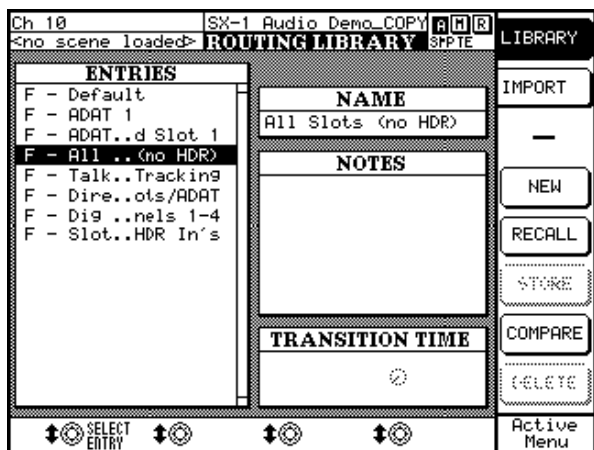

**IMPORT** Press this key to open the screen through which you can import routing presets from other projects into your current project.

**SELECT ENTRY** Scrolls through the presets listed in the ENTRIES window.

**EDIT NAME** Allows you to change the name of the currently selected (highlighted) routing preset.



## Chapter 12 – Fader Links, Groups, & Banks

### Links

It's possible to link any (including aux, effect sends, busses, and MIDI channel faders) odd-numbered mixer channel with its adjacent, even-numbered channel to form a stereo pair. This feature can be accessed from the VGA (whenever you see a LINK

key), the LCD (from the GROUPS/LINKS screen), or simply by pressing the **SEL** keys for two adjacent channels simultaneously (this move lets you quickly link and unlink channels).

### VGA Fader Links

The Link feature can be accessed from the CONTROL module in the CHANNEL screen. It is also available directly on the channels shown in the MIXER screens.



**LINK** This is an example of the LINK key in the CONTROL module. It is similar in appearance to the LINK keys found on the mixer channels in the MIXER screens.

Press the LINK key to gang the selected channel with an adjacent channel (the next even channel if the selected channel is odd, and the previous odd channel

if the selected channel is even). The LINK key glows blue when active.

#### TIP

*Right-click on the LINK arrow to view the channel elements you would like to link: aux send, dynamics, EQ, faders, trim/delay, stereo pan, and cue pan. This technique also works for the channels in the Mixer screens.*

*When two channels are linked in this way, the settings of the channel whose LINK key is clicked are transferred to the other linked channel.*

### LCD Fader Links

From the **LCD ACCESS** section, press the **GROUPS/LINKS** key to reach the GROUPS/LINKS screen. Then press the LINKS soft key to reach the LINKS page.

**LINKS** From this screen you can turn links on and off, and control which parameters (such as EQ, aux sends, and pan) of each channel are actually linked.

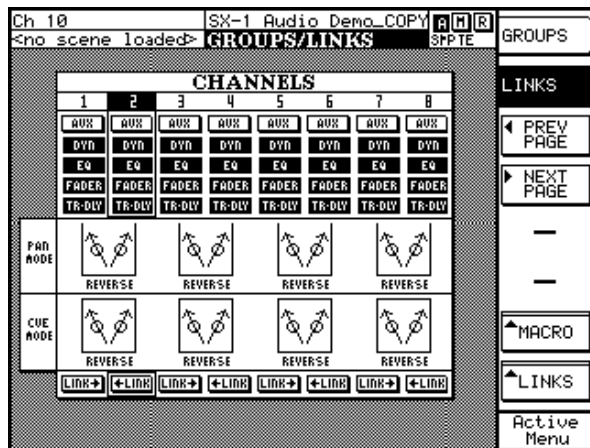

# Part IV—Mixer Controls

**PREV PAGE and NEXT PAGE** These keys scroll through the LINKS pages (pictured below).

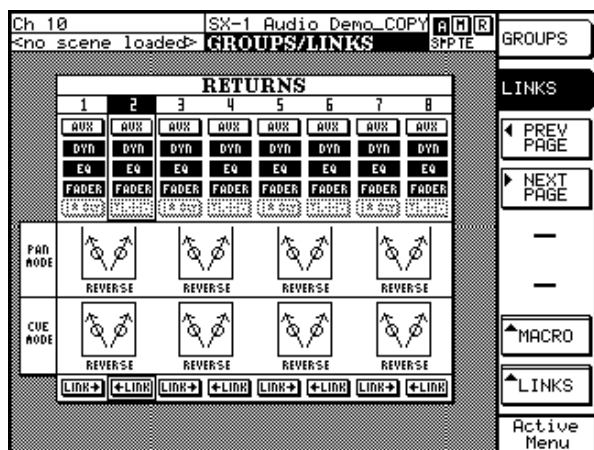

FX RETURN Links Screen

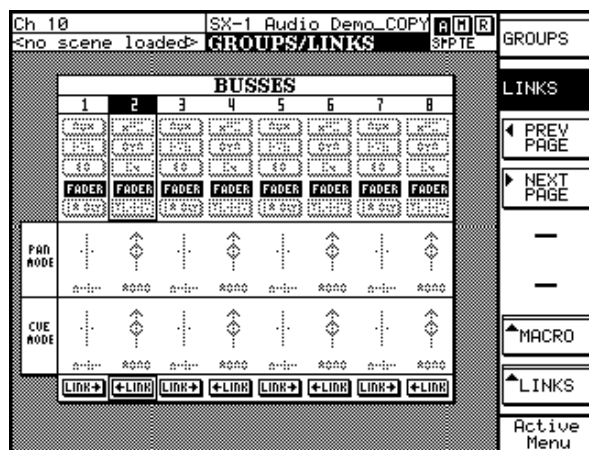

BUSS Links Screen

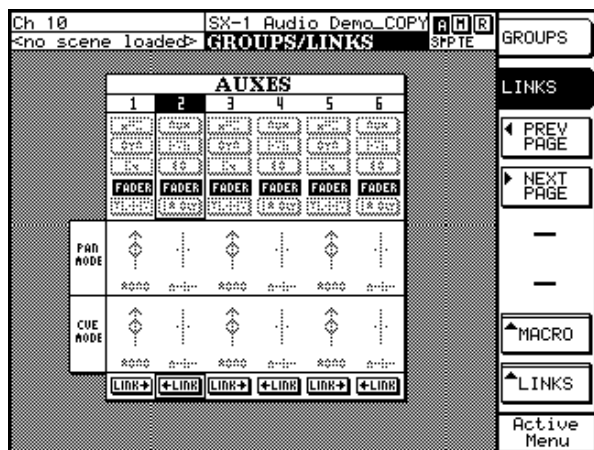

AUX Links Screen

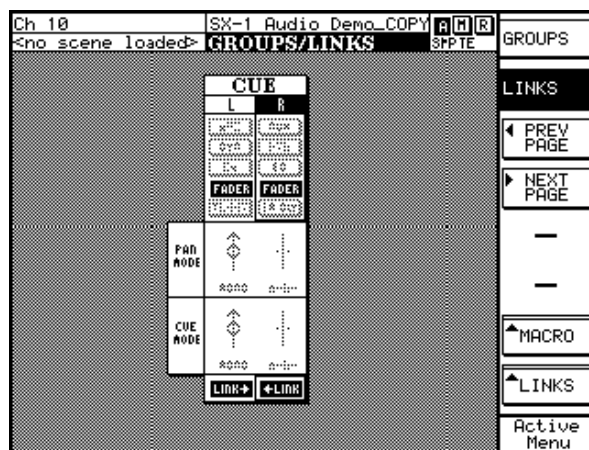

CUE Links Screen

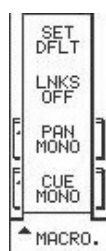

**MACRO** This key opens the MACRO dialog where there are several special link-related commands:

**SET DFLT** Press this soft key to make the mixer's channel links return to their factory default settings.

**LNKS OFF** Turns all presently active links off.

**PAN MONO** Sets the stereo pan for the selected channel to mono.

**CUE MONO** Sets the cue pan for the selected channel to mono.

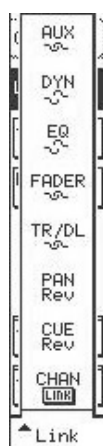

**LINKS** This key opens the LINKS dialog, which contains the selected channel's available parameters for linking.

**AUX** Makes or breaks the selected channel's Aux Sends link.

**DYN** Makes or breaks the selected channel's Dynamics link.

**EQ** Makes or breaks the selected channel's EQ link.

**FADER** Makes or breaks the selected channel's Fader link.

**TR/DL** Makes or breaks the selected channel's Trim and Delay link.

**CUE** Makes or breaks the selected channel's Cue link.

**CHAN/LINK** Turns the Link function on and off for the selected channel.

## Groups

It's possible to group any of the mixer channels (including aux, effect sends, busses, and MIDI chan-

nel faders) in two different ways, as stereo pairs or groups containing master and slave faders.

### VGA Fader Groups

The GROUPS module of the CHANNEL screen gives you direct control over the selected channel's associated fader groups.



Press **CHANNEL** in the **MAIN DISPLAY MODES** section to find this module. From here you can add and delete master and slave faders.

**Master** This window displays the master fader associated with the selected channel.

**Slaves** This window displays the slave faders associated with the selected channel.

**Add** Press the key to select the type of fader you want to add as either a Master or Slave.

**DISSOLVE** Dissolves the group when the group master is selected.

**DELETE** Removes the selected Slave fader from the Slaves window.

**TIP**

*Step by step instructions for creating a slave group controlled by a Group Master fader are given below.*

### LCD Fader Groups

The GROUPS/LINKS screens' GROUPS page parallels the GROUPS module on the VGA Channel screen.

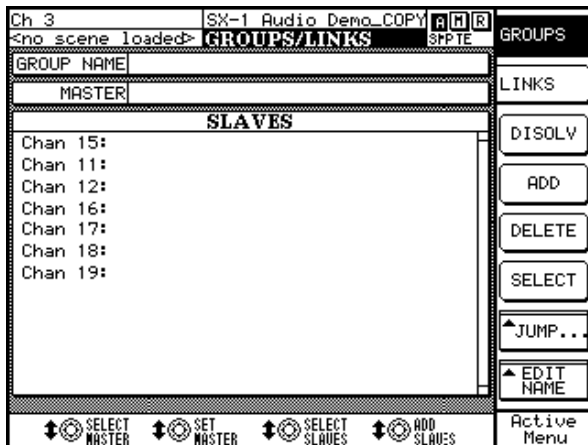

From the **LCD ACCESS** section, press the **GROUPS/LINKS** key to reach the GROUPS/LINKS screen. Then press the GROUPS soft key to reach the GROUPS page.

**SELECT** Allows you to select faders for editing. For example, several faders can be simultaneously highlighted and removed.

**JUMP** Allows you to jump between a project's different fader groups.

**EDIT NAME** Allows you to name your Fader Groups. This feature is unique to the LCD screen and is not reflected in the VGA's GROUPS module.

## Understanding Group Masters

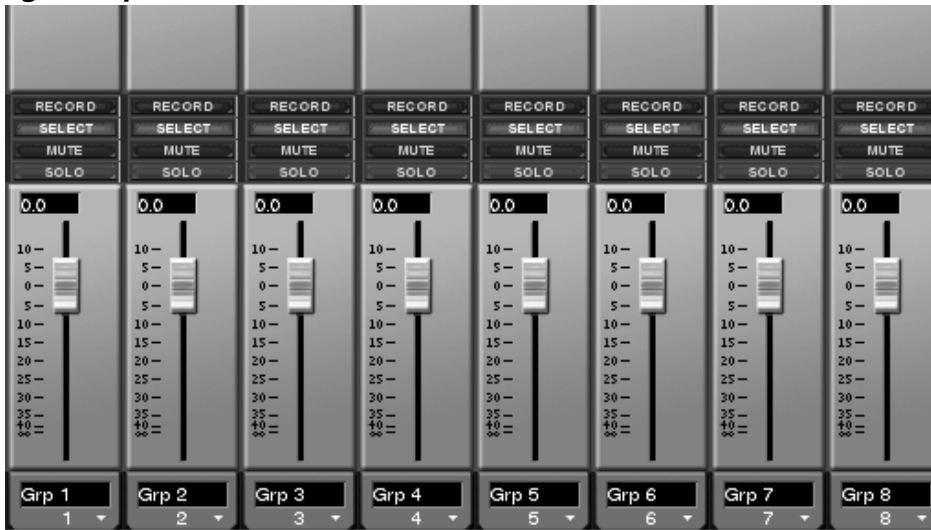

Group Masters are faders that are dedicated controllers. No signal actually passes through them - they merely control a group of slave faders. The benefit of using a Group Master instead of a regular mixer channel as a master fader is that you don't waste a mixer channel controlling your slaves.

There are eight dedicated Group Masters.

They show up in the Return/Group preset fader bank (pictured here—press the **RTN/ GRP** key in the **FADER BANK** section to reach this screen).

To assign a group of slave faders to a Group Master, follow these steps:

- 1 **Select a slave fader that is part of the group of Slave faders you want to control. Press the channel's SEL key and then press CHANNEL in the MAIN DISPLAY MODE section to view the slave fader's channel screen.**

- 2 **In the GROUPS module (of the VGA's Channel screen—that you recalled in the last step) under the Master window, click the Add arrow.**
- 3 **From the menu, choose GRP1 from the Group Masters sub-menu.**
- 4 **That's it. The first Group Master fader will now control the selected slave's associated group. If you want to add other slave channels to the group, click on the Add arrow below the Slaves window (in the same module) and select the desired channels.**

### NOTE

*To do this quickly, hold down the surface **SHIFT** key, and press the Group Master's **SEL** key, followed by the **SEL** keys of those channels you want to add to the group.*

## Fader Banks

The 16 mixer faders allow level control over all of the SX-1's audio and MIDI channels. The faders themselves are not hardwired to a particular channel, but instead are able to control whatever channel to which they are assigned (including the obvious 32 mixer inputs, sends and returns, busses, and MIDI tracks).

All the different types of channels can be recalled to the actual faders in “banks” of 16 at a time. These banks are called *fader banks* and can be accessed from the keys in the **FADER BANKS** section on the SX-1's slanted front panel.

### Fader Bank Section

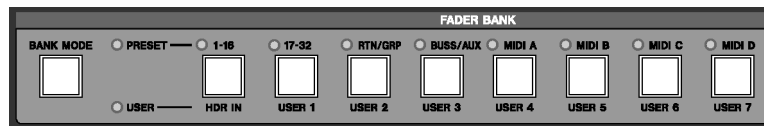

Fader banks are available as presets, or you can create your own user-defined banks. The keys in this section are for recalling fader banks.

**BANK MODE** Use the **BANK MODE** key to switch between our preset fader banks or your own custom fader banks. Press **BANK MODE** and then the fader bank (Preset or User) you want to recall.

**<PRESET>** Indicates that the **FADER BANK** keys will recall the default/preset fader banks (the labels on top of the **FADER BANK** keys—see below for each key's individual description).

**<USER>** Indicates that the **FADER BANK** keys will recall the user defined fader banks (the labels at the bottom of the **FADER BANK** keys).

**1-16/HDR IN** Use the **1 - 16 /HDR IN** key to recall audio mixer channels 1 to 16 (which default to the 16 analog inputs), making sure the **<USER BANK>** LED is lit (if not, press **BANK MODE**) and press **1 - 16 /HDR IN** to recall the Hard Disk Recorder inputs 1 to 16.

#### TIP

*The HDR IN bank always controls the master input levels to the HDR. For example, even if the direct out from channel 1 feeds HDR In 1, that channel's level can still be controlled by the HDR Bank.*

**17-32/USER 1** Use the **17 - 32 /USER 1** key to recall audio mixer channels 17 to 32 (which, at default, have the HDR outs routed to their inputs), and your own custom user bank. When recalling the User Bank, be sure the **<USER BANK>** LED is lit (if not, press the **BANK MODE** key).

**RTN/GRP/USER 2** Use the **RTN/ GRP/ USER 2** key to recall the audio mixer's fader groups and Return channels, and your own custom user bank. When recalling the User Bank, be sure the **<USER BANK>** LED is lit (if not, press the **BANK MODE** key).

**BUSS/AUX/USER 3** Use the **BUSS/ AUX/ USER 3** key to recall the audio mixer's busses and auxiliary returns, and your own custom user bank. When recalling the User Bank, be sure the **<USER BANK>** LED is lit (if not, press the **BANK MODE** key).

**MIDI A/USER 4 to MIDI D/USER 7** Use the **MIDI A/ USER 4** to **MIDI D/ USER 7** keys to recall MIDI sequencer channels 1-16 for port A through 1-16 for port D, and your own custom user banks. When recalling the User Bank, be sure the **<USER BANK>** LED is lit (if not, press the **BANK MODE** key).

# Part IV—Mixer Controls

## VGA Fader Banks

In the **FADER BANK** section each key has an associated VGA screen. The User Bank screens reflect your own custom bank setups (explained in the following pages).

From the **MAIN DISPLAY MODE** section, press **MIXER/ USER BANKS** and then the preset fader

bank screen you would like to view: Channels 1–32 (in two groups of 16), Return/Group, Buss/Aux, and all the MIDI channel banks (in four groups of 16 channels each for a total of 64 MIDI channels). See the preset fader bank screen examples below.

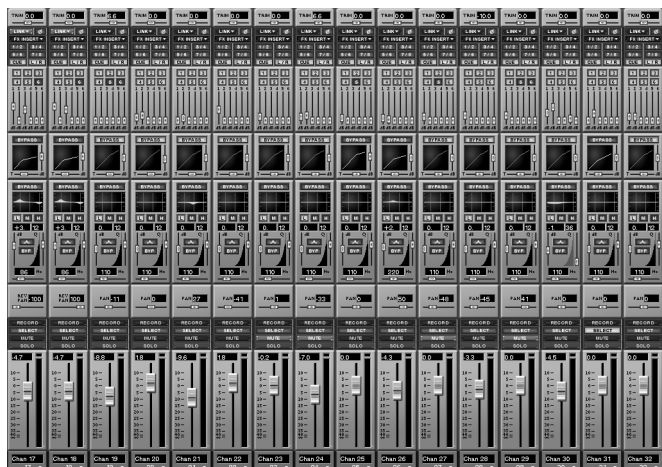

Mixer channels

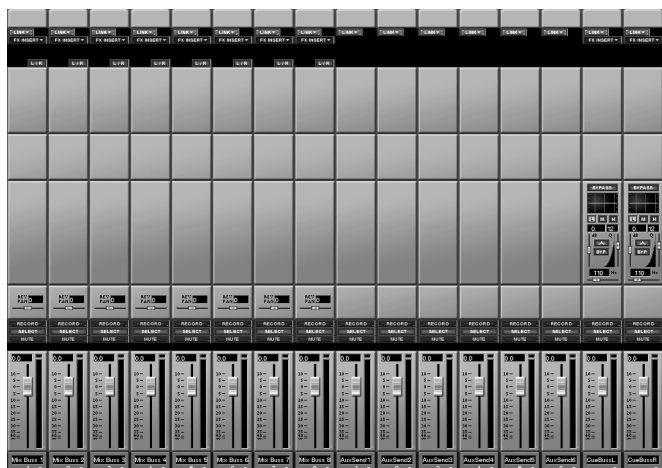

Buss & Aux channels

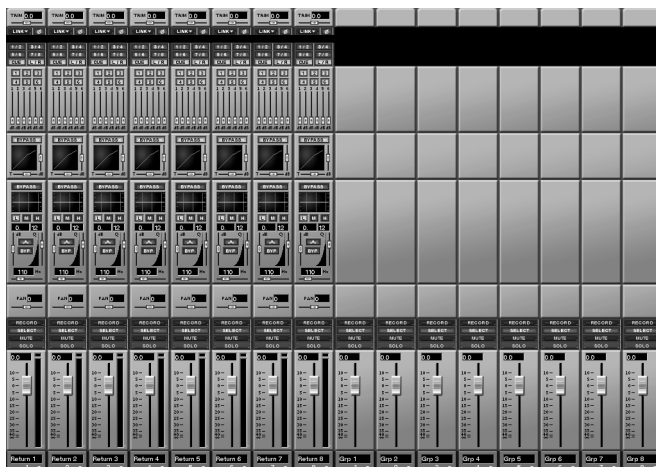

Return channels & group faders



MIDI channels

### TIP

The **MIXER/ USER BANKS** key's default screen is the same as the preset fader bank 1 - 16 /HDR IN screen (showing mixer channels 1-16). Before pressing any **FADER BANK** keys, when you first press **MIXER/ USER BANKS**, it recalls this screen. Otherwise, the VGA Mixer screen always follows the selected bank.

## USER Fader Banks

From the **MAIN DISPLAY MODES** section, press **MIXER/ USER BANKS**. Make sure that the **BANK MODE LED** is set to **<USER>** (if not, press **BANK MODE**). Then select the User Bank key for the user bank screen you want to view.

The example below has several different channel types arranged on a single screen and saved as a User Bank for quick recall.

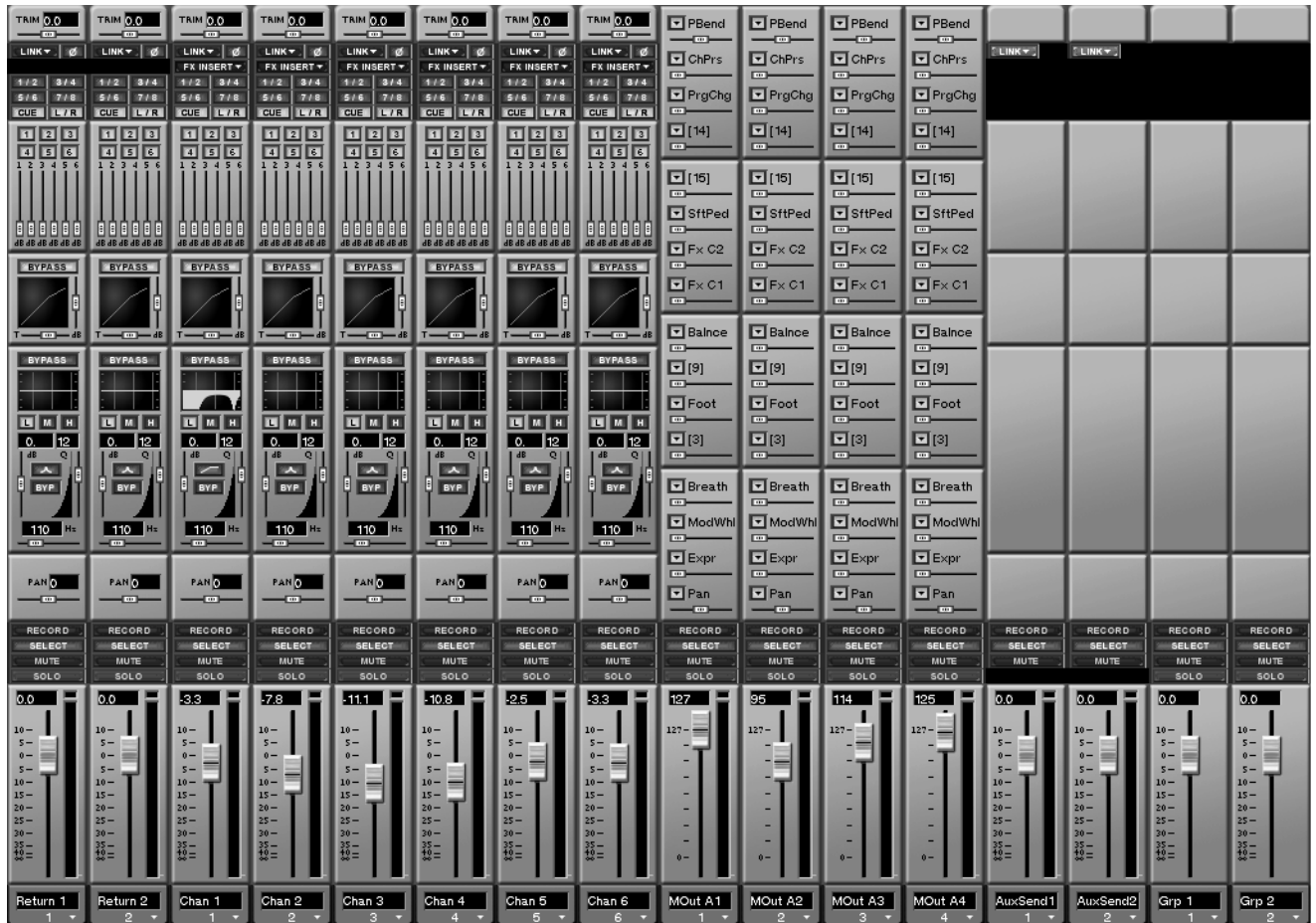

## Creating a User Fader bank (VGA)

To create a User Fader bank in the VGA Mixer screen, first make sure that the **BANK MODE** key is set to **<USER>**. Then right-click on the arrow at the bottom

of a channel to select the type of channel you want to assign to that display strip.

## User Fader Banks (LCD)

Press **SHIFT** on the keypad and then the **MIXER/USER BANKS** key in the **MAIN DISPLAY MODE** section. This recalls the USER BANKS screens.

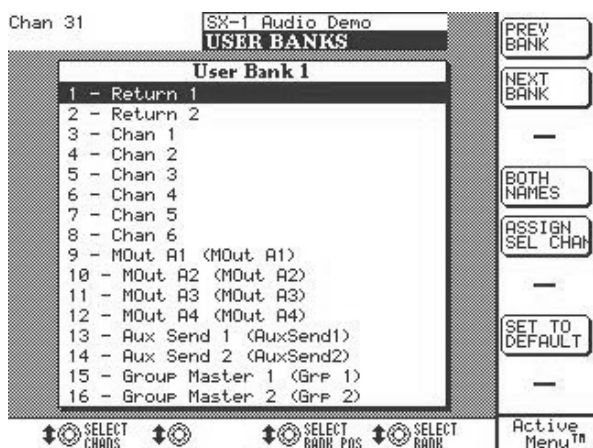

**PREV BANK** Scrolls forward to the next User Bank.

**NEXT BANK** Scrolls back to the previous User Bank.

**BOTH NAMES** Allows the display of both the pre-set system names and user defined names.

**ASSIGN SEL CHAN** Selects a channel to be edited.

**SET TO DEFAULT** Returns the currently selected User Bank back to its default setup.

**SELECT CHANS** Selects a channel to be edited.

**SELECT BANK POS** Selects the channel to be positioned at the highlighted slot.

**SELECT BANK** Selects the bank to be edited.

**VGA Bank Menu** All Fader Bank screens can also be recalled directly from the menu bar's Bank menu.

Bank	
Channel Inputs 1-16	SHIFT   ALT   1
Channel Inputs 17-32	SHIFT   ALT   2
Aux Returns/Groups	SHIFT   ALT   3
Busses/Aux Sends	SHIFT   ALT   4
MIDI Output A	SHIFT   ALT   5
MIDI Output B	SHIFT   ALT   6
MIDI Output C	SHIFT   ALT   7
MIDI Output D	SHIFT   ALT   8
User Bank 1	SHIFT   CTL   ALT   1
User Bank 2	SHIFT   CTL   ALT   2
User Bank 3	SHIFT   CTL   ALT   3
User Bank 4	SHIFT   CTL   ALT   4
User Bank 5	SHIFT   CTL   ALT   5
User Bank 6	SHIFT   CTL   ALT   6
User Bank 7	SHIFT   CTL   ALT   7
User Bank 8	SHIFT   CTL   ALT   8

### TIP

Note the PS/2 keyboard commands after the menu items. Use the PS/2 keyboard as an alternative to pressing **FADER BANK** keys.



## Channel Overview Screens

The Overview screens are recalled by pressing the **OVERVIEW** key in the **MAIN DISPLAY MODE** section, and then clicking on the corresponding tab for the overview you want to see. These screens show all the signals running through the mixer at a glance.

**TIP**

*The Overview screens can also be recalled from the View menu on the VGA screen's Main Menu Bar.*

### VGA Buss Overview Screen

The returns, mix busses, aux sends, and Master L/R buss are displayed in this overview.

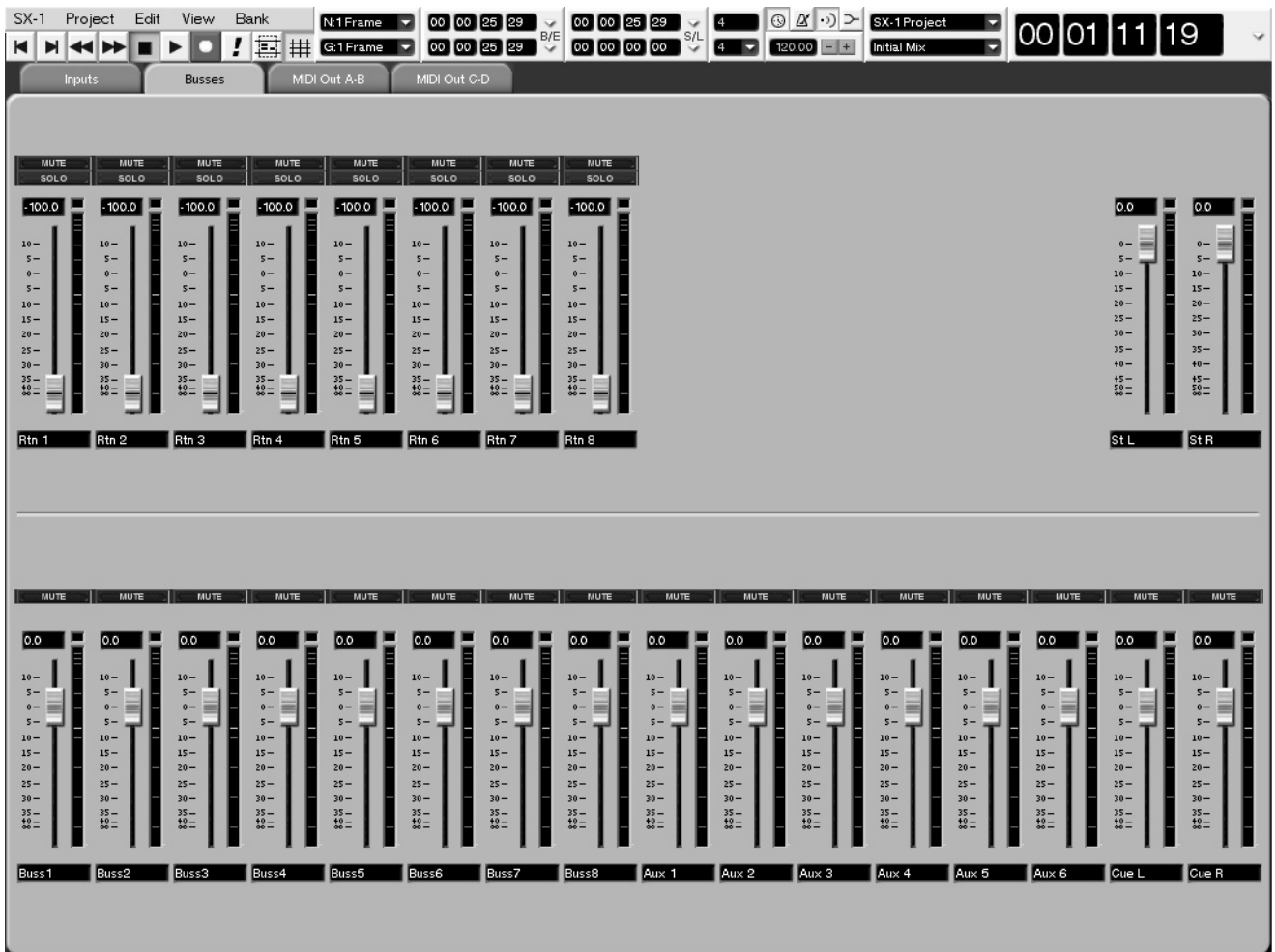

## Part IV—Mixer Controls

### LCD Buss Overview Screen

Press **OVERVIEW** from the **MAIN DISPLAY MODE** section, then press the **BUSS** soft key.

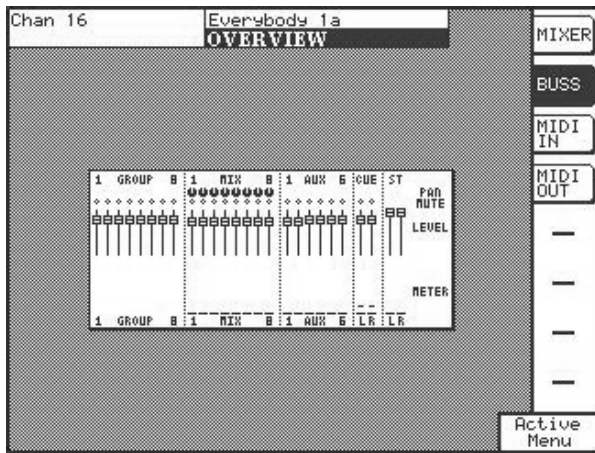

Use this screen to view the fader positions of the channel busses, group masters, Aux sends, cue and L/R Master busses. The pan positions for the channel busses are also shown.

### LCD Mixer Overview Screen

Press **OVERVIEW** from the **MAIN DISPLAY MODE** section, then press the **MIXER** soft key.

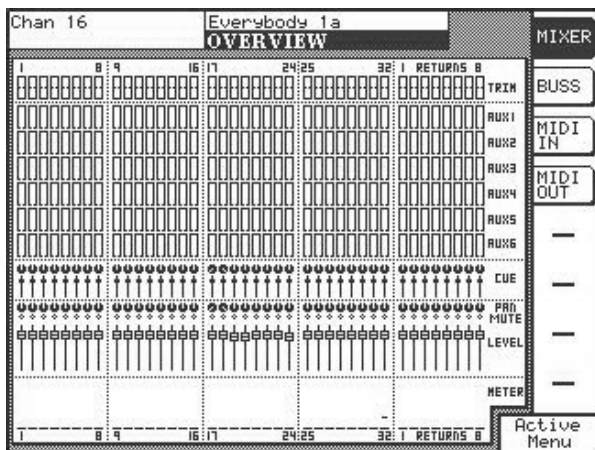

This screen shows the fader and pan positions for all of the mixer's input channels and cue sends. Mute switches and trim are shown for the mixer channels as well. Aux send levels are also displayed here.

## VGA Input Overview Screen

All 32 of the mixer channel inputs are displayed in this overview.

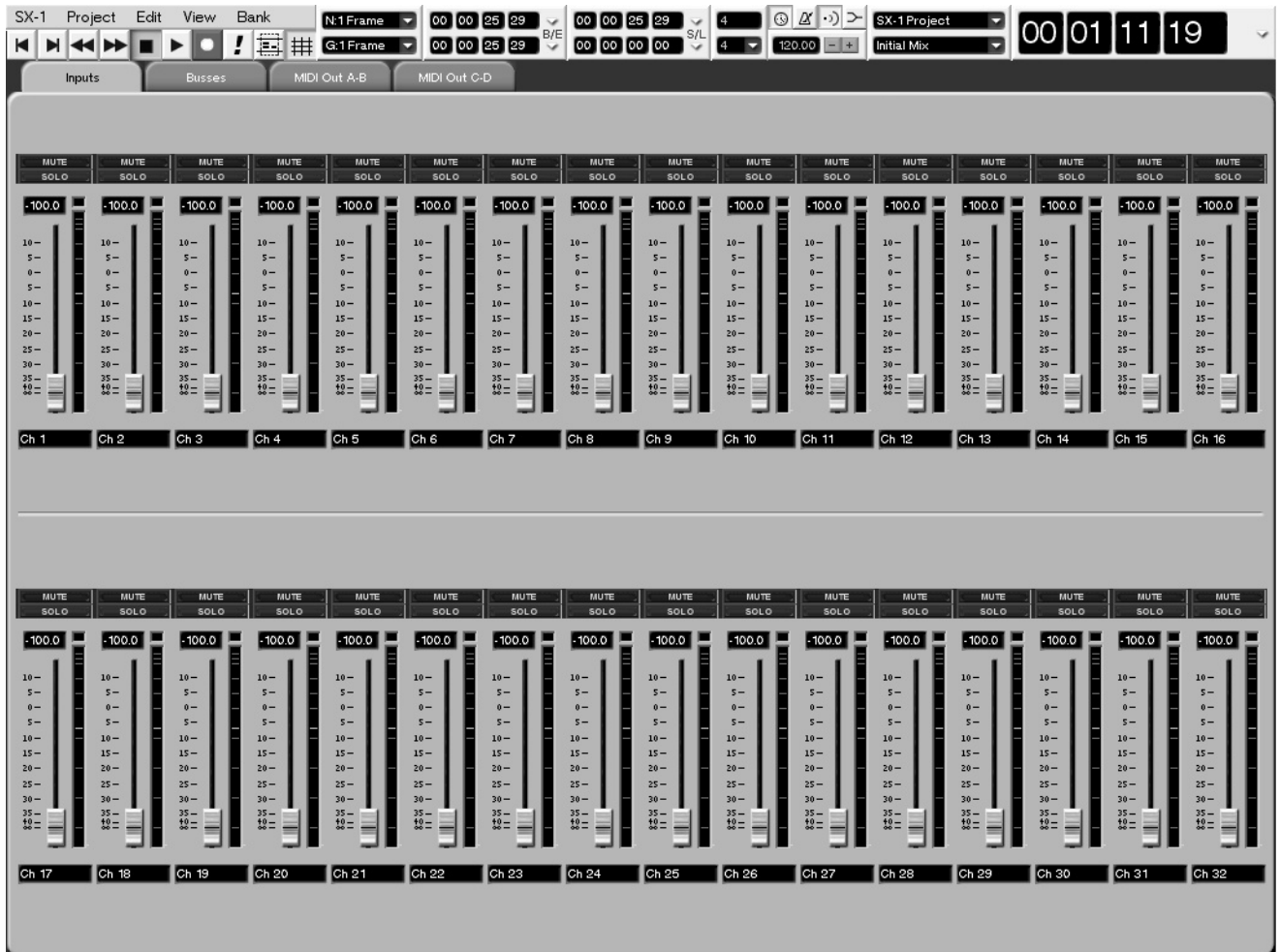

### TIP

The meters of the SX-1's VGA screens are able to display three signal weights at once: Peak, Average, and Current. The white dot to the right of the meter (when signal is present) is RMS (or Average), the peak LED that

holds for a few seconds is Peak, and the regular meter shows current amplitude (Current).

Incidentally, the speed of meter operation is adjustable from the LCD Preferences page. You can vary the speed between very fast and very slow (which looks a bit like old plasma meters on large format consoles).

# Chapter 13 – Automation

---

## Understanding Modes & States

---

The SX-1 can write automation moves to any of the mixer's controls, including: faders, mute, pan, surround, EQ, dynamics, aux sends, buss assign, cue and library recall. Automation can also be written to the effect plug-ins' parameters.

The automation functions are best understood when broken into two categories - those functions that are global in scope and those that are controller specific. We'll call the first category Global Modes, and the second, Controller States. Global Modes cause all controllers to respond in a way that is defined by each individual controller's State. A controller's State refers to its current automation condition — which in turn determines how it will react to the Global Mode.

While Global Modes can be turned on and off, a controller's State is always active (even if its automation

State is Off, which is still a State). For example, a controller whose state is Automatic will read pre-existing automation data with no Global Mode active. However, when Global Write is enabled the controller will also (in addition to reading the pre-existing data) write automation over its pre-existing data when the controller is moved. Each of the automation's Global Modes and Controller States are explained on the following pages.

### TIP

*The SX-1's faders are touch-sensitive. During automation, they sense that they are being touched through the stray capacitance in your fingertips. To ensure that the touch-sensitivity of the faders is responding properly, always use the pads of your fingers to move the faders. If you use another device (such as a pencil, ruler, or even your fingernail), the fader will not register as having been touched.*

---

## Controller States

---

There are six different Controller States:

---

### Automatic (Auto)

This is a controller's default automation state. It is highly flexible, as it will change its behavior depending on the status of the Global Modes, whether or not it already has dynamic mix data, and whether or not it is being touched.

For example, when a control is in Auto and the transport is running, the control enters *write ready* if the

Global Write LED is lit, or *trim ready* if the Global Trim LED is lit. The control reads pre-existing data (if any) until it is moved, and then enters the appropriate state (writing or trimming). It is possible for a single control, or a group of controls to drop into and out of writing and trimming in one pass, while other controls remain unaffected.

---

### Static

During the course of an automated mix, some controls require movement (Dynamic automation) while others remain stationary throughout the track. The position of these controls are saved as part of the

mix. A control in Static will have its position automatically updated in the current project's mix file whenever that control is moved, regardless of whether a Global Mode is active.

---

### Write

A control in Write Status behaves just as if it were set to Auto, and Global Write was on. This status does not require that a Global Mode be enabled to enter *write ready*, as the control enters that status the

moment **PLAY** is depressed. Any movement of the control while the transport is running will overwrite pre-existing data.

**Trim**

During a mix there may be sections where there are good mix moves on a control but the overall level of that control needs to be raised or lowered while preserving the existing moves.

Trim mode is used to make such relative offsets to existing mix moves for the duration of the Trim operation.

**Safe**

Any control in Safe will only read existing static or dynamic automation, regardless of the Global Mode. Moving a control in Safe will not write any automa-

tion data nor affect the audio passing through that control.

**Off**

Use this selection to turn a control’s automation functionality off. A control that is Off will neither write nor play back automation data, regardless of the Global Mode. However, moving a control that is Off will affect its audio. Similarly to the Static Con-

troller State, the new, final resting position of the control is in the project file, separate from the control’s static position as stored in an individual mix file.

**Global Modes**

There are three different Global Modes:

**Global Write**

Think of this mode as “automation-record-ready”. When Global Write is enabled, and the transport is moving, all the controls that are in Auto will read pre-existing automation data until they are moved.

As soon as you move a control, automation will begin writing for that control, overwriting any pre-existing data.

**Trim**

During a mix, sometimes there are sections when a control’s mix moves are perfect but the overall level needs to be raised or lowered.

To change such a section’s level without affecting its contours (the peaks and valleys of the automation data), use Global Trim Mode. The diagram below illustrates how Trim will affect the pre-existing automation data when the controller’s State is in Auto.

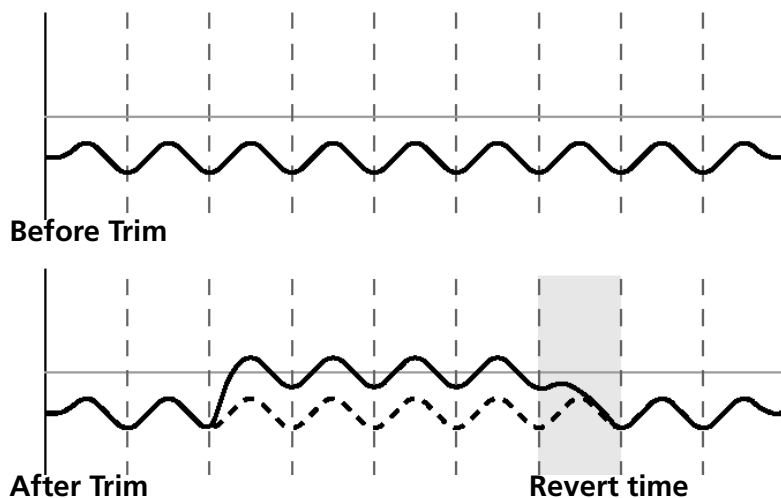

### Init Edit

The Initial Status of a control is its value before the first dynamic mix move present. Until dynamic mix moves are written to a control, there is no difference between the Initial Status of a control and its position were it set to Static. When dynamic mix moves are written to a control, and the controller is in Auto, the

controller becomes dynamic. Any change to the mix data on such a control takes into account both its Initial Status and any dynamic automation. The illustration below shows what Initial Status looks like with respect to dynamic automation data.

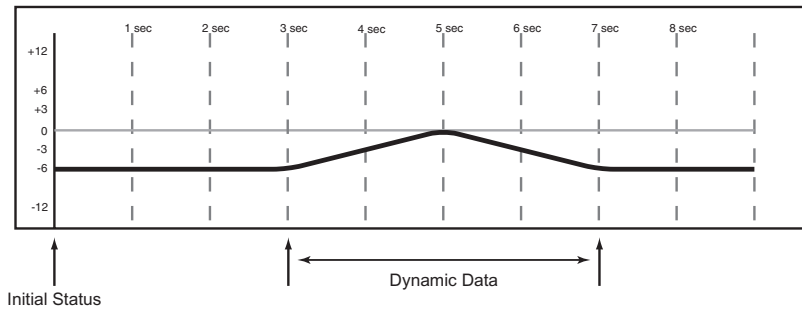

Once a control contains dynamic automation data, any new mix moves written to that control will be dynamic mix moves as well. If it becomes necessary to alter a control's starting point (Initial Status)

before the first dynamic move written, Init Edit is used.

The Initial Event Ramp Time allows a smooth match between the new initial value, and the previous dynamic automation data.

You can adjust any control to change its Initial Status at any time. In the case of faders, moving the fader element while in Init Edit will change its Initial Status to reflect its new setting. In the case of keys and

knobs, pressing a key while in Initial Edit will change its Initial Status to reflect its new setting. The illustration below shows how an Init Edit operation on a controller set to Auto would look.

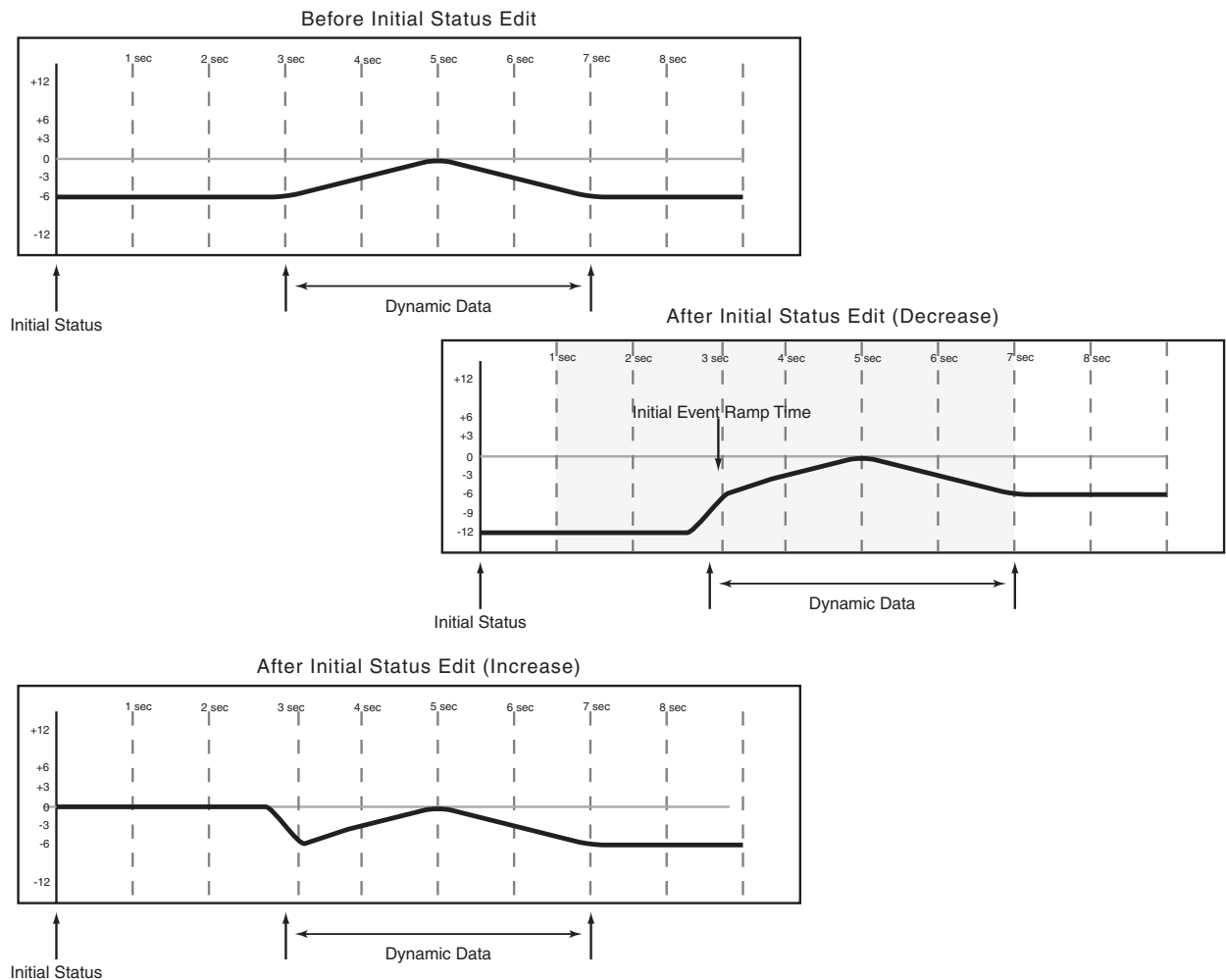

## Rehearse Functionality

**Rehearse** is a special automation setting that allows you to practice or experiment with mix moves without actually writing them. It works with all the Global Modes.

The main advantage of the Rehearse mode is that in this mode, the SX-1 behaves exactly as if the control is being written to, but without actually writing data.

For example, when rehearsing a Trim operation you will hear the results of the Trim and the Revert will occur just like a real Trim.

Additionally, the rehearsed data will show in the VGA Automation display while being performed, and then disappear upon transport stop.

### Global Controls

The Global screen houses parameters for defining how automation will operate in the current project.

### Mix Displays

The SX-1 has the ability to save multiple discrete Mixes for a single project. These Mixes contain a large amount of data, such as which takes are loaded, processing parameters, routing and stereo links in

addition to the actual automation data. The Mix tab in the Automation screen is where these Mixes are managed.

### VGA Mix Tab

From the AUTOMATION screen, press the Mix tab. Here, you can name, save, and recall mixes.



Highlight the mix to be loaded or deleted in the Mix field, and press the LOAD or DELETE button as appropriate. In the case of a delete operation, a confirmation dialog is shown.

When a mix is highlighted, it may be renamed by entering a new name into the Name field.

**KEEP MIX** Press this key to save your current mix. Pressing **SHIFT** and the **TOUCH/ KEEP** key does the same thing from the control surface.

Using **KEEP MIX**, whether from the VGA interface or from the control surface, will save the current mix (adding an incremented numerical value), allowing further mixing to be done while maintaining the option to go back to a previous version.



### LCD MIX Screen

The MIX screen mirrors the MIX tab from the VGA AUTOMATION screen.

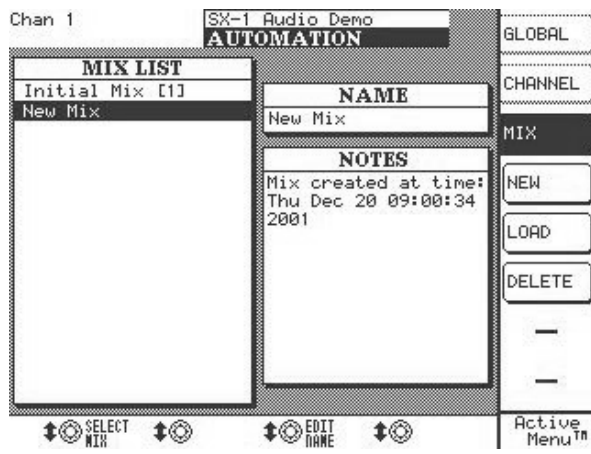

From the **MAIN DISPLAY MODES** section, press **AUTOMATION** and then the MIX soft key to reach this screen.

**TIP**  
*A project's associated mixes can also be recalled directly from the VGA's Main Menu Bar just to the left of the time readout.*

## Automation Controls

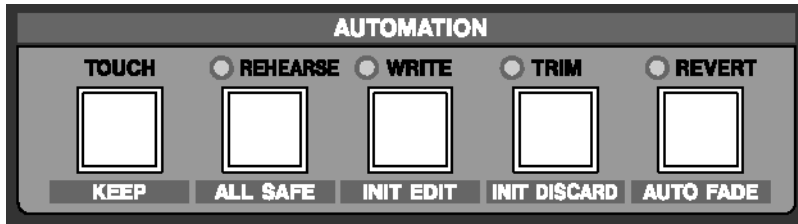

### Front Panel Controls

All the automation modes can be entered from the SX-1's front panel as well as through associated LCD and VGA screens. However, the front panel controls give you direct and immediate access to the automation modes without needing to be on an automation screen.

The keys in this section access all of the mixer's automation States and Modes.

**TOUCH/KEEP** Use the **TOUCH/KEEP** key to use the Touch function, which overwrites soft knob or rotary encoder data at the current setting, erasing previous moves. Since these controls are not touch-sensitive, this is a useful way to erase previous mix moves on these controls.

The relationship between the previous mix moves and the moves made using the touch function is shown below:

Existing Move

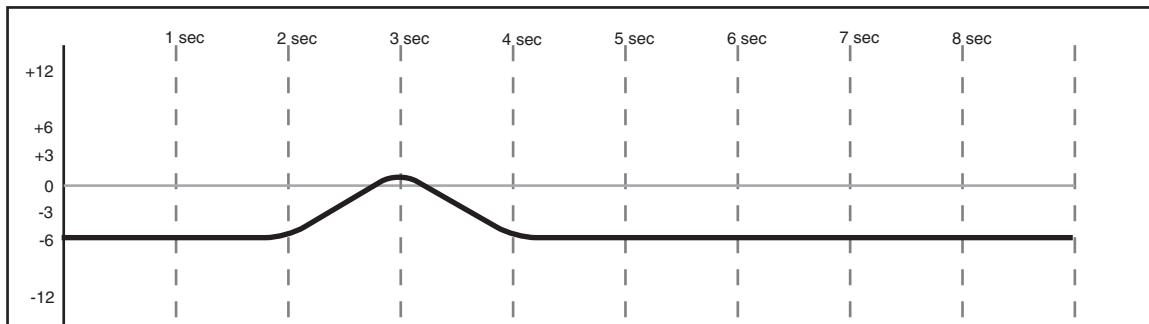

Mix Move

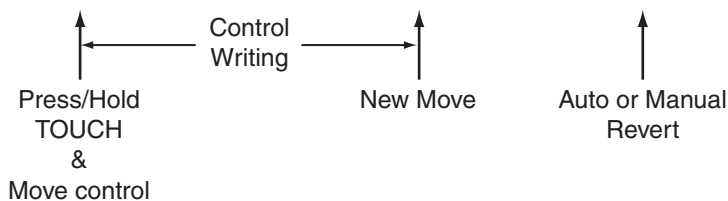
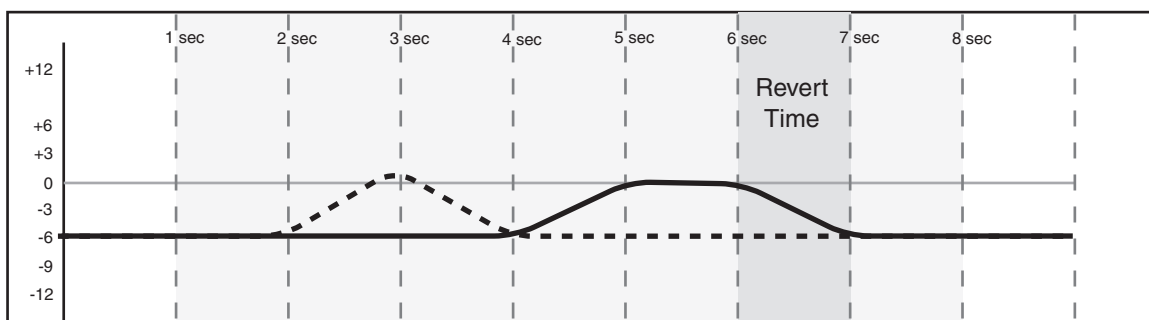

To operate the touch function:

- 1 **Enable write mode.**
- 2 **Press and hold the TOUCH key.**
- 3 **While holding the TOUCH key, use the control to begin overwriting the existing previous mix moves for that control.**
- 4 **Release the TOUCH key. The control continues to write until a new move is written or until REVERT is pressed.**

**If a new move is written, the revert action follows the settings made on the AUTO MAIN screen.**

**REHEARSE/ALL SAFE** The **REHEARSE/ ALL SAFE** key enables the write automation Rehearse mode.

Press **SHIFT+REHEARSE/ ALL SAFE** to prevent automation from being written at all. This All Safe mode places all controls on the mixer into Safe. The result is that no automation can be written and moving a control will not affect the audio going through that control.

**WRITE/INIT EDIT** Use the **WRITE/ INIT EDIT** key to enable Global Write mode. The Write mode must be enabled (as indicated by the **WRITE/ INIT EDIT** key's associated LED) in order for touch automation to function. Press **SHIFT+WRITE/ INIT EDIT** to enter the Init Edit mode.

Init Edit allows editing of any control's initial status as described above. Exiting Init Edit saves the edit. There is no Undo for this operation. The **INIT DISCARD** is used to Undo an Init Edit (see below).

**TRIM/INIT DISCARD** The **TRIM/ INIT DISCARD** key enables the Global Trim mode. Trim automation allows you to add or subtract values from your current automation data. For example, if automation data already exists, entering the Trim mode and then pushing the fader up will add this extra value to the track's already recorded automation. Pressing **SHIFT + TRIM/ INIT DISCARD** throws out any changes made while Init Edit is active. This must be done before exiting the Init Edit status.

**REVERT/AUTO FADE** Press **REVERT** to cause any controls currently Writing or Trimming to exit Write/Trim and transition back to the setting they held prior to the Write or Trim operation. The amount of time taken for this transition is determined by the setting of the Write Revert Time and Trim Revert Time parameters.

**SHIFT+REVERT/ AUTO FADE** automatically fades the Master Fader out over a specified time (this time is also set from the Global tab). Auto Fade operations must be performed in either Write or Trim mode. Auto Fade operations may be rehearsed using the Rehearse mode.

### VGA Automation Screen

From the **MAIN DISPLAY MODE** section, press the **AUTOMATION** key to reach the Automation screens (if the **MAIN DISPLAY** is set to **EXTERNAL**—other-

wise, use the **Alt+5** combination on the PS/2 keyboard). These screens provide control of all the SX-1's automation parameters.

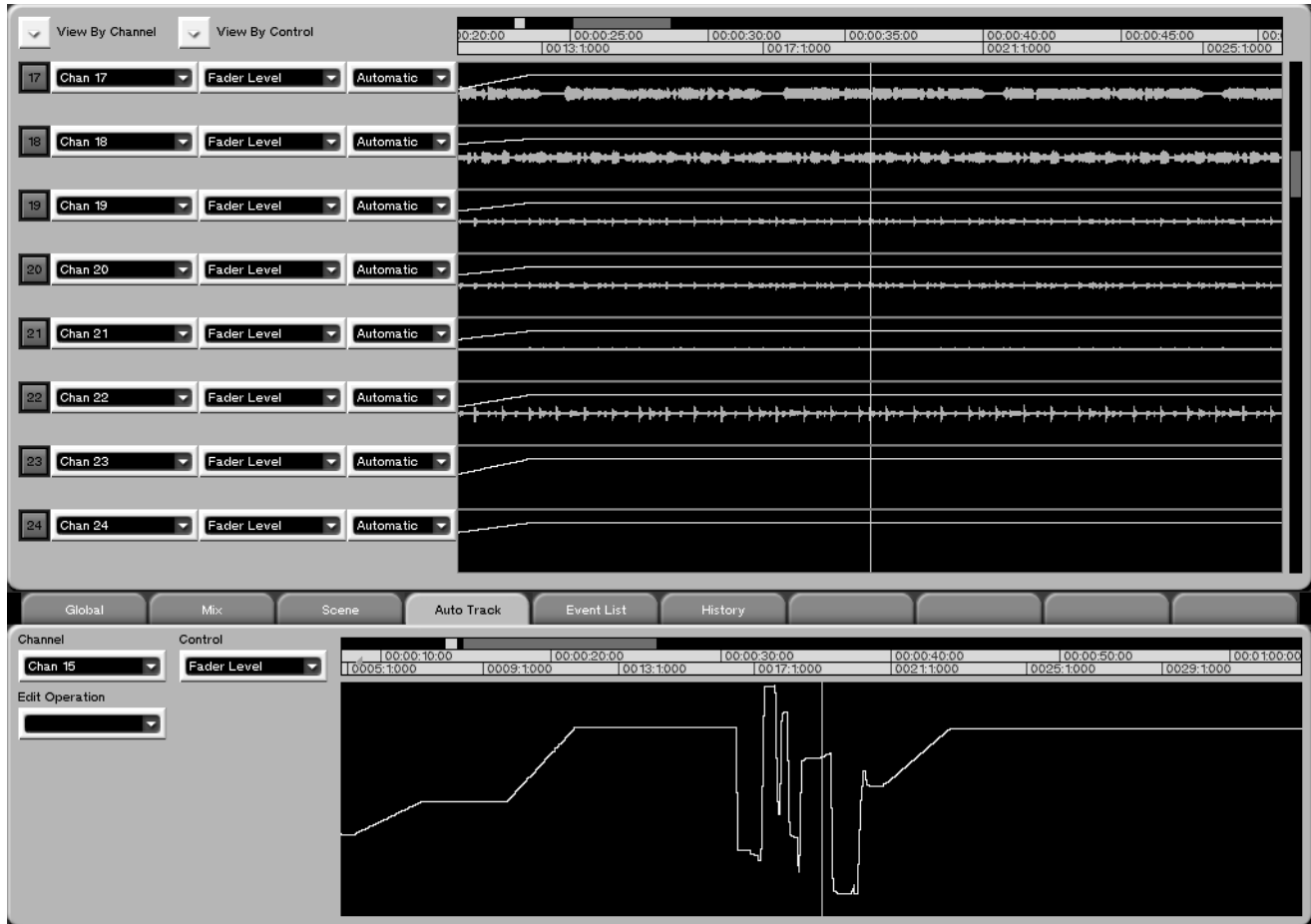

#### TIP

*Working with data in the AUTOMATION screen is very similar to working with audio or MIDI data in the TRACK screen. Most of the same editing and selection commands and tools apply to these regions as with audio and MIDI data.*

## Automation Track Area

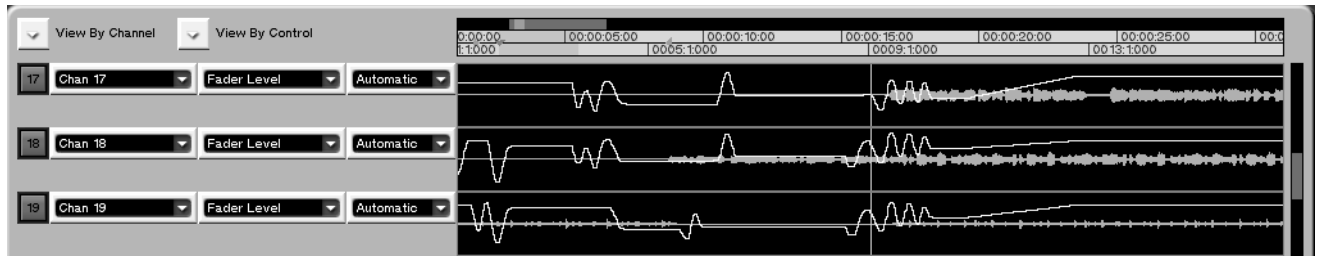

This area works in much the same way the Tracks channels work on the TRACK screen. Regions of automation data can be selected and edited just as they can in the MIDI Piano Roll and Audio Waveform tabs (for more on editing tools and commands, see “MIDI Editing” on page 155).

**View by Channel** Click on the arrow to select a channel to view. This allows you to view all the controls for the selected mixer channel. All the automation tracks will update to show the selected channel.

**View by Control** Click on the arrow to select a control to view. This allows you to view the same control for several different mixer channels or effects

plug-ins at the same time. All the automation tracks will update to show the selected control type.

**Channel** This field shows the name of the mixer channel or effect plug-in displayed in the automation track window. You can click on the arrow to select a channel to view.

**Name** This field shows the name of the control displayed in the automation track window. You can click on the arrow to select a control to view.

**Status/Mode** Click on the arrow to select the control’s automation State. The available choices are Auto, Static, Trim, Write, Safe, and Off.

## Auto Track

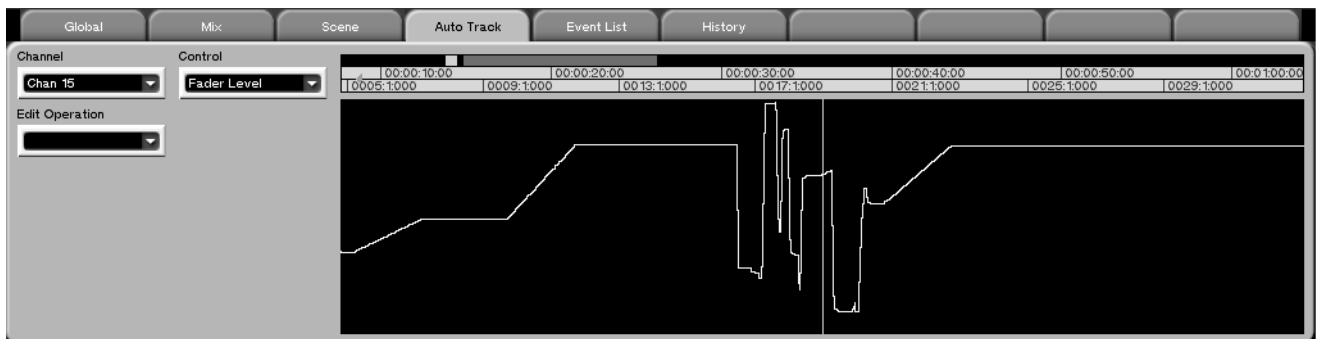

This tab works in much the same way the Waveform tab works in the TRACK screen. Here you can view a single control’s automation data and select and edit that data just as if it were a MIDI controller or a waveform. From the **MAIN DISPLAY MODE** section, press **AUTOMATION**, then the Auto Track tab. Also see Chapter 19 for tool editing.

**Channel** Click on the arrow to select a channel to view. This field shows the name of the mixer channel or effect plug-in displayed in the tab’s track window.

**Control** Click on the arrow to select a control to view. This field shows the name of the control displayed in the tab’s track window.

**Edit Operations** Click on the arrow to select the type of edit operation you want to perform on the selected data. As with the MIDI Piano Roll and the Audio Waveform tabs, the choices in the Edit Operations menu vary, depending on the editing tool currently selected:

---

### Edit Operations (Region/Event select)

---

#### When nothing is selected

**Add Library Entry Recall** This operation brings up the parameters you edit in order to recall a library entry as an automation event. You can define:

- **Library Type:** from which library (EQ or Dynamics) an individual preset is recalled
- **Algorithm:** use this to choose an effect to recall when automating the library recall of an internal effects processor
- **Load entry:** The drop-down menu allows the library entry to be selected
- **Transition time:** The time taken for the current settings to “morph” into the recalled library setting
- **CANCEL:** Exit without making changes
- **DONE:** Confirm settings and return

**Render Library Recalls** This allows the parameter changes which will be performed when a library entry is recalled to be split into a series of automation events. This can be useful when a mix started out containing library recalls, that later requires dynamic automation.

---

**A region is selected** In addition to the Add and Render Library events described above, the following additional edit commands are available when a region or an event has been selected:

**Move** Move automation data or the region itself.

- **Apply To:** Use this to choose whether to move only the beginning of an event or region, only the end, or both the beginning and the end.
- **Move events:** Choose to move the event or region earlier or later in time.

**Smooth** Use this function to smooth out the movements of controls and/or to create average values of detailed control movements. You may want to use this when sharp control movements are too audible.

---

**Events selected** These are available when events are selected:

**Event Editor** Edit events:

- **Start Time:** Enter a new start time for the selected event
- **Value:** Enter a new value for the selected event
- **Initial Value:** Allows the initial status of an event to be edited offline.

**NOTE**

*If a fader's (or other continuous controller's) Initial Value is modified in this way, an Initial Event Ramp Time will not be applied. Unlike an Init Edit, controls that have had their Initial Value modified in this way can have that modification reversed by the Undo command.*

**Move** Allows you to nudge, by fine or gross amounts, the automation data of your selected region.

---

### Edit Operations (Pencil Tool)

With the pencil tool selected, it is possible to draw freehand control automation data.

Use the Event Density parameter to determine the smoothness of the data that you draw in single frame increments from 1 through 30.

---

### Edit Operations (Curve Tool)

**Curve Type** The Linear curve type is very useful for emulating break-point style offline volume automation, while the Exponential, Logarithmic and Cosine curve types may be used for the production of more natural-sounding fade effects.

**Curve Steepness** Used in conjunction with the Curve Type parameter above; this parameter offers subtle variations when creating an offline fade.

**Curve Randomize** A special effect that can be useful for introducing random control fluctuations into a track that is lacking performance dynamics, in a similar way to using randomized quantization in a MIDI performance.

## LCD CHANNEL screen

This screen is the equivalent of the upper left corner of the VGA screen, where the same choices are also available.

On this screen you can define the type of automation assigned to each controller of your selected mixer channel. This screen also comes in handy as an overview of a channel's automation state.

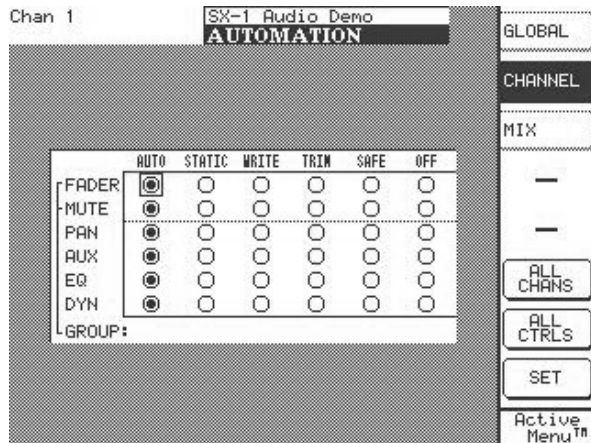

Here the numerical keypad's cursor keys are used to move the cursor to the various choices. Pressing the numerical keypad's **ENTER** key is the same as pressing the SET soft key.

From the **MAIN DISPLAY MODES** section, press **AUTOMATION** and then the CHANNEL soft key to reach this screen.

**ALL CHANS** Use this button to assign a State to the same control across all mixer channels.

**ALL CNTRLS** Use this button to assign a State to all the controls on the selected channel.

**SET** Use this button to execute your selection.

## Automation Events & History Screens

The Event List tab allows offline editing of the selected track's automation data.

The History tab shows the SX-1's global undo history and is the same as viewing this tab in other screens.

### Event List Tab



From the AUTOMATION screen, click on the Event List tab. Here you can see any automation events for all controls on the selected channel or effect plug-in. Keyboard and control surface editing is also possible on selected events.

**Edit Operation** Click on the arrow to select the type of edit operation you want to perform on the selected events. The choices are:

**Insert Library Entry Recall** This operation allows you to store the recall of a library entry as an automation event. You can define which library (EQ or Dynamics) an individual preset is recalled from, and where the recall event will be inserted. You can also select a different transition time for each automated recall.

**Event Editor** This operation provides a register for modifying the time stamp of the automation or modifying the time and value of the event. It is also possible to modify the control's Initial Value.

## Part IV—Mixer Controls

### NOTE

If a fader's (or other continuous controller's) Initial Value is modified in this way, an Initial Event Ramp Time will not be applied. Unlike an Init Edit, controls that have had their Initial Value modified in this way can have that modification reversed by the Undo command.

**Move** Allows you to nudge, by the amount into the Amount field, the selected automation events.

**Render Library Recalls** This allows the parameter changes which will be performed when a library entry is recalled to be split into a series of automation events. This can be useful when a mix started out containing library recalls, that later requires dynamic automation.

**Smooth Events** Use this function to smooth out the movements of controls and/or to create average values of detailed control movements. You may want to use this when sharp control movements are too audible.

**SCROLL** When depressed, the event list follows the playhead (it scrolls). When not depressed, the event list does not follow the playhead.

**Event Display Filters** Selects the type of control you do not want to view for the selected mixer channel or effect plug-in. For example, if the channel has many fader moves and you only need to see Mute events, uncheck Fader Level to hide those events from view.

### History Tab

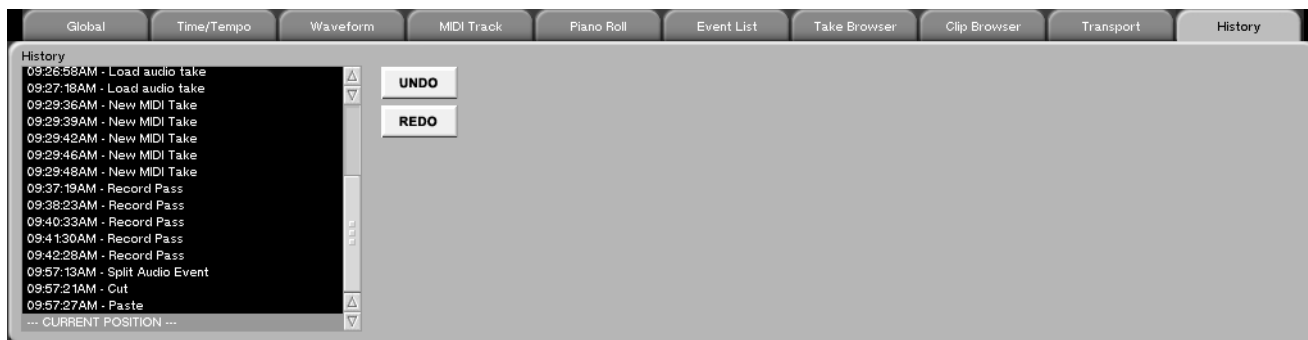

The History tab accesses the SX-1's global history list. It shows the same information that is displayed in the History tab for any screen (essentially, it is the same tab).

From the AUTOMATION screen, click on the History tab.

### VGA Automation Global Tab

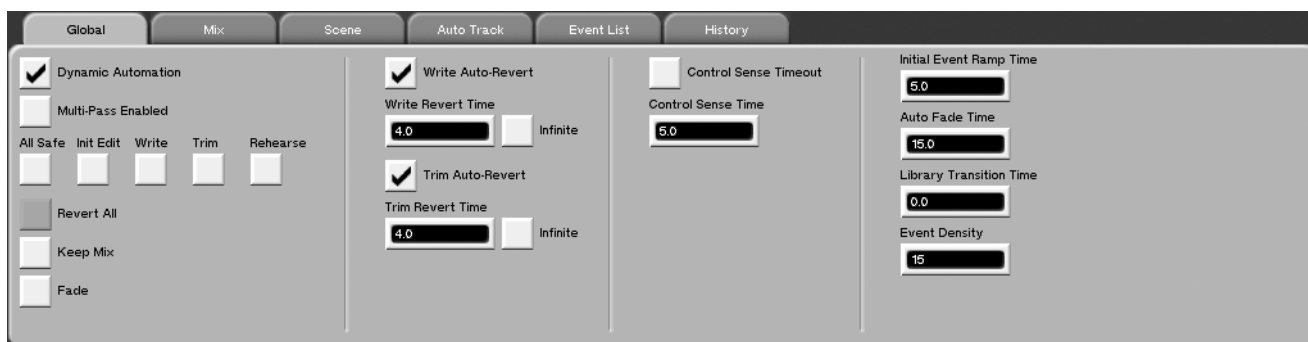

**Dynamic Automation** Enables the Automation Engine. The default value of this control is ON, allowing all control settings within a project to be Static automation data and to be stored within a mix.

If this is turned off at the beginning of a project and then later turned on, all controls will snap to the default values for a new project since their values in the Mix would not have been updated.



**All Safe** Enables the automation All Safe mode, where no auto data is generated. See the definition “Safe” on page 81.

**Init Edit** After dynamic automation is already recorded, check this box to enable changing the initial value of the automation data. For example, to change the initial start position of a fader before the first automation move.

**Write** Enables Global Write mode.

**Trim** Enables Global Trim mode.

**Rehearse** Enables Global Rehearse mode.

**Revert All** Click to revert the most recently moved controllers back to their original values.

**Keep Mix** Press this button to save the current mix within the project and automatically assign it an incremented numerical designation if a mix of the same name already exists. This is useful for creating Mix Milestones for the ability to go back to an earlier point in the mixing process. All mixes are stamped with their date and time of creation for easy reference.

**Fade** Click to begin an auto-fade on the Master fader. The system must be in Global Write or Trim to do this.

**Write Auto-Revert** Enables auto-revert during Write automation. Auto Revert causes any controls currently Writing or Trimming to exit Write/Trim and transition back to the setting they held prior to the Write or Trim operation. The amount of time taken for this transition is determined by the setting of the Write Revert Time parameter.

**Write Revert Time** Determines the amount of time it takes, after the control is released, for a Write move to return to its original value.

**Write To End (for Write mode):** Infinite—when this box is checked, the last value of the control during an automation pass will be written to the end of the project, overwriting any data already there. This operates independently of the setting of Auto Revert.

**Trim Auto-Revert** Enables auto-revert during Trim automation. Auto Revert causes any controls currently Writing or Trimming to exit Write/Trim and transition back to the setting they held prior to the Write or Trim operation. The amount of time taken for this transition is determined by the setting of the Trim Revert Time parameter.

**Trim Revert Time** Determines the amount of time it takes, after the control is released, for a Trim move to return to the track’s original value (see the Before and After Trim diagrams).

**Trim To End (for Trim Mode):** Infinite—when this box is checked, the last Trim value of the control during an automation pass will be written to the end of the project. This operates independently of the setting of Auto Revert.

**Control Sense Timeout** In the case of non touch-sensitive controls, revert starts when the CONTROL SENSE TIMEOUT has expired without movement of the control. This feature allows controls to respond as if they were touch-sensitive even though they are not.

**Control Sense Time** Adjusts the time for the Control Sense Timeout.

**Initial Event Ramp Time** This parameter determines the transition time between a new Initial Status and previous Dynamic data when editing the initial status; very much like a time-reversed version of Revert Time.

**Auto Fade Time** Sets the duration of an Auto Fade from 0.5s to 120s in 0.1 second increments.

**Library Transition Time** The amount of time it takes for controllers to move from their current state to the new settings of a just recalled library preset.

**Event Density** Determines the events per second recorded during automation, and adjustable in single-frame increments from 1 through 30. The more events that are used to describe a move, the smoother the move is.

## LCD GLOBAL Screen

This screen mirrors the GLOBAL automation tab of the VGA Automation tracks screen. Most of the parameters found on this screen are identical to the parameters found in the VGA Global automation tab and are explained on the previous pages. Only those parameters that are unique to this LCD screen are explained here.

From the **MAIN DISPLAY MODES** section, press **AUTOMATION** and then the **GLOBAL** soft key to reach this screen

**SET TO DEFAULT** Returns all parameters in the LCD screen back to their default settings.

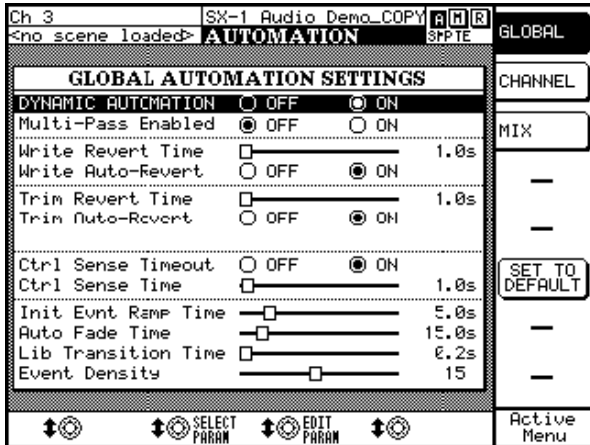

---

### Operations Examples

---

The following examples and explanations are intended to help you better understand the SX-1's automation protocols. In each case of an operation, a

brief explanation is given on how the SX-1's automation engine will respond.

---

#### Writing Mix Moves

Before or after pressing **PLAY**, press **WRITE** (in the **AUTOMATION** section) so that its indicator lights. Perform your desired mix moves.

With the console in Global Write mode, any movement of a control while the transport is in play is written to that control by the automation system. In the case of the touch-sensitive faders, writing begins when a fader is touched. In the case of soft knobs, writing will begin when the control is moved. Once dynamic mix moves have been written to a control, that control is Dynamic, in order to play back the

Dynamic automation. Controls that have not had mix moves written to them remain Static, even if those controls are on the same channel as a control that has had dynamic mix data written to it.

By default all controls are in Auto. When in Auto, the system does the switching between Static and Dynamic transparently to the user. Thus, a control set to Auto that has not had any dynamic mix moves written to is considered to be Static “under the hood” and a control that has dynamic mix moves is considered Dynamic “under the hood”.

---

#### Revert Time

When a control stops recording mix moves, it “reverts” to the setting that existed before recording the move. The previously existing setting could be a dynamic mix move or a static control position. The amount of time it takes to make a smooth match from the end of the recorded mix move to the previously existing setting is called the *Revert Time*.

In the event that the transport is stopped, a Revert Time is applied even past the point where the play-head has stopped, to ensure a smooth transition between the new mix move and the control's previous setting.

## Part IV—Mixer Controls

**Auto Revert Choices** With AUTO REVERT Write (or Trim) enabled, the automation system stops writing mix moves automatically on a per control basis without the need to end writing manually. That is, controls stop writing mix moves at different times, depending on when they were released (faders) or when movement ended (soft knob controls).

In the case of touch-sensitive faders, reverting begins when the fader is released. In the case of soft knob controls, reverting begins when the CONTROL SENSE TIMEOUT has expired without the control being moved. CONTROL SENSE TIMEOUT allows the soft knob

controls to respond as if they are touch-sensitive (even though they are not).

When a Revert occurs, the control smoothly matches back to its previous value, based on the set value of the Revert Time. The previous control value could be a control's Static position or a control's Dynamic mix moves.

Below is an example of writing a fader move over a previous static fader position with Auto Revert enabled:

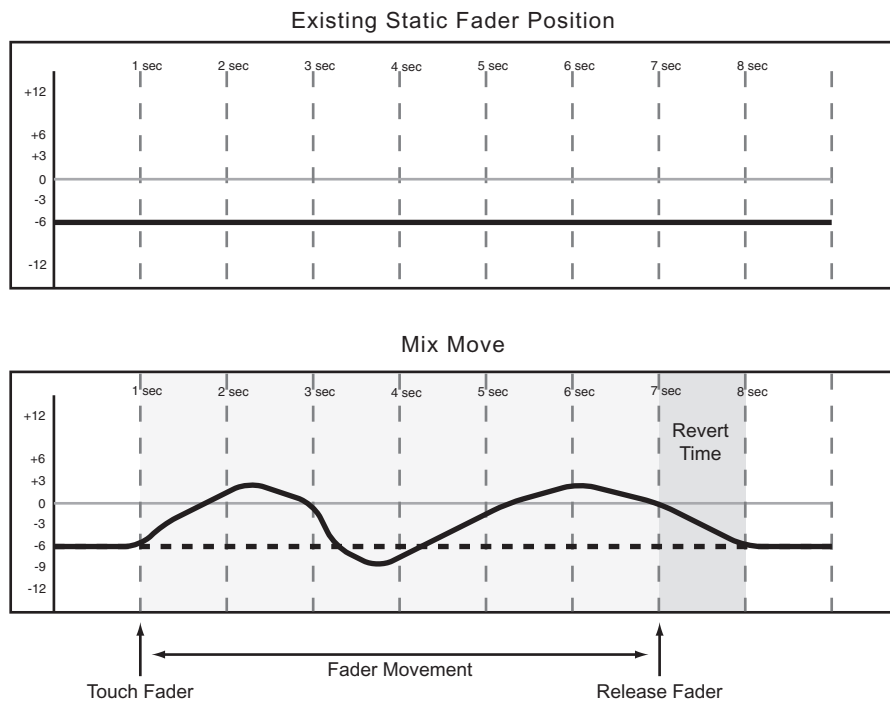

Below is an example of writing a soft knob (labeled POD) move over a previous static position with Auto Revert enabled:

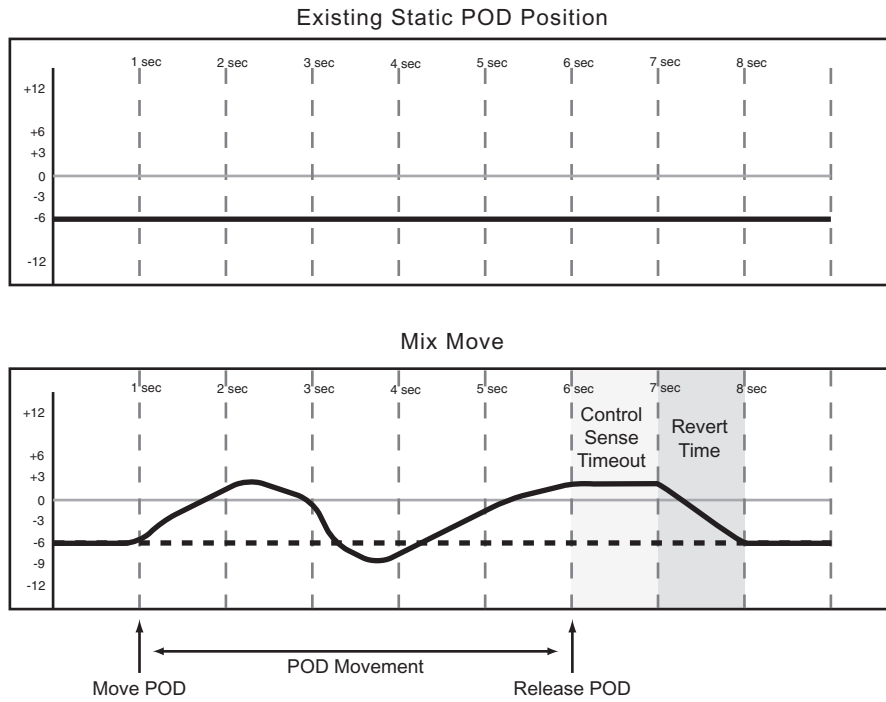

Below is an example of writing a new fader move over a previous Dynamic fader move with Auto Revert enabled:

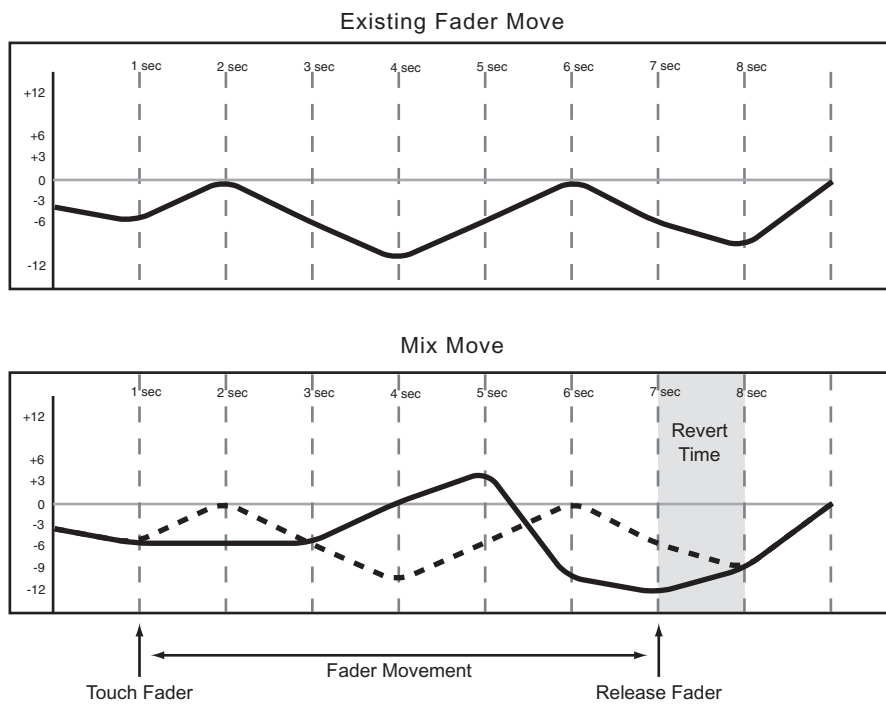

## Part IV–Mixer Controls

This is an example of writing a new soft knob (labeled POD) move over a previous Dynamic soft knob move with Auto Revert enabled:

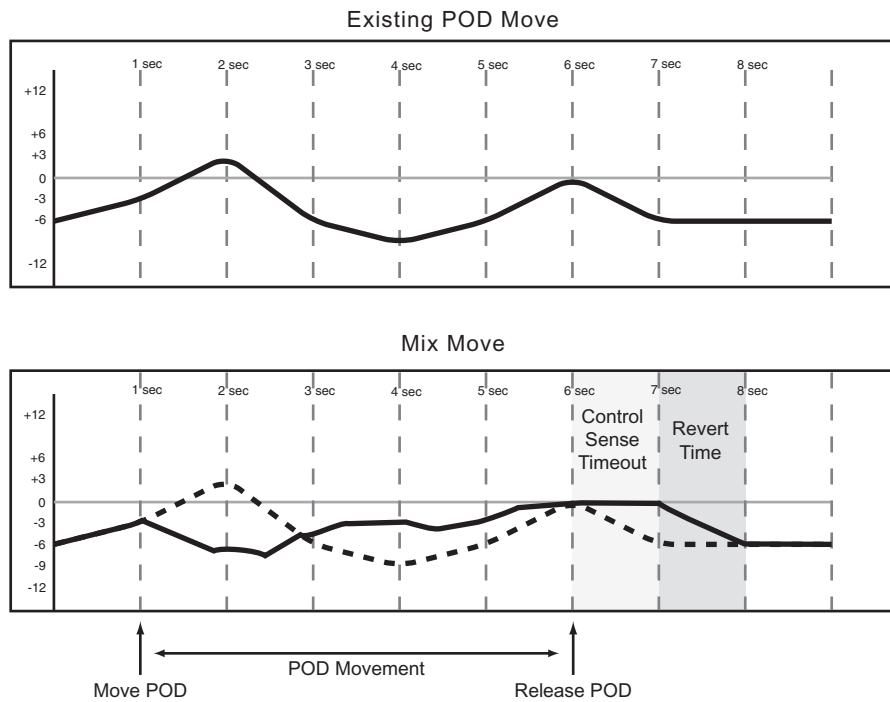

**Disabling Auto Revert** allows you to manually stop writing mix moves, either by stopping the transport, or by pressing the **REVERT/ AUTO FADE** key. In this situation, all controls that are writing mix moves will stop writing simultaneously when **REVERT/ AUTO FADE** is pressed or play stops.

When a Revert is triggered by pressing **STOP**, the Revert Time is still applied to the control beyond where the playhead stops, for a smooth match from the end of the new mix move to the control's previous setting.

Below is an example of writing a new fader move over a previous Static fader position with Auto Revert disabled:

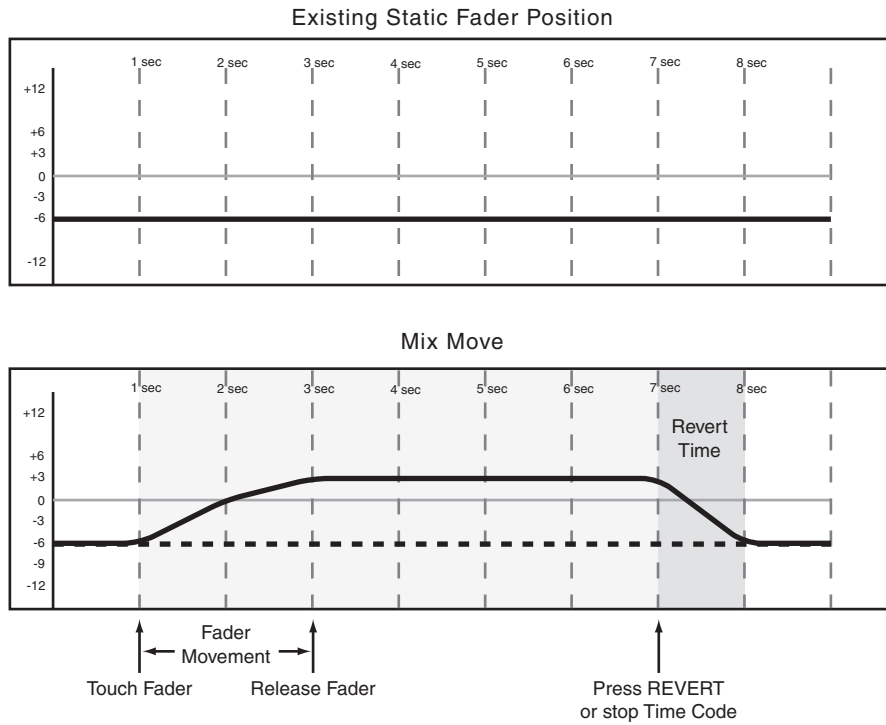

Below is an example of writing a new fader move over previous Dynamic fader moves with Auto Revert disabled:

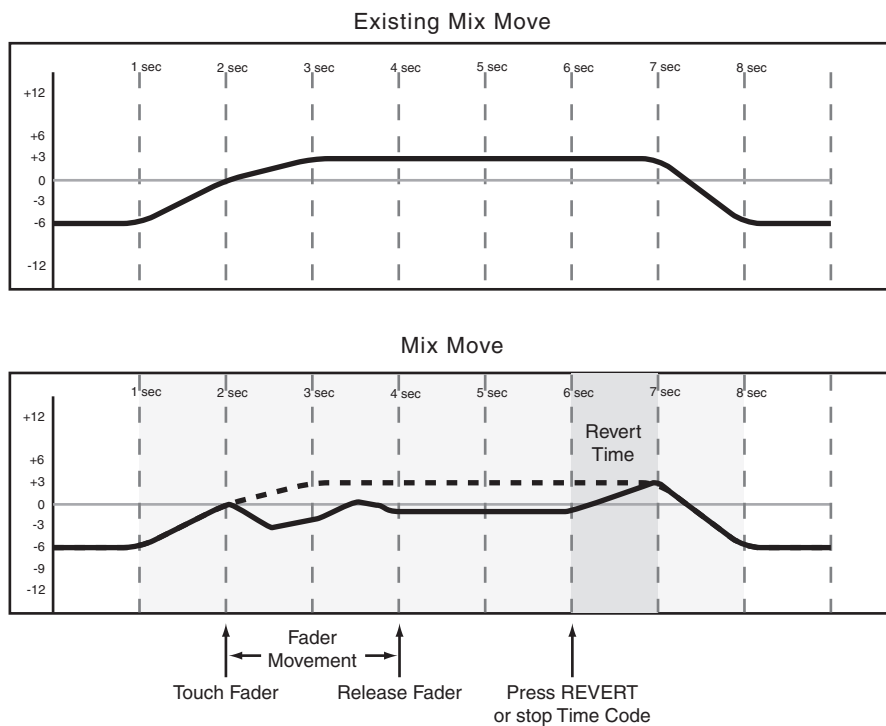

## Part IV—Mixer Controls

**Write to End** When the Infinite checkbox is checked (VGA), or the Write Revert Time is set to Inf. (LCD), you are essentially telling the automation system to maintain a control's last setting from the point where the automation recording ends, all the way to the end of the program. This is called Write to

End. In this case, any mix moves existing in the time between the end of automation recording and the end of the program will be erased.

Below is an example of a Write to End operation over previous Dynamic fader moves:

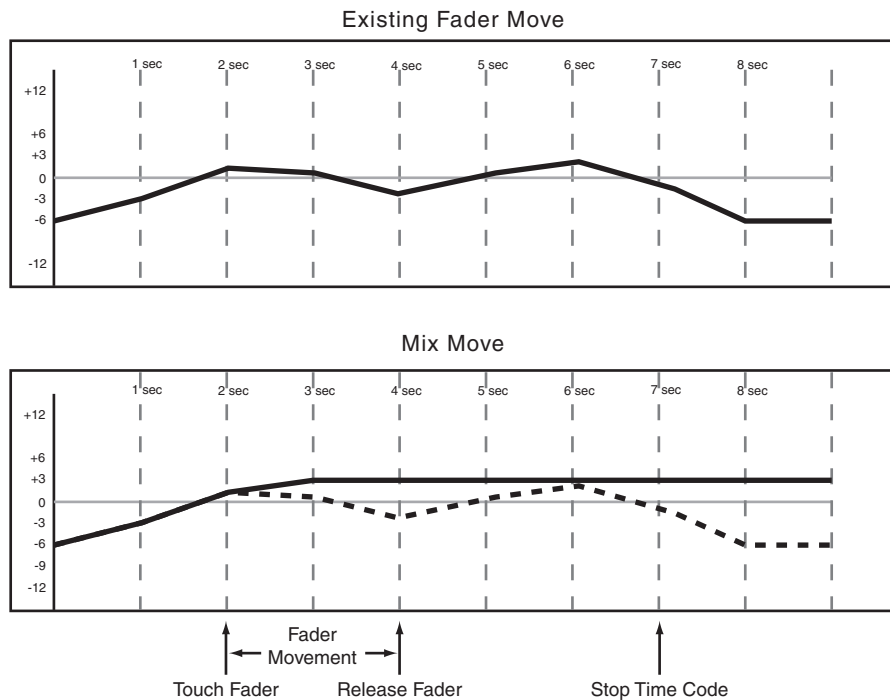

### Writing Switch Events

Switch Events are defined as the switching of any “on/off” controls or library recall events. Examples of such controls are **MUTE** and soft keys.

Before or after pressing **PLAY**, press **WRITE** (in the **AUTOMATION** section) so that its indicator lights. With the SX-1 in play, press the desired key or keys to write the switch event at the desired locations. This works for switches such as mutes, EQ On/Off, EQ band types, Dynamics On/Off, Dynamic Makeup gain, Auxiliary send Pre/Post, Buss assignments, and Library Recall. With Write or Trim mode enabled, Moves can be made by using the mouse to click on

items in the VGA Channel screens, via the soft keys of the LCD MIXER CHANNEL screen, or the front panel's keys and knobs.

Switch events can be written in Write or Trim mode with the same results. Once a switch event has been written to a control, the automation system automatically changes that control from Static to Dynamic, in order to read mix moves. Controls that have not had switch events written remain in Static, even if those controls are on the same channel as a control that has had other mix data written to it.

### Revert Time

Because switch events do not generate continuous data like fader moves, there is no need to make a smooth match to previous data. Consequently, adjusting the Revert Time has no effect on writing switch events.

**CONTROL SENSE TIME OUT & Switch Events** The SX-1's faders are touch-sensitive, so the automation system knows when you have touched or released a fader. However, keys are not touch-sensitive. These controls simply write a switch event (with Write or Trim mode enabled) whenever they are pressed. Control Sense Time Out allows these keys to punch out of automation writing automati-



cally, after the specified amount of time has passed without being pressed. This field can be set from 0.5 seconds to 10 seconds in 0.5 second increments.

**Auto Revert Choices** With Auto Revert Write (or Trim) enabled, the automation system stops writing (or trimming) switch events automatically on a per control basis without the need to end writing manually. That is, keys stop recording switch events at different times, depending on when they were last pressed and depending on the Control Sense Time Out value.

In the case of control surface keys and knobs, writing ends when the Control Sense Time Out has expired without a key press or knob turn. Control Sense Time Out allows the control surface keys to respond as if they are touch-sensitive, even though they are not.

Writing switch events over a Static switch position simply adds the new switch events. When writing new switch events over previous ones, the SX-1 automation system provides you with a high degree of flexibility over when writing will end.

Below is an example of writing new switch events over previous switch events with Auto Revert enabled:

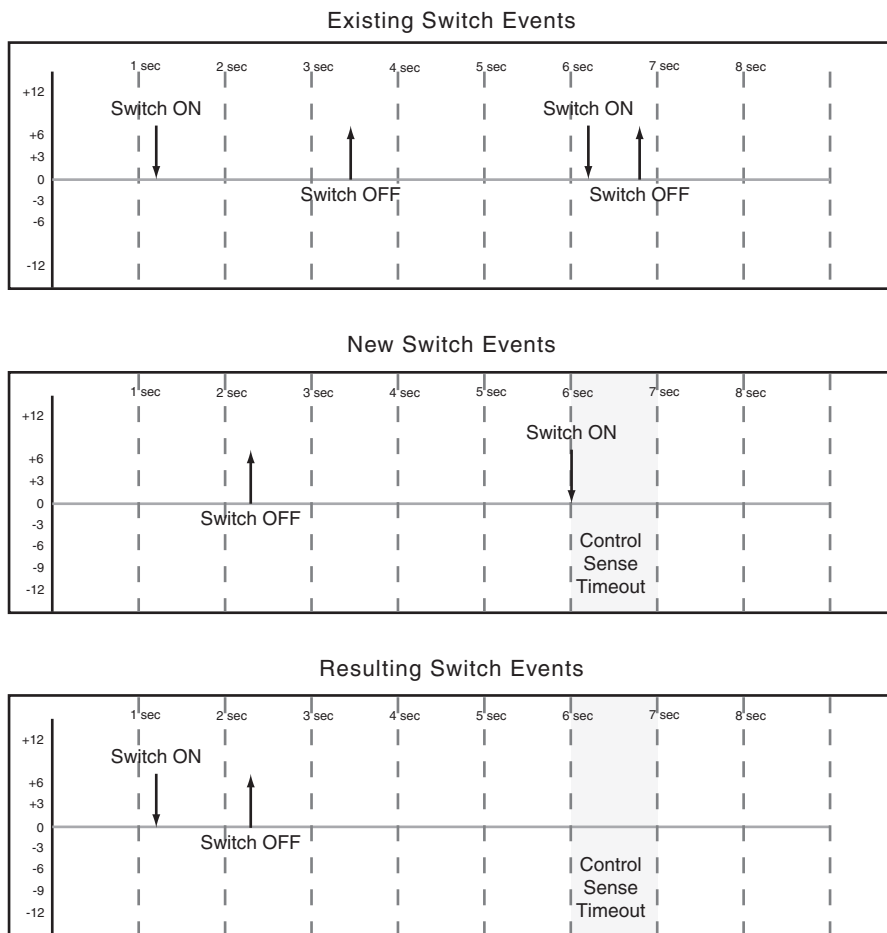

## Part IV—Mixer Controls

**Disabling Auto Revert** allows you to manually stop writing switch events, either by stopping the transport, or by pressing the **REVERT/ AUTO FADE** key. In this situation, all controls that are writing will

stop writing simultaneously when **REVERT/ AUTO FADE** is pressed or play stops.

Below is an example of Writing new switch events over previous switch events with Auto Revert disabled:

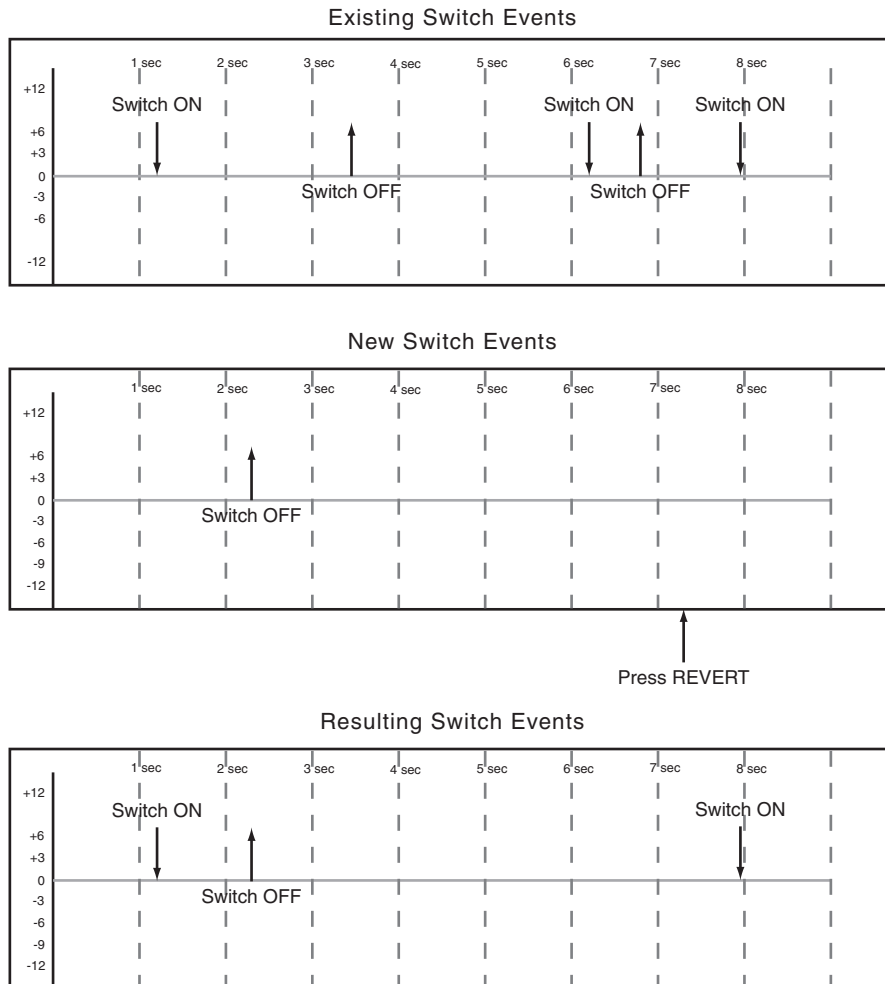

### Disabling Control Sense Timeout

Control Sense Timeout is a subset of Auto Revert in that it only affects non touch-sensitive controls. By disabling Control Sense Timeout, it is possible to begin writing on a switch or rotary encoder and have that control continue writing, while new fader moves are performed with Auto Revert. It is necessary to

manually revert controls that begin writing with Control Sense Timeout disabled.

It is possible to enable or disable Control Sense Timeout on a single mix pass for flexibility in ending the write in the same way that Auto Revert can be enabled or disabled on a single mix pass.

### Trimming Mix Moves

There may be times when a control has existing mix moves that are good, but the overall level of those moves needs to be raised or lowered. In this situation, Trim is used to offset existing moves.

Before or after pressing **PLAY**, press **TRIM** (in the **AUTOMATION** section) so that its indicator lights. Perform your desired Trim operation.

With the mixer in Trim mode, any movement of a control while timecode is running performs a Trim

operation on that control. The audio passing through the control reflects the previous mix moves, combined with the offset created by the Trim operation.

In the case of the touch-sensitive faders, trimming begins when a fader is touched. In the case of keys and knobs, trimming begins when the control is moved.

## Revert Time

When a control stops trimming mix moves it “reverts” to reading any mix data that existed before trimming began. The previously existing data could be a dynamic mix move or a static control position. The amount of time it takes to move smoothly from the end of the trimmed mix move to the previously existing data is called the *Revert Time*.

A Revert Time is applied, even after stopping playback, past the point where the playhead stops, to ensure a smooth transition between the trimmed mix move and the control’s previous setting.

**Auto Revert Choices** With AUTO REVERT Trim enabled, the automation system stops writing trimming mix moves automatically per control without the need to stop trimming manually. That is, controls stop trimming mix moves at different times, depend-

ing on when they were released (faders) or when movement ended (keys and knobs).

In the case of the touch-sensitive faders, the revert starts when the fader is released. In the case of keys and soft knobs, revert starts when the Control Sense Time Out has expired without movement of the control. Control Sense Time Out allows the control surface keys and knobs to respond as if they are touch-sensitive, even though they are not.

When a Revert occurs, the control smoothly matches back to its previous data based on the amount of Revert Time set. Previous data could be a control’s Static position or a control’s Dynamic mix moves.

Below is an example of trimming fader moves with Auto Revert enabled:

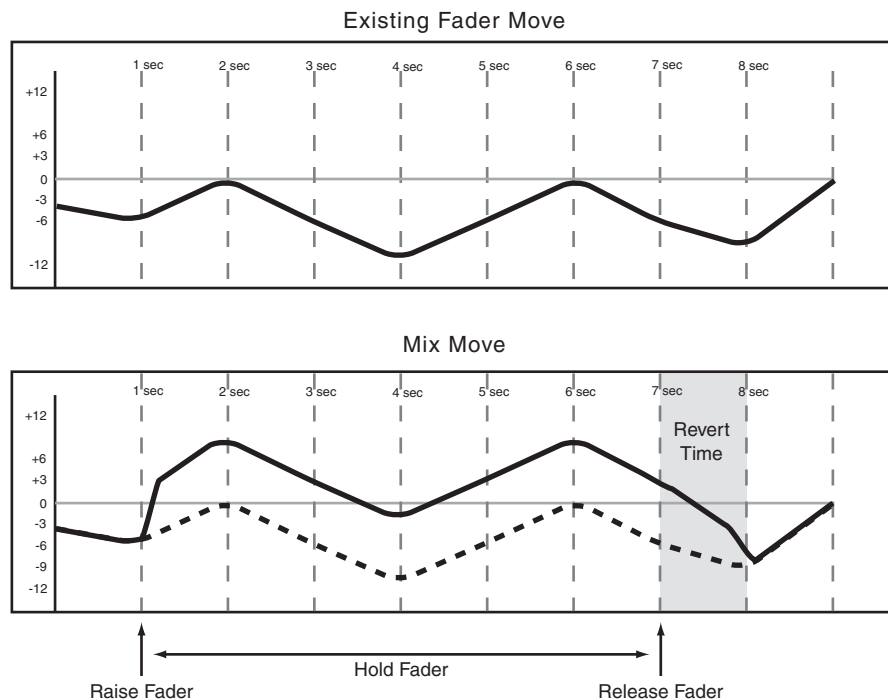

## Part IV—Mixer Controls

**Disabling AUTO REVERT** when TRIM is enabled, this allows you to manually stop trimming mix moves by stopping play or by pressing the **REVERT/ AUTO FADE** key. In this situation, all controls that are trimming mix moves will stop trimming

simultaneously when **REVERT/ AUTO FADE** is pressed or playback stops.

Below is an example of trimming fader moves with Auto Revert disabled:

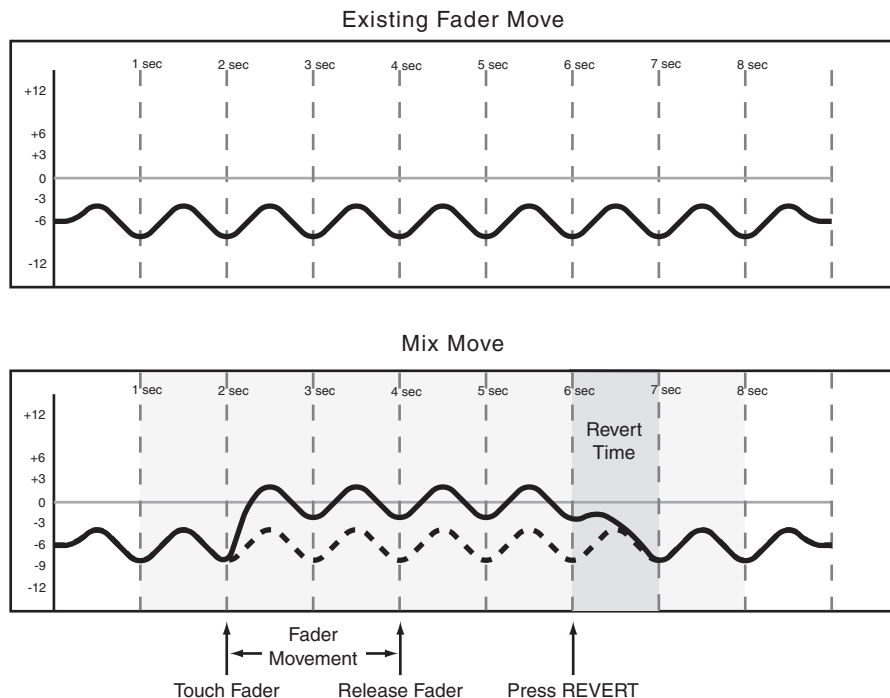

---

## Automating Library Recall

---

The SX-1 automation system is capable of including library recall events as part of an automated mix. These are treated by the automation system as Switch Events. All SX-1 libraries support automated recall for: Scene, EQ, Compression, Expanders, Gates, and the plug-in effects.

Because there may be differences between control settings recalled by a library and those being played

back by the automation system, below are some important things to keep in mind in order to avoid unexpected behavior.

The basic rule is that automation data, whether a library recall or a dynamic mix move, only has priority until another mix event is played back.

---

## Writing Library Recall Events Over Existing Static Control Positions

---

When a library recall event is written by the automation system which affects controls in Static, those controls become Dynamic. This ensures correct control position when locating the transport to a position prior to the first library recall event. This also means that if those controls need to be adjusted, INIT EDIT or Global Write must be used. If a dynamic move is written after a library recall, the control will Revert

to the setting determined by the control's Initial Status, which may differ from the library recall immediately preceding the dynamic move.

If a library is recalled which affects controls in Static mode without the library recall event being written, the controls will update their static positions as if they had been directly adjusted.

---

## Combining Library Recall With Dynamic Mix Moves

Dynamic mix moves are treated in a way similar to continuous data by the SX-1 automation system. Library recall events are instantaneous scenes. If a library recall occurs while the automation system is reading dynamic mix moves, the affected controls

will snap to the positions recalled by the library then snap to reading previous dynamic mix moves as the time code position crosses the previous data. While this can create some interesting effects when used purposely, it could also take you by surprise.

---

## Automating Groups

There are several considerations and possibilities when using the SX-1 automation with grouped controls:

- Creating a group with controls that don't have dynamic automation.
- Creating a group with controls that have existing dynamic automation.
- Automating the Group Master.
- Automating group slaves.
- Removing slaves from an automated group.

**Grouping Non-Automated Controls** Create the group normally using the Groups module on the Channel screen. The group master or slaves within the group may then be automated. A Group Master may be automated just like any other control.

Automation data is only written by the Group Master. Any group slave that is removed from a group no longer follows any mix moves written by the Group Master. However, it continues to read its own mix moves. Any group slave may be individually automated just like any other control.

**Grouping Automated Controls** If a group is created where any single control contains dynamic data, all like controls within that group will switch to dynamic, requiring further moves on those controls to be dynamically written (or modified using Init Edit) instead of being statically adjusted.

### NOTE

*When automating group slaves while the group master is moving, an incorrect revert destination on the slave control is possible. To avoid this, write dynamic moves on slaves between occurrences of dynamic moves on the slave's master.*

## Chapter 14 – Working with Effects

### The Philosophy – how it works

The SX-1 has four slots in which to load effects, named *quadrants*. Each quadrant is capable of loading any of the effects that come with the SX-1. The list of included effects includes delays, choruses, compressors, distortion, microphone and speaker simulation and reverb. In most cases the SX-1 has the ability to run four discreet versions of any of these plugins, reverb being the most obvious exception (you can run two TC Reverbs at once, along with two other plugins of your choice).

Each effect comes with presets that allow you to use them more easily, and these presets can be recalled at any time. Double-clicking on a preset in the list will load that effect’s parent into the current quadrant, which means that double-clicking on the Metallic Tone preset will automatically load the Flanger plugin.

All of the parameters for the effects are available for automation, both in real time as well as being drawn onscreen.

### VGA Effects Screens

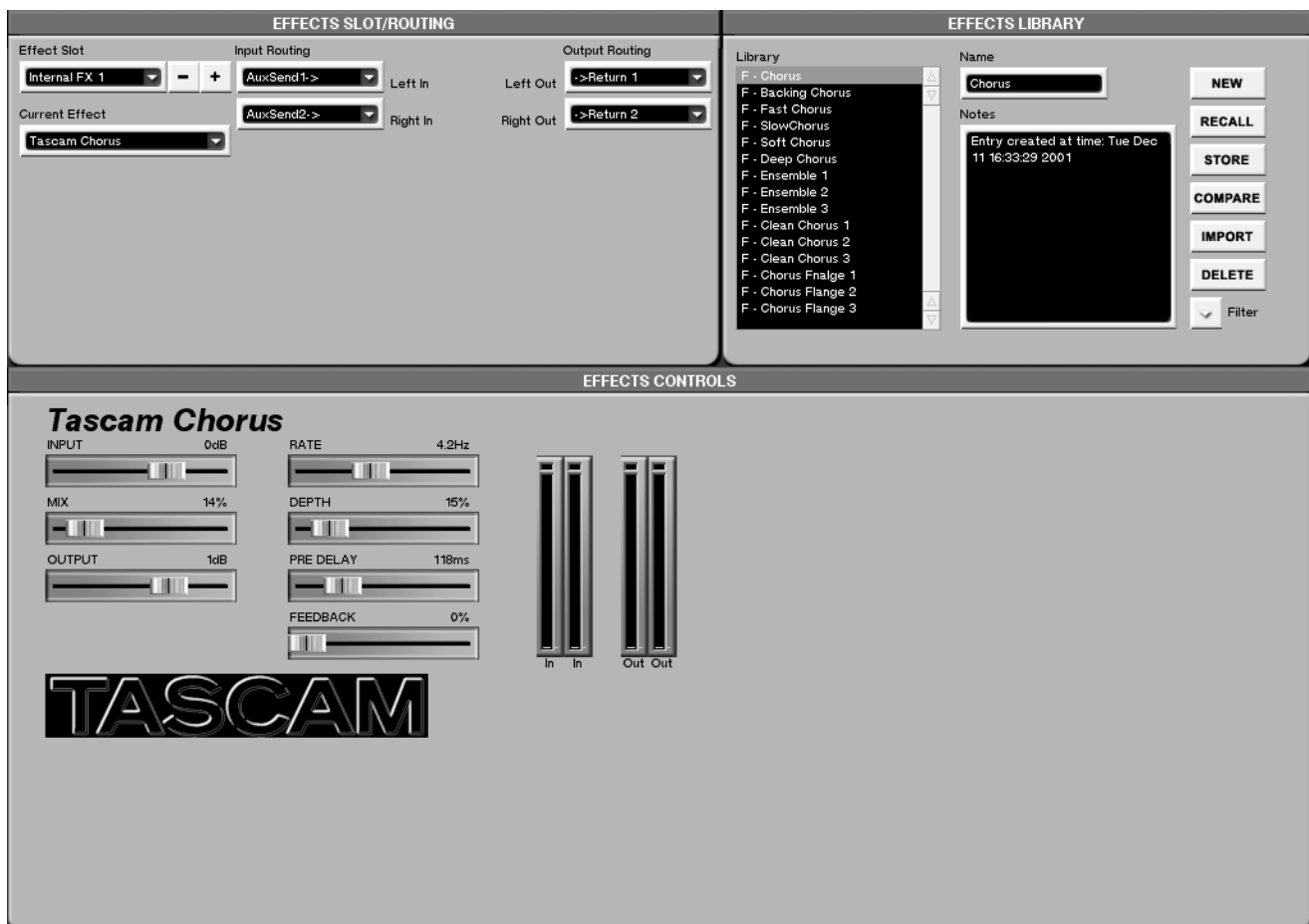

From the **MAIN DISPLAY MODES** section, press **EFFECTS**. This takes you to the main VGA effects control screen. From here you can assign effects to one of the four effect busses, save and recall effects

to the effects library feature, and change individual effect parameters (individual effect algorithms are covered in the next chapter).

## Routing Effects Screens

The effects routing displays let you select, configure, and route the effects plugins.

### VGA EFFECTS SLOT/ROUTING Module

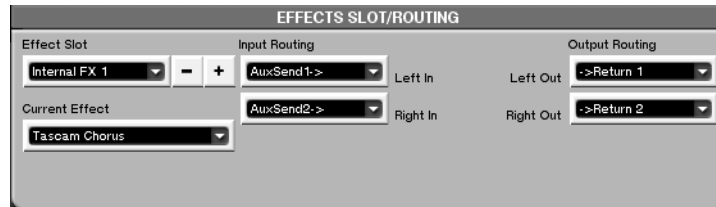

This module is part of the Effects screen. It houses the controls for assigning the effects algorithms to the processor slots, and routing the audio inputs and outputs.

**Effect Slot** Selects the placement of the effect algorithm in the DSP chain. The selections are:

**Internal FX 1-4** The four available native DSP quadrants.

**Current Effect** Selects an effect algorithm.

**Input Routing** Click on the arrow for the Left In and Right In fields to select the input source for the effect displayed in the Current Effect field.

**Output Routing** Click on the arrow for the Left Out and Right Out fields to select the output destination for the effect displayed in the Current Effect field.

### LCD Effects Routing Screen

The LCD Effects screens mirror the VGA Effects screen.

**EFFECTS** The EFFECTS screen’s ROUTING page houses controls for assigning the effect algorithms to a DSP quadrant, the effect algorithm’s input source, and output destination.

From the **MAIN DISPLAY MODES** section, press **EFFECTS**.

The ROUTING CURSOR soft knob can be used to select the routing node, and SELECT ROUTING is used to bring up all possible destinations for the routing.

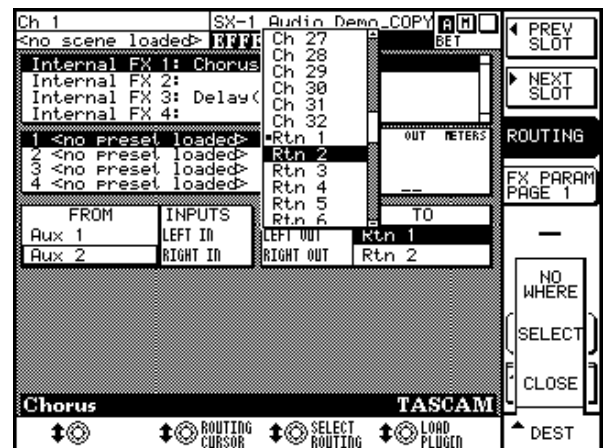
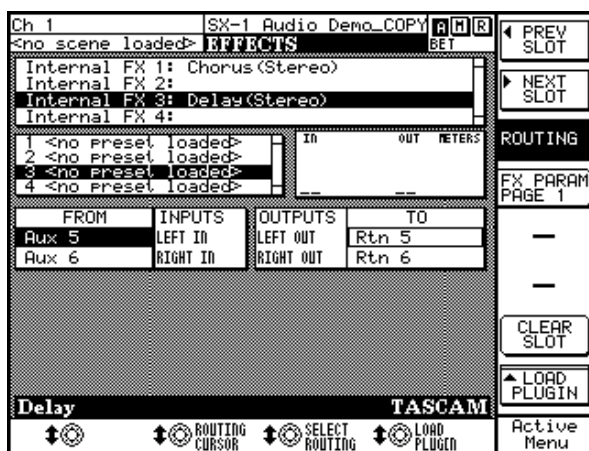

**PREV SLOT** Skips back to select the previous effects slot.

**NEXT SLOT** Skips forward to select the next effects slot.

**ROUTING** This screen’s default page.

**CLEAR SLOT** Removes the effect algorithm from the currently selected slot.

## Part V—Effects

**LOAD PLUGIN** Pressing the LOAD PLUGIN soft key opens a dialog where you select from a menu of effects algorithms.

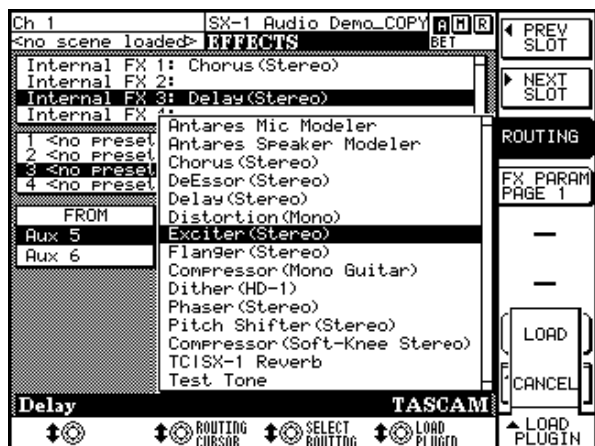

### TIP

You can use the arrow keys on the keypad to step through the effects plugins. Then, with the one you want to load highlighted, press **ENTER** to load the plugin to the selected slot.

## Effects Controls Displays

The effects controls screens house the effect plugin's parameters.

The controls that appear in these screens change according to the effect plugin selected.

### VGA EFFECTS CONTROLS Screen

The EFFECTS CONTROLS module is part of the Effects VGA screen. From the **MAIN DISPLAY MODE** section, press **EFFECTS**.

Below is an example of the module with a chorus effect selected in the EFFECT SLOT module (the EFFECTS CONTROLS module follows the effects selection in the EFFECT SLOT module).

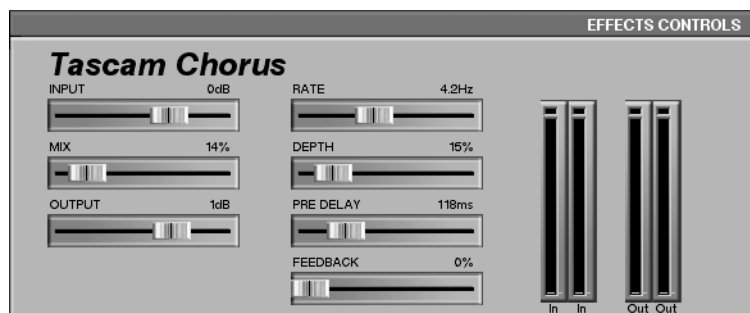

### TIP

When you turn the LCD screen's soft knobs that are tied to the parameters in the EFFECTS CONTROLS module, these controls reflect the soft knobs' movements. You can also use the mouse to directly move the EFFECTS CONTROLS.

### LCD EFFECTS Control Screen

This screen mirrors the VGA EFFECTS CONTROL module. Like the controls of the EFFECTS CONTROL module,



the LCD EFFECTS screen’s controls change according to the selected plugin.

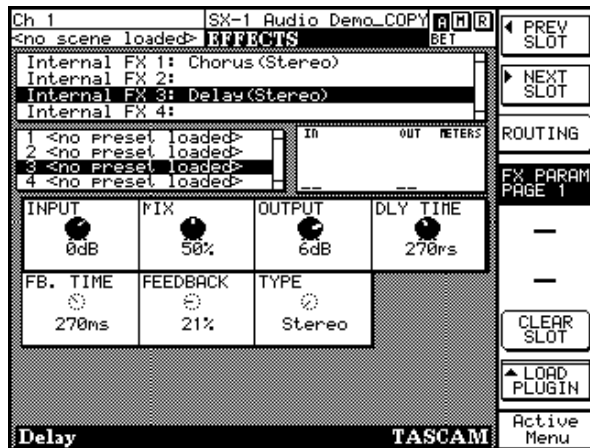

From the **MAIN DISPLAY MODES** section, press **EFFECTS**. Then press FX PARAM PAGE 1 to reach the first page of the effects parameters.

**PREV SLOT** Skips back to select the previous effects slot.

**NEXT SLOT** Skips forward to select the next effects slot.

**ROUTING** Opens the EFFECTS screen’s routing page (the default page for this screen).

**FX PARAM PAGE 1** Since the LCD has limited space, the screen cannot show all effect parameters at the same time. The FX Params Pages let you skip forward and back through the selected effect plugin’s controls.

**TIP**

To record automation for an effect plugin from the LCD, use the LCD screen’s soft knobs for the selected effect.

## Effects Library Displays

Every effect plugin can have its settings saved as a patch in the Effects Library. A single plugin may have dozens of associated presets. Most plugins

come with a set of factory presets—if not, you can always create your own.

### VGA EFFECTS LIBRARY Screen

The EFFECTS LIBRARY module is part of the Effects VGA screen. In this module you can name, store, and recall effect plugin patches.

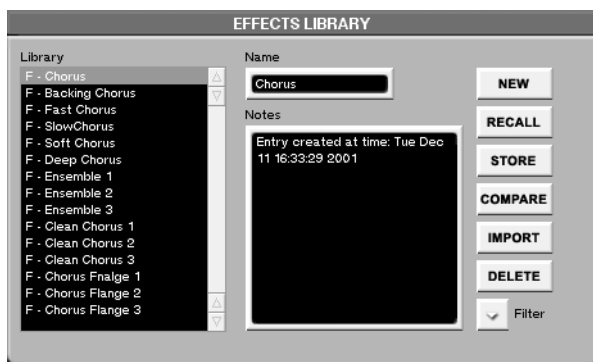

**COMPARE** Press this key to compare the current settings of a selected plugin with the last saved settings of that same plugin.

**IMPORT** Opens the Effect Plugin Import dialog where you can bring effect plugin presets from other projects into your current project.

**Filter** This feature allows you to view effect presets by category—either generic effect type or specific effect plugin. For example, if you are just looking for reverbs, select view only reverb patches. Or if you only want to see the patches associated with a particular effect plugin (such as TASCAM Chorus, as in the screenshot here), select to filter out all other plugin presets.

**TIP**

The recall of effects presets can be automated. See “Automating Library Recall” on page 104 for details.

## LCD FX LIBRARY Screens

The FX LIBRARY screens mirror the EFFECTS LIBRARY module found in the VGA Effects screen.

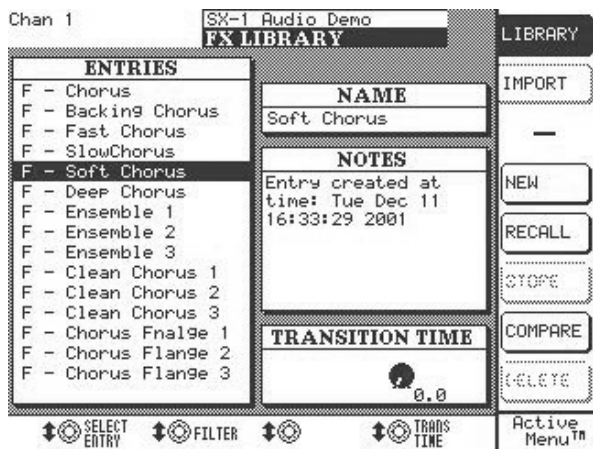

Press the **FX** key in the **LIBRARY** section and then press the **LIBRARY** soft key to reach this screen.

**TRANS TIME** The amount of time it takes to move from the current effect settings to a setting that has just been recalled.

**IMPORT** From the FX LIBRARY screen, press the **IMPORT** soft key. This opens the Import dialog where you can bring effect plugin presets from other projects into your current project.

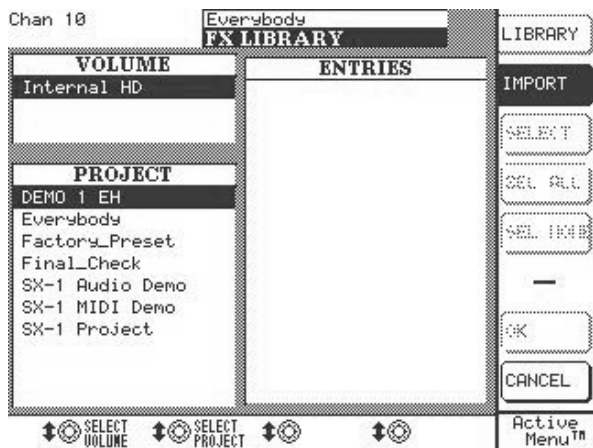

**FILTER** This feature allows you to view effect presets by category, either generic effect type or specific effect plugin.

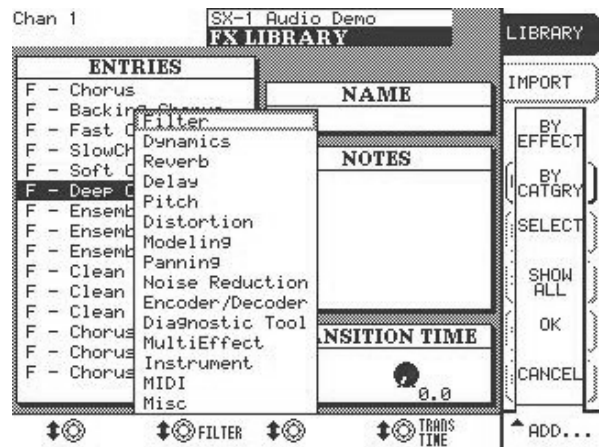

Turn the soft knob below **FILTER** to reach these dialogs.

**BY EFFECT** View presets only by effect plugin type.

**BY CATEGORY** View presets only by effect algorithm type.

**SHOW ALL** View all effect presets.

## Routing Effect Examples

Below are step by step instructions for patching an effect plugin into your mix. Both routing a plugin to

Aux Sends and Returns and inserting directly on a channel are covered.

### Aux Send & Return

- 1 Go to the **VGA Effects** screen and add a **TC Reverb** on **quadrant 1** (the **Effect Slot** field).
- 2 Using the **Input Routing** field to the right of the **Effect Slot** field, select **Aux Send 1** as the left input. Select **Aux Send 2** as the right input.
- 3 Using the **Output Routing** field, send the reverb's left output to **Return 1**, and the reverb's right output to **Return 2**.
- 4 On the **Mixer** screen, select the **Return/Group Fader Bank** (press **MIXER** from the **MAIN**

**DISPLAY MODE**, then press **RTN/ GRP** in the **LCD ACCESS** section) and make sure that **Returns 1 and 2** are assigned to the **L/R Buss**. If they are not linked, press the **Link** key on either return channel.

- 5 Select the **fader bank** for a channel that has **audio playing back**, and raise the level on **Aux sends 1 and 2** until you can hear the reverb. That's it—repeat these steps to assign an effect to the other quadrants.

### Inserting an Effect

- 1 Go to the **VGA Effects** screen and add a **TC Reverb** on **quadrant 1** (the **Effect Slot** field).
- 2 Go to the **VGA Routing** screen and select the **Insert Preset** tab. In the **User Name** field for **Insert 1**, type in the name **Reverb**. Use the **PS/2** keyboard to enter the text and then press **[RETURN]**.
- 3 From the **Insert Send** pull down menu for **Insert 1**, select **Effect/TC Reverb Left In**.
- 4 From the **Insert Receive** pull down menu for **Insert 1**, select **Effect/TC Reverb Left Out**.
- 5 Go to the **VGA Mixer** screen, and right-click on the **FX INSERT** key of the channel you want to use. From the menu that appears, select **Insert 1 (Reverb)** as the insert you would like to use.
- 6 Left-click on the **Insert FX INSERT** to enable **Insert 1**. You should now hear the **TC Reverb** on the inserted channel when you press **PLAY**. That's it—repeat these steps to insert an effect on other channels.

# Chapter 15 – Examples of Effect Algorithms

---

## Categories

---

The SX-1 comes stock with over 15 native plugin effects. Below is a list of these effects grouped by category:

### Distortion

- Tascam Distortion

### Dynamics

- Tascam Guitar Compressor
- Tascam Soft-knee
- Compressor
- Tascam DeEssor

### Enhancer

- Tascam Exciter

### Modeling

- Antares Mic Modeler

- Antares Speaker Modeler

### Modulation

- Tascam Chorus
- Tascam Delay
- Tascam Phaser
- Tascam Flanger

### Pitch Shift

- Tascam Pitch Shifter

### Reverb

- TC SX-1 Reverb

### Utilities

- Tascam/Nemesys HD1 Dither
- Tascam Test Tone

---

## Common Effect Parameters

---

There are several effect parameters which are common to many of the plugins. How these controls operate are always identical, even if the parameters which they adjust, or select, are different.

### TIP

*Describing the common effect parameters here means that not every parameter is explained for all effects. If you are looking at an VGA or LCD effect screen and don't see all the items explained next to the manual's illustration, the missing controls are probably explained here.*

**Input** This controls the input level going to the effect plugin.

**Mix** This controls the wet-to-dry mix ratio of the effect. If you are using the effect on a Return, start with this value at 100% to avoid phasing.

**Output** This controls the output level coming from the effect plugin.

**L/R Balance** This controls the left-to-right balance of the effect plugin's output.

**COMPARE** Press this key to compare your current settings with your last saved settings.

**BYPASS** Press this key to bypass the effect. In the case of an insert, the source signal will pass through the plugin without being effected (remaining completely dry).

## Examples

Since many of the SX-1's effects are recording studio standards (such as, chorus, distortion, delay, etc.), not all of the plugins are explained here. If you are unfamiliar with such standard types of effects, you should

refer to an introductory handbook on engineering. What are explained on the following pages are the SX-1's plugins.

## Antares Mic Modeler

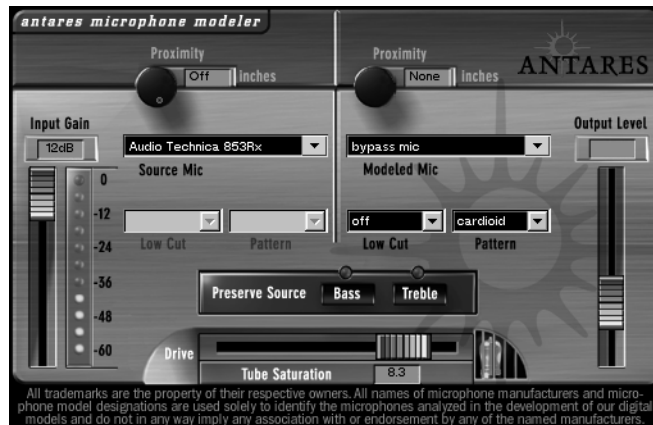

Antares Audio Technologies has created precise digital models of a wide variety of microphones using their patented Spectral Shaping Tool™ technology. TASCAM has licensed their popular Mic Modeler plugin, which is based on this technology, for the SX-1. With this plugin assigned to one of the SX-1's four effect quadrants (and properly routed), you can simply tell Mic Modeler what microphone you are actually recording with and what microphone you would like it to sound like. You can easily turn an inexpensive dynamic mic into an expensive sounding condenser, or *vice versa*.

Not only do the modeling choices reproduce all of the subtle sonic characteristics that make each microphone unique, but they also give you control of each mic's specific options and recording characteristics: low cut filter, wind screen, and placement. Each option produces the same sonic effect that it would have with the actual modeled mic. And for that final touch of perfection, you can even add some tasty tube saturation.

### TIP

*With Mic Modeler, you can record each track through a model of the specific mic that will best produce the ideal sound you're looking for. You can also use it during mixdown to change the perceived mic sound on an already recorded track.*

**Signal Flow** Mic Modeler is divided into a number of discreet functional blocks as follows (in the order of signal flow):

**Input** For setting the input level of the audio to be processed.

**Source Mic** For indicating the mic (and the state of its various parameters) that was actually used to record the audio.

**Modeled Mic** For selecting the mic (and the state of its various parameters) whose sound you would like to model.

**Tube Saturation** For adding a model of analog tube saturation distortion.

**Input Section** The Input Gain slider is used to set the level of the incoming audio. The exact amount of gain or attenuation is displayed numerically above the slider. In most instances, the input gain should be set at the highest level that does not cause the 0 dB "LED" of the graphic level meter to light.

**Level Meter** The Level Meter displays the level of the audio as it is being processed by both the Source and Modeled Mic models. Because some models (or combinations of models) can result in increased amplitude at various frequencies, changing to a different mic model or changing a model's settings may

require an adjustment of the Input Gain to avoid clipping. In practice, you should start out by setting the Input Gain at a bit under the optimum level. Once you're confident that you've found the right mic settings for your track, you should go back and fine tune the gain for maximum level without clipping.

---

**Source Mic Section** The Source Mic section is where you specify the mic and the settings that were (or will be) used to capture the input sound. The purpose of these selections is to remove the effect of the source microphone, resulting in the signal that would have been recorded by an ideal instrumentation microphone with no proximity effect.

**Source Mic Menu** The Source Mic pop-up menu is used to select a specific model of mic. In some cases a mic will have a second listing with (w) appended to the mic's name. This indicates that the mic that was modeled was supplied with a windscreen and this is the model of the mic with the windscreen attached. If your audio was captured using the windscreen, you should select this version of the model.

The menu also offers a selection called Bypass. With Bypass selected, the source signal is passed unmodified to the Modeled Mic section. You should select Bypass when your source was not recorded with a microphone (such as a guitar via direct box or a direct synth input). If your desired mic is not listed in the menu, you can try one of the following (in order of preference):

- 1) Use a different mic that is listed—this is, of course, only an option if you've not yet recorded the audio and do, in fact, have another listed mic.
- 2) Select another mic on the list whose characteristics are known to be similar to your mic (a similar model from the same manufacturer, for example).
- 3) Select another mic of the same general type as your mic (such as, dynamic, large diaphragm condenser, etc.).
- 4) Select Bypass from the menu. It must be stressed that selecting option 2, 3, or especially, 4, will compromise the Microphone Modeler's ability to accurately reproduce the sound of the desired modeled mic. That's not to say that you won't be able to get something that sounds great, just that it's unlikely to be an accurate simulation of whichever mic you chose in the Modeled Mic section.

**Low-Cut Menu** If the mic you select in the Source Mic menu is equipped with a user-selectable low-cut

filter, the Low-Cut pop-up menu will allow you to select from among the actual filter settings available on that mic. (If the selected mic does not have a low-cut filter, the menu will be grayed out.)

If the source mic does include a low-cut filter, select the low-cut setting that was (or will be) used when capturing your audio.

### NOTE

*It is important to keep in mind that the purpose of this setting is to "undo" the effect of any low-cut filter that was used to capture your audio. You may initially think that it's working "backwards" because changing the menu selection from OFF to any filter setting will actually cause a bass boost in the monitored audio. However, the purpose of all the controls in the Source Mic section is to neutralize the effects of the source mic. To do this the model must now boost the bass an equal amount to remove the source mic's sonic coloration.*

**Pattern** If the mic you select in the Source Mic menu is equipped with user-selectable pick-up patterns (e.g., omni, cardioid, hypercardioid, etc.), the Pattern pop-up menu will allow you to select from the actual pattern settings available on that mic. (If the source mic does not have selectable patterns, the menu will be grayed out.)

If the source mic does include multiple patterns, select the pattern that was (or will be) used when capturing your audio.

### TIP

*The purpose of the Pattern selection is to neutralize the varying frequency characteristics that result from each of the available pattern settings, with the assumption that the audio was recorded on axis (i.e. from the front of the microphone). Since the Microphone Modeler has no way of knowing the actual placement of the signal source, it does not attempt to simulate off-axis performance.*

**Proximity** The Proximity knob in the Source Mic section should be used to set the average distance that separated the mic and the signal source during the recording of the audio. The purpose of this control is to allow the model to remove any Proximity Effect that may have been introduced by the source mic.

Mics operating in omnidirectional mode do not exhibit a proximity effect. Consequently, if the source mic is an omni mic, or the source mic has selectable patterns and omni is chosen, the Proximity control will be disabled.

**TIP**

*Proximity Effect* is a boost in bass frequencies resulting from placing a directional mic in close proximity to a signal source. The amount of the effect varies from mic to mic, and is inversely proportional to the distance from the mic to the source (for example, the smaller the distance, the greater the bass boost).

**Modeled Mic Section** Here's where the magic really starts. The Modeled Mic section is where you select the mic (and its settings) whose characteristics you want to apply to your audio.

**Modeled Mic Menu** The Modeled Mic pop-up menu is used to select your desired mic. In some cases a mic will have a second listing with (w) appended to the mic's name. This indicates that the mic modeled was supplied with a windscreen and this is the model of the mic with the windscreen attached. If you wish to simulate the use of the windscreen, you should select this version of the model. Additionally, the menu offers a selection called Bypass. When Bypass is selected, no mic model is applied. The net sonic effect of selecting Bypass here depends on the setting of the Source Mic menu:

- If the correct source mic is selected in the Source Mic menu, and Bypass is selected in the Modeled Mic menu, the final output of the Microphone Modeler will be stripped of the characteristics of the source mic. This results in a signal that would have been recorded by an ideal instrumentation microphone with no proximity effect.
- If Bypass is selected in the Source Mic menu and Bypass is selected in the Modeled Mic menu, the final output of the Microphone Modeler will be identical to the original input signal (with the exception of any added tube saturation).

**Low-Cut Menu** If the mic you select in the Modeled Mic menu is equipped with a user-selectable low-cut filter, the Low-Cut pop-up menu will allow you to select from among the filter settings available on that mic. (If the selected mic does not have a low-cut filter, the menu will be grayed out.) If the modeled mic does include a low-cut filter, selecting a low-cut setting will reproduce the same effect that selecting that setting would have on the actual modeled mic.

**TIP**

The setting labels that appear in the menu are those that appear on the physical mic. In some cases, the label is the cut-off frequency of the low-cut filter as specified

by the mic's manufacturer. However, the Microphone Modeler does not simply apply a generic low-cut filter at the stated frequency, but instead models the actual filter performance of each modeled mic. In other words, a stated cut-off frequency is only as accurate as the filter on the actual mic.

**Pattern** If the mic you select in the Modeled Mic menu is equipped with user-selectable pick-up patterns (e.g., omni, cardioid, hypercardioid, etc.), the Pattern pop-up menu will allow you to select from the actual pattern settings available on that mic. (If the modeled mic does not have selectable patterns, the menu will be grayed out.) If the modeled mic does include multiple patterns, select the pattern whose characteristics produce the effect you desire.

**TIP**

The purpose of the Pattern selection is to model the varying frequency characteristics that result from each of the available pattern settings, with the assumption that the audio was recorded on axis (that is, from the front of the microphone). Since the Microphone Modeler has no way of knowing the actual placement of the signal source, it does not attempt to simulate off-axis performance.

**Proximity** The Proximity knob in the Modeled Mic section can be used to select a desired amount of proximity effect. Using the Proximity knob to set a particular distance will result in the amount of proximity effect that would be produced by the actual modeled mic when placed at that distance from the signal source.

The effect of the Proximity control is unique for each model of microphone. The Microphone Modeler does not use a generalized approximation of proximity effect. Each model reflects the specific physical properties that create the individual proximity effect for that mic.

Mics operating in omnidirectional mode do not exhibit a proximity effect. Consequently, if the modeled mic is an omni mic, or the modeled mic has selectable patterns and omni is chosen, the Proximity control will be disabled.

**NOTE**

A secondary effect of mic-to-source distance is the extent to which environmental ambience is picked up by a mic. For example, as a mic is moved away from the source, the proximity effect decreases, but the amount of "room tone" increases (assuming that you are not in an anechoic chamber). The Microphone Modeler does not model this effect. However, judicious use of the

*Proximity control in combination with some appropriately programmed reverb will allow you to create the same effect, with the additional bonus of being able to control the exact nature of the room tone.*

---

**Preserve Source** The Preserve Source controls allows you to split your audio into its bass and treble ranges and process each range separately. This lets you create hybrid mics that combine the bass characteristics of one mic and the treble characteristics of another. One of the two mics will be your actual source mic and the other can be selected from any of the available models.

Say, for example, that you have a mic whose bass response is great for a particular track, but whose treble response just doesn't sound right. With this feature you can preserve the bass response of your source mic while replacing its treble characteristics with that of any of the modeled mics.

Here's how it works:

- 1 Make all the appropriate settings in the Source Mic section. (Do not select Bypass unless you are going for some special effect, as it will defeat the normal function of this feature).**
- 2 Choose the other mic for your hybrid and make all the appropriate settings in the Modeled Mic section. (Again, do not select Bypass unless you are going for some special effect.)**
- 3) In the Preserve Source section, click on either the Bass or Treble button (its associated "LED" will light) depending on whether you want to preserve the bass or treble characteristics of your source mic.**

**There are four possible states of the two Preserve Source buttons. Here's what each does (☼ = LED lit, ● = LED not lit):**

**Preserve Source: Bass ●, Treble ●** With neither button pressed, frequency splitting does not take place and the Microphone Modeler operates in its normal manner according to the settings in the Source and Modeled Mic sections.

**2) Preserve Source: Bass ☼, Treble ●** With the Bass button pressed, the source mic's bass characteristics are allowed through unchanged while the treble characteristics are neutralized. Then, at the model end, only the model's treble characteristics are applied to the signal. The net effect is that you get the source mic's bass characteristics and the modeled mic's treble characteristics.

**Preserve Source: Bass ●, Treble ☼** This, as you've probably guessed, is the reverse of the previous arrangement. With the Treble button pressed, the source mic's bass characteristics are neutralized while the treble characteristics are allowed through unchanged. Then, at the model end, only the model's bass characteristics are applied to the signal. The net effect is that you get the source mic's treble characteristics and the modeled mic's bass characteristics.

**Preserve Source: Bass ☼, Treble ☼** With both buttons pressed, both the source's bass and treble characteristics are allowed through unchanged and no model is applied to either range. This is equivalent to selecting Bypass in both the Source Mic and Modeled Mic menus, with the exception that the Proximity controls for both the source and modeled mics remain active.

---

**Tube Saturation** The Tube Saturation section is designed to model the distortion that is typical of a high-quality tube pre-amp.

When tube pre-amps are operated in their linear range, there is virtually no signal distortion and their audio qualities are essentially identical to solid state pre-amps. However, it commonly occurs that transients exceed the linear voltage range, resulting in distortion. The distortion characteristics of a vacuum tube pre-amp are vastly different from that of solid state amplifiers and are often described as adding a certain "warmth" to a sound (in contrast to what is often described as the "brittleness" of the solid state sound).

The amount of tube saturation effect applied to your audio is controlled by the Tube Saturation Drive control in combination with the Input Gain control.

The Drive control determines the amplification factor of the modeled tube pre-amp with the numeric display indicating the amplification in dB. At 0 dB, no distortion occurs, even for full amplitude (+1 or -1) signal levels. These levels represent the "rails" of the amplifier. As the Drive is increased, the amplification is increased. Any regions of the signal that increase beyond the rails generate distortion. (But instead of the usual ugly digital clipping, they are distorted the same way the tube pre-amp would distort the sound.)

#### TIP

*If you want to add tube saturation distortion without otherwise affecting your sound, set both the Source Mic and Modeled Mic menus to Bypass.*



**Output Level** The **Output Level** control is used to fine-tune the Microphone Modeler’s output level. This control is strictly an attenuator (i.e., no gain is available). You should always start with it at 0dB (the

top of its range) and then reduce level as necessary. It is particularly useful when adding large amounts of tube saturation.

## Antares Speaker Modeler

More of Antares Audio Technologies’ patented modeling technology is found in the Speaker Modeler plugin (the SX-1 is, we’re proud to say, its debut). This plugin lets you sonically morph one type of studio monitor into a completely different speaker. For example, let’s say you want an audio track to sound like it is coming out of a car stereo; or, perhaps you just need to hear what your entire mix would sound like out of a TV speaker. This plugin will help you achieve these effects. Its uses range from creative sound effects (when inserted on a channel or fed an

aux send) to simulating different sound systems during reference monitoring (when fed an entire mix).

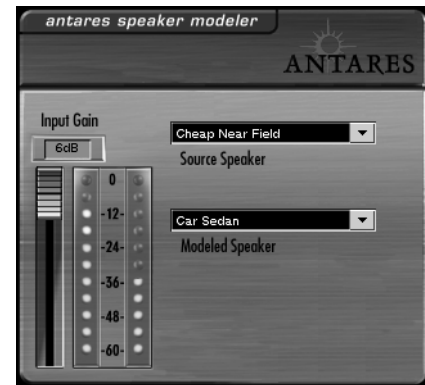

**Source Speaker** Use this field to select the type of speaker that your source material was recorded from, or select Bypass to leave your source material dry. Use this setting when you want the audio coming from your studio monitors to accurately emulate the speakers selected in the Modeled Speaker field.

**Modeled Speaker** Use this field to define the type of speaker you want to emulate.

## Tascam DeEssor

This plugin is used to limit sibilance in vocal recordings (for example, over exaggerated “sss” sounds). It is based on a frequency dependent limiter that only affects high frequencies at a very narrow bandwidth.

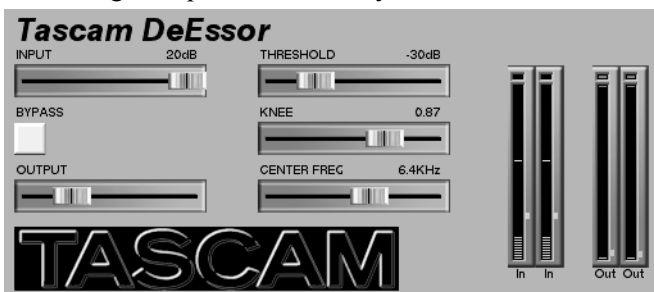

**THRESHOLD** This control sets the level at which you want processing to begin. The higher the Threshold setting, the less often de-essing will occur.

**KNEE** This control determines the curve, or steepness, at which the limiting occurs.

**CNTR FREQ** Use this slider to define the center frequency around which limiting will occur. Depending on the person singing or talking, excessive sibilance often occurs between 6 and 8kHz. Try a value in this range as a starting point.

### Tascam Exciter (Stereo)

Use this plugin to add extra high-frequency punch to your tracks. It is especially useful for improving the clarity of poorly recorded vocals.

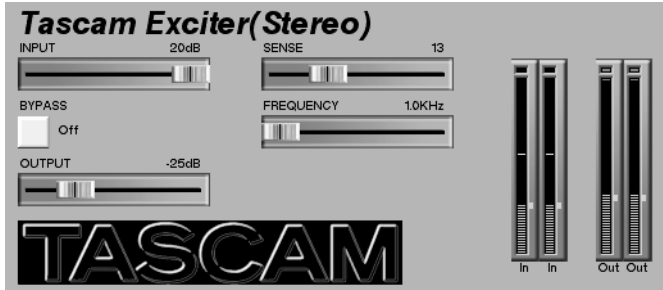

**SENSE** This control determines how often the exciter effect will occur.

**FREQUENCY** This control defines the frequency above which exciting occurs.

### Tascam/Nemesys HD1 Dither

This plugin is for changing and enhancing the resolution of digital recordings. Its dithering algorithm boasts an extremely flat, low-noise spectrum. Use it to convert bit resolutions, to dither, and to truncate.



#### TIP

*This plugin is best used post-fader (either on inserts or busses), as the last processor in a signal chain. If it is*

*placed in a position where DSP processing happens afterwards, you lose the bit resolution effect.*

**Bit Depth** Select the bit depth you want to convert to in this field (16, 18, 20, or 24).

**Type** In this field there are three choices: HD1, Truncate, or Bypass.

**HD1** This setting uses the TASCAM/Nemesys high-definition dithering algorithm to improve the low amplitude fidelity of your digital signal.

**Truncate** This setting cuts off the least significant bits in your digital recording. This might prove useful when using the Bypass key to compare sound quality between 24-bit versions and 16-bit versions of your mix.

**Bypass** Select bypass to bypass the effect.

## TC SX-1 Reverb

The TC Reverb plugin is a very comprehensive and high-quality reverb algorithm. It mainly consists of 4

functional blocks: Level Mix Controls, Space Editor, Highcut Filter, and Time Editor.

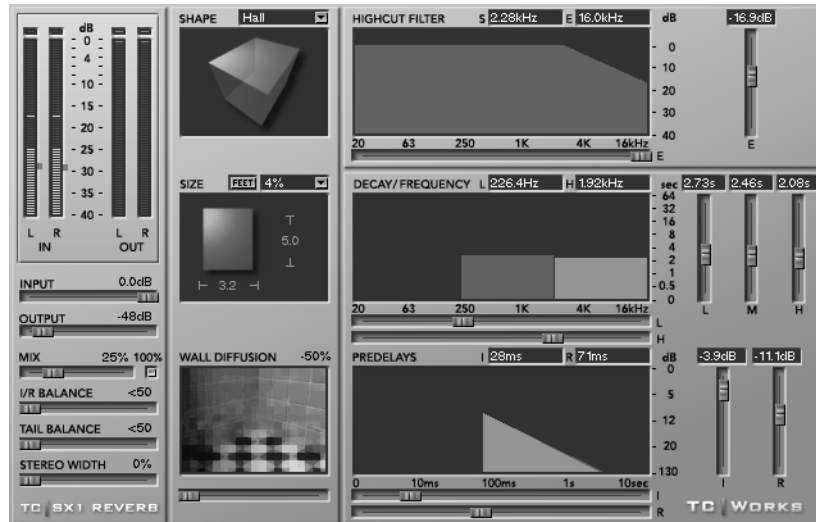

The TC SX-1 Reverb has a very powerful reverb algorithm core. Take a look at the block diagram below to get a better idea of the signal flow:

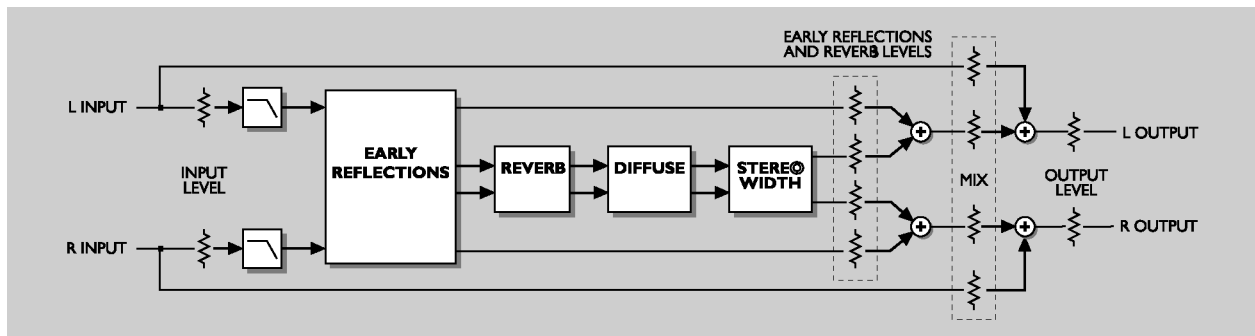

### Level Mix Controls

**MIX** This parameter sets the balance between the source signal and the processed signal. At 0%, you will only hear the source, while at 100% you will only hear the processed signal. When you are using the reverb in a send/return configuration, you will usually want to check the 100% box. This disables the MIX slider and locks the mix ratio at 100% wet.

**L/R BALANCE** Use this control to set the left/right balance of the Initial Reflections.

**TAIL BALANCE** With this fader you can set the left/right balance of the Reverb Tail.

**STEREO WIDTH** Stereo Width determines how “wide” the reverb should be: 0% is the same as mono, and 100% is wide stereo.

**Space Editor** The Space Editor defines the basic structure of the room. In natural reverberation, the early reflection happens within the first second of the response. This is where the sound is very clearly reflected by the walls and floors, and you can “feel” which type of room you are in. The second stage is the reverb process; here, the original sound is almost ‘lost’ within millions of chain reflections—so that even two very different rooms often sound much alike. The early reflection is actually the part of the reverberation process that defines the room characteristics.

**SHAPE** Shape defines the basic room type and early reflection pattern. By clicking on label beside the Shape label above the display you will get a pull-

down window where you can choose the reverb's shape directly. These shapes are available:

### Hall

Simulates the early reflection measured in the Boston Symphony Hall.



### Horseshoe

Incorporates some ideas from the design of the Musikvereinssaal in Austria.

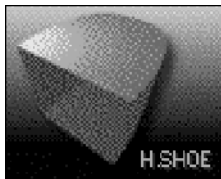

### Prism

Has a pattern based on the conceptual 'golden ratio' shoe box hall.

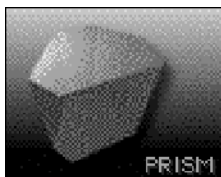

### Fan

Is based on the basic structure of the La Scala Concert Hall.

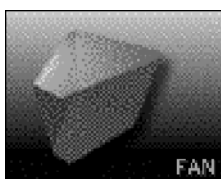

### Club

Is based on a regular small club room.

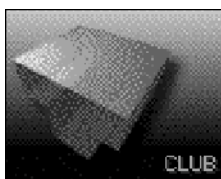

### Small

Simulates a small domestic room.

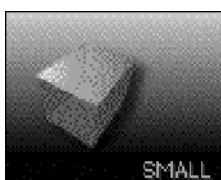

### TIP

Always adjust the predelay according to the basic shape you have chosen. Small rooms with a long predelay, for example, sound very unusual.

**SIZE** Size sets the size of the room by scaling the early reflection pattern. By clicking on the Size label above the display you will get a pop-up window. Here you can choose a scaling factor for the room size. A scaling factor of 1.0 is the original room size.

**WALL DIFFUSION** Wall Diffusion determines how much coloration the walls add to the sound. This parameter is used to increase the reverb decay's density. A Diffusion of 0% determines a value related to the original sound character of the room settings (including decay). You can change the Diffusion with an offset of up to  $\pm 50\%$ .

**High Cut Filter** The input to the TC SX-1 Reverb algorithm is processed with a low pass filter which allows you to "roll off" the high frequencies of your reverb effect. In general, you will want to make your reverb effect a bit darker than the source signal, as it might otherwise sound unnatural or even unpleasant.

**HIGHCUT FILTER** Above the HIGHCUT FILTER window, there are two frequency values displayed. The S value is the start frequency of the high cut filter, which is the lowest frequency influenced by the filter. The E value is the end value. This frequency is where you have reached the determined attenuation. The slider to the window's right adjusts the actual high frequency cut. And, the slider at the bottom of the window adjusts the frequency position where S meets E.

### Time Editor

**DECAY/FREQUENCY** The reverb decay is a long tail of reverberation that happens after the initial burst. The Decay block receives its input from the early reflection. Decay time can be edited distinctly in 3 frequency ranges: low (L), mid (M), and high (H). And the frequency-ranges themselves can also be modified.

For each band you can set the decay time between 0.25 and 64 seconds. The sliders to the right of the window adjust each band's decay time. The two sliders at the bottom of the window set the 2 crossover points between the 3 frequency-ranges.

### TIP

When designing your reverb, keep in mind that room acoustics lose their high frequency energy more easily over time. Setting the High Decay to a large amount of time will usually make the room sound more artificial.

**PREDELAYS** The predelays determine the starting point for when the actual reverb effect will begin.

This is broken into two components, the reverb's early reflection (I) and its decay curve (R). The individual start times and levels of both components are adjustable. The sliders to the right of the window adjust the early reflection and decay curve levels. The sliders below the window adjust the early reflec-

tion and decay curve start times (the amount of time each is initially delayed). The decay curve's start time is directly related to the early reflection's start. The maximum early reflection delay is 160 ms. And the decay curve's start time can be set no later than 100 ms from this initial first predelay.

# Chapter 16 – Working with Audio Regions

## Essential Tools

The Tracks screen and its associated Waveform tab provide the main work areas for audio waveform editing on an VGA display. These work areas are mirrored on the LCD display by the Tracks and Waveform screens. The Tracks screens allow coarse editing and

region selection on one or multiple tracks. The Waveform screens provide a larger view of the waveform and sample-accurate resolution for more detailed editing.

## Tool Select Menu

There are several tools located in the VGA's Main Menu Bar that determine the behavior of the mouse's cursor.

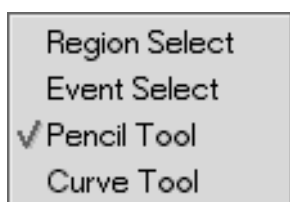

Click on the tool icon to select the tool you wish to work with (like those pictured below). You may cycle through the tools by repeatedly pressing the [ESC] key on the PS/2 keyboard.



**Region Select Tool** Use this tool for selecting (highlighting) regions to edit.



**Event Select Tool** Use this tool to select audio and MIDI events. Click on the event or group of events you want to select. It works in both the Track and Waveform screens (and the Piano Roll screens for MIDI events).



**Pencil Tool** Use this tool for drawing in data (automation, continuous controller data, and MIDI notes). Simply click, or click and drag where you want the data drawn. It works in the automation's Auto Track and MIDI track Piano Roll tabs.



**Curve Tool** Allows precise curves to be drawn in for automation controllers and MIDI control data.

## VGA Waveform Tab

From the Tracks screen on the VGA, click on the WAVEFORM tab to reach this window.

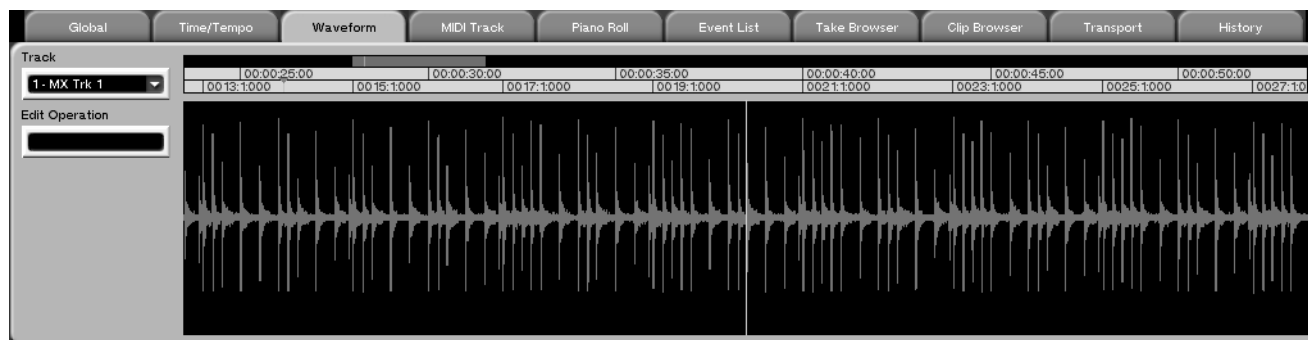

### TIP

Remember that for a larger Waveform screen you can click on the divider bar's three dots (explained in "Resiz-

ing Windows" on page 16). Then drag the bar vertically to expand the Waveform tab.

**Track** Click on the arrow to select the audio track you want to view.

---

## Edit Operation

This menu is used for selecting the type of edit operation to be performed on your selected event. The Edit Operations are as follows:

---

**Event Editor** After selecting an event (using the Event Select tool), a number of fields will appear to the left of the Waveform.

**Name** Allows you to name the selected audio event.

**Time** Displays the start time of the selected audio event.

**Duration** Displays the length of the selected audio event.

**Offset** Allows you to set an offset for the selected audio event.

**Muted** Check this box to mute the selected audio event.

**Initial Gain** Use this field to set the selected audio event's starting volume.

**Final Gain** Use this field to set the selected audio event's ending volume.

**Ramp Up Start Time** This field designates at what time the selected audio event will begin fading in.

**Ramp Up End Time** This field designates at what time the fade-in for the selected audio event will end.

**Ramp Down Start Time** This field designates at what time the selected audio event will begin fading out.

**Ramp Down End Time** This field designates at what time the fade-out for the selected audio event will end.

---

**HyperSelect** This operation allows you to select the events in a given region according to rules you designate (see "HyperSelect" on page 160). For example, you could select all audio events after bar 108.

---

**Move** Allows you to move a selected event forward or backward in time by a defined amount.

---

**Render** This operation takes any number of selected audio clips and consolidates them into one file. You can choose the name for the new clip before

rendering. This is currently the only way to name a raw audio file.

---

**Repeat Selection** This operation allows the selection to be repeated a specified number of times. Repeats are pasted sequentially, end to end.

**Count** This field determines the number of repeats.

**Merge Events** This box is grayed out for audio event editing, as the SX-1 cannot merge audio events in this manner.

---

**Reverse** This operation takes the selected audio event and reverses it.

---

**Gain/Fade** This operation offers a quick way to create linear fade-ins and fade-outs. There are two parameters: Start Amount and End Amount.

**Start Amount** refers to the level of the audio file at the beginning of the selection.

**End Amount** refers to the level of the audio at the end of the selection. The Start and End amount registers are ratios based upon the actual level of the audio file—meaning that a value of 100 represents 100% of the audio file's amplitude.

To make a fade-in, select an audio event that you would like to fade (if there is not a separate event yet to fade, use Split to create one), and then select 0 as your Start Amount, and 100 as your end amount. Press DONE, and the SX-1 will render your fade into the audio event.

---

**Normalize** The Normalize operation raises the gain of an event to a preset ceiling. This operation analyzes the audio event according to the setting of the Type field. If Peak is selected, the analysis looks for the loudest transient in the file. If RMS is selected, the analysis looks for the average loudest value over time. The Max Level setting determines what the level ceiling is for the action. For example, if the Max Value is set to -3, and the Type field is set to Peak, the SX-1 will raise the level of the entire audio event equally, so that the loudest transient is -0.3 dB below 0 dB (which is full clip in a digital system).

---

**Remove DC** This operation removes any instances of DC Offset, which can sometimes be created by improper digital conversion.

## LCD WAVEFORM Screen

This screen parallels the Waveform tab found in the Tracks screen on the VGA.

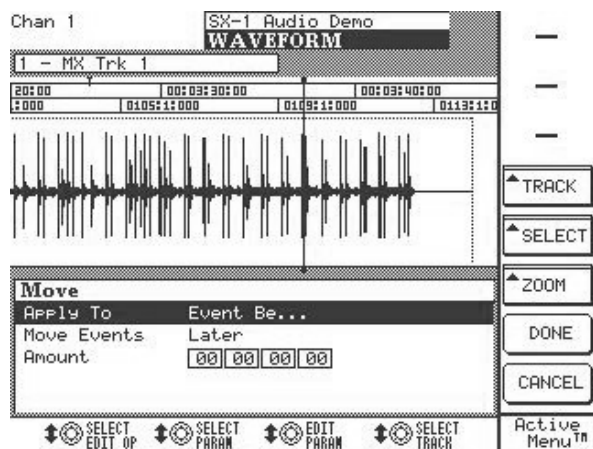

Press the **WAVEFORM** key from the **LCD ACCESS** section to reach this screen.

**TRACK** Allows you to scroll through your current project's audio tracks.

**ZOOM** Magnify or contract the track view.

**SELECT EDIT OP** This menu is for choosing a type of edit operation to be performed on your selected

region. The edit operations are described on the previous pages ("Edit Operation" on page 123).



**SELECT** Press this key to access the LCD screen's additional waveform editing menu.

**SINGLE EVENT** Selects the audio event at the playbar.

**ADD EVENT** Adds an event to the current selection.

**SINGLE TRACK** Selects an entire track (the track that is selected with the **SEL** key).

**ADD TRACK** Adds a track to the selected regions.



**NUDGE LEFT** Nudges the selected audio region earlier in time (set Nudge amount on the Main Menu Bar).

**NUDGE RIGHT** Nudges the selected audio region later in time.

**CLEAR** Clears the current selections.

## Managing Audio Takes

Several audio clips can be assembled (imported or recorded) to form a *take*. A take is essentially a self-contained EDL made up of a group of clips. The SX-1 has a pool of takes associated with a project, and the takes within this pool can be assigned to any track of the HDR for playback (they are not fixed to the track that they were originally assembled on). Takes can also be imported and exported between projects. They are managed from the Take Browser tab of the VGA's Tracks screen.

Audio takes are loaded to track slots by clicking on the  icon to the right of the  key in the Tracks screen. Then, selecting the Load Audio Take command from the pop up-menu reveals the takes that are available for loading.

### TIP

*For step by step instructions on loading audio and MIDI takes to tracks, see the Quick Start Guide.*



### VGA Take Browser Tab

Here you can manage your current project's takes and import takes from other projects. You must load takes into slots by using the slot button on the VGA.

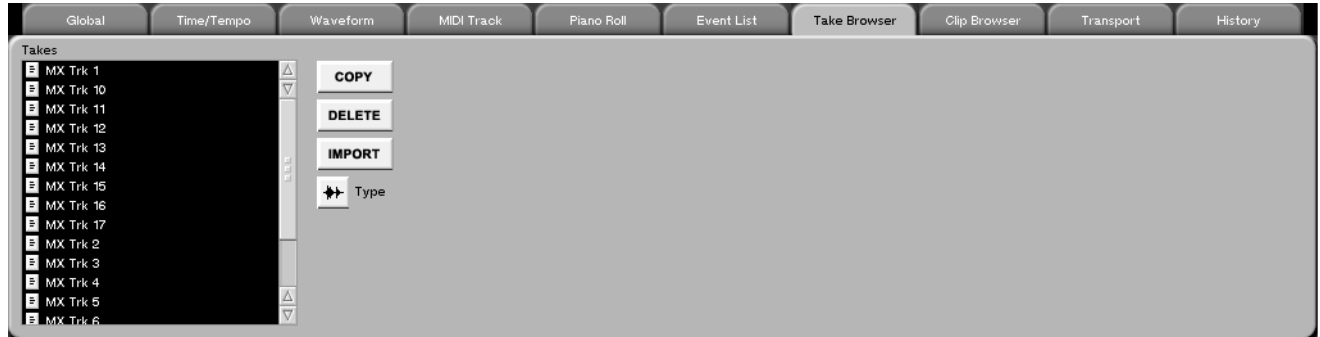

**TYPE** This allows you to toggle between viewing audio takes or MIDI takes.

### Audio Clips

*Clips* are raw audio files created by recording on the SX-1, or by importing from other media (such as samples and loops). The SX-1 allows you to import

clips that conform to one of a number of standard audio file formats: WAV, AIFF, SDII, BWAV, and AU.

### VGA Clip Browser Tab

In this tab you can view audio files that are available to your current project as clips. Clips from this win-

dow can be selected and dragged directly to an audio track in the Tracks window.

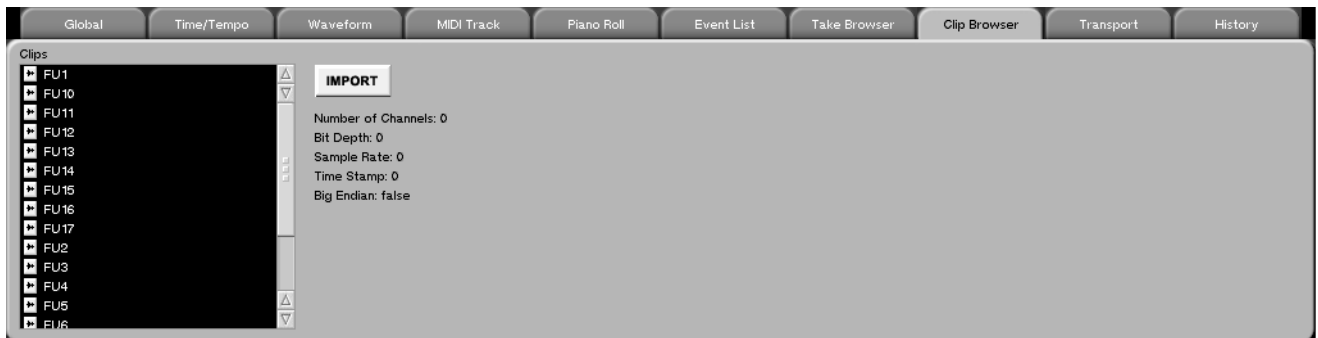

You will notice that when you select a Clip in the browser, information about that audio file is displayed to the right of the list. Bit depth, sample rate, number of channels (stereo or mono), and time stamp are all included.

Also note, the type of display is determined by the type set for the SX-1's timecode display readouts. This means that if the SX-1 is set to display bars and beats, the data displays to the right of the Clip Browser will show their information in bars and beats instead of SMPTE or samples.

## Part VI—Audio tracks

Pressing the Import button opens the import dialog (pictured below). Here you can import audio files from the internal drive, a CD-ROM or other con-

nected media. Once these files are imported into your project's clip window, simply drag them to an audio track for playback.



Clicking the Use Time Stamps button will constrain the selected file to its original timestamp when it is dragged onto a slot. If the original file has no stamp, the file can be moved anywhere on the timeline.

### TIP

*If you dragged a file onto an audio track but can't see it, it might be because the file's original position is out of your immediate viewing range. Drag the cursor around the timeline to find your file, or go to the event list for that track and double-click on the audio event to locate the transport there.*

## Chapter 17 – Editing Audio

### Edit Controls

Besides the editing controls found in the VGA and LCD screens, there are also front panel editing keys you can use with a parallel editing menu on the VGA menu bar, if you need it. Once you have selected a region or event using the on-screen or surface con-

trols, the front panel editing keys give you quick access to basic editing operations.

Select an event and press one of these keys to perform the editing operation.

### EDIT

The **EDIT** key opens the EDIT screen (pictured below) on the LCD. This screen allows you to, among other things, define your edit region and adjust grid and nudge settings.

**EDIT REGION** These registers let you change the start, end, length, and sync point of your edit region.

**GRID SETTINGS** These parameters are for setting your grid size and time value (such as samples or beats). From here you can also turn the grid on or off. The grid is explained further in “Nudge & Grid Settings” on page 18.

**NUDGE SETTING** These parameters determine how the nudge value operates. The nudge time format and amount can also be set in the Main Menu Bar of the VGA. However, the Nudge Mode parameter is unique to this LCD screen. Possible settings for this parameter are as follows:

**Slide Event** This setting determines that a Nudge command will Slide the event forward or backward in time by the Nudge amount, depending on whether a Nudge Left or Nudge Right command is chosen.

**Event Begin** This setting determines that a Nudge command will modify the event’s In point by the Nudge amount, without changing the Out value.

**Event End** This setting determines that a Nudge command will modify the event’s Out point by the Nudge amount, without changing the In Point’s value.

**Event File Offset** This is an advanced setting for users who are used to editing samples on hardware samplers. This setting determines that a Nudge command will move the point where the event begins playing/becomes audible, without changing the position in time of the event itself.

**Slide Region** This setting determines that a Nudge command will move the edit selection points together (without moving the underlying event) by the Nudge amount. This is useful when a region is selected, but you would like to move the selected area, not the audio, MIDI, or automation data it is selecting.

**Region Begin** This setting determines that a Nudge command will move the beginning point of a region selected for editing, without affecting the end point.

**Region End** This setting works the opposite of the previous setting. It determines that a Nudge command will move the End point of a region selected for editing without affecting the In point.

**HISTORY LIST** Press this soft key to recall the LCD display’s EDIT HISTORY LIST. Here you can see all of your previous recording and editing moves. This screen is a mirror of the VGA Tracks screen’s History tab.

**ERROR LOG** The SX-1 keeps a log of all events it classifies as errors (for example, losing clock sync). Pressing this soft key shows the error log readout screen. This LCD screen has a parallel window in the

## Part VI—Audio tracks

VGA that is accessed from the SX-1 menu of the Main Menu Bar.

**SMPTE FORMAT** Sets the time format for the EDIT REGION registers. The choices are: SMPTE, hours:minutes:seconds, bars:beats:ticks, feet:frames, or samples

**SET TO DEFAULT** Sets the highlighted parameter back to its factory default value.

**NUDGE LEFT & NUDGE RIGHT** These soft keys let you move your selected region forward or backward in time by the nudge amount given in the NUDGE SETTING field and the Nudge type set in the Nudge Mode field.

### Editing

#### TIP

*Before you can perform an edit, you must first select an event to modify. If you need to create an event, simply drag across a track with the mouse and hit the Split key. Alternatively, create the Edit Begin and End points with the Capture key and then select Split.*

**CUT** Use **CUT** to remove a selected region. A gap is left between the Edit In and Out points, and the cut contents are placed in the SX-1's temporary clipboard.

#### Audio Before Cut

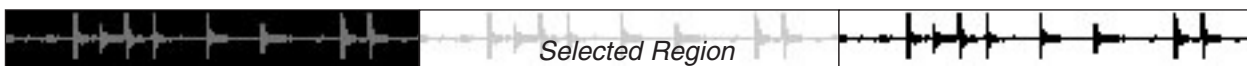

#### Audio After Cut



**COPY** Use **COPY** to send the selected region to the clipboard. The clipboard contents (the copied region) can then be pasted to a new location.

#### Audio Before Copy

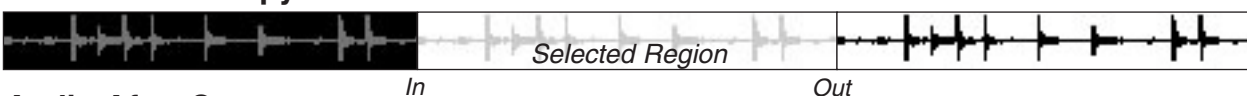

#### Audio After Copy



**PASTE** Use **PASTE** to place the clipboard contents at an edit In point. The newly pasted region overwrites the area's previous contents.

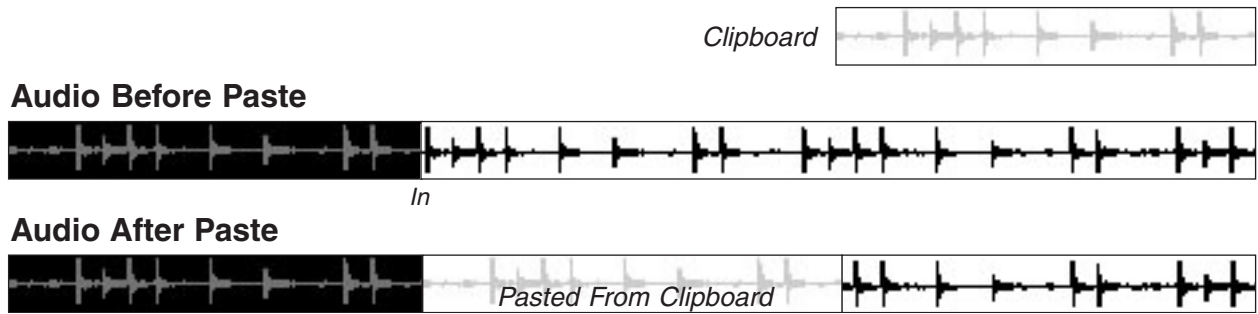

**TIP**  
 An In point can be created in two ways. On the VGA display, place the cursor (using the Region Select tool) where you want the In point to be and click once. Or, from the SX-1's front panel, press the **EDIT/ EDIT BEGIN** key where you want the edit In marker placed.

**CLEAR/TRIM** Use **CLEAR/ TRIM** to remove the contents of a selected region without sending that region to the clipboard. Press **SHIFT+CLEAR/ TRIM** to crop the selected region. This move deletes everything on the track but the selected region (see illustration below).

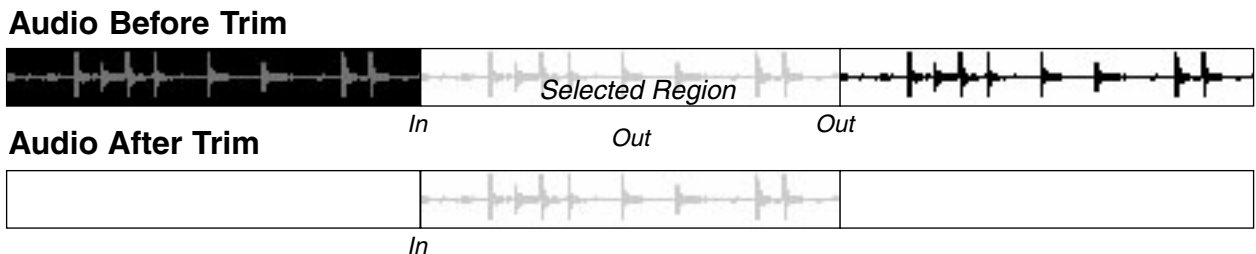
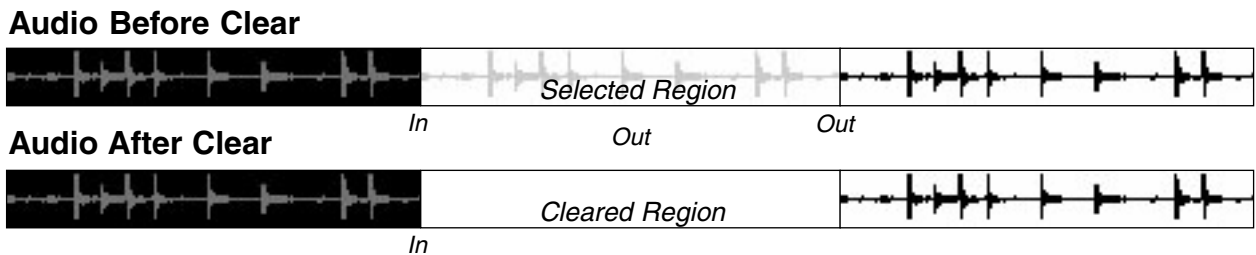

**SPLIT** Use the **SPLIT** key to divide one large event into one or more smaller events. For example, splitting a region into several different events can facilitate

selection and movement (horizontally, within the track itself, and vertically, between different tracks) of sound bites and musical phrases.

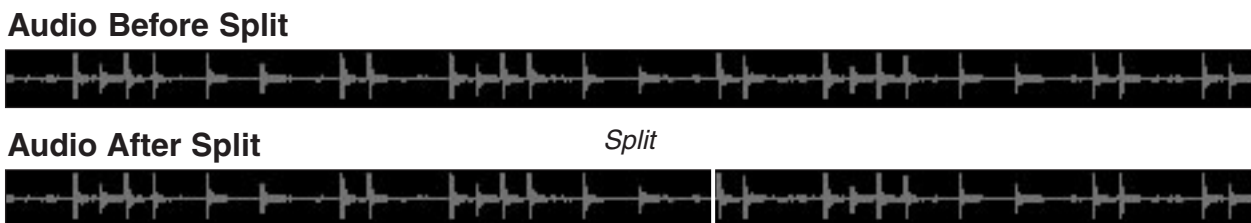

## Part VI—Audio tracks

**MERGE** This key is for MIDI editing only. Use **MERGE** to combine two different MIDI regions (the contents of the clipboard and a region equal to the

length of the clipboard's selection after the paste In point).

### Region 1



### Region 2

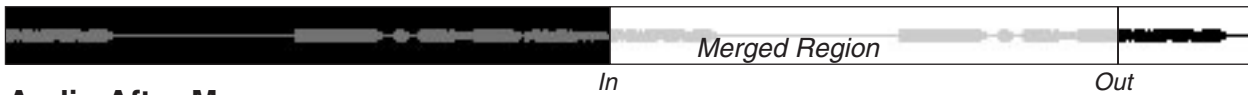

### Audio After Merge



**RIPPLE/REV RIPPLE** Ripple is a mode where data is moved during an edit operation, either to fill the gap created by a Clear or Cut, or to move out of the way for a Paste command. Ripple moves events later in time, while Reverse Ripple moves events earlier in time.

Press this key and its LED will light to indicate that all subsequent edits will be rippled. For example, with Ripple enabled, all material pasted from the clipboard will be inserted at the In point and the original material after the In point will move later in time. Pressing **SHIFT+RIPPLE/REV RIPPLE** moves the rippled data to the left.

Use the **RIPPLE/REV RIPPLE** key to enable rippling for the Cut, Paste, Split, and Clear edit commands.

Clipboard



### Audio Before Paste Ripple



### Audio After Paste Ripple



Clipboard

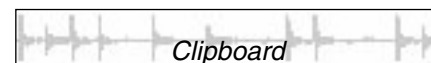

### Audio Before Reverse Paste Ripple



### Audio After Reverse Paste Ripple



**UNDO** Use the **UNDO** key to revert to the project's state just before your last edit or record move.

**REDO** Use the **REDO** key to revert the last Undo move.

#### TIP

In the VGA, click on the History tab to view all of the session's previous recording and editing moves.

**SELECT** Press this key to jump to the HyperSelect LCD screen (pictured here). This screen mirrors the controls of the Waveform tab's HyperSelect command (explained in "HyperSelect" on page 160), an item of the Edit Operation menu. Use these controls to select multiple audio events that conform to HyperSelect's

rules (for example, you could select all audio events after bar 108).

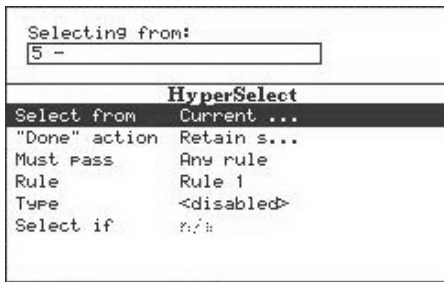

**BEGIN/EDIT BEGIN** Press the **BEGIN/ EDIT BEGIN** key to define the In marker for an edit region. Press **SHIFT+BEGIN/ EDIT BEGIN** to adjust the edit Begin point.

**TIP**

Remember, In and Out edit points must be defined before you can edit a region. Use the **CAPTURE** key (explained in “Creating Locate Points” on page 38) to capture edit points on the fly.

**END/EDIT END** Press the **END/ EDIT END** key to define the Out marker for an edit region. Press **SHIFT+ BEGIN/ EDIT END** to adjust the edit end point.

**SYNC PT/EDIT SYNC** Press the **SYNC PT/ EDIT SYNC** key to mark a location for that event that all edits will align to. Press **SHIFT+SYNC PT/ EDIT SYNC** to edit the position of the sync point.

**VGA Edit Menu**

Undo	ALT Z
Redo	SHIFT ALT Z
Cut	ALT X
Cut (Ripple Left)	SHIFT ALT X
Cut (Ripple Right)	CTL ALT X
Erase	ALT B
Copy	ALT C
Paste (Insert)	ALT V
Paste (Overwrite)	SHIFT ALT V
Paste (Merge)	CTL ALT V
Trim	ALT T
Open Area	CTL ALT O
Split	ALT S
Select All	ALT A
Select All Audio	
Select All MIDI	
Select All Automation	
Unselect All	ALT U
Toggle Grid	ALT G
Store MIDI Control Values	

An expanded edit command menu is available from the VGA’s Main Menu Bar. Along with all the previously explained editing operations, there are several unique editing commands found only on this menu.

The commands that are unique to this menu are explained here.

**Cut (Ripple Left)** Functions like Cut+Reverse Ripple.

**Cut (Ripple Right)** Functions like Cut+Ripple.

**Paste (Insert)** Functions like Paste+Ripple.

**Paste (Overwrite)** Pastes from the clipboard and overwrites the area beneath the newly pasted region.

**Paste (Merge)** This is for MIDI editing only. Use Merge to combine the contents of the clipboard with pre-existing data on a track.

**Open Area** This operation creates a gap that is equal to the duration of the selected region, by moving all of the track’s material past the region’s In point later in time (see the illustration below).

**Audio Before Open Area**

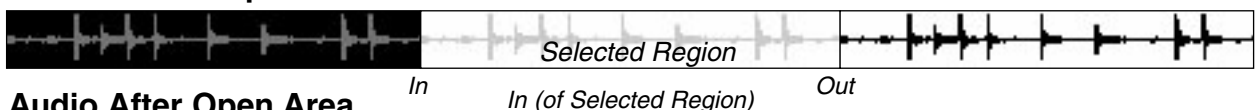

**Audio After Open Area**

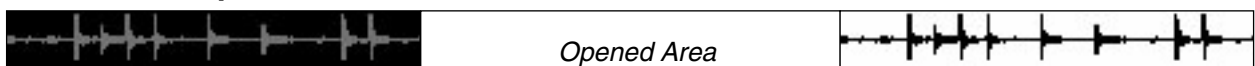

**Select All** Selects all tracks.

**Select All Audio** Selects all audio tracks.

**Select All MIDI** Selects all MIDI tracks.

**Select All Automation** Selects all automation tracks.

**Unselect All** Deselects all selected tracks, regions, and events.

**Toggle Grid** Turns the “snap-to-grid” function on and off (works exactly the same as the Grid Select key described on “Grid Select” on page 18).

**TIP**

For quick PS/2 keyboard access to these editing functions, note the keyboard commands listed on the far right of the pull-down menu.

### Auditioning Edits

In order to facilitate an easy and quick way to hear your selected regions and edits, the SX-1 includes a dedicated Audition section on its front panel.

#### AUDITION Section

These keys determine how a region or edited area is played back for review. They all function in a similar manner. Press one of the keys and then press the edit location point (for example, the **BEGIN/ EDIT BEGIN** or **END/ EDIT END** keys in the **EDITING** sec-

tion) you want to audition. After pressing an audition key, blinking LEDs alert you as to which location points can be auditioned (edit, loop, autopunch, and locate points).

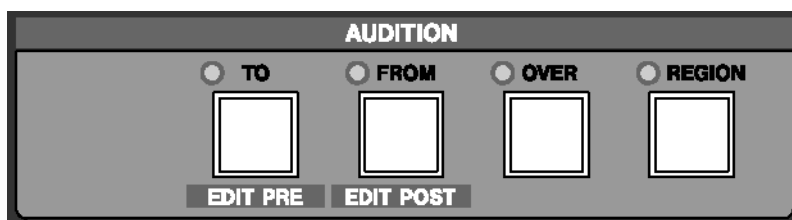

**TO/EDIT PRE** Use the **TO/ EDIT PRE** key to audition material up to the edit point. Press **SHIFT+TO/ EDIT PRE** to adjust the Audition pre-roll time (a register appears on the LCD, pictured here).

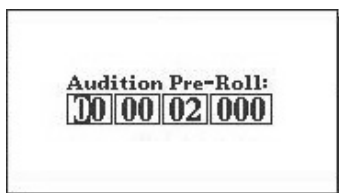

**FROM/EDIT POST** Use the **FROM/ EDIT POST** key to audition material from the edit point forward. Press **SHIFT+FROM/ EDIT POST** to adjust the Audi-

tion post-roll time (a register appears on the LCD, pictured here).

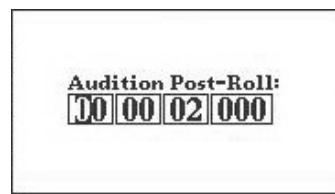

**OVER** Use the **OVER** key to play back from a point before the edit to a point after the edit. The post and pre-roll times are determined by the **TO/ EDIT PRE** and **FROM/ EDIT POST** keys (see above).

**REGION** Use the **REGION** key to play back only the selected region.



## Chapter 18 – Essential Controls

### MIDI Sequencer

The SX-1's MIDI sequencer is a full-fledged 128-track sequencer with all the editing and recording capabilities of a dedicated software program. There

are several ways to interact with the MIDI sequencer: from the SX-1's front panel, a connected VGA screen, and the onboard LCD screen.

#### MIDI REC MODE Section

The keys in this section access functions of the MIDI sequencer.

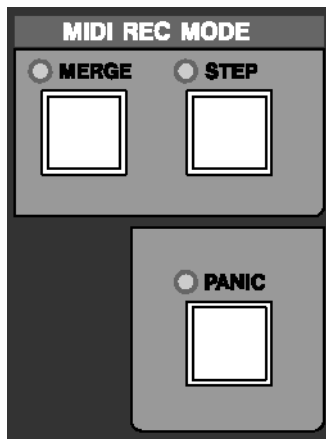

**MERGE** Use the **MERGE** key to enable the MIDI Merge recording function. By default, MIDI record-

ing is set to overwrite data. However, with the Merge function active (as indicated by the <MERGE> LED), newly recorded MIDI data is added to the pre-existing MIDI data of a track.

**STEP** Use the **STEP** key to enter MIDI Step Record mode (“Step Record Mode” on page 146). When Step Record is active, notes can be entered one at a time from a MIDI controller connected to the SX-1's MIDI In jack. The note durations are shown in the Piano Roll tab when the Step Record edit operation is selected, and note durations can be changed via the Keypad.

**PANIC** Use the **PANIC** key to reset stuck MIDI notes and other such errant MIDI messages. A mirror Panic key is also available on the VGA Main Menu Bar. This key is a latching key.

### VGA Tracks Display of MIDI

Working with MIDI data is similar in some ways to working with audio data. Many of the same rules for

selecting and editing regions and events (outlined in “Editing Audio” on page 127) apply to both.

#### MIDI Tracks

The image below is an example of MIDI tracks as they appear in the Tracks screen on the VGA. You can treat these tracks in much the same way you treat

audio tracks. Events and areas can be selected, cut, cleared, moved, and so on.

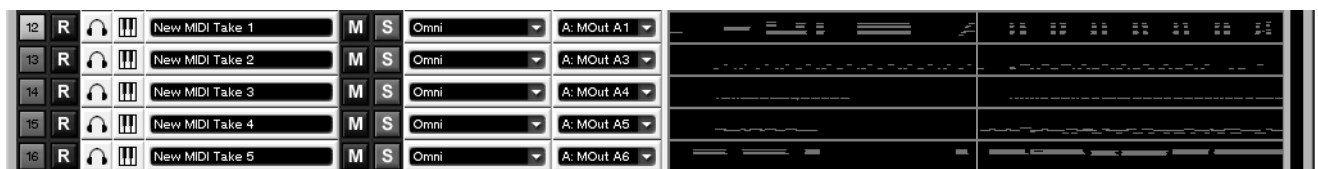

#### TIP

To learn how to create and load MIDI tracks, see the *Quick Start*.

## Part VII—MIDI Sequencing

For a more detailed view of a single MIDI track, use the Piano Roll tab (pictured here) of the Tracks screen.

MIDI data on the Piano Roll shows up as colored blocks, indicating their pitch and timing by their

position). Notes flash on the keyboard when they are played back, showing accurate Note On velocity by using a gradually darker color as the velocity approaches 127 (full scale MIDI).

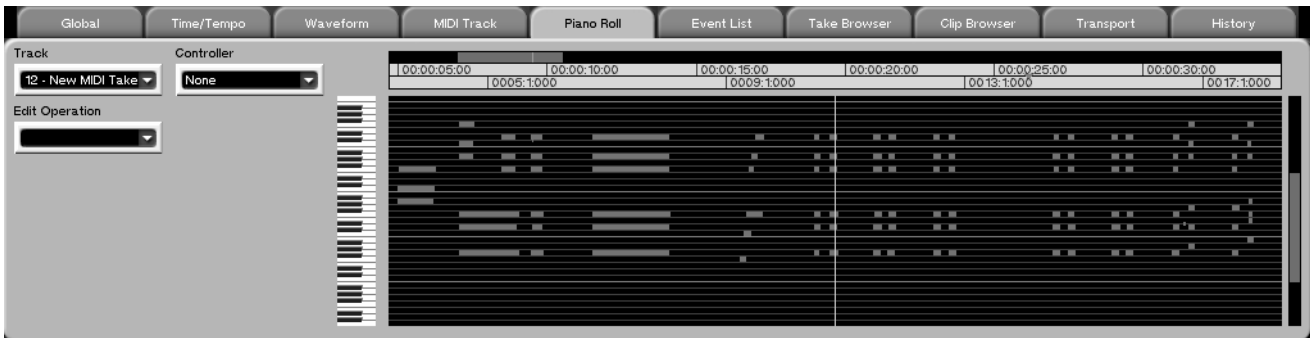

### LCD Tracks Display of MIDI

#### MIDI Tracks

The image below is an example of MIDI tracks as they appear in the TRACKS screen on the LCD.

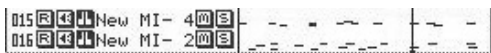

The VGA's Piano Roll tab also has a parallel LCD screen (pictured below).

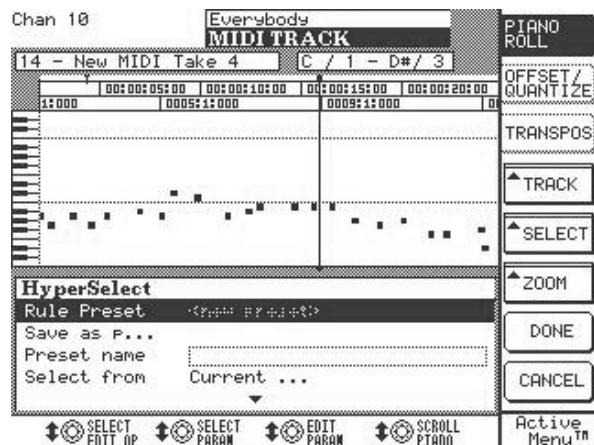

From the **LCD ACCESS** section, press the **MIDI TRACK** key to reach this screen. The operations for this screen are discussed above.

## VGA MIDI Channel Display

Like the audio tracks, the MIDI tracks also have their own Channel control. With a MIDI track selected (press the mixer channel's **SEL** key for a MIDI

track), press the **CHANNEL** key in the **MAIN DISPLAY MODE** section.



**MIDI CONTROLLERS 1-16** The SX-1's MIDI channels pre-assign 16 Continuous Controllers by default, and these can be any of the allowable controllers within the MIDI specification – for instance,

14 bit controllers (instead of the standard 7 bit). Use these modules to assign the desired controllers, which will record/play and pass through (if MIDI Thru is enabled).

## LCD MIDI Channel Display

The controller modules are also available via the LCD screen. They function identically to the controller parameters in the VGA Channel module.

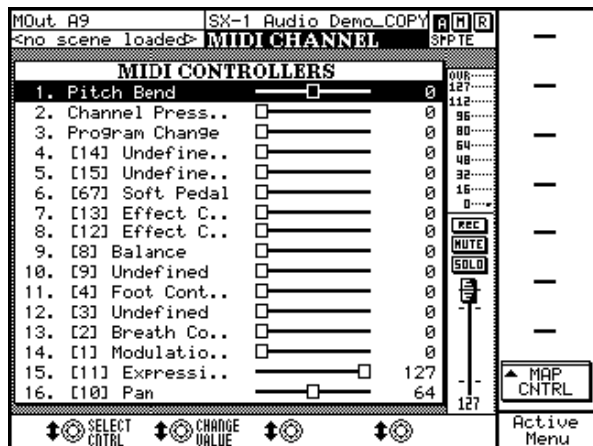

With a MIDI channel selected, From the **MAIN DISPLAY MODE** section, press **CHANNEL**.

### TIP

A MIDI track's associated controllers can also be seen in the MIDI Mixer screen of the Fader Banks. The controllers can be assigned there, and their values can be manipulated.

## Global Controls

The MIDI settings in the Global tab of the VGA Tracks screen affect all MIDI operations.

### VGA Global Tab

Press **TRACK** in the **MAIN DISPLAY MODE** section, then click on the Global tab to reach this window.

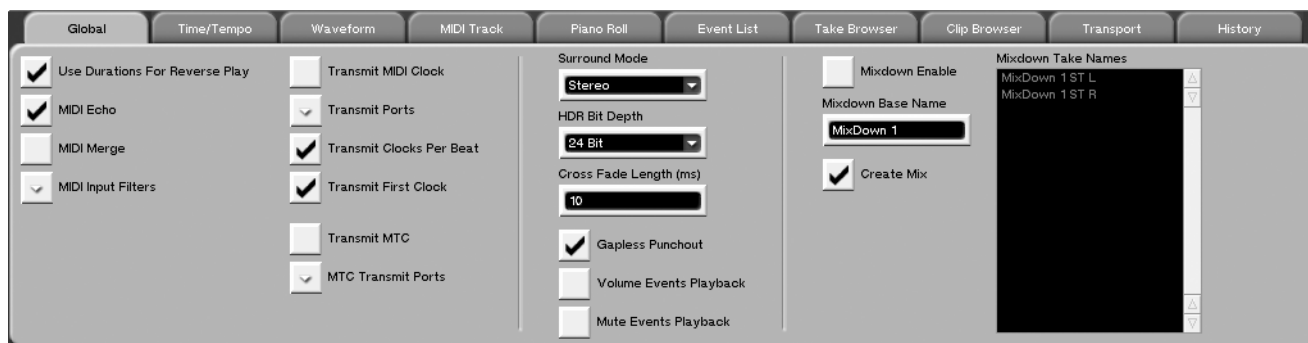

**Use Durations For Reverse Play** The sequencer supports playback of MIDI performances in reverse.

### TIP

Start reverse playback by pressing and holding the **SHIFT** key on the Keypad while pressing **PLAY**. Or, by holding down the **[Alt]** key on the PS/2 keyboard and clicking on the Play key in the VGA's Main Menu Bar.

When Use Durations for Reverse Play is on, the sequencer will simply swap each MIDI note's start time with its

end time as it plays in reverse (see the illustration below).

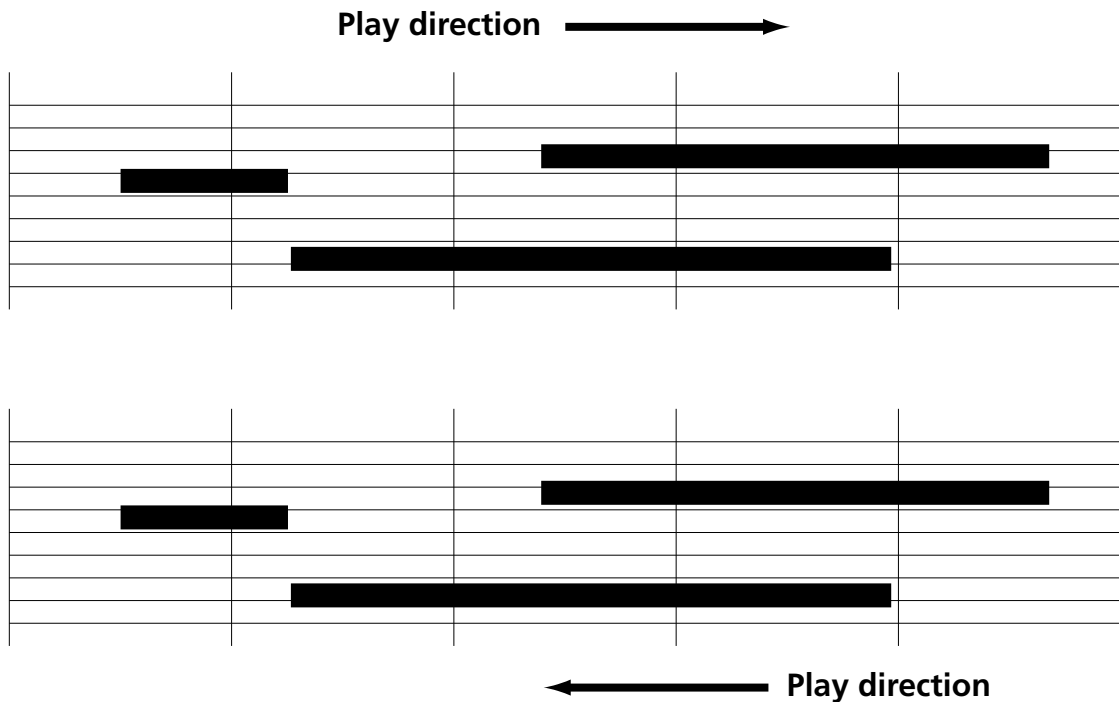

When Use Durations for Reverse Play is turned off, during reverse play the start time of each note remains the same, and each note plays for a fixed duration (the

default duration for this mode is a 1/16th note (semi-quaver), but this can be changed).

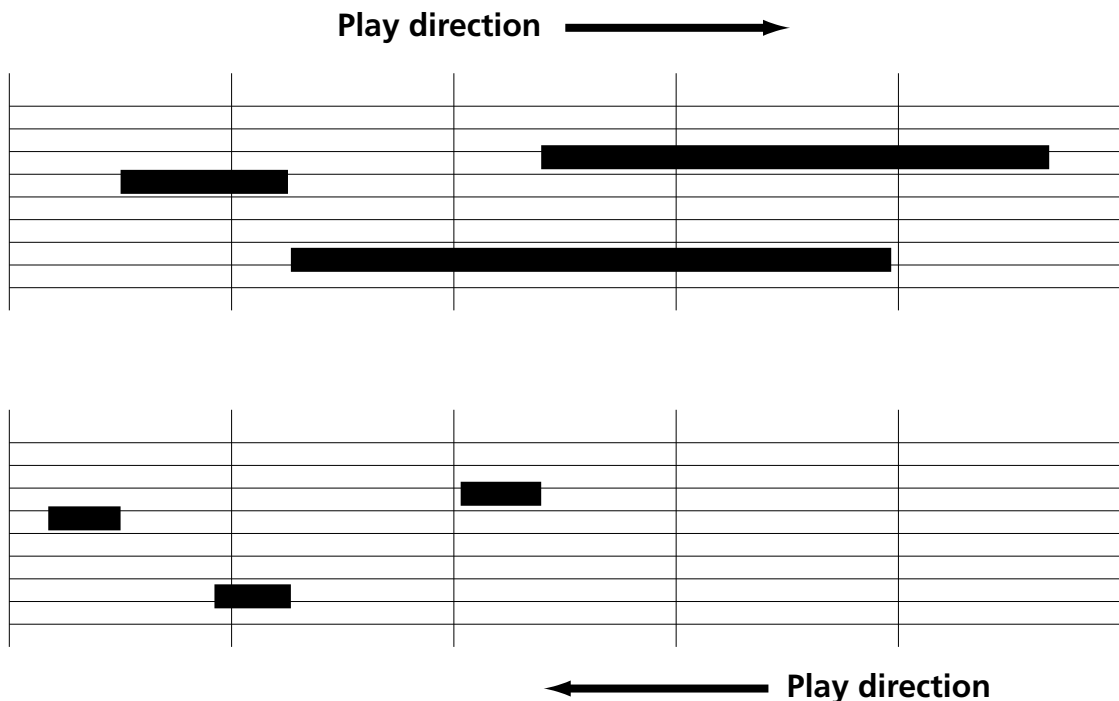

**TIP**

*With sounds that have sharp attacks followed by fast decays to silence, it is best to turn Use Durations for Reverse Play off. If you don't, these types of sounds in reverse play can sound odd because note start times will not*

*align. However, with sounds that have a steady sustain (such as organ notes), then turn Use Durations for Reverse Play on to get a closer approximation of what the sequence would sound like if the notes were played backwards.*

### MIDI Input Settings

**MIDI Echo** When MIDI Echo is turned on, all MIDI data entering the SX-1's input port is echoed out of one or more of the output ports. The MIDI data received on the selected input channel (or all channels, if OMNI is selected as the input source of the track slot) is echoed out the port and channel selected in the output field track slot. This can be helpful when using a master controller with no sounds of its own, but can cause problems if the device being used as the controller also has internal sounds that are being used. If MIDI Echo is disabled, then data echoing does not occur.

#### TIP

*Data is only echoed if a MIDI take has been created and exists in a track slot, and has RECORD or MONITOR enabled.*

**MIDI Merge** With MIDI Merge turned on, when recording over existing data, the old and new performances are merged together. When MIDI Merge is turned off, recording over existing data erases and replaces that data.

**MIDI Filters** The MIDI Input Filters feature determines what types of MIDI data are ignored at the MIDI input ports. If an event type is checked in the popup menu, then it will be filtered—not recorded or echoed to the MIDI output ports (if MIDI Echo is enabled).

**Transmit MIDI Clock** Turn this setting on to enable transmitting MIDI Clock (Timing Clock, sometimes known as MIDI Beat Clock) whenever the SX-1 plays or records. One or more Transmit Ports must be enabled for transmission to occur (see Transmit Ports below).

#### TIP

*MIDI Clock is useful for synchronizing external MIDI devices that contain internal sequencers, as these devices rarely chase timecode.*

**Transmit Ports** Click on the arrow to choose which output ports transmit MIDI Clock. It is best to enable transmission of MIDI clock on just the ports where it is needed. MIDI clock can affect the timing of other MIDI data sent on the same port, so having a port dedicated to MIDI clock transmission is optimal.

**Transmit Clocks Per Beat** When enabled (checked), 24 MIDI clocks are sent per beat. When not enabled (unchecked), 24 MIDI clocks are sent per quarter note (crochet). The 24 MIDI clocks per beat mode is preferred when working with time signatures that are not based on quarter note beats (such as 3/8, 6/8, 3/2, etc.).

**Transmit First Clock** When enabled (checked), 24 MIDI clocks are transmitted after the MIDI Start command. When disabled (unchecked), the Start command serves as the first clock and 23 more clocks follow. Some older MIDI devices assume the Start command is also the first clock of the first beat. For these devices, enable Transmit First Clock.

**Transmit MTC** When enabled (checked), MIDI Time Code is sent out the list of ports selected in the MTC Transmit Ports menu (see below).

**MTC Transmit Ports** Click on the arrow to determine the list of output ports sending MTC (MIDI Time Code). As with MIDI Clock, it is best to only enable MTC transmission on the ports where it is actually required. Ideally, a single output port should be dedicated to MTC transmission.

#### NOTE

*The mixdown parameters in this tab are covered in "The SX-1 and Mixdown Mode" on page 170 and the system parameters in "System Settings" on page 182.*

## LCD MIDI Settings Screen

This LCD screen mirrors the MIDI controls found on the Global tab of the VGA Track screen. Many of the parameters on this screen are identical to the parameters found in the VGA Global tab, and are explained on the previous pages. Only those parameters that are unique to this LCD screen are explained here.

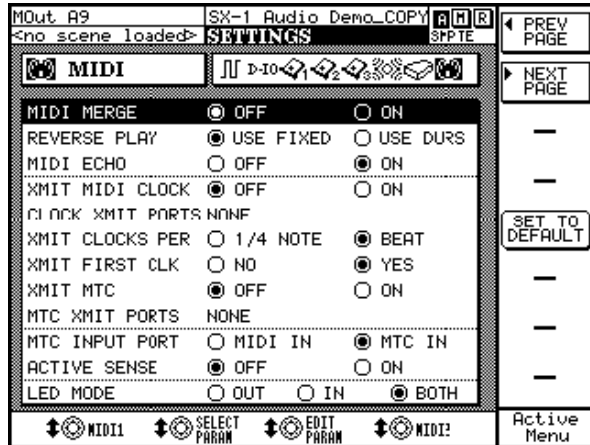

To reach this screen, press the **SETTINGS** key in the **MAIN DISPLAY MODE** section. Then use the **NEXT PAGE** soft key to scroll to the MIDI page.

**MTC INPUT PORT** This allows the SX-1's **MIDI IN** port to see MIDI Time Code. Use the **MIDI IN** option if you are using a device that is sending both MTC and MIDI performance data (notes, etc.) from the same port.

**ACTIVE SENSE** This turns on or off MIDI Active Sensing. Turn this parameter on when you are controlling a device that accepts Active Sensing. You may want to turn off Active Sensing if: you have an older MIDI device that does not accept Active Sense messages and “chokes” on them, or if you find the constant flashing of the MIDI activity indicator annoying (or you only want to see sequencer activity). This parameter is only accessible from the LCD screen.

**LED MODE** This setting allows you to choose whether the **<MIDI>** activity LED on the SX-1's slanted front panel responds to MIDI In data, MIDI Out data, or both.

## VGA MIDI Track Tab

The MIDI Track tab contains controls for non-destructively altering a track's MIDI performance. From the

**MAIN DISPLAY MODE** section, press the **TRACK** key, then click on the MIDI Track tab.

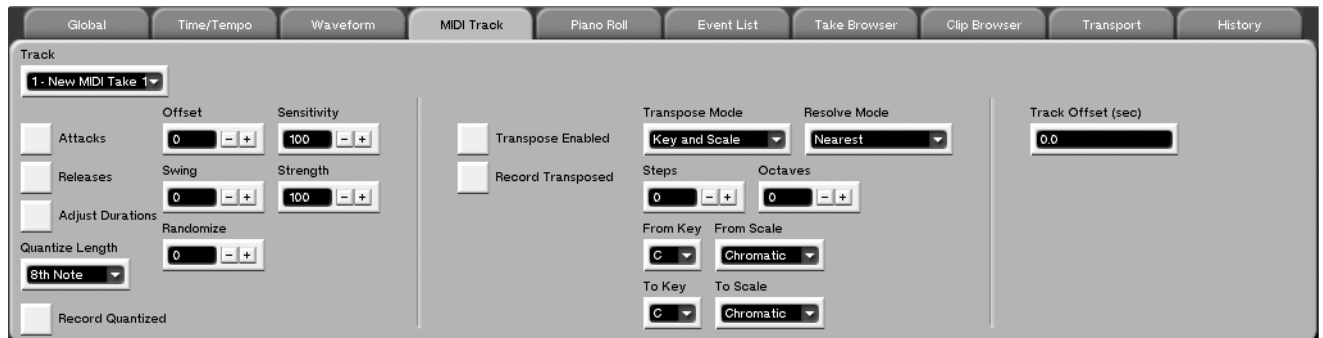

**Track** Here, you select a MIDI track for processing. Each track can have its own unique settings for all of the available parameters.

## Part VII—MIDI Sequencing

**Quantize Controls** The Quantize feature allows notes to be precisely aligned on an imaginary quantize “grid” in a variety of ways. The following definitions and accompanying illustrations are examples of

how different quantize settings affect the MIDI performance. All the illustrations are based on a single measure with a 4/4 meter and the quantize grid set to 8th notes (quavers) (see the figure below).

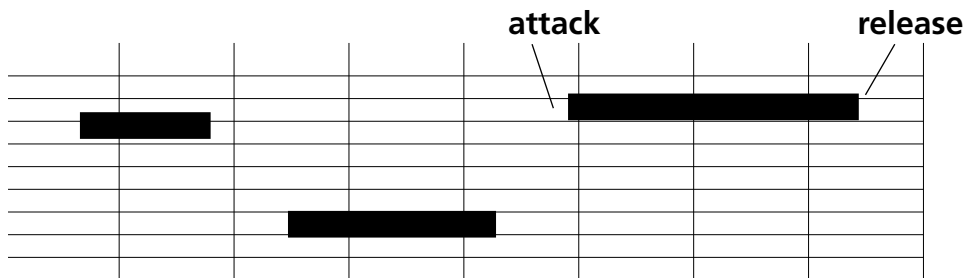

**Quantize Length** This is the most important quantize parameter. It determines the size of the “grid” to be applied to the MIDI data. The grid’s spacing is expressed as a rhythmic value, for example, a 1/16th note (semiquaver). In 4/4 time, a quantize length of 1/16th note would result in 64 quantize divisions per measure (that’s 4 beats x 16 divisions per beat).

**Attacks** When enabled, the start times of notes are aligned to the quantize grid. For example, if the Quantize length is 8th notes (quavers), then all the selected notes’ start times are moved to the nearest 8th note boundary in the current measure. Notes are moved forwards or backwards depending on where the nearest 8th note boundary falls. The picture below shows before and after quantize with the Attacks parameter enabled.

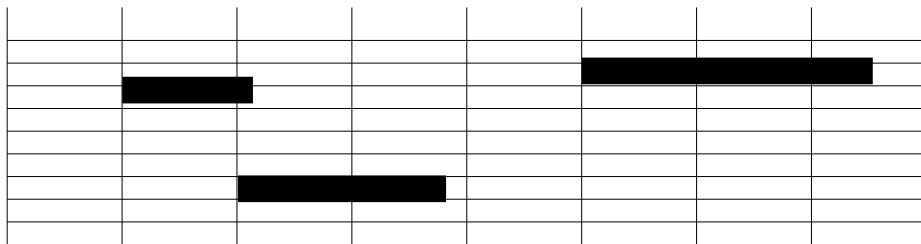
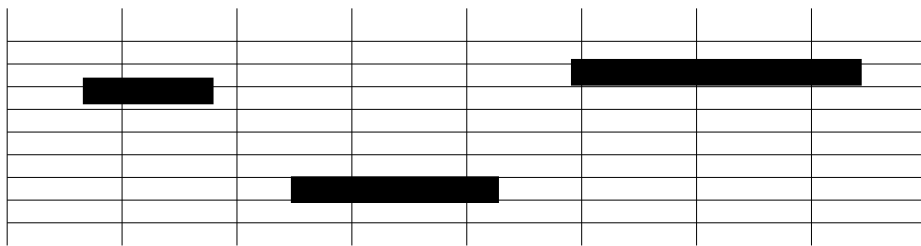



**Releases** When enabled, notes are moved so that their end times align with the quantize grid.

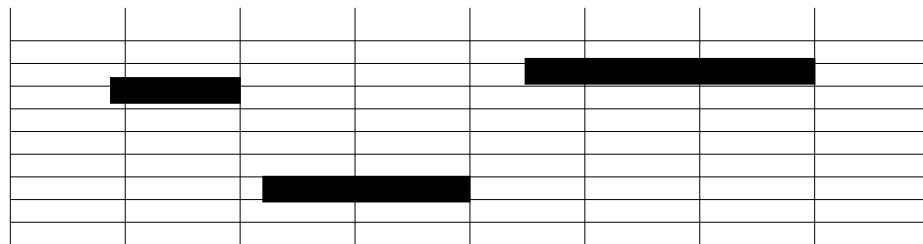
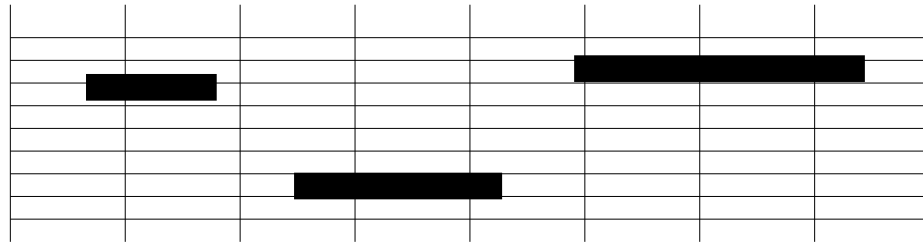

**Adjust Durations** When enabled, the duration of the notes change to conform to the attack or release quantize settings. If both attacks and releases are

being quantized, the notes will be stretched or shrunk to fit into the nearest quantize grid.

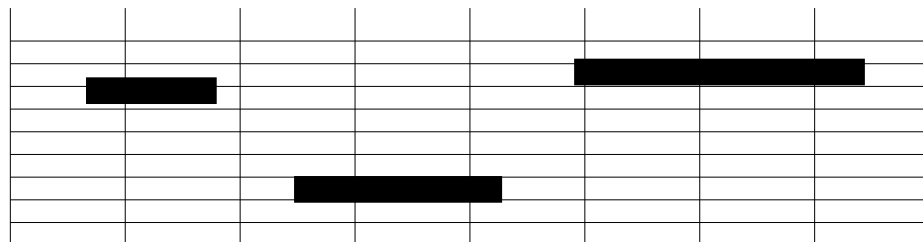

**Record Quantize** Check this box to have the quantize settings applied to all incoming MIDI notes.

This results in a recorded performance that is already quantized.

## Part VII—MIDI Sequencing

**Swing** The swing parameter causes every other note to be delayed by a specified amount to produce the “swing” effect. As the parameter value increases, the delay amount increases. At 100%, the delay amount is equal to one quantize grid length interval

(for example, a 1/16th note (semiquaver) at a quantize grid length of 1/16th note).

The figure below shows the effects of applying swing and quantizing attacks:

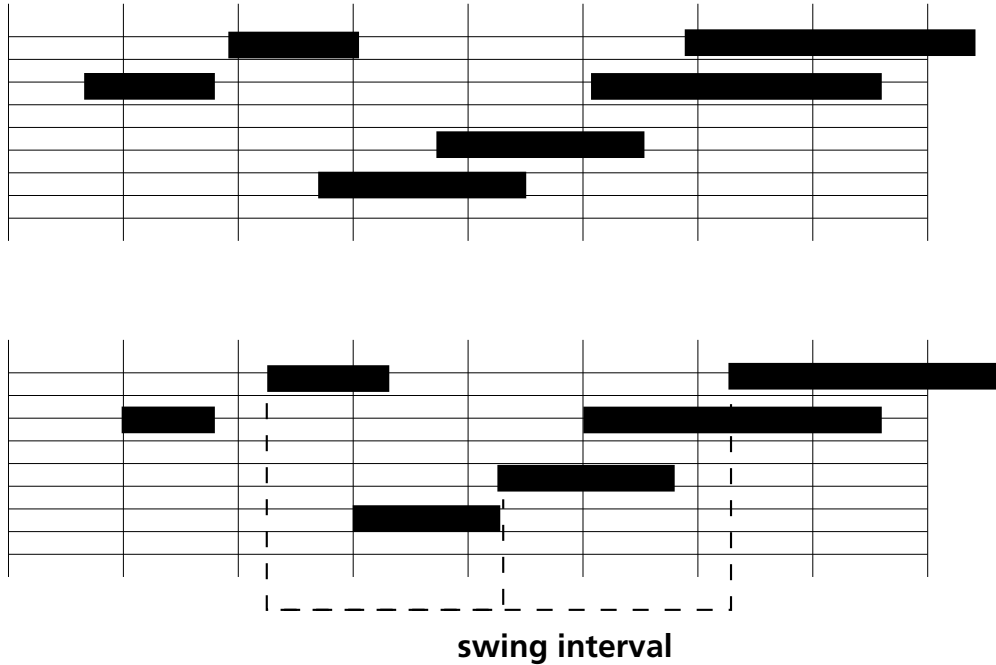

**Randomize** When Randomize is any value but zero, the amount that notes are quantized is randomly varied. This produces a more natural effect (sometimes called a “human feel”) because notes don’t always

start or end exactly on the quantized values. Lower Randomize settings move the notes to random positions closer to the quantize value while higher settings produce more variation.

**Sensitivity** Sensitivity defines the region where notes will be moved to the grid. If Sensitivity is set to 100%, notes will be moved to the nearest grid line regardless of where they originally play. If Sensitivity is less than 100%, only the notes within a certain distance of a grid line will be moved. For example, at

50%, only notes that are within 1/2 a grid interval will be moved. At 0%, no notes will be moved.

The figure below shows the effect of 50% sensitivity. Since only the first note falls in the shaded “sensitivity zone”, it is the only note that is actually quantized.

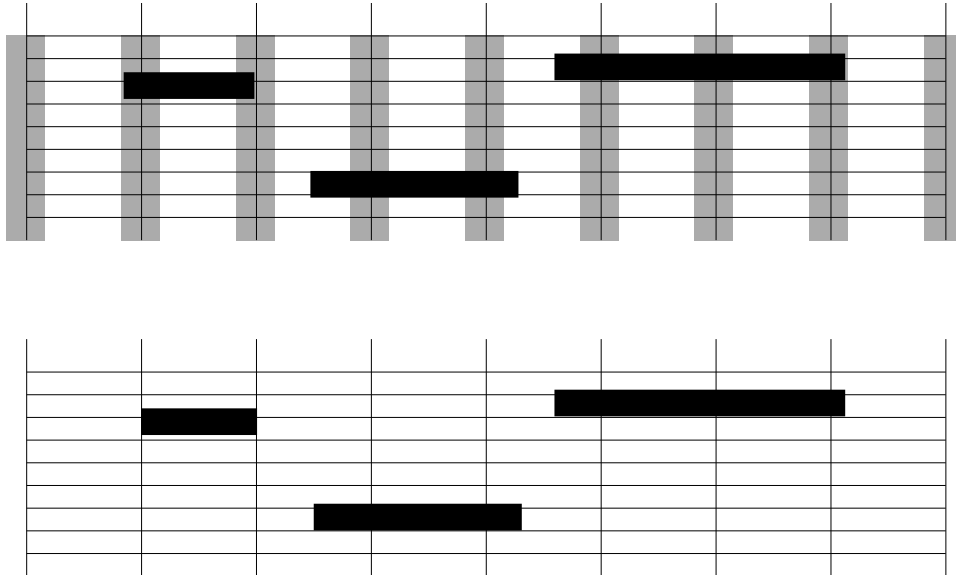

**Strength** The Strength parameter determines how much each note is moved towards the nearest grid line. When set to 100%, the notes will be moved exactly to the grid line. At 50%, the notes will only

be moved halfway towards the nearest grid line. This is also a “humanization” feature that can be used to make quantized music sound more natural.

## Part VII—MIDI Sequencing

**Offset** The number of ticks added or subtracted to the start time of selected notes is the Offset. Use this parameter to add a set number of ticks to notes for a delay effect, or subtract a set number of ticks to cause notes to play earlier in time (for example, “ahead of

the beat”). This field will accept  $\pm 960$  ticks (in 4/4 time, this equals one quarter note (crochet)).

The figure below shows the result of attacks quantized and a small offset applied:

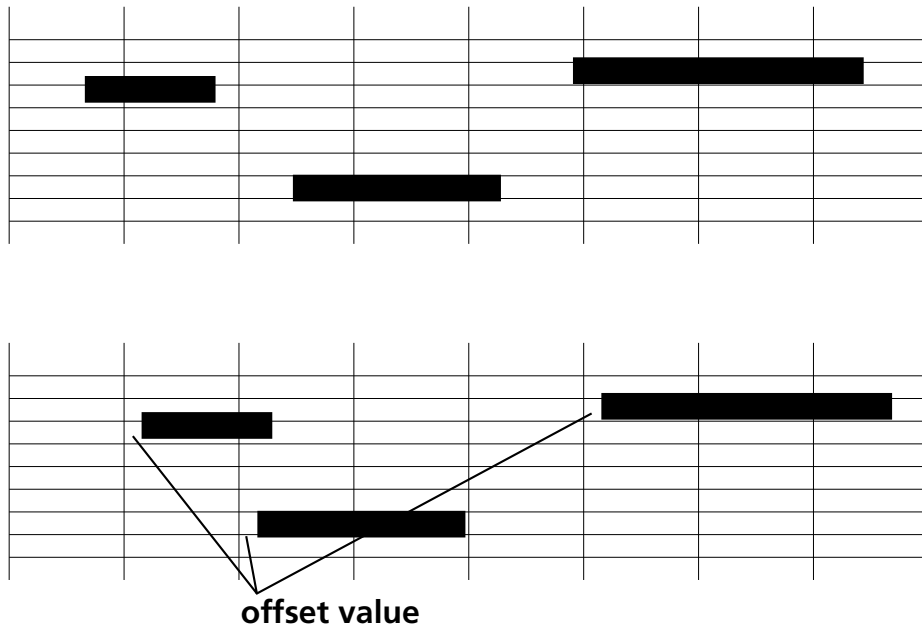

---

### Transpose

The SX-1 sequencer supports non-destructive transpose. This parameter can be applied to tracks individually.

**Transpose Mode** Opens the Transpose menu from which you can select the following scales:

**Interval** When selected, transposition is based upon steps and octaves.

**Diatonic** When selected, notes get transposed to a specific key and scale as specified in the To Key/To Scale field (see below). Using this setting will cause notes to be moved to the nearest note in your chosen scale.

**Key and Scale** For Key and Scale, the track can be transposed from a specific key/scale to a new key/scale. Use the From Key setting (described here) to make the sequencer treat the selected notes as being in a specific key. Then use the To Key settings to make the sequencer transpose to a new key from the From Key scale. In short, the Key and Scale setting allows notes to be shifted up or down to a new key before the actual transpose scale is applied.

**Resolve Mode** If set to Upward, notes are always shifted upwards to the next nearest key/scale note. If set to Downward, notes are always shifted lower. If set

to Nearest, then the note will be shifted to the nearest scale note regardless of proximity. If set to Random, the sequencer will randomly shift notes up or down to the nearest scale notes.

**Steps** In this field, enter the number of chromatic steps (semitones) by which you want the track transposed. This is used before any keys and scales are applied and can be active for any Transpose Mode.

**Octaves** In this field, enter the number of octaves you want the track transposed. This is used before any keys and scales are applied and can be active for any Transpose Mode.

**From Key** This parameter specifies the track's current key. It is only available when Transpose Mode is set to Key and Scale.

**From Scale** This parameter specifies the track's current scale. It is only available when Transpose Mode is set to Key and Scale.

**To Key** This parameter specifies the track's target key. It is only available when Transpose Mode is set to Diatonic or Key and Scale.

**To Scale** This parameter specifies the track's target scale. It is only available when Transpose Mode is set to Diatonic or Key and Scale.

## Track Offset

Use the Track Offset field to apply a fixed offset to a whole track. The offset value can be up to  $\pm 10$  seconds.

## RELATED LCD screens

There are several LCD screens that reflect the MIDI parameters found on the MIDI Track tab of the VGA Track screen. These related screens are pictured on the following pages. All of the parameters found on these screens are identical to the parameters in the MIDI Track tab and are explained on the previous pages.

**LCD Non-Destructive Quantize Screen** The parameters on this screen apply to the nondestructive Quantize feature.

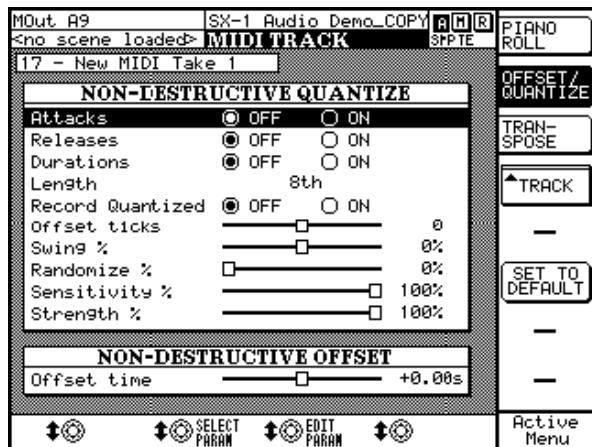

## TIP

The Track Offset feature is useful for adjusting a track's overall "feel" against the other tracks, and compensating for external MIDI gear with long latency times.

To reach this screen, from the **LCD ACCESS** section, press **MIDI TRACK** and then the **OFFSET/QUANTIZE** soft key.

## LCD Non-Destructive Transpose Screen

The parameters on this screen apply to the nondestructive Transpose feature.

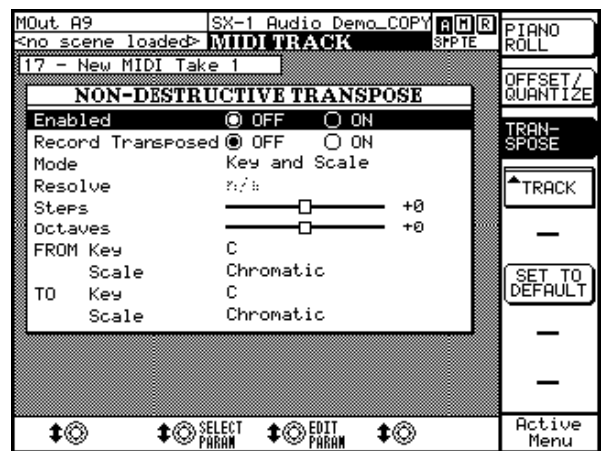

To reach this screen, from the **LCD ACCESS** section, press **MIDI TRACK** and then the **TRANPOSE** soft key.

## Step Record Mode

Step Record allows you to enter MIDI notes one at a time. The MIDI parameters for each note can be determined before entry, including velocity, duration, and offset. Then, with the SX-1's sequencer in Step Record, each MIDI note received is dropped at the playhead's position.

The sequencer can also be set to automatically advance to the next beat in preparation for the next note. The following definitions cover the Step Record mode's parameters and operations.

### Step Parameters

The Step Record mode operation is accessed from the Edit Operation menu in the Piano Roll tab (of the VGA's Tracks screen), the SELECT EDIT OP soft knob in

the LCD MIDI TRACK screen, and the front panel's **STEP** key in the **MIDI REC MODE** section.

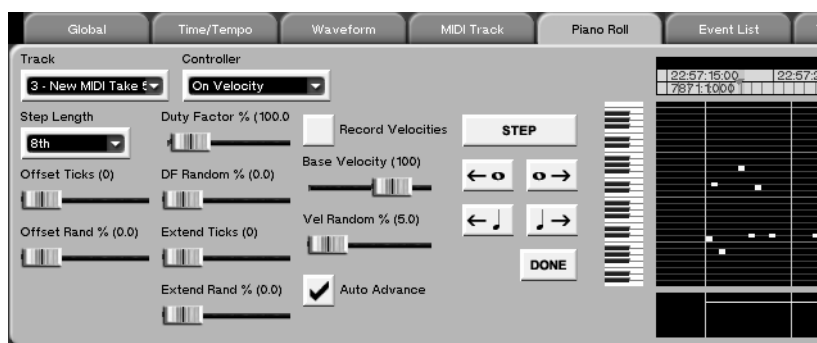

The parameters listed below become available when Step Record Mode is enabled:

**Step Length** This determines the time value of the note (or notes) to be entered. Values are given in standard rhythm notation form and range from whole notes, to fractional (like 8th and 16th notes (quavers and semiquavers)), triplets, and dotted values.

**Offset Ticks** With a value of zero selected, stepped notes will always fall exactly on the beat (as determined by the note's Step Length). Set the slider to a number greater than one, and the stepped note will fall after the beat (from 1 to 3840 ticks).

**Offset Rand %** This parameter randomizes the Offset Ticks parameter. The greater the value, the more random the Offset Ticks effect (as determined by the Offset Ticks slider) is.

**Duty Factor %** This setting modifies the Duration setting. At a setting of 100%, a note entered with a duration setting of a quarter note is written to the track as a quarter note. However, at a setting of 85%, the note written to the track would be only 85% as long as a quarter note. This makes it relatively easy to enter a staccato performance, or, with percentages larger than 100%, a legato performance where notes blend into each other. Note that, even though the

duration of the new MIDI events are modified with this setting, the duration of the Steps is always a constant note value.

**DF Random %** This parameter randomizes the Duty Factor % parameter. The greater the value, the more random the Duty Factor effect (as determined by the Duty Factor slider) is.

**Extend Ticks** This setting is somewhat like Duty Factor, in that it modifies the Duration value. However, instead of adding or subtracting a percentage of the new note duration to the new events, Extend Ticks adds or subtracts a constant number of ticks to/from the duration of the new events, depending on the setting of this field.

**Extend Rand %** This parameter randomizes the Extend Ticks parameter. The greater the value, the more random the Extend Ticks effect (as determined by the Extend Ticks slider) is.

**Record Velocities** Check this box to record the velocity values of your stepped notes as they are played.

**Base Velocity** Sets the velocity floor for step recorded notes. For example, with a value of 100, all notes generated have a minimum velocity of 100.

**Vel Random %** This parameter randomizes the Base Velocity parameter. The greater the value, the more random the Base Velocity effect (as determined by the “Base Velocity slider) is.

**Auto Advance** Check this box to have the sequencer automatically advance to the next beat after a note is played (as determined by the note’s Step Length). With this box unchecked, you will not move to the next grid line until you have pressed the STEP key.

**STEP** This key advances the sequencer to the next beat, as determined by the Step Length field. You can

also think of the STEP key as a rest whose value is tied to the Step Length field.

**Whole Note Forward & Back** Use these keys to advance the sequencer forward or back by whole note (semibreve) beats. You can also think of the Whole Note Forward key as a whole note rest.

**Quarter Note Forward & Back** Use these keys to advance the sequencer forward or back by quarter note beats. You can also think of the Quarter Note Forward key as a 1/4 note rest.

## Step Recording

Follow these directions to perform a Step Record operation:

- 1 **From the front panel, press STEP in the MIDI REC MODE section. The LCD screen will display a prompt asking you which MIDI track you would like to record on. Use the SELECT TRACK soft knob to choose your track and press the OK soft key. If you do not already have a MIDI slot ready, Step Record will make one for you.**

After pressing OK, the selected MIDI track is automatically record enabled and waiting for your first MIDI note.

You can also enable Step Record by choosing Step Record from the Edit Operation pull-down menu on the Piano Roll tab on the VGA

- 2 **From the Piano Roll tab on the VGA, or the MIDI TRACK screen’s Step Record operations screen on the LCD (or the duration keys on the keypad), choose a Step Length for your first stepped note. At this point, also enter any other attributes you would like your first note to have (such as velocity or offset).**

- 3 **Enter a note from your connected MIDI controller. If the Auto Advance box is checked, the sequencer will record your note and automatically advance to the next beat. If the Auto Advance box is not checked, press Step to move to the next beat.**

- 4 **If you would like to insert a rest or just skip ahead a few beats, press the Whole Note Forward, Quarter Note Forward, or STEP keys the appropriate number of times.**

- 5 **Repeat from Step 2 until your passage is complete. Press the DONE button in either the VGA or LCD screens. You will automatically be taken out of the Step Record mode.**

### TIP

To add stepped notes to a track that already has data, use the Merge function. Before beginning the Step Record operation, simply press **MERGE** from the **MIDI REC MODE** section. This puts the sequencer into Record Merge instead of Record Overwrite Mode. Then perform Step Record as usual, and your newly stepped notes will be added to the track’s existing MIDI data.

## TIME/TEMPO Management

The SX-1 sequencer has screens for setting your project's meter, tempo, and click track. These settings are saved with your project.

## VGA Control

Most of your project's click track settings are made in the Time/Tempo tab (described here).

In order to record the initial tracks for a project, you often need some sort of click track to follow along with the project's selected tempo. The SX-1 can gen-

erate its own MIDI click track for just this purpose. The MIDI click track's operation is determined by the settings in the Time/Tempo tab. This tab is part of the VGA Track screen.

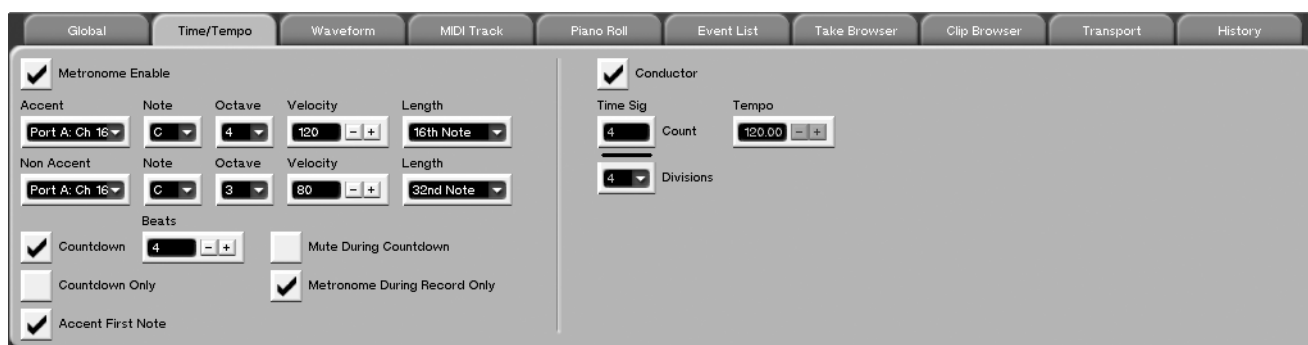

**Metronome Enable** Check this box to enable the metronome/click.

**Accent** Choose the output port and channel that the accented click (a bar's first downbeat) is sent to.

**Note** Select the MIDI note for the accented click.

**Octave** Choose an octave for the accented click's note.

### TIP

*Many popular units put a click sound on C# 1 for a drum instrument.*

**Velocity** Choose a velocity value for the accented click's note.

**Length** Select a duration (given in note values) for the accented click's note.

**Non Accent** Choose the output port and channel that the non-accented click (all beats following a bar's first downbeat) is sent to.

**Note** Select the MIDI note for the non-accented click.

**Octave** Choose an octave for the non-accented click's note.

**Velocity** Choose a velocity value for the non-accented click's note.

**Length** Select a duration (given in note values) for the non-accented click's note.

**Accent First Note** When enabled, the metronome will play a bar's first note (or click) with the Accent metronome settings. All of the bar's following metronome notes are played with the Non Accent settings. When disabled, the Accent settings do not apply and only the Non-Accent settings are used for the metronome notes.

**Countdown** Check this box to have the metronome perform a countdown. When enabled, the countdown plays before entering record or play.

### NOTE

*The transport will move during the countdown.*

**Beats** Select the number of beats you want for the countdown.

**Countdown Only** Check this box to have the metronome play only during the countdown. Then,



when record or play is entered, the metronome will stop playing.

**Mute During Countdown** Mutes the metronome during the Countdown period.

**Metronome During Record Only** Selecting this option will only play the metronome when the machine is in record mode. If not selected, the SX-1 will generate a click when the transport is in motion.

## LCD TIME/TEMPO Screens

There are several LCD screens that reflect the time, tempo, and metronome parameters found on the TIME/TEMPO tab of the VGA Track screen. These related screens are pictured on the following pages. All of the parameters found on these screens are identical to the parameters found in the MIDI Track tab and are explained on the previous pages.

**LCD TEMPO Screen** The parameters on this screen apply to the current project's tempo and meter.

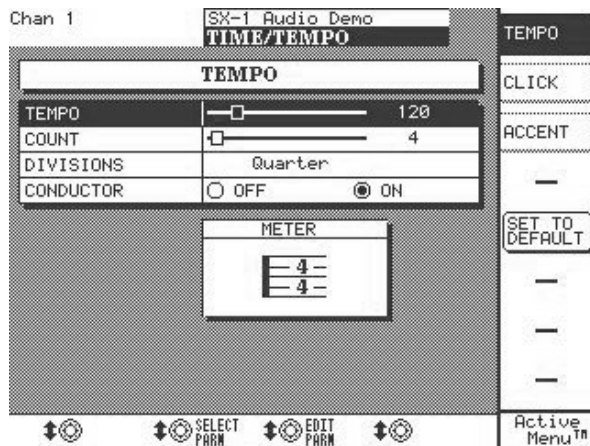

To reach this screen, from the **LCD ACCESS** section, press **TIME/ TEMPO** and then the TEMPO soft key.

**Conductor** This enables the Conductor Track (it works the same as the Conductor Track Key in the VGA's Main Menu Bar). When checked, the Conductor Track (which is visible from the Event List tab) is used to specify the tempo and time signature of your project. When not checked (disabled), the tempo and time signature settings in the VGA Main Menu Bar are used.

**LCD CLICK Metronome Screen** The parameters on this screen apply to the current project's metronome and countdown.

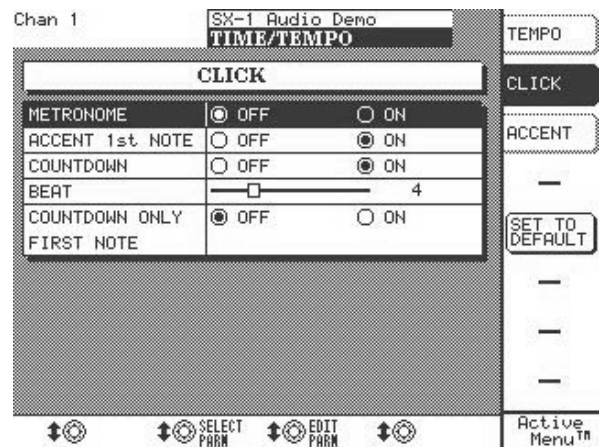

To reach this screen, from the **LCD ACCESS** section, press **TIME/ TEMPO** and then the CLICK soft key.

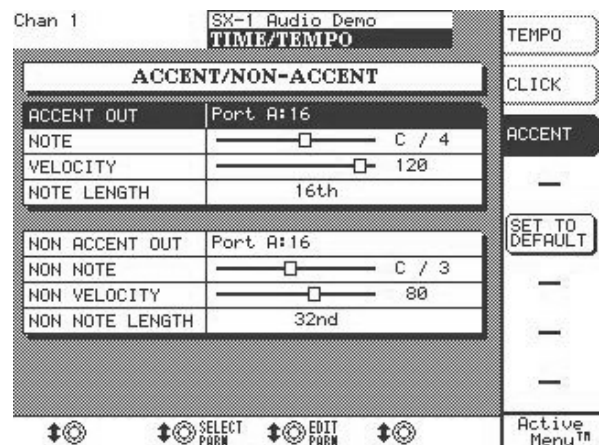

**ACCENT** The parameters on this screen apply to the current metronome's accent and non-accent settings.



To reach this screen, from the **LCD ACCESS** section, press **TIME/ TEMPO** and then the ACCENT soft key.

### Managing MIDI Takes

Several MIDI performances can be assembled (imported or recorded) to form a *take*. The SX-1 has a pool of MIDI takes associated with a project. The takes within this pool can be assigned to any slot of the MIDI sequencer for playback (they are not fixed to the track that they were originally assembled on). Takes can also be imported and exported between projects. They are managed from the Take Browser tab of the VGA's Tracks screen.

MIDI takes are loaded to track slots by clicking on the  icon to the right of the  key in the Tracks screen. Then, selecting the Load MIDI Take command from the pop-up menu reveals the takes that are available for loading.

#### TIP

For step by step instructions on loading MIDI and audio takes to tracks, see the *Quick Start Guide*.

### VGA Take Browser Tab

Here you can manage your current project's takes and import takes from other projects. You must load takes into slots by using the slot button on the VGA.

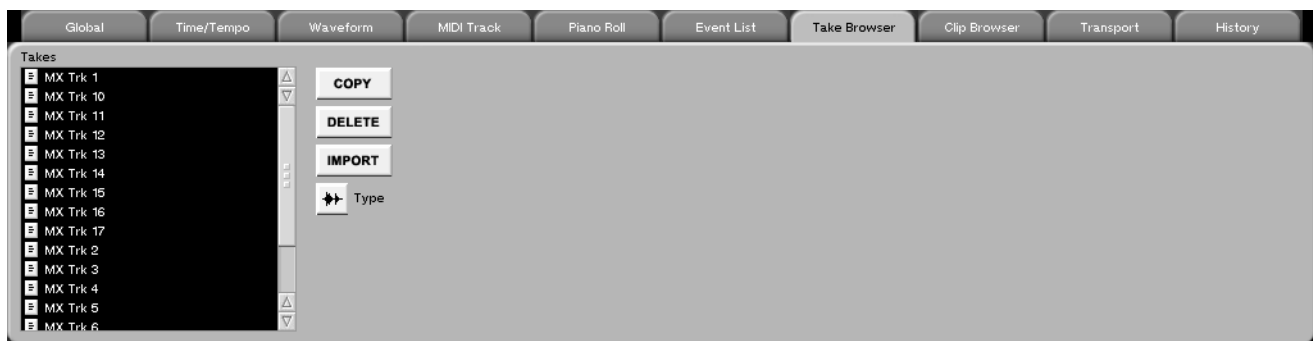

**TYPE** This allows you to toggle between viewing MIDI takes or audio takes.

### Managing MIDI Files

**The Philosophy** When dealing with audio, the SX-1 names individual events Clips, and these may or may not have anything to do with a Take. However, when dealing with MIDI, one note is a single event, making a direct association impossible. On the SX-1, MIDI data exists on Takes only.

For instance, in a live recording scenario, having only one audio event per Take is normal, while a MIDI drum track could have as many as 2000 individual events. Thus, you will not be seeing MIDI data in the Clip browser.

When you record or import MIDI on the SX-1, the data is placed onto a MIDI Take (just as Clips on a

track are). From then on, the behavior is the same as an audio Take.

The SX-1 can import and export both types of Standard MIDI Files: Type 0, which collapses all of the MIDI tracks down to one track, and Type I, which leaves the MIDI tracks separate.

As such, it is important that you know how to manage your MIDI information effectively.

Use the Take Browser tab (found in the Tracks screen of the VGA and shown above) to manage takes and clips.

Here you can manage your current project's takes and import takes from other projects.

## Standard MIDI Files

The SX-1 sequencer can import and export Type 0 or 1 SMFs (Standard MIDI Files). Once imported, these files are added to the project's Take Browser tab.

### TIP

To learn how to load a Take into a track, see the SX-1's *Quick Start Guide*.

## VGA SMF Management Tab

To reach this tab, from the **MAIN DISPLAY MODE** section, click on the SMF Management tab.

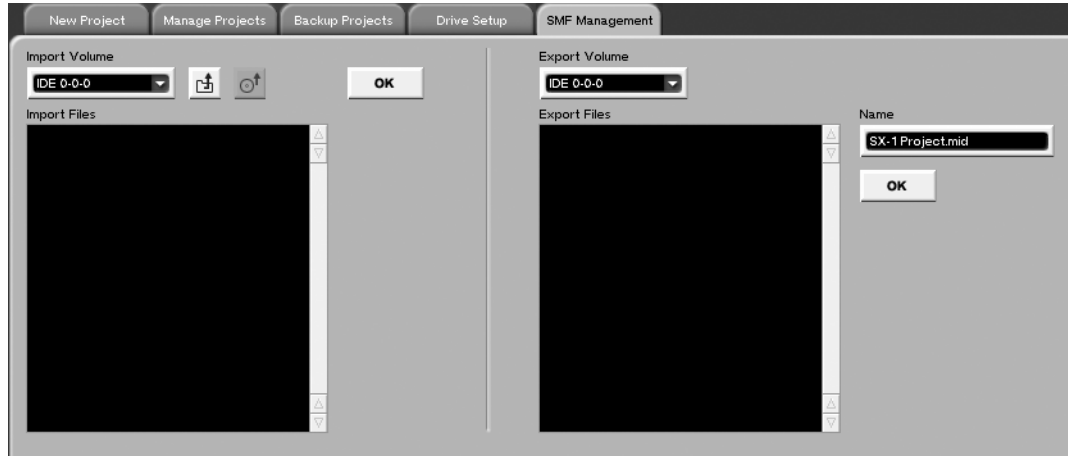

**Import Volume** This is the disk where the SMF files that you want to import are located.

**Folder icon** Press to step up or back through the volume's folder hierarchy.

**CD icon** This button unmounts and ejects a disc in the CD-RW drive.

**Import Files** This window displays the SMF files that are available for import.

**Export Volume** Selects the volume to which you will export the SMF files.

**Name (In Export Folder)** Use this field to give the file that you are exporting a name.

## VGA Main Menu SMF Commands

The Project menu on the VGA menu bar also features handy shortcuts for the SMF Management tab on the VGA Project screen.



Both the Import SMF and Export SMF commands immediately open the SMF Management tab.

## MIDI Monitoring

The Overview screens are recalled by pressing the **OVERVIEW** key in the **MAIN DISPLAY MODE** section, and then clicking on the corresponding tab for

the overview you want to see. These screens show all the signals running through the mixer at a glance.

### MIDI Overview Screen

This tab displays all the MIDI activity being output by the SX-1's sequencer.

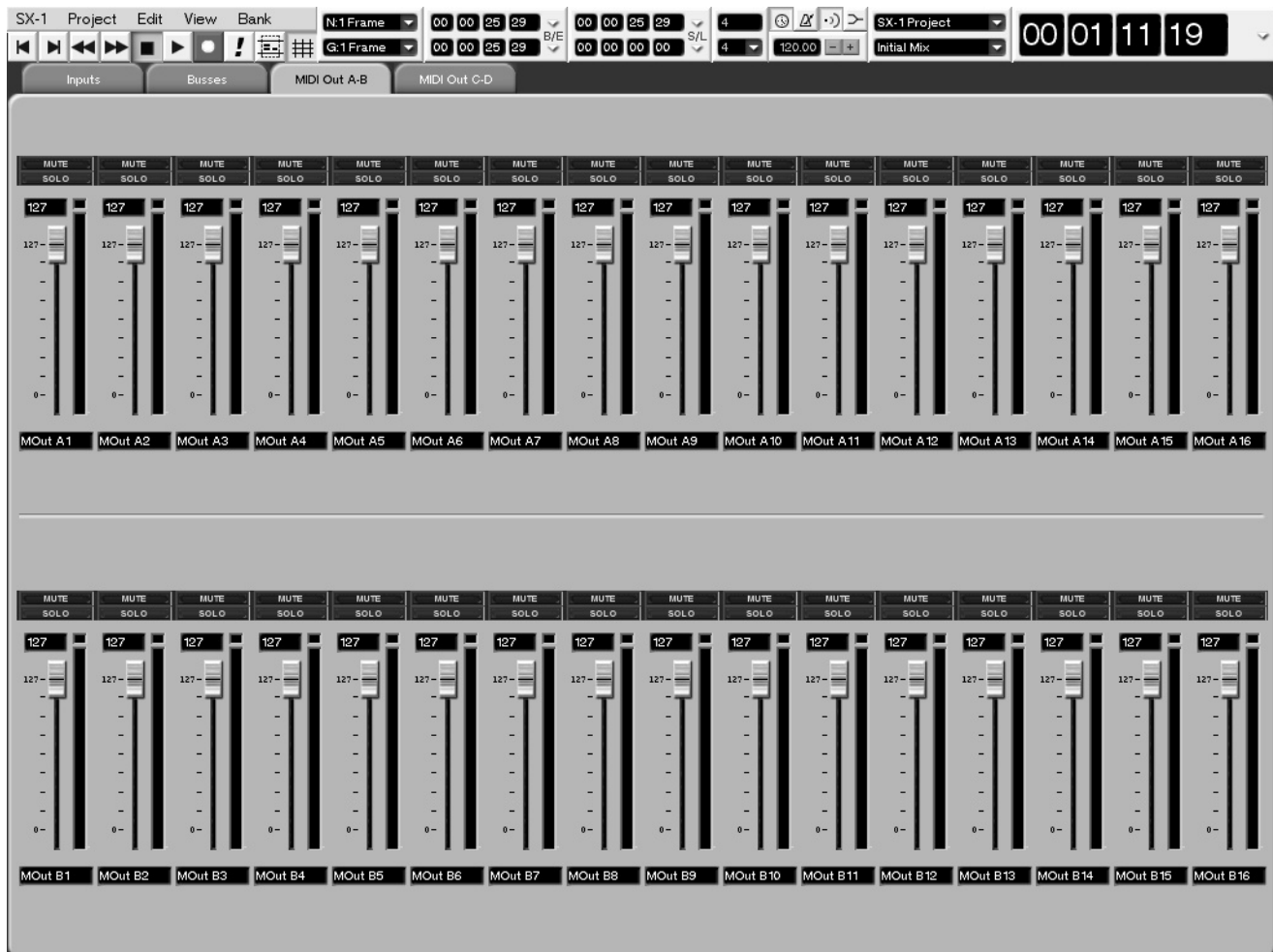

#### TIP

If a MIDI module is not responding and you're not sure why, one of the Overview screen's MIDI Out tabs is a great way of verifying that the SX-1 sequencer is outputting MIDI data on the proper channels. Other trou-

bleshooting tips would include using the keyboard on the Piano Roll tab to see if notes were registering, and using the MIDI LED to ascertain whether or not MIDI is leaving the SX-1.

## LCD MIDI In Overview Screen

Press **OVERVIEW** from the **MAIN DISPLAY MODE** section, and then press the MIDI IN soft key.

Use this screen to view the MIDI data coming in the SX-1's **MIDI IN** port.

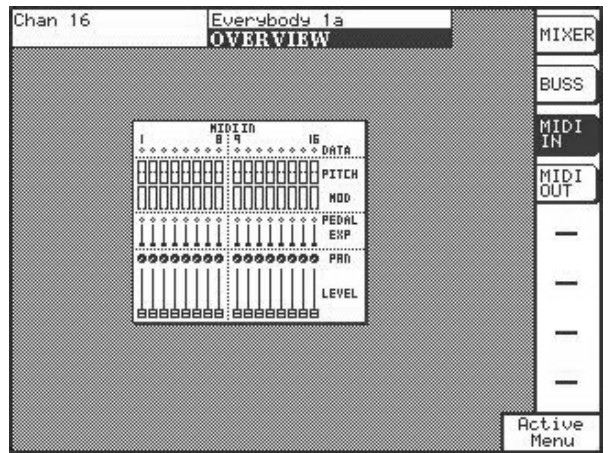

## LCD MIDI Out Overview Screen

Press **OVERVIEW** from the **MAIN DISPLAY MODE** section, and then press the MIDI OUT soft key.

Use this screen to view the MIDI data going out each of the SX-1's **MIDI OUT** ports.

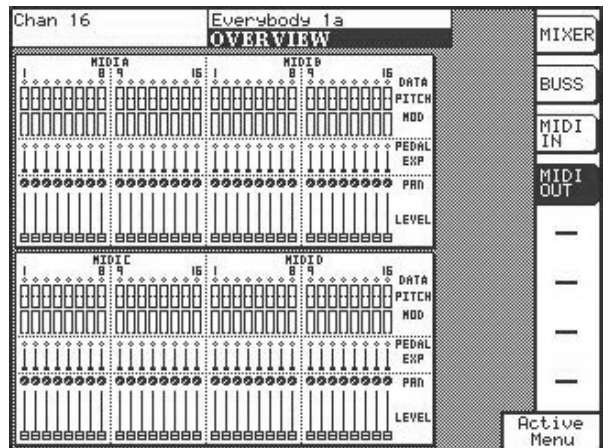

## Part VII—MIDI Sequencing

### MIDI Naming Tab

This tab is found on the VGA's Routing screen. Here you can name the channels for each MIDI Out port.



## Chapter 19 – MIDI Editing

### Tools & Screens

The TRACK screen and its associated Piano Roll tab provide one of the main work areas for MIDI note and region editing on a VGA display. These work areas are mirrored on the LCD display by the TRACKS and

PIANO ROLL screens. The Tracks screens allow coarse editing and region selection on one or more tracks. The Piano Roll screens provide a larger view of the MIDI performance for more detailed editing.

### A recap — onscreen tools for working with MIDI events

There are several tools located in the VGA's Main Menu Bar that determine the behavior of the mouse's cursor.

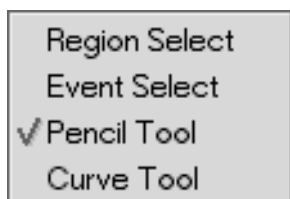

Right-click on the tool icon (like those pictured here) to select the tool you wish to work with.



**Region Select Tool** Use this tool for selecting (highlighting) regions to edit. Click and drag to select a region. It works in both the Track and Waveform screens.



**Event Select Tool** Use this tool to select audio and MIDI events. Just click on the

event or group of events you want to select. It works in both the Track and Waveform screens (and the Piano Roll screens for MIDI events).



**Pencil Tool** Use this tool for drawing in data (automation, continuous controller data, and MIDI notes). Simply click, or click and drag where you want the data drawn. It works in the automation's Auto Track and MIDI track Piano Roll tabs.



**Curve Tool** Allows precise curves to be drawn in for automation controllers and MIDI control data.

#### TIP

*MIDI notes and regions can be treated quite similarly to audio waveforms and regions. Even the editing operations accessed by the keys in the **EDITING** section are applicable. To read about these editing operations, see "Editing Audio" on page 127.*

### Using the Tools

The SX-1 has two editing modes that might not be obvious to the uninitiated user. However, these modes provide powerful tools - which can vastly speed up certain aspects of controller editing. You can reach the Pencil and Curve tools from the VGA's

Main Menu Bar either by right-clicking on the tool icon itself, or just pressing the [ESC] key repeatedly to cycle through the choices (shown above). It should be noted that both of these editing tools only work in the VGA screen.

## Part VII—MIDI Sequencing

**Pencil Tool** The first mode consists of a pencil tool. The Pencil Tool can draw MIDI Continuous Controller events on the Piano Roll tab or Automation events on the Automation VGA screen.

The example below is of the Automation screen's Auto Track tab. The pencil tool has been used to draw in a number of curves for the kick drum's fader to follow.



This next example below is from the Piano Roll tab on the Tracks screen. The bar at the bottom of the screen is currently displaying MIDI Note On velocity.

Using the pencil tool, the Note On Velocities of all the notes have been drawn in.

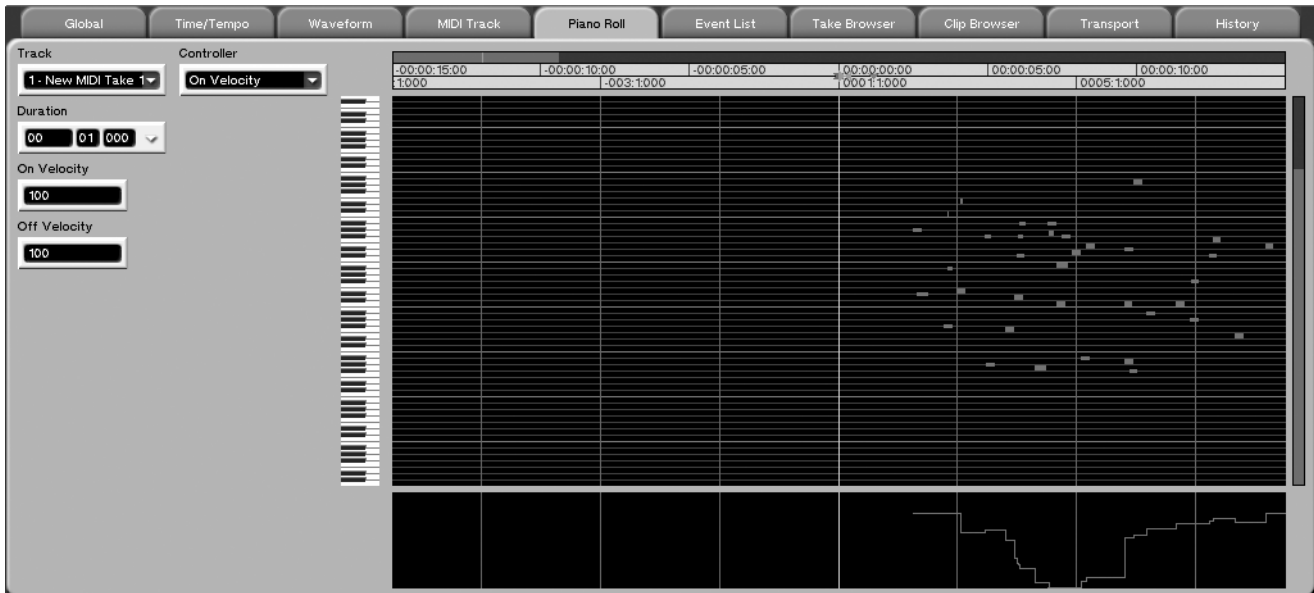



This screenshot below shows that when the Pencil Tool is selected, menus for Duration, On Velocity and Off Velocity become visible. It is possible to click directly onto the Piano Roll tab and enter notes (this is how the

notes were entered in the preceding example). These three fields determine the length (duration) and volume (On/Off Velocity) of notes entered in this manner.

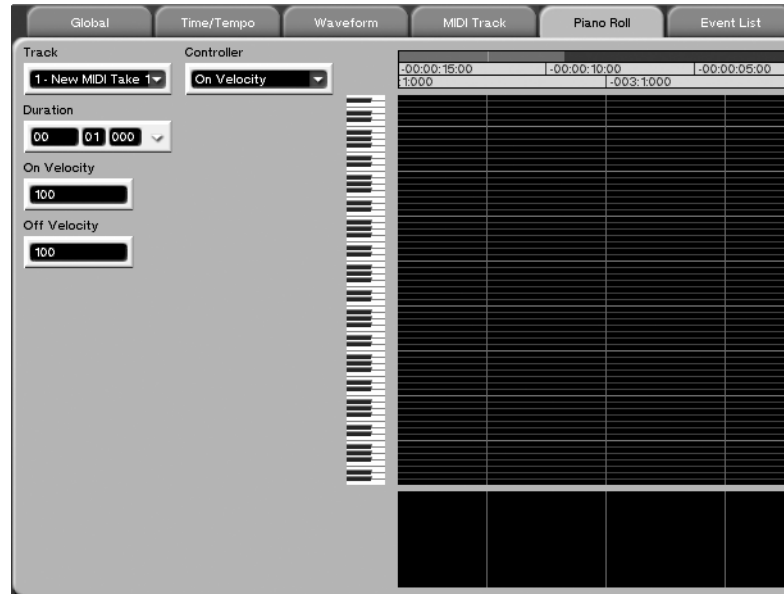

**Curve Tools** This edit tool allows smooth curves to quickly and easily be drawn into both the Piano Roll's MIDI controller display and the Automation

Screen's Auto Track tab. The figure below shows the previous Auto Track tab example after clicking and dragging with the Curve Tool.

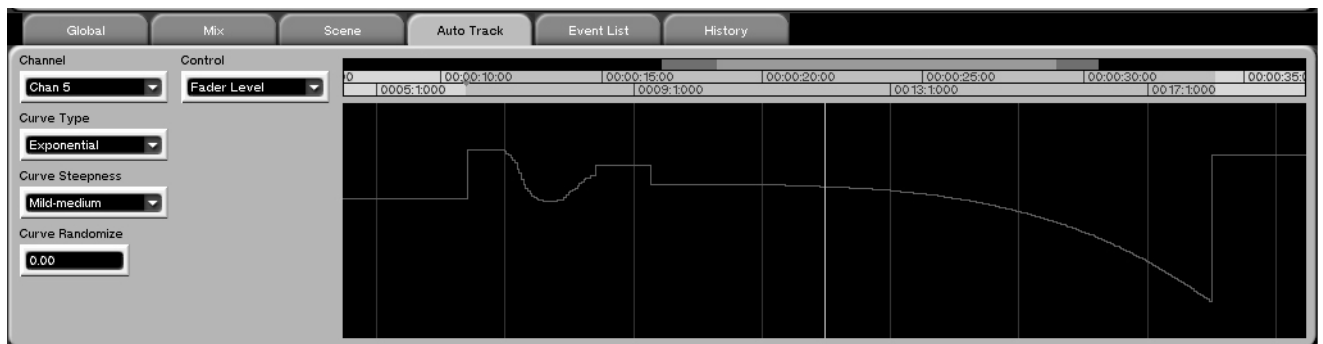

## Part VII—MIDI Sequencing

The figure below shows the previous Note On Velocity readout after a quick click and drag with the Curve Tool.

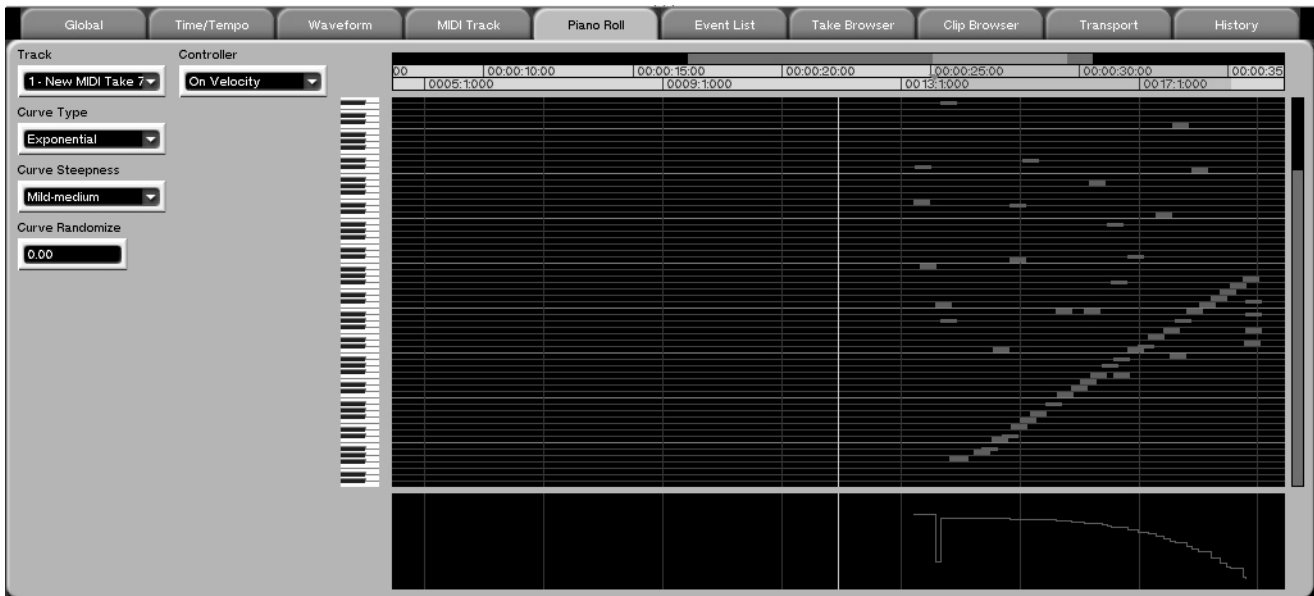

The figure below shows the three fields that appear on the Piano Roll tab when the Curve Tool is selected. The Curve Type field can be set to any one of four curve

shapes to facilitate editing versatility. The choices are Linear, Logarithmic, Exponential, and Cosine.

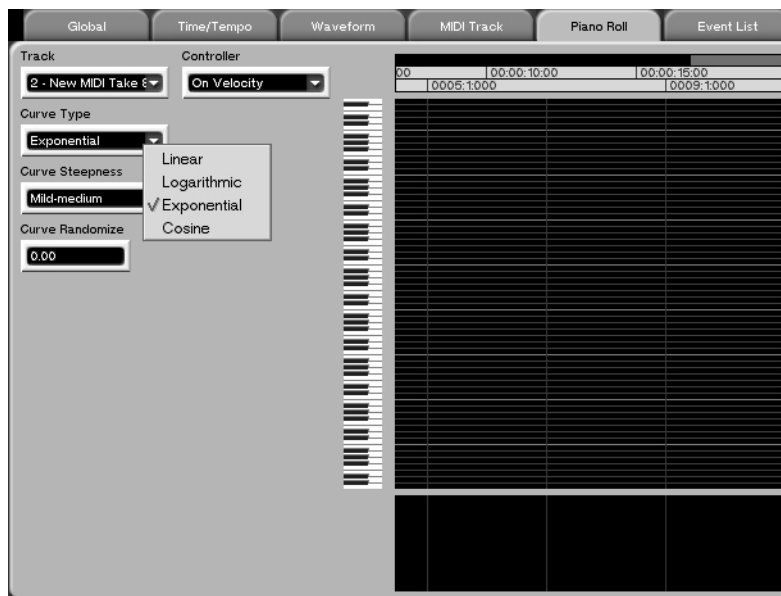

**Curve Steepness** This field allows you to select anything from a very mild to an extremely steep curve.

**Curve Randomize** This field allows you to set a value for variance, where the higher the entered value, the less perfect the curve. At the highest values the curve drawn will resemble static.

## MIDI Piano Roll Screens

Piano Roll screens are available on both the VGA and the LCD screens.

### VGA Piano Roll

From the Tracks screen on the VGA, click on the Piano Roll tab to reach this window.

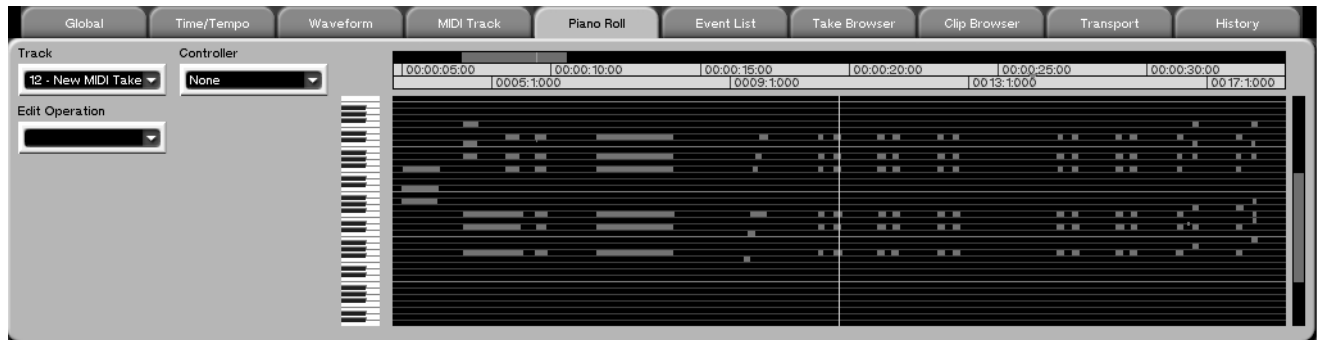

**Track** Click on the arrow to select the MIDI track you want to view.

**Controller** Selects the type of MIDI controller or Control Change message you want to view or edit. When a MIDI data type is selected, a window to dis-

play this information opens below the Piano Scroll. When none is selected, the window is hidden.

#### TIP

*The MIDI Controller View window is only available through the VGA display. The LCD Piano Roll screen does not have this feature.*

### Edit Operation

Once a MIDI note, event, or region is selected, a variety of edit operations are possible. Click on the arrow in this field to open the Edit Operation menu to choose an edit operation. These operations are described on the following pages.

**Add Note** Use this operation to add a specific note at a particular location.

**Start Time** This field allows the start time of the note to be entered.

**Note** This field designates which MIDI note will be entered on the track.

**On Velocity** This field sets the velocity of the note, from 0-127.

**Off Velocity** This field allows the user to determine the Note Off velocity, from 0-127.

**Duration** This field determines the point where the new note will end.

**Add Program Change** This operation allows you to manually enter MIDI Program Changes.

**Time** Use this field to set the point where the program change will occur.

**Program Number** This field lets you select a program change number from 0-127.

**Adjust Duration** This operation lets you change the duration (or length) of a selected note (or notes).

**Adjust %** This field represents the percentage that the selected notes are lengthened.

**Adjust Velocity** This operation lets you change a selected note's Note On velocity value. One or more notes can be processed simultaneously.

**Adjust %** This field represents the percentage that the selected notes' velocities are changed.

## Part VII—MIDI Sequencing

**Apply to** This field allows you to choose whether the adjust velocity operation will effect the Note On, Note Off, or Note On and Off values.

---

**Crescendo** Use this operation to create a MIDI crescendo or decrescendo.

**Mode** Determines whether change values will be absolute or percentage based.

**Start %** In this field, enter the Note On velocity value for the beginning of the crescendo.

---

### Event Editor

After selecting an event using the Event Select tool, and selecting Event Editor from the Edit Operations tab, a number of fields will appear to the left of the Piano Roll.

**Time** This field allows the start time of the event to be modified.

**Duration** This field allows the duration of the event to be set.

---

### HyperSelect

This operation allows you to select events in different ways by applying up to ten “rules”. A rule is created by filling in the fields described below.

Edited data can be modified or sent to other tracks.

**Select from** This field allows you to select data from the current track, all MIDI tracks, or all audio tracks.

**Done action** This field gives you three choices of what type of action to take on the selected data: retain selection, split to consecutive tracks, or split and merge to a single track.

**Must pass** This field determines whether the selected data must pass all rules or any rule selected.

---

### Move

Use this operation to move events by a specified amount, earlier or later in time.

**Apply to** This field defines whether the move operation will affect the selected event’s beginning, end, or both.

**End%** This field sets the Note On velocity value for the end of the crescendo.

**Curve** This field allows the shape of the crescendo to be set. The choices are: Linear, Logarithmic, Exponential, and Cosine.

**Steepness** Determines the grade of the crescendo’s curve.

**Randomize** Determines the amount of variation introduced into the crescendo’s curve.

---

**Pitch** This control determines the pitch of the event.

**On Velocity** This slider determines the event’s On velocity.

**Off Velocity** This slider determines the event’s Off velocity.

---

**Rule** This field selects from any of the ten rules.

**Type** This field selects which specific data will be selected by the Edit Operation (such as aftertouch, pitch, sustain, etc.).

**Select if** This field adds a modifier to the selection. That is, choices like “is equal to” or “is greater than” determine how the data in the Type field pertains to the selection in the Value field.

**Value** This field sets the specific value that the Select if field uses to select events. For example, if Pitch was chosen in the Type field, and “greater than” was chosen in the Select if field, and C2 was chosen in the Value field, then any note from C#2 and above would be selected by the HyperSelector.

---

**Move Events** This field determines whether the events are moved sooner or later in time.

**Amount** Use this field to define the amount by which the events are moved. The field can be: SMPTE, hours:minutes:seconds, bars:beats:ticks, feet:frames, or samples.

---

### Quantize

This is a destructive quantize. That is, it writes quantize changes directly to the MIDI performance. For a

more detailed discussion of the quantize parameters, see “Quantize Controls” on page 140.

---

### Randomize Duration

This operation allows the SX-1 to randomly vary the duration of selected notes.

**Randomize %** The percentage of time that the notes’ durations will be randomized.

---

### Randomize Time

This operation allows the SX-1 to randomly vary the timing of selected notes.

**Randomize %** This field lets you set a strength percentage.

**Maximum** This field determines the maximum allowable amount of variance.

**Randomize End Times** Check this box to vary note durations.

---

### Randomize Velocity

This operation allows the randomization of selected MIDI note velocities.

**Randomize** This slider determines the percentage of variance.

**Base Velocity** Use this slider to determine the selected notes’ initial velocities.

**Apply To** This field allows the selection of Note On, Note Off, or Both as possible targets for the randomization process.

---

### Repeat Selection

This operation allows the selection to be repeated a specified number of times. Repeats are pasted sequentially, end to end.

**Merge Events** Leave this box unchecked if you would like the repeats to overwrite pre-existing data. Check this box if you would like the repeats to be merged with pre-existing data.

**Count** This field determines the number of repeats.

---

### Reverse

This operation takes the selected area or event and reverses it.

---

### Set Duration

This operation sets the duration of all selected notes to a single value.

**Duration** This field determines the selected notes’ length.

---

### Set Min/Max Duration

This operation lets you set floor and ceiling values for MIDI note durations.

**Maximum Duration** This field determines the largest (longest) value desired for the selection’s note duration.

**Minimum Duration** This field determines the smallest (shortest) value desired for the selection’s note durations.

---

---

### Set Min/Max Velocity

This operation lets you set floor and ceiling values for MIDI note velocities.

**Minimum Velocity** This slider determines the smallest (most quiet) value for the selection's note velocities.

**Maximum Velocity** This slider determines the largest (loudest) value for the selection's note velocities.

**Apply To** This field allows the selection of Note On, Note Off, or Both as possible targets for the operation.

---

### Set Velocity

This operation sets the velocity of all selected notes to a single value.

**Velocity** This slider sets the velocity value (from 0-127).

**Apply To** This field defines whether the operation will affect the note's On, Off, or Both velocities.

---

### Smooth Events

Use this operation to even out a performance. It is especially useful for smoothing MIDI controller data, as it averages values to produce smooth curves.

**Smoothing Factor** This field determines the amount of smoothing applied to the event selection.

---

### Split Notes

This operation lets you transfer selected notes from one track to several new tracks. Each note of the selection is placed on its own discrete track.

*have a separate track for every instrument in your drum kit. This means you can solo the kick and snare alone, for instance.*

#### TIP

*This function is especially useful when you wish to split up a drum kit that currently exists on one MIDI track. After running the Split Notes edit operation, you will*

**Delete Source Track** Check this box to delete the original track after splitting out selected notes. Leave this box unchecked and the original track will remain untouched.

---

### Step Record

Choosing this operation opens the Step Record dialog for the selected track. When Step Record is active, notes can be entered one at a time from a MIDI controller connected to the SX-1's **MIDI IN**

jack. Step Record's many parameters and basic operations are explained in "Step Record Mode" on page 146.

---

### Transpose

This is a destructive transpose operation—it writes the transposed data directly to the MIDI

performance. For a more detailed discussion of these parameters, see "Transpose" on page 144.

---

### Trim Duration

This operation lets you modify the duration of selected notes by a set amount.

**Trim Amount** This field sets the amount of length to be added (or trimmed).

---

### Trim Velocity

This operation lets you modify the velocity of selected notes by a set amount.

**Trim Amount** This slider determines the amount of change. Velocity values can be added to or subtracted from the original notes' velocities.

---

**Apply To** This field determines which types of MIDI velocities are affected: Note On, Note Off, or Both.

## LCD Piano Roll

This LCD screen reflects the Piano Roll parameters found on the Piano Roll tab of the VGA Track screen. All of the parameters found on this screen are identical to the parameters found in the VGA Piano Roll tab and are explained on the previous pages. Only those parameters that are unique to this LCD screen are explained here.

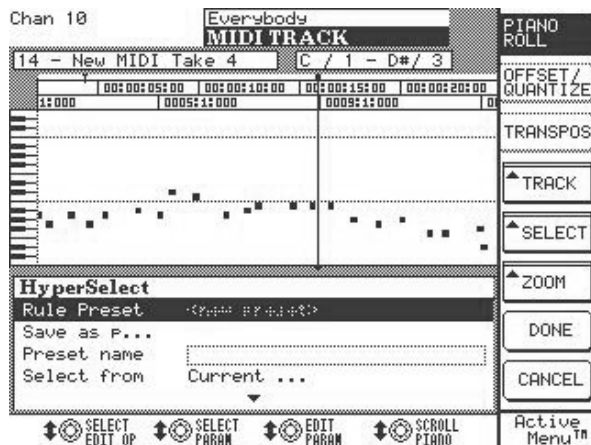

To reach this screen, from the **LCD ACCESS** section, press **TIME/ TEMPO** and then the **TEMPO** soft key.

**SCROLL PIANO** Turn this soft knob to scroll the piano roll screen vertically. This allows you to see higher and lower note ranges.

## Event Lists

Event lists are also a convenient way of editing MIDI notes and MIDI controllers. These windows show events (MIDI as well as audio and edit events) as a chronological list, complete with start times and

other relevant information for each event. There are screens available for both the VGA and LCD.

### NOTE

*It should be noted that the VGA Event Lists for Automation and MIDI show different data.*

## VGA Event List

From the VGA Track screen, click on the Event List tab to reach this window. From here you can select MIDI

events individually or in groups for editing. Selections are color coded for easy visibility.



A selected event is colored gray; the playhead's current position is indicated by light blue—double-clicking an event locates the playhead to that event and highlights it dark blue.

**Track** Selects the track you want to view in the Event List window.

**SCROLL** When Scroll is enabled, the event list follows the playhead. When Scroll is disabled, it does not follow the playhead.

---

### Edit Operations

The Edit operations that are available from this tab are identical to those found on the Piano Roll, with the exception of Change Tempo, Add Lyric, and Add Time Signature. These three operations are only available for the Conductor Track, and can only be instantiated from the Event List tab.

The explanations for the other edit operations can be found starting on page “MIDI Editing” on page 155.

**Add Lyric** Allows you to add lyrics to the project's Conductor Track.

**Time** This field allows the start time of the lyric to be entered.

**Lyric** Add your lyrics in this field. After adding lyrics and pressing the DONE key, the lyrics will appear in the Event List after their respective time stamps.

**Add Time Signature** This operation lets you change the time signature at different points within your project, by inserting a new time signature on the Conductor Track.

**Time** Use this field to set the point where the meter change will occur.

**Numerator** This field sets the number of beats in the bar.

**Denominator** This field designates what type of note receives a full beat.

**Click Interval** This field sets the metronome's Click value (1/8 (quaver), 1/4 (crochet), or dotted 1/4 note (dotted crochet)) for the selection.

**Event Display Filters** Click on the arrow to open a menu from which you can select the type of MIDI data you do not want see. If no MIDI data is filtered, then all the MIDI for the selected track appears in the Event List window.

#### TIP

*Use the filter function to hide extraneous MIDI data that may be cluttering the Event List window. This way, you see just the information you want to edit.*

---

**Tempo Change** This operation allows the SX-1 to effect a tempo change.

**Type** This field allows you to determine whether the type of tempo change will be a single change or an accelerando/decelerando. Selecting accelerando/decelerando allows you to set a beginning and an ending value, smoothly increasing or decreasing the tempo during the time you have set.

**Start BPM** This field sets the tempo at the beginning of the change.

**End BPM** This field determines the tempo at the end of the change.

**Start Time** This field determines the position (relative to the EDL) for the start of the change.

**End Time** This field determines the end of the change.

**Duration** This field determines the duration of the change.

**Curve** This field lets you to select the type of curve the tempo change will follow (Linear, Logarithmic, Exponential, and Cosine).

**Steepness** Determines the grade of the tempo change's curve.

**Randomize** Determines the amount of variation introduced into the tempo change's curve.

**Event Density** This field determines the amount of tempo change MIDI data that makes up the curve. Higher values produce smoother tempo changes while lower values yield more stepped changes (but require less MIDI data).



## LCD Event List

This LCD screen reflects the Event List parameters found on the Event List tab of the VGA Track screen. Most of the parameters found on this screen are identical to the parameters found in the VGA Piano Roll tab and are explained on the previous pages.

Only those parameters that are unique to this LCD screen are explained here.

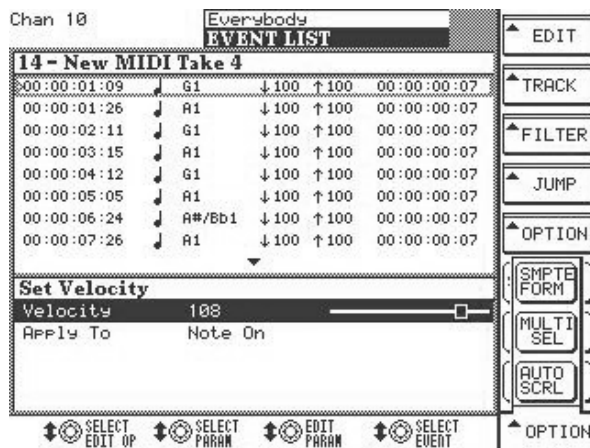

To reach this screen, from the **LCD ACCESS** section, press **EVENT LIST**.

The fields in the main window are as follows: note start time, MIDI note, note on velocity, note off velocity, and note duration. The area below the main window changes according to the edit operation selected.

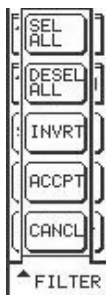

**FILTER** Press this key to open the Filter dialog. It is different from the Filter menu on the VGA Event List tab.

**SEL ALL** Selects all events in the Event List window.

**DESEL ALL** Deselects all events in the Event List window.

**INVRT** Inverts your current selection.

For example, if you have a single note selected and you press **INVRT**, every event **BUT** that note would be selected.



**JUMP** Use this menu to quickly navigate through the Event List window directly from the LCD screen.

**FIRST EVENT** Takes you to the very first event of the selected track.

**LAST EVENT** Takes you to the very last event of the selected track.

**PLAY HEAD** Takes you to the event at the playhead's current position.

**FIRST SEL** This button moves the Event List view to the first selected event. This is helpful when a number of events are selected, and they are not all visible at once onscreen.

**LAST SEL** This button moves the Event List view to the last selected event in the list.

**PREV SEL** This button moves the Event List view to the previously selected event. This is helpful when using HyperSelect to select events that might not be adjacent to one another (for example, the previous event selected might be two minutes earlier).

**NEXT SEL** This button moves the Event List view to the next selected event in the list.



**OPTION** Press this key to open the Option dialog. These controls define how the Event List operates.

**SMPTE FORM** Determines how time will be displayed in the Event List window: SMPTE, hours:minutes:seconds, bars:beats:ticks, feet:frames, or samples.

**MULTI SEL or SINGL SEL** Allows you to choose between selecting multiple events or single events only. With Multiple events, once an event is selected, it remains highlighted until you deselect it. For Single Events, only one event at a time can be selected.

**AUTO SCRL** Determines whether the Event List will follow the playhead or not.

### Chapter 20 – Project Management

#### Important Screens

The Project screens are where you manage your sessions, called *projects*. A project includes all important mixer settings, audio tracks, automation, effects, and sequencer data (in short, nearly every parameter

except Control Room and Studio Out sources). Projects are saved to your hard drive as a file, and all of this information is recalled to the SX-1 upon loading a project.

#### New Project Screens

Use the New Project screens to create a new project. New projects contain no audio or sequencer data, all mixer settings are zeroed, and there are no effects loaded. After creating a new project, its name will appear on your hard drive.

#### TIP

*The SX-1 autosaves your current project after every major operation. It is also a good idea to make a copy of your project somewhere from time to time that is just there for backup. See “Manage Project screens” on page 167 for the copy project controls.*

#### VGA New Project Tab

From the **MAIN DISPLAY MODE** section, press **PROJECT** to reach the PROJECT screen. Then click on the New Project tab.

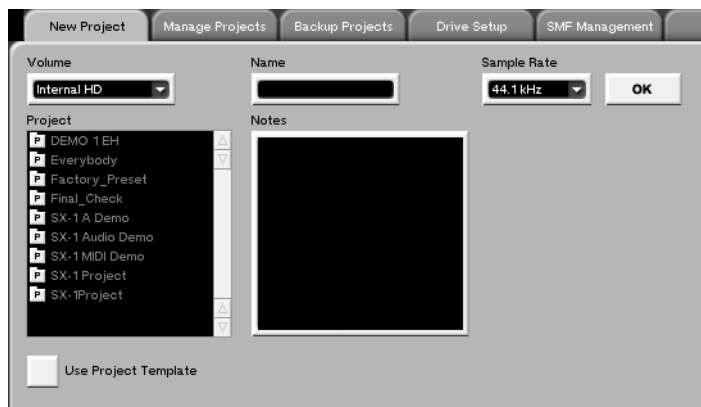

**Volume** This menu selects the drive where you want to save your new project.

**Name** The field is where you name your new project. You must enter a name for your new project here before you can create the file.

**Sample Rate** Select the sample rate for your new project.

**Project** Displays the projects saved on the current disk volume.

**Use Project Template** Check this box to choose another project as a template, or starting point, for your new project. You can import libraries, groups, routing setups, and MIDI controls.

#### NOTE

*The SX-1 can record 16- or 24-bit data within the same project (even within the same Take!). Use the VGA Global tab System Settings (“VGA Global Tab System Settings” on page 185) to set the bit depth.*

## LCD New Project Screen

This LCD screen reflects the New Project parameters found on the New Project tab of the VGA Project screen. Most of the parameters found on this screen are identical to the parameters found in the VGA New Project tab and are explained on the previous pages. Only those parameters that are unique to this LCD screen are explained here.

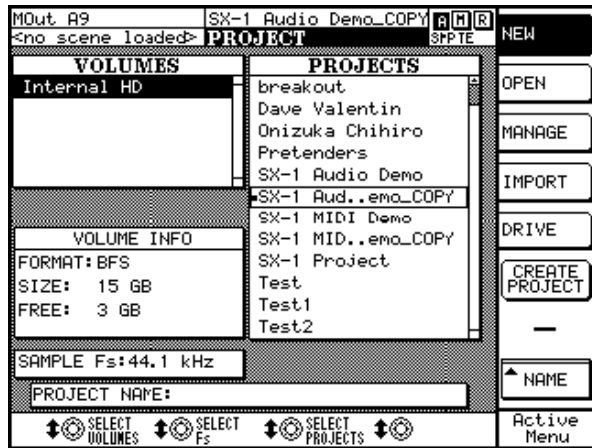

From the **MAIN DISPLAY MODE** section, press **PROJECT**, then press the New soft key.

**Create Project** After you have named your new project and selected a sample rate, press this soft key to write the new project file to disk.

## Manage Project screens

The Manage Projects screens are where you load, copy, and delete projects on your current disk volume.

### VGA Manage Project Tab

From the **MAIN DISPLAY MODE** section, press **PROJECT** to reach the PROJECT screen. Then click on the Manage Projects tab.

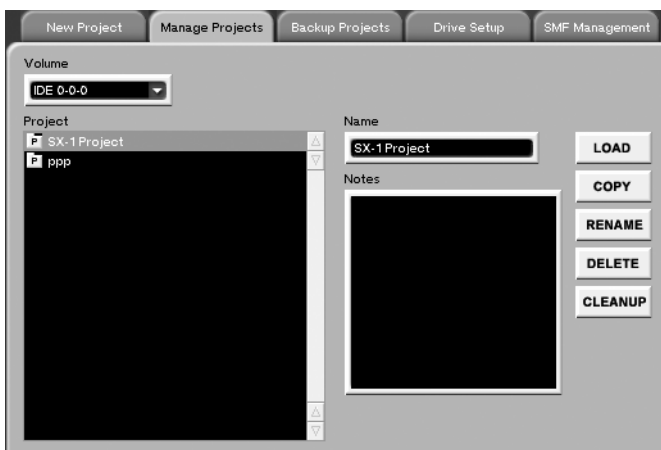

**Name** This field displays the name of the currently selected project.

**LOAD** Loads the project selected in the list.

**COPY** This key copies the selected project into a new file with a new name. The audio files are only copied when copying the project to a different drive or when backing up. See the section “The SX-1 and Hard Drives” on page 175.

**RENAME** Lets you rename the selected project.

**DELETE** Deletes the project selected in the list.

**CLEANUP** Cleans up all currently-mounted disks by going through the projects, and checking to see what clips are referenced by the projects on the disks. Any unreferenced clip files are deleted. If only part of a clip is used, the whole clip will be kept on disk. Files in the Import folder will not be cleaned up in this way.

## “Safe” startup

On rare occasions, the SX-1 may not be able to load the last project you worked on when it starts up (disk problems, etc.). If this happens to you:

- 1 Turn on the SX-1 as usual, but before the screen shows the “ghost” TASCAM and SX-1 logos, press and hold the PANIC key for a few seconds.

- 2 The SX-1 now boots, but does not automatically load the last project.
- 3 You can now restore the offending project from a backup, or take whatever steps are necessary to restore the integrity of your data.

## LCD Manage Screen

This LCD screen reflects the Manage Project parameters found on the Manage Projects tab of the VGA Project screen. Most of the parameters found on this screen are identical to the parameters found in the VGA Manage Projects tab and are explained on the previous pages. Only those parameters that are unique to this LCD screen are explained here.

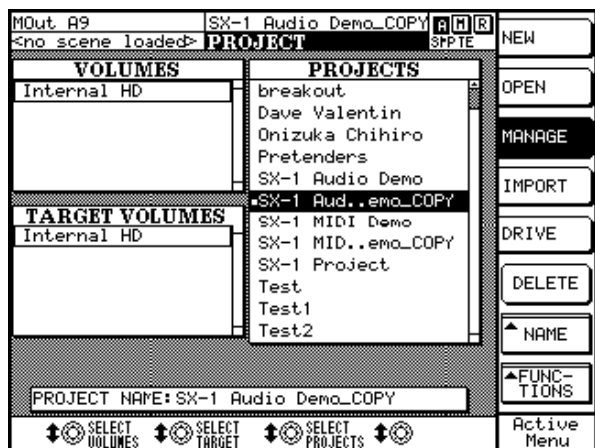

From the **MAIN DISPLAY MODE** section, press **PROJECT**, then press the MANAGE soft key.

**TARGET VOLUMES** These are the volumes that are currently available for saving and loading projects.

## FUNCTIONS

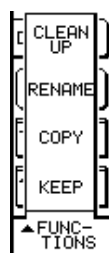

**CLEAN UP** Cleans up all currently-mounted disks by going through the projects, and checking to see what clips are referenced by the projects on the disks. Any unreferenced clip files are deleted. If only part of a clip is used, the whole clip will be kept on disk. Files in the Import folder will not be cleaned up

in this way.

### TIP

*If your disk is getting full, this is a way to reclaim some space by deleting the unwanted audio files (multiple retakes and retries) from older projects.*

**RENAME** Allows the currently-selected project to be renamed.

**KEEP** Operates in much the same manner as the Keep Mix function does (“Automation” on page 80), except that the command deals with Project files. Press the soft key to save the loaded Project under an incremented name (this operates much like “Save As” does on a computer).

**COPY** Makes a copy of the project highlighted in the list, excluding the audio files. The audio files are only copied when copying the project to a different drive or when backing up. See the section “The SX-1 and Hard Drives” on page 175.

## LCD Open Screen

Use this LCD screen to recall projects. Its controls parallel the Open Project parameters found on the Manage Projects tab of the VGA Project screen.

From the **MAIN DISPLAY MODE** section, press **PROJECT**, then press the OPEN soft key.

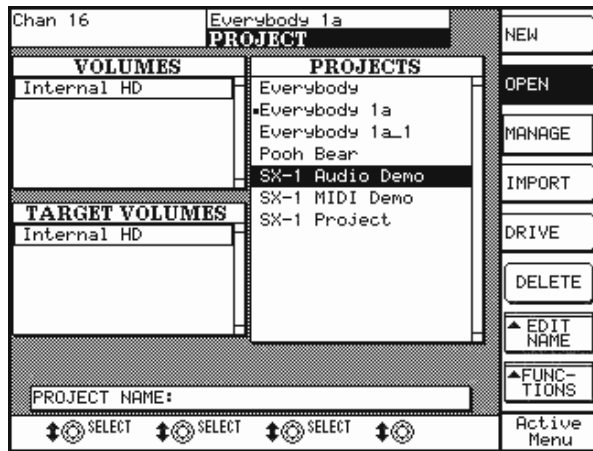

## Main Menu Bar Project Commands



New and Open Project commands are also available from the VGA's Main Menu Bar. These commands take you directly to their associated tab screens

(except Keep Project which saves your project and auto increments the file name). The key commands for each action are also listed on this menu.

## Chapter 21 – Mixdown, Author, Backup

### The SX-1 and Mixdown Mode

The SX-1 has a built-in mechanism for mixing down tracks (also known commonly as *bouncing*), useful both for mixing down the final stereo or surround

mix or for combining (also commonly known as *comping*) tracks together.

#### Philosophy – how it works

Basically, in stereo mode, anything that comes out of the L/R Buss can be bounced to a separate stereo file. In surround mode, anything that comes out of the surround busses can be bounced to a separate multi-channel file. The control that modifies how this behaves is the Create Mix button, which we will get to in a bit.

For stereo, if Mixdown mode is enabled and record is pressed, any audio coming out of the L/R buss is bounced down to a stereo file. This bounce actually creates two files, a Left and a Right (not a combined stereo file, commonly referred to as an interleaved file), which can be imported back into the session or sent to the burning program for audio CD creation.

This provides a simple way to comp together a large amount of tracks without having to go through a confusing routing scenario. Imagine that you had 16

vocal Takes that you wanted to comp to two tracks. All you would need to do is solo the tracks you want to comp together, enable Mixdown mode and press **PLAY** and **RECORD**. After the transport is stopped, the SX-1 will create a stereo file of your soloed tracks—which you can import into your current session. This would allow you to unload the vocal takes you have just comped together, saving tracks and lowering the mixing complexity.

When the Create Mix button is pressed, a new Mix will be created and loaded upon exiting Mixdown Mode. The resulting stereo file is loaded into Slots 1 and 2, panned in stereo and routed correctly, making it possible to quickly check your mix simply by pressing **PLAY**. To return to the state the SX-1 was in before you exited Mixdown mode, just reload the last Mix-file.

#### Stereo Mixdown – printing your final mix or comping tracks

Obviously, there are a number of ways to use Mixdown mode, with stereo mixdown likely being the most common. When you have reached the point in your mix where you would like to save it as a two-

track file (either for audio CD burning or other uses), you can accomplish this easily by using this mode. The first examples in this section will address the way the SX-1 “mixes down to two”.

#### On the VGA

As has been discussed previously, the VGA Track screen has a number of tabs at the bottom. The Global

tab contains the VGA’s Mixdown mode controls. The Global tab looks like this:

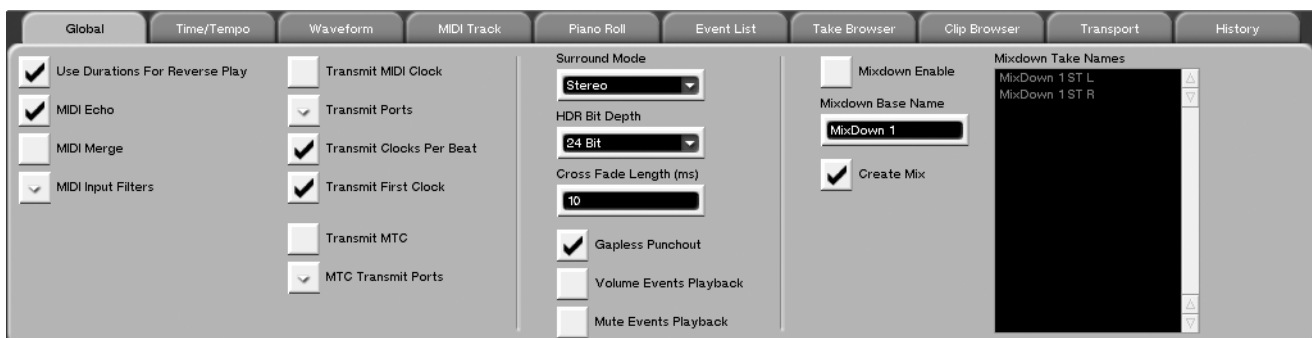

In this section we are concerned with the controls on the right hand side of this tab:

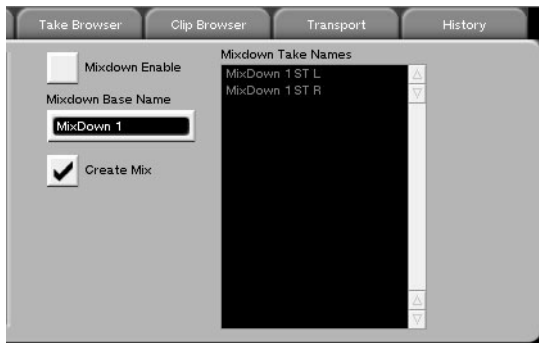

The Mixdown Enable button enables Mixdown mode. Pressing this button sends the machine into record all-safe, meaning that nothing can be recorded on any of the slots.

Notice the Record button at the top of the VGA displays an “M” to let you know you’re in Mixdown mode:



If the transport is moving and Record is pressed, the SX-1 will bounce the audio coming out of the L/R Buss to a stereo file, with the resulting file named according to the text entered in the Mixdown Base Name field. Every time mixdown mode is enabled, the machine will automatically increment the name with a Mix number (“Mixdown 1” Mixdown 2”, etc.).

The Mixdown Take Names field displays the names that will be given to the right and left side of the next stereo file created in Mixdown mode.

The Create Mix button changes the manner in which the SX-1 exits Mixdown mode. With this button checked, the machine will create an entirely new Mixfile upon exiting Mixdown mode. This Mixfile will be loaded, and the stereo file from the bounce will be loaded into the first two HDR slots – with the mixer channels panned and linked accordingly. To verify that your mix printed correctly, simply press **PLAY**. When you are finished listening to your mixdown and wish to return to the SX-1’s previous state, load the previous Mixfile (from the tab at the top of the VGA screen or the Mix tab on the Automation screen).

## On the LCD

The behavior of the machine as controlled by the LCD is identical. To view the graphical differences, press the **MASTER** key in the **MAIN DISPLAY MODES** section of the surface.

You should see this on the LCD:

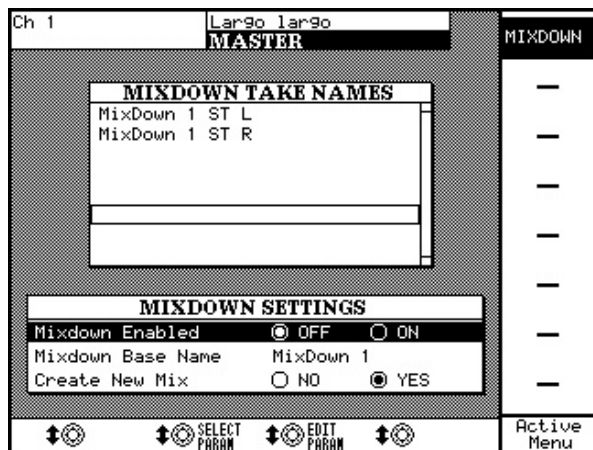

The Mixdown Take Names field displays the names that will be given to the right and left side of the next stereo file created in Mixdown mode.

The Mixdown Enabled ON and OFF buttons enable or disable Mixdown mode.

Highlighting the Mixdown Name line with the cursor and tweaking the Edit Param knob will bring up this display:

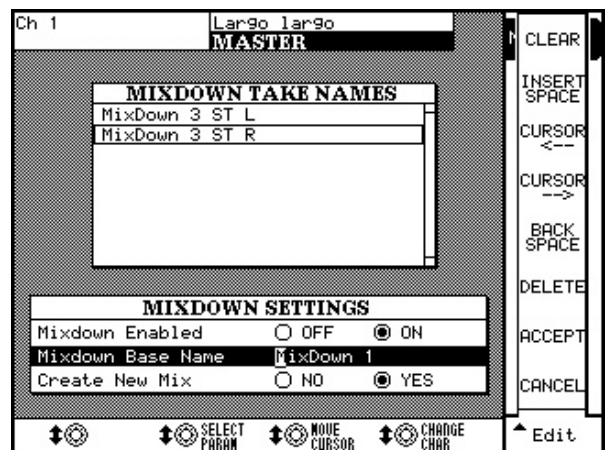

Use the controls that appear at the right side of the screen to navigate through the name field, and use the numeric keypad to enter the actual characters. You can use it just like a cell (mobile) phone or regular telephone with letters on the keypad—press the “1” key once for an “a”, press it twice for a “b”, three times for a “c”, etc. Press the Accept key when you’ve finished editing the name.

## In Surround Mode – what changes?

If the mixing console is set to one of the surround modes, the behavior of Mixdown mode is changed slightly, in that the audio bounced down to the Mix-

down file originates from the surround mix busses, not the L/R Buss.

## On the VGA

In surround, the VGA Global tab looks like this:

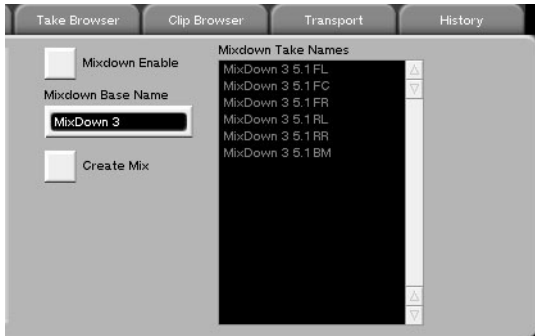

You will notice that the Take names reflect which speaker/surround buss the file relates to. The Mixdown file still uses the text in the Mixdown Base Name field as its point of reference, but each individual audio file also receives the name of its source/destination.

## On the LCD

On the LCD, just as on the VGA, the only thing that changes in the display of surround is that the Mixdown Take Names field shows six files (in 5.1 surround) instead of two.

From the **MAIN DISPLAY MODE** section, press **MASTER**, then press the MIXDOWN soft key.

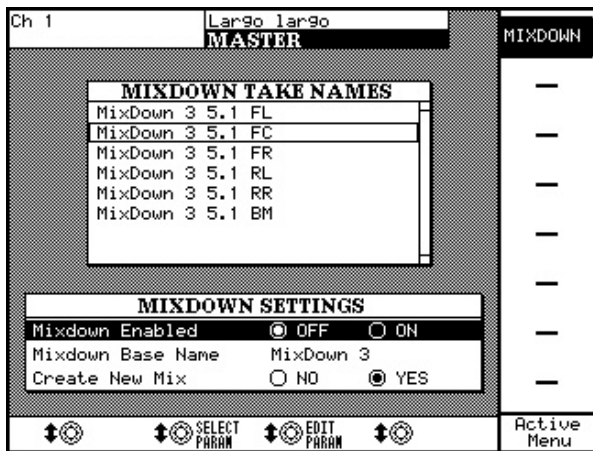



## Working With the CD Burner

The CD Burning program on the SX-1 can create both Red Book audio and ISO 9660 CDs. You will find that it has a number of unique features, some of which are not available in most other burning programs.

When creating Red Book audio or ISO 9660 data CD's, you can access the burning program by press-

ing the **MASTER** key in the **MAIN DISPLAY MODES** section.

At the top of the VGA screen you will see the Type tab. Use this tab to select either Red Book CD (for audio CDs that can be played back in any CD player) or ISO Data CD (for data CDs that can also be read by most computers).

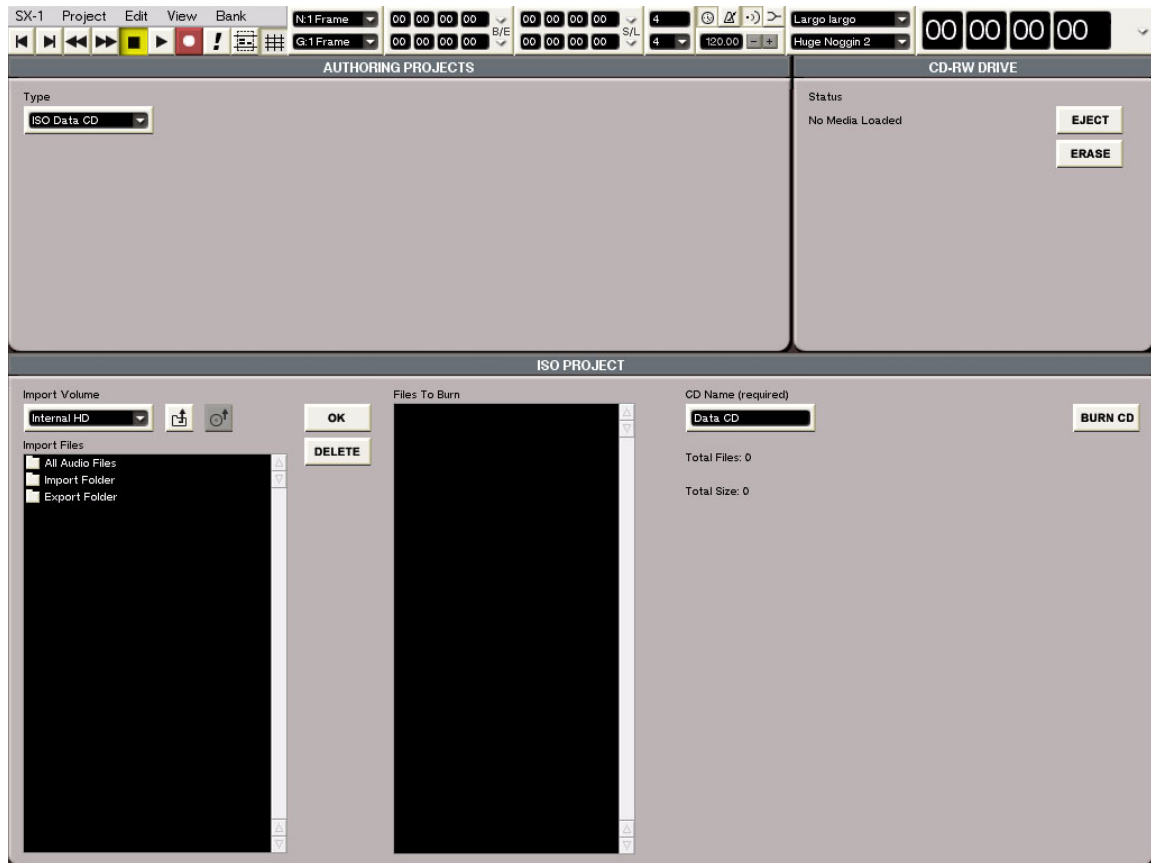

## ISO Data CD

When ISO CD is chosen, the VGA screen should look like this:



The bottom half of the screen is devoted to selecting and arranging files for data CD burning. The Import Volume tab selects one of the connected and mounted devices as the import volume (the volume from which files will be selected for CD burning). If you have nothing connected to the SX-1 via SCSI, this list will likely only have Internal HD as an option.

The Import Files register will normally default to showing three folders: the Import Folder, the Export folder, and the All Files folder. Double-clicking on a

folder with the mouse will open it, while pressing the  button will take you one step back in the file hierarchy (the  button acts just like the “Back” button in a Web browser).

The SX-1 cannot browse audio files in separate folders, meaning that selecting the All Files folder will show you all of the audio files on disc. Find and select the desired audio files for CD burning, and add them to the selection by pressing the OK button to the left of the Files register. You will add them one at a

## Part VIII—Data Entry, System & File Management

time. As you add files, you will notice that a Total Files and a Total Size readout will update with each addition.

When you have assembled all of the desired audio files for your ISO data CD, give the CD a name by entering one in the CD Name field to the right of the

Files register. Once you have named the CD with your PS/2 keyboard, press the Burn CD button to the right of the CD Name field. A progress bar will appear, letting you know the status of the burning program. The disc will eject when finished.

---

### Red Book Audio CD

---

If you select Red Book CD from the Type tab at the top of the VGA screen, the layout of the bottom screen will change to this:

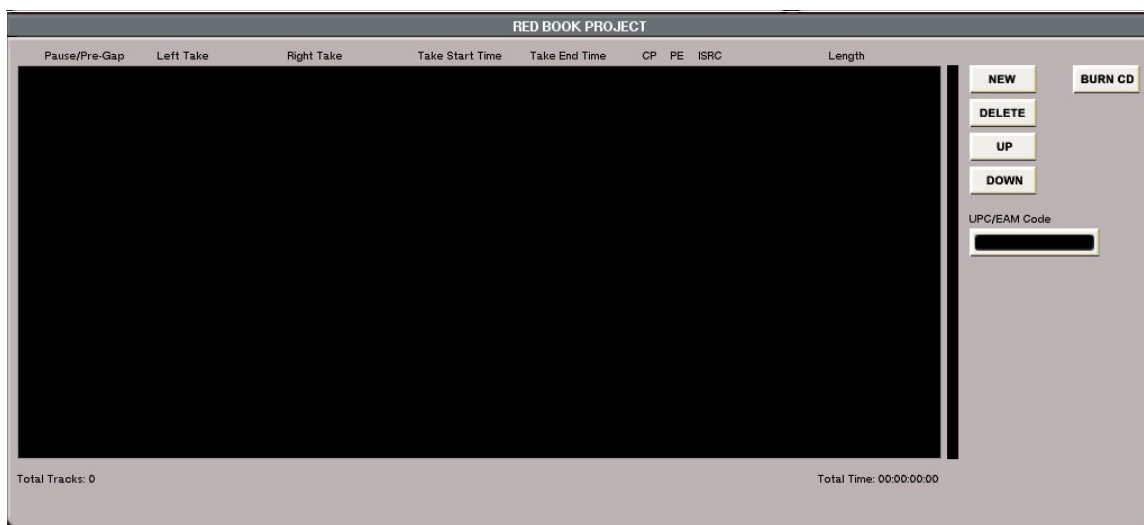

To add a stereo file, press the New button to the bottom right of the screen.

One of these will appear:



The use of this bar requires some explanation:

The SX-1 uses Takes to load the stereo files for burning. This means that audio Clips are not available for direct import into the burning program. Any audio file that you wish to be burned to a CD in Red Book audio format must be loaded into a Take slot first, before it can be loaded into the bar above. While this might at first seem unusual, looking closer at the functionality this provides will show its merit. As well, consider the fact that any stereo file created in Mixdown mode is already, by its very nature, a Take.

One advantage to using Takes is that you can pre-configure an entire audio CD by loading the desired mixes onto a pair of Takes and arranging from there. Using this method, you can drag files around to get the desired amount of space between them, as well as crossfading one song into the next by using the same tools you're used to for editing audio waveforms.

Look again at the slot above that appears when you press the New button on the bottom right of the VGA screen.

The Pause/Pre Gap field is where you manually enter the amount of space between the previous Take and this one. If the Take in question is the first one, this field sets the amount of time it takes to play the CD when it is loaded and the first track is selected by the CD player.

The Left Take field has an arrow, which denotes a pull-down menu. The pulldown menu allows you to search for the desired files by project. When you find the desired file and select it, it will be loaded into the Left Take slot. As a benefit, when you load the left side of a stereo mix labeled some name followed by either a "L" or "R" (to denote left or right), the burning program will automatically load the corresponding right side of the Mix. Incidentally, this works inversely for the Right Take field.

**Important!** The Take Start Time and Take End Time fields address which part of the Take is played on this CD Track. For instance, if you had created and loaded a Mixdown pass that started at 00:48:00:00 and ended at 00:52:00:00 in the original session, leaving these fields blank would result in a CD Track fifty-two minutes long. As well, the audio for that track would not begin until the 48th minute. This is obviously a function that you need to become familiar with.

If all of the Takes for the mixes you load into the burning program begin at 00:00:00:00, and you leave the Pause/Pre Gap field at the default, the audio CD will be created with a two second gap between Tracks. If you want to pre-assemble your CD on the Tracks window by loading multiple mixes into two slots and arranging them, you would simply load the two takes in question into multiple slots in the burning program (as many slots as you want CD Tracks). Then use the “Take Start Time” and Take End Time fields to determine which parts of the Take get played on each CD Track.

The numbered buttons at the very left of the bar (which light up yellow when pressed) select a Take for editing, which in this case mainly applies to the use of the buttons to the right of the Track field. In a situation where more than one Take is loaded, selecting a Take that is lower down the list and pressing the UP button will move the selected Take up one increment. Selecting a Take and pressing the DOWN button will have the opposite effect and move the Take down one slot. Selecting a Take and pressing the DELETE button will remove the entire slot from the list.

When you are finished assembling your audio CD, press Burn CD to begin creating the disc.

The CP button turns on SCMS copy protection, which will allow only one copy to be made of your CD. The ISRC field allows you to enter information about your project in space on the disc provided by the Red Book specification. This information can be read in certain CD players. As well, the UPC field to the right of the slots is typically reserved for retail UPC codes.

---

## The SX-1 and Hard Drives

---

### Care and feeding, and audio file behavior

As you are no doubt aware, the SX-1 uses a hard drive to store all of its data on, both project-wise and audio-wise. The following section is geared toward

getting you familiar with the SX-1’s disk behavior, and how to manage your data.

---

### The Philosophy – drives in general

Although there are other forms of digital media (solid state and digital tape, for instance), the hard drive is the standard storage device of all computer-based products. You will see that the SX-1 addresses these standards as very few other devices can.

Every hard drive has a directory (sometimes known as a catalog) that spans the entire disc, which tells the drive where to deposit and retrieve data. Each common operating system has a disk directory – commonly referred to as a *format* – that it uses as a standard. For example, machines running a modern Windows operating system use FAT32 as their native drive format, while modern Macintoshes use HFS+. The SX-1 runs on the Be operating system, which uses the BFS disk format.

The format itself determines a number of things about the way data is written to the drive, including block size (the size of the smallest data block on the

drive’s surface – which can range anywhere between 4 and 512K) and file type.

Getting much deeper into the architecture of hard drives is unnecessary in this section, except to note that drive formats grew and developed to support operating systems – and thus determine some of the behavior of each. This is the reason why the SX-1 writes Sound Designer II audio files to an HFS+ drive format (used on Macintosh computers and DAW’s), but writes Broadcast Wave audio files to FAT32 (Windows) and BFS (Be operating system) drives.

#### **NOTE**

*The validity (health) of a hard drive’s format is extremely important, because if it becomes corrupted or compromised in any way, the possibility of lost data increases exponentially.*

### Drives and the SX-1

The SX-1 comes with one internal IDE hard drive – segmented into two virtual hard drives or *partitions* – one for audio and one for the system software. These partitions are seen by the SX1 as separate drives (because they have separate formats), and can be managed as such (meaning that you can manage files on one partition without affecting the other). As well, the machine comes with UltraWide SCSI capability, accessed either by the port on the rear panel, or the slot underneath the CDRW drive on the front of the unit.

The internal drive is formatted to BFS, but the SX-1 is capable of mounting all three previously mentioned format types and their variations via SCSI: BFS, FAT32, HFS, and HFS+.

It is possible to have as many as four external drives running in conjunction with the internal drive, in specific configurations that will be covered in a few pages. Even though the internal drive is formatted to BFS, you can connect any combination (up to four) of HFS, HFS+ and FAT32 drives via SCSI and have them running at the same time.

#### NOTE

*Even though they cannot be viewed through the SX-1's user interface, the formats for FAT32 and HFS drives work exactly the same as they do when connected to their desktop counterparts. This means that if you were to connect an HFS drive (that you had an SX-1 project on) to a Mac, you would see the folders and icons you are used to.*

### What is actually put on the drive

A project created on the SX1, when moved to a desktop system, would be displayed in much the same way that a project created in any other application would look.

There are three basic folders created by the SX-1 on a hard drive, the first of which is the TL Projects folder (the main folder for SX-1 projects). Inside the TL Projects folder sit the individual Project folders themselves, with each Project Folder labeled by the name entered on the New Project screen, and each containing a number of different files:

- an Audio Files folder (which contains the raw audio files, or Clips, from the Project)
- a Data Files folder (which contains all of the data written to eq, compression, effects processors, etc)
- a Track Files folder (which contains all of the Take data – basically, all of the EDL information, or which files get placed at which time)
- a single file named “something.tl”, which is the Project file itself.

There are two other folders: TL Imports and TL Exports. These folders serve as buffers for the SX-1 software, which cannot directly read or store certain types of data without conversion. When an SMF file is exported to the internal drive, the file ends up in the TL Exports folder. The TL Imports folder can be used as a storage area for audio you intend to import into an SX-1 session, as well as storage for data you

wish to remain immune from a Disk Cleanup command.

#### NOTE

*It is important to note that you cannot place any data inside the TL Imports folder from within the SX-1 itself. The only way to put files inside the TL Folder is by mounting the drive on a desktop computer. As well, once you have data in this folder, the only way to delete those files (without affecting the other data on that drive) is to move the drive to an external machine.*

*Obviously, reformatting the drive will clear all of the data on the drive.*

If you never connect a SCSI drive to the SX-1 and then take that data to a desktop computer, this information is largely irrelevant (because all of these operations are transparent when working on the unit itself). However, it is always a good idea to know how something in your system works (and what to expect), should you attempt to do something you have never done before.

#### NOTE

*It is worth mentioning that the SX-1 and the units it derives from (the MX-2424 and the MM series of TASCAM recorders) are some of the only machines available with the ability to mount common drive formats. These units are some of the only machines available that write time-stamped SDII and Broadcast Wave audio files natively, meaning that there is no need for conversion when taking your data to another system. This flexibility is one of the core design concepts behind the SX-1.*

### What is happening when the SX-1 is recording

The SX-1 has a very fast hard disk engine, which is nearly as capable of punching in and out of record as fast and as many times in thirty seconds as you are. This performance is a result of the manner in which the SX-1's hard disk recorder deals with audio data.

Recording passes are written to disk in real time, after passing through RAM buffers. The speed of the disk engine itself is achieved by a combination of buffer maintenance and hardware throughput.

When you are finished recording a pass, the audio just recorded is placed for playback upon the Take in the position it was recorded. If data already existed on the Take in that position (which was seemingly overwritten), pressing Undo will restore that data. If at least a slice of the previous audio still exists on a Take, you can right-click on a waveform and uncover the rest of the file if you wish.

Basically, a Take is a list of which audio files were played and when, which is also a simplified description of an EDL – or Edit Decision List.

The SX-1 (and MX-series machines) uses the last audio placed on the Take as current, which means that if you were to close the project or shut the machine down, when you reloaded the project the audio last loaded on the Take would be what you would see. Once you shut down the SX-1 or close a session, you lose the ability to Undo back to a previous state.

#### TIP

*Remember however, you can always import the Clips back into a Take from the Clip Browser.*

The main concept to understand is, *if you wish to keep all of your record passes as separate Takes (as opposed to Clips you can always import back into the project), you'll need to create a new Take before each record pass.* After you are finished recording, you can always load the different Takes and comp them together using Mixdown Mode.

### The way the SX-1 handles data

The disk engine (the disk engine inside the SX-1, and the MX and MM series machines) handles data a bit differently from the way that desktop computers do, in order to take full advantage of the speed of the system. As a result, there are a few conventions of desktop systems that do not apply to the SX-1.

When you make a Copy of a project, the destination volume determines the behavior of the copy somewhat.

If you Copy a project from the internal drive to itself:

- All of the Track, Project and Data files are copied to their new location.
- The Audio Files are not copied.

The reason for this is that the Timeline engine can freely exchange audio files between projects, and it can only like to deal with one copy of the same audio file at a time.

If you Copy a project from the internal drive to an external volume, either FAT32 or HFS:

- All of the Track, Project, and Data files are copied to their new location.
- If the destination volume is FAT 32, the audio files are copied to their new location with no change.

- If the destination volume is HFS or HFS+, the audio files are copied to their new location, and are converted to SDII in the process.

The reason for this behavior stems from the fact the SX-1 (and MX-2424) always writes SDII files to Mac volumes. FAT 32 and BFS volumes must always use Broadcast Wave files. When a Copy is done from one volume type to another, the audio files are automatically converted along the way.

#### TIP

*This is actually a very fast way to batch-convert a number of audio files between formats!*

Thus, if you Copy a project from HFS to FAT32 or vice versa:

- The Data, Track and Project files are copied to their new locations.
- All of the audio files are converted to the native file format of the volume.

If you Copy a Project from one volume to another, *and the project already exists on the destination volume:*

- The Data, Track and Project files are copied to their new locations.
- The SX-1 will search the destination drive, looking for the audio files that are linked to the project

being copied. *If those audio files already exist on the destination volume, they will not be copied.*

This saves time and disk space.

The preceding description is the same for a project being Restored from a Backup.

---

### Explanation of Disk Cleanup and Low Level Format

After a number of projects have been created and backed up on your drive, and a number of projects have been deleted, a number of orphan files will exist on your drive. Disk Cleanup on the Drive Management Screen can take care of this.

What Disk Cleanup does involves searching out the entire hard disk, looking for audio files that no longer reference any EDLs on the drive. This means that the SX-1 looks for any files that don't belong to any session currently stored on the drive being cleaned. If the SX-1 finds any files that don't belong to any Project file currently on that drive, it will delete them. This is an easy way to free up a potentially large amount of disk space.

#### CAUTION

*The behavior of disk cleanup means that you only select it when you know you have backed up every file that*

*you need! If you are not absolutely sure that you have everything backed up to your satisfaction, wait until you are before you perform a Disk Cleanup. Files deleted with Disk Cleanup are not recoverable by any normal means.*

Low Level Format is a standard term that refers to an operation that “zeros the disk”. When a drive is simply “initialized”, all of the header data pointing to files on the disc are zeroed. The data itself remains on the plates until something is physically written over it.

When Low Level Format is chosen, all of the data on the drive is zeroed, meaning that the drive is wiped completely clean. This is a very good procedure to do whenever you are wiping a drive.

---

### How the Backup file is made

When you make a Backup to a CD-R or other backup media (DVD-RAM, for instance), the SX-1 creates one file to go onto the backup volume. This is done by searching out every relevant file to the Project being backed up, and creating a separate archive for them.

If you were to move an SX-1 SCSI volume to your Windows machine or Mac, you would see a file in the root directory named TL\_WAVEFORM\_DB

(with a number after “DB”). This file holds the entire waveform database for that hard drive in it, which is why it is likely larger than all of the other text files in the Project folders. When you create a Backup, the SX-1 searches through the Waveform database file looking for the overview (waveform) data relevant to your Project, and those overview files are included in the Backup file.

---

### Quick general behavior

- Like a Mac, once the SX-1 has mounted and recognized a CD-ROM in its drive, that CD-ROM cannot be ejected by the button on the front of the drive itself. The drive must be ejected from the SX-1 itself.
- The SX-1 can only mount SCSI volumes once per boot, which means that to switch out a removable SCSI drive, you have to power cycle.
- Remember that devices designed only for backup, like tape drives and non-formatted DVD-RAM (which do not have a directory), can only be globally initialized. This means that you cannot erase

- one tune at a time, you must erase the entire volume. This is standard for all backup media.
- A backup CD produced on an SX-1 is a standard ISO dic structure. This allows it to be mounted on a PC, for example, allowing data to be transferred and consolidated with other PC-based data of the same project (subject to proper directory structure being maintained).
- A Low Level Format will take longer, but should be done anytime you are wiping an entire drive. This is to insure drive health and data safety.
- When you are exporting an SMF or some similar type of data, the files go into the TL Export folder.

## Backing Up

To ensure that your projects do not become damaged or lost, it is important to back up your working session drives on a regular basis (say, at least every 20 hours—or whenever you have done a significant amount of work that would be impossible to recreate). This guarantees that if something does happen to your project files, you will have a backup copy that contains a good portion of your work.

See the previous section for a fuller explanation of the backup file format, etc.

### NOTE

*The SX-1 will create a backup file in the Timeline BU format from these screens. This format condenses all of the individual elements of a project into one file that can be imported by any TASCAM/Timeline machine (MX-2424, MMR-8, MMP-16). The type of target (or destination) backup volume does not influence the type of file made from a Backup screen.*

*If you wish to take your work to a non-TASCAM device (a DAW such as Nuendo or Logic Audio that supports Open TL, for instance), you'll need to Copy your project onto a valid connected FAT32 or HFS drive. An MX-2424 can always read all of the files that the SX-1 creates.*

## Backup Displays

Backup controls are available from both VGA and LCD screens. Use these screens to facilitate a backup of your working drives.

## VGA Project Backup Tab

From the **MAIN DISPLAY MODE** section, press **PROJECT/ BACKUP** to reach the Project screen. Then click on the Backup Projects tab.



**Volume** This menu selects the drive that contains the project you want to back up.

**Project** In this window you select the project you want to back up.

**BACKUP** Click here to begin the backup process of the selected project.

**RESTORE** Click here to restore a previously backed up project.

## Part VIII—Data Entry, System & File Management

**VERIFY** Check this box to enable data verification on backup and restore operations.

**Backup Volume** In this field, you select the volume you would like to back up to (or the volume where the project files that you want to restore reside).

**Backup Project** In this window, you select the project files that you want to restore.

### LCD Backup Screen

This LCD screen reflects the Backup Projects parameters found on the Backup Projects tab of the VGA Project screen. Most of the parameters found on this screen are identical to the parameters found in the VGA Manage Projects tab and are explained on the previous pages. Only those parameters that are unique to this LCD screen are explained here.

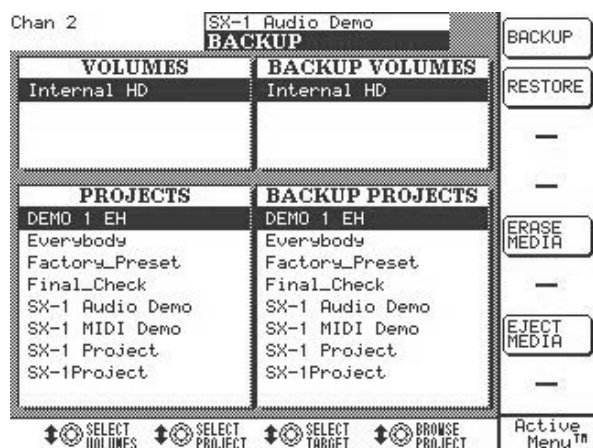

**"CD" icon** Ejects media in the CD-RW drive.

**ERASE** This command erases the selected backup volume. In the case of CD-RW, a blank disc must first be erased before it is usable. After it has been erased, a CD-RW disc will show up as a valid backup volume.

Press **SHIFT** on the Keypad. Then, from the **MAIN DISPLAY MODE** section, press **PROJECT**.

**BACKUP** Begins the backup process of the selected project.

**RESTORE** Begins the restore process of the selected project.

**ERASE MEDIA** Pressing this soft key will erase the currently selected backup volume.

**EJECT MEDIA** Ejects media from the CD-RW drive.

**SELECT TARGET** This selects the volume you want to use for the backup. It functions the same as the Backup Volume list on the VGA's Backup Projects tab (in the PROJECT screen).

### Drive Settings

Before using a hard drive with the SX-1, it must be formatted.

Controls for formatting hard drives are available from both VGA and LCD screens.

### VGA Drive Setup Tab

From the **MAIN DISPLAY** section, press the

**PROJECT** key. Then click once on the Drive Setup tab.

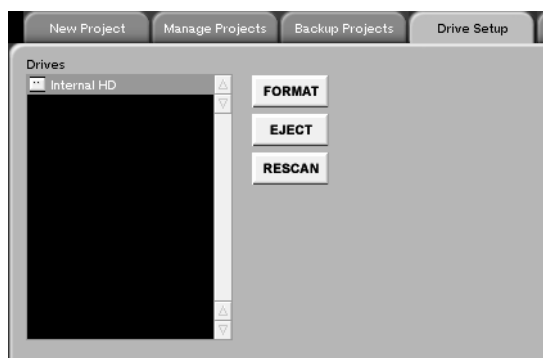



**Drives** This window shows the drives that are currently mounted.

**RESCAN** Press this key to rescan all connected devices (removable media such as DVD-RAM, etc.).

**EJECT** Press this key to eject media (such as, a CD-R or other removable media).

**FORMAT** Press this key to format a drive. This erases all information on the drive, so be sure there is nothing you need to save on it. Format choices are

(for external SCSI drives): Fat 32 (PC), HFS (Macintosh), HFS Plus (Macintosh). A choice of a Low Level Format is also available for external SCSI drives. Check this box to zero all data on the external drive.

**TIP**

*Performing a low level format whenever you erase a hard disk (or other such media) can help to keep the drive working at peak efficiency. Also note that the only way to format the internal drive is to reinstall the software from the CD-ROM.*

## LCD Drives Screen

.From the **MAIN DISPLAY MODE**, press **PROJECT**. Then press the **DRIVE** soft key to reach this screen.

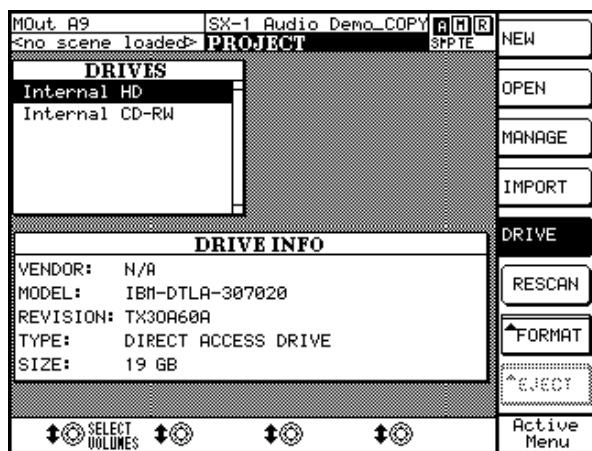

**FORMAT** Press this soft key to format the selected drive's media. This erases all information on the drive, so be sure there is nothing you need to save on it. Format choices are available for external SCSI drives: Fat 32 (PC), HFS (Macintosh), HFS Plus (Macintosh).

**EJECT** Press this soft key to eject the selected drive's removable media.

## Chapter 22 – System Settings

### Preferences

Preferences deal with general operational and appearance settings.

### Preferences Screens

There are preference controls available from both VGA and LCD screens. However, there are several more LCD screens for setting preferences than VGA screens. Many of the LCD screens have parameters

which are only accessible via that screen. Preference controls are for customizing the operation of your SX-1 and its appearance.

### VGA UI Settings Tab

This screen allows you to set the way the SX-1's VGA screens look. To reach this screen, from the

MAIN DISPLAY MODE section, press **SETTINGS/PREFS**. Then click on the UI Settings tab.

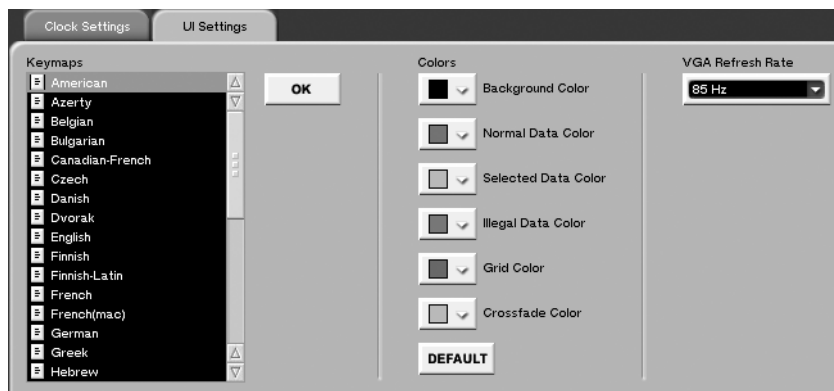

**Keymap** If you are using a PS/2 keyboard which is not the North American QWERTY standard, you can set the type of keyboard you are using here.

**Color** Use these color settings to customize the look and feel of the VGA screens to your requirements and personal taste.

**Background Color** Selects the background color in the Tracks screen and associated tabs.

**Normal Data Color** Selects the track's data color (like waveforms and MIDI notes) in the Tracks screen and associated tracks tabs.

**Selected Data Color** Chooses the select (highlight) color in the Tracks screen and associated tracks tabs.

**Ghost Data Color** This setting selects the color of *Ghost data*, most often seen when accessing a track on the Automation screen that pertains to an HDR track, or when dragging an audio event somewhere that is illegal (like over a MIDI track).

**Grid Color** This setting determines the color of the SX-1's Grid display. To lighten the Grid against the background color, choose a color for the Grid that is very near the shade of the background itself.

**Miscellaneous Color** This setting chooses the color for items such as the outlines of Waveforms in the Tracks screen.

**VGA Refresh Rate** Set the refresh rate of your VGA monitor (available from your monitor's documentation) using this pulldown menu.

## LCD Meter Screen

Several LCD screens are available for setting preferences. Many of these screens have parameters that are only accessible via the LCD.

The METER screen is such an example. This screen is used for setting the responsiveness of the SX-1's LED meters.

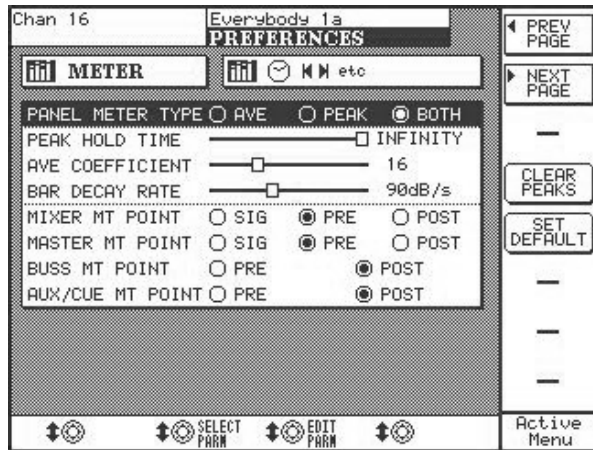

Press **SHIFT** on the Keypad. Then, from the **MAIN DISPLAY MODE** section, press **SETTINGS/ PREFS**, and use **NEXT PAGE** (or **PREV PAGE**) soft key to scroll to the METER screen.

**PANEL METER TYPE** This parameter is for the front panel LED Master Meter. Use it to select between Average (meters reflect an average of signal levels), Peak (the peak LED holds for a few seconds), or Both (shows peak and average meters at the same time).

**PEAK HOLD TIME** Here, you can choose how long you want the meters to hold peaks (from 9 ms to infinity).

**AVE COEFFICIENT** This parameter determines the first part of meter ballistics – the speed of attack. At smaller values, the amount of data passing through the meter is lower than it is at higher values, speeding up the meter's performance.

**BAR DECAY RATE** This control deals with the second part of meter ballistics – the decay rate. The value refers to the number of db (decibels) the meter falls every second. The higher the number in db per second, the faster the meter recedes after a peak.

**MIXER MT POINT** This sets the Mixer Metering Point—that is, the point in the signal chain that is depicted by the meter. The choices are: Sig (directly after the A/D conversion), Pre (pre-fader), and Post (post-fader).

**MASTER MT POINT** This setting determines the metering point for the Master L/R Buss. The choices are: Sig (pre-buss trim), Pre (pre-fader), and Post (post-fader).

**BUSS MT POINT** This setting determines the metering point for the Busses. The choices are either pre or post fader.

**AUX/CUE MT POINT** This setting determines the metering point for the Cue buss and the Aux Sends. The choices are pre- or post-fader.

## LCD Miscellaneous Screen

This screen allows you to set a variety of different preferences: the foot pedal jack's performance, dim

attenuation, and Control Room and Studio Out attenuation.

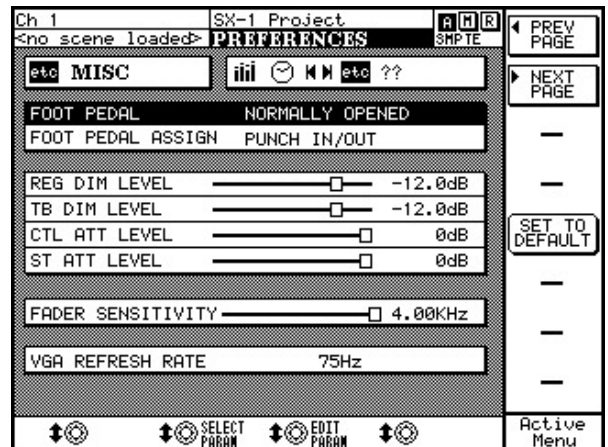

## Part VIII—Data Entry, System & File Management

Press **SHIFT** on the Keypad. Then, from the **MAIN DISPLAY MODE** section, press **SETTINGS/ PREFS**, and use the **NEXT PAGE** (or **PREV PAGE**) soft key to scroll to the **MISC** screen.

**FOOT PEDAL** Allows you to set the foot pedal jack's operation to Normally Open or Normally Closed.

**FOOT PEDAL ASSIGN** Allows the assignment of the footswitch function.

### NOTE

*The foot pedal's default operation is as a punch-in pedal for recording. In future versions it will have expanded capabilities*

**REG DIM LEVEL** Here, you can set the amount of level attenuation (–50 to –3 dB) for the **DIM** key of the **CONTROL ROOM** section.

**TB DIM LEVEL** Use this control to set the amount of Main Output level attenuation (–50 to –3 dB) asso-

ciated with the **TALKBACK** key of the **STUDIO** section.

**CTL ATT LEVEL** Use this parameter to adjust the starting level for the Control Room outs. The default of 0 is equivalent to +4 dBu.

**ST ATT LEVEL** Use this parameter to adjust the starting level for the Studio outs. Again, the default value of 0 is equivalent to +4 dBu.

**FADER SENSITIVITY** Adjusts the touch-sensitivity of the faders. The values are expressed in scan cycles, with higher values denoting faster (and therefore more accurate) scanning of the faders.

Note that the SX-1 faders' touch-sensitivity depends somewhat on the environment; chiefly temperature and humidity, and body pH—as these all affect conductivity.

**VGA REFRESH RATE** Use this dial to select your VGA screen's sync rate (60 to 87 Hz).

### LCD Time Screen

Everything you do on the SX-1 is time and date stamped. This is essential for event history and undo/redo operations. Use this screen to set the SX-1's internal time.

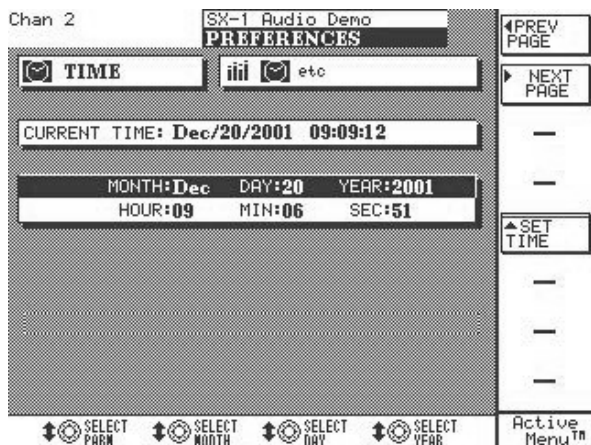

Press **SHIFT** on the Keypad. Then, from the **MAIN DISPLAY MODE** section, press **SETTINGS/ PREFS**, and use the **NEXT PAGE** (or **PREV PAGE**) soft key to scroll to the **TIME** screen.

**SET TIME** Once you have adjusted the time and date, press this soft key to set the SX-1's internal clock.

**SELECT MONTH and SELECT HOUR** Turn this soft knob to adjust the month or hour, depending on the field that is selected.

**SELECT DAY and SELECT MINUTE** Turn this soft knob to adjust the day or minute, depending on the field that is selected.

**SELECT YEAR and SELECT SECOND** Turn this soft knob to adjust the year or second, depending on the field that is selected.

### About your SX-1

There are no editable parameters on this screen—it simply provides information about some of the SX-1 hardware components.

## The SX-1 Menu

Many preferences can also be reached from the SX-1 menu that is found on the VGA's Main Menu Bar.

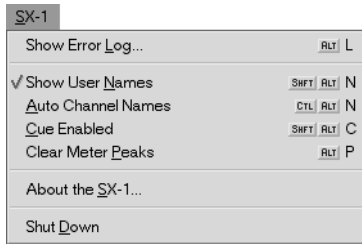

**Show Error Log** The SX-1 keeps a log of all events it classifies as errors (for example, losing clock sync). This command shows the error log read-out.

This error log is also available by pressing the surface **EDIT** key, and then pressing the Error Log soft key.

**Toggle User Names** Use this command to toggle between the default/factory name for a routing location and the user name.

**Toggle Cue** Use this command (shown as Cue Enabled or Cue Disabled) as a shortcut for pressing the **CUE** key on the Virtual Channel Strip. It simply toggles the Cue bank on and off.

**Clear Peaks** Clears the current meter peak hold.

**About the SX-1...** Provides information about the SX-1's current operating system version and its hardware and software developers.

**Shut Down** This command duplicates the **SHUTDOWN** key's function. The only difference is that you don't have to hold the physical key down for 3 seconds, as shutdown begins immediately upon releasing the mouse.

## System Settings

System Settings are global operating parameters, such as sample rate, bit depth, and digital clock settings.

### System Settings Screens

There are System Settings controls available from both VGA and LCD screens.

### VGA Global Tab System Settings

Here, you can set several system parameters that affect the global operation of the SX-1. Press **TRACK**

in the **MAIN DISPLAY MODE** section, and then click on the Global tab to reach this window.

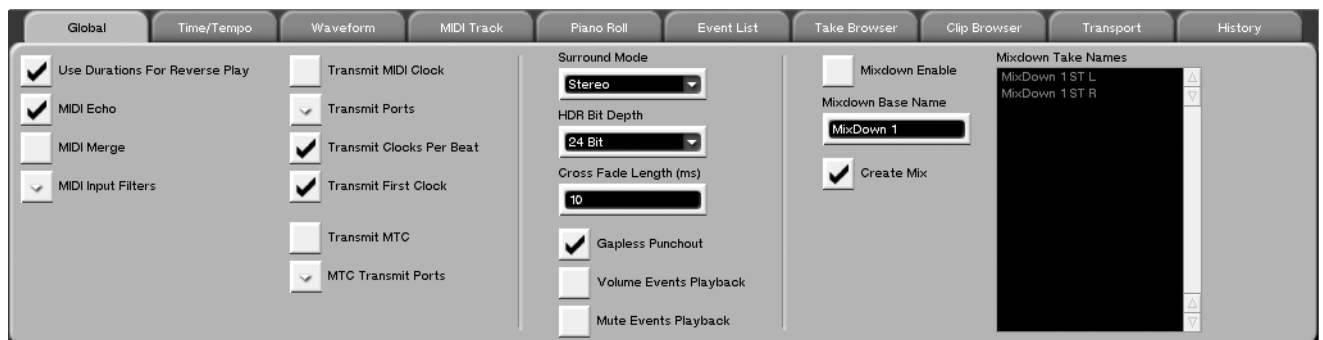

**Surround Mode** Select the type of output configuration for the mixing console: Stereo, Quad, LCRS, and 5.1 Surround. Surround is discussed in "Surround" on page 41.

**HDR Depth** The SX-1 has the ability to play back multiple bit depths in the same project. This parameter determines at what depth audio will be recorded. The choices are 16 or 24-bit.

**Cross Fade Length (ms)** The SX-1 will automatically generate crossfades during recording and editing audio in order to achieve the smoothest possible transitions. This field sets the default length for for these crossfades.

**Gapless Punchout** Check this box to allow immediate switching between monitoring input audio to previously recorded audio. This function affects monitoring only (actual audio punching is always gapless).

**Volume Events Playback** There are other machines in the TASCAM family (such as the MX-

2424 and MMR-8) that have the ability to generate clip based Volume events. While the SX-1 cannot generate these events, checking this box will allow them to play back correctly.

**Mute Events Playback** The SX-1 cannot generate Event Based Mute automation. However, checking this box will allow proper playback of this data.

**TIP**

The MIDI parameters on this tab are covered in Chapter "Global Controls" on page 136, and the Mixdown parameters in "Mixdown, Author, Backup" on page 170..

## LCD Hard Drive (HDR) Screen

This LCD screen reflects the parameters of the Global tab found on the Tracks screen of the VGA. Most of the parameters on this screen are identical to the parameters found in the VGA Global tab and are explained on the previous pages. Only those parameters that are unique to this LCD screen are explained here.

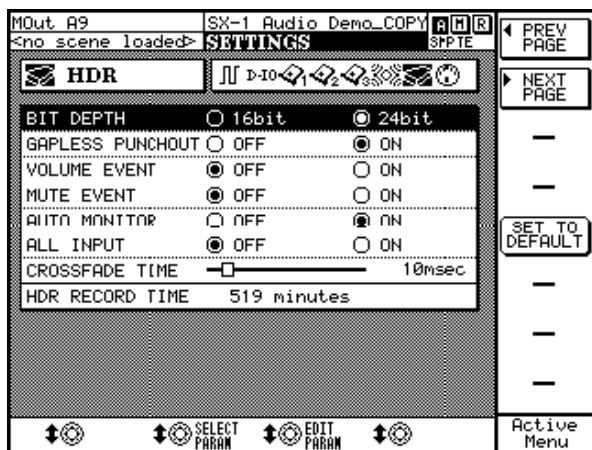

From the **MAIN DISPLAY MODE** section, press **SETTINGS/ PREFS**, and use the NEXT PAGE (or PREV PAGE) soft key to scroll to the HDR screen

**AUTO MONITOR** Turns the Auto Monitor mode for the HDR On or Off. When this mode is active, recording will automatically switch from monitoring the HDR to the record input channels.

**ALL INPUT** This control sets the SX-1 to monitor the inputs of record-enabled tracks, regardless of the state of the transport.

## VGA Clock Settings Tab

This screen is where you set the SX-1's clock settings. If you wish to have the SX-1 communicate with other digital audio devices, you must have the

parameters on this tab set correctly. From the **MAIN DISPLAY MODE**, press **SETTINGS/ PREFS**, then click on the Clock Settings tab.

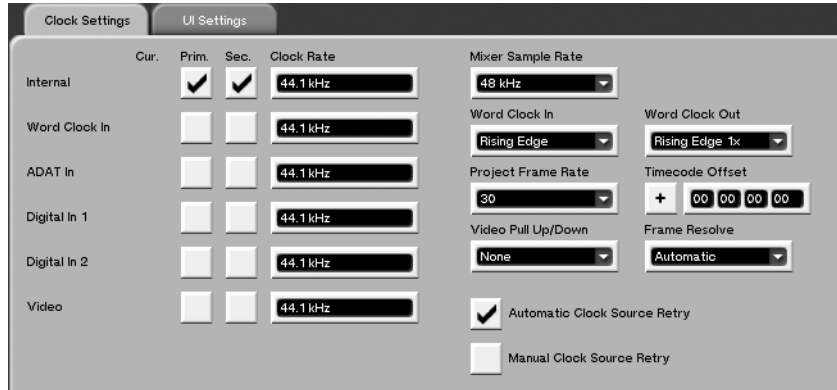

**Cur., Prim., and Sec.** The SX-1 can set up two different clock master scenarios, displayed as Primary and Secondary, utilizing any of the available I/O on the left side of the screen. If the first clock source is not available (PRIM.), it will automatically shunt to the next available clock source (Sec.). If the clock source selected as Secondary is not available, the SX-1 will shunt to Internal clock and mute its output to let you know something is wrong.

**Internal** This displays the SX-1's internal clock state.

**Word Clock In** This displays the sample rate of data coming in the SX-1's rear panel **WORD CLOCK IN** jack.

An added feature for this and the following I/O clock displays is the error readout. Any variance from the normal sample rate detected in the clock stream will be shown in -/+ percentages, which can be an important tool when troubleshooting clock errors.

**ADAT In** This register displays the clock rate of the audio coming in the SX-1's stock Lightpipe™ optical ports (on the unit's rear).

**Digital In 1 & Digital In 2** This register displays the clock rate of the audio coming in the SX-1's stock SPDIF Digital In 1 and 2 jacks (on the unit's rear).

**Video** This displays the clock rate of the data coming in the SX-1's stock video sync ports (on the unit's rear).

**Slot 1 Input 1 to Slot 3 Input 3** These registers display the clock rate of the audio coming in the option cards installed in the SX-1's expansion slots.

**Auto Retry** Knowing that the SX-1 can switch to another clock source if the Primary selection becomes unstable, this setting determines whether or not the master clock will be switched back to Primary if that clock again becomes stable.

**MANUAL RETRY** Pressing this soft key causes the SX-1 to manually search for a valid clock on the Primary selection's port.

**Mixer Sample Rate** This pull-down tab sets the desired sample rate for the SX-1's mixer. If the desired mixer sample rate differs from the selected clock master, the **SAMPLE RATE** indicators on the slanted front panel will flash.

**Word In Setup** There is no industry standard for word clock polarity; this field lets you choose to use the rising edge or the falling edge of the word stream when syncing to external word.

**Word Out Setup** Determines whether the SX-1 outputs word clock that is referenced to the rising edge or falling edge of its own clock reference.

**Video Pull Up/Down** Use this tab when the SX-1 is syncing to an external source that is pulled up or pulled down. These settings are used when syncing to timecode (generally produced from film) that is running at a different rate from the standard. In general, pull ups and pull downs are only used in certain

stages of post-production and should not be used unless absolutely necessary.

**Frame Rate** Use this tab to set the frame rate for the timecode used in the project. Frame rates from 24 through 30 are supported.

### NOTE

To access 30-drop-frame (usually grayed out as this is not a common frame rate), hold down the **SHIFT** key on the PS/2 keyboard while left-clicking this tab.

### LCD Clock Settings Screen

This LCD screen reflects the parameters of the Clock Settings tab found on the Settings screen of the VGA.

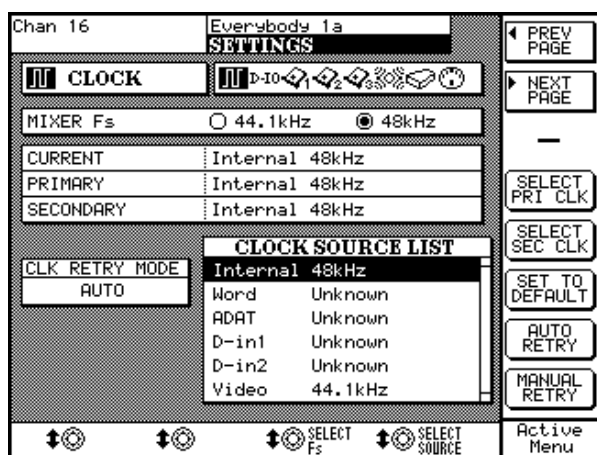

From the **MAIN DISPLAY MODE** section, press **SETTINGS/ PREFS**, and use **NEXT PAGE** (or **PREV PAGE**) soft key to scroll to the **CLOCK** screen.

**SELECT Fs** This soft knob selects the mixer sample rate.

**SMPTE/TIMECODE OFFSET** This parameter determines the amount of offset from incoming and outgoing timecode. Values can be entered by using the PS/2 keyboard.

**FRAME RESOLVE** Use this setting to resolve timecode to the frames received through the video sync input.

**SELECT SOURCE** This soft knob opens a menu where a clock source can be chosen.

**SELECT PRI CLK** This soft key sets the source you have selected as the Primary clock master.

**SELECT SEC CLK** This soft key sets the source you have selected as the Secondary clock master.

**SET TO DEFAULT** Pressing this soft key sets the selected control in question to the factory default value.

**AUTO RETRY** Knowing that the SX-1 can switch to another clock source if the Primary selection becomes unstable, this setting determines whether or not the master clock will be switched back to Primary if that clock again becomes stable.

**MANUAL RETRY** Pressing this soft key causes the SX-1 to manually search for a valid clock on the Primary selection's port.



## LCD EXTERNAL DEVICES Settings Screen

Use this screen to manage the SX-1's transport communication with external devices. See "P2 Remote Machine Control in the SX-1" on page 34 for more details..

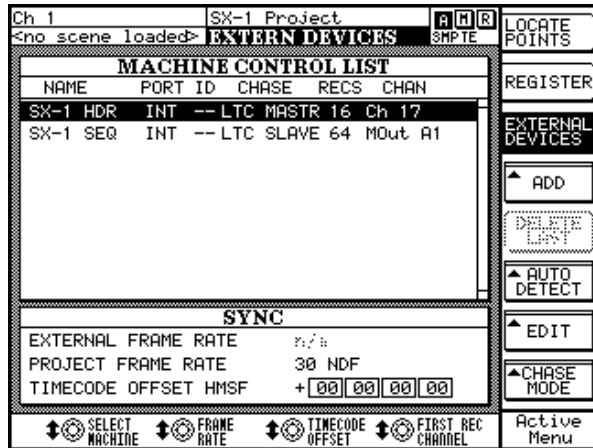

From the **LCD ACCESS** section, press **TRANSPORT**, then press the EXTERNAL DEVICES soft key to reach this screen.

**CHASE MODE** Selects the SX-1's time code source. You should use Internal if the SX-1 is not synchronized to external timecode. You should use LTC if the SX-1 is synchronized to external timecode. Use MTC if the SX-1 is synchronized to MIDI Time Code coming in its MTC port. If the time code Source is either MTC or LTC, the transport will automatically locate and begin playing when the SX-1 receives incoming time code. See "Working with External Timecode Sources" on page 35 for more details of these operations.

**INT TC Rate** This is where you choose the time code (SMPTE/EBU) frame rate that the SX-1 will use and output.

**WORD IN SETUP** There is no industry standard for word clock polarity; this field lets you choose to use the rising edge of the word stream or the falling edge when syncing to external word.

**WORD OUT SETUP** Determines whether the SX-1 outputs word clock that is referenced to the rising edge or falling edge of its own clock reference.

## Digital I/O Settings

When you have another digital audio device hooked up to the SX-1 via its **DIGITAL I/O** jacks, you want to make sure that the SX-1's I/O matches the other device's I/O settings. These parameters can be adjusted from the LCD screen.

### TIP

*The SX-1 can perform sample rate conversion (SRC) in real time via the SDPIF inputs. For example, if your project is at 48kHz but you want to input something that was recorded at 44.1 kHz, set the SX-1's digital input to 48 kHz.*

## LCD Digital I/O Screens

From the **MAIN DISPLAY MODE** section, press **SETTINGS/ PREFS**, and use the **NEXT PAGE** (or **PREV PAGE**) soft key to scroll to the DI/O screen. Then, use the appropriate soft keys to jump to the Digital I/O you want to set. The default screens for the onboard S/PDIF jacks are shown below.

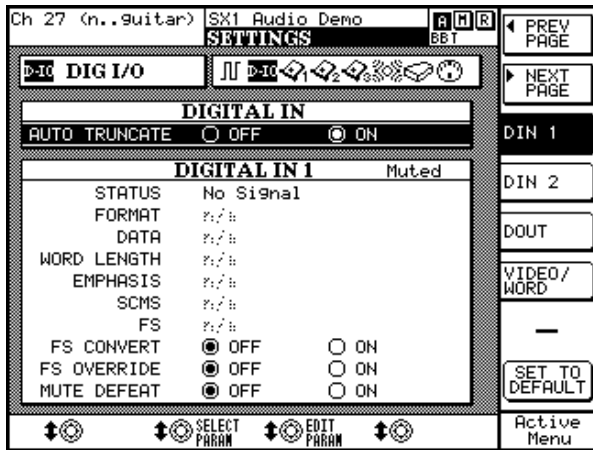

**FS CONVERT** Turns the input sampling frequency conversion on or off. When on, sampling frequencies from 32 kHz to 48 kHz are automatically converted to the current mixer sample rate.

**FS OVERRIDE** Overrides the current mixer sample rate, if sample rate of the source at this jack is different.

**MUTE DEFEAT** Normally, when the SX-1 detects a clock outside its limits of tolerance ( $\pm 6\%$ ) from the nominal sample rate of that source (e.g. a varispeed source), the console mutes. This setting allows you to defeat this operation.

## Option Card Settings

The SX-1 can have up to three Option cards installed in its three expansion Slots. The Options screens, which are unique to the LCD, are where you manage the settings for these cards.

Below is an example of how an Option screen appears with an AES/EBU card fitted in slot 1. The screen will change slightly, depending on the card you have installed.

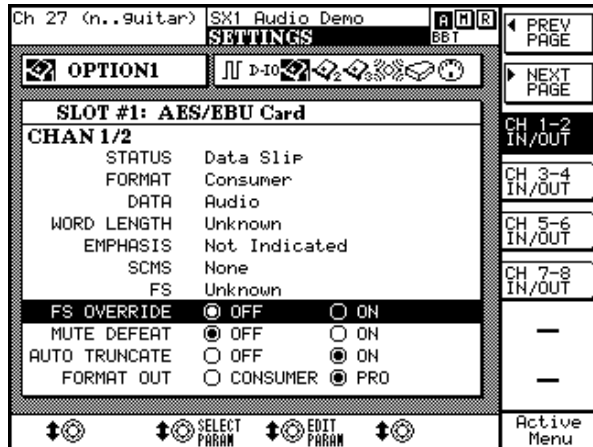

From the **MAIN DISPLAY MODE** section, press **SETTINGS/ PREFS**, and use the NEXT PAGE (or PREV PAGE) soft key to scroll to the Option card screen that you want.

### NOTE

*The options and capabilities differ, according to the type of card fitted. Consult the TASCAM Web site (<http://www.tascam.com>) for up-to-date details.*

## Front Panel SHUTDOWN Key



The **SHUTDOWN** key is located on the SX-1's slanted front panel, just above the **LCD ACCESS** section. It is important to properly shutdown the SX-1 in order to maintain the integrity of your hard drives and

their associated project files along with the SX-1's system. Use this key to execute a proper shutdown.

Press and hold the **SHUTDOWN** key for 3 seconds to execute a proper shutdown. When the SX-1 is ready to be powered off, a message will appear on the LCD screen that reads, It is now safe to turn the SX-1 off.

## Chapter 23 – Inputs and Outputs

### Top Panel

The top panel of the SX-1 is where most of its analog mixer inputs and outputs are located.

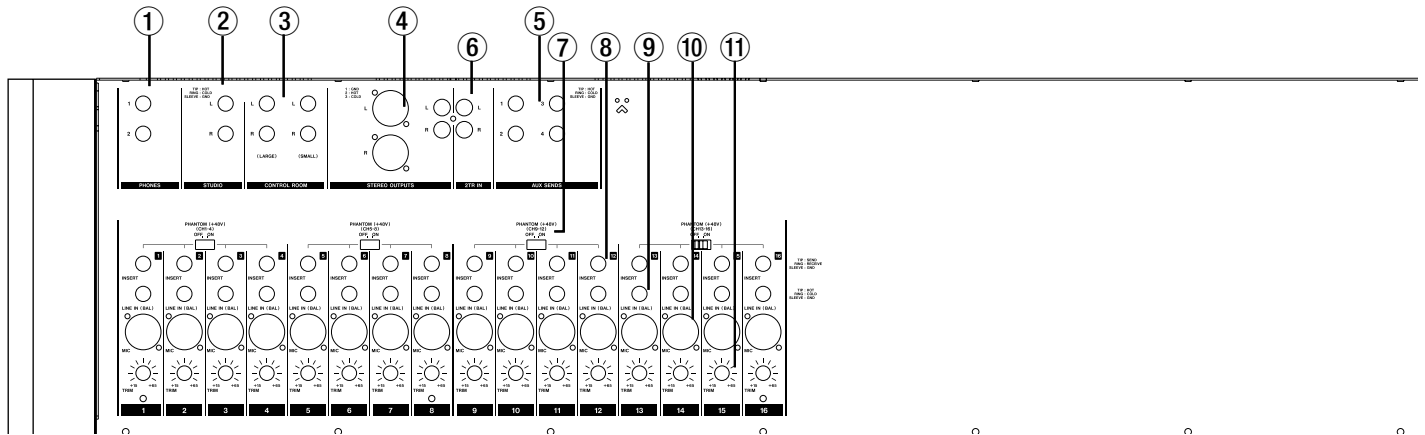

### OUTPUTS

- ① **PHONES (1 & 2)** These stereo output jacks are where you connect your headphones. They are labeled as **1** and **2** to designate their associated control sections which are **PHONES 1** and **PHONES 2** (the controls for which are found on the SX-1's front panel).
- ② **STUDIO** These 1/4-inch balanced TRS outputs are where you connect your Studio speakers (the controls for these outputs are found on the SX-1's front panel).
- ③ **CONTROL ROOM (LARGE) & (SMALL)** These 1/4-inch balanced TRS outputs are where you connect your Control Room speakers (the controls for these outputs are found on the SX-1's front panel).
- ④ **Balanced & unbalanced STEREO OUTPUTS** These are the Master L/R outputs coming directly from the Master fader (at default) on

the SX-1's front panel. Use these outputs to send signal to a mastering device (such as a DAT deck or cassette deck).

- ⑤ **AUX SENDS 1 - 4** By default, these balanced outputs come from the SX-1 Auxiliary sends. You can use these outputs to send signal to outboard processors and additional headphone amplifiers. However (as with all the jacks in this section), flexible routing is available from the Routing screen, which allows other uses for these outputs. As aux sends their level controls are available directly from the SX-1's front panel.

#### NOTE

*All TRS and XLR analog connections operate at +4dBu, while the RCA analog connections operate at -10dBV. The pinouts for these connectors are provided on the SX-1 surface.*

### INPUTS

- ⑥ **2-TR IN** These inputs are of RCA unbalanced type. They are provided as a convenient way of connecting analog two-track inputs (such as a cassette deck or CD player).
- ⑦ **PHANTOM POWER** These switches turn the phantom power for the 16 XLR balanced mic inputs on/off in groups of four channels.

#### TIP

*Never connect or disconnect a microphone with the phantom power on or you could damage the microphone. Always turn the phantom power on after the microphone has been plugged in. Also, never plug a ribbon microphone into a channel where phantom power will be used or it is likely that you will destroy the ribbon element.*

- ⑧ **INSERT** Insert jacks fall before the channel's analog to digital converter. The jacks are of a standard stereo input type with the tip=send, ring=return, and sleeve=ground.
- ⑨ **LINE IN (BAL) [TRS]** These 1/4-inch inputs accept balanced and unbalanced jacks. They are used for line inputs and are of a standard wiring (tip is hot).
- ⑩ **MIX [XLR]** The XLR jacks are connected to their respective mic preamps. The phantom power switch for each group is directly above the XLR jacks. The jacks follow standard wiring (pin 2 is hot).

**WARNING**

Connection of microphone cable and microphones: to prevent hazard or damage, ensure that only microphones designed to the IEC 268-15A standard are connected.

Connexions des microphones et de leurs câbles: pour éviter tout endommagement, s'assurer de vrancher uniquement des microphone et des câbles de microphone conçus selon la norme IEC 268-15A.

- ⑪ **TRIM** These knobs control the gain for the incoming signal. The gain goes from 0dB to +54dB.

## Rear Panel

The rear panel of the SX-1 is where all of the unit's peripheral ports are located, including MIDI, digital I/O, clock sync, and Option Slots.

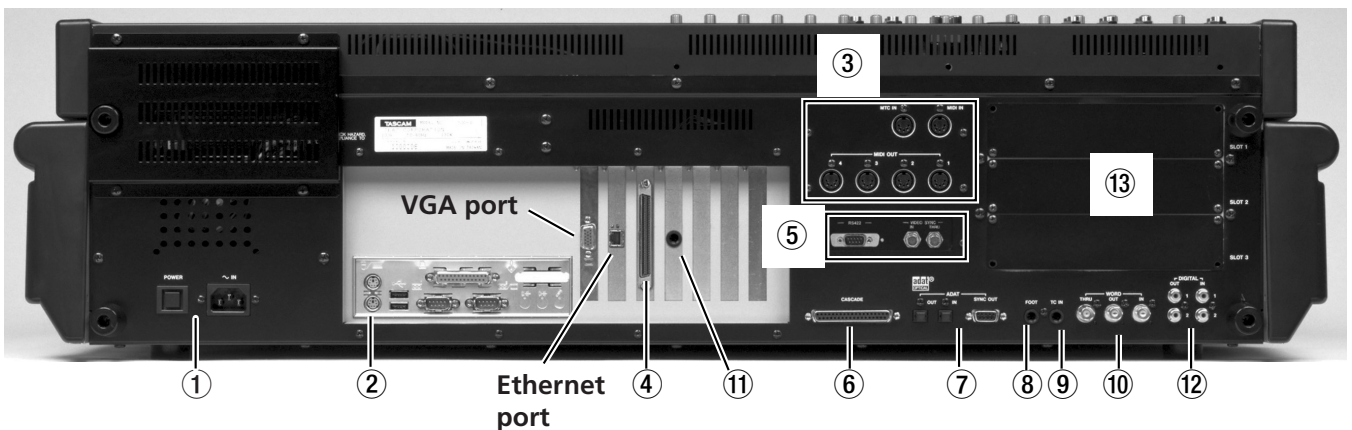

**NOTE**

The position of some of the boards fitted in your SX-1 may differ slightly from the positions shown here..

There are many connections and ports on the SX-1's rear. It is not necessary to understand all of them in order to begin using the machine. For now, the areas highlighted above (and explained below) are the most important. (To learn more about the other connections and ports, see the *Owner's Manual*.)

- ① **Power** This is where the SX-1's power cable connects. An IEC Type II detachable power cable is included with the unit. The **POWER** switch is used to turn the unit on and off.
- ② **Peripheral Ports** The PS/2 keyboard and mouse connect here. The port colored purple is for the provided keyboard, while the green port is for the provided mouse. The other included connections in this section are reserved for future expansion.

**NOTE**

The SX-1 USB ports are disabled.

- ③ **MIDI Ports** Here you will find **MIDI OUT** Ports A, B, C, and D. Connect these ports to the MIDI inputs of your MIDI sound modules. Also in this area is the **MIDI IN**, where you connect the output of your MIDI controller, and a MIDI Time Code (MTC) jack for reading incoming MTC (see "Transport, Loop, Auto Punch" on page 31 for more about synchronization).
- ④ **SCSI Port** The SX1 comes equipped with a 68-pin Ultra Wide SCSI interface. You can use this port to connect to compatible SCSI drives and backup solutions.
- ⑤ **VIDEO IN/THRU & Sony 9-pin** These jacks are involved with synchronization. Connect a Video sync signal (also called *house sync* or *black-burst*) to the **VIDEO IN**. **VIDEO THRU** will pass that

## Part IX—Connections and Ports

same signal directly out, unaffected by any of the SX-1's electronics.

The Sony 9-pin connector (also known as *P2*) is used for connecting to devices that adhere to that protocol. See “P2 Remote Machine Control in the SX-1” on page 34 for more information on connecting P2 devices.

- ⑥ **CASCADE** This connector will be used in a future release to allow a TASCAM DM-24 console to act as a “sidecar” for the SX-1.
- ⑦ **ADAT I/O** These connectors carry eight channels of digital audio in a format commonly referred to as *ADAT lightpipe*. The 9-pin D-sub connector is used for sync/control with an ADAT-style device.
- ⑧ **FOOTSWITCH** Connect a momentary-style pedal here for remote control of recording (punching in or out). The polarity (that is, whether the pedal is normally open or normally closed) of the pedal is set on the LCD PREFERENCES screen.

⑨ **TIME CODE IN** Connect the LTC (Longitudinal Time Code, often referred to as *SMPTE*) output of a device to this input. The SX-1 can chase this incoming code.

⑩ **WORD IN/OUT/THRU** These jacks send and receive word clock signals. The **THRU** connector takes the signal received at the **IN** and sends out an exact mirror, untouched by the SX-1's electronics.

⑪ **LTC OUT** This jack allows the SX-1 to output LTC (or SMPTE). The frame rate is determined on the SETTINGS pages.

⑫ **DIGITAL I/O (SPDIF) 1 and 2** These jacks send and receive digital audio in S/PDIF or AES/EBU format (automatically detected for input, switchable for output). They can be directly monitored in the monitoring sections by selecting either **D-IN 1** or **D-IN 2**.

⑬ **Expansion slots** The SX-1 can have its available I/O expanded by the addition of 8-channel expansion cards in these slots. These cards are the same as those used in the TASCAM DM-24 console.

## Appendix A – PS/2 Keyboard & Mouse Shortcuts

In a growing number of applications, speed of editing and access to functions are absolutely necessary for doing professional work. As such, the SX-1 has two full featured control surfaces: the surface of the unit

itself and an attached PS/2 keyboard and mouse. In this Appendix, the keyboard and mouse shortcuts are outlined.

---

### In General

---

**Alt-click** on most faders and controls snaps them to their default value.

**Right-click** drag on faders (on the VGA) to make fine adjustments.

**Shift-click** will generally do multiple selections in most contexts.

**Tab** will move left to right within text boxes of the same type, while **Shift-tab** reverses this and moves right to left.

**Escape** stops editing any text box, reverting to the previous contents.

---

### Track Management

---

**Alt-click** a track to select it from 0 to infinity (from the absolute beginning to the absolute end).

**Shift-click** a track in region mode to modify the existing selection.

**Control-click** a track in region mode to change the sync point.

**Delete or Backspace** will perform a Clear.

Locate to the seven register points by typing the first letter of their name:

**b** Begin

**e** End

**s** Sync

**i** In (punch)

**o** Out (punch)

**f** From (loop)

**t** To (loop)

**-/+ keys** in numeric keypad perform Nudge Left and Nudge Right.

**Right-click** events in event mode to change the duration or start time, based on whether you click in the first half or second half of the event.

**Control-click** to Copy an audio event while dragging.

**Alt-click** yellow track selection buttons to select all tracks.

---

### Piano Roll Management

---

Hold **Control** while dragging MIDI notes to adjust only pitch.

Hold **Option** while dragging MIDI notes to adjust only time.

**Right-click** on a MIDI note with the Pencil Tool to erase it.

**Left-click** on a note on the keyboard to select all notes of that pitch.

**Right-click** on a note on the keyboard to play it.

---

### TrackScale View (*the grey zooming bar*)

---

**Left-click** and **drag** to locate.

**Left-click** in blank area to jump one window in that direction.

**Right-click** and **drag** in the grey area to zoom views.

---

### Ruler

---

**Left-click** to make a selection across all tracks.

**Right-click** to locate to that time.

**Alt-click** to select all tracks from 0 to infinity (absolute beginning to absolute end).

---

### Transport

---

**Space** will play if stopped, and stop if the transport is moving.

**< or l** Jump left

**> or r** Jump right

**Alt-Space** will reverse play.

**Alt - Enter** Record

**, (comma key)** Rewind

**. (period key)** Fast Forward



## Appendix B – Control Surface Shortcuts

In this Appendix, the control surface shortcuts are outlined.

---

### SHIFT Key

---

Normally, the **SHIFT** key is used as a one-shot latching 2nd function key.

If you press and release **SHIFT**, its LED comes on and remains on until you press another key. Pressing another key will cause the LED to go off, and if the key pressed has a second function written in blue below it, the second function will be invoked.

The **SHIFT** function can also be used in another way. If you press and hold the **SHIFT** key down while pressing another key, or turning a virtual pot, special commands are accessed. The following is a list of these commands:

- Any button with a blue-labeled 2nd function will invoke its 2nd function.
- Encoders (like the virtual channel knobs or soft knobs) will allow for fine adjustment.
- The **MAIN DISPLAY** key will cycle through the four time display modes.
- Monitor **SOURCE** keys will cycle sources in reverse.
- The solo **MODE** key will cycle modes in reverse.
- If the **SOLO** key is on and the solo mode is In-Place, pressing a channel's **MUTE** key will toggle to solo safe.
- Pressing the **CUE** key causes the Master L/R mix to be copied to the Cue mix.
- Quick group editing (while [SHIFT] is held down) includes:
  - ➔ The first channel **SEL** key pressed is the Group Master. The Group Master's **SEL** key LED will come on solid. The Slave channels' **SEL** keys blink.
  - ➔ Pressing the group master's **SEL** key again will dissolve the group.
  - ➔ Pressing other channels' **SEL** keys will add or remove them from the group.
  - ➔ Group editing is completed when the **SHIFT** button is released.
- **PLAY** will reverse play.
- **STOP** will eject media on external device.
- **TALKBACK** will enter slate mode.

---

### CANCEL Key

---

The **CANCEL** key is sometimes used as a “set to default” modifier.

Pressing and holding the **CANCEL** key while pressing another key, turning an encoder, or touching a fader may cause that controller to be set to a default value.

Special functions that happen while the **CANCEL** key is held down include:

- Turning any channel controller will set it to its default value.
- Turning LCD soft knobs will set some LCD widgets to their default value.
- Touching and “untouching” a fader cap will set it to 0 dB (or MIDI 127 on MIDI channels).
- Pressing **CUE** key will cause the entire cue mix (pans, pan mode, faders) to be set to their factory default values.
- **CANCEL** + 3 will clear peak holds.
- **CANCEL** + **SEL** initializes an entire channel strip.

---

### Transport Key Combinations

---

**SHIFT** + **PLAY** reverse play

**REW** + **PLAY** reverse play

**SHIFT** + **STOP** eject media

**SHIFT** + **JOG** allows fine adjusts

---

### Channel Select Key Special Functionality

---

- Pressing an odd and even pair of channel **SEL** keys simultaneously will link/unlink two channel strips.
- Pressing and holding a **SEL** key will cause the UI to switch to that Channel screen.
- **SHIFT + SEL** is used for group editing (see Group Editing explanation under Shift Key Shortcuts, above).

---

### DIM, MONO & TALKBACK Special Functionality

---

These key toggle their associated function on or off if pressed and released within 1/2 second. If held longer, the buttons act as momentary switches.

### Appendix C – Block Diagrams (i)

SX-1 Signal Flow at Normal FS, Stereo Mix Mode

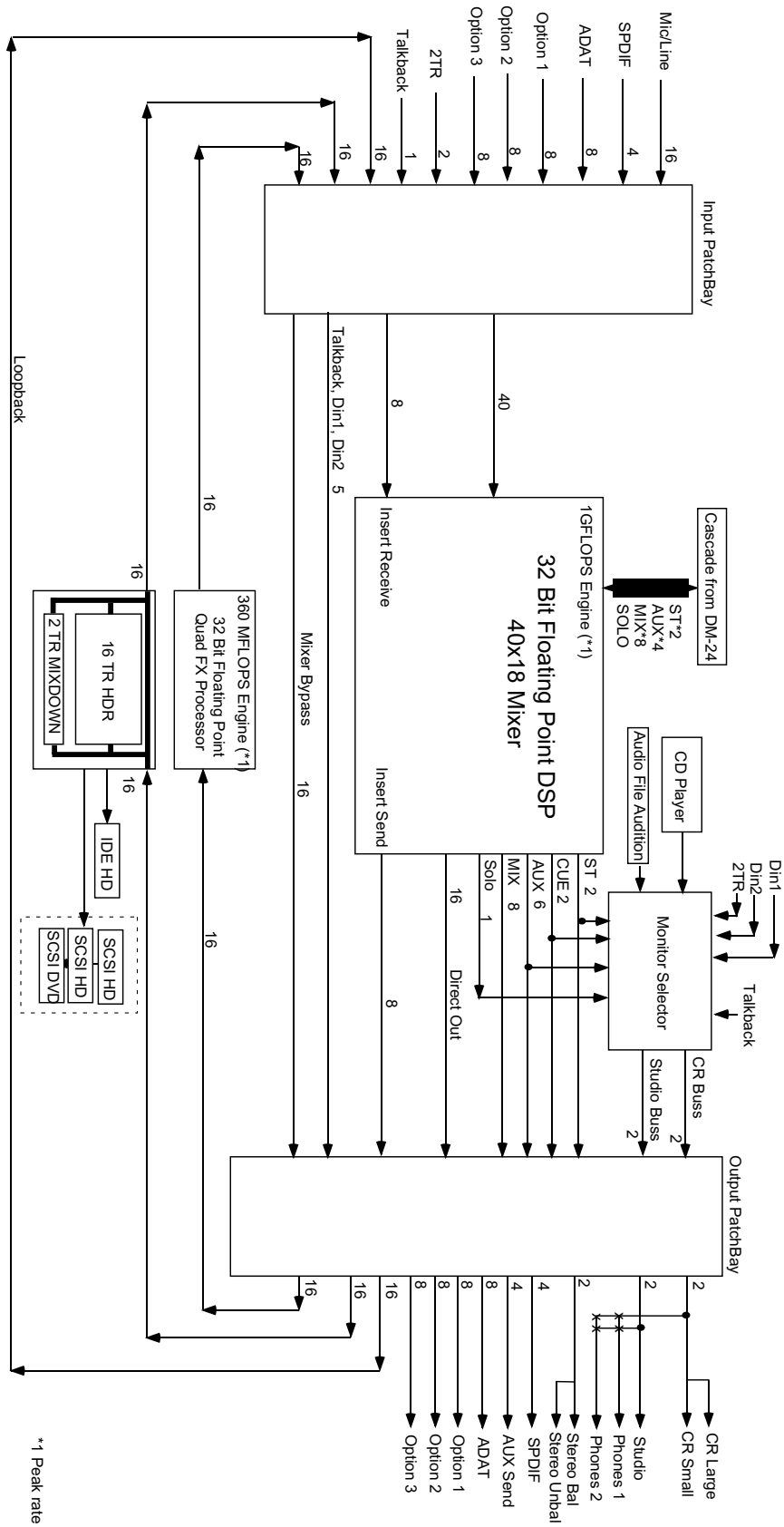

\*1 Peak rate

## Block Diagram (ii)

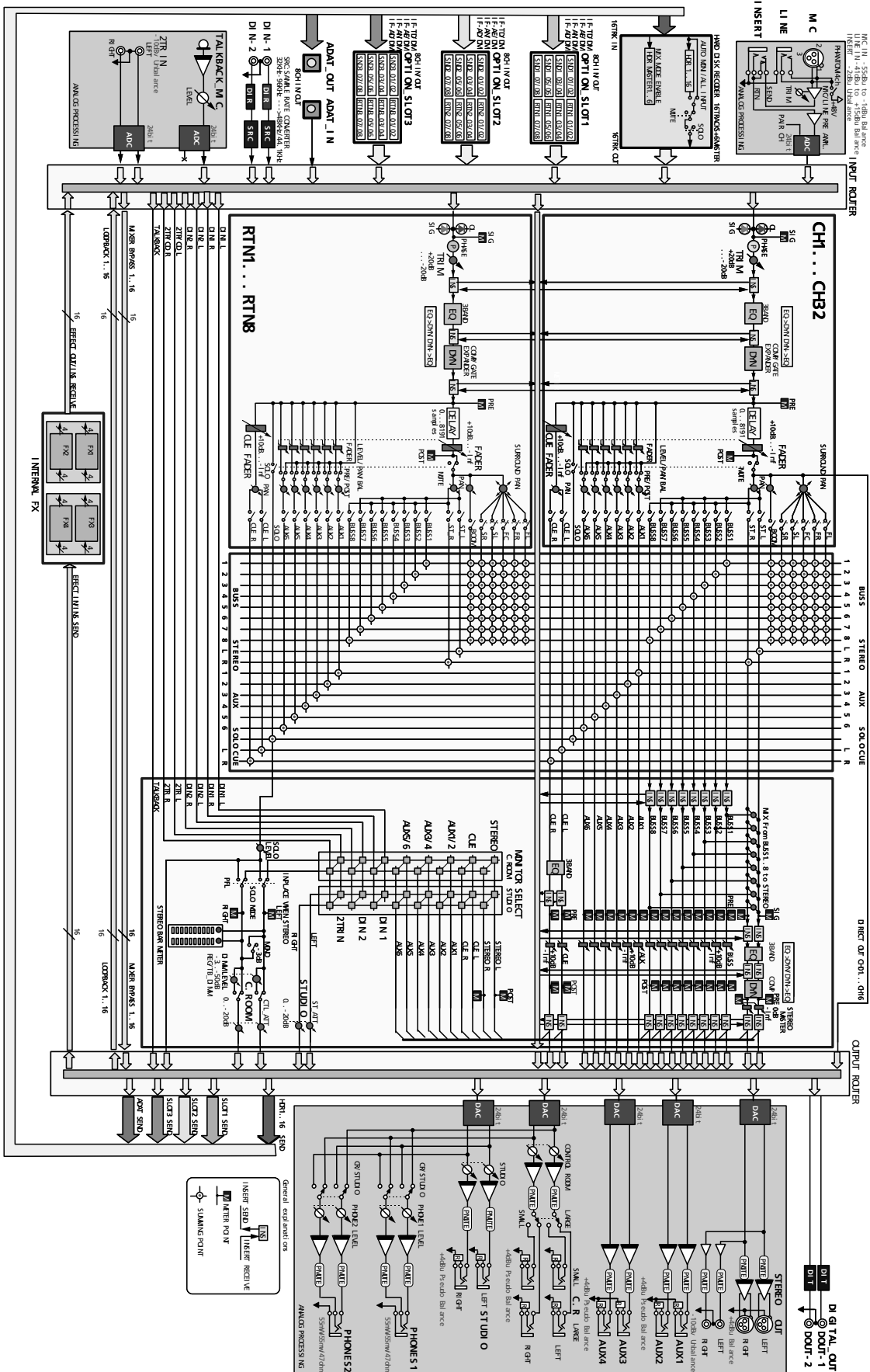

Version 1.00 TASCAM

# Appendix D – Level diagram

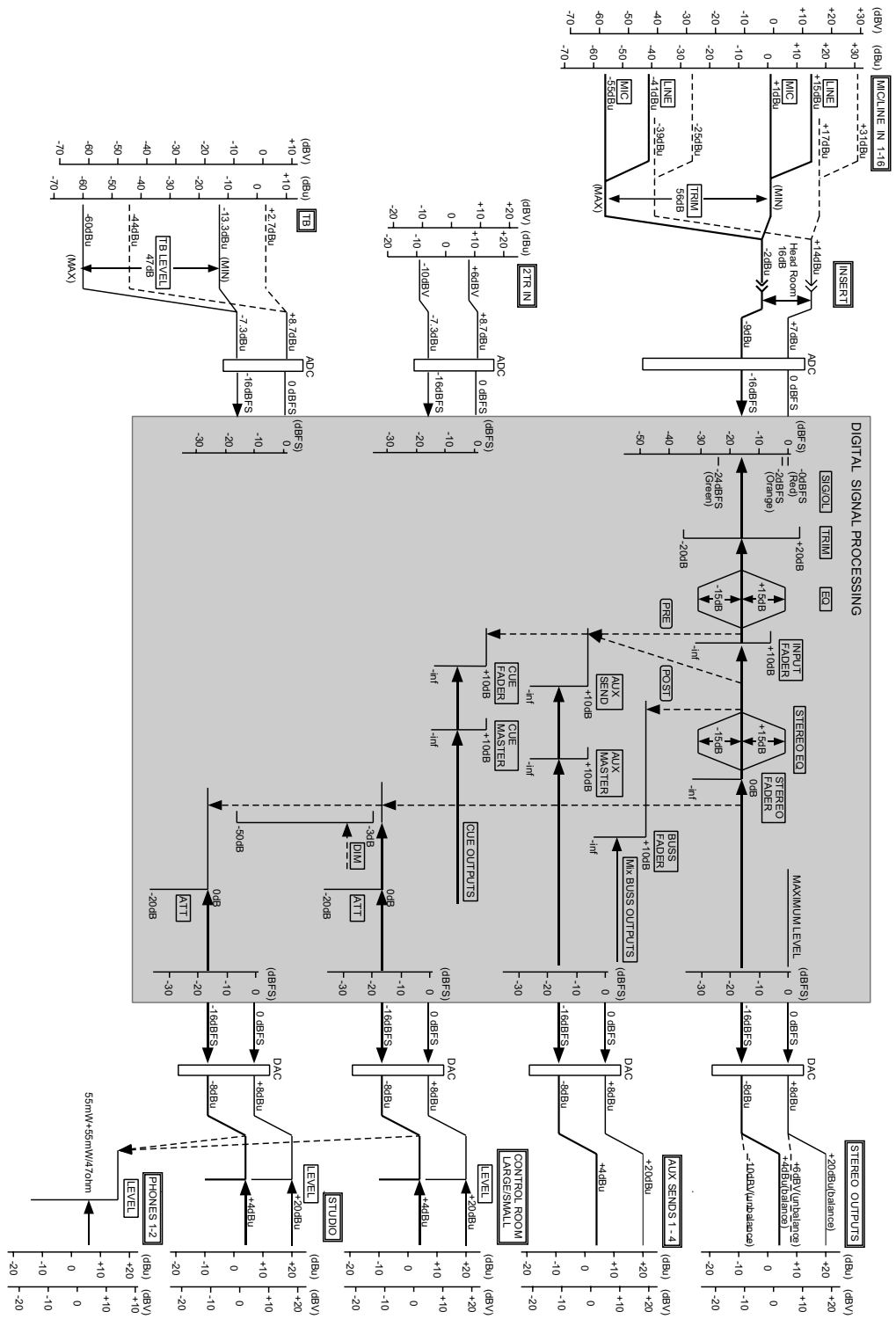

SX-1 Version 1.00

## Appendix E – Specifications

### Physical specifications

Power requirements	120VAC, 60Hz (USA, Canada) 230VAC, 50Hz (Europe) 240VAC, 50Hz (Australia) 220VAC, 60Hz (Korea)
Power consumption	146W
Applicable electromagnetic environment	E4
Peak inrush current	Max 8.5A
Dimensions (w x h x d)	954 x 261 x 756 (mm) 37.6 x 10.3 x 29.8 (in)
Weight	40kg (88lb)

### Dimensional drawing

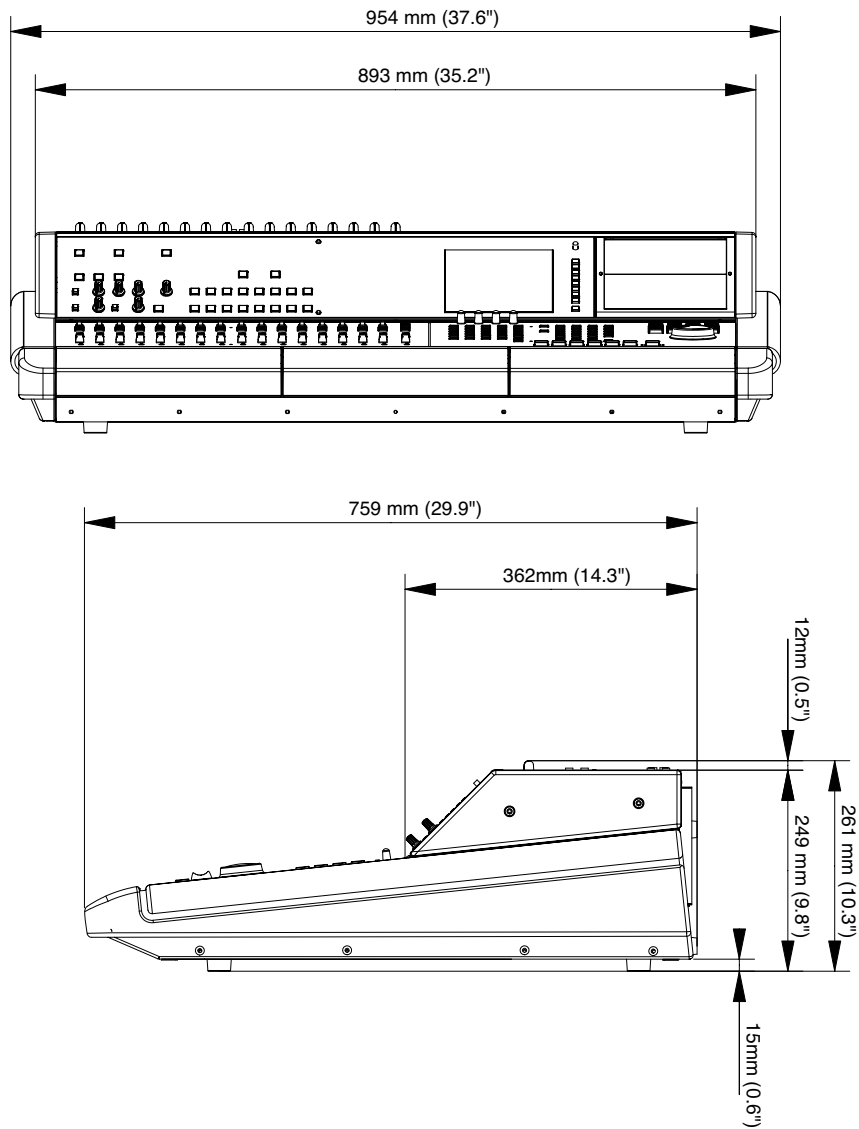

## Audio specifications

### I/O (analog)

<b>MIC IN 1–16</b> XLR-3-31 <sup>a</sup> balanced	Input impedance	2.2k $\Omega$
	Input level	–55dBu ( <b>TRIM</b> maximum) — +1dBu ( <b>TRIM</b> minimum)
	Headroom	16dB
	Phantom power	+48V (switchable in groups of 4 channels)
<b>LINE IN 1–16</b> TRS 1/4 <sup>tb</sup> x 16, balanced	Input impedance	10k $\Omega$
	Nominal input level	+4dBu
	Input level	–41dBu ( <b>TRIM</b> maximum) — +15dBu ( <b>TRIM</b> minimum)
	Headroom	16dB
<b>2 TR IN (L/R)</b> RCA (phono) x 2, unbalanced	Input impedance	10k $\Omega$
	Nominal input level	–10dBV
	Headroom	16dB
<b>STEREO OUTPUT (L/R)</b> XLR-3-32 balanced	Output impedance	100 $\Omega$
	Nominal output level	+4dBu
	Maximum output level	+20dBu
<b>STEREO OUTPUT (L/R)</b> RCA (phono) x 2, unbalanced	Output impedance	200 $\Omega$
	Nominal output level	–10dBV
	Maximum output level	+6dBV
<b>AUX OUTPUT 1-4</b> TRS 1/4" x 4, balanced	Output impedance	100 $\Omega$
	Nominal output level	+4dBu
	Maximum output level	+20dBu
<b>CR LARGE MONITOR</b> output (L/R) TRS 1/4" x 2, balanced	Output impedance	200 $\Omega$
	Nominal output level	+4dBu
	Maximum output level	+20dBu
<b>CR SMALL MONITOR</b> output (L/R) TRS 1/4" x 2, balanced	Output impedance	200 $\Omega$
	Nominal output level	+4dBu
	Maximum output level	+20dBu
<b>STUDIO MONITOR</b> output (L/R) TRS 1/4" x 2, balanced	Output impedance	100 $\Omega$
	Nominal output level	+4dBu
	Maximum output level	+20dBu
<b>PHONES 1-2</b> , 1/4" stereo x 2	Output power	55mW + 55mW
		47 $\Omega$
<b>INSERT 1-16</b> TRS <sup>c</sup> x 16, unbalanced	Output impedance	100 $\Omega$
	Nominal output level	–2dBu
	Input impedance	10k $\Omega$
	Nominal input level	–2dBu
	Headroom	16dB

a. All XLR connectors are wired 1=ground, 2=hot, 3=cold

b. All balanced TRS 1/4" jacks are wired tip=hot, ring=cold, sleeve=ground

c. Insert 1/4" jacks are wired: tip=send, ring=receive, sleeve=ground

## Part X—Specifications, etc.

### I/O (digital)

<b>DIGITAL INPUT 1 COAXIAL</b> RCA (phono)	Input impedance	75Ω
	Format	AES-3-1992/IEC60958 (automatic detection)
	Bit depth	24 bits
<b>DIGITAL INPUT 2 COAXIAL RCA</b> (phono)	Input impedance	75Ω
	Format	AES-3-1992/IEC60958 (automatic detection)
	Bit depth	24 bits
<b>ADAT IN</b> optical	Format	ADAT optical
	Bit depth	24 bits
<b>DIGITAL OUTPUT 1 COAXIAL</b> RCA (phono)	Output impedance	75Ω
	Format	AES-3-1992/IEC60958 (selectable)
	Bit depth	24 bits
<b>DIGITAL OUTPUT 2 COAXIAL</b> RCA (phono)	Output impedance	75Ω
	Format	AES-3-1992/IEC60958 (selectable)
	Bit depth	24 bits
<b>ADAT OUT</b> optical	Format	ADAT optical
	Bit depth	24 bits

### Synchronization, etc. I/O

<b>CASCADE</b> D-sub 37 pin female	Cascades busses 1 through 8, Aux sends 1 through 6, stereo and solo (at normal sampling rates)	
	Compatibility	DM-24 standard
<b>WORD SYNC IN</b> BNC	Input impedance	75Ω
	Input level	TTL
<b>WORD SYNC OUT</b> BNC	Output level	TTL
<b>WORD SYNC THRU</b> BNC		
<b>TIMECODE IN</b> TRS balanced	Input impedance	10kΩ
<b>LTC OUT</b> TRS balanced	Output impedance	< 100Ω
	Output level	2Vp-p
<b>MIDI IN</b> 5-pin DIN	Conforms to MIDI standards	
<b>MTC IN</b> 5-pin DIN	Conforms to MIDI standards	
<b>MIDI OUT</b> x 4 5-pin DIN	Conform to MIDI standards	
<b>ADAT SYNC OUT</b> 9-pin D-sub	ADAT sync protocol <sup>a</sup>	
<b>VIDEO IN</b> BNC	Input impedance	75Ω
	Input level	1Vp-p/4Vp-p
<b>VIDEO THRU</b> BNC		
<b>RS-422</b> 9-pin D-sub female	Format	RS-422 / P2 protocol

a. Unavailable in high sampling frequency modes

### Other connections, etc.

VGA high-density 15-pin D-sub		
Ethernet RJ-45, 10/100BASE-T		
SCSI Ultra2 SCSI	16-bit LVD (Low Voltage Differential)	
	Internal 68-pin	
	External 68-pin	
Option card slots	x 3	TASCAM standard
Faders	100mm, automated, touch-sensitive, 256 levels	
LCD screen	Backlit, 320 x 240 pixel	
Meters x 2	30-segment LED	
Timecode display	8 x 7-segment LED	



## Performance

Sampling frequency (base)	48.0kHz/44.1kHz $\pm$ 6%	
Delay	< 1.7ms	Fs=48kHz, LINE IN -> STEREO OUTPUT
THD (at nominal level)	< 0.01%	20Hz — 20kHz, LINE IN -> INSERT SEND)
	< 0.01%	LINE IN -> STEREO OUTPUT
Frequency response (nominal level)	20Hz — 25kHz	+0.5dB/-1.5dB (MIC/LINE IN -> INSERT SEND)
	20Hz — 20kHz	+0.5dB/-1.0dB (LINE IN -> STEREO OUTPUT)
	20Hz — 20kHz	+0.5dB/-1.0dB (LINE IN -> BUSS/AUX OUTPUT)
	20Hz — 20kHz	+0.5dB/-1.0dB (2TR IN -> MONITOR OUTPUTS)
	20Hz — 20kHz	+0.5dB/-1.0dB (CD-RW -> MONITOR OUTPUTS)
Noise level (20Hz — 20kHz, TRIM max, 150 $\Omega$ )	<-125dBu	EIN, MIC IN -> INSERT SEND
	<-80dB	LINE IN -> STEREO OUTPUT BAL
	<-80dB	LINE IN -> STEREO OUTPUT UNBAL
	<-80dB	LINE IN -> BUSS/AUX OUTPUT
	<-80dB	2TR IN -> MONITOR OUTPUT
Crosstalk (1kHz)	>80dB	STEREO/BUSS/AUX OUTPUTS
	>68dB	MONITOR OUTPUTS

## Appendix F – MIDI Implementation Chart

TEAC [Digital Mixer]

DATE : 10June, :2002

Model: SX-1

MIDI Implementation Chart

Version : 1.0

Function		Transmitted	Recognized	Remarks
Basic Channel	Default Changed	– Port 1–4 1-16	OMNI 1-16	Memorized
Mode	Default Messages Altered	x O NONE *****	x O O	
Note Number	True Voice	O *****	O O	
Velocity	Note On Note Off	O O	0 0	
After Touch	Key's Ch's	O O	O O	
Pitch Bend		O	O	
Control Change	1-119	O	O	
Prog Change	True #	O (1-127) *****	O (1-127) *****	
System Exclusive		O	x	(a)
Common	MTC Quarter Frame Song Pos Song Sel Tune	O x x x	O x x x	
System Real Time	Clock Commands	O O	x x	
Aux Messages	Local ON/OFF All Notes OFF Active Sense Reset	x O O (b) x	x x x x	(c)

a. SysEx transmit possible only if imported via SMF. Editing of SysEx not possible in version 1.0

b. All four Output ports turned off together

c. Transmitted when front panel PANIC button is pressed

MODE 1: OMNI ON, POLY

MODE 2: OMNI ON, MONO

O: Yes

MODE 3: OMNI OFF, POLY

MODE 4: OMNI OFF, MONO

x: No

**A**

active sensing (MIDI) 139  
 after-fader solo 23  
 ALL SAFE (automation) 25, 87  
 ALL SAFE (record) 45  
 Alt key 15  
 analog input routing 63  
 Antares microphone modeler 113–116  
 Antares speaker modeler 117  
 assignment to busses 52  
 audio clips  
   rendering 123  
 audio editing 127  
 audio performance 205  
 audio regions 122  
   editing 122  
   tool selection 122  
   viewing waveforms 122, 124  
 audio specifications 203  
 audition function 132  
 auto fade (automation) 87, 93  
 auto punch 37, 39  
 auto revert (automation) 96–99, 101, 103–104  
 auto state (automation) 80  
 automatic play mode 31  
 automation  
   all safe 87  
   and groups 105  
   auto fade 87, 93  
   auto revert 96–99, 101, 103–104  
   auto state 80  
   control sense timeout 100, 102  
   display 88–90  
   display filters 92  
   edit operations 90–91  
   event editor 91  
   events 91  
   front panel controls 86  
   global settings 93  
   global write 81  
   history 91  
   init edit 82, 87  
   initial event ramp time 82  
   initial status 82  
   keep mix 84  
   library recall in 104–105  
   mix management 84  
   modes and states 80  
   off setting 81  
   rehearse 83  
   rendering library recalls 92  
   revert 87  
   revert time 95, 100, 103  
   safe mode 81  
   static state 80  
   status 46  
   status indicators 25

switch events 100  
 touch/keep 86  
 trim mode 81, 87, 102  
 write mode 80, 95  
 write to end 100  
 aux returns 65, 67  
 aux sends 48, 51, 65  
   effects 111  
   faders 73  
   linking 70  
   monitoring 21  
   overview 77  
   pre/post 48

**B**

backing up 179–180  
 backup 173  
 backup files 178  
 BANK MODE key 73  
 bbt (bars, beats, ticks) 39  
 bit depth 185  
 blackburst 193  
 block diagram 199–200  
 boom (surround) 42  
 buss  
   assignments 47, 52, 57, 63, 65  
   assignments (surround) 42  
   faders 73  
   masters 64  
   overview 77–78  
   routing 29  
 bussing 57  
 bypass 58

**C**

CANCEL Key 197  
 CANCEL key 13  
 CAPTURE key 38  
 capturing locate points 38  
 cascade connector 194  
 CD burning 173–174  
 CD-RW operations 174  
 channels  
   aux sends 48  
   channel strips 45  
   copying settings (trim & delay) 52  
   delay 52  
   dynamics processors 49  
   EQ 49  
   grouping 48, 71  
   insert 48, 52  
   linking 48, 51, 69  
   overview 77, 79  
   phase polarity 52  
   REC key 45  
   selection 45  
   trim 52

## Index D - F

character entry *12*  
chase mode *33*  
clean up of hard disks *178*  
clear(audio editing) *129*  
clips  
    audio editing *125*  
clock (MIDI) *138*  
comping tracks *170*  
compressor *49, 51*  
    settings *50*  
conductor track *18*  
control room *21*  
control sense oime out (automation) *100*  
control sense timeout (automation) *102*  
copy (audio editing) *128*  
copying projects *167*  
creating locate points *38*  
crescendo (MIDI) *164*  
crossfading *186*  
cue mix *21*  
cueing *46, 48*  
    linking *70*  
cueing mode (jump) *31*  
cut (audio editing) *128*

---

### D

date and time setting *184*  
DC offset (audio editing) *123*  
de-essor *117*  
default on-screen colors *182*  
deferred play mode *32*  
delay  
    linking *70*  
deleting projects *167*  
digital inputs *26, 190, 194*  
digital outputs *194*  
dimensions *202*  
dimming (panic) *17*  
dimming monitor signals *22*  
disk  
    clean up *167–168*  
disks *175*  
display  
    scrolling *17*  
    zooming *17*  
display filters (automation) *92*  
dithering (effect) *118*  
divergence (surround) *42*  
DTRS (MTR) *33*  
dynamics *49*  
    linking *70*  
    placement in channel *47*  
    processors *51*

---

### E

echo (MIDI) *138*  
edit operations (automation) *90–91*  
editing

audio *127*  
audio clear *129*  
audio copy *128*  
audio cut *128*  
audio paste *129*  
audio redo *130*  
audio ripple *130*  
audio split *129*  
audio Takes *124*  
audio trim *129*  
audio undo *130*  
clips *125*  
DC offset *123*  
fades *123*  
HyperSelect *123, 130, 160*  
in and out points *18*  
locate points *38*  
MIDI *140–145, 156–164*  
MIDI merge *130*  
MIDI pencil *156*  
MIDI tools *155*  
normalize *123*  
open area *131*  
rendering audio clips *123*  
reverse *123*  
editing effects *112*  
editing tools *122*  
editing tools (automation) *90*  
effects *106*  
    controls *108–109*  
    de-essor *117*  
    dither *118*  
    exciter *118*  
    inserts *60*  
    libraries *109*  
    microphone modeler *113–116*  
    parameters *112*  
    plugins *108, 112*  
    quadrants *107*  
    routing *58, 107, 111*  
    slots *107*  
    speaker modeler *117*  
    TC reverb *119–121*  
ENTER key *13*  
EQ *49*  
    linking *70*  
Escape key (PS/2) *18*  
event editor (automation) *91*  
event list (MIDI) *165*  
events (automation) *91*  
exciter *118*  
expander *49, 51*  
external devices *24*

---

### F

fader banks  
    user fader banks *75–76*

fader groups 71  
 fader links 69  
 faders  
   aux send faders 73  
   buss faders 73  
   channel faders 45  
   fader banks 73  
   MIDI faders 73  
   revert (automation) 87  
   touch-sensitivity 80  
 fades (audio editing) 123  
 filtering available effects (in libraries) 109  
 filters (MIDI) 138  
 filters (notch, HPF, LPF, shelf) 49  
 footswitch 194  
 formats of hard disks 176

---

## G

gate  
   settings 50  
 gate (dynamics) 49, 51  
 global settings for automation 93  
 global write mode (automation) 81  
 grid 18, 131  
 grouping  
   group masters 72  
 grouping channels 48, 71  
 groups  
   automation and 105

---

## H

hard disk recorder (HDR) 24  
 hard disks 175  
   cleanup 178  
   formats 176  
   settings 180, 186  
 hard drives 175  
 HDR 24, 34  
   routing 58  
 headphones 23, 192  
 HPF 49  
 history (automation) 91  
 horizontal divergence (surround) 42  
 house sync 193  
 HyperSelect 160  
 HyperSelect (editing) 123, 130

---

## I

immediate play mode 31  
 importing library entries from other projects 53–55  
 INIT EDIT (automation) 25  
 init edit (automation) 82, 87  
 initial event ramp time (automation) 82  
 initial status (automation) 82  
 in-place solo 23

insert 193  
 inserts 59–60, 62  
   channels 48  
   effects 111  
   presets 59  
   returns 59  
   routing to mixer channel 61–62  
   sends 59  
 ISO CD burning 173

---

## J

jog dial 13  
 JUMP keys 31  
 jump modes 31

---

## K

keep mix (automation) 84  
 keyboard (PS/2) 15  
 keypad 12–13

---

## L

large speakers 22, 192  
 LCD  
   contrast 30  
   display 14  
   display access 29  
   transport controls 32  
 LCRS 41  
 level diagram 201  
 LFE 42  
 libraries 68  
   dynamics processors 50  
   effects 109  
   EQ, dynamics and snapshots 53, 55  
   importing from other projects 53–55, 109  
   overview 56  
   rendering recalls for automation 92  
   routing 68  
   scenes 54–55  
   use with automation 104–105  
 library entries  
   managing 56  
 linking 48, 51  
   channels 69–70  
 loading projects 167  
 locate points 31, 38, 40  
   creating 38  
   editing 38  
   on the VGA 39  
   recalling 38  
   using 39  
 loopback 58  
 looping 37  
 LPF {low pass} 49

## M

MAIN DISPLAY key 27  
MAIN DISPLAY Mode Section 27  
MAIN DISPLAY MODES 14  
Main Menu Bar 17  
managing library entries 56  
master  
    overview 77  
master channel 28, 45  
master fader  
    surround 43  
master outputs 192  
menu items 17  
merge (MIDI editing) 130  
merge (MIDI) 138  
meters 25–26  
    settings 183  
metronome 19, 148  
microphone modeler 113–116  
MIDI  
    active sense 139  
    activity LED 139  
    channel display 136  
    clock 138  
    controllers 135  
    crescendo 164  
    echo 19, 138  
    editing 140–145, 155–164  
    event list 165  
    file concepts 150  
    filtering 138  
    implementation chart 206  
    inputs and outputs 193  
    merge 138  
    metronome 148  
    MIDI faders 73  
    MIDI Time Code 139  
    monitoring 152  
    MTC (MIDI Time Code) 33  
    MTC chase 25  
    offset 144  
    output 138  
    outputs 154  
    overview 152  
    panic 17  
    piano roll 29, 134, 157, 159, 195  
    quantization 140  
    quantize 161  
    randomize 142  
    reverse play 137  
    sensitivity 143  
    sequencer 24, 34, 133  
    SMF 151  
    step recording 146–147  
    swing 142  
    takes 150

    tempo 149  
    track display 134  
    transposition 144  
mix management (automation) 84  
mixdown  
    creating mixes 171  
    making a CD of the mix 174  
    mixdown mode 170  
    surround 43, 172  
monitoring  
    2-track 21  
    aux sends 21  
    control room 21, 192  
    cue mix 21  
    cueing 46  
    dimming 22  
    level 22  
    MIDI 152  
    speaker selection 22  
    studio 22, 192  
    talkback 198  
mouse 193  
MTC  
    chase 25  
multi-function keys 12  
MUTE key 47

## N

naming entries 12  
naming mixes 171  
navigation 12, 15  
new project 166–167  
normalize (audio editing) 123  
notch filter 49  
nudge 18  
NUM LOCK key 13  
numeric entry 12  
numeric keypad 12–13

## O

off setting (automation) 81  
offset (MIDI) 144  
overview  
    MIDI 152  
open area (editing) 131  
option cards 191

## P

P2 control 33–34, 193  
pan pots 13, 46  
panic 17  
panning 48  
paste (audio editing) 129  
physical specifications 202  
piano roll 195  
piano roll (MIDI) 134

play modes 31  
 playback  
   looping 37, 40  
 plugins (effects) 108  
 post-roll (audition) 132  
 pre-fader solo 23  
 preferences 182–183  
   date and time setting  
     timestamps 184  
   meters 183  
 pre-roll (audition) 132  
 project management 166–168  
 projects  
   structure 176  
 PS/2 keyboard 15, 28, 182, 193  
   shortcuts 195  
 PS/2 mouse 193  
 punch recording 37, 194

---

## Q

Q (EQ) 49  
 quad 41  
 quadrants (effects) 106  
 quantization (MIDI) 140, 161

---

## R

randomize factor (MIDI) 142  
 ratio (compressor) 50  
 recalling locate points 38  
 record arming 45, 47  
 RECORD key 32  
 "Red Book" CDs 174  
 redo (audio editing) 130  
 rehearsal 37, 39  
 rehearse (automation) 83  
 remote track arming 32  
 renaming projects 167  
 rendering audio clips 123  
 rendering library recalls (automation) 92  
 resolution 18  
 reverb 119–121  
 reversal (audio editing) 123  
 reverse play (MIDI) 137  
 revert (automation) 87  
 revert time (automation) 95, 100, 103  
 REWIND key 32  
 ripple (audio editing) 130  
 routing 57, 68  
   analog in 63  
   effects 107, 111  
   inserts to mixer channels 61–62  
   matrix 57  
   mixer routing 58  
   panel routing 57  
   surround busses 44

---

## S

"safe" mode 168  
 safe mode (automation) 81  
 sample rate 26  
 scenes 55  
   transition time 55  
 screen appearance 182  
 scrolling 17  
 scrub wheel 13  
 scrubbing 13  
 SCSI disks 175  
   settings 180  
 SCSI interface 193  
 SEL keys 45  
 selection  
   length 18  
 sensitivity (MIDI) 143  
 settings 182  
 shelf filter 49  
 SHIFT key 12–13, 197  
 showing MIDI activity 139  
 shutdown 191  
 shuttle wheel 13  
 16-bit recording 185  
 slate key 22  
 small speakers 22  
 "smart" keys 22  
 SMF (Standard MIDI Files) 151  
 snap to grid 18  
 snapshots 53, 55  
 soft keys 15, 30  
   common 15  
 soft knobs 14, 30  
   common 15  
 solo  
   transport 24  
 solo modes 23  
 soloing 45  
 speaker modeler 117  
 speaker selection 22  
 specifications  
   audio 203  
   physical 202  
 split (audio editing) 129  
 static state (automation) 80  
 step recording (MIDI) 146–147  
 STOP key 32  
 structure of projects 176  
 studio monitoring 22  
 subwoofer 42  
 surround 41  
   5.1 41  
   buss assignments 42  
   horizontal divergence 42  
   LCRS 41  
   master fader 43  
   mixdown 43, 172  
   panning 42

# Index T - Z

- quad *41*
- routing busses *44*
- setting surround mode *185*
- vertical divergence *42*
- VGA display *42*
- swing (MIDI) *142*
- switch events (automation) *100*
- sync (video) *25*
- sync (word) *25*

---

## T

- takes (audio editing) *124*
- takes (MIDI) *150*
- talkback *198*
- talkback key *22*
- TC reverb *119–121*
- tempo (MIDI) *149*
- tempo map *18*
- threshold (compressor) *50*
- time code
  - MTC *139*
- time register *39*
- time signature *18*
- timecode *194*
  - chase *25, 33, 189*
  - chase mode *33*
  - display *25*
  - displays *40*
  - format *32*
  - frame rate *32, 189*
  - generation *33*
  - offset *32, 188*
- tool selection *17*
  - audio regions *122*
- touch/keep (automation) *86*
- track arming
  - remote *32*
- transition time (between scenes) *55*
- transport controls *31*
- transport keys *197*
- transport solo *24*
- transpose (MIDI) *144*
- trim
  - linking *70*
- trim (audio editing) *129*
- trim (automation) *87, 102*

- trim mode (automation) *81*
- 24-bit recording *185*
- 2 TR IN *21, 192*

---

## U

- undo (audio editing) *130*
- user fader banks *75–76*
- using locate points *39*

---

## V

- vertical divergence *42*
- VGA display *14, 27*
  - automation screens *88–90*
  - changing screens *27*
  - channel view *47*
  - inserts *60*
  - library management *53*
  - locate points *39*
  - surround *42*
  - tabs *17*
  - transport keys *32*
  - view menu *28*
- video
  - pull up/pull down *187*
  - sync *193*
- video sync *25, 188*
- viewing waveforms *122, 124*
- virtual channel pots *13*
- virtual channels *46*

---

## W

- waveforms, viewing *122, 124*
- word clock *25, 187*
- word sync *25, 187*
  - word clock *188*
- write mode (automation) *95*
- write status (automation) *80*
- write to end (automation) *100*

---

## Z

- zooming *17, 28*



# TASCAM

TEAC Professional Division

# SX-1

## TEAC CORPORATION

Phone: (0422) 52-5082

3-7-3, Nakacho, Musashino-shi, Tokyo 180-8550, Japan

## TEAC AMERICA, INC.

Phone: (323) 726-0303

7733 Telegraph Road, Montebello, California 90640

## TEAC CANADA LTD.

Phone: 905-890-8008 Facsimile: 905-890-9888

5939 Wallace Street, Mississauga, Ontario L4Z 1Z8, Canada

## TEAC MEXICO, S.A. De C.V

Phone: 5-851-5500

Campesinos No. 184, Colonia Granjes Esmeralda, Delegacion Iztapalapa CP 09810, Mexico DF

## TEAC UK LIMITED

Phone: 01923-819699

5 Marlin House, Croxley Business Park, Watford, Hertfordshire. WD1 8TE, U.K.

## TEAC DEUTSCHLAND GmbH

Phone: 0611-71580

Bahnstrasse 12, 65205 Wiesbaden-Erbenheim, Germany

## TEAC FRANCE S. A.

Phone: 01.42.37.01.02

17 Rue Alexis-de-Tocqueville, CE 005 92182 Antony Cedex, France

## TEAC BELGIUM NV/SA

Phone: 0031-162-510210

Oeverkruid 15, NL-4941 VV Raamsdonksveer, Netherlands

## TEAC NEDERLAND BV

Phone: 0162-510210

Oeverkruid 15, NL-4941 VV Raamsdonksveer, Netherlands

## TEAC AUSTRALIA PTY.,LTD. A.B.N. 80 005 408 462

Phone: (03) 9672-2400 Facsimile: (03)9672-2249

280 William Street, Port Melbourne, Victoria 3000, Australia

## TEAC ITALIANA S.p.A.

Phone: 02-66010500

Via C. Cantù 11, 20092 Cinisello Balsamo, Milano, Italy