



PORTATONE

PSR-OR7000

OWNER'S MANUAL

SPECIAL MESSAGE SECTION

This product utilizes batteries or an external power supply (adapter). DO NOT connect this product to any power supply or adapter other than one described in the manual, on the name plate, or specifically recommended by Yamaha.

WARNING: Do not place this product in a position where anyone could walk on, trip over, or roll anything over power or connecting cords of any kind. The use of an extension cord is not recommended! If you must use an extension cord, the minimum wire size for a 25' cord (or less) is 18 AWG. NOTE: The smaller the AWG number, the larger the current handling capacity. For longer extension cords, consult a local electrician.

This product should be used only with the components supplied or; a cart, rack, or stand that is recommended by Yamaha. If a cart, etc., is used, please observe all safety markings and instructions that accompany the accessory product.

SPECIFICATIONS SUBJECT TO CHANGE:

The information contained in this manual is believed to be correct at the time of printing. However, Yamaha reserves the right to change or modify any of the specifications without notice or obligation to update existing units.

This product, either alone or in combination with an amplifier and headphones or speaker/s, may be capable of producing sound levels that could cause permanent hearing loss. DO NOT operate for long periods of time at a high volume level or at a level that is uncomfortable. If you experience any hearing loss or ringing in the ears, you should consult an audiologist.

IMPORTANT: The louder the sound, the shorter the time period before damage occurs.

Some Yamaha products may have benches and / or accessory mounting fixtures that are either supplied with the product or as optional accessories. Some of these items are designed to be dealer assembled or installed. Please make sure that benches are stable and any optional fixtures (where applicable) are well secured BEFORE using.

Benches supplied by Yamaha are designed for seating only. No other uses are recommended.

NOTICE:

Service charges incurred due to a lack of knowledge relating to how a function or effect works (when the unit is operating as designed) are not covered by the manufacturer's warranty, and are therefore the owners responsibility. Please study this manual carefully and consult your dealer before requesting service.

ENVIRONMENTAL ISSUES:

Yamaha strives to produce products that are both user safe and environmentally friendly. We sincerely believe that our products and the production methods used to produce them, meet these goals. In keeping with both the letter and the spirit of the law, we want you to be aware of the following:

Battery Notice:

This product MAY contain a small non-rechargeable battery which (if applicable) is soldered in place. The average life span of this type of battery is approximately five years. When replacement becomes necessary, contact a qualified service representative to perform the replacement.

This product may also use "household" type batteries. Some of these may be rechargeable. Make sure that the battery being charged is a rechargeable type and that the charger is intended for the battery being charged.

When installing batteries, do not mix batteries with new, or with batteries of a different type. Batteries MUST be installed correctly. Mismatches or incorrect installation may result in overheating and battery case rupture.

Warning:

Do not attempt to disassemble, or incinerate any battery. Keep all batteries away from children. Dispose of used batteries promptly and as regulated by the laws in your area. Note: Check with any retailer of household type batteries in your area for battery disposal information.

Disposal Notice:

Should this product become damaged beyond repair, or for some reason its useful life is considered to be at an end, please observe all local, state, and federal regulations that relate to the disposal of products that contain lead, batteries, plastics, etc. If your dealer is unable to assist you, please contact Yamaha directly.

NAME PLATE LOCATION:

The name plate is located on the bottom of the product. The model number, serial number, power requirements, etc., are located on this plate. You should record the model number, serial number, and the date of purchase in the spaces provided below and retain this manual as a permanent record of your purchase.

Model

Serial No.

Purchase Date

PLEASE KEEP THIS MANUAL

PRECAUTIONS

PLEASE READ CAREFULLY BEFORE PROCEEDING

* Please keep this manual in a safe place for future reference.



WARNING

Always follow the basic precautions listed below to avoid the possibility of serious injury or even death from electrical shock, short-circuiting, damages, fire or other hazards. These precautions include, but are not limited to, the following:

Power supply/AC power adaptor

- Only use the voltage specified as correct for the instrument. The required voltage is printed on the name plate of the instrument.
- Use the specified adaptor (PA-301 or an equivalent recommended by Yamaha) only. Using the wrong adaptor can result in damage to the instrument or overheating.
- Check the electric plug periodically and remove any dirt or dust which may have accumulated on it.
- Do not place the AC adaptor cord near heat sources such as heaters or radiators, and do not excessively bend or otherwise damage the cord, place heavy objects on it, or place it in a position where anyone could walk on, trip over, or roll anything over it.

Do not open

- Do not open the instrument or attempt to disassemble the internal parts or modify them in any way. The instrument contains no user-serviceable parts. If it should appear to be malfunctioning, discontinue use immediately and have it inspected by qualified Yamaha service personnel.

Water warning

- Do not expose the instrument to rain, use it near water or in damp or wet conditions, or place containers on it containing liquids which might spill into any openings.
- Never insert or remove an electric plug with wet hands.

Fire warning

- Do not put burning items, such as candles, on the unit. A burning item may fall over and cause a fire.

If you notice any abnormality

- If the AC adaptor cord or plug becomes frayed or damaged, or if there is a sudden loss of sound during use of the instrument, or if any unusual smells or smoke should appear to be caused by it, immediately turn off the power switch, disconnect the adaptor plug from the outlet, and have the instrument inspected by qualified Yamaha service personnel.



CAUTION

Always follow the basic precautions listed below to avoid the possibility of physical injury to you or others, or damage to the instrument or other property. These precautions include, but are not limited to, the following:

Power supply/AC power adaptor

- When removing the electric plug from the instrument or an outlet, always hold the plug itself and not the cord.
- Unplug the AC power adaptor when not using the instrument, or during electrical storms.
- Do not connect the instrument to an electrical outlet using a multiple-connector. Doing so can result in lower sound quality, or possibly cause overheating in the outlet.

Location

- Do not expose the instrument to excessive dust or vibrations, or extreme cold or heat (such as in direct sunlight, near a heater, or in a car during the day) to prevent the possibility of panel disfiguration or damage to the internal components.
- Do not use the instrument in the vicinity of a TV, radio, stereo equipment, mobile phone, or other electric devices. Otherwise, the instrument, TV, or radio may generate noise.

- Do not place the instrument in an unstable position where it might accidentally fall over.
- Before moving the instrument, remove all connected adaptor and other cables.
- When setting up the product, make sure that the AC outlet you are using is easily accessible. If some trouble or malfunction occurs, immediately turn off the power switch and disconnect the plug from the outlet. Even when the power switch is turned off, electricity is still flowing to the product at the minimum level. When you are not using the product for a long time, make sure to unplug the power cord from the wall AC outlet.
- Use only the stand specified for the instrument. When attaching the stand, use the provided screws only. Failure to do so could cause damage to the internal components or result in the instrument falling over.
- Do not place objects in front of the instrument's air vent, since this may prevent adequate ventilation of the internal components, and possibly result in the instrument overheating.

Connections

- Before connecting the instrument to other electronic components, turn off the power for all components. Before turning the power on or off for all components, set all volume levels to minimum. Also, be sure to set the volumes of all components at their minimum levels and gradually raise the volume controls while playing the instrument to set the desired listening level.

Maintenance

- When cleaning the instrument, use a soft, dry cloth. Do not use paint thinners, solvents, cleaning fluids, or chemical-impregnated wiping cloths.

Handling caution

- Do not insert a finger or hand in any gaps on the instrument.
- Never insert or drop paper, metallic, or other objects into the gaps on the panel or keyboard. If this happens, turn off the power immediately and unplug the power cord from the AC outlet. Then have the instrument inspected by qualified Yamaha service personnel.
- Do not place vinyl, plastic or rubber objects on the instrument, since this might discolor the panel or keyboard.
- Do not rest your weight on, or place heavy objects on the instrument, and do not use excessive force on the buttons, switches or connectors.
- Do not use the instrument/device or headphones for a long period of time at a high or uncomfortable volume level, since this can cause permanent hearing loss. If you experience any hearing loss or ringing in the ears, consult a physician.

Saving data

Saving and backing up your data

- The data of the types listed below are lost when you turn off the power to the instrument. Save the data to the USER tab display (page 27), or USB storage device (USB flash memory/floppy disk, etc).
 - Recorded/Edited Songs (page 43, 143, 158)
 - Created/Edited Styles (page 114)
 - Edited Voices (page 92)
 - Memorized One Touch Settings (page 51)
 - Edited MIDI settings (page 177)
 - Scale tune settings (page 99)

Moreover, the above-mentioned data can be saved all at once. Refer to page 75. Data in the USER tab display (page 27) may be lost due to malfunction or incorrect operation. Save important data to a USB storage device (USB flash memory/floppy disk, etc).

When you change settings in a display page and then exit from that page, System Setup data (listed in the Parameter Chart of the Data List downloadable from the web) is automatically stored. However, this edited data is lost if you turn off the power without properly exiting from the relevant display. Refer to page 5 for how to obtain the Data List.

Yamaha cannot be held responsible for damage caused by improper use or modifications to the instrument, or data that is lost or destroyed.

Always turn the power off when the instrument is not in use.

Even when the power switch is in the "STANDBY" position, electricity is still flowing to the instrument at the minimum level. When you are not using the instrument for a long time, make sure you unplug the AC power adaptor from the wall AC outlet.

Thank you for purchasing this Yamaha PORTATONE!
We recommend that you read this manual carefully so that you can fully take advantage of the advanced and convenient functions of the instrument.
We also recommend that you keep this manual in a safe and handy place for future reference.

About this Owner's Manual and Data List

This manual consists of the following sections.

Owner's Manual

- Introduction (page 12)..... Please read this section first.
Quick Guide (page 24)..... This section explains how to use the basic functions.
Basic Operation (page 60)..... This section explains how to use the basic operations including display-based controls.
Reference (page 77) This section explains how to make detailed settings for the various functions.
Appendix (page 183)..... This section contains additional information such as Troubleshooting and Specifications.

Data List

The Data List contains various important preset content lists such as Voices, Styles, Effects, as well as MIDI-related information. The Data List is available for downloading from the Yamaha Manual Library.

Yamaha Manual Library
<http://www.yamaha.co.jp/manual/>

- The illustrations and LCD screens as shown in this owner's manual are for instructional purposes only, and may appear somewhat different from those on your instrument.
- The example Operation Guide displays shown in this Manual are in English.
- Copying of the commercially available musical data including but not limited to MIDI data and/or audio data is strictly prohibited except for your personal use.
- This device is capable of using various types/formats of music data by optimizing them to the proper format music data for use with the device in advance. As a result, this device may not play them back precisely as their producers or composers originally intended.
- Some of the preset songs have been edited for length or arrangement, and may not be exactly the same as the original.

This product incorporates and bundles computer programs and contents in which Yamaha owns copyrights or with respect to which it has license to use others' copyrights. Such copyrighted materials include, without limitation, all computer software, style files, MIDI files, WAVE data, musical scores and sound recordings. Any unauthorized use of such programs and contents outside of personal use is not permitted under relevant laws. Any violation of copyright has legal consequences. DON'T MAKE, DISTRIBUTE OR USE ILLEGAL COPIES.

- The mandolin and pan flute, shown in the displays of the PSR-OR700, are on display at the Hamamatsu Museum of Musical Instruments.
- The bitmap fonts used in this instrument have been provided by and are the property of Ricoh Co., Ltd.
- This product utilizes NF, an embedded Internet browser from ACCESS Co., Ltd. NF is used with the patented LZW, licensed from Unisys Co., Ltd. NF may not be separated from this product, nor may it be sold, lent or transferred in any way. Also, NF may not be reverse-engineered, reverse-compiled, reverse-assembled or copied. This software includes a module developed by the Independent JPEG Group.
- All other trademarks are the property of their respective holders.

ACCESS

Accessories

- Guide to Yamaha Online Member Product User Registration**
- Accessory CD-ROM for Windows**
- Owner's Manual**
- Accessory CD-ROM for Windows Installation Guide**
- Music rest**
- AC Power Adaptor
PA-301 or an equivalent***

* May not be included depending on your particular area. Please check with your Yamaha dealer.

The followings are the titles, credits and copyright notices for two (2) of the songs pre-installed in this instrument:

Beauty And The Beast

from Walt Disney's BEAUTY AND THE BEAST

Lyrics by Howard Ashman

Music by Alan Menken

© 1991 Walt Disney Music Company and Wonderland Music Company, Inc.

All Rights Reserved Used by Permission

Hey Jude

Words and Music by John Lennon and Paul McCartney

Copyright © 1968 Sony/ATV Songs LLC

Copyright Renewed

All Rights Administered by Sony/ATV Music Publishing, 8 Music Square West, Nashville, TN 37203

International Copyright Secured All Rights Reserved

Table of Contents

Introduction

What can you do with the PORTATONE?	12
Panel Controls	14
Playing the Keyboard	16
Power Supply	16
Powering Up	17
Setting Up	18
Music Rest	18
Using Headphones	18
Changing the Display Language	19
Display Settings	19
Handling the Floppy Disk Drive (FDD) and Floppy Disks	22
Handling the USB Storage Device (USB Flash Memory/Floppy Disk, etc)	23

Quick Guide

Playing the Demos	24
Operations in Basic Displays	26
Operation of the Main Display	26
Operation of the File Selection Display	27
Operation of the Function Display	28
Playing Voices	30
Playing Preset Voices	30
Practicing with the Preset Songs	36
Playing Back and Listening to Songs Before Practicing	36
Displaying Music Notation (Score)	39
Muting the Right- or Left-hand Part Viewing the Score	40
Practicing with the Repeat Playback Function	42
Recording Your Performance	43
Playing Backing Parts with the performance assistant Technology	44
Playing Accompaniment with the Auto Accompaniment Feature (Style Playback)	46
Playing “Mary Had a Little Lamb” with the Auto Accompaniment Feature	46
The Multi Pads	52
Playing the Multi Pads	52
Using Chord Match	53
Voice Effects	53
Applying Harmony to Your Right-hand Melody (HARMONY/ECHO)	54
Calling Up Ideal Setups for Each Song (Music Finder)	55
Calling up the panel settings to match the Style (Repertoire)	56
Singing Along with Song Playback (Karaoke) or Your Own Performance	57
Singing with the Lyrics Display	57
Convenient Functions for Karaoke	58

Convenient Functions for Singing Along with Your Own Performance	58
Setting an Oriental Scale	59

Basic Operation

Selecting Message Language	60
The Messages Shown in the Display	60
Instant Selection of the Displays — Direct Access	61
Basic Displays (Main Display and File Selection Display)	62
Main Display	62
File Selection Display Configuration and Basic Operation	63
File/Folder Operations in the File Selection Display	66
Restoring the Factory-programmed Settings ...	72
Restoring the Factory-programmed System	72
Restoring the Factory-programmed Settings Independently by Item	72
Saving and Recalling Your Original Settings as a Single File	74
Data Backup	75
Backup procedure	75

Reference

Using, Creating and Editing Voices ..	77
Voice Characteristics	77
Playing Different Voices Simultaneously	78
Keyboard Parts (Right 1, Right 2, Left)	78
Playing Two Voices Simultaneously (Right 1 and 2 Parts)	79
Playing Different Voices with the Left and Right Hands (Right 1 and Left Parts)	80
Changing Pitch	81
Transpose	81
Fine-tuning the Pitch of the Entire Instrument	81
Selecting the Harmony/Echo type	82
Editing the Volume and Tonal Balance (MIXING CONSOLE)	84
Basic Procedure	84
Voice Creating — Voice Set	92
Basic Procedure	92
Creating Your Original Organ Flutes Voices	96
Using Oriental Scales — Scale Setting/Scale Tuning/Scale Memory	99
Setting an Oriental Scale — Scale Setting	99
Scale Tuning	99
Memorizing the Scale Setting — Scale Memory	101

Saving Your Scale Settings	101
Recalling the Scale Setting	102

Using, Creating and Editing the Auto Accompaniment Styles 103

Style Characteristics	103
Selecting a Chord Fingering Type	103
Playing Only the Rhythm Channels of a Style	104
Style Playback-related Settings	106
Split Point Settings	107
Editing the Volume and Tonal Balance of the Style (MIXING CONSOLE)	108
Convenient Music Finder feature	108
Searching the Records	108
Creating a Set of Favorite Records	110
Editing Records	111
Saving the Record	112
Style Creator	114
Style Structure	114
Creating a Style	114
Editing the Created Style	120

The Multi Pads 128

Multi Pad Creating (Multi Pad Creator)	128
Multi Pad Realtime Recording	128
Multi Pad Step Recording (EDIT)	129
Multi Pad Editing (Multi Pad Creator)	130

Registering and Recalling Custom Panel Setups — Registration Memory 131

Registering and Saving Custom Panel Setups	131
Recalling the Registered Panel Setups	132
Deleting an Unneeded Panel Setup/Naming a Panel Setup	133
Disabling Recall of Specific Items (Freeze Function)	134
Calling Up Registration Memory Numbers in Order — Registration Sequence	134

Using, Creating and Editing Songs 136

Compatible Song Types	136
Operations for Song Playback	137
Adjusting the Volume Balance and Voice Combination, etc. (MIXING CONSOLE)	140
Practicing Songs with the Guide Functions ..	141
Selecting the Guide Function Type	141
Recording Your Performance to MIDI	143
Recording Methods	143
Editing a Recorded Song	158

Using Your Instrument with Other Devices 167

Connecting Audio Devices	167
Using External Audio Devices for Playback (1 [OUTPUT] jacks)	167
Playing External Audio Devices with the Built-in Speakers (2 [AUX IN] jacks)	167
Using the Footswitch or Foot Controller (3 [FOOT PEDAL 1/2] jacks)	168
Assigning Specific Functions to Each Foot Pedal ..	168
Connecting External MIDI Devices (4 [MIDI] terminals)	171
Connecting to a computer and USB device ...	171
Connecting a Computer (4 [MIDI] and 5 [USB TO HOST] terminals)	171
Connecting to a USB Storage Device (6 via the [USB TO DEVICE] terminal)	172

What is MIDI? 174

MIDI Settings	177
Basic Operation	177
Pre-Programmed MIDI Templates	179
MIDI System Settings	180
MIDI Transmit Settings	180
MIDI Receive Settings	181
Setting the Bass Note for Style Playback via MIDI Receive	182
Setting the Chord Type for Style Playback via MIDI Receive	182

Appendix

Troubleshooting	183
Specifications	187
Index	189
Panel Button Chart	192

Introduction

Quick Guide

Basic Operation

Reference

Using, Creating and Editing Voices

Using Oriental Scales

Using, Creating and Editing the Auto
Accompaniment Styles

The Multi Pads

Registering and Recalling Custom Panel Setups

Using, Creating and Editing Songs

Using Your Instrument with Other
Devices

Appendix

Starting up before turning the power on

- Setting up the music rest..... page 18
- Connecting headphones..... page 18
- Turning the power on/off page 17

Listening to the PSR-OR700

- Playing the Demos page 24
- Playing songs..... page 36
 - Playing a Preset Song page 36
 - Turning parts (channels) of the Song on/off..... page 142
 - Adjusting the balance between the Song and keyboard..... page 140
- Playing Styles page 103
 - Playing Preset Styles..... page 46
 - Turning parts (channels) of the Style on/off page 105
 - Adjusting the balance between the Style and keyboard..... page 108
- Playing the Multi Pads page 52

Playing the Keyboard

- Selecting a Voice (RIGHT1) and playing the keyboard page 78
- Playing two or three Voices simultaneously page 79
- Playing different Voices with the left and right hands page 80
- Playing the drum/percussion Voices..... page 77
- MegaVoices..... page 77
- Setting the touch sensitivity of the keyboard page 33
- Turning Initial Touch on or off for each keyboard part (RIGHT1, 2, LEFT)..... page 53
- Setting the Modulation wheel for each keyboard part (RIGHT 1, 2, LEFT)..... page 34

Practicing the keyboard performance

- Using the Metronome..... page 34
- Displaying and playing along with the music notation of the song during playback..... page 39

Selecting the programs of the PSR-OR700

- Voices page 77
- Styles..... page 103
- Multi Pad banks..... page 128
- Songs page 136
- Music Finder records..... pages 55, 108
- Registration Memory bank..... page 134
- Registration Memory number page 134
- One Touch Setting numbers..... page 51
- Harmony/Echo types page 82
- MIDI templates..... page 179
- Effect types page 88
- Master EQ types page 90

Using the LCD display

- Understanding and using the Main display page 26
- Viewing the Song Lyrics on the LCD display page 57
- Viewing the Song Score on the LCD display page 39

Playing Style chords with your left hand and melodies with your right

- Learning how to play specific chord types..... Chord Tutor page 50
- Learning how to play (indicate) chords for Style playback..... Chord Fingering..... page 50
- Applying automatic harmony or echo to your right-hand melodies..... Harmony/Echo page 82
- Automatically changing the chords of the Multi Pads with your left-hand play..... Chord Match page 53

Instantly selecting custom panel settings

- Calling up ideal panel setups.....Music Finder pages 55, 108
- Changing setups to match the StyleOne Touch Setting page 51
- Saving and recalling custom panel setups.....Registration Memory page 131

Creating Voices, Styles, Songs, and more

- Creating your original Voices.....Voice Set page 92
- Creating your original Organ Flutes VoicesVoice Set page 96
- Creating your original Styles.....Style Creator..... page 114
- Creating your original Songs..... page 43
 - MIDI recording of your keyboard performance pages 43, 143
 - Inputting notes one by one.....Song Creator page 149
 - Inputting and editingSong Creator page 158
- Creating your original Multi Pads.....Multi Pad Creator page 128
- Creating a Registration Memory bank page 134
- Creating new Music Finder records page 110
- Creating new Effect types page 88
- Creating custom Master EQ settings..... page 90

Using Oriental Scales

- Setting an Oriental Scale — Scale Setting..... page 99
- Adjusting the Scale Tuning — Scale Tuning..... page 99
- Memorizing the Scale Setting — Scale Memory page 101
- Saving Your Scale Settings..... page 101
- Recalling the Scale Setting..... page 102

Controlling and adjusting the pitch

- Adjusting the overall pitch of the PSR-OR700.....Master Tune page 81
- Adjusting the octave of the keyboard..... page 86
- Transposing notes (Master Transpose, Keyboard Transpose, Song Transpose) page 58
- Setting [TRANSPPOSE] button to independently control separate parts page 86
- Using the PITCH BEND wheel page 33
- Using the MODULATION wheel..... page 34

Live performance tips and techniques

- Assigning specific panel operations/functions for foot control..... page 168
- Calling up Registration Memory numbers in custom-set orderRegistration Sequence page 134
- Using a foot pedal to change Registration Memory numbers page 168
- Using the Fade In/Out pages 48, 49

Group performance tips and techniques

- Independently transposing the Song and keyboard pitch to match your singing range page 58
- Tuning the overall sound of the PSR-OR700 to match other instruments..... page 81
- Synchronizing the PSR-OR700 to other MIDI instruments page 180

Other Tips

- Registering your name to the PSR-OR700..... page 21
- Importing custom icons for Voice/Style/Song indications in the Selection display page 70
- Displaying the bank select and program numbers in the Voice Selection display page 182

What can you do with the PORTATONE?

DEMO

Explore the Demos (page 24)

These not only showcase the stunning voices and styles of the instrument, they introduce you to the various functions and features — and give you hands-on experience using the PSR-OR700!

SONG

Playback previously recorded songs (page 36, 57, 137)

Enjoy a wide variety of preset songs as well as songs on commercially available disks.

LCD

The large LCD (together with the various panel buttons) provides comprehensive and easy-to-understand control of the instrument's operations. The lyrics, music scores can also be displayed in the LCD.

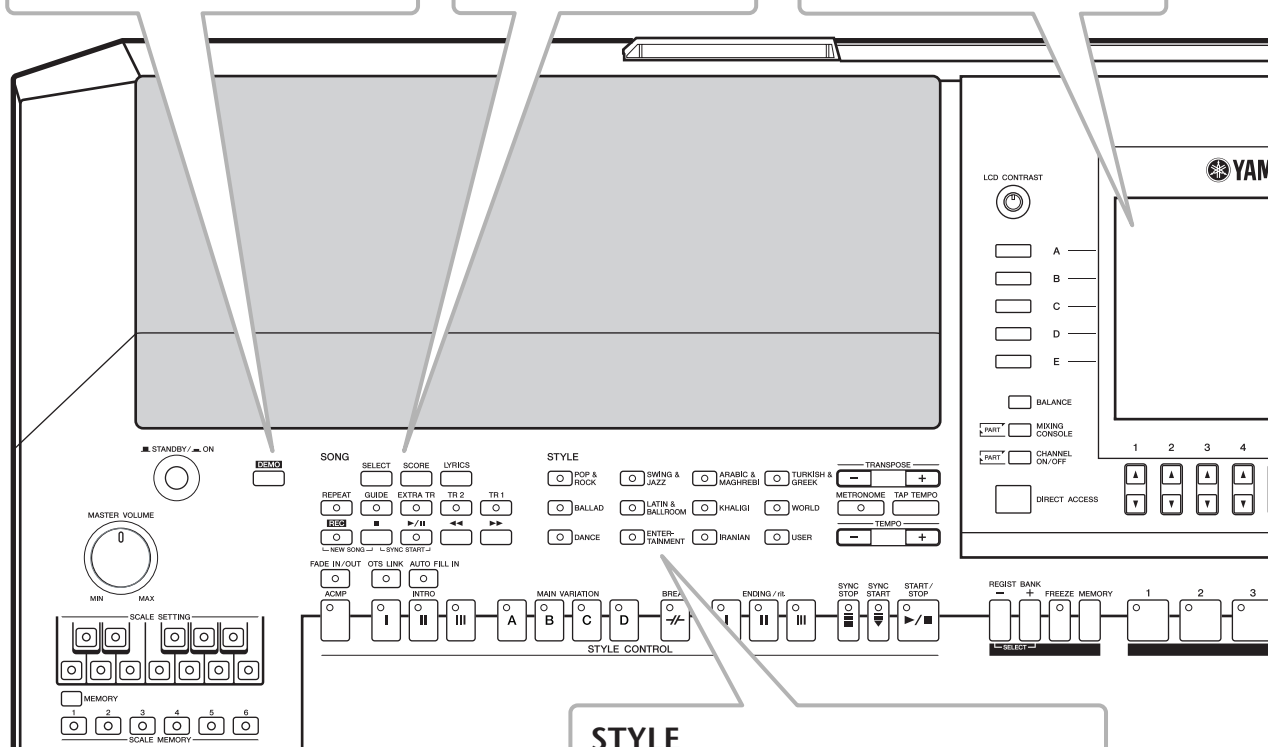

SCALE SETTING/SCALE MEMORY

Using oriental scales (page 99)

The Scale Setting feature lets you easily lower the pitches of specific notes by 50 cents to create your own oriental scales. Up to six scale settings can be stored for instant recall (Scale Memory), whenever you need them.

STYLE

Back up your performance with Auto Accompaniment (page 46, 103)

Playing a chord with your left hand automatically plays the auto accompaniment backing. Select an accompaniment style — such as pop, jazz, Latin, etc. — and let the PORTATONE be your backing band!

DIGITAL RECORDING

Record your performances (page 43, 143)

With the powerful and easy-to-use song recording features, you can record your own keyboard performances, and create your own complete, fully orchestrated compositions — which you can then save to the USER drive or a USB storage device for future recall. And since the recorded data is MIDI, you can easily edit your songs, too.

MUSIC FINDER
Call up the perfect accompaniment style (page 55, 108)
 If you know what song you want to play, but you don't know which style or voice would be right for it, let the Music Finder help you. Just select the song title, and the instrument automatically calls up the most appropriate style and voice.

VOICE
Enjoy a huge variety of realistic voices (page 30, 77)
 The PSR-OR700 features a wealth of exceptionally authentic and dynamic voices — including piano, strings, woodwinds, and more! The instrument also has MegaVoices. MegaVoices feature different performance sounds of the same instrument in different velocity ranges — designed specifically for recorded MIDI data.

Organ Flutes
Craft your own organ voices (page 96)
 This special function not only gives you a full set of rich and luscious organ sounds, it also lets you create your own original organ voices, just as on a traditional organ, by increasing and decreasing the flute footages, and adding percussive sounds.

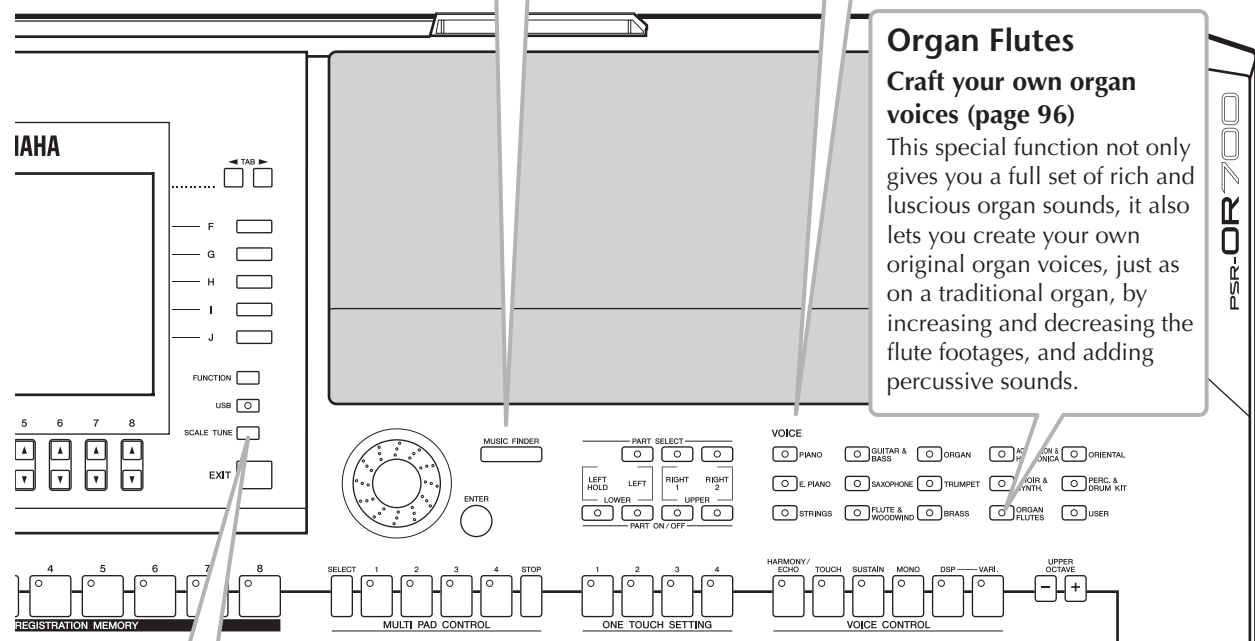

SCALE TUNE
Create your own scales (page 99)
 You can select a desired scale template including oriental scales and create your own scales by fine tuning the scale notes.

USB TO DEVICE terminal
Connect the instrument to the USB storage device (page 172)
 Connecting the USB storage device (such as USB flash memory and hard disk drive) to this terminal lets you save various types of data created on the instrument.

USB TO HOST terminal
Make music with a computer — quickly and easily (page 171)
 Dive in and take advantage of the wide world of computer music software. Connections and setup are exceptionally easy, and you can play back your computer recorded parts with different instrument sounds — all from a single instrument!

Multi Pads
Add spice to your performance with special dynamic phrases (page 52, 128)
 By simply pressing one of the Multi Pads, you can play short rhythmic or melodic phrases. You can also create your original Multi Pad phrases by recording them directly from the keyboard.

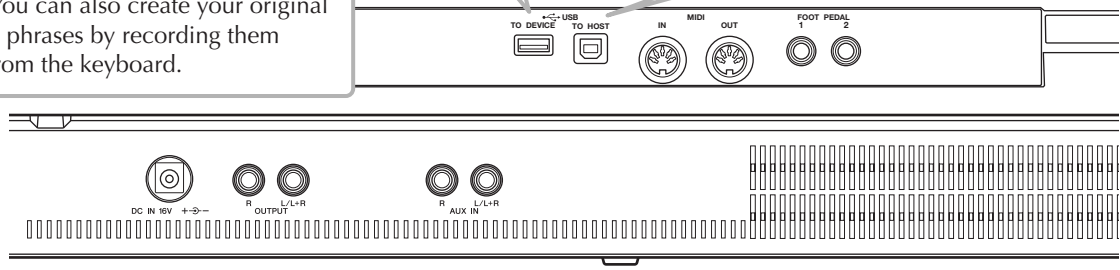

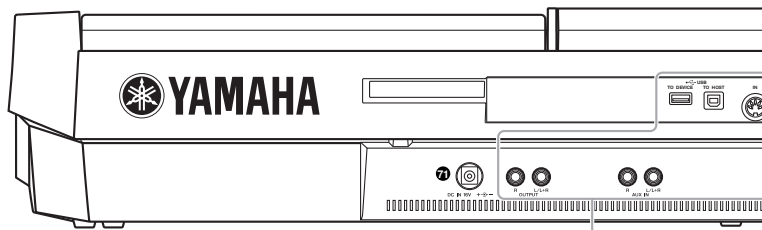

See page 167

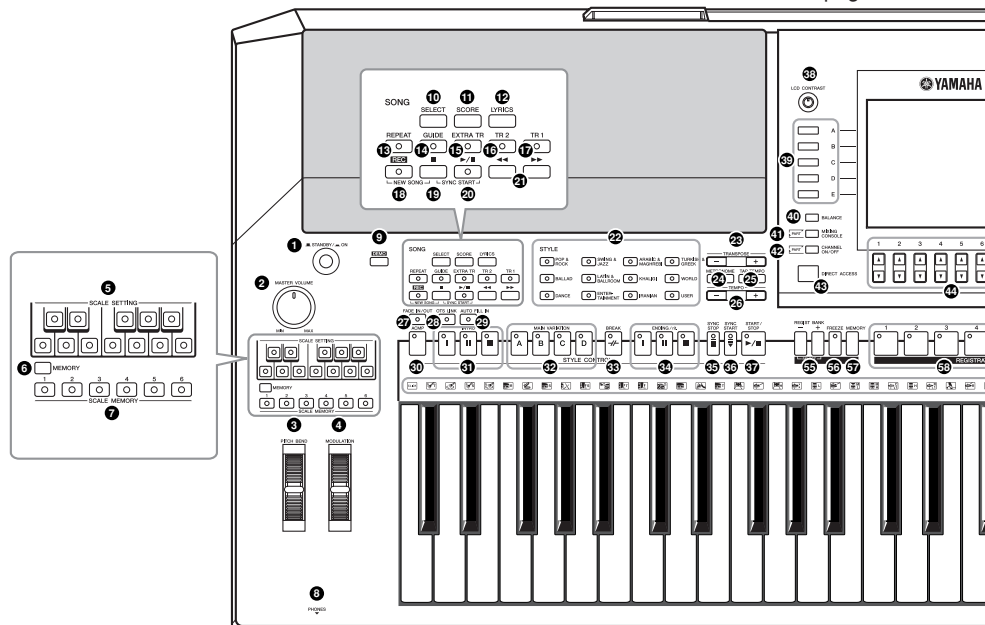

STANDBY/ON

- ① [STANDBY/ON] switch P. 17

VOLUME

- ② [MASTER VOLUME] dial P. 17

WHEEL

- ③ [PITCH BEND] wheel P. 33
- ④ [MODULATION] wheel P. 34

SCALE SETTING

- ⑤ [SCALE SETTING] buttons P. 59

SCALE MEMORY

- ⑥ [MEMORY] button P. 59
- ⑦ [SCALE MEMORY] buttons P. 59

PHONES

- ⑧ [PHONES] P. 18

DEMO

- ⑨ [DEMO] button P. 24

SONG

- ⑩ [SELECT] button P. 36
- ⑪ [SCORE] button P. 39
- ⑫ [LYRICS] button P. 57
- ⑬ [REPEAT] button P. 42
- ⑭ [GUIDE] button P. 40
- ⑮ [EXTRA TR] button P. 143
- ⑯ [TR 2] button P. 42
- ⑰ [TR 1] button P. 40
- ⑱ [REC] button P. 43

- ⑲ [■] (STOP) button P. 37
- ⑳ [▶ / ||] (PLAY/PAUSE) button P. 36
- ㉑ [◀◀]/[▶▶] (REW/FF) buttons P. 138

STYLE

- ㉒ STYLE buttons P. 46

TRANSPOSE

- ㉓ [-] [+] buttons P. 58

METRONOME

- ㉔ [METRONOME] button P. 34

TAP TEMPO

- ㉕ [TAP TEMPO] button P. 48

TEMPO

- ㉖ [-] [+] buttons P. 34

FADE IN/OUT

- ㉗ [FADE IN/OUT] button P. 48

STYLE CONTROL

- ㉘ [OTS LINK] button P. 51
- ㉙ [AUTO FILL IN] button P. 49
- ㉚ [ACMP] button P. 47
- ㉛ INTRO [I]/[II]/[III] buttons P. 48
- ㉜ MAIN VARIATION [A]/[B]/[C]/[D] buttons P. 49
- ㉝ [BREAK] button P. 49
- ㉞ ENDING/rit. [I]/[II]/[III] buttons P. 49
- ㉟ [SYNC STOP] button P. 49
- ㊱ [SYNC START] button P. 48
- ㊲ [START/STOP] button P. 48

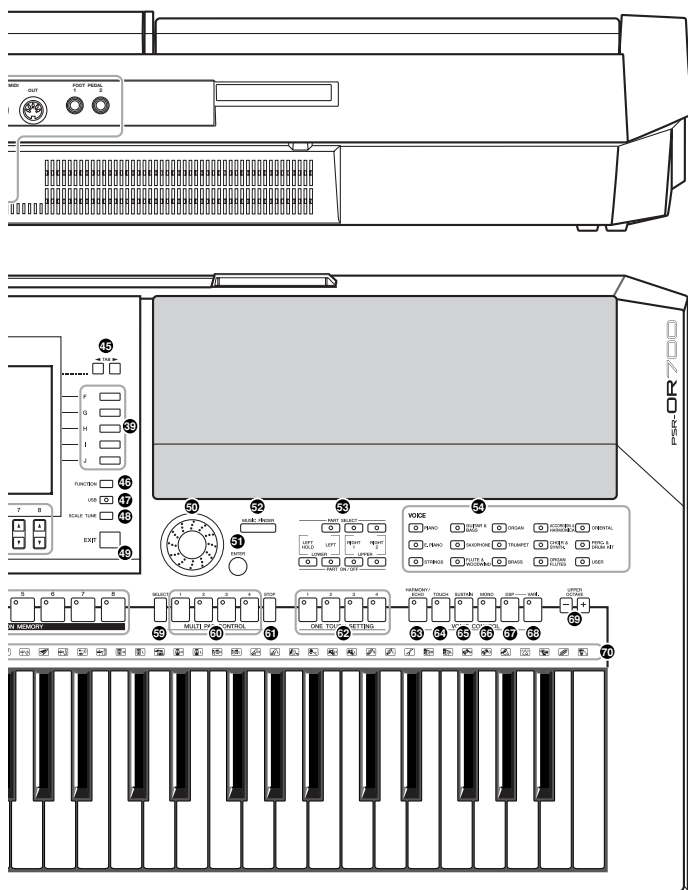

38	[LCD CONTRAST] knob	P. 19
39	[A]–[J] buttons.....	P. 26
40	[BALANCE] button	P. 41
41	[MIXING CONSOLE] button	P. 84
42	[CHANNEL ON/OFF] button	P. 105, 142
43	[DIRECT ACCESS] button	P. 61
44	[1 ▲ ▼]–[8 ▲ ▼] buttons	P. 26
45	TAB [◀] [▶] buttons.....	P. 27
46	[FUNCTION] button	P. 28
47	[USB] button.....	P. 65
48	[SCALE TUNE] button	P. 99
49	[EXIT] button.....	P. 27
50	DATA ENTRY dial	P. 65
51	[ENTER] button	P. 65

MUSIC FINDER

52	[MUSIC FINDER] button	P. 55
----	-----------------------------	-------

PART

53	[PART SELECT], [PART ON/OFF] buttons	P. 78
----	--	-------

VOICE

54	VOICE buttons	P. 30
----	---------------------	-------

REGISTRATION MEMORY

55	REGIST BANK [–]/[+] buttons.....	P. 132
56	[FREEZE] button.....	P. 134
57	[MEMORY] button	P. 131
58	[1]–[8] buttons.....	P. 131

MULTI PAD CONTROL

59	[SELECT] button	P. 130
60	[1]–[4] buttons	P. 130
61	[STOP] button	P. 128

ONE TOUCH SETTING

62	[1]–[4] buttons	P. 51
----	-----------------------	-------

VOICE CONTROL

63	[HARMONY/ECHO] button	P. 53, 82
64	[TOUCH] button.....	P. 53
65	[SUSTAIN] button.....	P. 53
66	[MONO] button.....	P. 53
67	[DSP] button	P. 53
68	[VARI.] button	P. 53

UPPER OCTAVE

69	UPPER OCTAVE [–]/[+] buttons.....	P. 62
70	Drum Kit icons.....	Data List (See page 5)

REAR PANEL

71	DC IN (terminal)	P. 16
----	------------------------	-------

- For quick reference, also see the alphabetically sorted “Panel Button Chart” on page 192.
- For information on the jacks and connectors located on the rear panel, see page 167.

⚠ WARNING

- Use the specified adaptor (PA-301/PA-300B/PA-300 or an equivalent recommended by Yamaha) only.
- The use of an incompatible adaptor may cause irreparable damage to the PSR-OR700, and may even pose a serious shock hazard! ALWAYS UNPLUG THE AC ADAPTOR FROM THE AC POWER OUTLET WHEN THE PSR-OR700 IS NOT IN USE.

⚠ CAUTION

Never interrupt the power supply (e.g. unplug the AC adaptor) during any PSR-OR700 record operation! Doing so can result in a loss of data.

⚠ CAUTION

Even when the switch is in the "STANDBY" position, electricity is still flowing to the instrument at a minimum level. When not using the PSR-OR700 for an extended period of time, be sure to unplug the AC power adaptor from the wall AC outlet.

Power Supply

1 Make sure that the instrument's STANDBY/ON switch is set to STANDBY (off).

2 Connect one end of the AC cable to the power adaptor.



3 Connect the power adaptor's DC plug to the instrument's DC IN terminal on the rear panel.

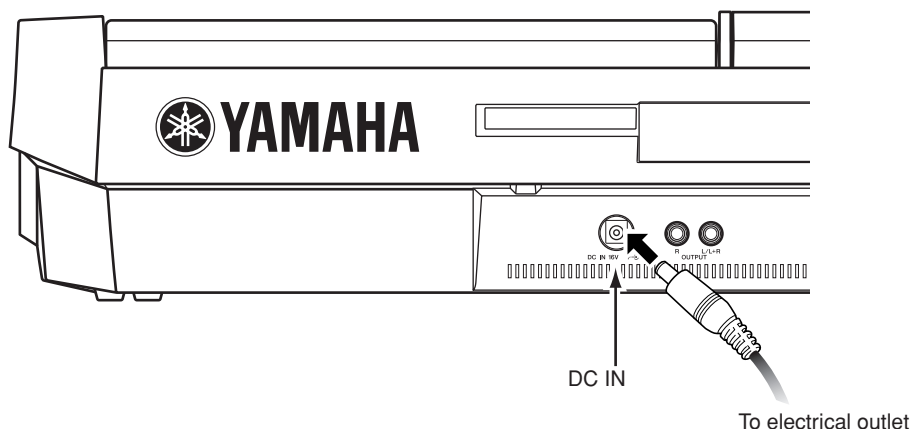

4 Connect the other end (normal AC plug) to the nearest electrical outlet.

Powering Up

NOTE

Before you switch your PSR-OR700 on or off, first turn down the volume of any connected audio equipment.

- 1 Press the [STANDBY/ON] switch.
The Main display appears in the display.

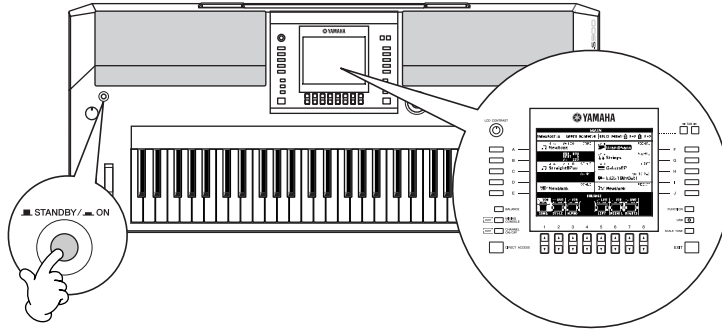

When you're ready to turn off the power, press the [STANDBY/ON] switch again.

- 2 **Setting the volume**
Use the [MASTER VOLUME] dial to adjust the volume to an appropriate level.

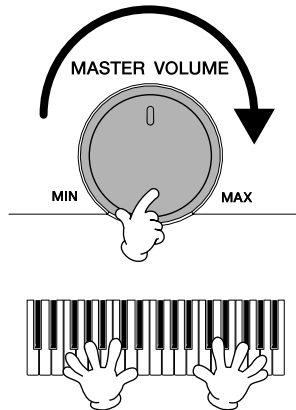

Air Vents

CAUTION

This instrument has special air vents in the top panel (see below) and rear panel. Do not place objects where they might block the air vent, since this may prevent adequate ventilation of the internal components, and possibly result in the instrument overheating.

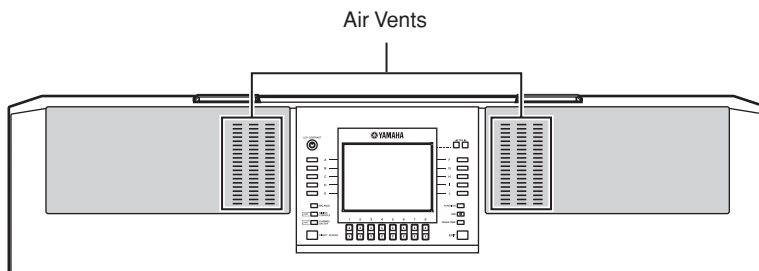

CAUTION

In order to avoid possible damage to the speakers or other connected electronic equipment, always switch on the power of the PSR-OR700 before switching on the power of the amplified speakers or mixer and amplifier. Likewise, always switch off the power of the PSR-OR700 after switching off the power of the amplified speakers or mixer and amplifier.

Music Rest

The PSR-OR700 is supplied with a music rest that can be attached to the instrument by inserting it into the slot at the rear of the control panel.

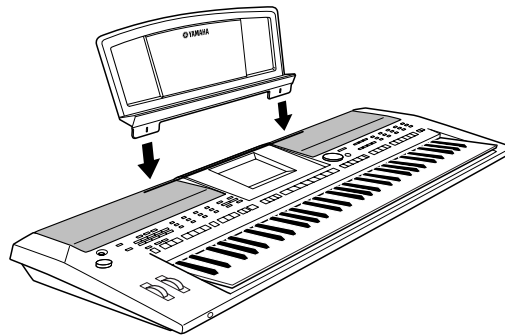

Using Headphones

Connect a pair of headphones to the [PHONES] jack. The internal stereo speaker system is automatically shut off when a pair of head phones is plugged into the [PHONES] jack.

⚠ CAUTION

Do not listen with the headphones at high volume for long periods of time. Doing so may cause hearing loss.

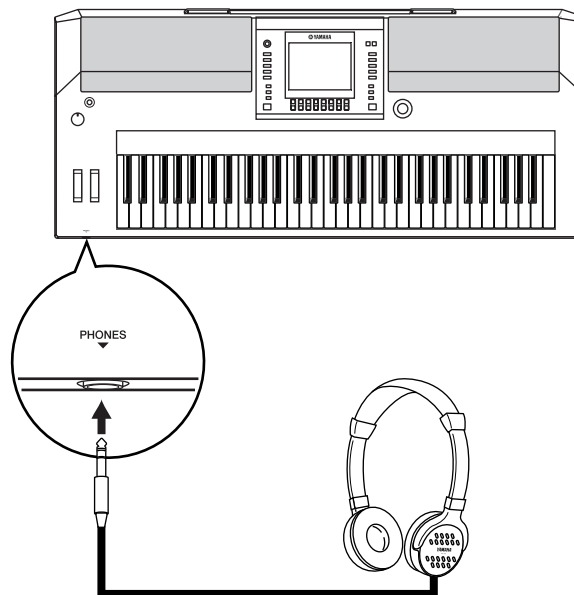

Changing the Display Language

This determines the language used in the display for messages, file names, and character input.

- 1 Call up the operation display.
[FUNCTION] → [] UTILITY → TAB[◀][▶] OWNER
- 2 Press the [4▲▼]/[5▲▼] button to select a language.

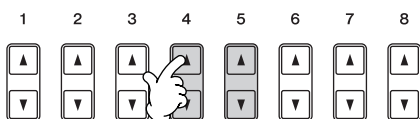
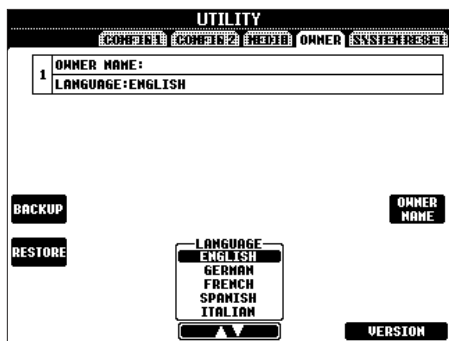

Display Settings

Adjusting the Contrast of the Display

You can adjust the contrast of the display by turning the [LCD CONTRAST] knob located to the left of the display.

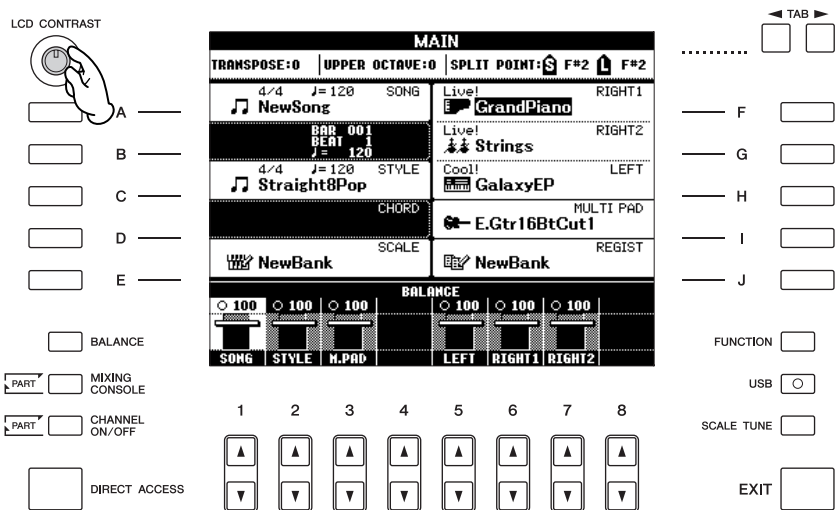

Adjusting the Brightness of the Display

Adjust the brightness of the display.

- 1 Call up the operation display.
[FUNCTION] → [J] UTILITY → TAB[◀][▶] CONFIG 2
- 2 Press the [2▲▼] button to adjust the brightness of the display.

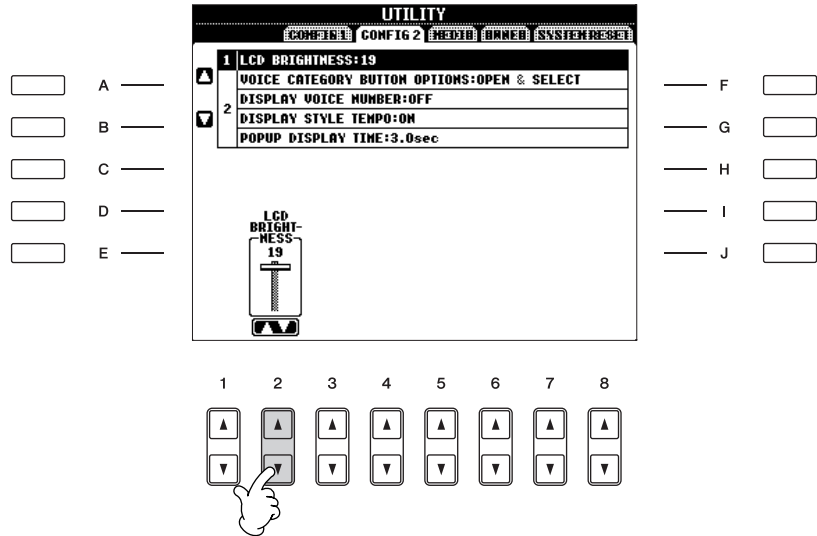

Entering the Owner Name in the Opening Display

You can have your name appear in the opening display (the display that appears when the power is turned on).



- 1 Call up the operation display.
[FUNCTION] → [I] UTILITY → TAB[◀][▶] OWNER
- 2 Press the [I] (OWNER NAME) button and call up the Owner Name display.
Refer to page 71 for character-entry details.

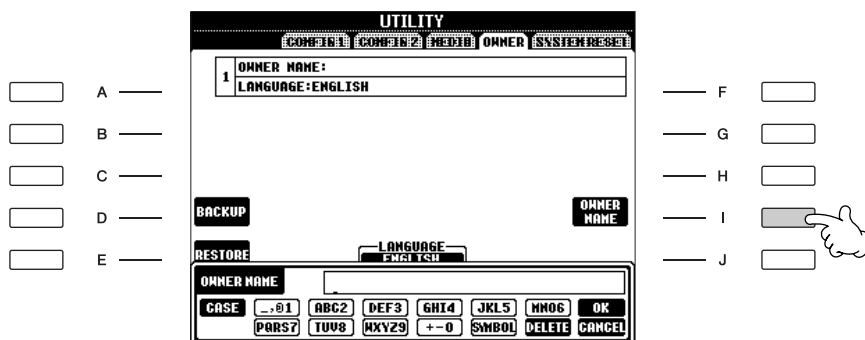

Displaying the version number

To check the version number of this instrument, press the [7 ▲ ▼]/ [8 ▲ ▼] (VERSION) buttons in the display in step 1 above. Press the [EXIT] or [8 ▲ ▼] button to return to the original display.

An optional floppy disk drive UD-FD01 can be connected to this instrument. It lets you save original data you've created on the instrument to floppy disk, and allows you to load data from floppy disk to the instrument. Be sure to handle floppy disks and treat the disk drive with care. Follow the important precautions below.

Floppy Disk Compatibility

- 3.5" 2DD and 2HD type floppy disks can be used.

Formatting a Floppy Disk

- If you find that you are unable to use new, blank disks or old disks that have been used with other devices, you may need to format them. For details on how to format a disk, see page 66. Keep in mind that all data on the disk will be lost after formatting. Make sure to check beforehand whether or not the disk contains important data.

NOTE

Floppy disks formatted on this device may or may not be usable as is on other devices.

Inserting/Removing Floppy Disks

Inserting a Floppy Disk into the Disk Drive:

- Hold the disk so that the label of the disk is facing upward and the sliding shutter is facing forward, towards the disk slot. Carefully insert the disk into the slot, slowly pushing it all the way in until it clicks into place and the eject button pops out.

NOTE

Never insert anything but floppy disks into the disk drive. Other objects may cause damage to the disk drive or floppy disks.

Removing a Floppy Disk

- After checking that the instrument is not accessing* the floppy disk (checking that the use lamp on the floppy disk drive is off), firmly press the eject button at the upper right of the disk slot all the way in. When the floppy disk is ejected, pull it out of the drive. If the floppy disk cannot be removed because it is stuck, do not try to force it, but instead try pressing the eject button again, or try re-inserting the disk and attempt to eject it again.

* Access of the disk indicates an active operation, such as recording, playback, or deletion of data.

If a floppy disk is inserted while the power is on, the disk is automatically accessed, since the instrument checks whether the disk has data.

CAUTION

Do not remove the floppy disk or turn off the instrument itself while the disk is being accessed.

Doing so may result not only in loss of data on the disk but also damage to the floppy disk drive.

- Be sure to remove the floppy disk from the disk drive before turning off the power. A floppy disk left in the drive for extended periods can easily pick up dust and dirt that can cause data-read and -write errors.

Cleaning the Disk Drive Read/Write Head

- Clean the read/write head regularly. This instrument employs a precision magnetic read/write head which, after an extended period of use, will pick up a layer of magnetic particles from the disks used that will eventually cause read and write errors.
- To maintain the disk drive in optimum working order Yamaha recommends that you use a commercially-available dry-type head cleaning disk to clean the head about once a month. Ask your Yamaha dealer about the availability of proper headcleaning disks.

About Floppy Disks

Handle floppy disks with care, and follow these precautions:

- Do not place heavy objects on a disk or bend or apply pressure to the disk in any way. Always keep floppy disks in their protective cases when they are not in use.
- Do not expose the disk to direct sunlight, extremely high or low temperatures, or excessive humidity, dust or liquids.
- Do not open the sliding shutter and touch the exposed surface of the floppy disk inside.
- Do not expose the disk to magnetic fields, such as those produced by televisions, speakers, motors, etc., since magnetic fields can partially or completely erase data on the disk, rendering it unreadable.
- Never use a floppy disk with a deformed shutter or housing.
- Do not attach anything other than the provided labels to a floppy disk. Also make sure that labels are attached in the proper location.

To Protect Your Data (Write-protect Tab):

- To prevent accidental erasure of important data, slide the disk's write-protect tab to the "protect" position (tab open). When saving data, make sure that the disk's write-protect tab is set to the "overwrite" position (tab closed).

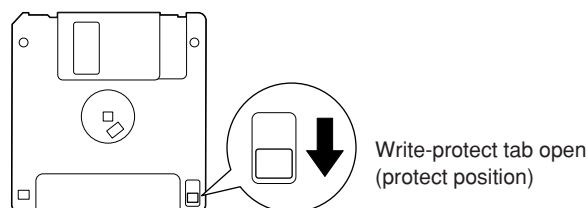

This instrument features a built-in [USB TO DEVICE] terminal. By connecting the instrument to a USB storage device with a standard USB cable, you can save data you've created to the connected device, as well as read data from the connected device. Be sure to handle USB storage device with care. Follow the important precautions below.

NOTE For more information about the handling of USB storage device, refer to the owner's manual of the USB storage device.

Compatible USB storage devices

- Up to two USB storage devices, such as a floppy disk drive, hard disk drive, CD-ROM drive, flash memory reader/writer, etc., can be connected to the [USB TO DEVICE] terminal. (If necessary, use a USB hub. The number of USB storage devices that can be used with musical instruments simultaneously even when a USB hub is used is a maximum of two.) This instrument can recognize up to four drives in one USB storage device. Other USB devices such as a computer keyboard or mouse cannot be used.
- The instrument does not necessarily support all commercially available USB storage devices. Yamaha cannot guarantee operation of USB storage devices that you purchase. Before purchasing USB storage devices, please consult your Yamaha dealer, or an authorized Yamaha distributor (see list at end of the Owner's Manual) for advice, or visit the following web page: <http://music.yamaha.com/homekeyboard/>

NOTE Although CD-R/RW drives can be used to read data to the instrument, they cannot be used for saving data.

Formatting USB storage media

- When a USB storage device is connected or media is inserted, a message may appear prompting you to format the device/media. If so, execute the Format operation.

CAUTION

The format operation overwrites any previously existing data. Make sure that the media you are formatting does not contain important data. Proceed with caution, especially when connecting multiple USB storage medias.

Using USB Storage Devices

- When connecting a USB storage device to the [USB TO DEVICE], make sure that the connector on the device is appropriate and that it is connected in the proper direction. Before removing the media from the device, make sure that the instrument is not accessing data (such as in the Save, Copy and Delete operations).

CAUTION

Avoid frequently turning the power on/off to the USB storage device, or connecting/disconnecting the cable too often. Doing so may result in the operation of the instrument "freezing" or hanging up. While the instrument is accessing data (such as in the Save, Copy and Delete operations), do NOT unplug the USB cable, do NOT remove the media from the device, and do NOT turn the power off to either device. Doing so may corrupt the data on either or both devices.

- If you are connecting two or three devices at the same time (such as two USB storage devices and a LAN adaptor), you should use a USB hub device. The USB hub must be self-powered (with its own power source) and the power must be on. Only one USB hub can be used. If an error message appears while using the USB hub, disconnect the hub from the instrument, then turn on the power of the instrument and re-connect the USB hub.
- Though the instrument supports the USB 1.1 standard, you can connect and use a USB 2.0 storage device with the instrument. However, note that the transfer speed is that of USB 1.1.

To protect your data (write-protect):

To prevent important data from being inadvertently erased, apply the write-protect provided with each storage device or media. If you are saving data to the USB storage device, make sure to disable write-protect.

Playing the Demos

The Demos are more than just songs — they also provide helpful, easy-to-understand introductions to the features, functions and operations of the instrument. In a way, the Demos are an interactive “mini-manual” — complete with sound demonstrations and text showing what it can do for you.

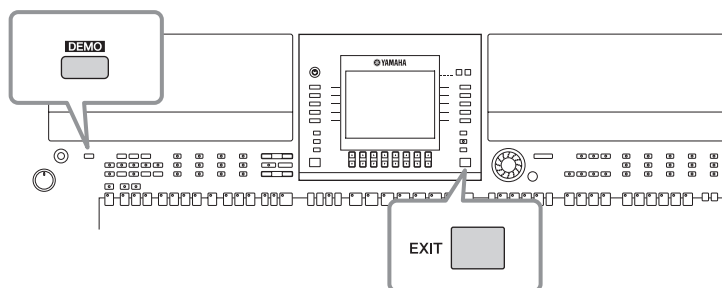

1 Select the desired Language.

- 1 Call up the operation display.
[FUNCTION] → [J]UTILITY → TAB[◀][▶] OWNER
- 2 Press the [4▲▼]/[5▲▼] buttons to select the desired language.

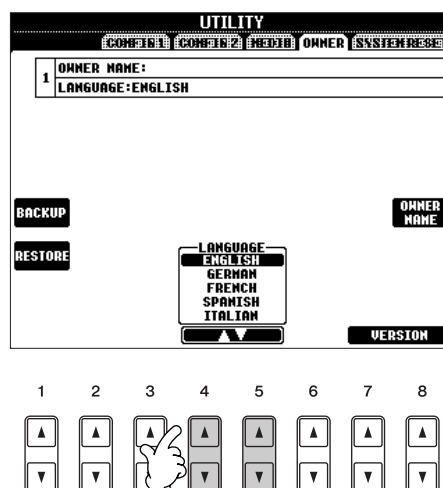

2 Press the [DEMO] button to start the Demos.

Demos will play back continuously until stopped.



3 Press the [EXIT] button to stop the Demo playback.

When the Demo stops, the display returns to the MAIN display.



Showing Specific Demo Topics

- 1 Press the [7▲▼]/[8▲▼] buttons in the Demo display to call up the specific Demo menu.

To return back to the previous display, press the [J] (Play Overview Demo) button.

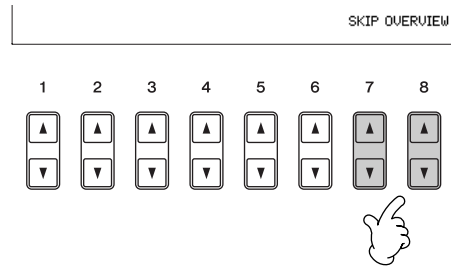

- 2 Press one of the [A]–[H] buttons to show a specific Demo.

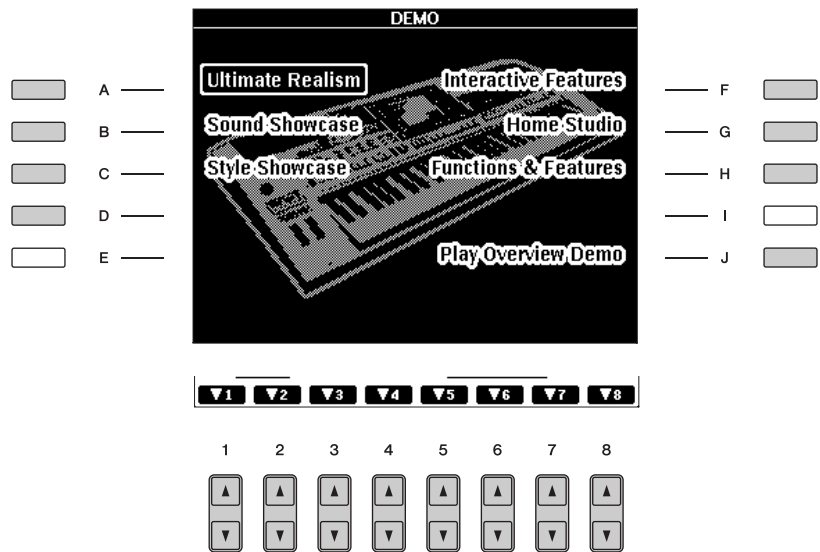

When the Demo has more than one screen.

Press [1▲▼]–[8▲▼] buttons corresponding to the screen number.

- 3 Press the [EXIT] button to exit from the Demos.

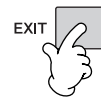

Operations in Basic Displays

To start with, you should know a little about the basic displays that appear in the Quick Guide. There are three basic displays:

- Main display** > See below.
- File selection display** > page 27
- Function display** > page 28

Operation of the Main Display

The Main display shows the basic settings and important information for the instrument (It is the same display that appears when the instrument is turned on.). You can also call up display pages related to the displayed function from the Main display.

NOTE About information in the Main display
See page 62.

1 [A]–[J] buttons

The [A]–[J] buttons correspond to the settings indicated next to the buttons. For example, press the [F] button, and the Voice (RIGHT 1) selection display will appear in the display.

2 [1 ▲ ▼]–[8 ▲ ▼] buttons

The [1 ▲ ▼]–[8 ▲ ▼] buttons correspond to the parameters which are indicated above the buttons. For example, pressing the [1 ▲] button will increase the Song (page 36) volume.

3 [DIRECT ACCESS] and [EXIT] buttons

Here's a convenient way to return to the Main display from any other display: Simply press the [DIRECT ACCESS] button, then the [EXIT] button.

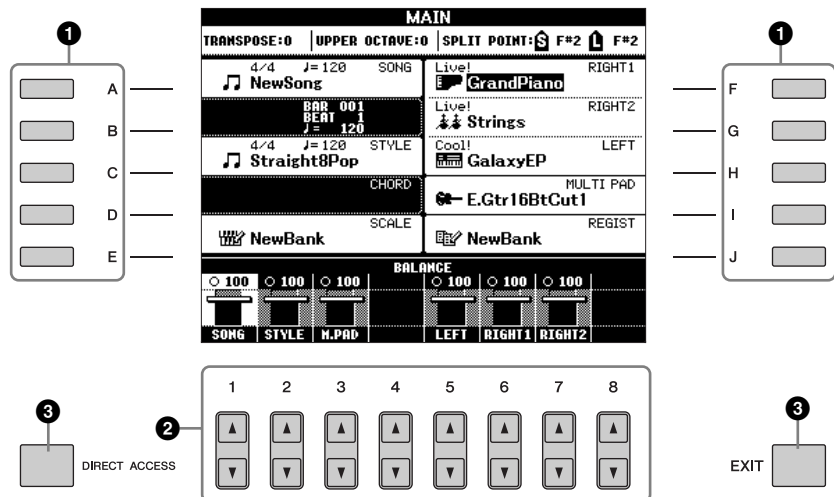

Operation of the File Selection Display

In the File Selection display, you can select the Voice (page 30)/Song (page 36)/Style (page 46), etc. In the example here, we'll call up and use the Song Selection display.

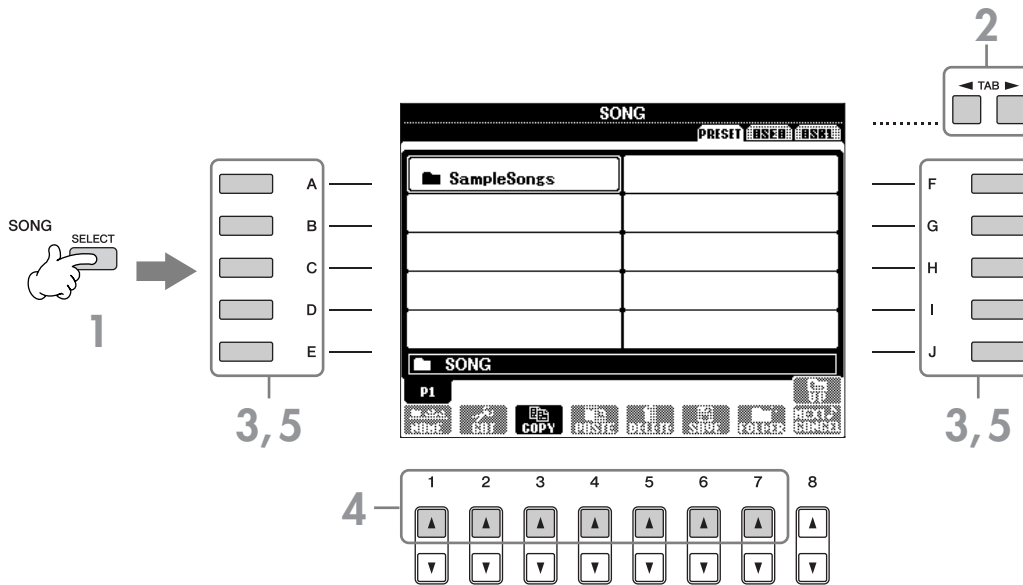

1 Press the SONG [SELECT] button to call up the Song Selection display.

2 Press the TAB [◀][▶] buttons to select the desired drive (PRESET/USER/USB).

About PRESET/USER/USB

PRESET Internal memory to which the preprogrammed data are installed as preset data.

USER Internal memory that allows both reading and writing of data.

USB USB storage device, such as USB flash memory/floppy disk drive, etc., which is connected to the [USB TO DEVICE] terminal.

NOTE Hereafter in this manual, any USB storage device such as USB flash memory/floppy disk drive, etc. will be referred to as "USB storage device."

3 Select a folder (if necessary).

Several Songs may be together in a folder. In this case, the folder(s) will appear in the display (see the illustration at right). Press one of the [A]–[J] buttons to select a folder.

Press the [8 ▲] (UP) button to call up the next highest level folder.



4 Select a page (if the display has several pages).

When the drive contains more than ten Songs, the display is divided up into several pages. The page indications are shown at the bottom of the display. Press one of the [1 ▲]–[7 ▲] buttons to select a page.

NOTE The number of pages shown varies depending on the selection display of the Voices/Songs/Styles. Press the button corresponding to "P1, P2 ..." in the display.

5 Press one of the [A]–[J] buttons to select a Song.

You can also select a Song by using the DATA ENTRY dial, then press the [ENTER] button to execute.

6 Press the [EXIT] button to return to the previous display.

Operation of the Function Display

In the Function display, you can make detailed settings.

In the example here, we'll call up and use the keyboard touch sensitivity setting display.

1 Press the [FUNCTION] button.

Categories of detailed settings are shown.

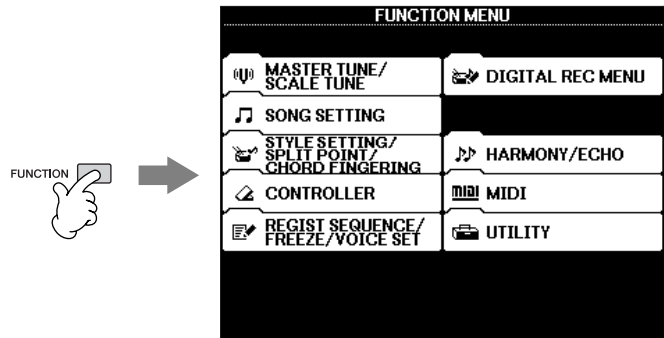

2 Press the [D] button to select the category CONTROLLER.

When the selected category is further divided into sub-categories, the tab(s) will be shown in the display.

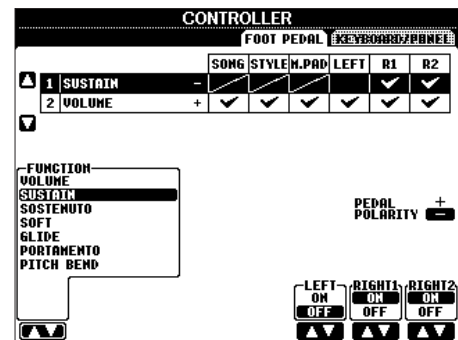

3 Press the TAB [◀][▶] buttons to select the KEYBOARD/PANEL tab.

When the setting is further divided into additional settings, a list will be shown in the display.

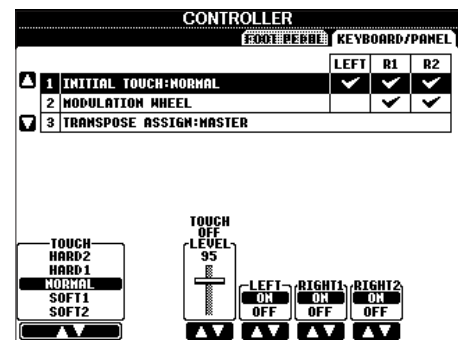
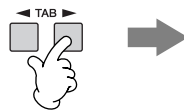

4 Press the [A] button to select the "1 INITIAL TOUCH."

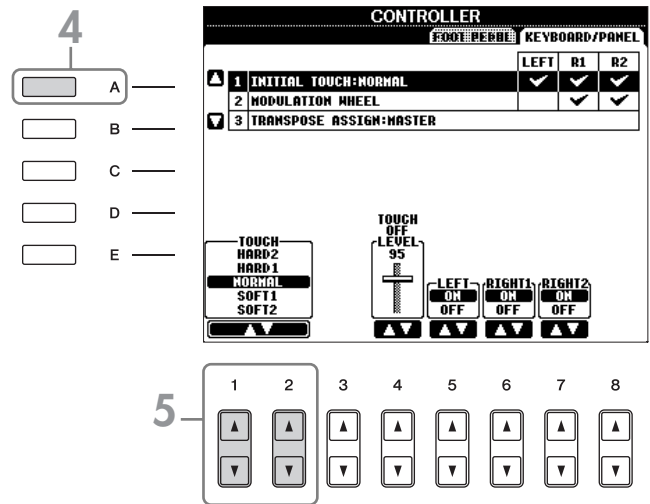

5 Press the [1 ▲ ▼]/[2 ▲ ▼] button to select touch sensitivity for the keyboard.

For details on the touch sensitivity settings, see page 33.

Throughout this manual, arrows are used in the instructions, indicating in shorthand the process of calling up certain displays and functions.

For example, the instructions above can be indicated in shorthand as: [FUNCTION] → [D] CONTROLLER → TAB [◀|▶] KEYBOARD/PANEL → [A] 1 INITIAL TOUCH.

Playing Voices

The instrument features a wide variety of exceptionally realistic Voices, including piano, guitar, strings, wind instruments and more.

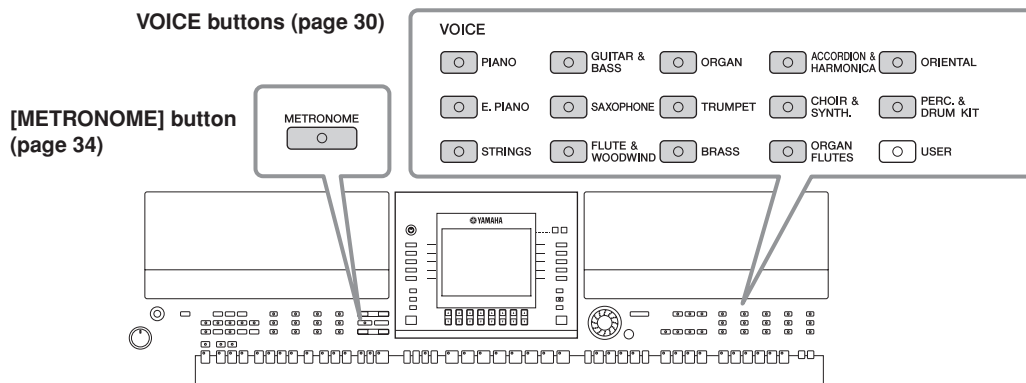

Playing Preset Voices

The preset Voices are categorized and contained in appropriate folders. Voice buttons on the panel correspond to the categories of the preset Voices. For example, press the [PIANO] button to display various piano Voices.

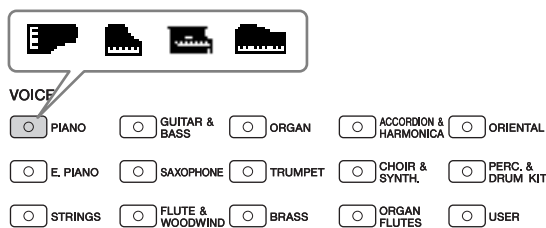

NOTE About the various Voices

Refer to the Voice List in the Data List available at the Yamaha website. (See page 5.)

1 Press the PART SELECT [RIGHT1] button to call up the Voice selection display.

The Voice selected here is for the RIGHT 1 part. For the Voice part, see page 78.

Make sure that the PART ON/OFF [RIGHT1] button is also turned on. If it is turned off, the right-hand part will not sound.

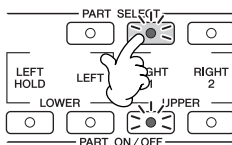

Determining how the Voice selection display is opened (when one of the VOICE category selection buttons is pressed).

You can select how the Voice selection display is opened (when one of the VOICE category selection buttons is pressed).

- 1 Call up the operation display.
[FUNCTION] → [J] UTILITY → TAB [◀][▶] CONFIG 2
- 2 Select the [B] (2 VOICE CATEGORY BUTTON OPTIONS) button, and use the [1 ▲ ▼]/[2 ▲ ▼] buttons to change how the Voice selection display is opened.
 - **OPEN&SELECT:**
Opens the Voice selection display with the top (first) voice of the voice category automatically selected (when one of the VOICE category selection buttons is pressed). With the default settings, the OPEN&SELECT function is turned on.
 - **OPEN ONLY:**
Opens the Voice selection display with the currently selected voice (when one of the VOICE category selection buttons is pressed).

2 Press one of the VOICE buttons to select a Voice category and call up the Voice selection display.

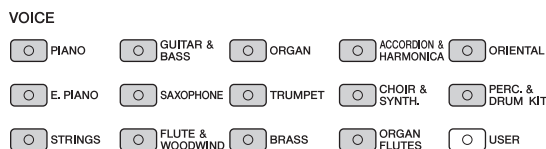

3 Press one of the [A]–[J] buttons to select the desired Voice.

- NOTE**
- The Voice type and its defining characteristics are indicated above the Preset Voice name. For details on the characteristics, see page 77.
 - You can instantly jump back to the original display by “double-clicking” on one of the [A]–[J] buttons.



4 Play the keyboard.

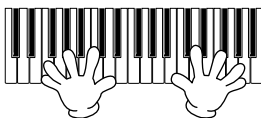

Recalling your favorite Voices easily

The instrument has a huge amount of high-quality Voices, covering an exceptionally broad range of instrument sounds — making it perfect for virtually every musical application. However, the sheer number of Voices may seem overwhelming at first. To easily recall your favorite Voice, there are two methods:

● **Save your favorite Voice to the USER display in the Voice Selection display and recall it by using the VOICE [USER] button**

- 1 Copy your favorite Voices from the Preset drive to the User drive. Refer to page 68 for details on the copy operation.
- 2 Press the Voice [USER] button to call up the Voice Selection display and press one of the [A]–[J] buttons to select the desired Voice.

● **Register your favorite Voice to Registration Memory and recall it with the REGISTRATION MEMORY [1]–[8] buttons**

Refer to page 131 for details on Registration Memory operations.

Playing the Voice Demos

To listen to the various Voices and hear how they sound especially in context, listen to the demo songs for each Voice.

1 In the Voice Selection display (page 31 step 3), press the [8 ▼] (DEMO) button to start the Demo for the selected Voice.

2 To stop the Demo, press the [8 ▼] (DEMO) button again.

Selecting percussion sounds

When one of the Drum Kit Voices in the [PERCUSSION & DRUM KIT] group is selected, you can play various drums and percussion instrument sounds on the keyboard. Details are given in the Drum List provided in the Data List (page 5).

To check which "Standard Kit 1" percussion sounds are assigned to each key, look at the Drum Kit icons printed below the keys (page 15).

Selecting sound effects

You can play individual sound effects, such as bird chirps and ocean sounds from the keyboard. The sound effects are categorized as "GM&XG"/"GM2."

- 1 Press the PART SELECT [RIGHT 1] button to call up the Voice selection display.
- 2 Press the [8 ▲] (UP) button to call up the Voice categories.
- 3 Press the [2 ▲] button to display page 2.
- 4 Press the [E]/[F] button to select "GM&XG"/"GM2."
- 5 Press the [2 ▲] button to display page 2.
- 6 Press the [F] button to select "SoundEffect."
- 7 Press one of the [A]–[J] buttons to select the desired sound effect.
- 8 Play the keyboard.

Selecting GM/XG/GM2 Voices

NOTE For details on the Voice allocation format, see page 177.

You can select the GM/XG/GM2 Voices directly via the panel operation. Perform steps 1–4 described in the "Selecting sound effects" above, select the desired category, then select the desired voice.

Playing different Voices simultaneously

The instrument can play different Voices simultaneously (page 78).

• Layering two different Voices

This is useful for creating rich and thick sounds.

• Setting separate Voices for the left and right sections of the keyboard

You can play different Voices with the left and right hands. For example, you can set up the keyboard to play the bass Voice with your left hand and the piano Voice with your right hand.

Setting the touch sensitivity of the keyboard

You can adjust the touch response of the instrument (how the sound responds to the way you play the keys). The touch sensitivity type becomes the common setting for all Voices.

- 1 Call up the operation display:
[FUNCTION] → [D] CONTROLLER → TAB [◀][▶] KEYBOARD/
PANEL → [A] 1 INITIAL TOUCH
- 2 Press the [1 ▲ ▼]/[2 ▲ ▼] buttons to specify the touch response.
HARD 2 Requires strong playing to produce high volume. Best
for players with a heavy touch.
HARD 1 Requires moderately strong playing for high volume.
NORMAL... Standard touch response.
SOFT 1..... Produces high volume with moderate playing strength.
SOFT 2..... Produces relatively high volume even with light play-
ing strength. Best for players with a light touch.

- NOTE**
- This setting does not change the weight of the keyboard.
 - When you do not want to apply touch sensitivity, set Touch to OFF for the corresponding parts by pressing the [5 ▼]–[7 ▼] buttons. When Touch is set to OFF, you can specify the fixed volume level by pressing the [4 ▲ ▼] button.
 - The touch sensitivity settings may have no effect with certain voices.

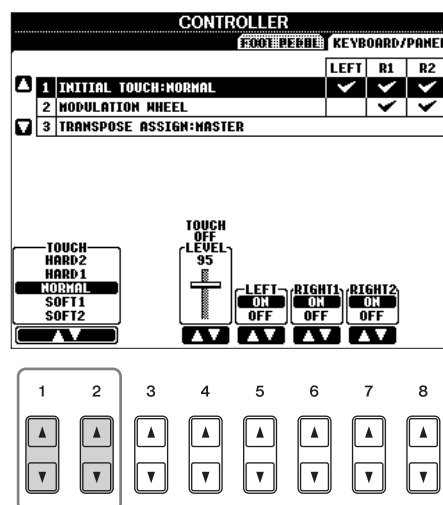

Using the Pitch Bend Wheel

Use the PITCH BEND wheel to bend notes up (roll the wheel away from you) or down (roll the wheel toward you) while playing the keyboard. The Pitch Bend is applied to all the keyboard parts (RIGHT 1, 2 and LEFT). The PITCH BEND wheel is self-centering and will automatically return to normal pitch when released.

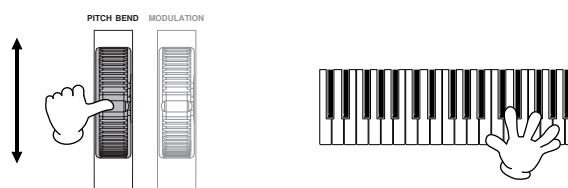

- NOTE**
- If the Pitch Bend range is set to more than 1200 cents (1 octave) via MIDI, the pitch of some voices may not be raised or lowered completely.
 - The effects caused by using the PITCH BEND Wheel will not be applied to the LEFT part when the Chord Fingering type is set to the one other than "FULL KEYBOARD" or "AI FULL KEYBOARD" with the [ACMP] and PART ON/OFF [LEFT] turned on.

The maximum pitch bend range can be changed via the following instructions.

- 1 Call up the display for setting the Pitch Bend Range.
[MIXING CONSOLE] → TAB [◀][▶] → TUNE → [H] PITCH BEND RANGE
- 2 Set each of the Pitch Bend Range of the keyboard part by using the [5 ▲ ▼]/[6 ▲ ▼]/[7 ▲ ▼] button.
[5 ▲ ▼] button..... Sets the Pitch Bend Range of the LEFT part.
[6 ▲ ▼] button..... Sets the Pitch Bend Range of the RIGHT1 part.
[7 ▲ ▼] button..... Sets the Pitch Bend Range of the RIGHT2 part.

Using the Modulation Wheel

The Modulation function applies a vibrato effect to notes played on the keyboard. This is applied to all the keyboard parts (RIGHT 1, 2 and LEFT). Moving the MODULATION wheel down (towards MIN) decreases the depth of the effect, while moving it up (towards MAX) increases it.

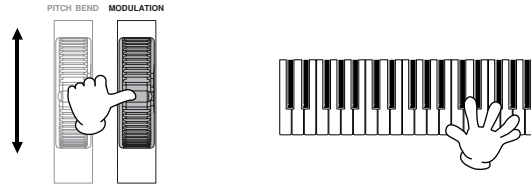

- NOTE**
- To avoid accidentally applying modulation, make sure the MODULATION Wheel is set at MIN before you start playing.
 - The effects caused by using the MODULATION wheel will not be applied to the LEFT part when the Chord Fingering type is set to the one other than "FULL KEYBOARD" or "AI FULL KEYBOARD" with the [ACMP] and PART ON/OFF [LEFT] turned on.

You can set whether the effects caused by the MODULATION Wheel will be applied or not to each of the keyboard part.

- Call up the display.
[FUNCTION] → [D] CONTROLLER → TAB [◀|▶] → KEYBOARD/PANEL → [A]/[B] 2 MODULATION WHEEL
- Set whether the effects caused by the MODULATION Wheel will be applied or not to each of the keyboard part by using the [5 ▲ ▼]/[6 ▲ ▼]/[7 ▲ ▼] button.
 - [5 ▲ ▼] button..... Sets whether the effects caused by the MODULATION Wheel will be applied or not to the LEFT part.
 - [6 ▲ ▼] button..... Sets whether the effects caused by the MODULATION Wheel will be applied or not to the RIGHT1 part.
 - [7 ▲ ▼] button..... Sets whether the effects caused by the MODULATION Wheel will be applied or not to the RIGHT2 part.

Using the Metronome

The metronome provides a click sound, giving you an accurate tempo guide when you practice, or letting you hear and check how a specific tempo sounds.

- Press the **METRONOME** button to start the metronome.

- To stop the metronome, press the **METRONOME** button again.

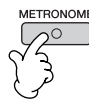

Adjusting the Tempo or Setting the Time Signature of the Metronome Sound

Adjusting the Metronome Tempo

- Press the **TEMPO [-]/[+]** button to call up the pop-up tempo setting display.

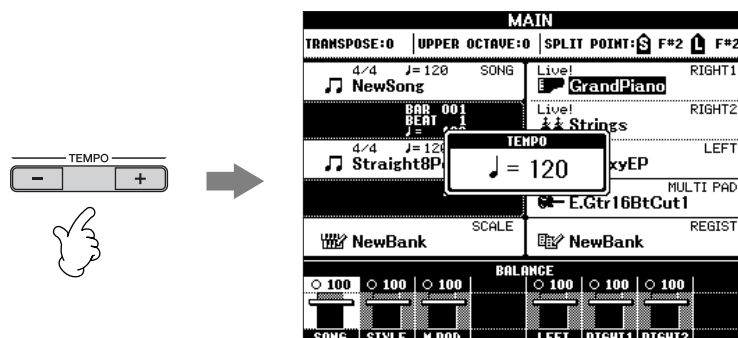

2 Press the TEMPO [-]/[+] buttons to set the tempo.

Pressing and holding either button lets you continuously increase or decrease the value.

You can also use the DATA ENTRY dial to adjust the value. To reset the tempo, press the TEMPO [-]/[+] buttons simultaneously.

NOTE About the Tempo display

The number in the display indicates how many quarter-note beats there are in one minute. The range is between 5 and 500. The higher the value, the faster the tempo.

3 Press the [EXIT] button to close the Tempo display.

Set the Popup Display Time

- 1 Call up the operation display.
[FUNCTION] → [J] UTILITY → TAB [◀][▶] CONFIG 2
- 2 Select the [B] (2 POPUP DISPLAY TIME) button, and use the [7 ▲ ▼]/[8 ▲ ▼] buttons to set the time.

Determine the Metronome Time Signature and Other Settings

- 1 Call up the operation display:
[FUNCTION] → [J] UTILITY → TAB [◀][▶] CONFIG 1 → [B] 2 METORONOME

- 2 Set the parameters by pressing the [2 ▲ ▼]–[7 ▲ ▼] buttons.

VOLUME	Determines the level of the metronome sound.
SOUND	Determines which sound is used for the metronome. Bell Off..... Conventional metronome sound, with no bell. Bell On..... Conventional metronome sound, with bell.
TIME SIGNATURE	Determines the time signature of the metronome sound.

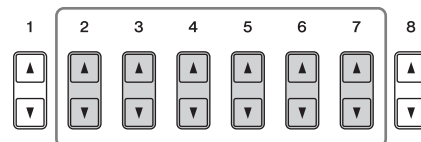
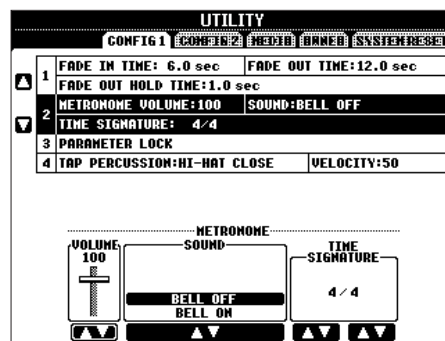

Practicing with the Preset Songs

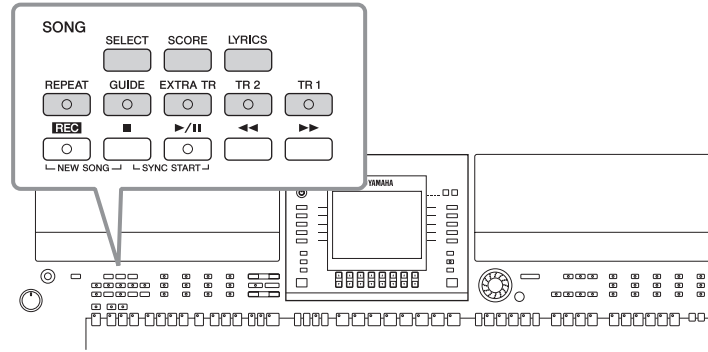

NOTE Song
In this manual, the word “Song” refers to performance data.

Playing Back and Listening to Songs Before Practicing

The instrument includes several preset Songs. This section covers basic information on playing back the preset Songs.

- 1 Press the **SONG [SELECT]** button to call up the Song selection display.



- 2 Press the **[A]** button to select the Sample Song category.



- 3 Press one of the **[A]–[E]** buttons to select the desired Song.

You can also select the file by using the DATA ENTRY dial, then press the [ENTER] button to execute.

NOTE You can instantly jump back to the original display by “double-clicking” on one of the [A]–[E] buttons.

- 4 Press the **SONG [▶ / ||]** (PLAY/PAUSE) button to start playback.

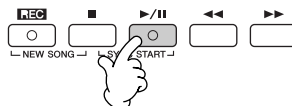

5 Press the SONG [■] (STOP) button to stop playback.

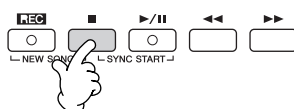

Playing Songs saved to USER (page 67)

- 1 Press the SONG [SELECT] button to call up the Song selection display.
- 2 Press the TAB [◀|▶] buttons to select the USER tab.



- 3 Press one of the [A]–[J] buttons to select the desired Song.

Playing Songs saved to a USB storage device (page 67)

⚠ CAUTION

Before using a USB storage device, be sure to read "Handling the USB Storage Device (USB Flash Memory/Floppy Disk, etc)" on page 23.

- 1 Connect the USB storage device to the [USB TO DEVICE] terminal.
- 2 Press the SONG [SELECT] button to call up the Song selection display.
- 3 Press the TAB [◀|▶] buttons to select the USB tab ("USB1"/"USB2"), corresponding to the USB storage device you inserted in Step 1.
The indication "USB1"/"USB2" will be displayed depending on the number of the connected devices.



- 4 Use the [A]–[J] buttons to select a Song.

NOTE You can also select a specified file in the USB storage device by pressing the [USB] button.
[USB] → [A] SONG → [A]–[J]

Playing Songs in sequence

You can play all Songs in a folder continuously.

- 1 Select a Song in the desired folder.
- 2 Call up the operation display.
[FUNCTION] → [B] SONG SETTING
- 3 Press the [H] (REPEAT MODE) button to select "ALL."
- 4 Press the SONG [▶ / ■] (PLAY/PAUSE) button to start playback.
All Songs in the folder play back continuously, in order.
- 5 Press the SONG [■] (STOP) button to stop continuous playback.
- 6 To turn off the Song sequence playback, press the [H] button to select "OFF" in the display in step 2.

Boost the volume of the part to be practiced

On the instrument, a single Song can contain separate data for up to sixteen MIDI channels. Specify the channel for practicing and increase the playback volume for the channel.

- 1 Select a Song. The method for selecting a Song is the same as “Playing Back and Listening to Songs Before Practicing” (page 36 step 1–3).
- 2 Press the [MIXING CONSOLE] button to call up the MIXING CONSOLE display.

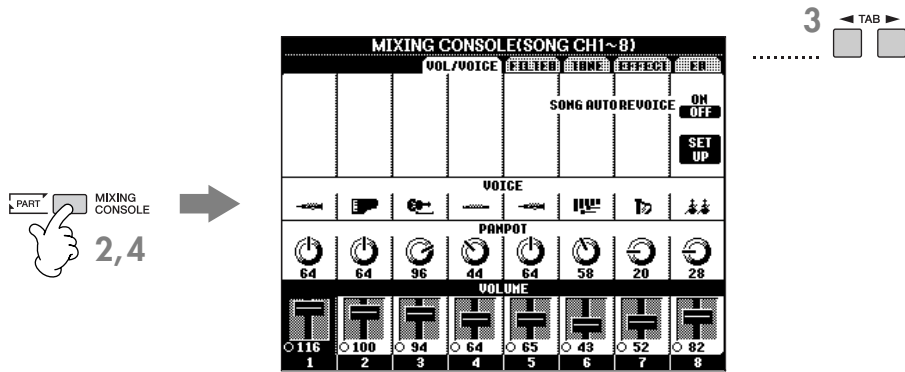

- 3 Press the TAB [◀][▶] buttons to select the VOL/VOICE tab.
- 4 Press the [MIXING CONSOLE] button until “MIXING CONSOLE (SONG CH1-8)” is shown at the top of the display.
- 5 Press the [E]/[I] button to select “VOLUME.”
- 6 To raise the level of the desired channel(s), press the appropriate buttons [1 ▲ ▼]–[8 ▲ ▼].
If the desired channel is not shown in the MIXING CONSOLE (SONG CH1-8) display, press the [MIXING CONSOLE] button to call up the MIXING CONSOLE (SONG CH9-16) display.

If you don't know which channel's volume to raise:

- Look at the illustrations of the instruments indicated below “VOICE.”

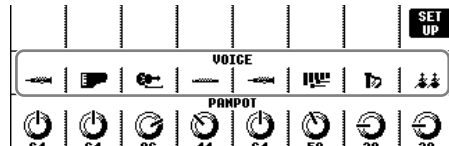

- Look at the channel indicators, which light as the Song plays back. Watching these as you listen can show you which channel you wish to boost.

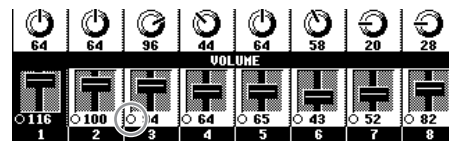

Displaying Music Notation (Score)

You can view the music notation of the selected Song. We suggest that you read through the music notation before starting to practice.

- NOTE** • The instrument can display the music notation of commercially-available music data or your recorded Songs.
- The displayed notation is generated by the instrument based on the Song data. As a result, it may not be exactly the same as commercially available sheet music of the same song — especially when displaying notation of complicated passages or many short notes.
- The notation functions cannot be used to create Song data by inputting notes. For information on creating Song data, see page 143.

1 Select a Song (page 36).

2 Press the [SCORE] button to display the music notation.

- NOTE** Look through the entire score before playing back the Song
Press the TAB [◀][▶] buttons to select subsequent pages.
You can also use the footswitch to select subsequent pages (page 169).

3 Press the SONG [▶ / II] (PLAY/PAUSE) button to start playback.

The “ball” bounces along through the score, indicating the current position.

4 Press the SONG [■] (STOP) button to stop playback.

Changing the Notation Display

You can change the notation display as desired to suit your personal preferences.

1 Press the [SCORE] button to display the music notation.

- NOTE** The music notation at right is for instructional purposes only, and the song depicted is not one of the preset Songs on your instrument.

2 Change the following settings as desired.

- **Changing the size of the music notation**
Press the [7 ▲ ▼] button to change the size of the music notation.
- **Displaying only right-hand part/left-hand part notation**
Press the [1 ▲ ▼]/[2 ▲ ▼] button to disable display of the left-hand part/right-hand part.
- **Customizing the notation display**
 - **Display the note name at the left of the note**
 - 1 Press the [5 ▲ ▼] (NOTE) button to display the note name.
 - 2 Press the [8 ▲ ▼] (SET UP) button to call up the detailed setting display.
 - 3 Press the [6 ▼] (NOTE NAME) button to select “Fixed Do.”
 - 4 Press the [8 ▲] (OK) button to apply the setting.
 - **Increase the number of measures in the display**
You can increase the number of measures that will be displayed by decreasing the other items to be displayed (part, lyrics, chords, etc.).
Use the [1 ▲ ▼]–[4 ▲ ▼] buttons to turn off the items you want not to be displayed.

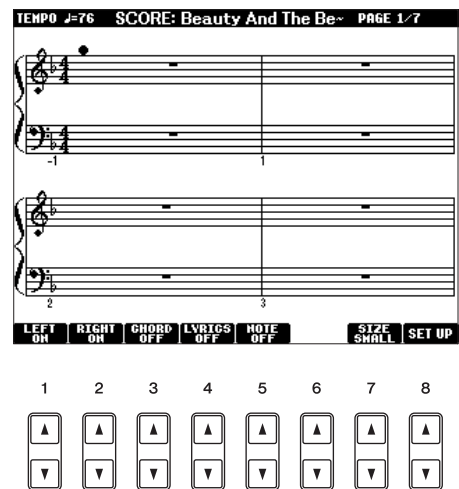

Set the detailed parameters of the view type as desired.

- 1 Press the [8 ▲ ▼] (SET UP) button to call up the detailed setting display.
- 2 Press the [1 ▲ ▼]–[6 ▲ ▼] buttons to set the view type.

LEFT CH/RIGHT CH	<p>Determines which MIDI channel in the Song data is used for the left-hand/right-hand part. This setting returns to AUTO when a different Song is selected.</p> <p>AUTO The MIDI channels in the Song data for the right- and left-hand parts are assigned automatically — setting the parts to the same channel as the channel which is specified in the [FUNCTION] → [B] SONG SETTING.</p> <p>1–16 Assigns the specified MIDI channel (1–16) to each of the left- and right-hand parts.</p> <p>OFF (LEFT CH only) No channel assignment: This disables display of the left-hand key range.</p>
KEY SIGNATURE	This lets you enter key signature changes in the middle of a song, at the stopped position. This menu is useful when the selected Song contains no key signature settings for displaying notation.
QUANTIZE	This gives you control over the note resolution in the notation, letting you shift or correct the timing of all displayed notes so that they line up to a particular note value. Make sure to select the smallest note value used in the song.
NOTE NAME	<p>Selects the type of the note name indicated at the left of the note in the notation from among the following three types. The settings here are available when the NOTE parameter in “Display the note name at the left of the note” step 1 is set to ON.</p> <p>A, B, C Note names are indicated as letters (C, D, E, F, G, A, B).</p> <p>FIXED DO Note names are indicated in solfeggio and differ depending on the selected language. The language is specified in LANGUAGE of the OWNER display (page 19).</p> <p>MOVABLE DO Note names are indicated in solfeggio according to the scale intervals, and as such are relative to the key. The root note is indicated as Do. For example, in the key of G major the root note of “So” would be indicated as “Do.” As with “Fixed Do,” the indication differs depending on the selected language.</p>

- 3 Press the [8 ▲] (OK) button to apply the setting.

NOTE Save the notation view settings

The notation view settings can be saved as part of a Song (page 162).

Muting the Right- or Left-hand Part Viewing the Score

The Guide function indicates the notes you should play, when you should play them, and how long you should hold them down. You can also practice at your own pace — since the accompaniment waits for you to play the notes correctly. Here, mute the right- or left-hand part and try practicing the part.

Practicing the Right-hand Part (TRACK 1)

- 1 Select a Song (page 36), then press the [SCORE] button to call up the Score display.

- 2 Turn the [GUIDE] button on.

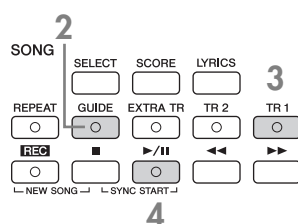

3 Press the SONG [TR 1] button to mute the right-hand part.

The indicator of the [TR 1] button goes out. You can now play that part by yourself.

4 Press the SONG [▶ / II] (PLAY/PAUSE) button to start playback.

Practice the muted part viewing the Score display.

NOTE Adjusting the tempo

Refer to page 34.

Quickly changing tempo during a performance (Tap function)

The tempo can also be changed during Song playback by tapping the [TAP TEMPO] button twice at the desired tempo.

5 Press the SONG [■] (STOP) button to stop playback.

6 Turn the [GUIDE] button off.

Adjusting the volume balance between the Song and the keyboard

This lets you adjust the volume balance between Song playback and the sound you play on the keyboard.

- 1 Press the [BALANCE] button to call up the volume balance display.
- 2 To adjust the Song volume, press the [1 ▲ ▼] button. To adjust the keyboard (RIGHT 1) volume, press the [6 ▲ ▼] button.
- 3 Press the [EXIT] button to close the volume balance display.

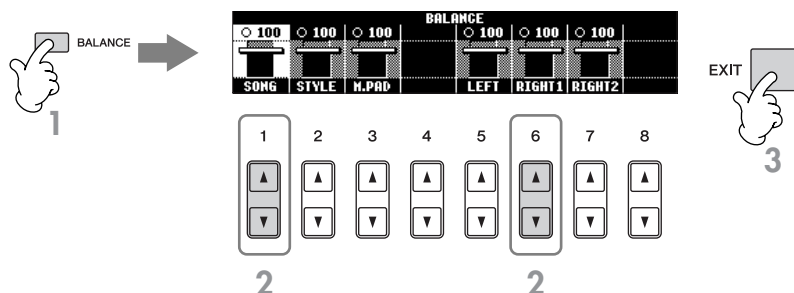

NOTE About keyboard parts (Right 1, Right 2, Left)

See page 78.

Other guide functions

The initial setting "Follow Lights" was used in the instructions "Muting the Right- or Left-hand Part Viewing the Score" on page 40. There are additional functions in the Guide feature, as described below.

To select a guide function, see page 141.

For keyboard performance

- **Any Key**

This lets you practice the timing of playing the keys.

For Karaoke

- **Karao-Key**

This function lets you control the Song playback timing with just one finger, while you sing along.

Practicing the Left-hand Part (TRACK 2) Viewing the Score

1,2 Follow the same steps as in “Practice the right-hand part (TR 1)” on page 40.

3 Press the [TR 2] button to mute the left-hand part.

The indicator of the [TR 2 (L)] button goes out. You can now play that part by yourself.

4 Press the SONG [▶ / ||] (PLAY/PAUSE) button to start playback and practice the muted part.

5 Press the SONG [■] (STOP) button to stop playback.

6 Turn the [GUIDE] button off.

Practicing with the Repeat Playback Function

The Song Repeat functions can be used to repeatedly play back a Song or a specific range of measures in a Song. This is useful for repeated practicing of difficult-to-play phrases.

Playing Back a Song Repeatedly

- 1** Select a Song (page 36).
- 2** Press the [REPEAT] button to turn on Repeat playback.
- 3** Press the SONG [▶ / ||] (PLAY/PAUSE) button to start playback.
The Song will be played back repeatedly until you press the SONG [■] (STOP) button.
- 4** Press the SONG [■] (STOP) button to stop playback.
- 5** Press the [REPEAT] button to turn off Repeat playback.

Specifying a Range of Measures and Playing them Back Repeatedly (A-B Repeat)

- 1** Select a Song (page 36).
- 2** Press the SONG [▶ / ||] (PLAY/PAUSE) button to start playback.
- 3** Specify the repeat range.
Press the [REPEAT] button at the starting point (A) of the range to be repeated. Press the [REPEAT] button again at the ending point (B). After an automatic lead-in (to help guide you into the phrase), the range from Point A to Point B is played back repeatedly.
NOTE Instantly returning to Point A
Regardless of whether the Song is playing back or is stopped, pressing the [■] (STOP) button returns to Point A.
- 4** Press the SONG [■] (STOP) button to stop playback.
- 5** Press the [REPEAT] button to turn off Repeat playback.

Other Methods for Specifying the A–B Repeat Range

● Specifying the repeat range while Songs are stopped

- 1 Press the [▶▶] (Fast Forward) button to advance to the Point A location.
- 2 Press the [REPEAT] button to specify Point A.
- 3 Press the [▶▶] (Fast Forward) button to advance to the Point B location.
- 4 Press the [REPEAT] button again to specify Point B.

● Specifying the repeat range between Point A and the end of the Song

Specifying only Point A results in repeat playback between Point A and the end of the Song.

Recording Your Performance

Record your performance by using the Quick Recording feature. This is an effective practice tool, allowing you to easily compare your own performance to the original song you are practicing. You can also use it to practice duet pieces by yourself, if you have your teacher or partner record his or her part beforehand.

1 Press the [REC] and [■] (STOP) buttons simultaneously.

A blank Song for recording is automatically set.

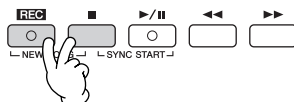

2 Select a Voice (page 30). The selected Voice will be recorded.

3 Press the [REC] button.

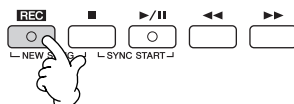

4 Start recording.

Recording begins automatically as soon as you play a note on the keyboard.

5 Press the SONG [■] (STOP) button to stop recording.

A message prompting you to save the recorded performance appears. To close the message, press the [EXIT] button.

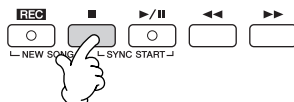

6 Press the SONG [▶ / II] (PLAY/PAUSE) button to play back the recorded performance.

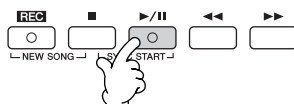

7 Save the recorded performance.

- 1 Press the SONG [SELECT] button to call up the Song selection display.
- 2 Press the TAB [◀][▶] buttons to select the appropriate tab (USER, USB, etc.) to which you want to save the data. Select USER to save the data to internal memory, or select USB to save the data to a USB storage device.
- 3 Press the [6▼] (SAVE) button to call up the file naming display.
- 4 Enter the file name (page 71).
- 5 Press the [8▲] (OK) button to save the file.
To cancel the Save operation, press the [8▼] (CANCEL) button.

⚠ CAUTION

The recorded song will be lost if you change to another Song or you turn the power off without executing the Save operation.

When the following message appears: "Song" changed. Save?/"Song" speichern?/"Song" modifié. Sauv.?"Song" cambiado. ¿Guardar?/Salvare "Song"?"

The recorded data has not yet been saved. To save the data, press the [G] (YES) button to open the Song selection display and save the data (see above). To cancel the operation, press the [H] (NO) button.

Playing Songs saved to USER or a USB storage device.

Refer to page 37.

Playing Backing Parts with the performance assistant Technology

This feature makes it exceptionally easy to play the backing parts along with Song playback.

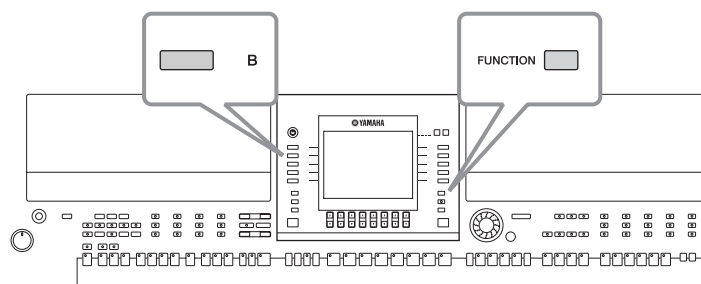

NOTE Before using performance assistant technology

To use the performance assistant technology, the Song must contain chord data. If the Song contains this data, the current chord name will be displayed in the Main display during Song playback, letting you easily check whether the Song contains chord data or not.

1 Select a Song (page 36).

In these example instructions, use the Songs in the "SampleSongs" folder.

2 Call up the operation display.

[FUNCTION] → [B] SONG SETTING

3 Press the [8 ▲ ▼] button to turn the [P.A.T.] (Performance Assistant) on.

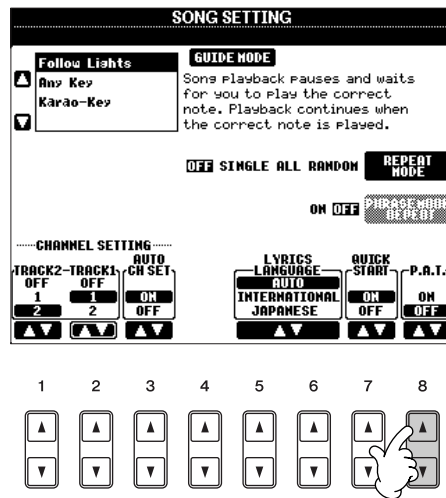

4 Press the SONG [▶ / II] (PLAY/PAUSE) button to start playback.

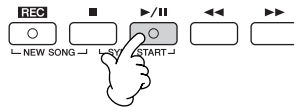

5 Play the keyboard.

The instrument automatically matches your performance on the keyboard to the Song playback and chords, no matter what keys you play. It even changes the sound according to the way you play. Try playing in the three different ways below.

- Playing the left and right hand together (method 1).
- Playing the left and right hand together (method 2).
- Playing the left hand and right hand alternately.

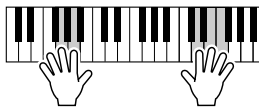

Play three notes at the same time with your right hand.

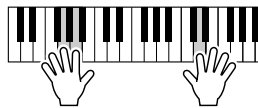

Play several notes one after the other with different fingers of your right hand.

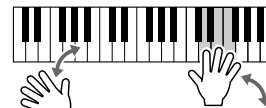

Play three notes at the same time with your right hand.

6 Press the SONG [■] (STOP) button to stop playback.

7 Press the [8 ▲ ▼] button to turn the [P.A.T.] (Performance Assistant) off.

Playing Accompaniment with the Auto Accompaniment Feature (Style Playback)

The Auto Accompaniment features let you produce automatic accompaniment playback simply by playing "chords" with your left hand. This lets you automatically recreate the sound of a full band or orchestra — even if you're playing by yourself. The Auto Accompaniment sound is made up of the rhythm patterns of the Styles. The Styles of the instrument cover a wide range of different musical genres including pop, jazz, and many others.

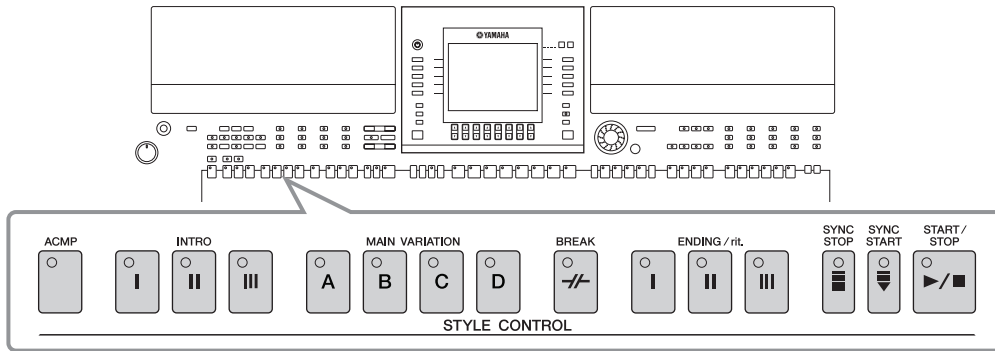

Playing "Mary Had a Little Lamb" with the Auto Accompaniment Feature

MARY HAD A LITTLE LAMB

Traditional

Style: Straight 8 Pop

Chord progression: C, C, G, C

Chord progression: C, C, G, C, Ending

1 Press the STYLE CONTROL "POP & ROCK" button.

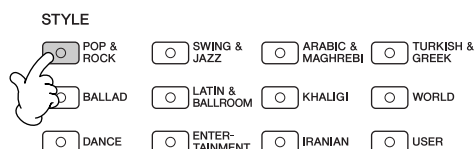

Enabling tempo display above Style name

You can select whether the tempo is displayed above the Style name or not.

- 1 Call up the operation display.
[FUNCTION] → [J] UTILITY → TAB [◀][▶] CONFIG 2
- 2 Select the [B] (2 DISPLAY STYLE TEMPO) button, and use the [5 ▲ ▼]/[6 ▲ ▼] buttons to switch the tempo display on/off.
 - ON:
Tempo is displayed above the Style name.
With the default settings, the Display Style Tempo function is on.
 - OFF:
Tempo is not displayed above the Style name.

2 Press one of the [A]–[J] buttons to select a Style “Straight 8 Pop.”

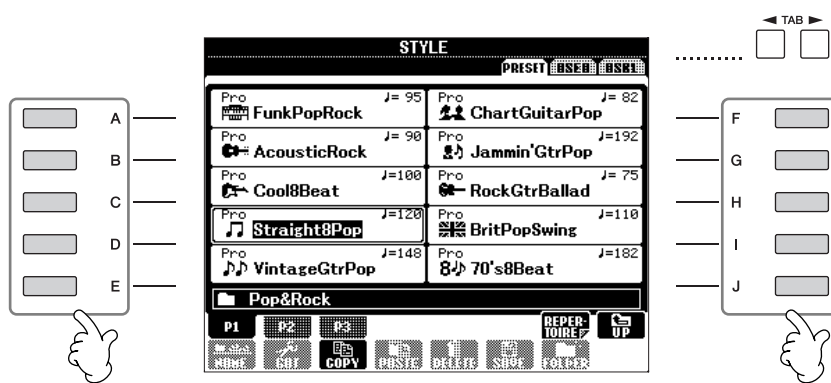

- **NOTE** The Style type and its defining characteristics are indicated above the Preset Style name. For details on the characteristics, see page 103.
- When the [7 ▲] (REPERTOIRE) button is pressed after selecting a Style, you can call up the custom panel settings (for voices and tempos, etc.) designed to best match the selected Style. For details on Repertoire, see page 56. To return to the previous display, press the [EXIT] button.
- You can instantly jump back to the original display by “double-clicking” on one of the [A]–[J] buttons.

3 Press the [ACMP] button to turn on Auto Accompaniment.

Use the left-hand section (lower part) of the keyboard to play the chords for sounding the Auto Accompaniment.

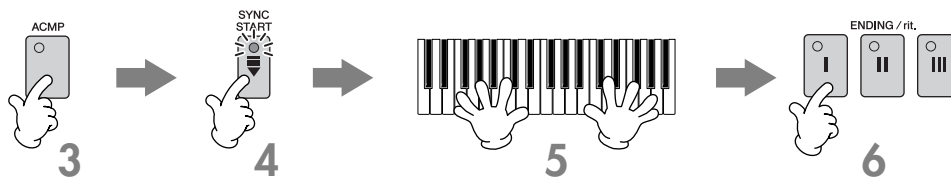

4 Press the [SYNC START] button to set Auto Accompaniment to standby — letting you simultaneously start the accompaniment as soon as you start playing.

5 As soon as you play a chord with your left hand, the Auto Accompaniment starts.

Try playing chords with your left hand and play a melody with your right hand.

- **NOTE** **Chord Fingerings**
There are seven different fingering methods you can use to specify chords (page 103).

6 Automatically play an appropriate ending by pressing any of the [ENDING/rit.] buttons, at the point in the score (page 46) indicated by "Ending."

When Ending playback is finished, the Style automatically stops.

NOTE • About the various Styles

Refer to the Style List in the Data List available at the Yamaha website. (See page 5.)

• Quickly changing the Style tempo during a performance (Tap function)

The tempo can also be changed during playback by tapping the [TAP TEMPO] button twice at the desired tempo.

• Specifying the split point (the border between the right- and left-hand range)

See page 107.

• Turns touch response on/off for the Style playback (Style Touch)

See page 106.

Adjusting the volume balance between the Style and the keyboard

This lets you adjust the volume balance between Style playback and the sound you play on the keyboard.

- 1 Press the [BALANCE] button to call up the volume balance display.
- 2 To adjust the Style volume, press the [2 ▲ ▼] button. To adjust the keyboard (RIGHT 1) volume, press the [6 ▲ ▼] button.
- 3 Press the [EXIT] button to close the volume balance display.

Pattern Variation

While you play, you can automatically add specially created intros and endings, as well as variations in the rhythm/chord patterns, for more dynamic, professional-sounding performances. There are several different auto accompaniment pattern variations for each situation: starting your performance, during your performance, and ending your performance. Try out the variations and combine them freely.

To Start Playing

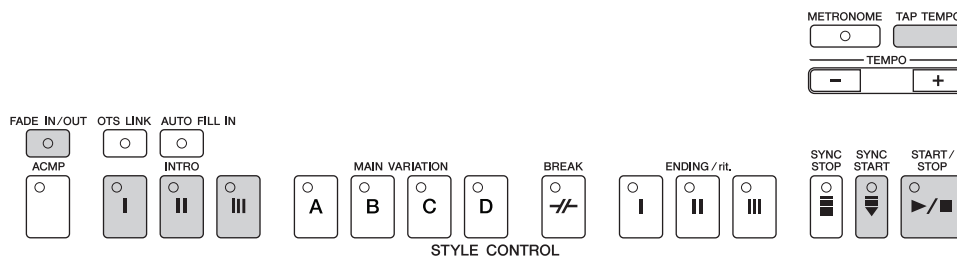

● Start/Stop

Styles start playing back as soon as the STYLE CONTROL [START/STOP] button is pressed.

● Intro

This is used for the beginning of the song. Each preset Style features three different intros. When the intro finished playing, accompaniment shifts to the Main section (see "Main" in the "During Style playback").

Press one of the INTRO [I]–[III] buttons before starting Style playback and press the STYLE CONTROL [START/STOP] button to start Style playback.

● Synchro Start

This lets you start playback as soon as you play the keyboard.

Press the [SYNC START] button when Style playback is stopped and play a chord in the chord section of the keyboard to start Style playback.

● Fade In

The Fade In produces smooth fade-ins when starting the Style.

Press the [FADE IN/OUT] button when Style playback is stopped and press the STYLE CONTROL [START/STOP] button to start Style playback.

● Tap

Tap out the tempo and automatically start the Style at that tapped speed. Simply tap (press/release) the [TAP TEMPO] button (four times for a 4/4 time signature), and the Style playback starts automatically at the tempo you tapped.

NOTE The particular drum sound and the velocity (loudness) of the sound when the Tap function is used can be selected in the following display.

[FUNCTION] → [J] UTILITY → TAB [◀][▶] CONFIG 1 → [B] 4 TAP

During Style Playback

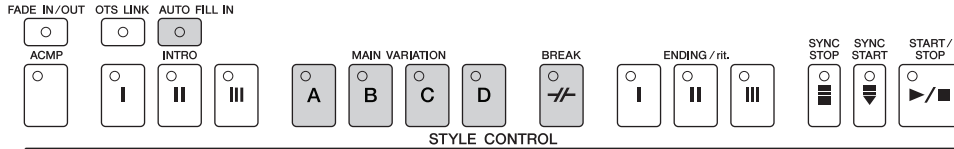

● Main

This is used for playing the main part of the Song. It plays an accompaniment pattern of several measures, and repeats indefinitely. Each preset Style features four different patterns.

Press one of the MAIN [A]–[D] buttons during Style playback.

● Fill In

The fill-in sections let you add dynamic variations and breaks in the rhythm of the accompaniment, to make your performance sound even more professional.

Turn on the [AUTO FILL IN] button before starting Style playback or during playback. Then, simply press one of the MAIN VARIATION (A, B, C, D) buttons as you play, and the selected fill-in section plays automatically (AUTO FILL), spicing up the auto accompaniment. When the fill-in is finished, it leads smoothly into the selected main section (A, B, C, D).

Even when [AUTO FILL IN] button is turned off, pressing the same button of the currently playing section automatically plays a fill-in before returning to the same main section.

● Break

This lets you add dynamic breaks in the rhythm of the accompaniment, to make your performance sound even more professional.

Press the [BREAK] button during Style playback.

To Finish Playing

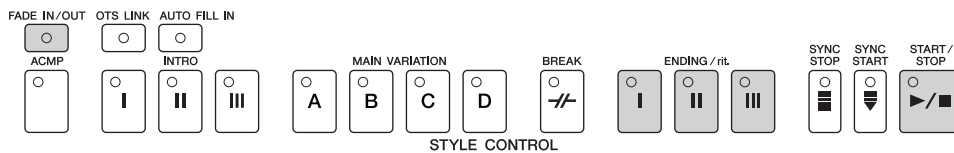

● Start/stop

Styles stop as soon as the STYLE CONTROL [START/STOP] button is pressed.

● Ending

This is used for the ending of the Song. Each preset Style features three different endings. When the ending is finished, the Style stops automatically.

Press one of the ENDING/rit. [I]–[III] buttons during Style playback. You can have the ending gradually slow down (ritardando) by pressing the same ENDING/rit. button again while the ending is playing back.

NOTE If you press the ENDING/rit. [I] button in the middle of your performance, a fill-in automatically plays before the ENDING/rit. [I].

● Fade Out

The Fade Out produces smooth fade-outs when stopping the Style.

Press the [FADE IN/OUT] button during Style playback.

NOTE For details on setting the fade-in and fade-out time, see page 105.

Others

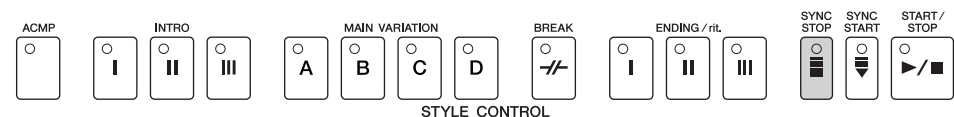

● Synchro Stop

When Synchro Stop is on, you can stop and start the Style anytime you want by simply releasing or playing the keys (in the chord section of the keyboard). This is a great way to add dramatic breaks and accents to your performance.

Press the [SYNC STOP] button before starting the Style playback.

NOTE • **Enable Synchro Stop by pressing/releasing keys (Synchro Stop Window)**

See page 106.

• **Fixing the section pattern to either Intro or Main (Section Set)**

For example, you can set this function to Intro to conveniently have an Intro play automatically whenever you select a Style (page 107).

About the section button (INTRO/MAIN/ENDING, etc.) lamps

- Green
The section is not selected.
- Red
The section is currently selected.
- Off
The section contains no data and cannot be played.

Holding the LEFT part Voice (Left Hold)

This function causes the LEFT part Voice to be held even when the keys are released. Non-decaying voices such as strings are held continuously, while decay-type voices such as piano decay more slowly (as if the sustain pedal has been pressed).

- 1 Press the PART ON/OFF [LEFT] button to turn the left-hand part on.
- 2 Press the [LEFT HOLD] button to turn the Left Hold function on.

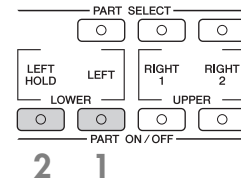

Learning How to Play (Indicate) Chords for Style Playback

Learning the Notes to Play for Certain Chords

If you know the name of a chord but don't know how to play it, you can have the instrument show you the notes to play (Chord Tutor function).

1 Call up the operation display.

[FUNCTION] → [C] STYLE SETTING/SPLIT POINT/CHORD FINGERING → TAB[◀|▶] CHORD FINGERING

2 Press the [6▲▼] button to select the root note.

3 Press the [7▲▼]/[8▲▼] button to select the chord type.

The notes you need to play to make the selected chord are shown in the display.

NOTE The notes that are displayed correspond to Fingering, no matter which fingering type is selected (page 104).

Appropriate Panel Settings for the Selected Style — One Touch Setting

One Touch Setting is a powerful and convenient feature that automatically calls up the most appropriate panel settings (Voices or effects, etc.) for the currently selected Style, with the touch of a single button. If you've already decided which Style you wish to use, you can have One Touch Setting automatically select the appropriate Voice for you.

1 Select a Style (page 46).

2 Press one of the ONE TOUCH SETTING [1]–[4] buttons.

Not only does this instantly call up all the settings (Voices, effects, etc.) that match the current Style — it also automatically turns on ACMP and SYNC START, so that you can immediately start playing the Style.

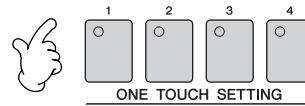

3 As soon as you play a chord with your left hand, the selected Style starts.

NOTE Parameter Lock

You can “lock” specific parameters (e.g., effect, split point, etc.) to make them selectable only via the panel controls (page 133).

Helpful hints for using One Touch Setting

● Automatically changing One Touch Settings with the Main sections (OTS Link)

The convenient OTS (One Touch Setting) Link function lets you automatically have One Touch Settings change when you select a different Main section (A–D). To use the OTS Link function, press the [OTS LINK] button.

● Memorizing the panel settings to the OTS

You can also create your own One Touch Setting setups.

- 1 Set up the panel controls (such as Voice, Style, effects, and so on) as desired.
- 2 Press the [MEMORY] button.
- 3 Press one of the ONE TOUCH SETTING [1]–[4] buttons. As it is possible to save the panel settings with another file (step 4), register it in a favorite number from 1 to 4. A message appears in the display prompting you to save the panel settings.
- 4 Press the [F] (YES) button to call up the Style selection display and save the panel settings as a Style file (page 67).

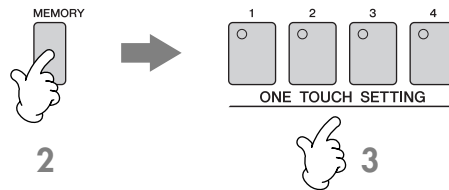

CAUTION

The panel settings memorized to each OTS button will be lost if you change the Style or turn the power off without executing the Save operation.

The Multi Pads

The Multi Pads can be used to play a number of short pre-recorded rhythmic and melodic sequences that can be used to add impact and variety to your keyboard performances. Multi Pads are grouped in Banks or four each. The PSR-OR700 features a variety of Multi Pad Banks in a variety of different musical genres.

Playing the Multi Pads

- 1 Press the **MULTI PAD CONTROL [SELECT]** button to call up the Multi Pad Bank selection display, then select the desired Bank.

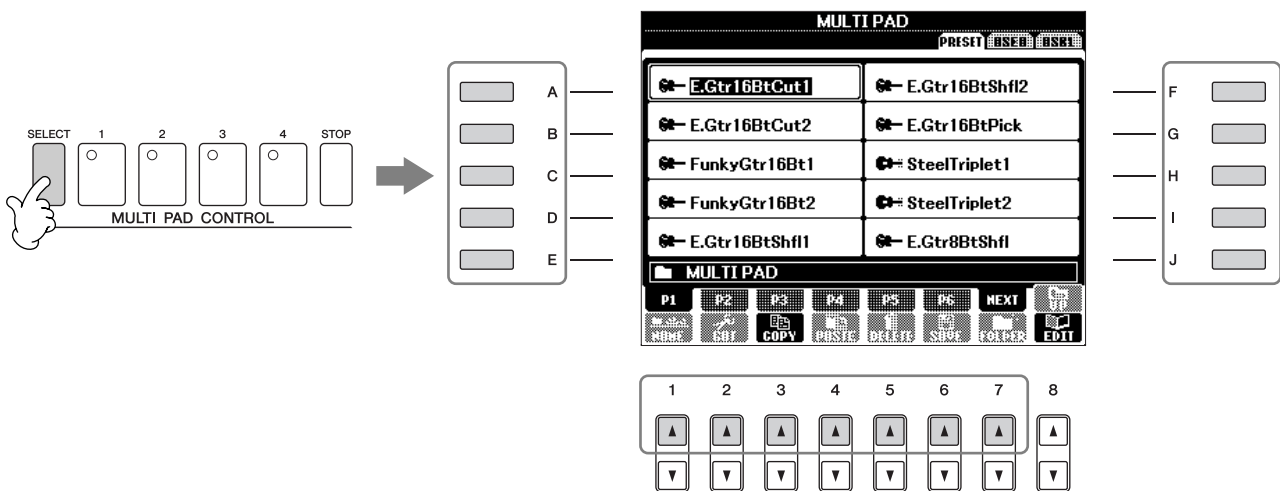

Select pages using the [1 ▲]–[7 ▲] buttons that correspond to “P1, P2...” in the display, then use the [A]–[J] buttons to select the desired bank.

- 2 Press any of the **MULTI PAD CONTROL [1]–[4]** buttons to play the Multi Pad phrase.

The corresponding phrase (in this case, for Pad 1) starts playing back in its entirety as soon as the pad is pressed. To stop it, press and release the [STOP] button.

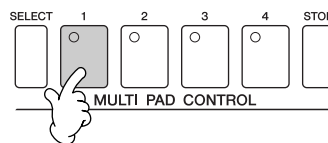

Simply tap any of the Multi Pads at any time to play back the corresponding phrase at the currently set tempo. You can even play two, three, or four Multi Pads at the same time. Pressing the pad during its playback will stop playing and begin playing from the top again.

● About the color of the Multi Pads

- Green: Indicates that the corresponding pad contains data (phrase).
- Red: Indicates that the corresponding pad is playing back.

● Multi Pad data

There are two types of Multi Pad data. Some types will play back once and stop when they reach to the end. Others will play back repeatedly until you press the [STOP] button.

● Stopping playback of the Multi Pads

- To stop all pads, press and release the [STOP] button.
- To stop specific pads, simultaneously hold down the [STOP] button and press the pad or pads you wish to stop.

Using Chord Match

Many of the Multi Pad phrases are melodic or chordal and you can have these phrases automatically change chords as you do with your left hand. While a style is playing back and [ACMP] is on, simply play a chord with your left hand and press any of the Multi Pads — Chord Match changes the pitch to match the chords you play. You can also use this with the style stopped (with the Stop Accompaniment function). Keep in mind that some Multi Pads are not affected by Chord Match.

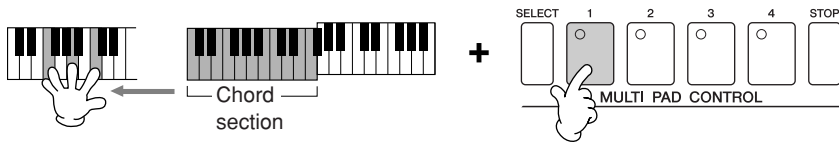

In this example, the phrase for Pad 1 will be transposed into F major before playing back. Try out other various chord types while playing the Multi Pads.

Voice Effects

The PSR-OR700 features a sophisticated multi-processor effect system which can add extraordinary depth and expression to your sound. This effect system can be turned on or off by using the following buttons.

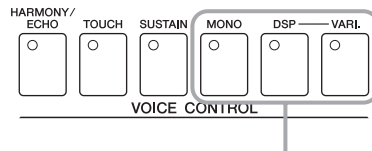

These three effect systems are applied to the currently selected keyboard part (RIGHT 1, 2, or LEFT).

- **HARMONY/ECHO**
The Harmony/Echo types are applied to the right-hand Voices. Refer to “Applying Harmony to Your Right-hand Melody” on page 54.
- **TOUCH**
This button turns the touch response of the keyboard on or off. When OFF, the same volume is produced no matter how strongly or softly you play the keyboard.
- **SUSTAIN**
When this Sustain function is on, all notes played on the keyboard (RIGHT 1/2 parts only) have a longer sustain. You can also set the sustain depth (page 95).
- **MONO**
When this button is on, the part’s Voice is played monophonically (only one note at a time). Using the MONO mode lets you play single, lead sounds (such as brass instruments) more realistically. It also lets you expressively control the Portamento effect (depending on the selected Voice) by playing legato. When this button is off, the part’s Voice played polyphonically.
- **DSP/DSP VARI.**
With the digital effects built into the instrument, you can add ambience and depth to your music in a variety of ways — such as adding reverb that makes you sound like you are playing in a concert hall.
 - The DSP switch is used to turn the DSP (Digital Signal Processor) effect on or off for the currently selected keyboard part.
 - The DSP VARI. (Variation) switch is used to change between variations of the DSP effect. You could use this while you play, for example, to change the rotating speed (slow/fast) of the rotary speaker effect.

NOTE **DSP**

Stands for Digital Signal Processor (or Processing). DSP changes and enhances the audio signal in the digital realm to produce a wide range of effects.

Applying Harmony to Your Right-hand Melody (HARMONY/ECHO)

Among the Voice Effects, Harmony is one of the most impressive. It automatically adds harmony parts to the notes you play with your right hand — immediately giving you a more full and professional sound. For details on the Harmony/Echo types, see page 82. An optional foot pedal can also be used to turn the effect on and off (page 168).

- 1 Turn the [Harmony/Echo] button on.
- 2 Turn on both the [ACMP] button and [SYNC START] button (page 47) and make sure that the RIGHT 1 part is on (page 30).
- 3 Play a chord with your left hand to start the style (page 47) and play some notes in the right-hand range of the keyboard.

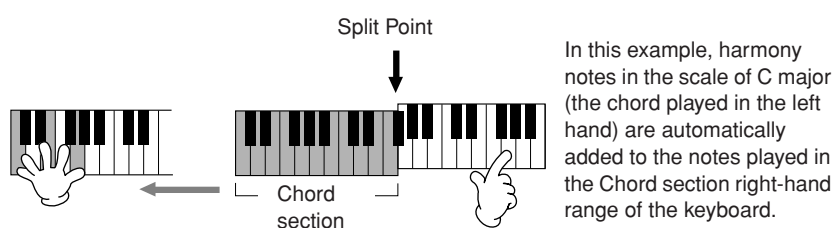

You can also use the Harmony effect with the style stopped (with the Stop Accompaniment function; page 106). Simply hold down a chord with your left hand and play a melody with your right. Since the Harmony effect is added by detecting chords, if you play a melody with your right hand before playing any chord, no Harmony effect is added to the notes.

Try out Harmony/Echo with some of the voices below...

Many of the voices have been automatically set to play certain Harmony/Echo types that match the particular voice. Try out some of the voices below — playing chords with your left hand and melodies with your right — and listen to the various Harmony and Echo effects.

Category	Voice Name	Harmony/Echo Type
Piano	Live! GrandPiano	Standard Trio
Accordion & Harmonica	TuttiAccordion	Country Trio
Strings	Live! Strings	Block
	ChamberStrings	4-way Open
	Harp	Strum
Guitar & Bass	Cool! PowerLead	RockDuet
	Cool! ElectricGtr	CountryDuet
Perc. & Drum Kit	Vibraphone	Trill
	Timpani	Tremolo

Calling Up Ideal Setups for Each Song (Music Finder)

If you want to play in a certain genre of music but don't know which Style and Voice settings would be appropriate, the convenient Music Finder function can help you out. Simply select the desired music genre from among the Music Finder "Records," and the instrument automatically makes all appropriate panel settings to let you play in that music style. A new record can be created by editing the currently selected one (page 111).

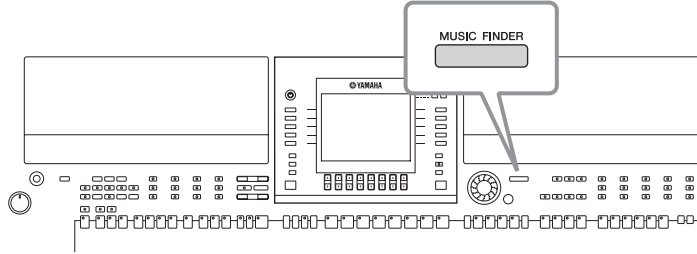

NOTE The data (records) of the Music Finder are not the same as Song data and cannot be played back.

1 Press the [MUSIC FINDER] button to call up the MUSIC FINDER display.

MUSIC	STYLE	BEAT	TEMPO
60 Second Waltz	VienneseWaltz	3/4	240
69 Summers Long	PowerRock	4/4	130
A Bridge To Cross Troub~	PowerBallad	4/4	78
A Cosy Life In Italy	OrganBallad	4/4	88
A Day's Difference	70'sTVTheme	4/4	126
A Feeling Of Love Tonig~	MovieBallad	4/4	68
A Nickel In The Nickelod~	Dixieland	4/4	214
A Night In A Wonderful L~	6-8Orchestral	6/8	72
A Sad Song To Make Ju~	LoveSong	4/4	70
A Song For New England	VintageGtrPop	4/4	152
A Spy Does It Better	PianoBallad	4/4	70
A Spy Lives Only Twice	SecretService	4/4	80
Abide This Hymn	ClassicPiano~	4/4	72
Acapulco Swings In The ~	Tijuana	4/4	200

2 Press the TAB [◀][▶] buttons to select the ALL tab.

The ALL tab contains the preset records.

3 Select the desired record by using the following four search categories. To select a record, press the [2▲▼]/[3▲▼] buttons

- NOTE** You can also select the desired record by using the DATA ENTRY dial, then press the [ENTER] button to execute.
- Searching the records**
The Music Finder is also equipped with a convenient search function that lets you enter a song title or keyword — and instantly call up all the records that match your search criteria (page 108).

- MUSIC**Contains the song title or music genre that describes each record, letting you easily find the desired music style.
 - NOTE** **Skipping up or down through the song alphabetically**
When sorting records by song title, use the [1▲▼] button to skip up or down through the songs alphabetically. Simultaneously press the [▲▼] buttons to move the cursor to the first record.
- STYLE**..... This is the preset Style assigned to the record.
 - NOTE** **Skipping up or down through the Style alphabetically**
When sorting records by Style name, use the [4▲▼]/[5▲▼] button to skip up or down through the Styles alphabetically. Simultaneously press the [▲▼] buttons to move the cursor to the first record.
- BEAT** This is the time signature registered to each record.
- TEMPO** This is the assigned tempo setting for the record.

4 Play the keyboard.

Notice that the panel settings have been automatically changed to match the music genre of the selected record.

- **Tempo Lock**
Tempo Lock function lets you avoid changing the Tempo during Style playback when selecting another record. To turn on the Tempo Lock function, press the [I] (TEMPO LOCK) button in the Music Finder display.
- **Parameter Lock**
You can “lock” specific parameters (e.g., effect, split point, etc.) to make them selectable only via the panel controls (page 133).

Calling up the panel settings to match the Style (Repertoire)

The convenient Repertoire function automatically calls up the most appropriate panel settings (voice number, etc.) for the currently selected Style.

1 Select the desired Style for which you want to call up the panel settings from the “PRESET”/“USER” tab on Style selection display.

NOTE The Repertoire function is valid for Styles in the “PRESET”/“USER” tab. The Repertoire function cannot be used for Styles saved to a USB storage device. To use the Repertoire function, save the desired Style in “USER” tab.

2 Press the [7▲] (REPertoire) button.

The panel settings that match the Style under selection is searched according to the record group of the Music Finder. The list of the search results is shown on the “SEARCH 2” display of the Music Finder.

CAUTION

When the result of searching the record in the “SEARCH 2” display has already been shown, the searched result is lost.

3 Press the [2▲▼]–[3▲▼] buttons to select the desired panel settings.

Sorting the records

Press the [F] (SORT BY) button to sort the records.

- MUSIC The record is sorted by song title.
- STYLE The record is sorted by Style name.
- BEAT The record is sorted by beat.
- TEMPO The record is sorted by tempo.

Changing the order of the records

Press the [G] (SORT ORDER) button to change the order of the records (ascending or descending).

Singing Along with Song Playback (Karaoke) or Your Own Performance

If the selected song has lyric data, you can have the lyrics shown in the display by playing back the song. Sing the song while viewing the lyrics on the display.

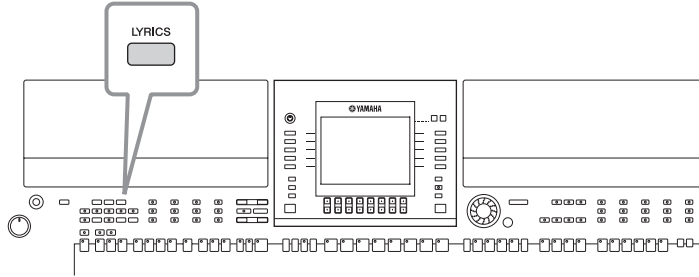

Singing with the Lyrics Display

Try singing while playing back a Song containing lyric data

1 Select a Song (page 36).

2 Press the [LYRICS] button to display the lyrics.

3 Press the SONG [▶ / ⏸] (PLAY/PAUSE) button to start playback.

Sing while following along with the lyrics on the display. The color of the lyrics changes as the Song plays.

4 Press the SONG [■] (STOP) button to stop playback.

- NOTE**
- **When the lyrics are unreadable**
You may need to change the Lyrics Language setting to “International” in the Song Setting display ([FUNCTION] → [B] SONG SETTING), if the lyrics shown are garbled or unreadable. This setting can be memorized as part of the Song data (page 162).
 - **Changing the lyrics**
You can change the lyrics as desired (page 166).

Convenient Functions for Karaoke

Adjusting the tempo	➤	page 34
Transpose	➤	See below.

Transpose

You can use this to adjust the key of the Song if it is too high or low.

- Transposing the Song key up..... Press the TRANSPOSE [+] button.
- Transposing the Song key down..... Press the TRANSPOSE [-] button.
- Resetting the transposition Press the TRANSPOSE [+][-] buttons simultaneously.

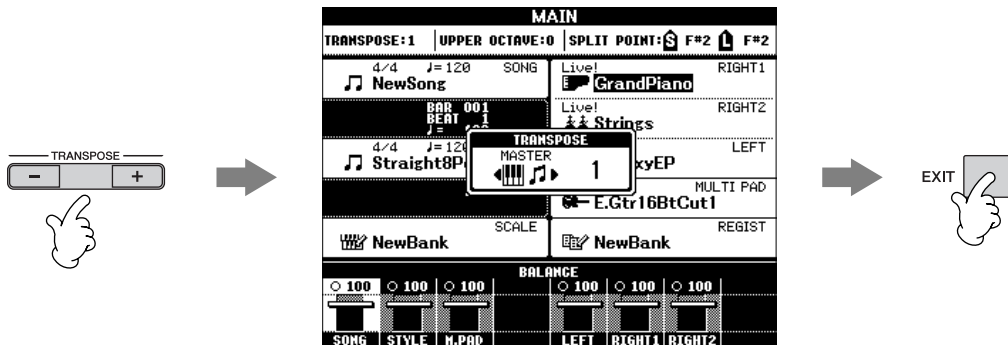

NOTE Selecting an effect type
You can select the effect type in the Mixing Console (page 88).

Convenient Functions for Singing Along with Your Own Performance

Changing the Key (Transpose)

You can match both the Song and your keyboard performance to a certain key. For example, the Song data is in F, but you feel most comfortable singing in D, and you are accustomed to playing the keyboard part in C. To match up the keys, set the Master Transpose to "0," the Keyboard Transpose to "2," and the Song Transpose to "-3." This brings the keyboard part up and the song data down to your desired singing key.

1 Call up the operation display.

[FUNCTION] → [D] CONTROLLER → TAB [◀][▶] KEYBOARD/PANEL → [B] TRANSPOSE ASSIGN

2 Press the [4▲▼]/[5▲▼] button to select the desired transpose type.

The following types are available. Select the one most suited to your purpose.

● KEYBOARD

Transpose pitch of the keyboard played Voices and Style playback (controlled by what you play in the chord section of the keyboard).

● SONG

Transposes the pitch of Song playback.

● MASTER

Transpose the overall pitch of the instrument.

3 Press the TRANSPOSE [-]/[+] button to transpose.

You can set the value in semitone steps.

To reset the transpose value, press the [+][-] buttons simultaneously.

4 Press the [EXIT] button to close the TRANSPOSE display.

Setting an Oriental Scale

The Scale Setting feature lets you easily lower the pitches of specific notes by 50 cents to create your own oriental scales. Up to six scale settings can be stored for instant recall (Scale Memory), whenever you need them.

NOTE For details on scale tuning, see page 99.

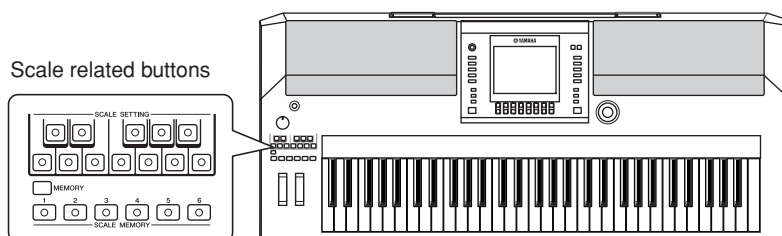

1 The [SCALE SETTING] buttons simulate an one-octave keyboard (C through B). Press the button corresponding to the key whose pitch you want to lower (the button lights). Press again to return to normal pitch.

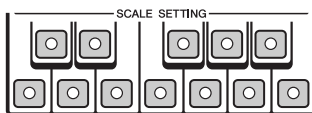

2 The scale settings you set are memorized by the Scale Memory function.

While holding the [MEMORY] button, press one of the SCALE MEMORY buttons. You can recall the memorized setting by pressing the appropriate button at any time.

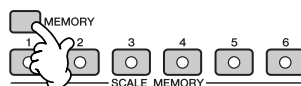

- NOTE** • To maintain the memorized scale settings even after the power is turned off, make sure to save the settings as a file (page 101).
- In the SCALE TUNE display, you can select a desired scale template including oriental scales and create your own scales by fine tuning the scale notes (page 99).

The language selected here is also used for various “Messages” shown during operations.

Selecting Message Language

You can select the desired language of the display messages.

- 1 Call up the operation display.
[FUNCTION] → [J] UTILITY → TAB [◀][▶] OWNER
- 2 Use [4▲▼]/[5▲▼] (LANGUAGE) buttons to select the language.
- 3 Press the [EXIT] button to return to the previous display.

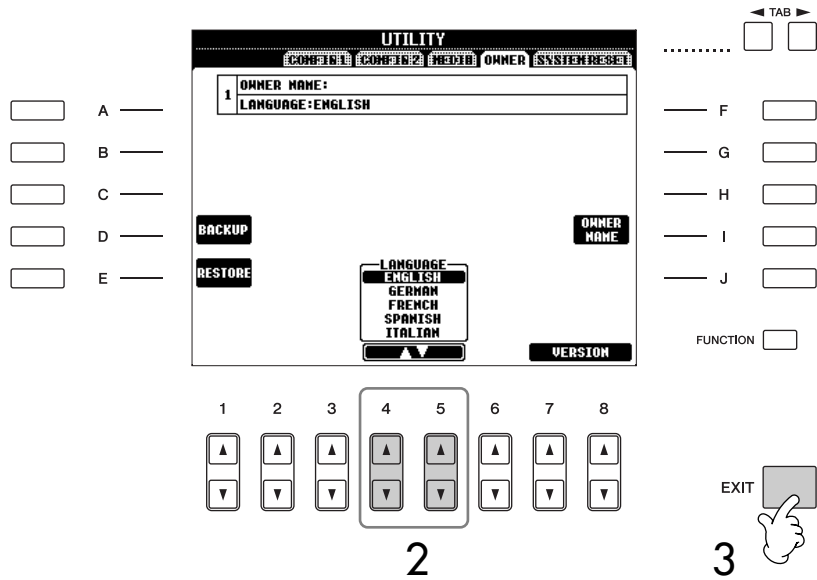

The Messages Shown in the Display

A message (information or confirmation dialog) sometimes appears on the screen to facilitate operation. When the message appears, simply press the appropriate button.

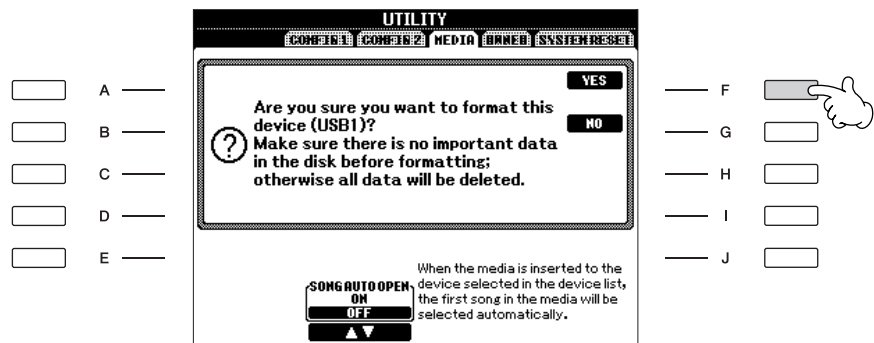

In this example, press the [F] (YES) button to start formatting the USB storage device (USB flash memory, floppy disk, etc.).

Instant Selection of the Displays — Direct Access

With the convenient Direct Access function, you can instantly call up the desired display — with just a single additional button press.

- 1 **Press the [DIRECT ACCESS] button.**
A message appears in the display prompting you to press the appropriate button.
- 2 **Press the button corresponding to the desired setting display to instantly call up that display.**
Refer to the Data List for a list of the displays that can be called up with the Direct Access function. The Data List is available at the Yamaha website. (See page 5.)

Example of calling up the Guide function display

Press the [DIRECT ACCESS] button, then press the [GUIDE] button.

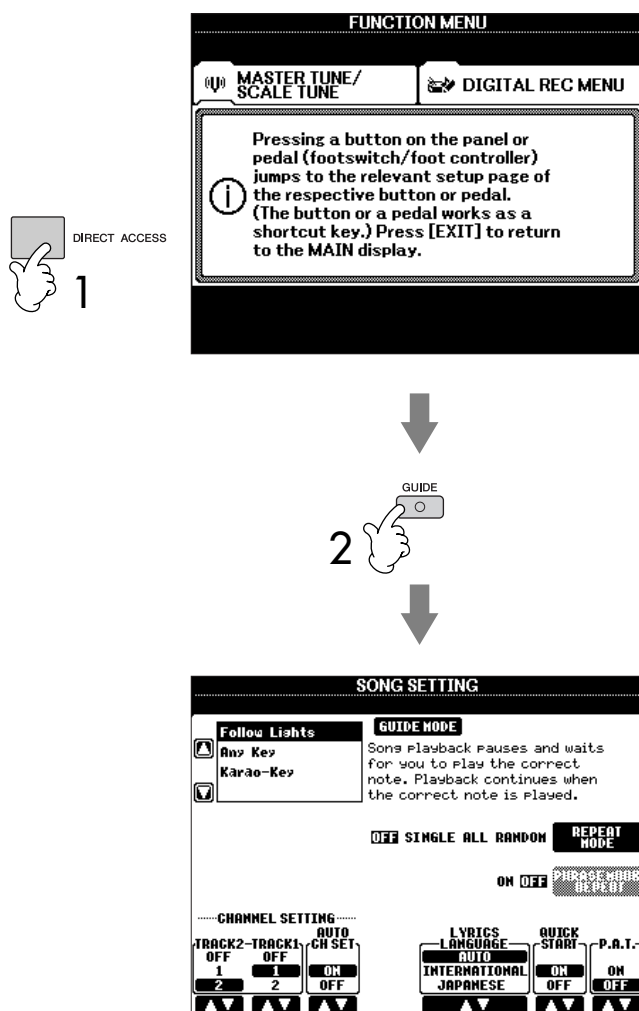

Returning to the Main display

Here's a convenient way to return to the Main display from any other display: Simply press the [DIRECT ACCESS] button, then the [EXIT] button.

Basic Displays (Main Display and File Selection Display)

There are two basic display types – Main and Selection. Here are explanations of each display segment and its basic operation.

Main Display

The Main display shows the current basic settings of the instrument such as the currently selected Voice and Style, allowing you to see them at a single glance. The Main display is the one you'll usually see when you play the keyboard.

Returning to the Main display

Here's a convenient way to return to the Main display from any other display: Simply press the [DIRECT ACCESS] button, then the [EXIT] button.

Basic Operation

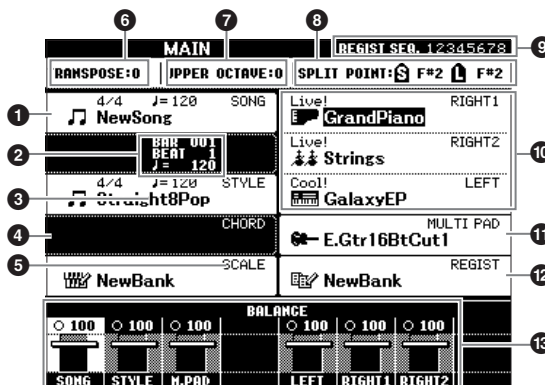

1 Song name and related information

Displays the currently selected Song name, time signature and tempo. If the Song contains the chord data, the current chord name will be displayed in the "CHORD" segment (see 4 below). Pressing the [A] button calls up the Song Selection display (page 36).

2 BAR/BEAT/Tempo

Displays either the current position and tempo of the Song or the current bar and beat number of Style playback.

3 Style name and related information

Displays the currently selected Style name, time signature and tempo. Pressing the [C] button calls up the Style Selection display (page 46).

4 Current chord name

If the [ACMP] button is set to On, the chord specified in the chord section of the keyboard will be displayed.

5 Scale Tune Bank name

Displays the currently selected Scale Tune Memory.

6 Transpose

Displays the amount of transposition in semitone units (page 58).

7 Octave

The [UPPER OCTAVE] buttons allow the pitch of the keyboard to be shifted down or up in octave steps. This shows the amount that the octave value is shifted.

8 Split Point

Split Points are specific positions (notes) on the keyboard that divide the keyboard into separate sections. There are two kinds of Split Points: "S", which separates the chord section from the rest of the keyboard, and "L", which divides the left-hand and right-hand sections.

9 Registration Sequence

Appears when the Registration Sequence is active (page 134).

10 Voice name

- RIGHT 1 (indicated at the right edge of the display):
Voice name currently selected for the RIGHT 1 part (page 78).
- RIGHT 2 (indicated at the right edge of the display):
Voice name currently selected for the RIGHT 2 part (page 78).
- LEFT (indicated at the right edge of the display):
Voice name currently selected for the LEFT part (page 78).

When the Left Hold function is ON, an "H" indication appears (page 50).

Pressing one of the [F], [G] and [H] buttons calls up the Voice Selection display for each part (page 31).

11 Multi Pad Bank name

Indicates the names of the selected Multi Pad Banks (page 128). Pressing the [I] button calls up the Multi Pad Bank Selection display (page 129).

12 Registration Memory Bank name

Displays the currently selected Registration Memory Bank name.

Pressing the [J] button calls up the Registration Memory Bank Selection display (page 132).

When the Freeze function is ON, an "F" indication appears (page 134).

13 Volume Balance

Displays the volume balance among the parts.

Adjust the volume balance among the parts by using the [1 ▲ ▼]–[8 ▲ ▼] buttons.

File Selection Display Configuration and Basic Operation

The File Selection display appears when you press one of the buttons shown below. From here you can select Voices, Styles, and other data.

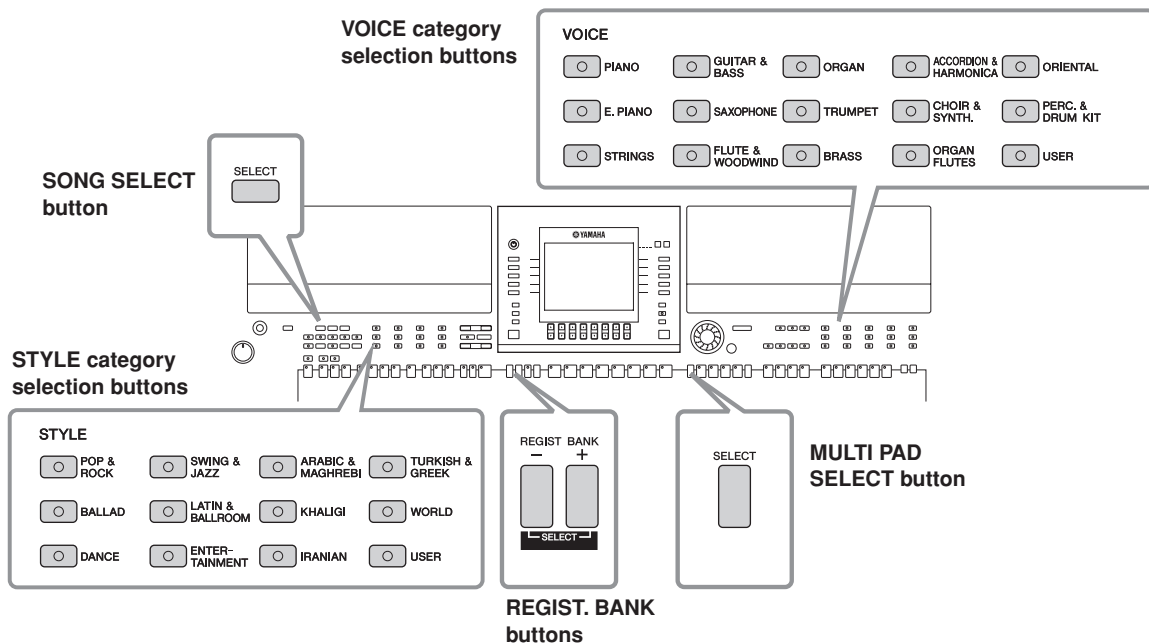

File Selection Display Configuration

• Location (drive) of data

Preset

Location where pre-programmed (preset) data is stored.



User

Location where recorded or edited data is saved.

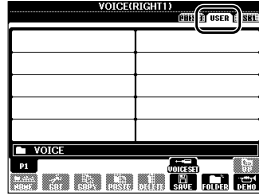

USB

Location where data on USB storage device (USB flash memory, floppy disk, etc.) is saved.

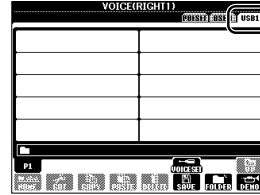

Hereafter in this manual, any USB storage device such as USB flash memory, floppy disk drive, etc. will be referred to as "USB storage device."

• Data files and folders

The data, both pre-programmed and your own original, are saved as "files." You can drop files into a folder.

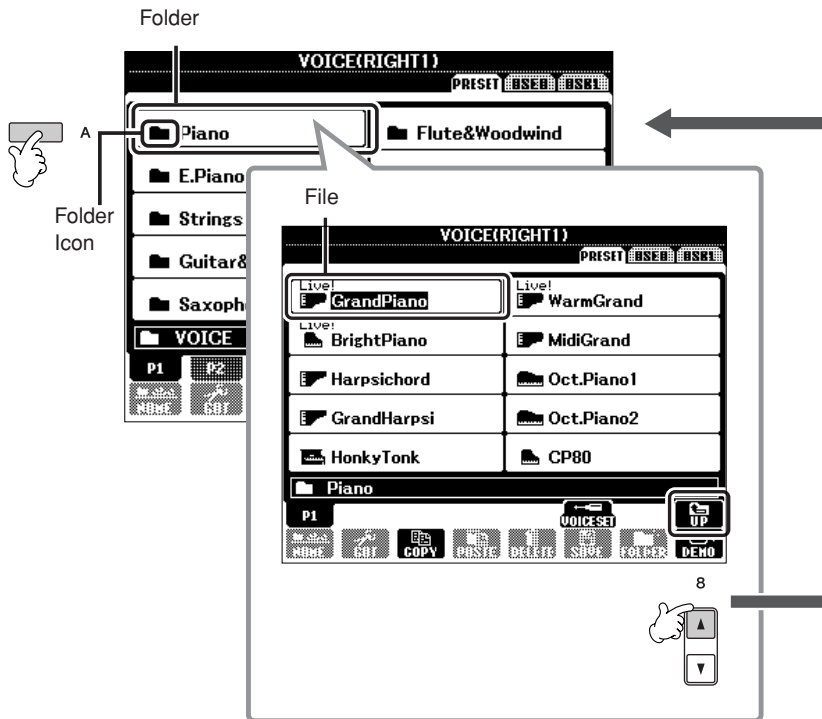

File Selection Display Basic Operation

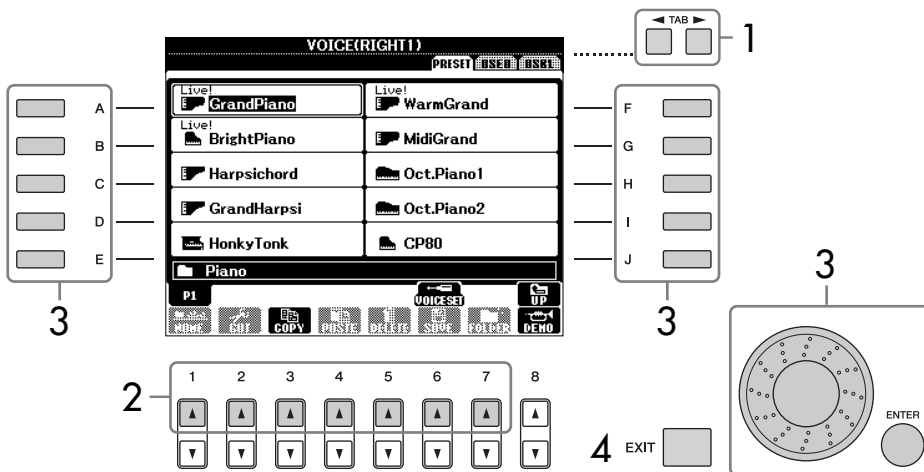

- 1 Select the tab containing the desired file by using the TAB [◀][▶] buttons.
- 2 Select the page containing the desired file by using the [1▲]–[7▲] buttons.
- 3 Select the file. There are two ways to do so.
 - Press one of the [A]–[J] buttons.
 - Select the file by using the DATA ENTRY dial, then press the [ENTER] button to execute.
- 4 Press the [EXIT] button to return to the previous display.

Selecting a file saved to the USB storage device.

You can also select a specified file in the USB storage device by pressing the [USB] button.
 [USB] → [A] SONG/[B] STYLE/[F] VOICE/[G] MULTI PAD → [A]–[J]

The number of pages shown varies depending on the selection display of the Voices/Songs/Styles. Press the corresponding button to “P1, P2 ...” in the display. When other pages follow, the “NEXT” button appears, and for the previous page, the “PREV” button appears.

Closing the current folder and calling up the next highest level folder

To close the current folder and call up the next highest level folder, press the [8▲] (UP) button.

Example of the PRESET Voice Selection display

The PRESET Voice files are categorized and contained in appropriate folders.



This display shows the Voice files in a folder.



The next highest level — in this case, folder — is shown. Each folder shown in this display contains appropriately categorized Voices.

File/Folder Operations in the File Selection Display

- Saving Files page 67
- Copying Files/Folders (Copy & Paste)..... page 68
- Moving Files (Cut & Paste)..... page 69
- Deleting Files/Folders..... page 69
- Renaming Files/Folders..... page 70
- Selecting Custom Icons for Files (shown at the left of file name) page 70
- Creating a New Folder page 71
- Entering characters..... page 71

Formatting USB storage media

When a USB storage device is connected or media is inserted, a message may appear prompting you to format the device/media. If so, execute the format operation.

⚠ CAUTION

The format operation deletes any previously existing data. Make sure that the media you are formatting does not contain important data. Proceed with caution, especially when connecting multiple USB storage medias.

- 1 Insert a USB storage device for formatting into the [USB TO DEVICE].
- 2 Call up the operation display.
[FUNCTION] → [J] UTILITY → TAB [◀][▶] MEDIA
- 3 Press the [A]/[B] buttons to select the USB device to be formatted from the device list.
- 4 Press the [H] button to format the device/media.

The indications USB 1, USB 2, etc. will be displayed depending on the number of the connected devices.



- A —
- B —
- C —
- D —
- E —

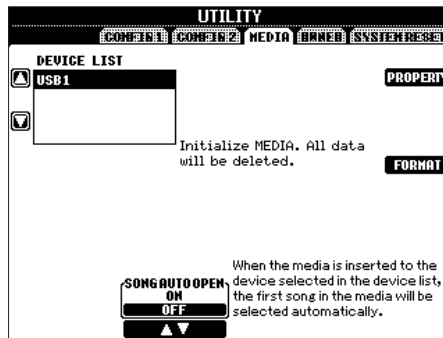

- F —
- G —
- H — 4
- I —
- J —

Saving Files

This operation lets you save your original data (such as Songs and Voices you've created) to a file.

- 1 After you've created a Song or Voice in the relevant SONG CREATOR or VOICE SET display, press the [SAVE] display button. The File Selection display for the corresponding data appears. Keep in mind that the Save operation is executed from the File Selection display.

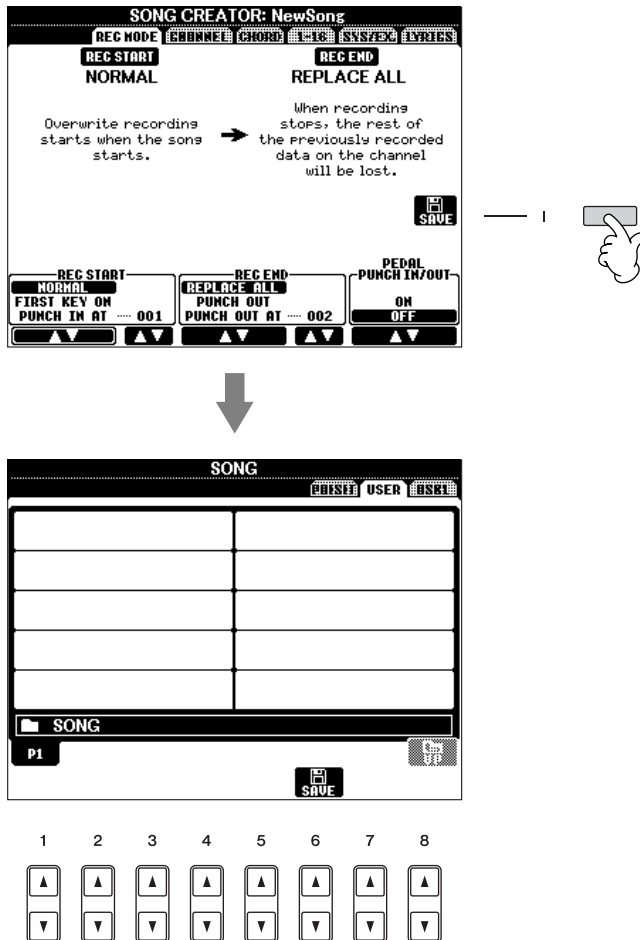

- 2 Select the appropriate tab (USER, USB, etc.) to which you want to save the data by using the TAB [◀][▶] buttons.
- 3 Press the [6 ▼] (SAVE) button to call up the file naming display.



- 4 Enter the file name (page 71).
- 5 Press the [8 ▲] (OK) button to save the file. If you want to cancel the Save operation, press the [8 ▼] (CANCEL) button. The saved file will be automatically located at the appropriate position among the files in alphabetical order.

Internal memory (User tab displays) capacity

The internal memory capacity of the instrument is about 560KB. This capacity applies to all file types, including Voice, Style, Song, and Registration data files.

Restrictions for protected Songs

Commercially available song data may be copy protected to prevent illegal copying or accidental erasure. They are marked by the indications at the upper left side of the file names. The indications and relevant restrictions are detailed below.

Prot. 1	Indicates Preset Songs saved to the User tab display, Disk Orchestra Collection (DOC) Songs, and Disklavier Piano Soft Songs. These cannot be copied/moved/saved to USB storage device.
Prot. 2 Orig	Indicates Yamaha-protection-formatted Songs. These cannot be copied. These can be moved/saved only to the USER tab display and USB storage device.
Prot. 2 Edit	Indicates edited "Prot. 2 Orig" Songs. Make sure to save these to the same folder containing the corresponding "Prot. 2 Orig" Song. These cannot be copied. These can be moved/saved only to the USER tab display and USB storage device.

Note for "Prot. 2 Orig" and "Prot. 2 Edit" Song file operation

Make sure to save the "Prot. 2 Edit" Song to the same folder containing its original "Prot. 2 Orig" Song. Otherwise the "Prot. 2 Edit" Song cannot be played back. Also, if you move a "Prot. 2 Edit" Song, be sure to move its original "Prot. 2 Orig" Song to the same location (folder) at the same time.

Copying Files/Folders (Copy & Paste)

This operation lets you copy a file/folder and paste it to another location (folder).

- 1 Call up the display containing the file/folder you want to copy.
- 2 Press the [3 ▼] (COPY) button to copy the file/folder.
The pop-up window for the Copy operation appears at the bottom of the display.

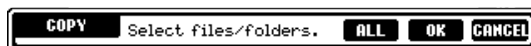

- 3 Press one of the [A]–[J] buttons corresponding to the desired file/folder.
To cancel the selection, press the same [A]–[J] button again.
 - **Selecting all files/folders**
Press the [6 ▼] (ALL) button to select all files/folders indicated on the current display including the other pages.
To cancel the selection, press the [6 ▼] (ALL OFF) button again.
- 4 Press the [7 ▼] (OK) button to confirm the file/folder selection.
To cancel the Copy operation, press the [8 ▼] (CANCEL) button.
- 5 Select the destination tab (USER, USB) to paste the file/folder, by using the TAB [◀][▶] buttons.
- 6 Press the [4 ▼] (PASTE) button to paste the file/folder.
The folder/file copied and pasted appears on the display at the appropriate position among the files in alphabetical order.

Moving Files (Cut & Paste)

This operation lets you cut a file and paste it to another location (folder).

- 1 Call up the display containing the file you want to move.
- 2 Press the [2 ▼] (CUT) button to cut the file.
The pop-up window for the Cut operation appears at the bottom of the display.



- 3 Press one of the [A]–[J] buttons corresponding to the desired file.
To cancel the selection, press the same [A]–[J] button again.

■ Selecting all files

Press the [6 ▼] (ALL) button to select all files indicated on the current display including the other pages.
To cancel the selection, press the [6 ▼] (ALL OFF) button again.

- 4 Press the [7 ▼] (OK) button to confirm the file selection.
To cancel the Cut operation, press the [8 ▼] (CANCEL) button.
- 5 Select the destination tab (USER, USB) to which the file is to be pasted, by using the TAB [◀][▶] buttons.
- 6 Press the [4 ▼] (PASTE) button to paste the file.
The file moved and pasted appears on the display at the appropriate position among the files in alphabetical order.

Deleting Files/Folders

This operation lets you delete a file/folder.

- 1 Call up the display containing the file/folder you want to delete.
- 2 Press the [5 ▼] (DELETE) button.
The pop-up window for the Delete operation appears at the bottom of the display.

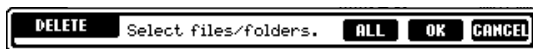

- 3 Press one of the [A]–[J] buttons corresponding to the desired file/folder.
To cancel the selection, press the same [A]–[J] button again.
■ Selecting all files/folders
Press the [6 ▼] (ALL) button to select all files/folders indicated on the current display including the other pages.
To cancel the selection, press the [6 ▼] (ALL OFF) button again.
- 4 Press the [7 ▼] (OK) button to confirm the file/folder selection.
To cancel the Delete operation, press the [8 ▼] (CANCEL) button.
- 5 Follow the on-display instructions.
YESDelete the file/folder
YES ALLDelete all selected files/folders
NOLeave the file/folder as is without deleting
CANCELCancel the Delete operation

Deleting all data in a USB storage device at once
Formatting a USB storage device completely erases all data on the USB storage device (page 66).

Renaming Files/Folders

This operation lets you rename files/folders.

- 1 Call up the display containing the file/folder you want to rename.
- 2 Press the [1 ▼] (NAME) button.
The pop-up window for the Rename operation appears at the bottom of the display.

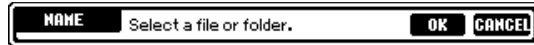

- 3 Press one of the [A]–[J] buttons corresponding to the desired file/folder.
- 4 Press the [7 ▼] (OK) button to confirm the file/folder selection.
To cancel the Rename operation, press the [8 ▼] (CANCEL) button.
- 5 Input the name (characters) of the selected file or folder (page 71).
The renamed folder/file appears on the display at the appropriate position among the files in alphabetical order.
- 6 Press the [8 ▲] (OK) button to actually enter the new name.

Selecting Custom Icons for Files (Shown at the Left of File Name)

You can select custom icons for files (shown at the left of file name).

- 1–4 Operations are the same as the above “Renaming Files/Folders” section.
- 5 Press the [1 ▼] (ICON) button to call up the ICON display.
- 6 Select the icon by using the [A]–[J] buttons or [3 ▲ ▼]–[5 ▲ ▼] buttons.
The ICON display includes several pages. Press the TAB [◀][▶] buttons to select different pages.
To cancel the operation, press the [8 ▼] (CANCEL) button.
- 7 Press the [8 ▲] (OK) button to apply the selected icon.
- 8 Press the [8 ▲] (OK) button to actually enter the new name.

Creating a New Folder

This operation lets you create new folders. Folders can be created, named and organized as desired, making it easier to find and select your original data.

- 1 Call up the page of the File Selection display for which you wish to create a new folder.
- 2 Press the [7▼] (FOLDER) button to call up the naming display for a new folder.



- 3 Input the name of the new folder (see below).

Entering Characters

The instructions that follow show you how to enter characters in naming your files/folders and when inputting the Keyword for Music Finder function/website. The method is much the same as inputting names and numbers to a conventional mobile phone. Entering characters should be done in the display shown below.

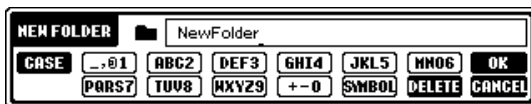

- 1 Change the type of character by pressing the [1▲] button.
 - The following different types of characters are available:
 - CASE.....Alphabet (capital letters, half size), numbers (half size), marks (half size)
 - case.....Alphabet (lowercase letters, half size), numbers (half size), marks (half size)
- 2 Use the DATA ENTRY dial to move the cursor to the desired position.
- 3 Press the [2▲▼]-[6▲▼] and [7▲] buttons, corresponding to the character you wish to enter.

Entering letters, numerals and symbols can be done by moving the cursor or pressing one of the character entry buttons. Alternately, you can wait for a short time and the characters will be entered automatically.

For details on entering characters, refer to the following section, step 4.

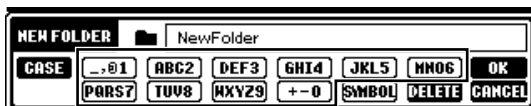

Several different characters are assigned to each button, and the characters change each time you press the button.

A new folder cannot be made in the PRESET tab.

Folder directories for the USER tab display

In the USER tab display, folder directories can contain up to four levels. The maximum total number of files and folders which can be stored is 363, but this may differ depending on the length of the file names. The maximum number of files/folders which can be stored in a folder in the USER tab is 250.

Depending on the display for character entry you are working in, some types of characters cannot be entered.

The following half-size marks cannot be entered for a file/folder name.
 \ / : * ? " < > |

4 Press the [8▲] (OK) button to actually enter the new name and return to the previous display.

- **Deleting characters**

Move the cursor to the character you wish to delete by using the DATA ENTRY dial, and press the [7▼] (DELETE) button. To delete all characters on the line at once, press and hold the [7▼] (DELETE) button.

- **Entering marks**

- 1 After actually entering a character by moving the cursor, press the [6▼] button to call up the mark list.
- 2 Use the DATA ENTRY dial to move the cursor to the desired mark, then press the [8▲] (OK) button.

- **Entering numbers**

First, select one of the following: "ABC" "CASE" (half-size capital alphabet) and "case" (half-size lowercase alphabet). Then, press and hold down the appropriate button, [2▲▼]–[5▲▼], [6▲] and [7▲] button, for a while, or press it repeatedly until the desired number is selected.

- **Inserting a Character**

- 1 Move the cursor to the desired position.
Use the same operation as in "Deleting Characters" above.
- 2 Press the [2▲▼]–[6▲▼], or [7▲] buttons to enter numbers and symbols.
- 3 Press the [8▲] (OK) button to enter characters.

- **Entering a Space**

- 1 Move the cursor to the desired position.
Use the same operation as in "Deleting Characters" above.
- 2 Press [6▼] button to call up the mark list.
- 3 Make sure the cursor is at the beginning space (blank) of the mark list, and press the [8▲] (OK) button.

Restoring the Factory-programmed Settings

Restoring the Factory-programmed System

While holding the C6 key (right-most key on the keyboard), turn the [POWER] button ON.

This operation has the same result as and is a shortcut for the System Setup restore operation explained in step 2 of the following section.

Restoring the Factory-programmed Settings Independently by Item

- 1 **Call up the operation display.**
[FUNCTION] → [J] UTILITY → TAB [◀][▶] SYSTEM RESET

CAUTION

This operation deletes all your original data for the respective item (MIDI SETUP, USER EFFECT, MUSIC FINDER, and FILES&FOLDERS).

2 Select items by pressing the [1▲▼]-[3▲▼] buttons.

SYSTEM SETUP	Restores the System Setup parameters to the original factory settings. Refer to the Data List for details about which parameters belong to the System Setup. The Data List is available at the Yamaha website. (See page 5.)
MIDI SETUP	Restores the MIDI settings including the MIDI templates on the User tab display to the original factory status.
USER EFFECT	Restores the User Effect settings including the user effect types and user master EQ types created via the Mixing Console display to the original factory settings.
MUSIC FINDER	Restores the Music Finder data (all records) to the original factory settings.
FILES&FOLDERS	Deletes all files and folders stored in the User tab display.
REGIST	Temporarily deletes the current Registration Memory settings of the selected Bank. The same can be done also by turning the [POWER] button ON while holding the B5 key (right-most B key on the keyboard).

The screenshot shows the 'UTILITY' menu with the 'SYSTEM RESET' option selected. The screen displays a list of items to be reset: SYSTEM SETUP, MIDI SETUP, USER EFFECT, MUSIC FINDER, FILES&FOLDERS, and REGIST. A 'FACTORY RESET EXECUTE' button is visible. A 'CAUTION!' warning states that all user files and folders are lost when 'FILES&FOLDERS' is selected and Factory Reset is executed. A keyboard diagram below shows buttons 1-8 with up/down arrows, and a hand icon pointing to button 4.

3 Checkmark the box of the item to be reset to the factory programmed settings by pressing the [4▲] button.

4 Press the [D] button to execute the Factory Reset operation for all checkmarked items.

Saving and Recalling Your Original Settings as a Single File

For the items below, you can save your Original Settings as a Single File for future recall.

- 1 **Make all desired settings on the instrument.**
- 2 **Call up the operation display.**
[FUNCTION] → [J] UTILITY → TAB [◀][▶] SYSTEM RESET
- 3 **Press one of the [F]-[I] buttons to call up the relevant display for saving your data.**

SYSTEM SETUP	Parameters set on the various displays such as the [FUNCTION] → UTILITY are handled as a single System Setup file. Refer to the Data List for details on which parameters belong to the System Setup. The Data List is available at the Yamaha website. (See page 5.)
MIDI SETUP	The MIDI settings including the MIDI templates on the User tab display are handled as a single file.
USER EFFECT	The User Effect settings including the user effect types and user master EQ types created via the Mixing Console displays are managed as a single file.
MUSIC FINDER	All the preset and created records of the Music Finder are handled as a single file.

- 4 **Select one of the tabs (other than the PRESET) by pressing the TAB [◀][▶] buttons.**
Note that the file in the PRESET tab display is the file of factory-programmed settings. If you select it, the factory-programmed settings for the respective item will be restored. (This is the same results as on page 72 “Restoring the Factory-programmed Settings Independently by Item.”)
- 5 **Save your file (page 67).**
- 6 **To recall your file, select the tab and page to which you’ve saved the file (same tab and page as specified in step 4), and press the corresponding [A]-[J] button.**

Data Backup

For maximum data security Yamaha recommends that you copy or save your important data to a USB storage device. This provides a convenient backup if the internal memory is damaged.

Data that can be saved

- 1 Song*, Style, Multi Pad, Registration Memory Bank, Scale Memory Bank and Voice.
- 2 Music Finder Record, Effect**, MIDI Template and System File
 - * Protected Songs (those with a "Prot.1/Prot.2" indication at the upper left of the file name) cannot be saved.
However, Songs with a "Prot.2" indication can be moved (cut-and-paste operation) to a USB flash memory.
 - **Effect data includes the following:
 - Edited or saved data in the Mixing Console "EFFECT/EQ."
- 3 All data listed in 1 and 2 above

The backup procedure is different for the data types in 1, 2, and 3 above.

Backup procedure

1 Song, Style, Multi Pad, Registration Memory Bank, Scale Memory Bank and Voice Data

- 1 **Insert/connect the backup USB storage device (destination).**
- 2 **Call up the display containing the desired file to be copied.**
 - Song:**
Press the SONG [SELECT] button.
 - Style:**
Press one of the STYLE buttons.
 - Multi Pad:**
Press the MULTI PAD CONTROL [SELECT] button.
 - Registration Memory Bank:**
Press the REGIST BANK [+] and [-] buttons simultaneously.
 - Scale Memory Bank:**
Call up the Main display and press the [E] button.
 - Voice:**
Press one of the VOICE buttons.

- 3 **Select the USER tab by using the TAB [◀][▶] buttons.**
- 4 **Press the [3 ▼] (COPY) button to copy the file/folder.**
The pop-up window for the Copy operation appears at the bottom of the display.



- 5 **Press the [6 ▼] (ALL) button to select all files/folders indicated on the current display and all other pages.**
To cancel the selection, press the [6 ▼] (ALL OFF) button again.
- 6 **Press the [7 ▼] (OK) button to confirm the file/folder selection.**
To cancel the Copy operation, press the [8 ▼] (CANCEL) button.
- 7 **Select the destination USB tab to which the file/folder is to be copied, by using the TAB [◀][▶] buttons.**
- 8 **Press the [4 ▼] (PASTE) button to paste the file/folder.**

If a message appears indicating data cannot be copied

Protected Songs ("Prot. 1/Prot.2" is indicated at the upper left side of the file names) are included in the copied files. These protected Songs cannot be copied. However, Songs with a "Prot.2" indication can be moved (cut-and-paste operation) to a USB flash memory.

2 Music Finder Record, Effect, MIDI Template and System Data

- 1 **Insert/connect the backup USB storage device (destination).**
- 2 **Call up the operation display.**
[FUNCTION] → [J] UTILITY → TAB [◀][▶] SYSTEM RESET
- 3 **Press one of the [F]-[I] buttons to call up the relevant display for saving your data.**
- 4 **Select the appropriate USB tab to which you want to save the data by using the TAB [◀][▶] buttons.**
- 5 **Save your data (page 67).**

3 All data listed in 1 and 2

- 1** Insert/connect the backup USB storage device (destination).
- 2** Call up the operation display.
[FUNCTION] → [J] UTILITY → TAB [◀][▶]
OWNER
- 3** Press the [D] (BACKUP) button to save the data to the USB storage device.
To restore the data, press the [E] (RESTORE) button in step 3 above.

- NOTE**
- It takes a few minutes to complete the backup/restore operation.
 - Backup data which has not been created on the PSR-OR700 cannot be restored.

CAUTION

Move the Protected Songs which are saved to the USER display before restoring. If the songs are not moved, the operation deletes the data.

Reference to Quick Guide pages

Playing Voices	page 30
Playing Preset Voices	page 30
Using the Pitch Bend Wheel	page 33
Using the Modulation Wheel	page 34
Using the Metronome	page 34
Voice Effects	page 53

Voice Characteristics

The Voice type and its defining characteristics are indicated above the Preset Voice name.

MegaVoice	<p>The MegaVoices are not intended to be played from the keyboard. They are primarily designed for use with recorded MIDI sequence data (such as songs and styles). Some of the guitar and bass Voices in particular have been created as MegaVoices.</p> <p>What makes MegaVoices special is their use of velocity switching. Normal Voices use velocity switching, too — to make the sound quality and/or level of a Voice according to how strongly or softly you play it. This makes the instrument's Voices sound authentic and natural. However, with MegaVoices, each velocity range (the measure of your playing strength) has a completely different sound.</p> <p>For example, a Mega guitar Voice includes the sounds of various performance techniques. In conventional instruments, different Voices having those sounds would be called up via MIDI and played in combination to achieve the desired effect. However, now with MegaVoices, a convincing guitar part can be played with just a single Voice, using specific velocity values to play the desired sounds.</p> <p>Because of the complex nature of these Voices and the precise velocities need to play the sounds, they're not intended for playing from the keyboard. They are, however, very useful and convenient when creating MIDI data — especially when you want to avoid using several different Voices just for a single instrument part.</p>
Live!	These acoustic instrument sounds were sampled in stereo, to produce a truly authentic, rich sound — full of atmosphere and ambience.
Cool!	These Voices capture the dynamic textures and subtle nuances of electric instruments — thanks to a huge amount of memory and some very sophisticated programming.
Sweet!	These acoustic instrument sounds also benefit from Yamaha's sophisticated technology — and feature a sound so finely detailed and natural, you'll swear you're playing the real thing!
Drums	Various drum and percussion sounds are assigned to individual keys, letting you play the sounds from the keyboard.
SFX	Various special effect sounds are assigned to individual keys, letting you play the sounds from the keyboard.
Organ Flutes!	This authentic organ Voice lets you use the Voice Set to adjust the various footages and craft your own original organ sounds. See page 96 for details.

MegaVoices Compatibility

MegaVoices are not compatible with other models. Any song/style data you've created on the PSR-OR700 using the MegaVoices will not sound properly when played back on other instruments.

Adjusting the volume balance among parts
Adjust the volume balance among the parts in the BALANCE display (page 41).

Specifying the split point (the border between the right- and left-hand range)
See page 107.

Playing Different Voices Simultaneously

The PSR-OR700 keyboard features various functions and performance conveniences that are simply unavailable on an acoustic instrument. It allows you to play several different Voices together in a layer, or play one Voice with your left hand while you play a different Voice (or even two layered Voices!) with your right.

Keyboard Parts (Right 1, Right 2, Left)

Voices can be assigned independently to each keyboard part: Right 1, Right 2, and Left. You can combine these parts by using the PART ON/OFF buttons to create a rich, ensemble sound.

Keyboard Part Combinations

■ Playing a single Voice (Right 1 part)

You can play a single Voice over the entire keyboard range. This is used for normal performance — for example, with the piano Voice.

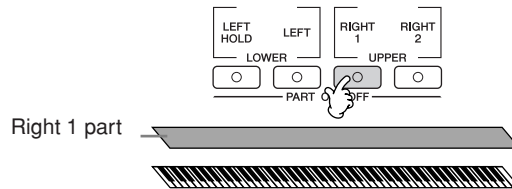

■ Playing two Voices simultaneously (Right 1 and 2 parts)

You can simulate a melody duet or combine two similar Voices to create a thicker sound.

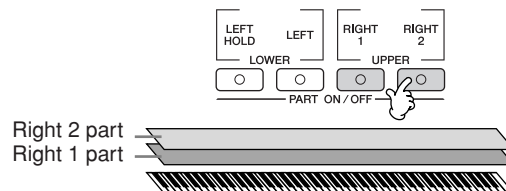

Refer to page 79 for Voice selection operations for the Right 2 part.

■ Playing different Voices with the left and right Hands (Right 1 and Left parts)

You can play different Voices with the left and right hands. For example, try playing the bass Voice with your left hand and the piano Voice with your right.

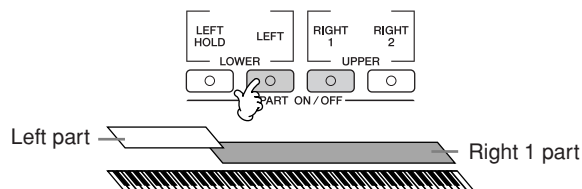

Refer to page 80 for Voice selection operations for the Left part.

■ Playing three different Voices with the left and right Hands (Right 1, 2 and Left parts)

You can combine these three parts to create a rich, ensemble sound.

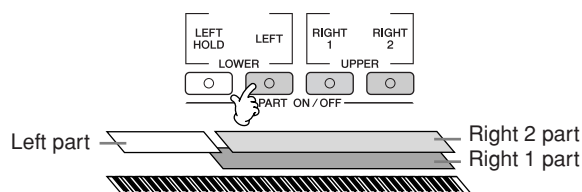

Playing Two Voices Simultaneously (Right 1 and 2 Parts)

You can play two Voices simultaneously with the Right 1 and 2 parts.

- 1 Make sure the PART ON/OFF [RIGHT 1] button is turned on.
- 2 Press the PART ON/OFF [RIGHT 2] button to turn it on.

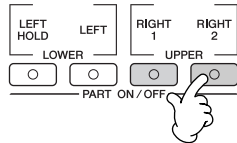

- 3 Press one of the VOICE buttons to call up the Voice selection display for the Right 2 part.

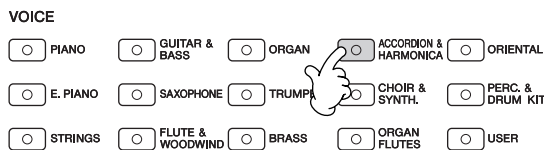

- 4 Press the TAB [◀] button to select the PRESET display.

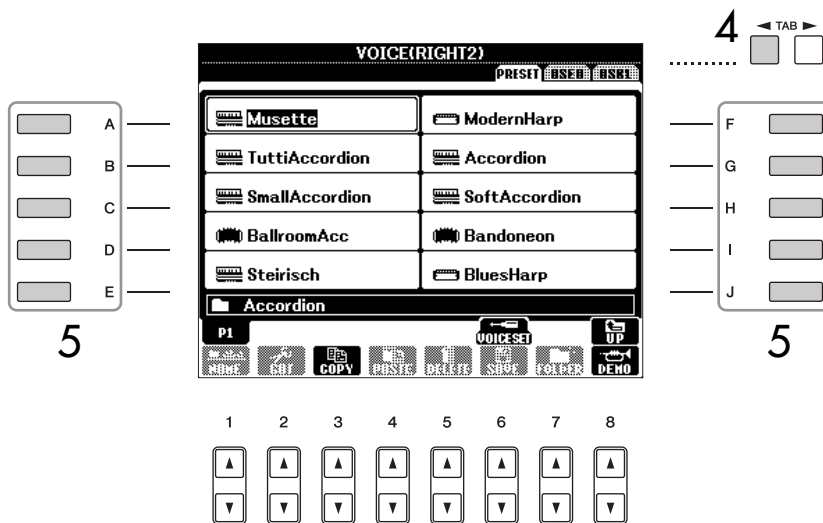

- 5 Press one of the [A]–[J] buttons to select a Voice.
- 6 Play the keyboard.
- 7 Press the PART ON/OFF [RIGHT 2] button again to turn it off.

For the selected part, the name of the currently selected Voice is highlighted (reverse display) in the Main display.

Quickly selecting Voices for Right 1 and 2 parts

You can quickly select the Right 1 and 2 part Voices, just from the Voice buttons. Press and hold one Voice button, then press another. The Voice of the first pressed button is automatically set for the Right 1 part, while the Voice of the second pressed button is set for the Right 2 part.

Switching the Right 2 part on/off with a pedal

You can use a pedal to switch the Right 2 part on/off (when the Right 2 part is appropriately assigned; page 168). This is useful for turning the Right 2 part on and off while you play.

Playing Different Voices with the Left and Right Hands (Right 1 and Left Parts)

You can play different Voices with the Left and Right Hands (Right 1 and Left parts).

For the selected part, the name of the currently selected Voice is highlighted (reverse display) in the Main display.

- 1 Make sure the PART ON/OFF [RIGHT 1] button is turned on.
- 2 Press the PART ON/OFF [LEFT] button to turn it on.

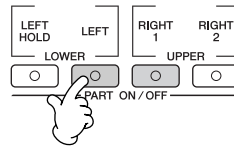

- 3 Press one of the VOICE buttons to call up the Voice selection display for the Left part.

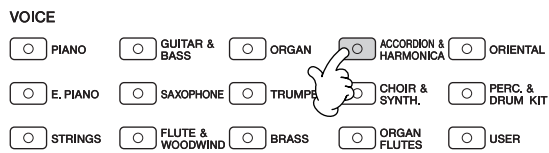

- 4 Press the TAB [◀] button to select the PRESET display.

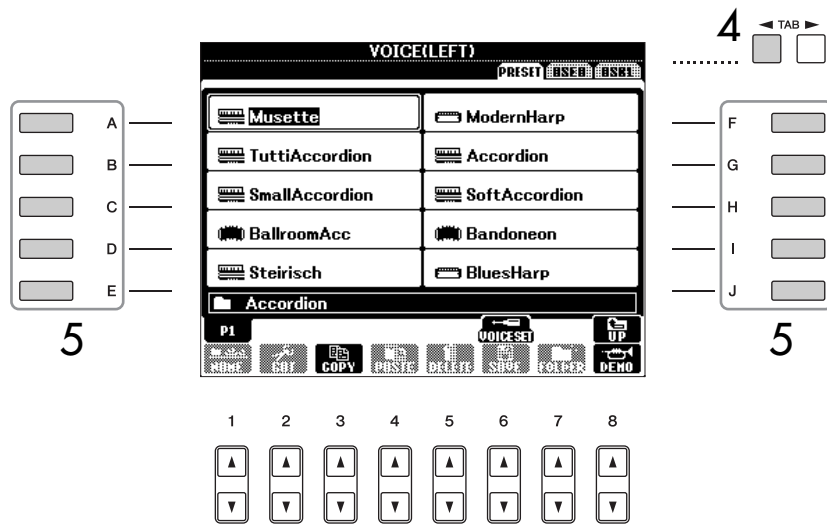

- 5 Press one of the [A]–[J] buttons to select a Voice.
- 6 Play the keyboard.
- 7 Press the PART ON/OFF [LEFT] button again to turn it off.

Switching the Left part on/off with a pedal

You can use a pedal to switch the Left part on/off (when the Left part is appropriately assigned; page 168). This is useful for turning the Left part on and off while you play.

Specifying the split point (the border between the right- and left-hand range)

See page 107.

Changing Pitch

Transpose

Transpose the pitch of the keyboard up or down (in semitones).

- **Transposing during performance**
You can easily set the desired transposition of the overall sound of the instrument by pressing the TRANSPOSE [-]/[+] buttons.
- **Transposing before performance**
Change the transpose settings in the MIXING CONSOLE display. You can set the transposition for the keyboard pitch (KBD), song playback (SONG), or overall sound of the instrument (MASTER), respectively.
 - 1 **Call up the operation display.**
[MIXING CONSOLE] → TAB [◀][▶] TUNE
 - 2 **Use the [1▲▼]–[3▲▼] buttons to set the transposition.**

Fine-tuning the Pitch of the Entire Instrument

You can fine-tune the pitch of the entire instrument — useful when you play the PSR-OR700 along with other instruments or CD music.

- 1 **Call up the operation display.**
[FUNCTION] → [A] MASTER TUNE/SCALE TUNE → TAB [◀][▶] MASTER TUNE
- 2 **Use the [4▲▼]/[5▲▼] buttons to set the tuning.**
Press the 4 or 5's [▲] and [▼] buttons simultaneously to reset the value to the factory setting of 440.0 Hz.

Please note that the Tune function does not affect the Drum Kit or SFX Kit Voices.

Hz (Hertz):

This unit of measurement refers to the frequency of a sound and represents the number of times a sound wave vibrates in a second.

Selecting the Harmony/Echo type

You can select the desired Harmony/Echo effect from a variety of types.

- 1 Turn the [Harmony/Echo] button on.
- 2 Call up the operation display.
[FUNCTION] → [H] HARMONY/ECHO
- 3 Use the [1 ▲ ▼]–[3 ▲ ▼] buttons to select the Harmony/Echo type.
- 4 Use the [4 ▲ ▼]–[8 ▲ ▼] buttons to select various Harmony/Echo settings (page 83).
The available settings differ depending on the Harmony/Echo type.

Harmony/Echo Types

The Harmony/Echo types are divided into the following groups, depending on the particular effect applied.

Harmony Types

These types apply the harmony effect to notes played in the right-hand section of the keyboard according to the chord specified in the left-hand section of the keyboard. (Note that the “1+5” and “Octave” settings are not affected by the chord.)

Multi Assign Type

This type applies a special effect to chords played in the right-hand section of the keyboard.

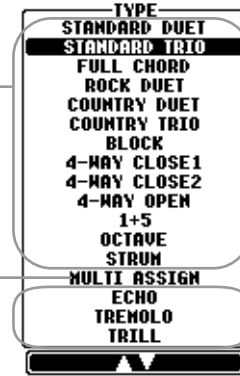

Echo Types

These types apply echo effects to notes played in the right-hand section of the keyboard in time with the currently set tempo.

● Harmony Types

When one of the Harmony Types is selected, the Harmony effect is applied to notes played in the right-hand section of the keyboard according to the type

Canceling the chord sound for the harmony effect

This cancels the sound of the chord played in the chord range of the keyboard — letting you hear only the Harmony effect. Set [ACMP] to On, set [SYNC START] to Off, and select “Off” for the Stop Accompaniment parameter.

selected above and the chord specified in the chord section of the keyboard shown below.

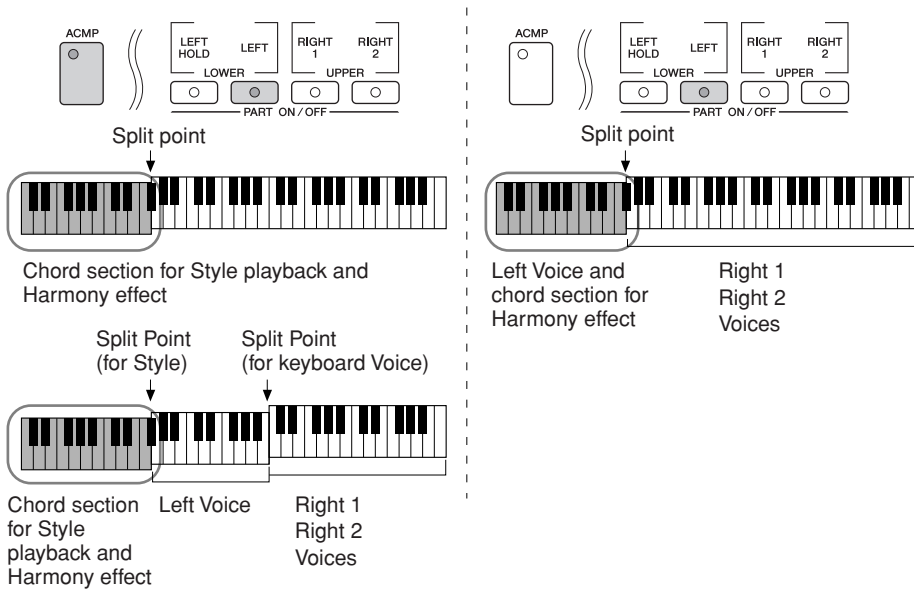

● **Multi Assign Type**

Multi Assign effect automatically assigns notes played simultaneously in the right-hand section of the keyboard to separate parts (Voices). Both of the keyboard part [RIGHT 1] and [RIGHT 2] should be turned on when using the Multi Assign effect. The Right 1 and Right 2 Voices are alternately assigned to the notes in the order you play.

● **Echo Types**

When one of the Echo Types is selected, the corresponding effect (echo, tremolo, trill) is applied to the note played in the right-hand section of the keyboard in time with the currently set tempo, regardless of the [ACMP] and the LEFT part on/off status. Keep in mind that Trill works when you hold down two notes on the keyboard simultaneously (last two notes if more than two notes are held), and it plays those notes alternately.

Harmony/Echo Settings

VOLUME	This parameter is available for all types with the exception of "Multi Assign." It determines the level of the harmony/echo notes generated by the Harmony/Echo effect.
SPEED	This parameter is only available when Echo, Tremolo, or Trill is selected in Type above. It determines the speed of the Echo, Tremolo, and Trill effects.
ASSIGN	This parameter is available for all types with the exception of "Multi Assign." This lets you determine the keyboard part via which the harmony/echo notes will be sounded.
CHORD NOTE ONLY	This parameter is available when one of the Harmony Types is selected. When this is set to "ON," the Harmony effect is applied only to the note (played in the right-hand section of the keyboard) that belongs to a chord played in the chord section of the keyboard.
TOUCH LIMIT	This parameter is available for all types with the exception of "Multi Assign." It determines the lowest velocity value at which the harmony note will sound. This allows you to selectively apply the harmony by your playing strength, letting you create harmony accents in the melody. The harmony effect is applied when you play the key strongly (above the set value).

Editing the Volume and Tonal Balance (MIXING CONSOLE)

The Mixing Console gives you intuitive control over aspects of the keyboard parts and Song/Style channels, including volume balance and the timbre of the sounds. It lets you adjust the levels and stereo position (pan) of each Voice to set the optimum balance and stereo image, and lets you set how the effects are applied.

Basic Procedure

- 1 Press the [MIXING CONSOLE] button to call up the MIXING CONSOLE display.

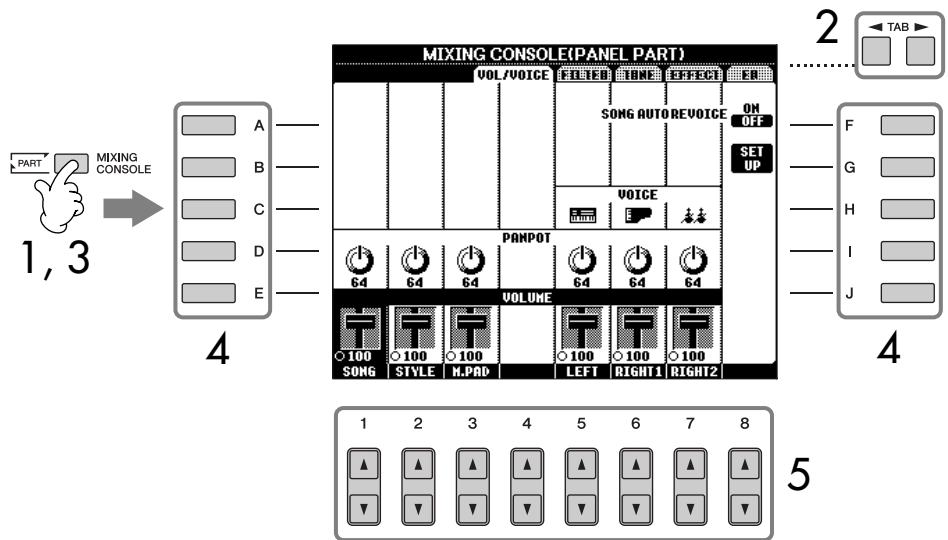

- 2 Use the TAB [◀][▶] buttons to call up the relevant setting display. For information on the available parameters, see the section “Adjustable items (parameters) in the MIXING CONSOLE displays” on page 85.
- 3 Press the [MIXING CONSOLE] button repeatedly to call up the MIXING CONSOLE display for the relevant parts. The MIXING CONSOLE displays actually consist of several different part displays. The part name is indicated at the top of the display. The various MIXING CONSOLE displays alternate among the following: PANEL PART display → STYLE PART display → SONG CH 1-8 display → SONG CH 9-16 display
- 4 Press one of the [A]–[J] buttons to select the desired parameter.
- 5 Use the [1▲▼]–[8▲▼] buttons to set the value.

About Parts
See below.

Instantly setting all parts to the same value
Once you’ve selected a parameter in step 4, you can instantly set the same value to all other parts. To do this, simultaneously hold down one of the [A]–[J] buttons, and use the [1]–[8] buttons or the DATA ENTRY dial.

6 Save your MIXING CONSOLE settings.

- **Saving the PANEL PART display settings**
Register them to Registration Memory (page 131).
- **Saving the STYLE PART display settings**
Save them as Style data.
 - 1 Call up the operation display.
[FUNCTION] → [F] DIGITAL REC MENU
 - 2 Press the [B] button to call up the STYLE CREATOR display.
 - 3 Press the [EXIT] button to close the RECORD display.
 - 4 Press the [I] (SAVE) button to call up the Style Selection display for saving your data, then save it (page 67).
- **Saving the SONG CH 1-8/9-16 display settings**
First register the edited settings as part of the Song data (SET UP), then save the Song.
See the SONG CREATOR → CHANNEL display → SETUP item explanation on page 162.

About Parts

PANEL PART

In the PANEL PART display of the MIXING CONSOLE, you can independently adjust the level balance among the Keyboard parts (RIGHT 1, RIGHT 2 and LEFT), SONG, STYLE, and MULTI PAD. The part components are the same as those that appear in the display when you press the panel [BALANCE] button.

STYLE PART

A Style consists of eight separate channels. Here you can adjust the level balance among these eight channels or parts. These part components are the same as those that appear in the display when you press the panel [CHANNEL ON/OFF] button to call up the STYLE display.

SONG CH 1-8/9-16

A Song consists of sixteen separate channels. Here you can adjust the level balance among these sixteen channels or parts. These part components are the same as those that appear in the display when you press the panel [CHANNEL ON/OFF] button to call up the SONG display.

Adjustable Items (parameters) in the MIXING CONSOLE Displays

The following explanations cover the available items (parameters) in the MIXING CONSOLE displays.

VOL/VOICE

SONG AUTO REVOICE	See page 87.
VOICE	Allows you to re-select the Voices for each part. When the Style channels are called up, neither Organ Flutes Voices nor User Voices can be selected. When the Song channels are called up, User Voices cannot be selected.
PANPOT	Determines the stereo position of the selected part (channel).
VOLUME	Determines the level of each part or channel, giving you fine control over the balance of all the parts.

- The RHY2 channel in the STYLE PART display can only be assigned to Drumkit Voices and SFX kit Voices.
- When playing GM song data, channel 10 (in the SONG CH 9-16) can only be used for a Drum Kit Voice.

FILTER

HARMONIC CONTENT	Allows you to adjust the resonance effect (page 94) for each part.
BRIGHTNESS	Determines the brightness of the sound for each part by adjusting the cutoff frequency (page 94).

TUNE

PORTAMENTO TIME	Portamento is a function that creates a smooth transition in pitch from the first note played on the keyboard to the next. The Portamento Time determines the pitch transition time. Higher values result in a longer pitch change time. Setting this to "0" results in no effect. This parameter is available when the selected keyboard part is set to Mono (page 93).
PITCH BEND RANGE	Determines the range of the PITCH BEND in semitones for each keyboard part (when a pedal is assigned to this function).
OCTAVE	Determines the range of the pitch change in octaves for each keyboard part.
TUNING	Determines the pitch of each keyboard part.
TRANSPOSE	Allows you to set the transposition for the keyboard pitch (KEYBOARD), Song playback (SONG), or overall sound of the instrument (MASTER), respectively.

EFFECT

TYPE	Select the desired effect type (page 88). After editing various parameters for the selected effect type, you can save it as an original effect.
REVERB	Adjusts the amount of the Reverb sound for each part or channel.
CHORUS	Adjusts the amount of the Chorus sound for each part or channel.
DSP	Adjusts the amount of the DSP sound for each part or channel.

EQ (Equalizer)

TYPE	Select the desired EQ type to suit the type of music and the performance environment (page 90). This affects the overall sound of the instrument.
EDIT	For editing the EQ (page 91).
EQ HIGH	Determines the center frequency of the high EQ band that is attenuated/boosted for each part.
EQ LOW	Determines the center frequency of the low EQ band that is attenuated/boosted for each part.

Song Auto Revoice

This feature lets you use the high-quality sounds of the instrument to full advantage with XG-compatible song data. When you play back any commercially available XG song data or that created on other instruments, you can use Auto Revoice to automatically assign the specially created Voices of the PSR-OR700 (Live!, Cool!, etc.) instead of the conventional XG Voices of the same type.

- 1–3 Same operation as in the “Basic Procedure” on page 84. In step 2, select the VOL/VOICE tab.
- 4 Press the [G] (SETUP) button to call up the AUTO REVOICE SETUP display.
- 5 Use the [1 ▲ ▼]–[3 ▲ ▼] buttons to select the Voice to be replaced.

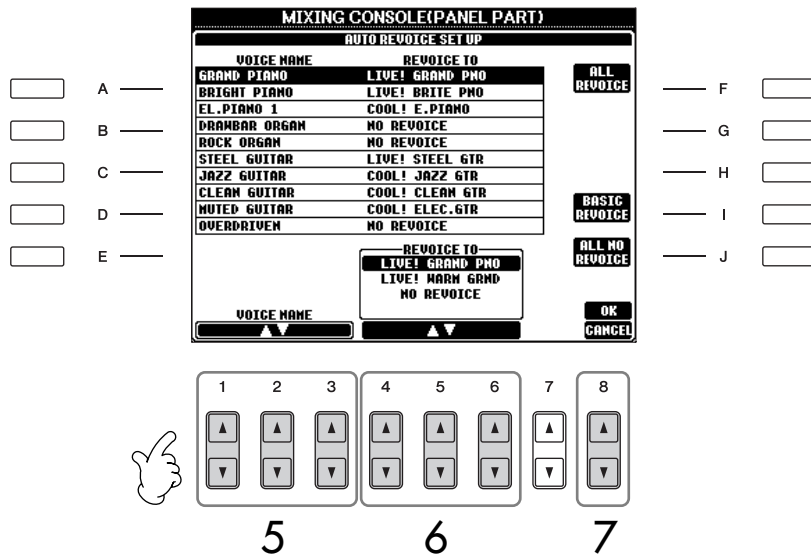

- 6 Use the [4 ▲ ▼]–[6 ▲ ▼] buttons to select the Voice for replacing the XG selected in step 5. Several different Revoice settings are available by using the [F]/[I]/[J] buttons, for conveniently calling up the recommended Revoice settings in one action.

- ALL REVOICE:** Replaces all of the replaceable XG Voices with the high-quality Voices of the PSR-OR700.
- BASIC REVOICE:** Replaces only the recommended Voices that are suitable for playing back the song.
- ALL NO REVOICE:** All Voices are returned to the original XG Voices.

- 7 Press the [8 ▲] (OK) button to apply your Revoice settings. To cancel the Revoice operation, press the [8 ▼] (CANCEL) button.
- 8 In the VOL/VOICE tab display, press the [F] button to set SONG AUTO REVOICE to ON.

Effect Type

■ Selecting an Effect type

- 1–3 Same operation as in the “Basic Procedure” on page 84. In step 2, select the EFFECT tab.
- 4 Press the [F] (TYPE) button to call up the Effect Type selection display.

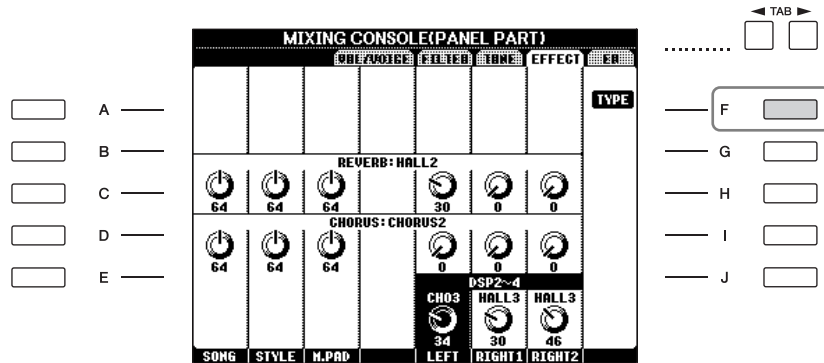

- 5 Use the [1 ▲ ▼]/[2 ▲ ▼] buttons to select the effect BLOCK.

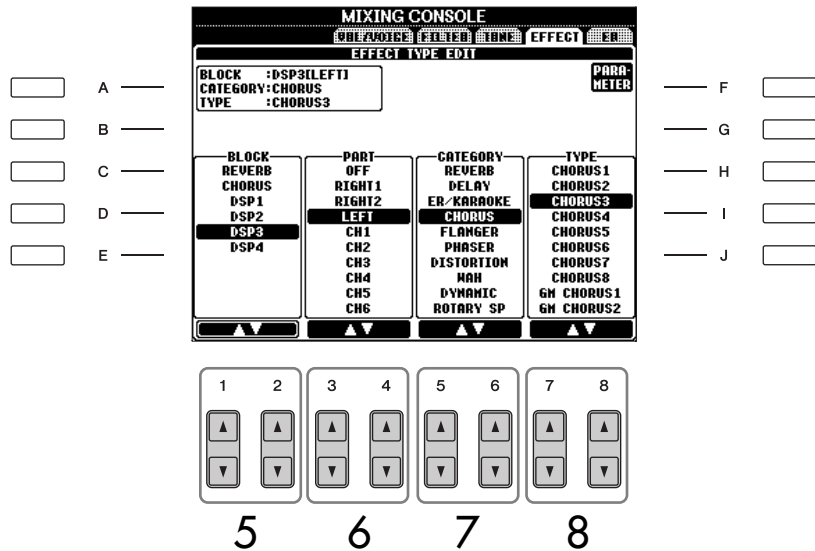

DSP:
Stands for Digital Signal Processor (or Processing). DSP changes and enhances the audio signal in the digital realm to produce a wide range of effects.

Effect Block	Effect-applicable parts	Effect characteristics
REVERB	All parts	Reproduces the warm ambience of playing in a concert hall or jazz club.
CHORUS	All parts	Produces a rich “fat” sound as if several parts are being played simultaneously.
DSP1	STYLE PART SONG CHANNEL 1–16	In addition to the Reverb and Chorus types, the instrument has special DSP effects, that include additional effects usually used for a specific part, such as distortion and tremolo.
DSP2 DSP3 DSP4	RIGHT 1, RIGHT 2, LEFT, SONG CHANNEL 1-16	Any unused DSP blocks are automatically assigned to the appropriate parts (channels) as needed.

- 6 Use the [3 ▲ ▼]/[4 ▲ ▼] buttons to select the part to which you want to apply the effect.
- 7 Use the [5 ▲ ▼]/[6 ▲ ▼] buttons to select the effect CATEGORY.

8 Use the [7▲▼]/[8▲▼] buttons to select the effect TYPE.

If you want to edit the effect parameters, go on to the next operation.

■ Editing and Saving the effect

9 Press the [F] (PARAMETER) button to call up the display for editing the effect parameters.

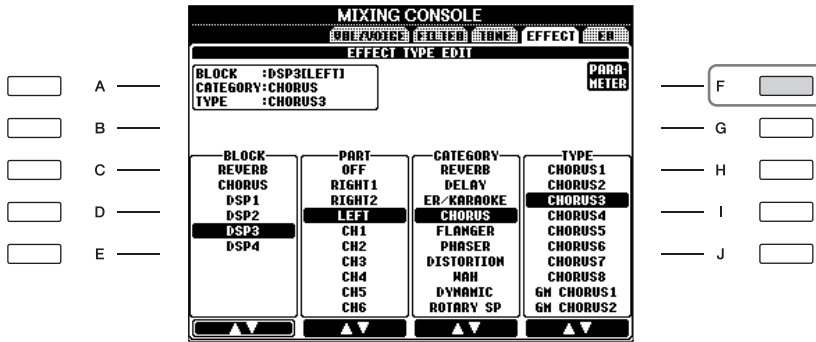

10 If you have selected one of the DSP 2-4 effect blocks in step 5: You can edit its standard parameters as well as its variation parameter. To select the standard type of parameters, press the [B] button. To select its variation parameter, press the [E] button.

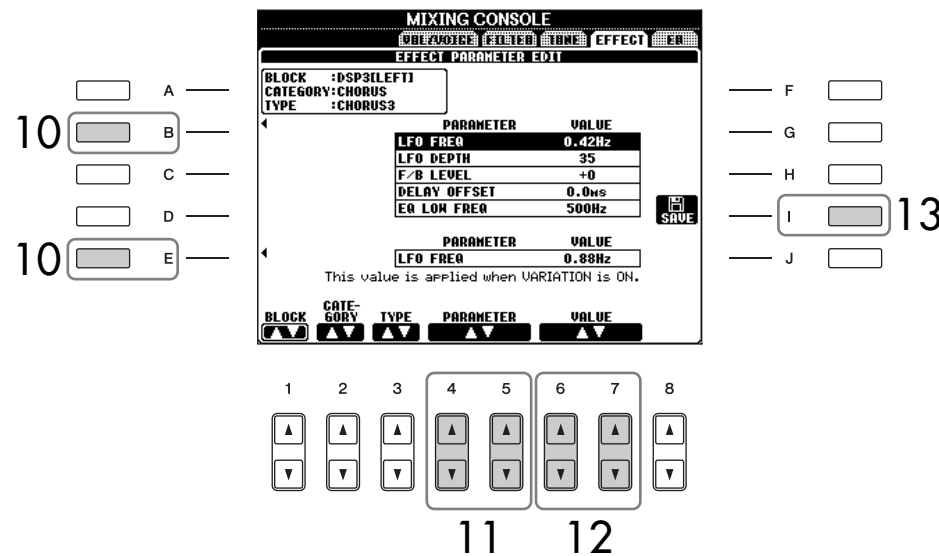

11 Select one of the parameters you want to edit by using the [4▲▼]/[5▲▼] buttons.

Available parameters differ depending on the selected Effect type.

12 Adjust the value for the selected parameter by using the [6▲▼]/[7▲▼] buttons.

If you have selected the REVERB, CHORUS or DSP1 effect block in step 5: Adjust the Effect Return Level by pressing [8▲▼] button.

13 Press the [I] (SAVE) button to call up the display for saving your original effect.

Re-selecting the Effect block, category and type
Use the [1▲▼]–[3▲▼] buttons. The re-selected effect configuration is displayed at the upper left side box in the display.

Effect Return Level:
Determines the level or amount of effect applied.
This is set for all parts or channels.

- 14** Use the [3▲▼]-[6▲▼] buttons to select the destination for saving the effect.
 The maximum number for effects that can be saved differs depending on the effect block.

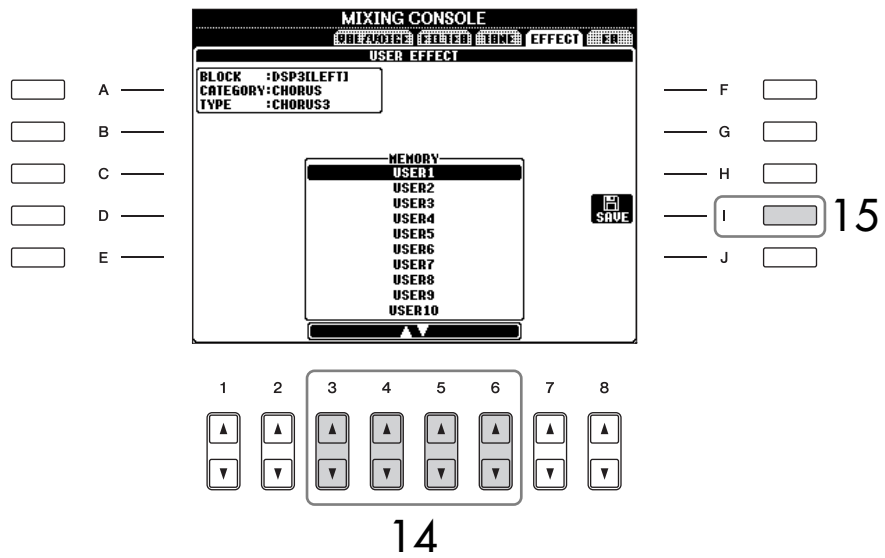

- 15** Press the [I] (SAVE) button to save the effect (page 67).
 When recalling the saved effect, use the same procedure as in step 8.

EQ (Equalizer)

Equalizer (also called “EQ”) is a sound processor that divides the frequency spectrum into multiple bands that can be boosted or cut as required to tailor the overall frequency response. Usually an equalizer is used to correct the sound from speakers to match the special character of the room. For example, you can cut some of the low range frequencies when playing in large spaces where the sound is too “boomy,” or boost the high frequencies in rooms and close spaces where the sound is relatively “dead” and free of echoes. The instrument possesses a high-grade five-band digital EQ. With this function, a final effect — tone control can be added to the output of your instrument. You can select one of the five preset EQ settings in the EQ display. You can even create your own custom EQ settings by adjusting the frequency bands, and save the settings to one of two User Master EQ types.

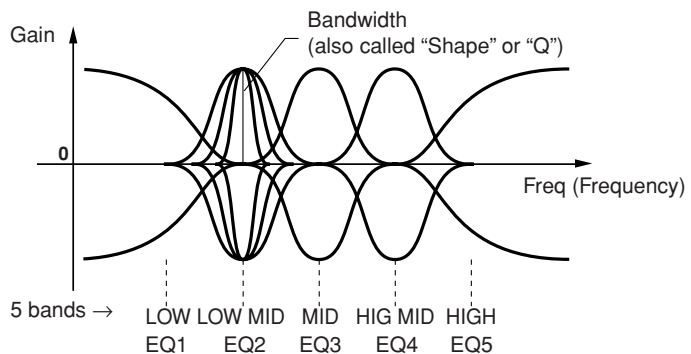

■ Select a Preset EQ type

- 1–3** Same operation as in the “Basic Procedure” on page 84. In step 2, select the EQ tab.
- 4** Use the [A]/[B] buttons to select a preset EQ type to suit your performance (music style or environment).

If you want to edit the EQ parameters, go on to the next operation.

■ Editing and Saving the selected EQ

5 Press the [F] (EDIT) button to call up the MASTER EQ EDIT display.

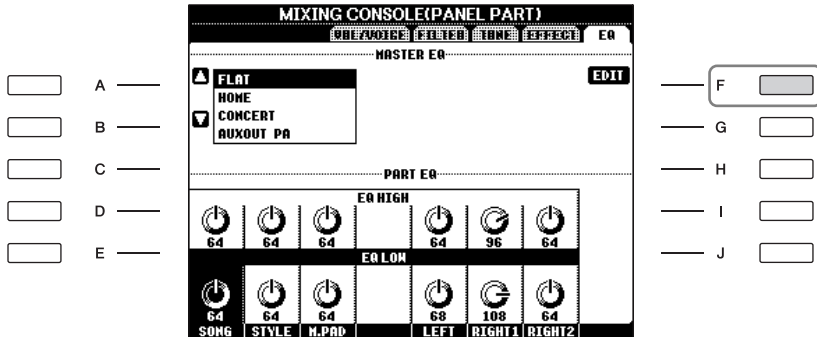

6 Use the [A]/[B] buttons to select a preset EQ type.

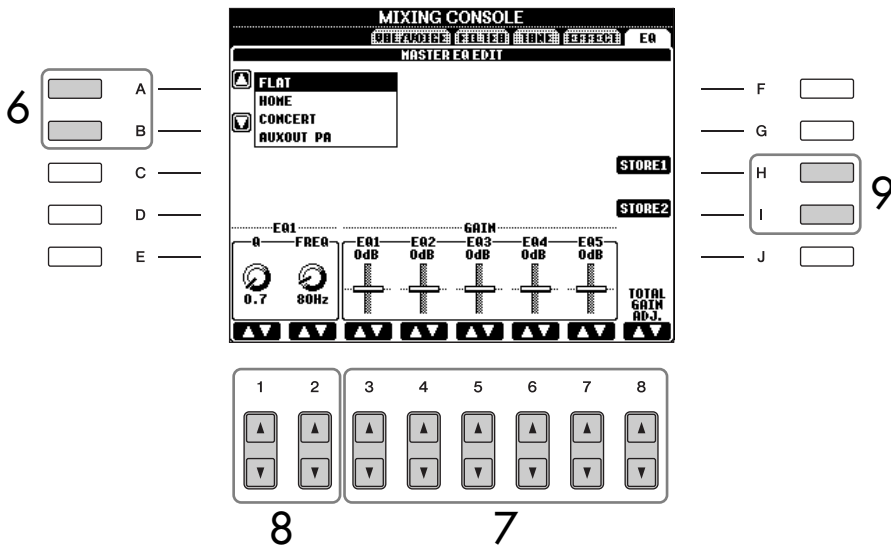

7 Use the [3 ▲ ▼]-[7 ▲ ▼] buttons to boost or cut each of the five bands.
Use the [8 ▲ ▼] button to boost or cut all the five bands at the same time.

8 Adjust the Q (bandwidth) and the FREQ (center frequency) of the band selected in step 7.

- **Bandwidth (also called "Shape" or "Q")**
Use the [1 ▲ ▼] button. The higher the value of Q, the narrower the band width.
- **FREQ (center frequency)**
Use the [2 ▲ ▼] button. The available FREQ range is different for each band.

9 Press the [H] or [I] (STORE 1 or 2) button to save the edited EQ type (page 67).

Up to two types of EQ can be created and saved. When recalling the saved EQ type, use the same procedure as in step 6.

Editing the ORGAN FLUTES Voices

The editing method is different for the ORGAN FLUTES Voices compared to other Voices. For instructions on editing the ORGAN FLUTES Voices, see page 96.

Voice Creating — Voice Set

The PSR-OR700 has a Voice Set feature that allows you to create your own Voices by editing some parameters of the existing Voices. Once you've created a Voice, you can save it as a User Voice to the USER/(USB) for future recall. The editing method is different for the ORGAN FLUTES Voices and for other Voices.

Basic Procedure

- 1 Select the desired Voice (other than an Organ Flutes Voice) (page 31).
- 2 Press the [6 ▲] (VOICE SET) button to call up the VOICE SET display.



- 3 Use the TAB [◀][▶] buttons to call up the relevant setting display. For information on the available parameters, see the "Editable Parameters in the VOICE SET Displays" on page 93.

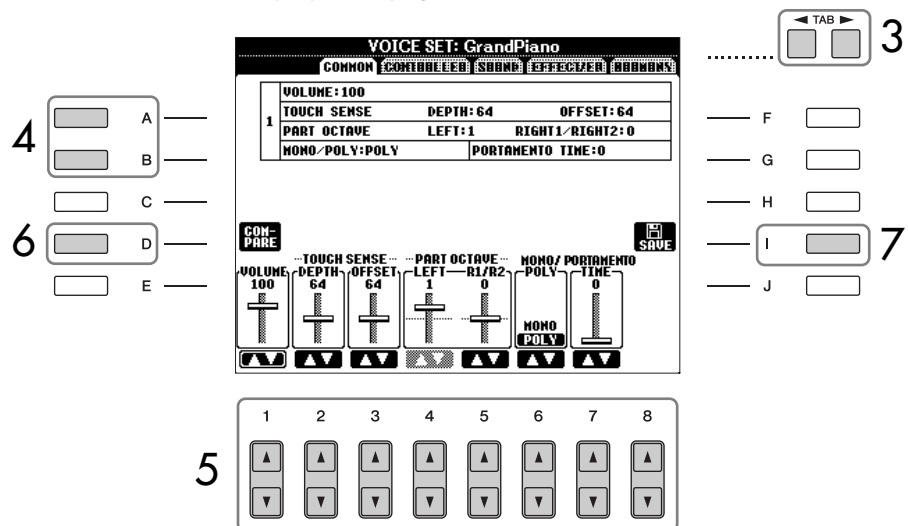

- 4 As necessary, use the [A]/[B] buttons to select the item (parameter) to be edited.
- 5 Use the [1 ▲ ▼]-[8 ▲ ▼] buttons to edit the Voice.
- 6 Press the [D] (COMPARE) button to compare the sound of the edited Voice with the unedited Voice.

CAUTION
If you select another Voice without saving the settings, the settings will be lost. If you wish to store the settings here, make sure to save the settings as a User Voice before selecting another Voice or turning the power off.

7 Press the [I] (SAVE) button to save your edited Voice (page 67).

Editable Parameters in the VOICE SET Displays

The following covers in detail the editable parameters that are set in the displays explained in step 3 of the “Basic Procedure” on page 92. The Voice Set parameters are organized into five different displays. The parameters in each display are described separately, below. These are also treated as part of the Voice Set parameters (page 98), which are automatically called up when the Voice is selected.

COMMON

VOLUME	Adjusts the volume of the current edited Voice.
TOUCH SENSE	Adjusts the touch sensitivity (velocity sensitivity), or how greatly the volume responds to your playing strength. DEPTH Determines the velocity sensitivity, or how much the level of the voice changes in response to your playing strength (velocity). OFFSET Determines the amount by which received velocities are adjusted for the actual velocity effect.
PART OCTAVE	Shifts the octave range of the edited Voice up or down in octaves. When the edited Voice is used as any of the RIGHT 1-2 parts, the R1/R2 parameter is available; when the edited Voice is used as the LEFT part, the LEFT parameter is available.
MONO/POLY	Determines whether the edited Voice is played monophonically or polyphonically. This setting can also be made from the VOICE CONTROL “MONO” button on the panel (page 53).
PORTAMENTO TIME	Sets the portamento time when the edited Voice is set to “MONO” above. NOTE Portamento Time: The Portamento Time determines the pitch transition time. Portamento is a function that creates a smooth transition in pitch from the first note played on the keyboard to the next.

CONTROLLER MODULATION

The MODULATION wheel can be used to modulate the parameters below as well as the pitch (vibrato). Here, you can set the degree to which the pedal modulates each of the following parameters.

FILTER	Determines the degree to which the pedal modulates the Filter Cut-off Frequency. For details about the filter, see page 94.
AMPLITUDE	Determines the degree to which the pedal modulates the amplitude (volume).
LFO PMOD	Determines the degree to which the pedal modulates the pitch, or the vibrato effect.
LFO FMOD	Determines the degree to which the pedal modulates the Filter modulation, or the wah effect.
LFO AMOD	Determines the degree to which the pedal modulates the amplitude, or the tremolo effect.

The available parameters differ depending on the Voice.

Changes to velocity curve according to Touch sensitivity

TOUCH SENSE DEPTH

Changes to velocity curve according to VelDepth (with Offset set to 64)

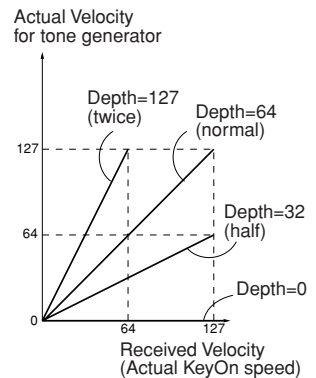

TOUCH SENSE OFFSET

Changes to velocity curve according to VelOffset (with Depth set to 64)

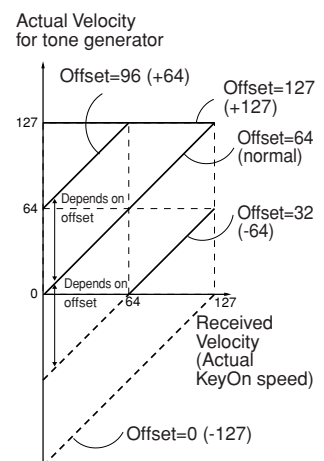

SOUND

● **FILTER**

Filter is a processor that changes the timbre or tone of a sound by either blocking or passing a specific frequency range. The parameters below determine the overall timbre of the sound by boosting or cutting a certain frequency range. In addition to making the sound either brighter or mellower, Filter can be used to produce electronic, synthesizer-like effects.

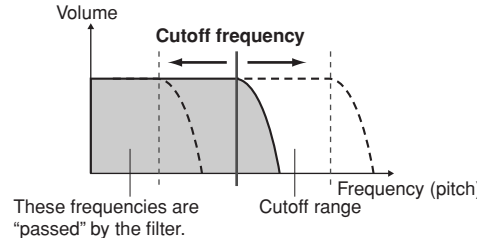
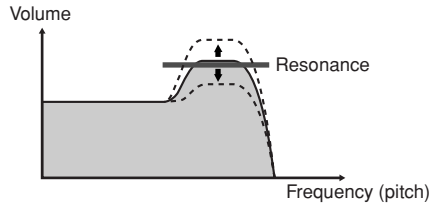
<p>BRIGHTNESS</p>	<p>Determines the cutoff frequency or effective frequency range of the filter (see diagram). Higher values result in a brighter sound.</p> 
<p>HARMONIC CONTENT</p>	<p>Determines the emphasis given to the cutoff frequency (resonance), set in BRIGHTNESS above (see diagram). Higher values result in a more pronounced effect.</p> 

● **EG**

The EG (Envelope Generator) settings determine how the level of the sound changes in time. This lets you reproduce many sound characteristics of natural acoustic instruments — such as the quick attack and decay of percussion sounds, or the long release of a sustained piano tone.

<p>ATTACK</p>	<p>Determines how quickly the sound reaches its maximum level after the key is played. The lower the value, the quicker the attack.</p>
<p>DECAY</p>	<p>Determines how quickly the sound reaches its sustain level (a slightly lower level than maximum). The lower the value, the quicker the decay.</p>
<p>RELEASE</p>	<p>Determines how quickly the sound decays to silence after the key is released. The lower the value, the quicker the decay.</p>

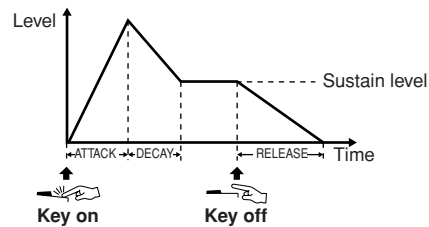

● **VIBRATO**

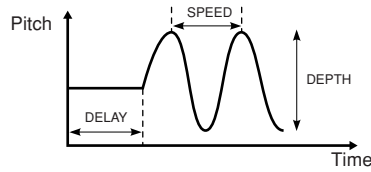

Vibrato:

A quavering, vibrating sound effect that is produced by regularly modulating the pitch of the Voice.

DEPTH	Determines the intensity of the Vibrato effect. Higher settings result in a more pronounced Vibrato.
SPEED	Determines the speed of the Vibrato effect.
DELAY	Determines the amount of time that elapses between the playing of a key and the start of the Vibrato effect. Higher settings increase the delay of the Vibrato onset.

EFFECT/EQ

1. REVERB DEPTH/CHORUS DEPTH/DSP DEPTH

REVERB DEPTH	Adjusts the reverb (page 88) depth.
CHORUS DEPTH	Adjusts the chorus (page 88) depth.
DSP DEPTH	Adjusts the DSP (page 88) depth. If you want to re-select the DSP type, you can do so in the DSP menu explained below.
DSP ON/OFF	Determines whether the DSP is on or off. This setting can also be made from the VOICE CONTROL “DSP” button on the panel (page 53).
PANEL SUSTAIN	Determines the sustain level applied to the edited voice when the VOICE CONTROL [SUSTAIN] button on the panel is turned on (page 53).

2. DSP

DSP TYPE	Selects the DSP effect category and type. Select a type after selecting a category.
VARIATION	Two variations are provided for each DSP type. Here, you can edit the VARIATION on/off status and variation-parameter value setting. ON/OFF The factory-programmed assignments are set to variation-off for all Voices (standard variation of DSP is assigned). If you select VARIATION ON here, a variation of the DSP effect is assigned to the Voice. The variation parameter value can be adjusted in the VALUE menu explained below. This setting can also be made from the VOICE CONTROL “DSP VARI.” button on the panel (page 53). This button is effective only when the [DSP] button is on. PARAMETER Displays the variation parameter. VALUE Adjusts the value of the DSP variation parameter.

3. EQ

EQ LOW/HIGH	These determine the Frequency and Gain of the Low and High EQ bands.
--------------------	--

HARMONY

Harmony sets the Right 1 and 2 parts together. Press the PART SELECT [RIGHT 1] button before you set it.

This has the same settings as the display of “Selecting the Harmony/Echo type” on page 82 in step 2.

Creating Your Original Organ Flutes Voices

The PSR-OR700 features a variety of lush, dynamic organ Voices that you can call up with the [ORGAN FLUTES] button. It also gives you the tools to create your own original organ sounds by using the Voice Set function. Just as on a traditional organ, you can create your own sounds by adjusting the levels of the flute footages.

Basic Procedure

- 1 Select the desired Organ Flutes Voice to be edited (page 31).
- 2 In the ORGAN FLUTES Voice Selection display, press the [6 ▲] (FOOTAGE) button to call up the VOICE SET [ORGAN FLUTES] display.

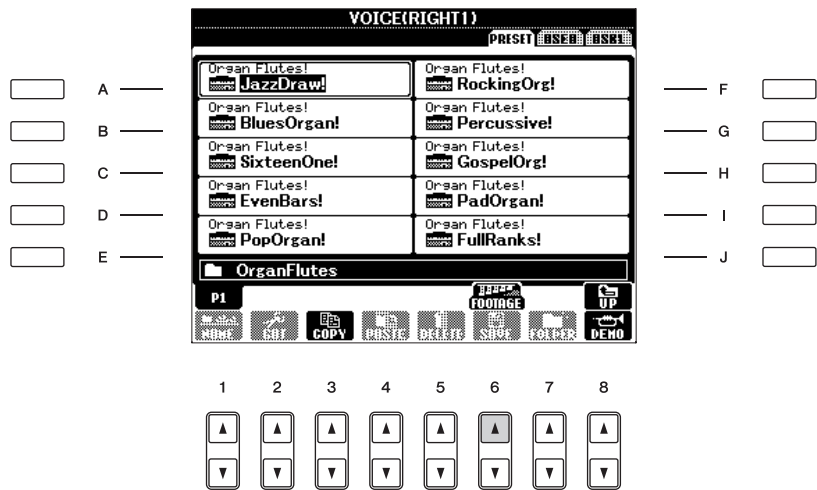

- 3 Use the TAB [◀][▶] buttons to call up the relevant setting display. For information on the available parameters, see the “Editable Parameters in the VOICE SET [ORGAN FLUTES] displays” on page 97.

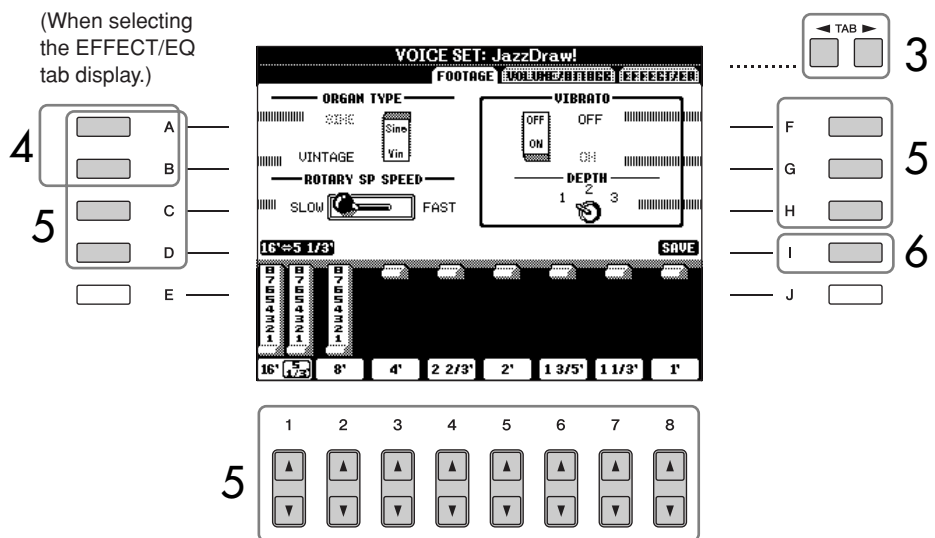

- 4 If you select the EFFECT/EQ tab display, use the [A]/[B] buttons to select the parameter to be edited.

- 5 Use the [A]–[D], [F]–[H] and [1▲▼]–[8▲▼] buttons to edit the Voice.
- 6 Press the [I] (SAVE) button to save your edited ORGAN FLUTES Voice (page 67).

Editable Parameters in the VOICE SET [ORGAN FLUTES] displays

The following covers in detail the editable parameters that are set in the displays explained in step 3 of the “Basic Procedure.” The Organ Flutes parameters are organized into three different pages. The parameters in each page are described separately, below. These are also treated as part of the Voice Set parameters (page 98), which are automatically called up when the Voice is selected.

FOOTAGE, VOLUME/ATTACK (common parameters)

ORGAN TYPE	Specifies the type of organ tone generation to be simulated: Sine or Vintage.
ROTARY SP SPEED	Alternately switches between the slow and fast rotary speaker speeds when a rotary speaker effect is selected for the Organ Flutes (see “EFFECT/EQ” DSP TYPE parameter on page 95), and the Voice Effect DSP (page 95) is turned on (this parameter has the same effect as the Voice Effect VARIATION ON/OFF parameter).
VIBRATO ON/OFF	Alternately turns the vibrato effect for the Organ Flutes Voice ON or OFF.
VIBRATO DEPTH	Sets the Vibrato depth to one of three levels: 1 (low), 2 (mid), or 3 (high).

FOOTAGE

16' ← → 5 1/3'	Which footage (16' or 5 1/3') is operated with the [1▲▼] button can be switched by pressing the [D] button.
16'–1'	Determines the basic sound of the organ flutes. The longer the pipe, the lower the pitch of the sound. Hence, the 16' setting determines the lowest pitched component of the Voice, while the 1' setting determines the highest pitched component. The higher the value of the setting, the greater the volume of the corresponding footage. Mixing various volumes of the footages lets you create your own distinctive organ sounds.

⚠ CAUTION

If you select another Voice without saving the settings, the settings will be lost. If you wish to store the settings here, make sure to save the settings as a User Voice before selecting another Voice or turning the power off.

Footage:

The term “footage” is a reference to the sound generation of traditional pipe organs, in which the sound is produced by pipes of different lengths (in feet).

VOLUME/ATTACK

VOL	Adjusts the overall volume of the Organ Flutes. The longer the graphic bar, the greater the volume.
RESP	Affects both the attack and release (page 94) portion of the sound, increasing or decreasing the response time of the initial swell and release, based on the FOOTAGE controls. The higher the value, the slower the swell and release.
VIBRATO SPEED	Determines the speed of the vibrato effect controlled by the Vibrato On/Off and Vibrato Depth on the previous page.
MODE	The MODE control selects between two modes: FIRST and EACH. In the FIRST mode, attack is applied only to the first notes played and held simultaneously; while the first notes are held, any subsequently played notes have no attack applied. In the EACH mode, attack is applied equally to all notes.
4', 2 2/3', 2'	These determine the attack sound volume of the ORGAN FLUTE Voice. The 4', 2-2/3' and 2' controls increase or reduce the volume of attack sound at the corresponding footages. The longer the graphic bar, the greater the attack sound volume.
LENG	Affects the attack portion of the sound producing a longer or shorter decay immediately after the initial attack. The longer the graphic bar, the longer the decay.

EFFECT/EQ

Same parameters as in the VOICE SET “EFFECT/EQ” tab display explained on page 95.

Disabling automatic selection of Voice Sets (effects, etc.)

Each Voice is linked to its related parameter settings that are indicated in the VOICE SET displays, including effects and EQ. Usually these settings are automatically called up when a Voice is selected. However, you can also disable this feature by the operation in the relevant display as explained below.

For example, if you want to change the Voice yet keep the same Harmony effect, set the HARMONY/ECHO parameter to OFF (in the display explained below).

You can set these independently by keyboard part and parameter group.

1 Call up the operation display.

[FUNCTION] → [E] REGIST.SEQUENCE/FREEZE/VOICE SET → TAB [◀][▶]
VOICE SET

2 Use the [A]/[B] buttons to select a keyboard part.

3 Use the [4▲▼]–[7▲▼] buttons to enable/disable automatic calling up of the settings (ON or OFF) independently for each parameter group.

Refer to the Data List for a list of parameters contained in each parameter group. The Data List is available at the Yamaha website. (See page 5.)

The Oriental Scales feature lets you simply and easily raise or lower the pitches of specific notes and create your own scales. You can change the scale settings at any time—even when you are playing. Up to six scale settings can be stored for instant recall, whenever you need them.

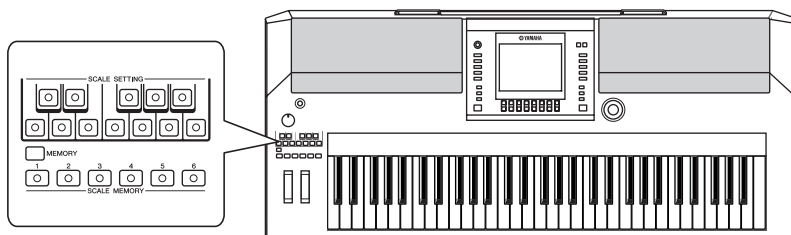

Setting an Oriental Scale — Scale Setting

The [SCALE SETTING] buttons simulate an one-octave keyboard (C through B). You can easily change the scale setting at any time by pressing one of the [SCALE SETTING] buttons, located at the left side of the panel.

Pressing each button turns the Scale Setting feature for the specific note on and off. The Scale Setting feature affects all the notes having the same note name in all octaves. When set to on (the selected button itself is lit), you can play the keyboard in the selected oriental scale.

The scale setting for each note is -50 cents. You can also adjust the scale tuning in 1-cent units in the SCALE TUNE display.

The [SCALE SETTING] buttons will light or go out according to the song playback data. The Scale Setting function has no effect on the Drum Kit/SFX Kit voices.

Scale Tuning

You can select various scales for playing in custom tunings for specific historical periods or music genres.

- 1 **Call up the operation display.**
[FUNCTION] → [A] MASTER TUNE/SCALE TUNE → TAB [◀][▶] SCALE TUNE
- 2 **Select the desired part for which you want to set the scale by using the [6▲▼]/[7▲▼] buttons.**
Checkmark the box by pressing the [8▲] button.
- 3 **Use the [A]/[B] buttons to select the desired scale.**
The tuning of each note for the currently selected scale is indicated in the keyboard illustration at the upper right of the display.

You also can call up the SCALE TUNE display by pressing the [SCALE TUNE] button.

Cent:

In musical terms a “cent” is 1/100th of a semitone. (100 cents equal one semitone.)

Instantly recalling the desired scale

Register the desired scale to the Registration Memory. Be sure to checkmark the SCALE item when registering (page 131).

4 Change the following settings as necessary.

- **Tuning the individual notes of the keyboard (TUNE)**
 - 1 Press the [3 ▲ ▼] button to select the note for tuning.
 - 2 Use the [4 ▲ ▼]/[5 ▲ ▼] buttons to set the tuning in cents.
- **Determines the base note for each scale.**
 Press the [2 ▲ ▼] button to select the base note.
 When the base note is changed, the pitch of the keyboard is transposed, yet maintains the original pitch relationship between the notes.

Preset Scale Types

EQUAL TEMPERAMENT	The pitch range of each octave is divided equally into twelve parts, with each half-step evenly spaced in pitch. This is the most commonly used tuning in music today.
BAYAT/ RAST	Use these tunings when playing Arabic music.
PURE MAJOR PURE MINOR	These tunings preserve the pure mathematical intervals of each scale, especially for triad chords (root, third, fifth). You can hear this best in actual vocal harmonies – such as choirs and a cappella singing.
PYTHAGOREAN	This scale was devised by the famous Greek philosopher and is created from a series of perfect fifths, which are collapsed into a single octave. The 3rd in this tuning are slightly unstable, but the 4th and 5th are beautiful and suitable for some leads.
MEAN-TONE	This scale was created as an improvement on the Pythagorean scale, by making the major third interval more “in tune.” It was especially popular from the 16th century to the 18th century. Handel, among others, used this scale.
WERCKMEISTER KIRNBERGER	This composite scale combines the Werckmeister and Kirnberger systems, which were themselves improvements on the mean-tone and Pythagorean scales. The main feature of this scale is that each key has its own unique character. The scale was used extensively during the time of Bach and Beethoven, and even now it is often used when performing period music on the harpsichord.

Tuning values for Preset Scales (base note: C) (in cents)

	C	C#	D	Eb	E	F	F#	G	Ab	A	Bb	B
EQUAL TEMPERAMENT	0	0	0	0	0	0	0	0	0	0	0	0
Bayat	0	0	-50.0	0	0	0	0	0	0	-50.0	0	0
Rast	0	0	0	0	-50.0	0	0	0	0	0	0	-50.0
PURE MAJOR	0	-29.7	3.9	15.6	-14.1	-2.3	-9.4	2.3	-27.3	-15.6	18.0	-11.7
PURE MINOR	0	33.6	3.9	15.6	-14.1	-2.3	31.3	2.3	14.1	-15.6	18.0	-11.7
PYTHAGOREAN	0	14.1	3.9	-6.3	7.8	-2.3	11.7	2.3	15.6	6.3	-3.9	10.2
MEAN-TONE	0	-24.2	-7.0	10.2	-14.1	3.1	-20.3	-3.1	-27.3	-10.2	7.0	-17.2
WERCKMEISTER	0	-10.2	-7.8	-6.3	-10.2	-2.3	-11.7	-3.9	-7.8	-11.7	-3.9	-7.8
KIRNBERGER	0	-10.2	-7.0	-6.3	-14.1	-2.3	-10.2	-3.1	-7.8	-10.2	-3.9	-11.7

* In the display, the rounded off value is shown.

Memorizing the Scale Setting — Scale Memory

The scale settings you set (using the [SCALE SETTING] buttons or in the SCALE TUNE display) are memorized by the Scale Memory function. Up to six scale settings can be stored for instant recall, whenever you need them.

- 1 Set up the scale settings as desired using the [SCALE SETTING] buttons or in the SCALE TUNE display.
- 2 While holding the [MEMORY] button, press one of the SCALE MEMORY [1]–[6] buttons.

The corresponding SCALE MEMORY button will light. Any data that was previously in the selected location is erased and replaced by the new settings.

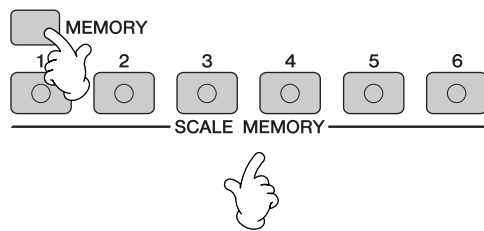

The memorized scale settings here will be lost when the power is turned off, unless you perform the Save operation (see next section).

About the lamp status:

Off no data registered, or not currently selected
 On data registered, and currently selected

Saving Your Scale Settings

The scale settings memorized to the SCALE MEMORY [1]–[6] buttons are saved as a single file.

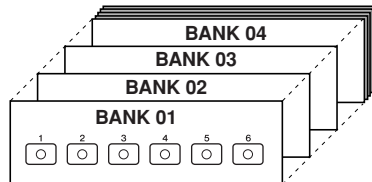

All settings memorized to the buttons [1]–[6] are referred to as a “bank.” The banks can be saved to “USER” or “USB” as Scale Tune Bank files.

- 1 Press the [E] button to call up the SCALE TUNE BANK Selection Display.

Press the [DIRECT ACCESS] button and [EXIT] button to call up the MAIN display.

2 Save the settings you've made to the SCALE MEMORY buttons as a single Scale Tune Bank file (page 67).

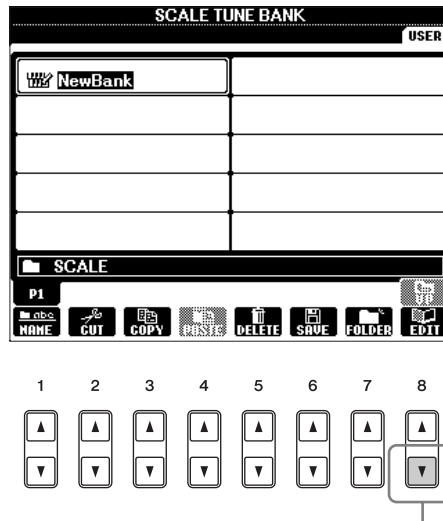

The SCALE TUNE EDIT display appears. For details on this display, see below.

SCALE TUNE EDIT display

The contents of the current Scale Tune Bank are listed in the SCALE TUNE EDIT screen. The names of the stored Scale Settings are shown in the display.

From this screen, you can select, name, or delete each of the Scale Settings.

Select.....Press the [A]–[C] / [F]–[H] buttons. The SCALE TUNE EDIT display is linked to the SCALE MEMORY [1]–[6] buttons.

When you select the Scale Settings in the display, the corresponding SCALE MEMORY button lights.

NameThis operation is the same as that in “Renaming Files/Folders” (page 70) in “Basic Operation.”

Delete.....This operation is the same as that in “Deleting Files/Folders” (page 69) in “Basic Operation.”

NOTE The result of the Name/Delete operation will be lost when the power is turned off unless you return to the SCALE TUNE BANK display by pressing the [8] (▲) button and save the data (page 67).

Recalling the Scale Setting

To recall the memorized scale settings, select the desired bank in the SCALE TUNE BANK display (page 99). Press the appropriate SCALE MEMORY [1]–[6] button to which you memorized the setting. The corresponding SCALE MEMORY button will light.

The Scale Memory function can be turned off by pressing the SCALE MEMORY button which is currently lit, so that the light goes out. The default Equal Temperament Scale settings (pitch settings for all notes are “0” will be restored.

NOTE If you press a SCALE MEMORY button to which nothing is memorized, the current scale settings remain and nothing changes.

Reference to Quick Guide pages

Playing “Mary Had a Little Lamb” with the Auto

Accompaniment Feature	page 46
Pattern Variation	page 48
Learning How to Play (Indicate) Chords for Style Playback	page 50
Appropriate Panel Settings for the Selected Style (One Touch Setting)	page 51

Style Characteristics

The Style type and its defining characteristics are indicated above the Preset Style name.

Pro	These Styles provide professional and exciting arrangements combined with perfect playability. The resulting accompaniment exactly follows the chords of the player. As a result, your chord changes and colorful harmonies are instantly transformed into lifelike musical accompaniment.
Session	These Styles provide even greater realism and authentic backing by mixing in original chord types and changes, as well as special riffs with chord changes, with the Main sections. These have been programmed to add “spice” and a professional touch to your performances of certain songs and in certain genres. Keep in mind, however, that the Styles may not necessarily be appropriate — or even harmonically correct — for all songs and for all chord playing. In some cases for example, playing a simple major triad for a country song may result in a “jazzy” seventh chord, or playing an on-bass chord may result in inappropriate or unexpected accompaniment.



Selecting a Chord Fingering Type

Style playback can be controlled by the chords you play in the chord section of the keyboard. There are seven types of fingerings.

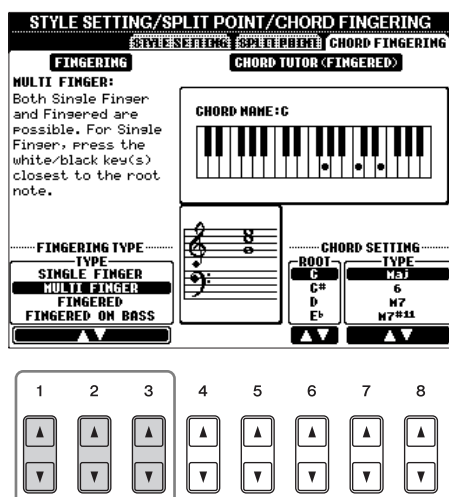
- 1 **Call up the operation display.**
[FUNCTION] → [C] STYLE SETTING/SPLIT POINT/CHORD FINGERING → TAB [◀][▶] CHORD FINGERING
- 2 **Press the [1 ▲ ▼]–[3 ▲ ▼] buttons to select a fingering.**

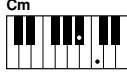

AI:
Artificial Intelligence

SINGLE FINGER	<p>Makes it simple to produce orchestrated accompaniment using major, seventh, minor and minor-seventh chords by pressing a minimum number of keys on the Chord section of the keyboard. This type is available only for Style playback. The abbreviated chord fingerings described at right are used:</p>	 <p>C For a major chord, press the root key only.</p>  <p>Cm For a minor chord, simultaneously press the root key and a black key to its left.</p>  <p>C7 For a seventh chord, simultaneously press the root key and a white key to its left.</p>  <p>Cm7 For a minor-seventh chord, simultaneously press the root key and both a white and black key to its left.</p>
MULTI FINGER	<p>Automatically detects Single Finger or Fingered chord fingerings, so you can use either type of fingering without having to switch fingering types.</p>	
FINGERED	<p>Lets you finger your own chords on the Chord section of the keyboard, while the instrument supplies appropriately orchestrated rhythm, bass, and chord accompaniment in the selected Style. The Fingered type recognizes the various chord types which are listed on the Data List available at the Yamaha website (page 5) and can be looked up using the Chord Tutor function (page 50).</p>	
FINGERED ON BASS	<p>Accepts the same fingerings as the Fingered, but the lowest note played in the Chord section of the keyboard is used as the bass note, allowing you to play "on bass" chords (in the Fingered mode the root of the chord is always used as the bass note).</p>	
FULL KEYBOARD	<p>Detects chords in the entire key range. Chords are detected in a way similar to Fingered, even if you split the notes between your left and right hands — for example, playing a bass note with your left hand and a chord with your right, or by playing a chord with your left hand and a melody note with your right.</p>	
AI FINGERED	<p>Basically the same as Fingered, with the exception that less than three notes can be played to indicate the chords (based on the previously played chord, etc.).</p>	
AI FULL KEYBOARD	<p>When this advanced fingering type is engaged, the instrument will automatically create appropriate accompaniment while you play just about anything, anywhere on the keyboard using both hands. You don't have to worry about specifying the Style chords. Although the AI Full Keyboard type is designed to work with many songs, some arrangements may not be suitable for use with this feature. This type is similar to Full Keyboard, with the exception that less than three notes can be played to indicate the chords (based on the previously played chord, etc.). 9th, 11th and 13th chords cannot be played. This type is available only for Style playback.</p>	

Playing Only the Rhythm Channels of a Style

Rhythm is one of the most important parts of a Style. Try to play the melody along with just the rhythm. You can sound different rhythms for each Style. Keep in mind, however, that not all Styles contain rhythm channels.

- 1 Select a Style (page 46).
- 2 Press the [ACMP] to turn Auto Accompaniment off.
- 3 Press the STYLE CONTROL [START/STOP] button to play back the rhythm channels.

Starting the rhythm with Sync Start

You can also start the rhythm simply by playing the keyboard, if Sync Start is enabled (turn on the [SYNC START] button).

4 Press the STYLE CONTROL [START/STOP] button to stop the rhythm.

Turning channels of the Style on/off

A Style contains eight channels: RHY1 (Rhythm 1) – PHR2 (Phrase 2). You can add variations and change the feeling of a Style by selectively turning channels on/off as the Style plays.

- 1 Press the [CHANNEL ON/OFF] button to call up the CHANNEL ON/OFF display.

When the STYLE tab is not selected, press the [CHANNEL ON/OFF] button again.

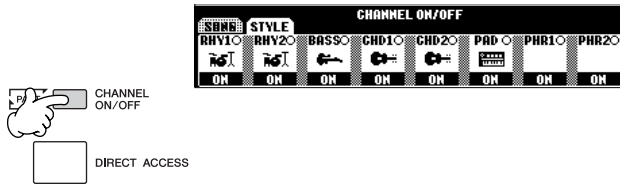

- 2 Press the [1 ▼]–[8 ▼] buttons to turn the channels on or off.

To listen to only one instrument by itself, hold down the appropriate button for the channel to set the channel to SOLO. To cancel SOLO, simply press the appropriate channel button again.

Playing the chords in free tempo (without Style playback)

You can have the accompaniment chords sound without playing back the Style, by setting [ACMP] to on (see page 106, Stop Accompaniment), and [SYNC START] to off. For example, if MULTI FINGER is selected (page 104), you can perform with your own pace while sounding the chord by pressing the chord section of the keyboard with your one finger.

Setting the fade in/out time

You can set the time of the fade in and fade out (pages 48, 49).

- 1 Call up the operation display.

[FUNCTION] → [J] UTILITY → TAB[◀][▶] CONFIG 1 → [A] FADE IN/OUT/HOLD TIME

- 2 Set the parameters by using the [3 ▲ ▼]–[5 ▲ ▼] buttons.

FADE IN TIME	Determines the time it takes for the volume to fade in, or go from minimum to maximum.
FADE OUT TIME	Determines the time it takes for the volume to fade out, or go from maximum to minimum.
FADE OUT HOLD TIME	Determines the time the volume is held at 0 following the fade out.

Style Playback-related Settings

The PSR-OR700 has a variety of Style playback functions which can be accessed in the display below.

- 1 **Call up the operation display.**
[FUNCTION] → [C] STYLE SETTING/SPLIT POINT/CHORD FINGERING → TAB[◀][▶] STYLE SETTING
- 2 **Use the [1 ▲ ▼]-[8 ▲ ▼] buttons for each setting.**

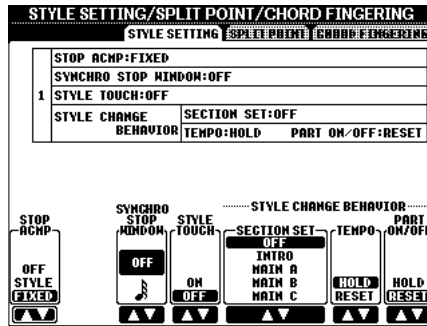

• **Stop Accompaniment**

When [ACMP] is turned on and [SYNC START] is off, you can play chords in the chord section of the keyboard with the Style stopped, and still hear the accompaniment chord. In this condition — called “Stop Accompaniment” — any valid chord fingerings are recognized and the chord root/type are shown in the display. Here, you can determine whether the chord played in the chord section will sound or not in the Stop Accompaniment status.

- OFF** The chord played in the chord section will not sound.
- STYLE** The chord played in the chord section will sound via the Voices of the selected Style.
- FIXED** The chord played in the chord section will sound via the specified Voice, regardless of the selected Style.

• **Synchro Stop Window**

This determines how long you can hold a chord before the Synchro Stop function is automatically cancelled. When the [SYNC STOP] button is turned on and this is set to a value other than “OFF,” this automatically cancels the Synchro Stop function if you hold a chord for longer than the time set here. This conveniently resets Style playback control to normal, letting you release the keys and still have the Style play. In other words, if you release the keys sooner than the time set here, the Synchro Stop function works.

• **Style Touch**

Turns touch response for the Style playback on/off. When this is set to “ON,” the Style volume changes in response to your playing strength in the chord section of the keyboard.

Data that is recorded when recording a Song

Please note that both the Voice that is sounded and the chord data will be recorded when set to “STYLE,” and only the chord data will be recorded when set to “OFF” or “FIXED.”

• **Style Change Behavior**

There are three types as shown below.

Section Set

Determines the default section that is automatically called up when selecting different Styles (when Style playback is stopped). When set to “OFF” and Style playback is stopped, the active section is maintained even if the different Style is selected. When any of the MAIN A-D sections is not included in the Style data, the nearest section is automatically selected. For example, when MAIN D is not contained in the selected Style, MAIN C will be called up.

Tempo

This determines whether the tempo changes or not when you change Styles during Style playback.

HOLD The tempo setting of the previous Style is maintained.

RESET The tempo changes to that of the initial default tempo for the selected Style.

Part On/Off

This determines whether the Style Channel On/Off status changes or not when you change Styles during Style playback.

HOLD The Style Channel On/Off status of the previous Style is maintained.

RESET All Style Channels are set to On.

Split Point Settings

These are the settings (there are two Split Points) that separate the different sections of the keyboard: the Chord section, the LEFT part section and the RIGHT 1 and 2 section. The two Split Point settings (below) are specified as note names.

1 Call up the operation display.

[FUNCTION] → [C] STYLE SETTING/SPLIT POINT/CHORD FINGERING → TAB [◀][▶] SPLIT POINT

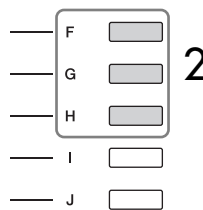
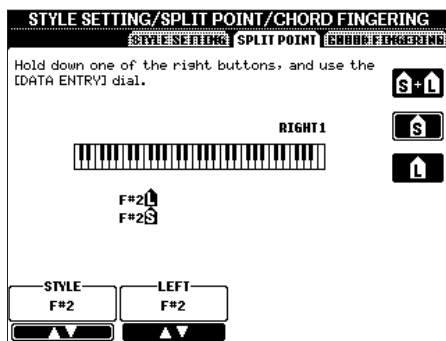

2 Use the [F]–[H] buttons to set the Split Point.

- Split Point (S)—separates the Chord section for Style playback from the section(s) for playing Voices (RIGHT 1, 2 and LEFT)
- Split Point (L)—separates the two sections for playing Voices, LEFT and RIGHT 1- 2.

These two settings can be set to the same note (as in the default) or two different notes as desired.

Specifying the Split Point by note name

Press the [1 ▲ ▼]–[4 ▲ ▼] buttons. You can specify the Split Point of the Voice and chord section of the keyboard by using STYLE in the display, and you can specify the Split Point of the left and right Voices by using LEFT.

Setting the Split Point (S) and the Split Point (L) to the same note

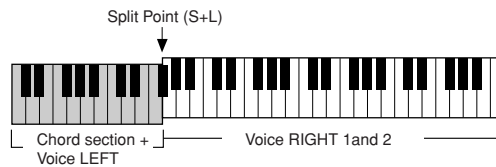

Press the [F] (S+L) button and rotate the DATA ENTRY dial.

Setting the Split Point (S) and the Split Point (L) to different notes

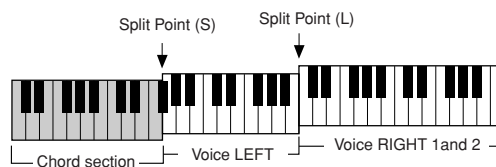

Press the [H] (S) button or the [G] (L) button and rotate the DATA ENTRY dial.

Split Point (L) cannot be set lower than Split Point (S), and Split Point (S) cannot be set higher than Split Point (L).

Editing the Volume and Tonal Balance of the Style (MIXING CONSOLE)

You can set various mixing-related parameters of the Style. (See “Adjustable items (parameters) in the MIXING CONSOLE displays” on page 85.) Call up the “STYLE PART” display in step 3 of the Basic Procedure in “Editing the Volume and Tonal Balance (MIXING CONSOLE)” on page 84, and follow the instructions.

Convenient Music Finder feature

Music Finder (page 55) is a convenient feature that calls up pre-programmed panel settings (for Voices, Styles, etc.) that match the song or type of music you want to play. The records of the Music Finder can be searched and edited.

Searching the Records

You can search the records by specifying a song name or keyword, using the Search function of the Music Finder. You can also save your favorite records in the FAVORITE display.

- 1 Press the [MUSIC FINDER] button to call up the MUSIC FINDER display.
- 2 Press the TAB [◀][▶] buttons to select the ALL tab. The ALL tab display contains all the preset Records.

3 Press the [6▲] (SEARCH 1) button to call up the Search display.

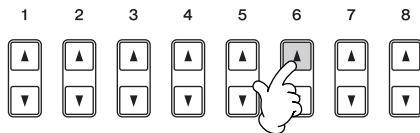
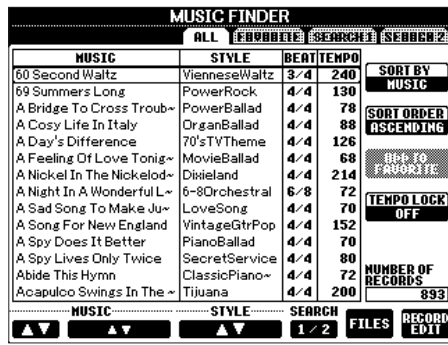

4 Enter the search criteria.

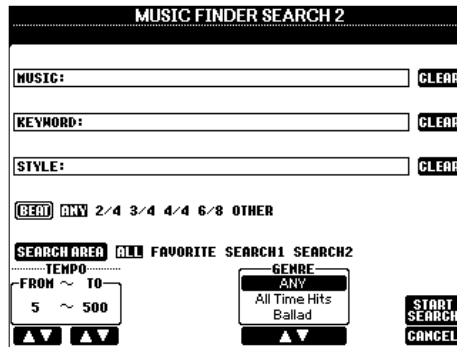

- Search by song title or music genre (MUSIC) or keyword
 - 1 Press the [A] (MUSIC)/[B](KEYWORD) button to call up the character entry display.
 - 2 Enter the song title or music genre, or the keyword (page 71).
- Search by Style name
 - 1 Press the [C] (STYLE) button to call up the Style selection display.
 - 2 Use the [A]–[J] buttons to select a Style.
 - 3 Press the [EXIT] button to return to the search display.

• Adding other Search Criteria

You can specify other search criteria in addition to the song name/keyword/Style name.

- BEAT**Select the beat (time signature) you want to use in your performance by pressing the [D] button. All beat settings are included in the search if you select ANY.
- SEARCH AREA**Select the pages to be included in the search by pressing the [E] button. (These correspond to the tabs at the top of the Music Finder display.)
- TEMPO**.....Set the range of the tempo you want to use in your performance by using the [1▲▼]/[2▲▼] (TEMPO) buttons.
- GENRE**Select the desired music genre by using the [5▲▼]/[6▲▼] (GENRE) buttons.

Clear the search criteria

To clear the entered Music/Keyword/Style, press the [F]/[G]/[H] (CLEAR) button.

Entering several different keywords

You can search several different keywords simultaneously by inserting a separator (comma) between each.

- 5 Press the [8▲] (START SEARCH) button to start the search. The Search 1 display appears, showing the results of the search. To cancel searching, press the [8▼] (CANCEL) button.

Searching other music genres

When you want to search other music genres, press the [6▼] (SEARCH 2) button in the Music Finder display. The search result is displayed in the SEARCH 2 display.

Calling up the panel settings to match the style (REPertoire)

When searching by style name, the same search result is obtained even if the search is done by using the Repertoire function. See page 56 for details.

Creating a Set of Favorite Records

As convenient as the Search function is in plumbing the depths of the Music Finder records, you may want to create a “folder” of favorite records — so you can quickly call up those Styles and settings you use most often in your performance.

- 1 Select the desired record from the Music Finder display.
- 2 Press the [H] (ADD TO FAVORITE) button to add the selected record to the FAVORITE display.

MUSIC	STYLE	BEAT	TEMPO
60 Second Waltz	VienneseWaltz	3/4	240
69 Summers Long	PowerRock	4/4	130
A Bridge To Cross Troub-	PowerBallad	4/4	78
A Cozy Life In Italy	OrganBallad	4/4	98
A Day's Difference	70'sTVTheme	4/4	126
A Feeling Of Love Tonig~	MovieBallad	4/4	68
A Nickel In The Nickelod~	Dixieland	4/4	214
A Night In A Wonderful L~	6-8Orchestral	6/8	72
A Sad Song To Make Ju~	LoveSongs	4/4	70
A Song For New England	VintageGtrPop	4/4	152
A Spy Does It Better	PianoBallad	4/4	70
A Spy Lives Only Twice	SecretService	4/4	80
Abide This Hymn	ClassicPiano~	4/4	72
Acapulco Swings In The ~	Tijuana	4/4	200

Control Panel: MUSIC, STYLE, SEARCH 1/2, FILES, RECORD EDIT, SORT BY MUSIC, SORT ORDER ASCENDING, ADD TO FAVORITE (H), TEMPO LOCK OFF, NUMBER OF RECORDS 893

- 3 Call up the FAVORITE display by using the TAB [◀][▶] buttons, and check to see if the record has been added.

Deleting Records from the FAVORITE Display

- 1 Select the record you want to delete from the FAVORITE display.
- 2 Press the [H] (DELETE FROM FAVORITE) button.

Editing Records

You can create a new record by editing the currently selected record. The newly created records are automatically saved in the internal memory.

- 1 Select the desired record to be edited in the Music Finder display.
- 2 Press the [8 ▲ ▼] (RECORD EDIT) button to call up the Edit display.



- 3 Edit the record as desired.

- **Editing the song name/keyword/Style name**
Input each item in the same way as done in the Search display (page 109).
- **Changing the Tempo**
Press the [1 ▲ ▼] (TEMPO) button.
- **Memorizing the Section (Intro/Main/Ending)**
Use the [2 ▲ ▼]/[4 ▲ ▼] buttons to select the section that will automatically be called up set when the record is selected. This is useful, for example, when you want to have a selected Style automatically be set up to start with an Intro section.
- **Editing the Genre**
Select the desired genre by using the [5 ▲ ▼]/[6 ▲ ▼] (GENRE) buttons. When creating a new genre, press the [7 ▲ ▼] (GENRE NAME) button and input the genre name. (page 71)
- **Deleting the Currently Selected Record**
Press the [I] (DELETE RECORD) button.
- **Canceling and Quitting the Edit functions**
Press the [8 ▼] (CANCEL) button.

- 4 To enter the edited record to the FAVORITE display, press the [E] (FAVORITE) button to turn on the FAVORITE.

- 5 Enter the edits you've made to the record as described below.

- **Creating a new record**
Press the [J] (NEW RECORD) button. The record is added to the ALL display. If you've entered the record to the FAVORITE display in step 4 above, the record is added to both the ALL display and the FAVORITE display.
- **Overwriting an existing record**
Press the [8 ▲] (OK) button. If you set the record as a Favorite in step 4 above, the record is added to the FAVORITE display. When you edit the record in the FAVORITE display, the record is overwritten.

⚠ CAUTION

You can also change a preset record to create a new one. If you want to keep the original preset, make sure to change the name and register the edited record as a new record (see step 5, page 111).

Keep in mind that the Beat setting made here is only for the Music Finder search function; this does not affect the actual Beat setting of the Style itself.

The maximum number of records is 1200, including internal records.

Saving the Record

The Music Finder feature handles all the Records including the presets and additionally created records as a single file. Keep in mind that individual records (panel setups) cannot be handled as separate files.

- 1 Call up the Save display.**
[MUSIC FINDER] → TAB [◀][▶] ALL → [7 ▲ ▼] (FILES)
- 2 Press the TAB [◀][▶] buttons to select the location for saving (USER/USB).**
- 3 Press the [6 ▼] button to save the file (page 67).**
All records are saved together as a single file.

Calling up Music Finder Records Saved to USER/USB

To call up the Music Finder records you've saved to USER/USB, follow the instructions below.

- 1 Call up the [MUSIC FINDER] display.
[MUSIC FINDER] → TAB [◀][▶] ALL
- 2 Press the [7▲▼] (FILES) button to open the File selection display of the Music Finder.
- 3 Use the TAB [◀][▶] buttons to select USER/USB.
- 4 Press the [A]–[J] buttons to select the desired Music Finder file.

When the file is selected, a message is displayed according to the content of the file. Press the desired button.

- **REPLACE**

All Music Finder records currently in the instrument are deleted and replaced with the records of the selected file.

- **APPEND**

The records called up are added to the records currently in the instrument.

Execute the operation to call up the Music Finder file. Select "CANCEL" to abort this operation.

CAUTION

Selecting "REPLACE" automatically deletes all your original records from internal memory and replaces them with the factory Music Finder data.

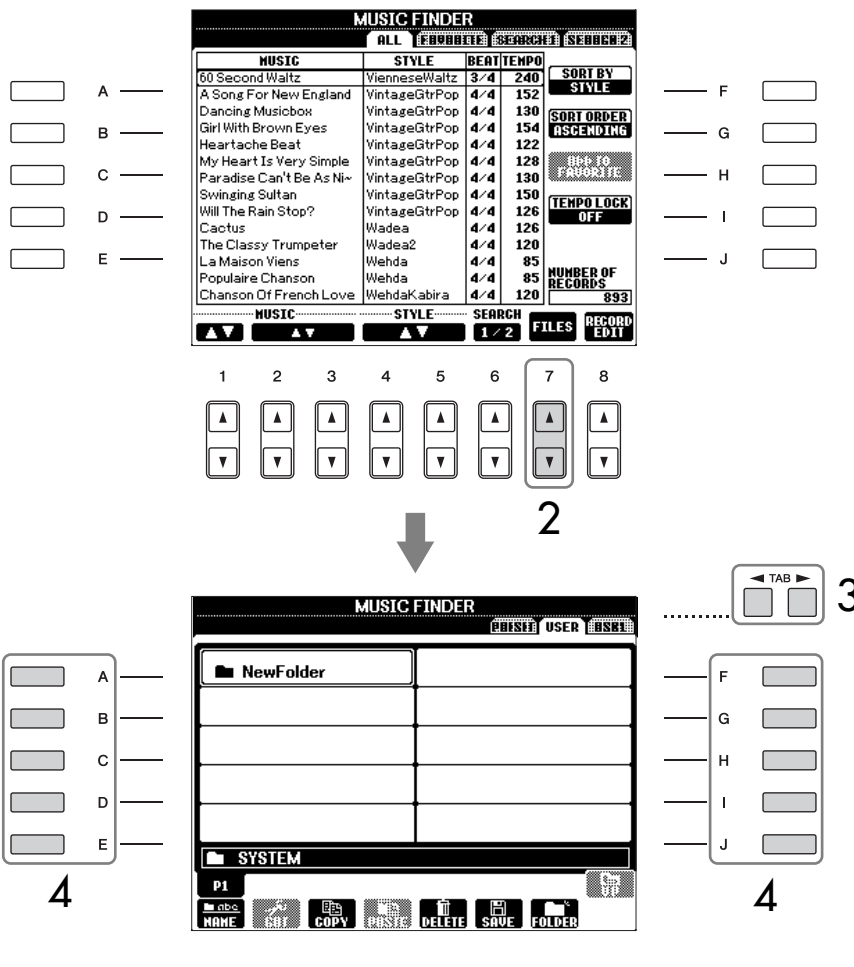

Restoring the Music Finder Data

You can restore the instrument's Music Finder to its original factory settings (page 72).

Style Creator

You can create your own styles — recording them by yourself or by combining the internal Style data. The created Styles can be edited.

Style Structure

Styles are made up of fifteen different sections and each section has eight separate channels. With the Style Creator feature, you can create a Style by separately recording the channels, or by importing pattern data from other existing Styles.

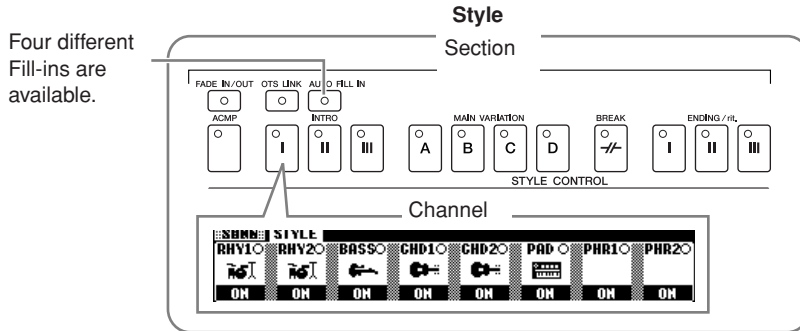

Creating a Style

You can use one of the three different methods described below to create a Style. The created Styles can also be edited (page 120).

■ Realtime Recording ▶ See page 115

This method lets you record the Style by simply playing the instrument. You can select an internal Style that most closely matches your image of the Style you want to create and then re-record parts of the Style as desired, or you can create a new Style from scratch.

■ Step Recording ▶ See page 118

This method is like writing music notation on paper, since it allows you to enter each note or individually, and specify its length. This allows you to create a Style without having to play the parts on the instrument, since you can enter each event manually.

■ Style Assembly ▶ See page 119

This convenient feature lets you create composite Styles by combining various patterns from the internal preset Styles. For example, if you want to create your own original 8-beat Style, you could take rhythm patterns from the “70’s 8Beat” Style, use the bass pattern from “60’s Rock1” Style and import the chord patterns from the “Cool8Beat” Style — combining the various elements to create one Style.

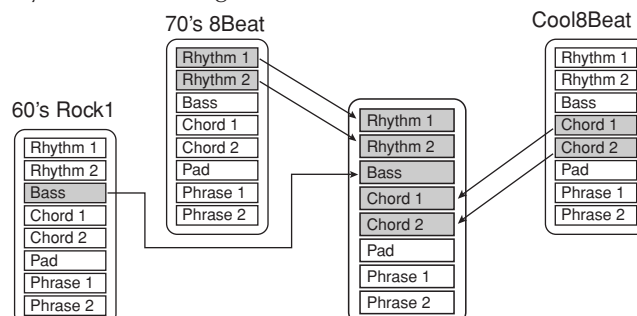

Realtime Recording (BASIC)

Create a single Style by recording the individual channels one-by-one, using realtime recording.

Realtime Recording Characteristics

• Loop Recording

Style playback repeats the rhythm patterns of several measures in a “loop,” and Style recording is also done using loops. For example, if you start recording with a two-measure main section, the two measures are repeatedly recorded. Notes that you record will play back from the next repetition (loop), letting you record while hearing previously recorded material.

• Overdub Recording

This method records new material to a channel already containing recorded data, without deleting the original data. In Style recording, the recorded data is not deleted, except when using functions such as Rhythm Clear (page 117) and Delete (page 116). For example, if you start recording with a two-measure MAIN section, the two measures are repeated many times. Notes that you record will play back from the next repetition, letting you overdub new material to the loop while hearing previously recorded material.

When creating a Style based on an existing internal Style, overdub recording is applied only to the rhythm channels. For all other channels (except rhythm), delete the original data before recording.

When using realtime recording based on the internal Styles:

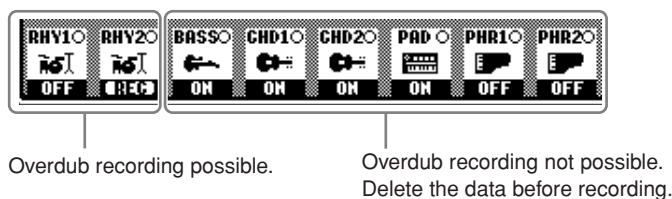

- 1 **Select the desired Style to serve as the basis for recording/editing (page 46).**
When creating a new Style from scratch, press the [C] (NEW STYLE) button from the display shown in step 5 below.
- 2 **Call up the operation display.**
[FUNCTION] → [F] DIGITAL REC MENU
- 3 **Press the [B] button to call up the Style Creator display.**
- 4 **Use the TAB [◀][▶] buttons, then select the BASIC tab to call up the RECORD display.**
- 5 **Call up the display for selecting sections, etc. by pressing the [EXIT] button.**

When recording channels BASS-PHR2 based on an internal Style, delete the original data before recording. Overdub recording is not possible on channels BASS-PHR2.

When the RECORD display (channel indication) at the lower part of the STYLE CREATOR display disappears, you can press the [F] (REC CH) button to re-display it.

Specifying sections from the panel buttons

You can specify the sections to be recorded by using the Section buttons ([INTRO]/[MAIN]/[ENDING], etc.) on the panel. Pressing one of the Section buttons calls up the SECTION display. Change the sections by using the [6▲▼]/[7▲▼] buttons and execute the selection by pressing the [8▲] button.

The INTRO 4/ENDING 4 sections cannot be specified with the panel controls.

6 Use the [3▲▼]/[4▲▼] buttons to select the section (page 114) to be recorded.

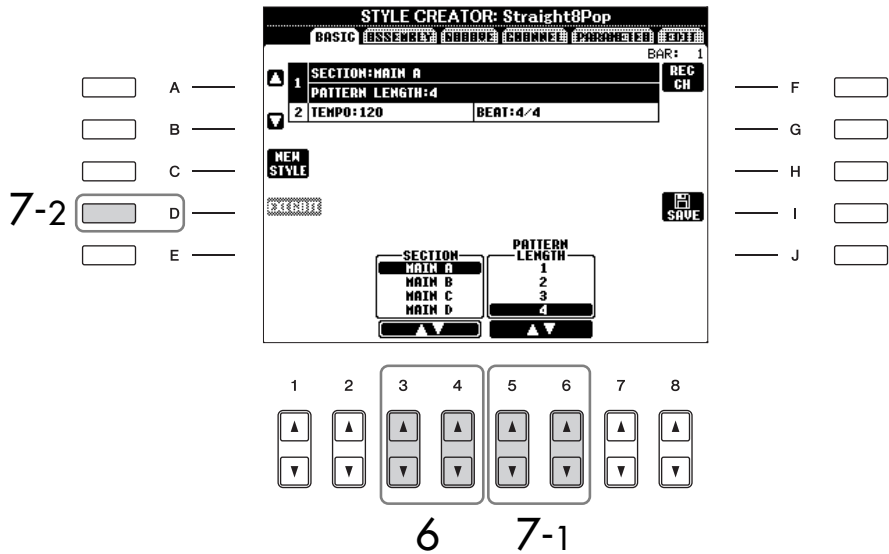

7 Use the [5▲▼]/[6▲▼] buttons to determine the length (number of measures) of the selected section.

Actually enter the specified length for the selected section by pressing the [D] (EXECUTE) button.

8 Specify the channel to be recorded by simultaneously holding down the [F] (REC CH) button and pressing the appropriate numbered button, [1▼]–[8▼].

To cancel the selection, press the appropriate numbered button [1▼]–[8▼] again.

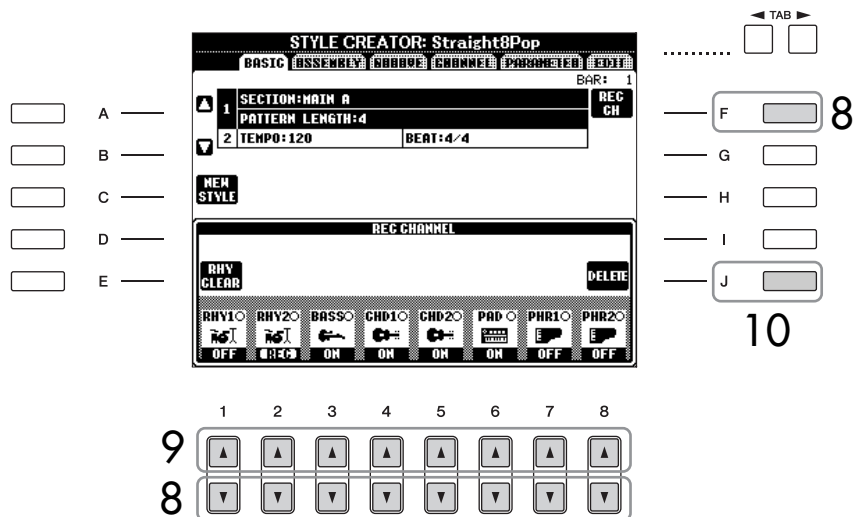

Recordable Voices

- **RHY1 channel:** Any except Organ Flute Voices are recordable.
- **RHY2 channel:** Only drum/SFX kits are recordable.
- **BASS-PHR2 channels:** Any except Organ Flute Voices and Drum/SFX kits are recordable. (Preset Organ Flute Voices can be selected only on the LCD display.)

9 Call up the Voice Selection display by using the [1▲]–[8▲] buttons and select the desired Voice for the corresponding recording channels. Press the [EXIT] button to return to the previous display.

10 To delete a channel, simultaneously hold down the [J] (DELETE) button and press the appropriate numbered button, [1▲]–[8▲]. You can cancel the deletion by pressing the same numbered button again, before releasing your finger from the [J] button.

- 11 **Start recording by pressing the Style Control [START/STOP] button.**
Playback of the specified section starts. Since the accompaniment pattern plays back repeatedly in a loop, you can record individual sounds one by one, listening to the previous sounds as they play. For information on recording to channels other than the rhythm channels (RHY1, 2), refer to the section "Rules when recording non-rhythm channels" (see below).
- 12 **To continue recording with another channel, simultaneously hold down the [F] (REC CH) button and press the appropriate [1▼]–[8▼] button to specify the channel, then play the keyboard.**
- 13 **Stop recording by pressing the Style Control [START/STOP] button.**
- 14 **Call up the display for selecting sections, etc. by pressing the [EXIT] button.**
- 15 **Press the [I] (SAVE) button to call up the Style Selection display to save your data.**
Save the data in the Style Selection display (page 67).

Rules when recording non-rhythm channels

- Use only the CM7 scale tones when recording the BASS and PHRASE channels (i.e., C, D, E, G, A, and B).
- Use only the chord tones when recording the CHORD and PAD channels (i.e., C, E, G, and B).



C = Chord notes
C, R = Recommended notes

Using the data recorded here, the auto accompaniment (Style playback) is appropriately converted depending on the chord changes you make during your performance. The chord which forms the basis for this note conversion is called the Source Chord, and is set by default to CM7 (as in the example illustration above). You can change the Source Chord (its root and type) from the PARAMETER display on page 124. Keep in mind that when you change the Source Chord from the default CM7 to another chord, the chord notes and recommended notes will also change. For details on chord notes and recommended notes, see page 125.

Deleting the recorded rhythm channel (RHY 1, 2)

To delete a specific instrument sound, simultaneously hold down the [E] (RHY CLEAR) button (from the display where the recorded channels are shown) and press the appropriate key.

⚠ CAUTION

The recorded Style will be lost if you change to another Style or you turn the power off without executing the Save operation (page 67).

Any desired chord or chord progression can be used for the INTRO and ENDING sections.

Changing the Source Chord

If you want to record the pattern with a Source Chord other than CM7, set the PLAY ROOT and PLAY CHORD parameters on the PARAMETER page (page 124) before recording.

Step Recording (EDIT)

The explanation here applies when selecting the EDIT tab in step 4 of “Realtime Recording” (page 115).

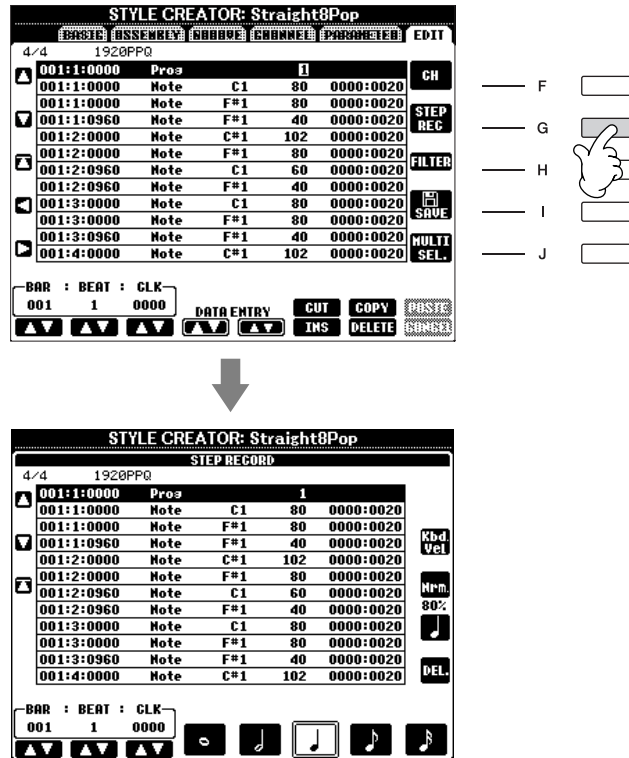

In the EDIT display, you can record notes with absolutely precise timing. This Step Recording procedure is essentially the same as that for Song Recording (page 148), with the exception of the points listed below:

- In the Song Creator, the End Mark position can be changed freely; in the Style Creator, it cannot be changed. This is because the length of the Style is automatically fixed, depending on the selected section. For example, if you create a Style based on a section of four measures length, the End Mark position is automatically set to the end of the fourth measure, and cannot be changed in the Step Recording display.
- Recording channels can be changed in the Song Creator 1-16 tab display; however, they cannot be changed in the Style Creator. Select the recording channel in the BASIC tab display.
- In the Style Creator, the channel data can be entered and System Exclusive data can be edited (delete, copy, or move). You can switch between the two by pressing the [F] button. However, Chord, Lyrics, and System Exclusive data cannot be entered.

Style Assembly (ASSEMBLY)

Style Assembly allows you to create a single Style by mixing the various patterns (channels) from existing internal Styles.

- 1 Select the basic Style, then call up the display for Style Assembly.**
The operation steps are the same as steps 1–4 in “Realtime recording” (page 115). In step 4, select the ASSEMBLY tab.
- 2 Select the desired section (Intro, Main, Ending, etc.) for your new Style.**
Call up the SECTION display by pressing one of the Section buttons ([INTRO]/[MAIN]/[ENDING], etc.) on the panel. Change the section as desired by using the [6 ▲ ▼]/[7 ▲ ▼] buttons and execute the operation by pressing the [8 ▲] (OK) button.

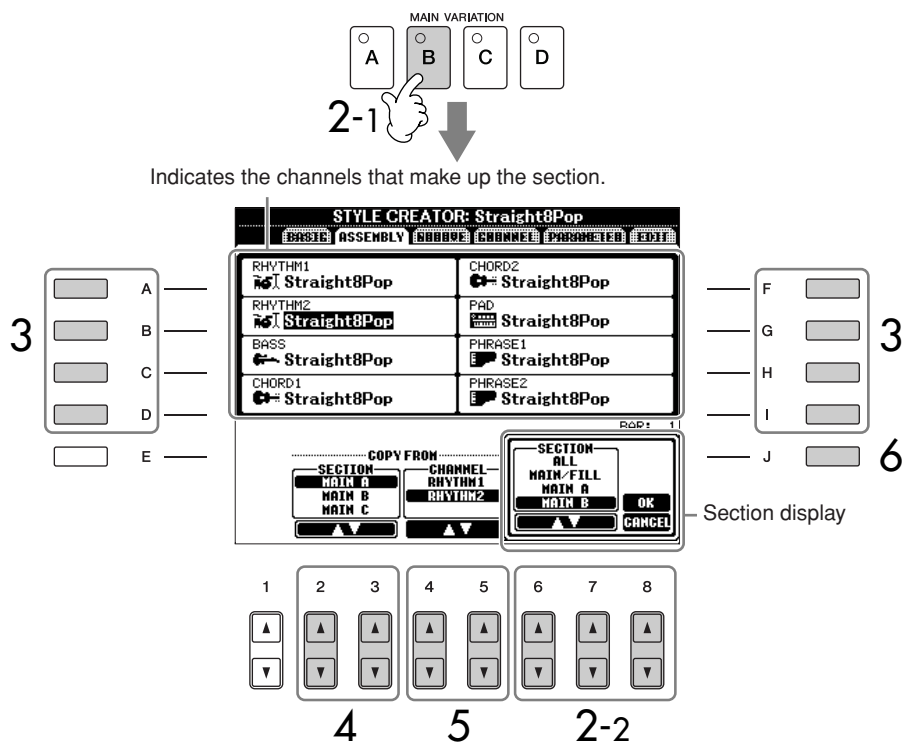

- 3 Select the channel for which you wish to replace the pattern by using the [A]–[D] and [F]–[I] buttons. Call up the Style Selection display by pressing the same button again. Select the Style containing the pattern you want to replace in the Style Selection display.**
To return to the previous screen, press the [EXIT] button after selecting the Style.
- 4 Select the desired section of the newly imported Style (chosen in step 3 above) by using the [2 ▲ ▼]/[3 ▲ ▼] (SECTION) buttons.**
- 5 Select the desired channel for the section (chosen in step 4 above) by using the [4 ▲ ▼]/[5 ▲ ▼] (CHANNEL) buttons.**
Repeat steps 3–5 above to replace the patterns of other channels.
- 6 Press the [J] (SAVE) button to call up the Style Selection display, and save your data from the display (page 67).**

You cannot select the SECTION INTRO 4/ENDING 4 directly via the panel operation.

⚠ CAUTION
The recorded Style will be lost if you change to another Style or you turn the power off without executing the Save operation (page 67).

Selecting a file saved to the USB storage device.

You can also select a specified file in the USB storage device by pressing the [USB] button.

[USB] → [B] STYLE → [A]–[I]

Playing the Style During Style Assembly

While you are assembling a Style, you can play back the Style and select the method of playback. Use the [6 ▲ ▼]/[7 ▲ ▼] (PLAY TYPE) buttons in the Style Assembly display to select the playback method.

- **SOLO**

Mutes all but the selected channel in the ASSEMBLY tab display. Any channels set to ON in the RECORD display on the BASIC page are played back simultaneously.

- **ON**

Plays back the selected channel in the ASSEMBLY tab display. Any channels set to something other than OFF in the RECORD display on the BASIC page are played back simultaneously.

- **OFF**

Mutes the selected channel in the ASSEMBLY tab display.

Editing the Created Style

You can edit the Style you've created by using Realtime recording, Step recording and/or Style Assembly.

Basic Operation for Editing Styles

- 1 **Select a Style to be edited.**
- 2 **Call up the operation display.**
[FUNCTION] → [F] DIGITAL REC MENU
- 3 **Call up the Style Creator/Edit display by pressing the [B] button.**
- 4 **Press the TAB[◀][▶] buttons to select a tab.**
 - **Changing the Rhythmic Feel (GROOVE) ▶ See page 121**
These versatile features give you a wide variety of tools for changing the rhythmic feel of your created Style.
 - **Editing Data for each Channel (CHANNEL) ▶ See page 123**
The editing features let you delete data as desired and apply quantize settings for each channel in the Style data.
 - **Making Style File Format Settings (PARAMETER) ▶ See page 124**
For playback of your created Style, you can decide how notes will be converted and sounded for the accompaniment when changing chords in the chord section of the keyboard.
- 5 **Edit the selected Style.**

Changing the Rhythmic Feel (GROOVE)

The explanation here applies when you select the GROOVE tab in step 4 of “Basic Operation for Editing Styles” (page 120).

- 1 Press the [A]/[B] button to select the edit menu (page 122).

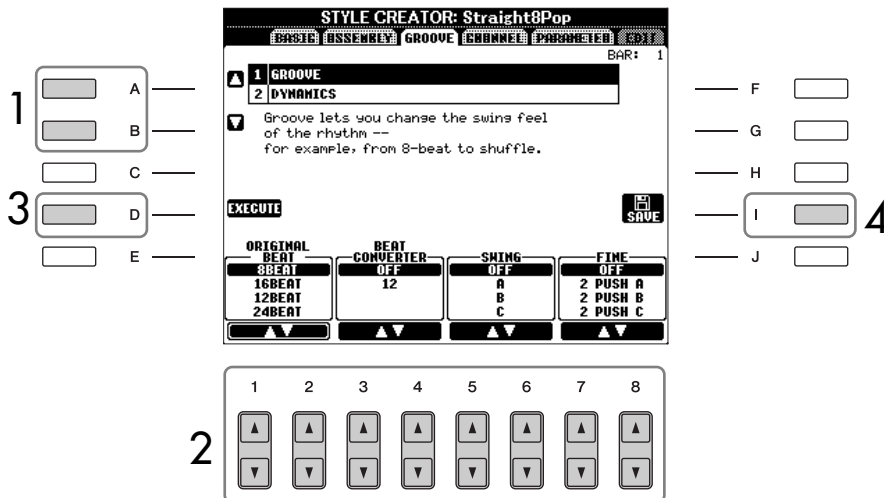

- 2 Use the [1 ▲ ▼]–[8 ▲ ▼] buttons to edit the data.
For details on editable parameters, see page 122.
- 3 Press the [D] (EXECUTE) button to actually enter the edits for each display.
After the operation is completed, you can execute the edition and this button changes to “UNDO,” letting you restore the original data if you’re not satisfied with the Groove or Dynamics results. The Undo function only has one level; only the previous operation can be undone.
- 4 Press the [I] (SAVE) button to call up the Style Selection display to save your data.
Save the data in the Style Selection display (page 67).

CAUTION
The edited Style will be lost if you change to another Style or you turn the power off without executing the Save operation (page 67).

■ GROOVE

This lets you add swing to the music or change the “feel” of the beat by making subtle shifts in the timing (clock) of the Style. The Groove settings are applied to all channels of the selected Style.

ORIGINAL BEAT	Specifies the beats to which Groove timing is to be applied. In other words, if “8 Beat” is selected, Groove timing is applied to the 8th notes; if “12 Beat” is selected, Groove timing is applied to 8th-note triplets.
BEAT CONVERTER	Actually changes the timing of the beats (specified in the ORIGINAL BEAT parameter above) to the selected value. For example, when ORIGINAL BEAT is set to “8 Beat” and BEAT CONVERTER is set to “12,” all 8th notes in the section are shifted to 8th-note triplet timing. The “16A” and “16B” Beat Converter which appear when ORIGINAL BEAT is set to “12 Beat” are variations on a basic 16th-note setting.
SWING	Produces a “swing” feel by shifting the timing of the back beats, depending on the ORIGINAL BEAT parameter above. For example, if the specified ORIGINAL BEAT value is “8 Beat,” the Swing parameter will selectively delay the 2nd, 4th, 6th, and 8th beats of each measure to create a swing feel. The settings “A” through “E” produce different degrees of swing, with “A” being the most subtle and “E” being the most pronounced.
FINE	Selects a variety of Groove “templates” to be applied to the selected section. The “PUSH” settings cause certain beats to be played early, while “HEAVY” settings delay the timing of certain beats. The numbered settings (2, 3, 4, 5) determine which beats are to be affected. All beats up to the specified beat — but not including the first beat — will be played early or delayed (for example, the 2nd and 3rd beats, if “3” is selected). In all cases, “A” types produce minimum effect, “B” types produce medium effect, and “C” types produce maximum effect.

■ DYNAMICS

This changes the velocity/volume (or accent) of certain notes in the Style playback. The Dynamics settings are applied to each channel or all channels of the selected Style.

CHANNEL	Selects the desired channel (part) to which Dynamics is to be applied.
ACCENT TYPE	Determines the type of accent applied — in other words, which notes in the part(s) are emphasized with the Dynamics settings.
STRENGTH	Determines how strongly the selected Accent Type (above) will be applied. The higher the value, the stronger the effect.
EXPAND/COMP.	Expands or compresses the range of velocity values. Values higher than 100% expand the dynamic range, while values lower than 100% compress it.
BOOST/CUT	Boosts or cuts all velocity values in the selected section/channel. Values above 100% boost the overall velocity, while values below 100% reduce it.

Editing Data for Each Channel (CHANNEL)

The explanation here applies when you select the CHANNEL tab in step 4 of "Basic Operation for Editing Styles" (page 120).

1 Press the [A]/[B] button to select the edit menu (see below).

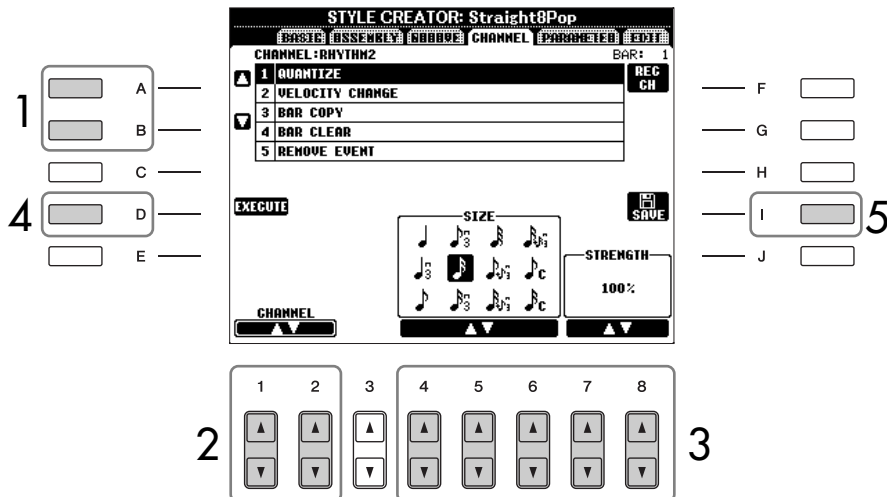

2 Use the [1 ▲ ▼]/[2 ▲ ▼] (CHANNEL) buttons to select the channel to be edited.

The selected channel is shown at the upper left of the display.

3 Use the [4 ▲ ▼]–[8 ▲ ▼] buttons to edit the data.

For details on editable parameters, see below.

4 Press the [D] (EXECUTE) button to actually enter the edits for each display.

After the operation is completed, you can execute the edition and this button changes to [UNDO], letting you restore the original data if you're not satisfied with the results of the edit. The Undo function only has one level; only the previous operation can be undone.

5 Press the [I] (SAVE) button to call up the Style Selection display to save your data.

Save the data in the Style Selection display (page 67).

QUANTIZE	Same as in the Song Creator (page 161), with the exception of the two additional available parameters below. ♪ [°] Eighth notes with swing ♪ [°] Sixteenth notes with swing
VELOCITY CHANGE	Boosts or cuts the velocity of all notes in the specified channel, according to the percentage specified here.
BAR COPY	This function allows data to be copied from one measure or group of measures to another location within the specified channel. SOURCE specifies the first (TOP) and last (LAST) measures in the region to be copied. DEST specifies the first measure of the destination location, to which the data is to be copied.
BAR CLEAR	This function clears all data from the specified range of measures within the selected channel.
REMOVE EVENT	This function lets you remove specific events from the selected channel.

⚠ CAUTION
 The edited Style will be lost if you change to another Style or you turn the power off without executing the save operation.

Editing of Style File Format data is related only to note conversion. Editing the rhythm channels has no effect.

Making Style File Format Settings (PARAMETER) Special Parameter Settings Based on Style File Format

Source Pattern
SOURCE ROOT
(Chord Root setting of a Source Pattern)
SOURCE CHORD
(Chord Type setting of a Source Pattern)

↓ Chord change via the chord section of the keyboard.

Note Transposition
NTR
(Note Transposition Rule applied to the Chord Root change)
NTT
(Note Transposition Table applied to the Chord Type change)



Other Settings
HIGH KEY
(Upper limit of the octaves of the note transposing caused by the Chord Root change)
NOTE LIMIT (Note range in which the note is sounded)
RTR
(Retrigger Rules that determine how notes held through chord changes will be handled)



Output

The Style File Format (SFF) combines all of Yamaha's auto accompaniment (Style playback) know-how into a single unified format. By using the Style Creator, you can take advantage of the power of the SFF format and freely create your own Styles.

The chart shown at left indicates the process by which the Style is played back. (This does not apply to the rhythm track.) These parameters can be set via the Style Creator feature.

• **Source Pattern**

There are a variety of possibilities for Style playback notes, depending on the particular root note and chord type that are selected. The Style data is appropriately converted depending on the chord changes you make during your performance. This basic Style data that you create with the Style Creator is referred to as the "Source Pattern."

• **Note Transposition**

This parameter group features two parameters that determine how the notes of the Source Pattern are to be converted in response to chord changes.

• **Other Settings**

Using the parameters of this group, you can fine-tune how Style playback responds to the chords you play. For example, the Note Limit parameter allows you to have the Voices of the Style sound as realistic as possible by shifting the pitch to an authentic range — ensuring that no notes sound outside the natural range of the actual instrument (e.g., very low notes of a piccolo sound).

The explanation here applies when you select the PARAMETER tab in step 4 of "Basic Operation for Editing Styles" (page 120).

1 Press the [A]/[B] button to select the edit menu (page 125).

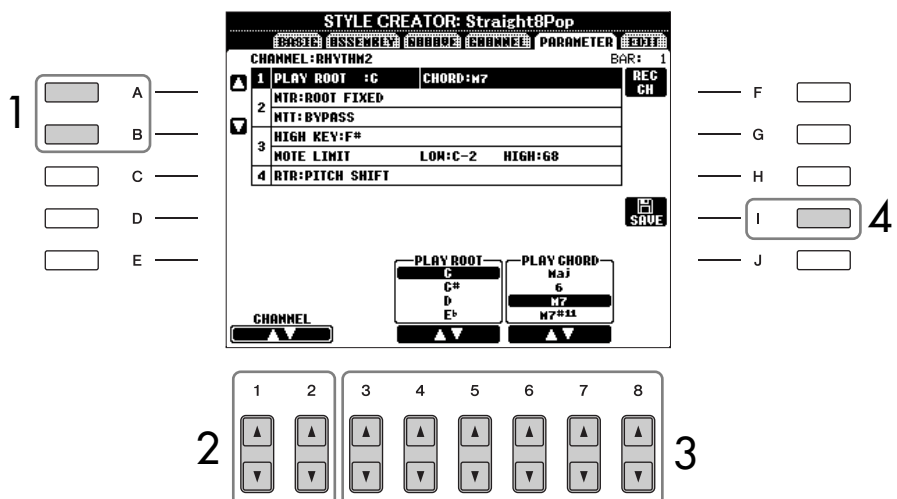

- 2 Use the [1▲▼]/[2▲▼] (CHANNEL) buttons to select the channel to be edited.
The selected channel is shown at the upper left of the display.
- 3 Use the [3▲▼]–[8▲▼] buttons to edit the data.
For details on editable parameters, see below.
- 4 Press the [I] (SAVE) button to call up the Style Selection display to save your data.
Save the data in the Style Selection display (page 67).

⚠ CAUTION

The edited Style will be lost if you change to another Style or you turn the power off without executing the Save operation.

■ PLAY ROOT/CHORD

These settings determine the original key of the source pattern (i.e., the key used when recording the pattern). The default setting of CM7 (with a Play Root of “C” and a Chord Type of “M7”), is automatically selected whenever the preset data is deleted prior to recording a new Style, regardless of the Source Root and Chord included in the preset data. When you change Source Root/Chord from the default CM7 to another chord, the chord notes and recommended notes will also change, depending on the newly selected chord type.

Auditioning Your Style with a Specific Chord

Normally in the Style Creator, you can hear your original Style-in-process with the Source Pattern. However, there is a way to hear it played by a specific chord and root. To do this, set NTR to “Root Fixed,” NTT to “Bypass,” and NTT BASS to “OFF” then change the newly displayed “Play Root” and “Play Chord” parameters to the desired settings.

When the Play Root is C:

C = Chord notes C, R = Recommended notes

■ NTR (Note Transposition Rule)

This determines the relative position of the root note in the chord, when converted from the Source Pattern in response to chord changes.

<p>ROOT TRANS (Root Transpose)</p>	<p>When the root note is transposed, the pitch relationship between notes is maintained. For example, the notes C3, E3 and G3 in the key of C become F3, A3 and C4 when they are transposed to F. Use this setting for channels that contain melody lines.</p>	<p>When playing a C major chord. When playing an F major chord.</p>
<p>ROOT FIXED</p>	<p>The note is kept as close as possible to the previous note range. For example, the notes C3, E3 and G3 in the key of C become C3, F3 and A3 when they are transposed to F. Use this setting for channels that contain chord parts.</p>	<p>When playing a C major chord. When playing an F major chord.</p>

■ NTT (Note Transposition Table)

This sets the note transposition table for the source pattern.

BYPASS	When NTR is set to ROOT FIXED, the transposition table used does not do any note conversion. When NTR is set to ROOT TRANS, the table used only converts the root note.
MELODY	Suitable for melody line transposition. Use this for melody channels such as Phrase 1 and Phrase 2.
CHORD	Suitable for chord transposition. Use this for the Chord 1 and Chord 2 channels, especially when they contain piano or guitar-like chordal parts.
MELODIC MINOR	When the played chord changes from a major to a minor chord, this table lowers the third interval in the scale by a semitone. When the chord changes from a minor to a major chord, the minor third interval is raised by a semitone. Other notes are not changed. Use this for melody channels of Sections which respond only to major/minor chords, such as Intros and Endings.
MELODIC MINOR 5th	In addition to the Melodic Minor transposition above, augmented and diminished chords affect the 5th note of the Source Pattern.
HARMONIC MINOR	When the played chord changes from a major to a minor chord, this table lowers the third and sixth intervals in the scale by a semitone. When the chord changes from a minor to a major chord, the minor third and flatted sixth intervals are raised by a semitone. Other notes are not changed. Use this for chord channels of Sections which respond only to major/minor chords, such as Intros and Endings.
HARMONIC MINOR 5th	In addition to the Harmonic Minor transposition above, augmented and diminished chords affect the 5th note of the Source pattern.
NATURAL MINOR	When the played chord changes from a major to a minor chord, this table lowers the third, sixth and seventh intervals in the scale by a semitone. When the chord changes from a minor to a major chord, the minor third, flatted sixth and flatted seventh intervals are raised by a semitone. Other notes are not changed. Use this for chord channels of Sections which respond only to a Major/minor chord such as Intros and Endings.
NATURAL MINOR 5th	In addition to the Natural Minor transposition above, augmented and diminished chords affect the 5th note of the Source pattern.
DORIAN	When the played chord changes from a major to a minor chord, this table lowers the third and seventh intervals in the scale by a semitone. When the chord changes from a minor to a major chord, the minor third and flatted seventh intervals are raised by a semitone. Other notes are not changed. Use this for chord channels of Sections which respond only to a Major/minor chord such as Intros and Endings.
DORIAN 5th	In addition to the Dorian transposition above, augmented and diminished chords affect the 5th note of the Source pattern.

■ NTT BASS ON/OFF

The channels for which this is set to ON will be played back by the bass root note, when the on-bass chord is recognized by the instrument.

■ HIGH KEY

This sets the highest key (upper octave limit) of the note transposition for the chord root change. Any notes calculated to be higher than the highest key are transposed down to the next lowest octave. This setting is available only when the NTR parameter (page 125) is set to "Root Trans."

Example — When the highest key is F.

Root changes → CM C#M . . . FM F#M . . .
 Notes played → C3-E3-G3 C#3-F3-G#3 F3-A3-C4 F#2-A#2-C#3



■ NOTE LIMIT

This sets the note range (highest and lowest notes) for voices recorded to the style channels. By judicious setting of this range, you can ensure that the voices sound as realistic as possible — in other words, that no notes outside the natural range are sounded (e.g., high bass sounds or low piccolo sounds). The actual notes that sound are automatically shifted to the set range.

Example — When the lowest note is C3 and the highest is D4.

Root changes → CM C#M . . . FM . . .

Notes played → E3-G3-C4 F3-G#3-C#4 F3-A3-C4

The musical notation shows three chords on a treble clef staff. The first chord is C Major (CM) with notes E3, G3, and C4. The second chord is C# Major (C#M) with notes F3, G#3, and C#4. The third chord is F Major (FM) with notes F3, A3, and C4. Dashed lines indicate a 'High Limit' at D4 and a 'Low Limit' at C3. The notes in the chords are positioned within this range.

■ RTR (Retrigger Rule)

These settings determine whether notes stop sounding or not and how they change pitch in response to chord changes.

STOP	The notes stop sounding.
PITCH SHIFT	The pitch of the note will bend without a new attack to match the type of the new chord.
PITCH SHIFT TO ROOT	The pitch of the note will bend without a new attack to match the root of the new chord.
RETRIGGER	The note is retriggered with a new attack at a new pitch corresponding to the next chord.
RETRIGGER TO ROOT	The note is retriggered with a new attack at the root note of the next chord. However, the octave of the new note remains the same.

Reference to Quick Guide pages

The Multi Pads page 52

Multi Pad Creating (Multi Pad Creator)

This feature lets you create your original Multi Pad phrases, and also allows you to edit existing Multi Pad phrases to create your own.

Multi Pad Realtime Recording

- 1** Select a Multi Pad Bank to be edited or created (page 130).
- 2** Call up the operation display.
[FUNCTION] → [F] DIGITAL REC MENU
- 3** Press the [C] button to call up the Multi Pad Creator display.
- 4** Press the TAB [◀] button to select the RECORD tab.
- 5** Press any of the [A], [B], [F], and [G] buttons to select a Multi Pad to be edited or created.
If you want to create the Multi Pad data from scratch, press the [C] button to call up an empty bank.
- 6** Press the [H] (REC) button to enter the recording standby status for the Multi Pad selected in step 5.
- 7** Start recording.
Recording begins automatically as soon as you play the keyboard. You can also start recording by pressing the STYLE CONTROL [START/STOP] button. This lets you record as much silence as you want before the start of the Multi Pad phrase.
If Chord Match is set to on for the Multi Pad to be recorded, you should record using the notes of the C major seventh scale (C, D, E, G, A and B).



C = Chord note
C, R = Recommended note

- 8** Stop recording.
Press the [H] (STOP) button or the panel MULTI PAD [STOP] button or the STYLE CONTROL [START/STOP] button to stop recording when you've finished playing the phrase.
- 9** Listen back to your newly recorded phrase, by pressing the appropriate MULTI PAD button, [1]–[4]. To re-record the phrase, repeat steps 6–8.

To ensure that your repeated rhythmic phrases play back in a perfect loop, be careful to stop recording right on the very last beat of the phrase, just before the “one” of the next measure. If it is difficult to get a good loop, you may want to use the Step Record functions on the EDIT page.

10 Turn Repeat of each pad On or Off by using the [1 ▲ ▼] - [4 ▲ ▼] buttons.

If the Repeat parameter is on for the selected pad, playback of the corresponding pad will continue until the MULTI PAD [STOP] button is pressed. If the Repeat parameter is off for the selected pad, playback will end automatically as soon as the end of the phrase is reached.

When you press the Multi Pads of which the Repeat is turned on during Song or Style playback, playback will start and repeat in sync with the beat.

11 Turn Chord Match of each pad On or Off by using the [5 ▲ ▼]-[8 ▲ ▼] buttons.

If the Chord Match parameter is on for the selected pad, the corresponding pad is played back according to the chord specified in the chord section of the keyboard generated by turning [ACMP] on, or specified in the LEFT voice section of the keyboard generated by turning [LEFT] on (when turning the [ACMP] off).

12 Press the [D] button, then enter a name for each Multi Pad by (page 130).**13 Press the [I] button, then save the Multi Pad data as a Bank containing a set of four Pads to the USER drive or USB storage device (page 64).**

Multi Pads indicated with the following icon (hand on fretboard) are created with special note transpositions to produce the natural chord voicing of the guitar. Because of this, if the Chord Match setting is set to off, the Multi Pads may not sound appropriately.



Multi Pad Step Recording (EDIT)

Step Recording can be executed in the EDIT page. After selecting a Multi Pad in step 5 of the Multi Pad Realtime Recording on page 128, press the TAB [◀][▶] buttons to select the EDIT tab. The EDIT page indicates the Event list that lets you record notes with absolutely precise timing. This Step Recording procedure is essentially the same as that for Song Recording (pages 148–157), with the exception of the points listed below:

- There is no menu for switching channels, since Multi Pads contain data for only a single channel.
- In the Multi Pad Creator, only the channel events can be entered and the System Exclusive messages can be edited. Chord and Lyrics events are not available. You can switch between the two types of Event Lists by pressing the [F] button.

Multi Pad Editing (Multi Pad Creator)

1 Press the MULTI PAD CONTROL [SELECT] button to call up the Multi Pad Bank selection display, then select a Bank to be edited on the USER drive.

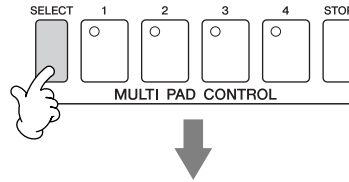

2 Press the [8 ▼] button to call up the [MULTI PAD EDIT] display, then select a Pad to be edited by pressing any of the [A], [B], [F], and [G] buttons.

The number above the Pad name corresponds to the MULTI PAD [1]–[4] buttons.

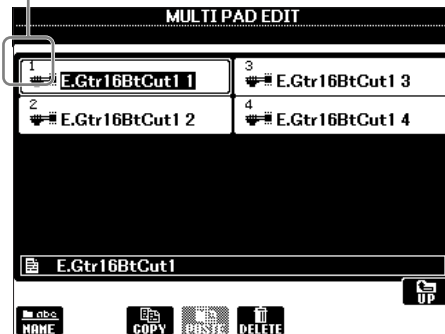

3 Edit each of the Multi Pads as desired.

- **Naming**
Press the [1 ▼] button then change the name of each Multi Pad (page 70).
- **Copying**
Press the [3 ▼] button, select the Multi Pad to be copied, select the destination location, then execute the Copy operation by pressing the [4 ▼] button (page 68).
- **Deleting**
Press the [5 ▼] button then delete the unnecessary Multi Pad (page 69).

The Registration Memory function allows you to save (or “register”) virtually all panel settings to a Registration Memory button, and then instantly recall your custom panel settings by pressing a single button. The registered settings for eight Registration Memory buttons should be saved as a single Bank (file).

Registering and Saving Custom Panel Setups

Registering Custom Panel Setups

- 1 **Set up the panel controls (such as Voice, Style, effects, and so on) as desired.**
Refer to the Data List for a list of parameters that can be registered with the Registration Memory function. The Data List is available at the Yamaha website. (See page 5.)
- 2 **Press the REGISTRATION MEMORY [MEMORY] button. The display for selecting the items to be registered appears.**
Only the items selected here will be registered.

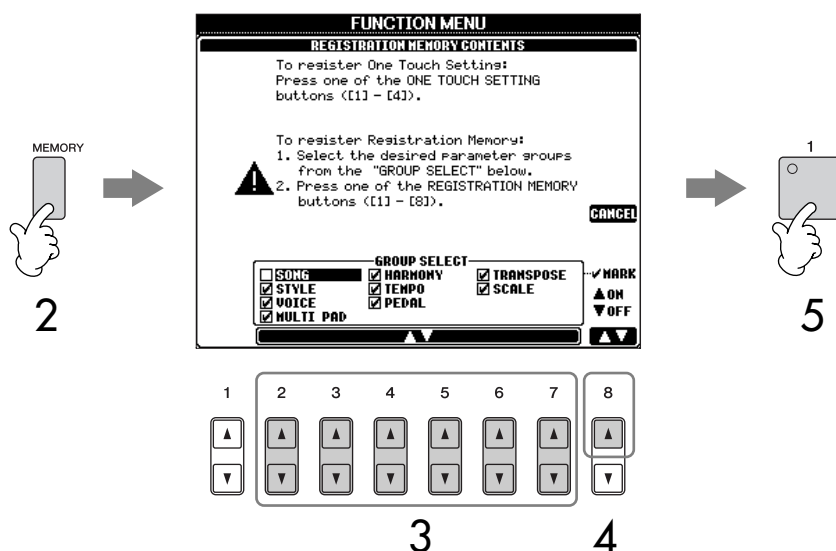

- 3 **Press the [2▲▼]–[7▲▼] buttons to select items.**
To cancel the operation, press the [I] (CANCEL) button.
- 4 **Enter or remove the checkmark in the box of the item to determine whether the item should be registered or not, by pressing the [8▲▼] button.**
- 5 **Press one of the REGISTRATION MEMORY [1]–[8] buttons to register your settings.**
It is recommended that you select a button whose lamp is not lit in red or green. Buttons that are lit in red or green, already contain the panel setup data. Any panel setup previously registered to the selected REGISTRATION MEMORY button (lamp lights in green or red) will be erased and replaced by the new settings.
- 6 **Register various panel setups to other buttons by repeating steps 1–5.**

When recalling registration setups, you can also select the items to be recalled or not, even if you selected all items when registering (page 134).

About the lamp status:

Off..... no data registered
On (green)...data registered, but not currently selected
On (red).....data registered, and currently selected

Deleting an unneeded panel setup

See page 133.

Deleting all eight current panel setups

To delete all the eight current panel setups, turn the [POWER] button ON while holding the B5 key (right-most B key on the keyboard).

Saving the Registered Panel Setups

You can save all the eight registered panel setups as a single Registration Memory Bank file.

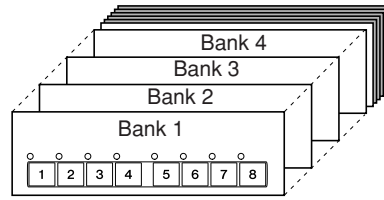

- 1 Press the REGIST BANK [+] and [-] buttons simultaneously to call up the REGISTRATION BANK Selection Display.
- 2 Press the [6 ▼] button to save the Bank file (page 67).

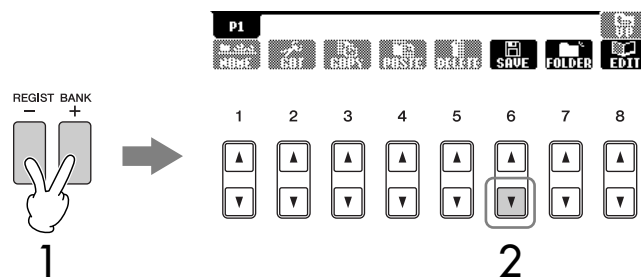

Recalling the Registered Panel Setups

- 1 Press the REGIST BANK [+] and [-] buttons simultaneously to call up the REGISTRATION BANK Selection Display.

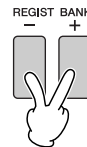

- 2 Press one of the [A]-[J] buttons to select a bank.

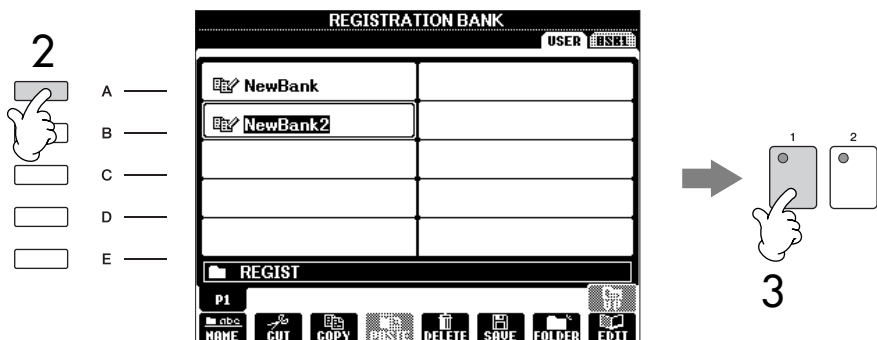

- 3 Press one of the green-lit numbered buttons ([1]-[8]) in the Registration Memory section.

About recalling setups from a USB storage device

When recalling the setups including Song/Style file selection from a USB storage device, make sure that the appropriate USB storage device including the registered Song/Style is connected into the [USB TO DEVICE] terminal.

Parameter Lock

You can “lock” specific parameters (e.g., effect, split point, etc.) to make them selectable only via the panel control — in other words, instead of via Registration Memory, One Touch Setting, Music Finder, Song or incoming MIDI data, etc.

- 1 **Call up the Parameter Lock display.**
[FUNCTION] → [J] UTILITY → TAB [◀][▶] → CONFIG 1 → [B] 3 PARAMETER LOCK
- 2 **Select the desired parameter by using the [1▲▼]–[7▲▼] buttons, then lock it with the [8▲] (OK) button.**

Deleting an Unneeded Panel Setup/Naming a Panel Setup

The panel setups can be deleted or named individually as desired.

- 1 **Press the REGIST BANK [+]** and [–] buttons simultaneously to call up the REGISTRATION BANK Selection Display.
- 2 **Press one of the [A]–[J] buttons** to select a bank to be edited.
- 3 **Press the [8▼] (EDIT) button** to call up the REGISTRATION EDIT Display.
- 4 **Edit the panel setups.**
 - **Deleting a panel setup**
Press the [5▼] button to delete a panel setup (page 69).
 - **Renaming a panel setup**
Press the [1▼] button to rename a panel setup (page 70).

The number above the file name corresponds to the REGISTRATION MEMORY [1]–[8] buttons.

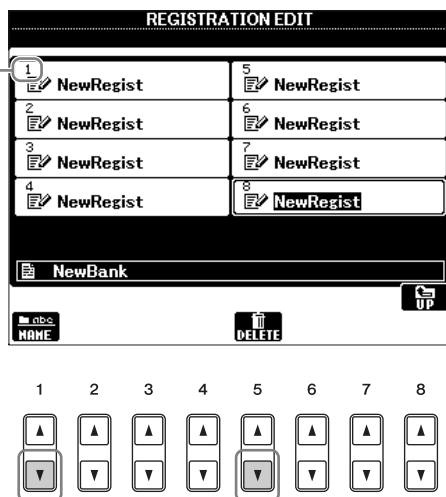

- 5 **Press the [8▲] (UP) button** to return to the REGISTRATION BANK Selection display.

Disabling Recall of Specific Items (Freeze Function)

Registration Memory lets you recall all the panel setups you made with a single button press. However, there may be times that you want certain items to remain the same, even when switching Registration Memory setups. For example, you may want to switch Voices or effect settings while keeping the same accompaniment Style. This is where the Freeze function comes in handy. It lets you maintain the settings of certain items and leave them unchanged, even when selecting other Registration Memory buttons.

⚠ CAUTION

Settings in the REGISTRATION FREEZE display are automatically saved to the instrument when you exit from this display. However, if you turn the power off without exiting from this display, the settings will be lost.

- 1 **Call up the operation display.**
[FUNCTION] → [E] REGIST SEQUENCE/FREEZE/VOICE SET → TAB [◀][▶] FREEZE
- 2 **Press the [2▲▼]-[7▲▼] buttons to select items.**
- 3 **Enter checkmarks for the items to be “Frozen” (i.e., to remain unchanged), by pressing the [8▲▼] button.**
- 4 **Press the [EXIT] button to exit from the operation display.**
- 5 **Press the [FREEZE] button on the panel to turn the Freeze function on.**

Calling Up Registration Memory Numbers in Order — Registration Sequence

As convenient as the Registration Memory buttons are, there may be times during a performance when you want to quickly switch between settings — without having to take your hands from the keyboard. The convenient Registration Sequence function lets you call up the eight setups in any order you specify, by simply using the TAB [◀][▶] buttons or the pedal as you play.

- 1 **Select the desired Registration Memory bank to program a sequence (page 132).**
- 2 **Call up the operation display.**
[FUNCTION] → [E] REGIST SEQUENCE/FREEZE/VOICE SET → TAB [◀][▶] REGISTRATION SEQUENCE

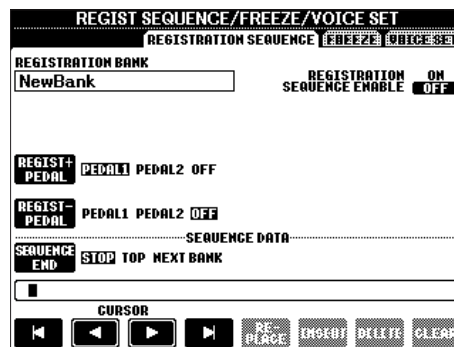

- 3 **If you intend to use a pedal to switch Registration Memory settings, specify here how the pedal will be used — to advance or to reverse through the sequence.**
Use the [C] button to select the pedal for advancing through the sequence.
Use the [D] button to select the pedal for reversing through the sequence.

- 4 Use the [E] button to determine how Registration Sequence behaves when reaching the end of the sequence (SEQUENCE END).**
- STOPPressing the TAB [▶] button or the “advance” pedal has no effect. The sequence is “stopped.”
 - TOPThe sequence starts again at the beginning.
 - NEXT BANK.....The sequence automatically moves to the beginning of the next Registration Memory Bank in the same folder.

- 5 Program the Sequence order.**
- The numbers shown at the lower part of the display correspond to the REGISTRATION MEMORY [1]–[8] buttons on the panel. Program the Sequence order from left to right.

Press one of the REGISTRATION MEMORY [1]–[8] button on the panel, then press the [6 ▲ ▼] (INSERT) button to input the number.

- **Replacing the number**
Press the [5 ▲ ▼] (REPLACE) button to replace the number at the cursor position with the currently selected Registration Memory number.
- **Deleting the number**
Press the [7 ▲ ▼] (DELETE) button to delete the number at the cursor position.
- **Deleting all numbers**
Press the [8 ▲ ▼] (CLEAR) button to delete all numbers in the sequence.

- 6 Press the [F] button to turn the Registration Sequence function on.**

- 7 Press the [DIRECT ACCESS] button, then the [EXIT] button to return to the Main display and confirm whether the Registration Memory numbers are called up according to the sequence programmed above.**
- Use the TAB [▶] button to call up the Registration Memory numbers in the order of the sequence, or use the TAB [◀] button to call them up in reverse order. The TAB [◀][▶] buttons can only be used for Registration Sequence when the Main display is called up.
 - When pedal operation has been set in step 3, you can use a pedal to select the Registration Memory numbers in order. The pedal can be used for Registration Sequence no matter which display is called up (except for the display in step 3).



The Registration Sequence is indicated at the top right of the Main display, letting you confirm the currently selected number.

Saving the Registration Sequence Settings

The settings for the Sequence order and how Registration Sequence behaves when reaching the end of the sequence (SEQUENCE END) are included as part of the Registration Memory Bank file. To store your newly programmed Registration Sequence, save the current Registration Memory Bank file.

- 1 Press the REGIST BANK [+] and [–] buttons simultaneously to call up the REGISTRATION BANK Selection display.**
- 2 Press the [6 ▼] button to save the Bank file (page 67).**

⚠ CAUTION
Settings in the REGISTRATION SEQUENCE display are automatically saved to the instrument when you exit from this display. However, if you turn the power off without exiting from this display, the settings will be lost.

Returning to the first Sequence in one action
In the Main display, press the TAB [◀] and [▶] buttons simultaneously. This cancels the currently selected Sequence number (the box indicator at the top right goes out). The first Sequence will be selected by pressing one of the TAB [◀][▶] buttons or by pressing the pedal.

⚠ CAUTION
Keep in mind that all Registration Sequence data is lost when changing Registration Memory Banks, unless you’ve saved it with the Registration Memory Bank file.

Before using a USB storage device, be sure to read "Handling the USB Storage Device (USB Flash Memory/Floppy Disk, etc)" on page 23.

Before using a floppy disk and the disk slot, be sure to read "Handling floppy disks" on page 22.

Commercially available music data is subject to protection by copyright laws. Copying commercially available data is strictly prohibited, except for your own personal use.

See page 176 for information on the types of Song data that can be played on the instrument.

Reference to Quick Guide Pages

Practicing with the Preset Songs	page 36
Playing Back and Listening to Songs Before Practicing	page 36
Displaying Music Notation (Score)	page 39
Muting the Right- or Left-hand Part Viewing the Score	page 40
Practicing by Using the Repeat Playback Function	page 42
Recording Your Performance.....	page 43
Singing Along with Song playback (Karaoke) or Your Own Performance	page 57
Singing with the Lyrics Display	page 57
Convenient Functions for Karaoke	page 58
Convenient Functions for Singing Along with Your Own Performance	page 58

Compatible Song Types

The PSR-OR700 can play back the following Song types.

Preset Songs

Songs in the Song Selection PRESET display.

Your Own Recorded Songs

These are Songs which you've recorded (page 43, page 143) and saved to the USER/USB display. (USB is available when you connect a USB storage device such as a USB flash memory/floppy disk drive to the instrument.)

Commercially Available Song Data

A variety of song data for the instrument can be downloaded from the Yamaha website, and even more titles are available commercially as Disk Songs. Disk Songs are available when you connect the optional floppy disk drive to the instrument. The instrument is compatible with the Song disks (floppy disks) that bear the following marks:



Operations for Song Playback

This section explains detailed operations and functions related to Song playback which are not covered in the “Quick Guide.”

■ Starting/Stopping a Song

Press the SONG [▶ / ■■] (PLAY/PAUSE) button to start Song playback, and press the SONG [■] (STOP) button to stop. In addition, there are several other convenient ways to start/stop a Song.

Starting Playback

Synchro Start

You can start playback as soon as you start playing the keyboard.

While playback is stopped, simultaneously press the SONG [■] (STOP) and [▶ / ■■] (PLAY/PAUSE) buttons simultaneously.

To cancel the Synchro Start function, simultaneously press the SONG [■] (STOP) and [▶ / ■■] (PLAY/PAUSE) buttons simultaneously once again.

Tap function

This useful function lets you press the [TAP TEMPO] button to tap out the tempo and automatically start the Song at that tapped speed. Simply tap (press/release) the button (four times for a 4/4 time signature) while the instrument is in Synchro Start standby mode, and the Song playback starts automatically at the tempo you tapped.

Fade In

The [FADE IN/OUT] button can be used to produce smooth fade-ins when starting the Song playback. To produce fade-ins, press the [FADE IN/OUT] button while playback is stopped and then press the SONG [▶ / ■■] (PLAY/PAUSE) button to start playback.

Stopping Playback

Fade Out

The [FADE IN/OUT] button can be used to produce smooth fade-outs when stopping the Song playback. Press the [FADE IN/OUT] button at the beginning of the phrase you want to fade out.

Set the Fade In/Out time

The times of the fade-in and fade-out can be set independently. For details, refer to page 105.

Depending on the particular Song data, the Style will also play back at the same time.

■ Top/Pause/Rewind/Fast Forward

Moving to the top position of the Song

Press the SONG [■] (STOP) button, regardless of whether the Song is stopped or playing back.

Pausing the Song

Press the SONG [▶ / ■] (PLAY/PAUSE) button during Song playback. Press the SONG [▶ / ■] (PLAY/PAUSE) button again and the Song will resume from the current position.

Moving back and forth (rewind and fast forward)

- 1 Press the SONG [◀◀] (REW) or SONG [▶▶] (FF) button to move back and forth (rewind and fast forward).

It calls up a pop-up window showing the current measure number in the Main display.

For Songs containing Phrase Marks, you can use the [◀◀/▶▶] (REW/FF) buttons to navigate through the Phrase Marks in the Song. If you don't want to set the Song position by the phrase marks, press the [E] button and select "BAR" in the window showing the Song position.

Phrase Mark:

Phrase Mark is a pre-programmed marker in certain Song data, which specifies a certain location (set of measures) in the Song.

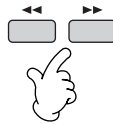

For Songs not containing Phrase Marks

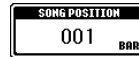

For Songs containing Phrase Mark



- 2 Press the [EXIT] button to close the pop-up window showing the current measure number (or Phrase Mark number).

■ Repeat Playback/Chain Playback

- 1 Call up the operation display.
[FUNCTION] → [B] SONG SETTING
- 2 Set the parameters related to the Repeat Playback by using the [H]/[I] buttons. The available parameters are shown below.

REPEAT MODE	<p>OFF Plays through the selected Song, then stops.</p> <p>SINGLE Plays through the selected Song repeatedly.</p> <p>ALL Continues playback through all the Songs in the folder containing the current Song repeatedly.</p> <p>RANDOM Randomly and repeatedly plays back all Songs in the folder containing the current Song.</p>
PHRASE MARK REPEAT	For Songs containing Phrase Marks, you can set Repeat Playback to "ON" or "OFF." When this is on, the part corresponding to the specified Phrase Mark number is repeatedly played back. The steps for specifying the Phrase Mark number are the same as in the steps 1–2 of the section "Moving back and forth (rewind and fast forward)" (see above).

■ Queuing the Next Playback Song

While a Song is playing back, you can queue up the next Song for playback. This is convenient for chaining it to the next Song smoothly during stage performance. Select the Song you want play next in the Song Selection display, while a Song is playing back.

The “NEXT” indication appears at the upper right of the corresponding Song name. To cancel this setting, press the [8 ▼] (Cancel) button.

■ Using the Auto Accompaniment Features with the Song Playback

When playing back a Song and a Style at the same time, channels 9–16 in the Song data are replaced with style channels — allowing you to play the accompaniment parts of the Song yourself. Try playing chords along with the Song playback as shown in the instructions below.

- 1 Select a Song (page 36).
- 2 Select a Style (page 46).
- 3 Press the STYLE CONTROL [ACMP] button to turn on the Auto Accompaniment function.
- 4 Press the STYLE CONTROL [SYNC START] button to enable standby — letting you simultaneously start the accompaniment as soon as you start playing.
- 5 Press the SONG [▶ / ■■] (PLAY/PAUSE) button to start playback.
- 6 Play chords along with the Song.
The chord name is indicated in the Main display. To return to the Main display, press the [DIRECT ACCESS] button, then press the [EXIT] button.

When the Song playback is stopped, the Style playback is also stopped at the same time.

- **Tempo for playing back a Song and a Style at the same time**
When playing back a Song and a Style at the same time, the tempo value set in the Song is automatically used.

Playing Songs with the Quick Start function

With the default settings, the Quick Start function is turned on. On some commercially available Song data, certain settings related to the Song (such as voice selection, volume, etc.) are recorded to the first measure, before the actual note data. When Quick Start is set to “ON,” the instrument reads all initial non-note data of the Song at the highest possible speed, then automatically slows down to the appropriate tempo at the first note. This allows you to start playback as quickly as possible, with a minimum pause for reading of data. When Quick Start is set to “ON,” a Song is played back directly from the first note (which may be in the middle of a measure). If you want to play from the beginning of the measure that has silence prior to the first note, turn Quick Start “OFF.”

- 1 Call up the operation display.
[FUNCTION] → [B] SONG SETTING
- 2 Press the [7 ▼] (QUICK START) buttons to turn the Quick Start “OFF.”

Parameter Lock

You can “lock” specific parameters (e.g., effect, split point, etc.) to make them selectable only via the panel controls (page 133).

For songs without chord data, the chord name will not be displayed in the Main display during Song playback.

**About the [SONG CH 1-8]/
[SONG CH 9-16] displays**

A Song consists of 16 separate channels. Separate settings can be made for each of the 16 channels in the MIXING CONSOLE display. Adjust the parameters in the SONG CH 1-8 or SONG CH 9-16 display respectively. Usually, CH 1 is assigned to the [TR 1] button, CH 2 is assigned to the [TR 2] button, and CH 3-16 are assigned to the [EXTRA TR] button, respectively.

Press the [C]/[H] (VOICE) buttons in step 5 to select the Voice which you want to change. Then, press one of the [1 ▲ ▼] to [8 ▲ ▼] buttons to call up the Voice selection display for the channel.

Reading Song data automatically when inserting a USB storage device

You can have the instrument automatically call up the first Song (not contained in a folder) on a USB storage device, as soon as the device is connected to the [USB TO DEVICE] terminal.

- 1 **Call up the operation display.**
[FUNCTION] → [J] UTILITY → TAB [◀][▶] MEDIA
- 2 **Press the [3 ▲]/[4 ▲] (SONG AUTO OPEN) button to select "ON."**

Adjusting the Volume Balance and Voice Combination, etc. (MIXING CONSOLE)

You can set the mixing-related parameters of a Song. Refer to the section "Adjustable items (parameters) in the MIXING CONSOLE display" on page 85. Call up the "SONG CH 1-8" or "SONG CH 9-16" display in step 3 of the Basic Procedure in "Editing the Volume Balance and Voice Combination (MIXING CONSOLE)" on page 84. Below are two operation examples.

Adjusting the Volume Balance of Each Channel

- 1 **Select a Song (page 36).**
- 2 **Press the [MIXING CONSOLE] button to call up the MIXING CONSOLE display.**
- 3 **Select the [VOL/VOICE] tab by pressing the TAB [◀][▶] buttons.**
- 4 **Press the [MIXING CONSOLE] button repeatedly to call up the display of "SONG CH 1-8" or "SONG CH 9-16."**
- 5 **Press the [J] button to select the "VOLUME."**
- 6 **Adjust the volume balance of each channel by using the [1 ▲ ▼]-[8 ▲ ▼] buttons.**
- 7 **You can save the volume settings to the Song in the Setup operation of the SETUP (page 162).**
Make sure to checkmark the "VOLUME" item in step 2 of the Setup procedure.

Changing Voices

- 1-4 The operation steps are the same as in the "Adjusting the Volume Balance of Each Channel" (see page 140).
- 5 Press the [H] button to select the "VOICE."
- 6 Press one of the [1▲▼]-[8▲▼] buttons to call up the Voice selection display for the channel.
- 7 Press one of the [A]-[J] buttons to select a Voice.
- 8 You can save the changed Voice selection to the Song in the Setup operation (page 162).
Make sure to checkmark the "VOICE" item in step 2 of the Setup procedure.

Practicing Songs with the Guide Functions

The Guide functions provide convenient learning and practicing tools to help you master the instrument. By pressing the [SCORE] button, you can have the notation of the song displayed, showing the notes you should play and when you should play them, for ease in learning.

Saving the Guide settings in the SONG SETTING display

You can save the Guide settings as a part of the Song data (page 162). For Songs to which Guide settings have been saved, the Guide function will be automatically turned on and the related settings will be recalled when the Song is selected.

Selecting the Guide Function Type

- 1 Call up the setting display:
[FUNCTION] → [B] SONG SETTING
- 2 Use the [A]/[B] buttons to select the desired Guide function type. The following types are available.

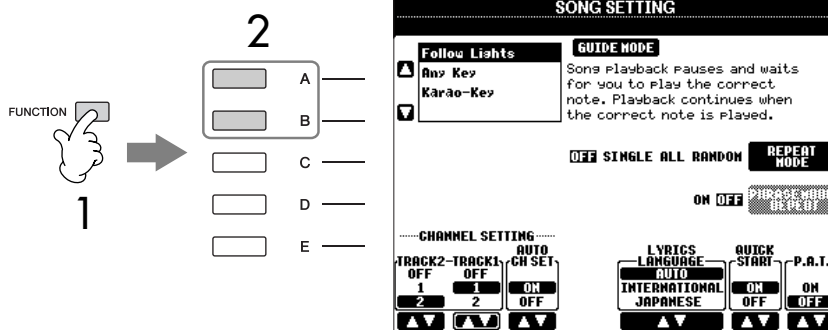

- 3 Select a song, call up the Score display (by pressing the [SCORE] button), then play the keyboard.

For Keyboard Performance

Follow Lights

When this is selected, Song playback pauses, waiting for you to play the notes correctly. When you play the correct notes, Song playback continues. Follow Lights was developed for the Yamaha Clavinova series. This function is used for practicing purposes, with built-in lamps on the Clavinova keyboard indicating the notes to be played. Even though the PSR-OR700 does not have these lamps, you can use the same function by following the indications in the displayed notation with the Song Score function.

Any Key

With this function, you can play the melody of a Song just by pressing a single key (any key is OK) in time with the rhythm. Song playback pauses and waits for you to play any key. Simply play a key on the keyboard in time with music and the Song playback continues.

For Singing

Karao-key

This function lets you control the Song playback timing with just one finger, while you sing along. Song playback pauses, waiting for you to sing. Simply play a key on the keyboard (any key is OK) and the Song playback continues. (For this function, the notes of the keyboard do not sound.)

Turning playback channels of the Song on and off

A Song consists of 16 separate channels. You can independently turn each channel of the selected Song playback on or off. Usually, CH 1 is assigned to [TR 1] button, CH 2 is assigned to [TR 2] button, and CH 3–16 are assigned to the [EXTRA TR] button.

1 Press the [CHANNEL ON/OFF] button to call up the Song CHANNEL ON/OFF display.

If the display shown below does not appear, press the [CHANNEL ON/OFF] button again.

SONG		CHANNEL ON/OFF															
1	2	3	4	5	6	7	8	9	10	11	12	13	14	15	16		
ON	ON	ON	ON	ON	ON	ON	ON	ON	ON	ON	ON	ON	ON	ON	ON	ON	

2 Use the [1 ▲ ▼]–[8 ▲ ▼] buttons to turn each channel on or off.

If you want to play back only one particular channel (muting all other channels), press and hold down one of the [1 ▲ ▼]–[8 ▲ ▼] buttons corresponding to the desired channel. To cancel solo playback, press the same button again.

Recording Your Performance to MIDI

You can record your own performances and save them to the User tab display or a USB storage device. Several different recording methods are available:

Quick Recording which lets you record performance conveniently and quickly, Multi track Recording which lets you record several different parts to multiple channels, and Step Recording which lets you enter notes one by one. And since the recorded data is MIDI, you can easily edit your songs, too.

For details on MIDI, see page 174, “What is MIDI?”

Internal memory (User tab displays) capacity

The internal memory capacity of the instrument is about 560KB. This capacity applies to all file types, including Voice, Style, Song, and Registration data files.

Recording Methods

There are three methods as shown below.

Realtime Recording	Quick Recording ▶ See below.	This convenient and simple recording method lets you quickly record your performance — useful, for example, in recording solo piano pieces. You can record to the [TR 1 (R)] or [TR 2 (L)] button, and also to the [EXTRA TR (STYLE)] track, which can be used for recording at the same time.
	Multi track Recording ▶ page 145	This lets you record a whole Song including several different instrument parts, to create the sound of a full band or orchestra. Record the performance of each instrument part one by one and create fully orchestrated compositions. You can also record over already-recorded parts of an existing Song (Preset Song or a Song on USB storage device) with your own performance.
Step Recording	Step Recording ▶ page 148	This method lets you compose your performance by “writing” it down one event at a time. This is a non-realtime, manual recording method – similar to writing music notation onto paper. You can input notes, chords and other events one by one (realtime performance is not needed).

You can also edit Songs after they’ve been recorded (page 158).

For example, you can edit specific notes one by one, or you can use the Punch In/Out function to re-record a specific part.

Quick Recording

This lets you conveniently and quickly record your performance.

1

Press the **SONG [REC]** and **SONG [■] (STOP)** buttons simultaneously.

A blank Song (“New Song”) is called up for recording.

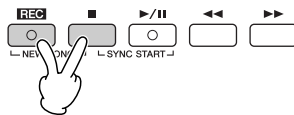

The RIGHT 2 and/or LEFT parts are recorded onto separate tracks.

Using the metronome
You can record your performance while playing back the metronome (page 34). However, the metronome sound is not recorded.

2 Make the desired panel settings for your keyboard performance.

Below are some example settings you may want to try.

- **Recording the RIGHT 2 and/or LEFT parts**

The [RIGHT 2] and/or [LEFT] keyboard parts should be turned on. Select the voice for each keyboard part (RIGHT 2, LEFT) by calling up the Voice selection display (page 79, page 80).

- **Recording Styles**

- 1 Select a Style (page 46).
- 2 Set the tempo for recording by pressing the TEMPO [-] [+] buttons, as necessary.

- **Using Registration Memory panel setups**

Press one of the REGISTRATION MEMORY [1–8] buttons (page 131).

3 While holding the SONG [REC] button, press the SONG TRACK buttons to be recorded.

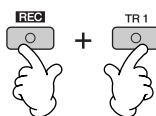

- **Recording your performance**

Press the SONG [TR 1] button for the right-hand part recording, and/or the SONG [TR 2] button for the left-hand part recording.

- **Recording Styles/Multi Pads**

Press the SONG [EXTRA TR (STYLE)] button.

- **Recording your performance and the Style/Multi Pad playback simultaneously**

Press the SONG [TR 1]/[TR 2] buttons and the SONG [EXTRA TR (STYLE)] button.

4 Start recording.

There are several different ways you can start recording.

- **Starting by playing the keyboard**

If you've selected the SONG [TR 1]/[TR 2] buttons in step 3, play in the right-hand section of the keyboard (page 78). If you've selected the SONG [EXTRA TR (STYLES)] button in step 3, play in the left-hand (chord) section of the keyboard (page 107). Recording begins automatically as soon as you play a note on the keyboard.

- **Starting by pressing the SONG [▶ / ■■] (PLAY/PAUSE) button**

If you start recording in this way, "empty" data is recorded until you play a note on the keyboard. This is useful for starting a Song with a short one- or two-beat pick-up or lead-in.

- **Starting by pressing the STYLE CONTROL [START/STOP] button.**

In this case the rhythm parts (channels) of the Style begin playing back and recording starts simultaneously.

5 Press the SONG [■] (STOP) button to stop recording.

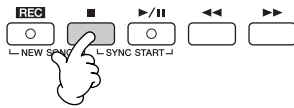

When recording is finished, a message prompting you to save the recorded performance data appears. To close the message, press the [EXIT] button. See step 7 for instructions on saving your recording.

6 Listen to your newly recorded performance. Press the SONG [► / ■] (PLAY/PAUSE) button to play back the performance you just recorded.

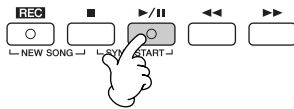

7 Press the SONG [SELECT] button to call up the Song Selection display for saving your data, then save the data in the Song Selection display (page 67).

Multi Track Recording

A Song consists of 16 separate channels. With this method, you can record data to each channel independently, one by one. Both Keyboard and Style parts can be recorded.

1 Press the SONG [REC] and SONG [■] (STOP) buttons simultaneously.

A blank Song ("New Song") is called up for recording.

Select Voices for recording the keyboard parts (RIGHT 1, RIGHT 2, and/or LEFT) (page 30, page 79, page 80). Select a Style and a Multi Pad Bank for recording also, as necessary (page 46, page 52).

Example

Recording the keyboard RIGHT 2 part to the channel 2

Press the PART SELECT [RIGHT 2] button to call up the Voice selection display, and select a Voice for the RIGHT 2 part. Also be sure to turn the PART ON/OFF [RIGHT 2] button on.

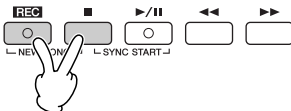

Pausing and restarting your recording

To pause recording, press the SONG [► / ■] (PLAY/PAUSE) button during recording. To restart recording, follow the operations shown below.

- For recording to [TR 1]/[TR 2], press the SONG [► / ■] (PLAY/PAUSE) button.
- For recording to [EXTRA TR], press the STYLE CONTROL [SYNC START] button, then play in the chord section of the keyboard.

⚠ CAUTION

The recorded Song data will be lost if you select another Song or turn the power to the instrument off without executing the Save operation (page 67).

About Channels

See page 147.

Setting all of the 5–16 channels to “REC” simultaneously
While holding the SONG [REC] button, press the SONG [EXTRA TR] button.

When selecting the MIDI part

- Setting a single channel to MIDI
All incoming data received via any of the MIDI channels 1-16 is recorded. When using an external MIDI keyboard or controller to record, this lets you record without having to set the MIDI transmit channel on the external device.
- Setting several channels to MIDI
When using an external MIDI keyboard or controller to record, this records data only over the set MIDI channel — meaning the external device must also be set to the same channel.

Recording each channel with the same tempo

Use the Metronome function (page 34) to record each channel with the same tempo. Keep in mind that the metronome sound is not recorded.

Pausing and restarting your recording

See page 144.

2 While holding the SONG [REC] button, press the [1 ▲ ▼]–[8 ▲ ▼] buttons to set the desired channels to “REC.”

Normally, the keyboard parts should be recorded to channels 1–4, the Multi Pads should be recorded to 5–8, and the Styles should be recorded to channels 9–16. To cancel the channel selection, press the SONG [REC] button again.

While holding the SONG [REC] button, press the [2 ▲] button to set the channel 2 to “REC.”

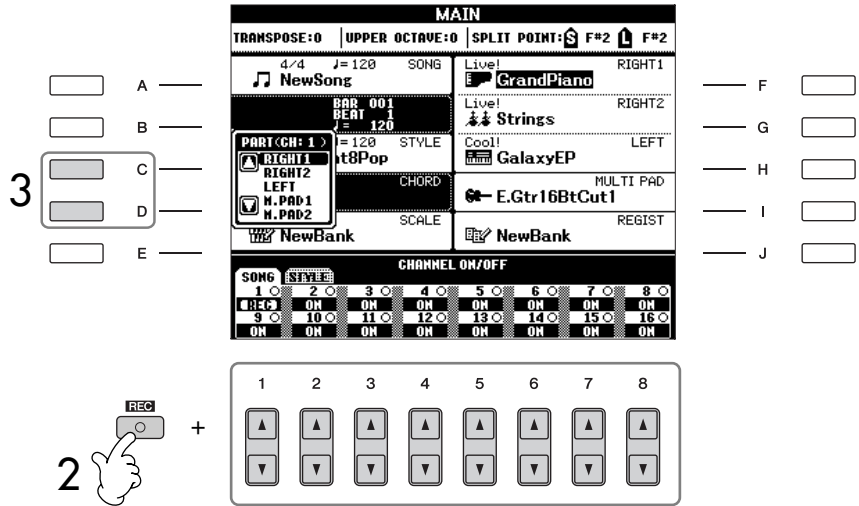

3 Use the [C]/[D] buttons to select the desired part for the channel to be recorded.

This determines which part — keyboard or Style (Rhythm 1/2, Bass, etc.) or Multi Pad — is recorded to each of the channels selected in step 2. Default channel/part assignments are shown in the section “About Song channels” (page 147). To close the Part selection display, press the [EXIT] button.

Press the [D] button to select the “RIGHT2.”

4 Start recording.

The method for starting is the same as in step 4 of Quick Recording (page 144).

5 Press the SONG [■] (STOP) button to stop recording.

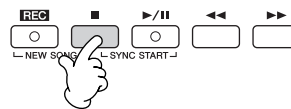

When recording is finished, a message appears prompting you to save the recorded performance. To close the message, press the [EXIT] button. For instructions on saving Song data, see step 8.

6 Listen to your newly recorded performance. Press the SONG [▶ / ■■] (PLAY/PAUSE) button to playback the performance you just recorded.

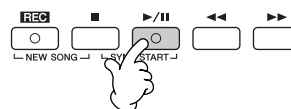

- 7 To record another channel, repeat steps 2 through 6.
- 8 Press the SONG [SELECT] button to call up the Song Selection display for saving your data, then save the data in the Song Selection display (page 67).

About Song channels

Default channel/part assignments are shown below.

Channels	Default Parts		Channels	Keyboard parts	
1	RIGHT1	Keyboard Parts	9	RHYTHM1	Style parts
2	RIGHT1		10	RHYTHM2	
3	RIGHT1		11	BASS	
4	RIGHT1		12	CHORD1	
5	M.Pad1	Multi Pad parts	13	CHORD2	
6	M.Pad2		14	PAD	
7	M.Pad3		15	PHRASE1	
8	M.Pad4		16	PHRASE2	

About keyboard parts

There are three keyboard parts, RIGHT 1, RIGHT 2 and LEFT. As the default, the RIGHT 1 part is assigned to each of the channels 1–4. Normally, the keyboard parts should be recorded to the channels 1–4.

About Style parts

As the default, each of the Style parts is assigned to the channels 9–16, respectively as shown above. Normally, the Style parts should be recorded to the channels 9–16.

RHYTHM This is the basic part of the Style, containing the drum and percussion rhythm patterns. Usually one of the drum kits is used.

BASS The bass part uses various appropriate instrument sounds to match the style.

CHORD This is the rhythmic chord backing, commonly used with piano or guitar Voices.

PAD This part is used for sustained instruments such as strings, organ, choir, etc.

PHRASE This part is used for punchy brass stabs, arpeggiated chords, and other extras that make the accompaniment more interesting.

About Multi Pad parts

As the default, each of the Multi Pads is assigned to the channels 5–8, respectively as shown above.

⚠ CAUTION

The recorded Song data will be lost if you select another Song or turn the power to the instrument off without executing the Save operation (page 67).

Step Recording

This method lets you record regular music data such as melodies and chords.

Basic Operations for Step Recording

- 1 Press the SONG[REC] and SONG[■] (STOP) buttons simultaneously. A blank Song ("New Song") is called up for recording.

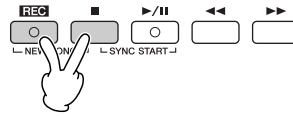

- 2 Call up the operation display. [FUNCTION] → [F] DIGITAL REC MENU

- 3 Press the [A] button to call up the Song Creator display for recording/editing a Song.

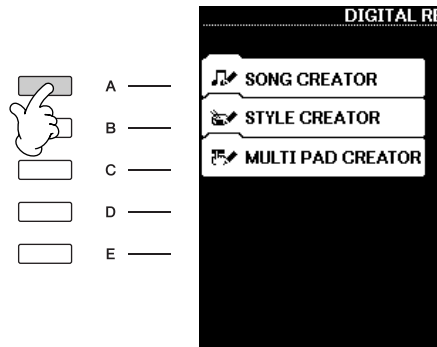

- 4 Select the appropriate tab by using the TAB [◀][▶] buttons. For recording melodies Select the [1-16] tab. For recording chords Select the [CHORD] tab.

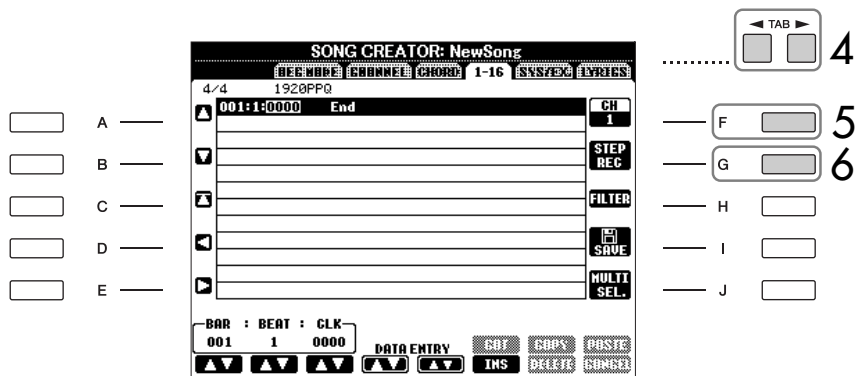

- 5 If you select the "1-16" tab in step 4, press the [F] button to select the channel for recording.

- 6 Press the [G] button to call up the STEP RECORD display.

- 7 Start Step Recording. For recording melodies See page 149. For recording chords See page 156.

Recording Melodies

This section explains how to step-record notes, using three music score examples.

Example 1

The explanations here apply to step 7 of the section “Basic Operations for Step Recording” on page 148.

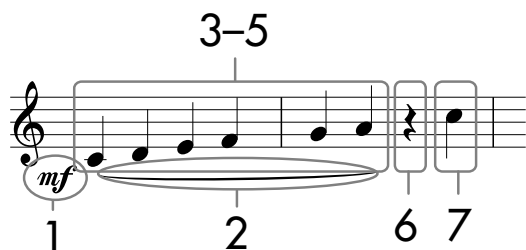

* The numbers shown in the notation correspond to the following operation step numbers.

Select the Voice for recording after calling up the Step Record display.

1 Press the [G] button to select “mf.”

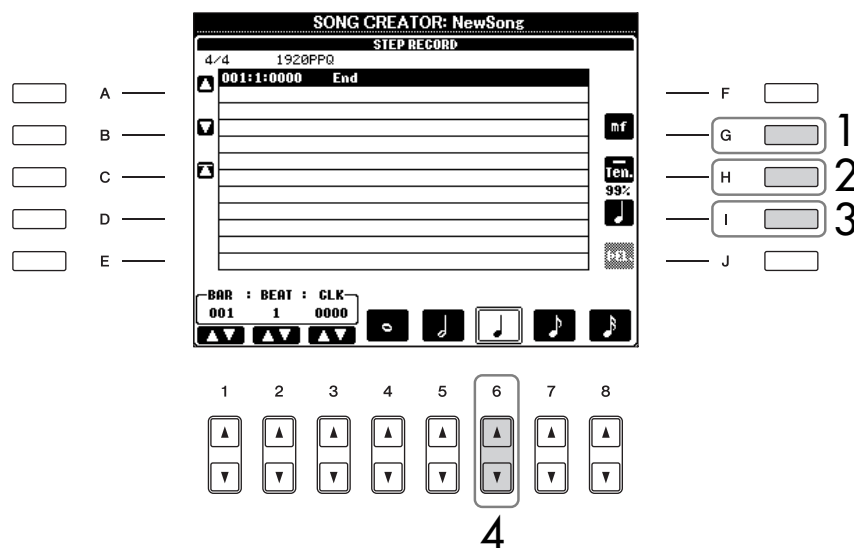

2 Press the [H] button to select “Tenuto.”

3 Press the [I] button to select “normal” note type.

4 Press the [6▲▼] button to select the quarter-note length.

5 Play the keys C3, D3, E3, F3, G3, and A3 in order, according to the notation example.

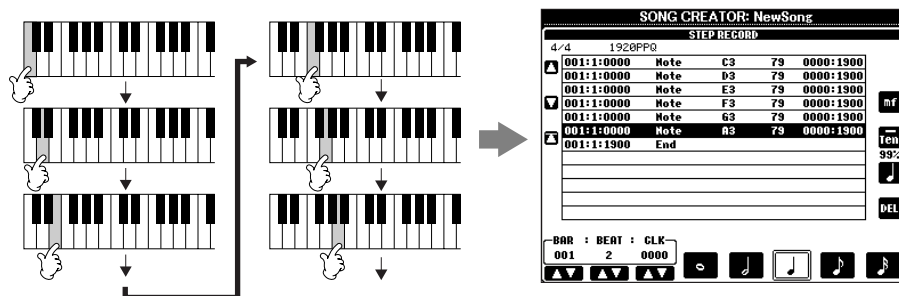

Since the music score displayed on the instrument is generated from the recorded MIDI data, it may not appear exactly the same as shown here.

About the items which can be selected via the [G] [H] [I] buttons See page 151.

- 6** Press the [6 ▲ ▼] button to enter a quarter-note rest.
 To enter the rest, use the [4 ▲ ▼]–[8 ▲ ▼] buttons. (Press the button once to select the rest value, and once again to actually enter it.) A rest having specified note length will be entered.

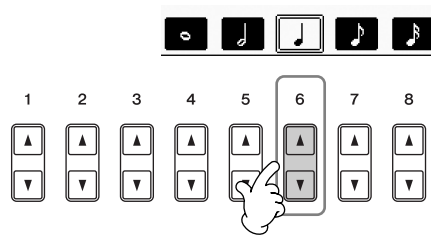

- 7** Play the C4 key.

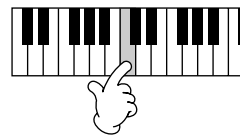

- 8** Press the SONG [■] (STOP) button to move the cursor to the beginning of the Song.



- 9** Press the SONG [▶ / ||] (PLAY/PAUSE) button to hear the newly entered notes.

- 10** Press the [EXIT] button to exit from the Step Record display.
 If you want, you can also edit already recorded Songs in the same manner (page 158).

- 11** Press the [I] (SAVE) button to call up the Song Selection display for saving your data, then save the data in the Song Selection display (page 67).

CAUTION
 The recorded Song data will be lost if you select another Song or turn the power to the instrument off without executing the Save operation (page 67).

Move the cursor to the beginning of the Song.
 Press the SONG [■] (STOP) button during recording.

Deleting data

Mistakenly entered notes can be deleted.





- 1 Use the [A]/[B] buttons in the STEP RECORD display (page 148) to select the data you want to delete.
- 2 Press the [J] (DELETE) button to delete the selected data.

About items which can be selected via the [G] [H] [I] buttons in the Step Record display

[G] button Determines the velocity (loudness) of the note to be entered.

Items	Velocity to be recorded
Kbd.Vel	Actual velocity you play the keyboard with
fff	127
ff	111
f	95
mf	79
mp	63
p	47
pp	31
ppp	15

[H] button Determines the gate time (note length) of the note to be entered.

Items	Gate time to be recorded
Normal	 80%
Tenuto	 99%
Staccato	 40%
Staccatissimo	 20%
Manual	The gate time (note length) can be set to any desired percentage by using the DATA ENTRY dial.

[I] button Determines the note type to be entered. Pressing the button alternately switches the note selectors (at the bottom of the display) among three basic note values: normal, dotted and triplet.

About velocity

Velocity is determined by how strongly you play the keyboard. The more strongly you play the keyboard, the higher the velocity value and the louder the sound. The velocity value can be specified within a range from 1 to 127. The higher the velocity value, the louder the sound becomes.

Example 2

The explanations here apply to step 7 of the “Basic Operations for Step Recording” on page 148.

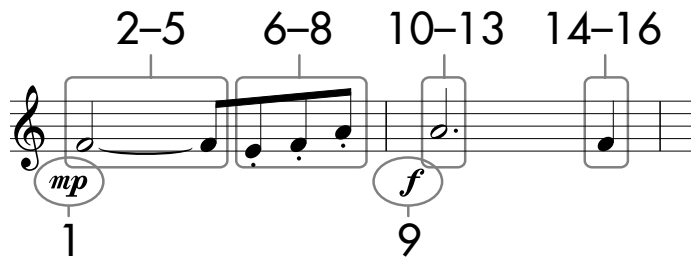

* The numbers shown in the sheet correspond to the following operation step numbers.

In this example, keep in mind that one of the steps involves holding down a key on the keyboard while executing the operation. Select the Voice for recording after calling up the Step Record display.

Since the music score displayed on the instrument is generated from the recorded MIDI data, it may not appear exactly the same as shown here.

About the items which can be selected via the [G] [H] [I] buttons
See page 151.

1

Press the [G] button to select “mp.”

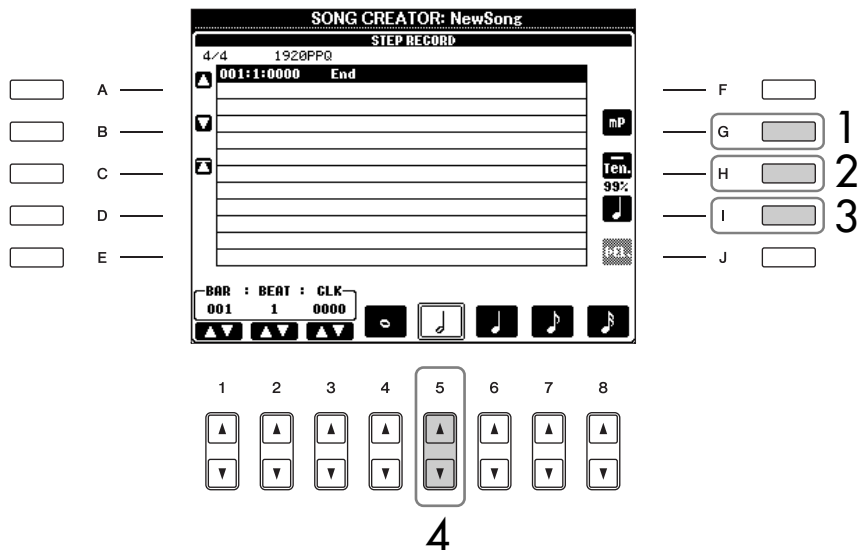

2

Press the [H] button to select “Tenuto.”

3

Press the [I] button to select “normal” note type.

4

Press the [5 ▲ ▼] button to select the half-note length.

5

While holding F3 on the keyboard, press the [7 ▲ ▼] button.

Before you go on to step 6, release the F3 key and the [7 ▲ ▼] button.

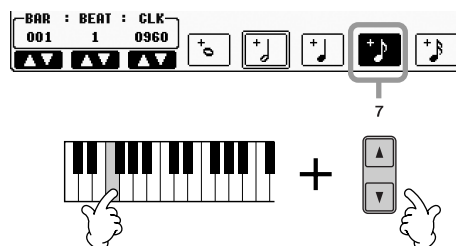

- 6 After releasing the F3 key, press the [H] button to select "Staccato."
- 7 Press the [7 ▲ ▼] button to select the eighth-note length.
- 8 Play the keys E3, F3, and A3 in order, according to the notation example.

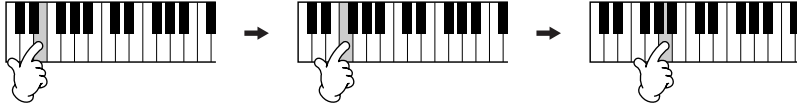

- 9 Press the [G] button to select "*f*."
- 10 Press the [H] button to select "Tenuto."
- 11 Press the [I] button to select "dotted."
- 12 Press the [5 ▲ ▼] button to select the dotted half-note length.
- 13 Play the A3 key on the keyboard, as specified in the example.
- 14 Press the [I] button to select "normal" note type.
- 15 Press the [6 ▲ ▼] button to select the quarter-note length.
- 16 Play the F3 key on the keyboard, as specified in the example.
- 17 Press the SONG [■] (STOP) button to move the cursor to the beginning of the Song.



- 18 Press the SONG [► / ■■] (PLAY/PAUSE) button to hear the newly entered notes.
- 19 Press the [EXIT] button to exit from the Step Record display. You can also edit the Songs you've recorded as necessary (page 158).
- 20 Press the [I] (SAVE) button to call up the Song Selection display for saving your data, then save the data in the Song Selection display (page 67).

CAUTION
The recorded Song data will be lost if you select another Song or turn the power to the instrument off without executing the Save operation (page 67).

Since the music score displayed on the instrument is generated from the recorded MIDI data, it may not appear exactly the same as shown here.

About the items which can be selected via the [G] [H] [I] buttons
See page 151.

Example 3

The explanations here apply to step 7 of the “Basic Operations for Step Recording” on page 148.

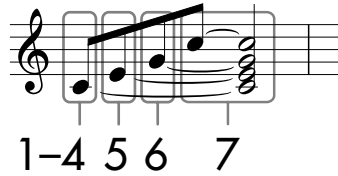

* The numbers shown in the sheet correspond to the following operation step numbers.

In this example, keep in mind that one of the steps involves holding down a key on the keyboard while executing the entire operations.

Select the Voice for recording after calling up the Step Record display.

1 Press the [H] button to select “Normal.”

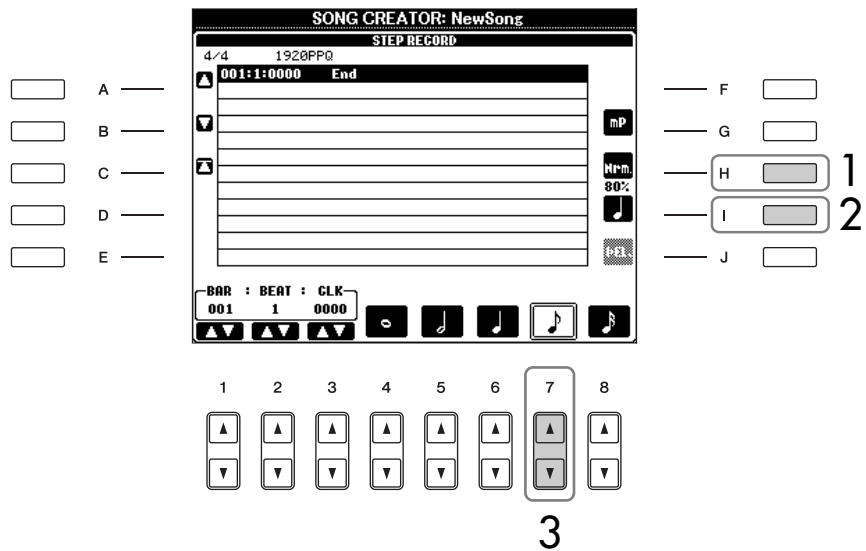

2 Press the [I] button to select “normal” note type.

3 Press the [7▲▼] button to select the eighth note.

4 While holding C3 key on the keyboard, press the [7▲▼] button.

Do not release the C3 key yet. Keep holding it while executing the following steps.

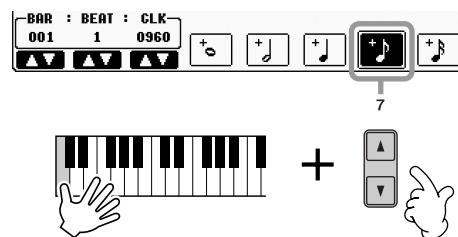

- 5** While holding the C3 and E3 keys on the keyboard, press the [7▲▼] button.
Do not release the C3 and E3 keys yet. Keep holding them while executing the following steps.

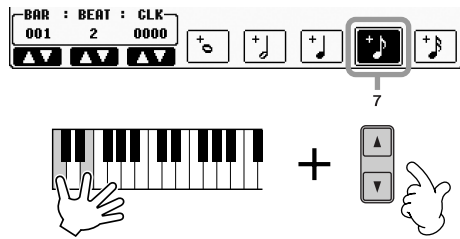

- 6** While holding the C3, E3 and G3 keys on the keyboard, press the [7▲▼] button.
Do not release the C3, E3 and G3 keys yet. Keep holding them while executing the following steps.

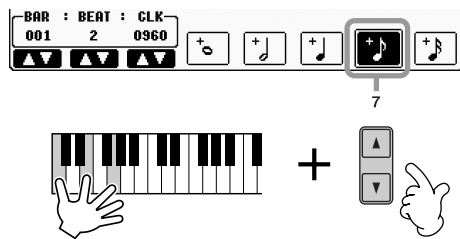

- 7** While holding the C3, E3, G3 and C4 keys on the keyboard, press the [7▲▼] button, and successively press the [5▲▼] button.
After you press the [5▲▼] button, release the keys.

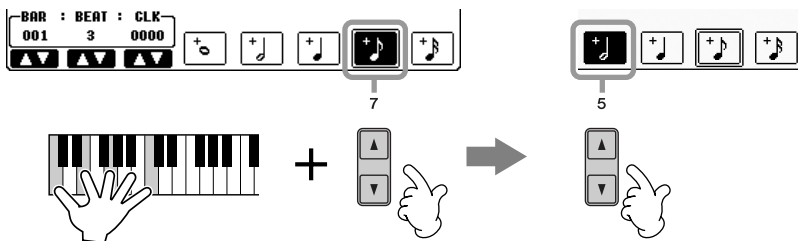

- 8** Press the SONG [■] (STOP) button to move the cursor to the beginning of the Song.
- 9** Press the SONG [▶/||] (PLAY/PAUSE) button to hear the newly entered notes.
- 10** Press the [EXIT] button to exit from the Step Record display.
If you want, you can also edit already recorded songs in the same manner (page 158).
- 11** Press the [I] (SAVE) button to call up the Song Selection display for saving your data, then save the data in the Song Selection display (page 67).

⚠ CAUTION
The recorded Song data will be lost if you select another Song or turn the power to the instrument off without executing the Save operation (page 67).

Recording Chords

You can record Chords and Sections (Intro, Main, Ending, and so on) one at a time with precise timing. These instructions show how to record chord changes using the Step Record function.

The explanations here apply to step 7 of the “Basic Operations for Step Recording” on page 148.

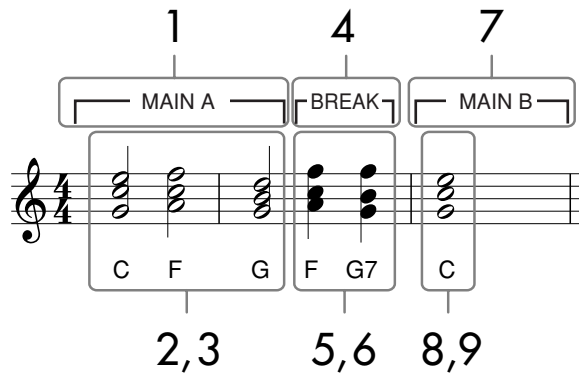

* The numbers shown in the notation correspond to the following operation step numbers.

- 1 Make sure the STYLE CONTROL [AUTO FILL IN] button is set to OFF, then press the STYLE CONTROL [MAIN VARIATION A] button.

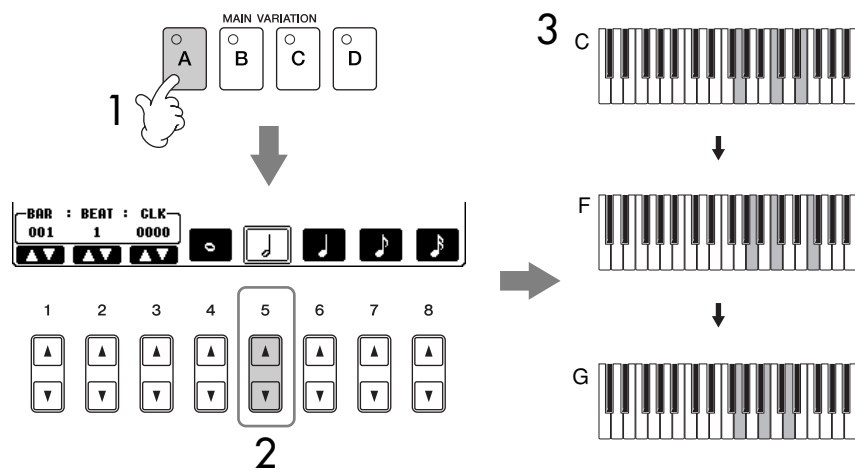

- 2 Press the [5 ▲ ▼] button to select the half-note length.
- 3 Play the chords C, F and G in the chord section of the keyboard.
- 4 Press the STYLE CONTROL [BREAK] button.

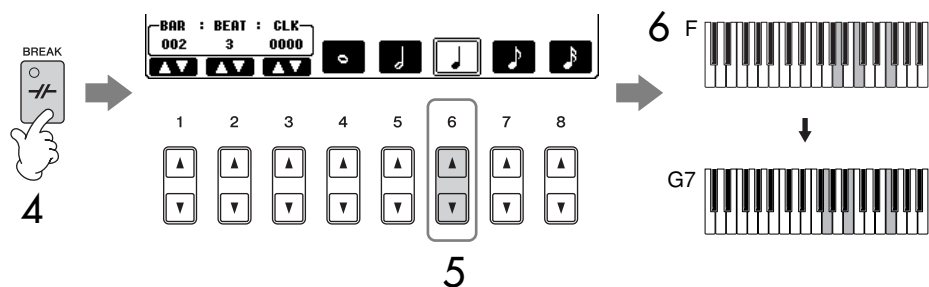

- 5 Press the [6 ▲ ▼] button to select the quarter-note length.
- 6 Play the chords F, and G7 in the chord section of the keyboard
- 7 Press the STYLE CONTROL [MAIN VARIATION B] button.

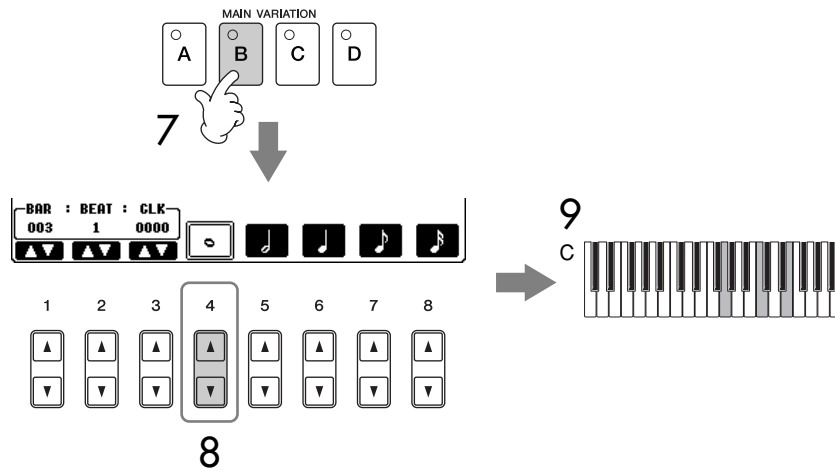

- 8 Press the [4 ▲ ▼] button to select the whole-note length.
- 9 Play the chord C in the chord section of the keyboard.
- 10 Press the SONG [■] (STOP) button to move the cursor to the beginning of the Song.
- 11 Press the SONG [▶ / ■■] (PLAY/PAUSE) button to hear the newly entered notes.
- 12 Press the [EXIT] button to exit from the Step Record display.
If you want, you can also edit already recorded Songs in the same manner (page 158).
- 13 Press the [F] (EXPAND) button to convert the input chord change data into the Song data.
- 14 Press the [I] (SAVE) button to call up the Song Selection display for saving your data, then save the data in the Song Selection display (page 67).

⚠ CAUTION

The recorded Song data will be lost if you select another Song or turn the power to the instrument off without executing the Save operation (page 67).

Deleting data

Mistakenly entered notes can be deleted (page 150).

Entering fill-ins

Turn the STYLE CONTROL [AUTO FILL IN] button to ON, and simply press one of the STYLE CONTROL [MAIN VARIATION (A, B, C, D)] buttons. (The appropriate fill-in section plays and then automatically goes to the selected [MAIN VARIATION (A, B, C, D)] pattern playback.)

Editing a Recorded Song

You can edit the Songs you've recorded with any recording method — Quick Recording, Multi Track Recording, or Step Recording.

Basic Editing Operation

- 1 Select a Song for editing.
- 2 Call up the operation display.
[FUNCTION] → [F] DIGITAL REC MENU
- 3 Press the [A] button to call up the SONG CREATOR display to record or edit Songs.

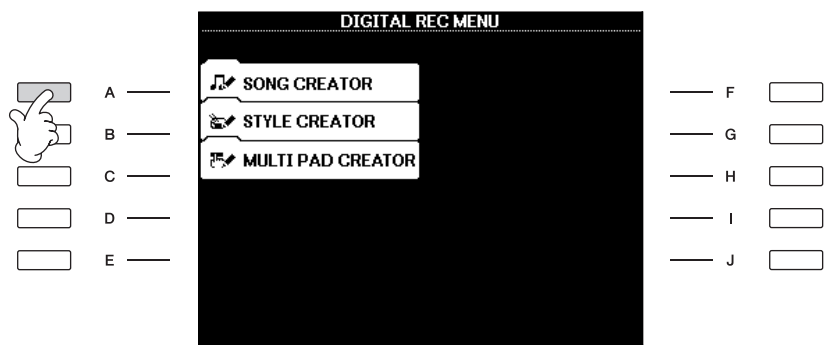

- 4 Select the appropriate tab by using the TAB [◀][▶] buttons and edit the Song.

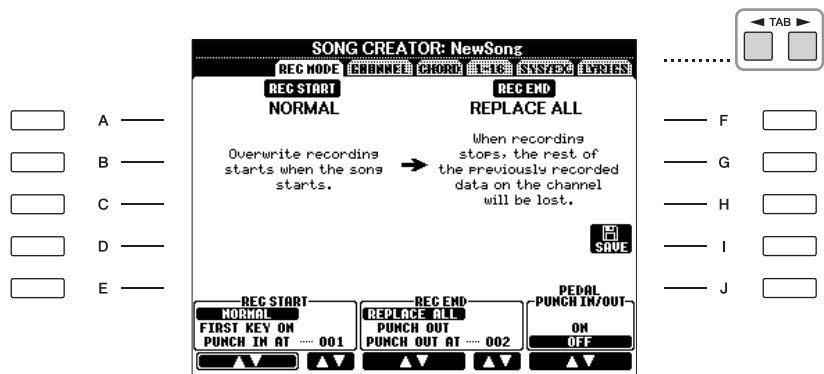

- **Re-Recording a Specific Section — Punch In/Out (REC MODE)** page 159
This lets you re-record a specific section of a Song.
- **Editing Channel Events (CHANNEL)** page 160
This lets you edit the channel events. For example, you can delete data or transpose notes by channel.
- **Editing Note or Chord Events (CHORD, 1–16)** page 163
This lets you change or delete the recorded notes or chords.
- **Editing System Event (SYS/EX.)** page 165
This lets you change the tempo or the time signature.
- **Editing Lyrics (LYRICS)**..... page 166
This lets you change the Song name or lyrics events.

Re-Recording a Specific Section — Punch In/Out (REC MODE)

When re-recording a specific section of an already-recorded Song, use the Punch In/OUT function. In this method, only the data between the Punch In point and the Punch Out point is overwritten with the newly recorded data. Keep in mind that the notes before and after the Punch In/Out points are not recorded over, although you will hear them play back normally to guide you in the Punch In/Out timing. You can specify the Punch In and Punch Out points as measure numbers beforehand for automatic operation, or manually execute the Punch In/Out recording by using a Foot Pedal or simply by playing the keyboard. The explanations here apply to the REC MODE display in step 4 of the “Basic Editing Operation” on page 158.

- 1 Use the [1 ▲ ▼]–[6 ▲ ▼] buttons to determine the settings for re-recording (see below).
- 2 While holding the SONG [REC] button, press the desired track button.

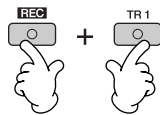

- 3 Press the SONG [▶ / ■■] (PLAY/PAUSE) button to start playback. Play the keyboard at the Punch In point and stop recording at the Punch Out point.
- 4 Press the [I] (SAVE) button to call up the Song Selection display for saving your data, then save the data in the Song Selection display (page 67).

■ PUNCH IN settings

NORMAL	Overwrite recording starts when pressing the SONG [▶ / ■■] (PLAY/PAUSE) button or when you play the keyboard in the Synchro Standby mode.
FIRST KEY ON	The Song plays back normally, then starts overwrite recording as soon as you play the keyboard.
PUNCH IN AT	The Song plays back normally up to the beginning of the indicated Punch In measure, then starts overwrite recording at that point. You can set the Punch In measure by pressing the [3 ▲ ▼] button.

■ PUNCH OUT settings

REPLACE ALL	This deletes all data after the point at which recording is stopped.
PUNCH OUT	The Song position at which recording is stopped is regarded as the Punch Out point. This setting maintains all data after the point at which recording is stopped.
PUNCH OUT AT	Actual overwrite recording continues until the beginning of the specified Punch Out measure (set with the corresponding display button), at which point recording stops and normal playback continues. This setting maintains all data after the point at which recording is stopped. You can set the Punch Out measure by pressing the [6 ▲ ▼] buttons.

⚠ CAUTION

The recorded Song data will be lost if you select another Song or turn the power to the instrument off without executing the Save operation (page 67).

Examples of re-recording with various Punch In/Out settings

This instrument features several different ways you use the Punch In/Out function. The illustrations below indicate a variety of situations in which selected measures in an eight-measure phrase are re-recorded.

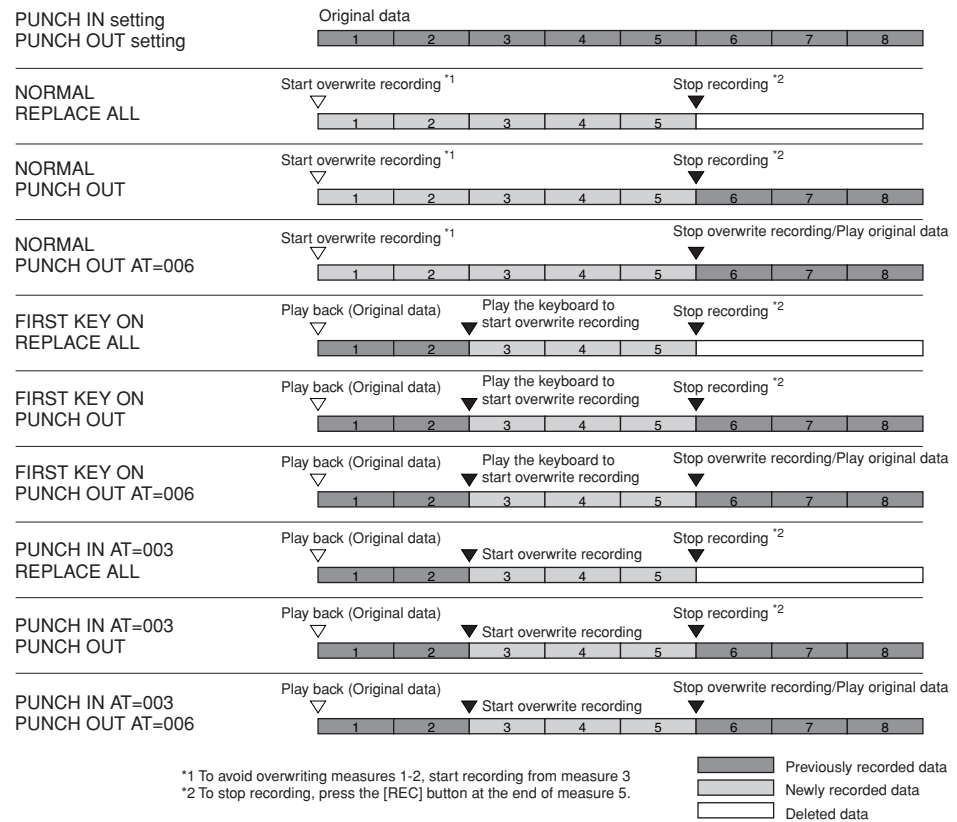

■ Pedal Punch In/Out settings

When this is set to ON, you can use the Foot Pedal 2 to control the punch-in and punch-out points. While a Song is playing back, pressing (and holding) the Foot Pedal 2 instantly enables Punch In recording, while releasing the pedal stops recording (Punch Out). You can press and release the Foot Pedal 2 as often as you want during playback, to punch in/out of overwrite recording. Note that the current function assignment of the Foot Pedal 2 is cancelled when the Pedal Punch In/Out function is set to ON.

Editing Channel Events (CHANNEL)

The explanations here apply to the CHANNEL tab display in the step 4 of the Basic Editing Operation on page 158.

- 1 Use the [A]/[B] buttons to select the Edit menu (page 161).
- 2 Use the [1▲▼]-[8▲▼] buttons to edit the data.
For information on the available parameters, see page 161.
- 3 Press the [D] (EXECUTE) button to execute the operation for the current display.
After the operation (with the exception of the SETUP menu display) is completed, this button changes to "UNDO", letting you restore the original data if you are not satisfied with the Operation results. The Undo function only has one level; only the immediate operation can be undone.

Pedal Punch In/Out operation may be reversed depending on the particular pedal you've connected to the instrument. If necessary, change the pedal polarity to reverse the control (page 168).

⚠ CAUTION
 The recorded Song data will be lost if you select another Song or turn the power to the instrument off without executing the Save operation (page 67).

- 4 Press the [I] (SAVE) button to call up the Song Selection display for saving your data, then save the data in the Song Selection display (page 67).

■ QUANTIZE menu

The Quantize function allows you to align the timing of all the notes in a channel. For example, if you record the musical phrase shown at right, you may not play it with absolute precision, and your performance may have been slightly ahead of or behind the precise timing. Quantize is a convenient way of correcting for this.



CHANNEL	Determines the channel in the Song to be quantized.										
SIZE	<p>Selects the quantize size (resolution). For optimum results, you should set the Quantize size to the shortest note value in the channel. For example, if eighth notes are the shortest in the channel, you should use eighth note as the Quantize size.</p> <p style="text-align: right;">After eighth note quantization</p> <p>Settings</p> <table style="width: 100%; text-align: center;"> <tr> <td> quarter note</td> <td> eighth note</td> <td> sixteenth note</td> <td> thirty-second note</td> <td> sixteenth note + eighth note triplet*</td> </tr> <tr> <td> quarter note triplet</td> <td> eighth note triplet</td> <td> sixteenth note triplet</td> <td> eighth note + eighth note triplet*</td> <td> sixteenth note + sixteenth note triplet*</td> </tr> </table> <p>The three Quantize settings marked with asterisks (*) are exceptionally convenient, since they allow you to quantize two different note values at the same time. For example, when the straight eighth notes and eighth notes triplet are contained in the same channel, if you quantize by the straight eighth notes, all notes in the channel are quantized to straight eighth notes — completely eliminating any triplet feel. However, if you use the eighth note + eighth note triplet setting, both the straight and triplet notes will be quantized correctly.</p>	quarter note	eighth note	sixteenth note	thirty-second note	sixteenth note + eighth note triplet*	quarter note triplet	eighth note triplet	sixteenth note triplet	eighth note + eighth note triplet*	sixteenth note + sixteenth note triplet*
quarter note	eighth note	sixteenth note	thirty-second note	sixteenth note + eighth note triplet*							
quarter note triplet	eighth note triplet	sixteenth note triplet	eighth note + eighth note triplet*	sixteenth note + sixteenth note triplet*							
STRENGTH	<p>Determines how strongly the notes will be quantized. A setting of 100% produces exact timing. If a value less than 100% is selected, notes will be moved toward the specified quantization beats according to the specified percentage. Applying less than 100% quantization lets you preserve some of the “human” feel in the recording.</p>										

■ Deleting the data of the specified channel (DELETE menu)

You can delete the data of the specified channel in the Song. Select the channel whose data to be deleted by using the [1 ▲ ▼]–[8 ▲ ▼] buttons, then press the [D] (EXECUTE) button to execute the operation.

About Quantize size (resolution)

The Quantize size or resolution is the number of clocks per quarter note.

■ **Mixing (merging) the data of the specified two channels (MIX menu)**

This function lets you mix the data of the two channels and place the results in a different channel. It also lets you copy the data from one channel to another.

SOURCE 1	Selects the channel (1–16) to be mixed. All MIDI events in the selected channel are copied to the destination channel.
SOURCE 2	Selects the channel (1–16) to be mixed. Only note events in the selected channel are copied to the destination channel. In addition to the values 1–16, there is a “COPY” setting that allows you to copy the data from Source 1 to the destination channel. If “COPY” is selected here, the data from Source 1 is copied to the destination channel. (The original channel data is maintained.)
DESTINATION	Selects the channel into which the mix or copy results will be placed.

■ **CHANNEL TRANSPOSE menu**

This allows you to transpose the recorded data of individual channels up or down by a maximum of two octaves in semitone increments.

To display the channels 9–16

Press the [F] button to toggle between the two channel displays — Channels 1–8, and Channels 9–16.

Transposing to the same value for all channels simultaneously

While holding the [G] (ALL CH) button, press one of the [1 ▲ ▼]–[8 ▲ ▼] buttons.

SETUP menu

The current settings of the Mixing Console (page 84) displays and other panel settings can be recorded to the top position of the Song as the Setup data. The Mixing Console and panel settings recorded here are automatically recalled when the Song starts.

■ **Setup recording procedure**

- 1 **Call up the operation display.**
[FUNCTION] → [F] DIGITAL REC MENU → [A] SONG CREATOR → TAB [◀][▶] CHANNEL → [B] SET UP
- 2 **Use the [1 ▲ ▼]–[7 ▲ ▼] buttons to determine the settings to be automatically called up when the Song starts.**

SONG	Records the tempo setting and all settings made from the Mixing Console.
KEYBOARD VOICE	Records the panel settings including the Voice selection of the keyboard parts (RIGHT1, 2, and LEFT) and their on/off status. Panel settings recorded here are same as the ones memorized to the One Touch Setting. This can be recorded at any point in a Song (the other items in this chart can be recorded only to the top position of the Song).
SCORE SETTING	Records the settings in the Score display.
GUIDE SETTING	Records the settings of the Guide functions including the Guide ON/OFF setting.
LYRICS SETTING	Records the settings in the Lyrics display.

- 3 **Checkmark the selected item by pressing the [8 ▲] button.**
- 4 **Press the [D] (EXECUTE) button to execute the SETUP recording operation.**
- 5 **Press the [I] (SAVE) button to call up the Song Selection display for saving your data, then save the data in the Song Selection display (page 67).**

⚠ CAUTION
The recorded Song data will be lost if you select another Song or turn the power to the instrument off without executing the Save operation (page 67).

Editing Note or Chord Events (CHORD, 1–16)

The explanations here apply to the CHORD and 1–16 tab displays in step 4 of the Basic Editing Operation on page 158.

- 1 **When the 1–16 tab display is elected, press the [F] button to select the channel to be edited.**
- 2 **Move the cursor to the desired data.**
 To move the cursor up or down Use the [A]/[B] button.
 To move the cursor to the top data Press the [C] button.
 To move the cursor by Measure/Beat/Clock units Use the [1 ▲ ▼]–[3 ▲ ▼] buttons.
- 3 **Edit the data.**
 - Editing the data line by line**
 Use the [6 ▲ ▼]–[8 ▲] buttons to cut/copy/paste/insert/delete the events.
 - Editing each parameter of the data**
 - 1 Use the [D]/[E] buttons to select the parameter to be edited.
 - 2 Use the [4 ▲ ▼]/[5 ▲ ▼] buttons to edit the parameter value. The DATA ENTRY dial can also be used. To actually enter an edited value, simply move the cursor away from the parameter.

To restore the original value, press the [8 ▼] (CANCEL) button before move the cursor.
- 4 **When the CHORD tab display is selected, press the [F] (EXPAND) button to convert the data into Song data.**
- 5 **Press the [I] (SAVE) button to call up the Song Selection display for saving your data, then save the data in the Song Selection display (page 67).**

Selecting multiple lines of data

While holding the [J] (MULTI SELECT) button, press the [A]/[B] buttons.

Displaying specific types of event (FILTER)

You can select the event types to be displayed in the [CHORD] and [1-16] tab displays. This is convenient, for example, when you wish to have only the note events shown (page 165).

⚠ CAUTION

The recorded Song data will be lost if you select another Song or turn the power to the instrument off without executing the Save operation (page 67).

Chord and Section data recorded with Realtime Recording cannot be indicated and edited on this display.

About Clock

A unit of note resolution. The Quantize size is the number of clocks per quarter note. On the PSR-OR700, one clock is equal to 1/1920th of a quarter note.

About the events shown in the display

Example **001 : 1 : 1440**

Measure number (BAR) | Beat | Clock

- ❶ Indicates the location (position) of the corresponding event. Same as the indication at the lower left of the display.
- ❷ Indicates the event types (see below).
- ❸ Indicates the event values.

Event types shown on the 1-16 tab display

Note	The individual note of a Song. Includes the note number which corresponds to the key which was played, plus a velocity value based on how hard the key is played, and the gate time value (the length of a note).
Ctrl (Control Change)	Settings to control the Voice, such as volume, pan, filter and effect depth (edited via the Mixing Console described on page 84), etc.
Prog (Program Change)	MIDI program change number for selecting a Voice.
P.Bnd (Pitch Bend)	Data for changing the pitch of a Voice continuously.
A.T. (Aftertouch)	This event is generated when pressure is applied to a key after the note is played.

Event types shown on the CHORD tab display

Style	Style
Tempo	tempo
Chord	chord root, chord type, on bass chord
Sect	Accompaniment Style Section (Intro, Main, Fill In, Break, Ending)
OnOff	On/off status for each part (channel) of the Accompaniment Style
CH.Vol	Volume for each part (channel) of the Accompaniment Style
S.Vol	Overall volume of the Accompaniment Style

Displaying Specific Types of Events (FILTER)

In the edit displays various types of events are shown. It may sometimes be difficult to pinpoint the ones you want to edit. This is where the Filter function comes in handy. It lets you determine which event types will be shown in the edit displays.

- 1 Press the [H] (FILTER) button in the edit displays.
- 2 Select the event type by using the [2▲▼]–[5▲▼] buttons.
- 3 Checkmark (show) or remove the checkmark for the selected item by using the [6▲▼]/[7▲▼] buttons.
 - [H](ALL ON)..... Checkmarks for all event types.
 - [I] (NOTE/CHORD)..... Selects only NOTE/CHORD data.
 - [J] (INVERT) Reverses the checkmark settings for all boxes. In other words, this enters checkmarks to all boxes that were previously unchecked and vice versa.
- 4 Press the [EXIT] button to execute the settings.

Pressing the [C]–[E] buttons calls up the respective Filter displays as shown below.

MAIN Call up the Main Filter display.
 CTRL CHG Call up the Control Change Filter display.
 STYLE Call up the Accompaniment Style Filter Display.

Editing System Exclusive Events (SYS/EX.)

The explanations here apply to the [SYS/EX] tab display in step 4 of the Basic Editing Operation on page 158.

From this display, you can edit recorded System Exclusive events, which do not belong to a specific channel, such as tempo and beat (time signature). The operations here are basically the same as those in the section “Editing Note or Chord Events” on page 163.

System Events

ScBar (Score Start Bar)	Determines the top measure of a Song.
Tempo	Determines the tempo value.
Time (Time Signature)	Determines the time signature.
Key (Key Signature)	Determines the key signature, as well as the major/minor setting, for the music score shown on the display.
XGPm (XG Parameters)	Allows you to make various detailed changes to the XG parameters. Refer to the “MIDI Data Format” in the Data List for details. The Data List is available at the Yamaha website. (See page 5.)
SysEx (System Exclusive)	Displays the System Exclusive data in the Song. Keep in mind that you cannot create new data or change the contents of the data here; however, you can delete, cut, copy, and paste the data.
Meta (Meta Event)	Displays the SMF meta events in the Song. Keep in mind that you cannot create new data or change the contents of the data here; however, you can delete, cut, copy, and paste the data.

Press the [I] (SAVE) button to call up the Song Selection display for saving your data, then save the data in the Song Selection display (page 67).



CAUTION

The recorded Song data will be lost if you select another Song or turn the power to the instrument off without executing the Save operation (page 67).

Editing Lyrics (LYRICS)

The explanations here apply to the LYRICS tab display in step 4 of the Basic Editing Operation on page 158. From this display, you can edit the recorded Lyrics events. The operations here are basically the same as in the section “Editing Note or Chord Events” on page 163.

Lyrics Events

Name	Allows you to enter the Song name.
Lyrics	Allows you to enter lyrics.
Codes	<p>CR Enters a line break in the lyrics text.</p> <p>LF Unavailable on the instrument. On some MIDI devices, this event may delete the currently displayed lyrics and display the next set of lyrics.</p>

Inputting and Editing Lyrics

- 1 Use the [4 ▲ ▼]/[5 ▲ ▼](DATA ENTRY) buttons to call up the lyrics editing display.
Operations are the same as in the section “Entering Characters” (page 71).
- 2 Press the [I] (SAVE) button to call up the Song Selection display for saving your data, then save the data in the Song Selection display (page 67).

CAUTION

The recorded Song data will be lost if you select another Song or turn the power to the instrument off without executing the Save operation (page 67).

Using Your Instrument with Other Devices

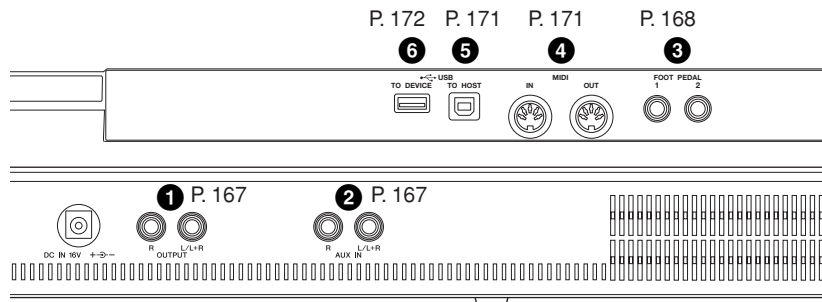

CAUTION
 Before connecting the instrument to other electronic components, turn off the power of all the components. Also, before turning any components on or off, make sure to set all volume levels to minimum (0). Otherwise, electrical shock or damage to the components may occur.

Connecting Audio Devices

NOTE
 Use audio cables and adaptor plugs having no (zero) resistance.

Using External Audio Devices for Playback (1 [OUTPUT] jacks)

You can connect these jacks to a stereo system to amplify the instrument's sound. Use audio cables for connection as shown in the diagrams. These jacks are located on the underside jacks panel of the instrument.

CAUTION

- When the instrument's sound is output to an external device, first turn on the power to the instrument, then to the external device. Reverse this order when you turn the power off.
- Do not route the output from the [OUTPUT] jacks to the [AUX IN] jacks. If you make this connection, the signal input at the [AUX IN] jacks is output from the [OUTPUT] jacks. These connections could result in a feedback loop that will make normal performance impossible, and may even damage both pieces of equipment.

When these are connected, you can use the instrument's [MASTER VOLUME] control to adjust the volume of the sound output to the external device. Connect the instrument's OUTPUT [L/L+R]/[R] jacks (standard phone jacks) and the input jacks of a pair of powered speakers using appropriate audio cables. Use only the [L/L+R] jack for connection with a monaural device.

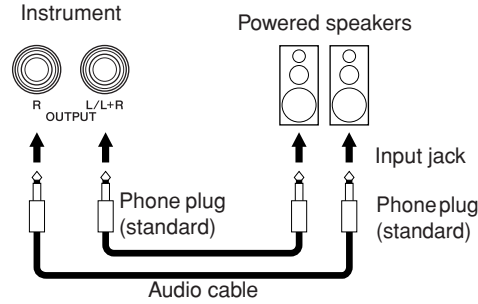

Playing External Audio Devices with the Built-in Speakers (2 [AUX IN] jacks)

The stereo outputs from another instrument can be connected to these jacks, allowing the sound of an external instrument to be reproduced via the instrument's speakers. Connect the output jacks (LINE OUT etc.) of an external synthesizer or the tone generator module and the instrument's AUX IN [L/L+R]/[R] jacks using appropriate audio cables.

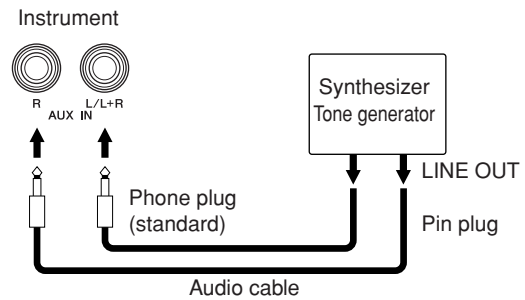

CAUTION
 When the sound of an external device is output to the instrument, first turn on the power to the external device, then to the instrument. Reverse this order when you turn the power off.

NOTE

- Use only the [L/L+R] jack for connection with a monaural device.
- The instrument's [MASTER VOLUME] setting affects the input signal from the [AUX IN] jacks.

Using the Footswitch or Foot Controller (3 [FOOT PEDAL 1/2] jacks)

Two FOOT PEDAL jacks can be used via the following functions at the initial default setting (factory setting).

- **FOOT PEDAL 1 jack**

Plug an optional Yamaha FC4 or FC5 footswitch into this jack and use it to switch sustain on and off. The footswitch functions like the damper pedal on a piano — press for sustain, release for normal sound.

- **FOOT PEDAL 2 jack**

Plug an optional Yamaha FC7 foot controller into this jack and use it to change the volume as you play the instrument (expression function).

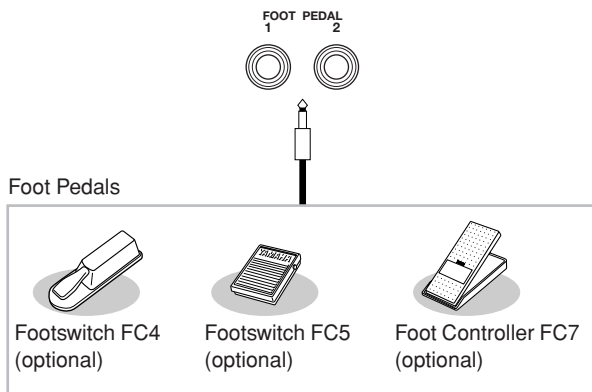

CAUTION
Make sure to connect or disconnect the pedal only when the power is off.

Assigning Specific Functions to Each Foot Pedal

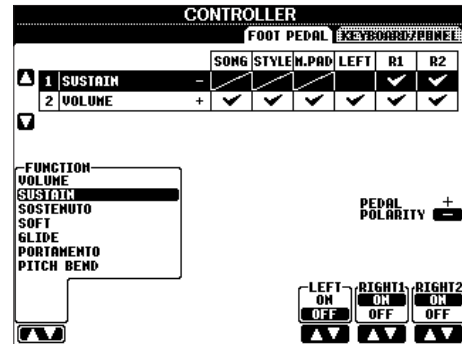

The functions assigned by default to the connected footswitch or foot controller can be changed — for example, letting you use the footswitch to start/stop Style playback, or use the foot controller to produce pitch bends.

- 1 **Call up the operation display.**
[FUNCTION] → [D] CONTROLLER → TAB [◀|▶]
FOOT PEDAL
- 2 **Use the [A]/[B] buttons to select one of the two foot pedals to which the function is to be assigned.**
- 3 **Use the [1 ▲ ▼] button to select the functions to be assigned to the pedal specified in step 2.**
Details on the pedal functions are listed below.
- 4 **Use the [2 ▲ ▼]–[8 ▲ ▼] buttons to set the details of the selected functions.**
The available parameters differ depending on the function selected in step 3. Details on the parameters are given on page 169.
- 5 **Check that the desired function is controllable with the pedal by actually pressing the pedal.**

NOTE When you use the pedals to switch Registration Memory settings (page 134), these settings are invalid.

Set the polarity of the pedal

Pedal on/off operation may differ depending on the particular pedal you've connected to the instrument. For example, pressing down on one pedal may turn the selected function on, while pressing a different make/brand of pedal may turn the function off. If necessary, use this setting to reverse the control. Press the [I] (PEDAL POLARITY) button to switch the polarity.

Details on the pedal functions are listed here. For functions indicated with “*”, use only the foot controller; proper operation cannot be done with a footswitch.

Assignable Pedal Functions

VOLUME*	Allows you to use a foot controller to control the volume.
SUSTAIN	Allows you to use a pedal to control the sustain. When you press and hold the pedal, all notes played on the keyboard have a longer sustain. Releasing the pedal immediately stops (damps) any sustained notes.
SOSTENUTO	Allows you to use a pedal to control the Sostenuato effect. If you play a note or chord on the keyboard and press the pedal while holding the note(s), the notes will sustain as long as the pedal is held. However, all subsequent notes will not sustain. This makes it possible to sustain a chord, for example, while other notes are played staccato.
SOFT	Allows you to use a pedal to control the Soft effect. Pressing this pedal reduces the volume and changes the timbre of the notes you play. This is effective only for certain appropriate Voices.
GLIDE	When the pedal is pressed, the pitch changes, and then returns to normal pitch when the pedal is released.
PORTAMENTO	The portamento effect (a smooth slide between notes) can be produced while the pedal is pressed. Portamento is produced when notes are played legato style (i.e., a note is played while the preceding note is still held). Portamento Time can also be adjusted from the Mixing Console (page 86). This function does not affect certain Natural Voices, which would not sound appropriately with this function.
PITCH BEND*	Allows you to bend the pitch of notes up or down by using the pedal.
MODULATION*	Applies a vibrato effect to notes played on the keyboard. The effect becomes deeper when pressing down the foot controller. You can turn this function on/off for each keyboard part on this display.
DSP VARIATION	Switches Voice Effect DSP VARIATION on and off.
HARMONY/ECHO	Switches the HARMONY/ECHO Voice Effect on and off.
SCORE PAGE+	While the song is stopped, you can turn to the next score page.
SCORE PAGE-	While the song is stopped, you can turn to the previous score page.
LYRICS PAGE+	While the song is stopped, you can turn to the next lyrics page.
LYRICS PAGE-	While the song is stopped, you can return to the last lyrics page.
SONG PLAY/PAUSE	Same as the SONG [▶ / ■] (PLAY/PAUSE) button.
STYLE START/STOP	Same as the STYLE CONTROL [START/STOP] button.
TAP TEMPO	Same as the [TAP TEMPO] button.
SYNCHRO START	Same as the [SYNC START] button.
SYNCHRO STOP	Same as the [SYNC STOP] button.
INTRO1-3	Same as the [INTRO I-III] buttons.
MAIN A-D	Same as the [MAIN VARIATION A-D] buttons.
FILL DOWN	Plays a fill-in, which is automatically followed by the Main section of the button on the immediate left.
FILL SELF	Plays a fill-in.
FILL BREAK	Plays a break.
FILL UP	Plays a fill-in, which is automatically followed by the Main section of the button on the immediate right.
ENDING1-3	Same as the [ENDING/rit. I-III] buttons.
FADE IN/OUT	Same as the [FADE IN/OUT] button.
FINGERED/FING ON BASS	The pedal alternately switches between the Fingered and On Bass modes (page 103).

BASS HOLD	While the pedal is pressed, the Accompaniment Style bass note will be held even if the chord is changed during Style playback. If the fingering is set to "AI FULL KEYBOARD," the function does not work.
PERCUSSION	The pedal plays a percussion instrument selected by the [4 ▲ ▼]–[8 ▲ ▼] buttons. You can use the keyboard to select the desired percussion instrument.
RIGHT1 ON/OFF	Same as the PART ON/OFF [RIGHT 1] button.
RIGHT2 ON/OFF	Same as the PART ON/OFF [RIGHT 2] button.
LEFT ON/OFF	Same as the PART ON/OFF [LEFT] button.
OTS+	Calls up the next One Touch Setting.
OTS–	Calls up the previous One Touch Setting.

NOTE The Sostenuto and Portamento functions will not affect the Organ Flute Voices, even if they have been assigned to the Foot Pedals.

Adjustable Parameters for Each Function

The parameters below correspond to buttons [2 ▲ ▼]–[8 ▲ ▼], and their availability depends on the selected control type. For example, if SUSTAIN is selected as the type, the parameters "HALF PEDAL POINT," "RIGHT 1," "RIGHT 2" and "LEFT" automatically appear in the display.

SONG, STYLE, M.PAD, LEFT, RIGHT1, RIGHT2	These specify the part(s) that will be affected by the pedal.
UP/DOWN	When GLIDE or PITCH BEND is selected, this determines whether the pitch change is raised or lowered.
RANGE	When GLIDE or PITCH BEND is selected, this determines the range of the pitch change, in semitones. Linked to the Mixing Console → Pitch Bend Range (page 86) setting.
ON SPEED	When GLIDE is selected, this determines the speed of the pitch change, when the pedal is pressed.
OFF SPEED	When GLIDE is selected, this determines the speed of the pitch change, when the pedal is released.
KIT	When PERCUSSION is assigned to the pedal, all available drum kits are shown here, letting you select the particular drum kit used for the pedal.
PERCUSSION	When PERCUSSION is assigned to the pedal, all sounds of the selected drum kit (in KIT above) are shown here. This determines the particular instrument sound assigned to the pedal.

Connecting External MIDI Devices (4 [MIDI] terminals)

Use the built-in [MIDI] terminals and standard MIDI cables to connect external MIDI devices.

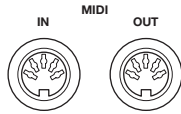

MIDI IN	Receives MIDI messages from an external MIDI device.
MIDI OUT	Transmits MIDI messages generated by the instrument.

For a general overview of MIDI and how you can effectively use it, refer to the following sections:

- What is MIDI?.....page 174
- What You Can Do With MIDI.....page 176
- MIDI Settings.....page 177

Connecting to a computer and USB device

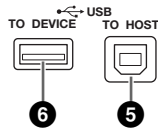

Connecting a Computer (4 [MIDI] and 5 [USB TO HOST] terminals)

By connecting a computer to the [USB TO HOST] or [MIDI] terminals, you can transfer data between the instrument and the computer via MIDI, and take advantage of sophisticated computer music programs. Keep in mind that you also need to install an appropriate USB-MIDI driver.

The instructions below explain how to connect and use the terminals.

NOTE

If you are using a computer that has a USB interface, we recommend that you connect the computer and the instrument by USB, rather than by MIDI.

NOTE

Driver

A driver is software that provides a data-transfer interface between the computer's operating system and a connected hardware device. You need to install a USB-MIDI driver to connect the computer and the instrument. Refer to the separate Installation Guide (page 4).

(This explanation is divided into two parts, covering the two connections: connection to the [USB TO HOST] terminal and connection to the [MIDI] terminal.)

• **Connecting to the [USB TO HOST] terminal**

When connecting the instrument to the computer via USB, use a standard USB cable (having the USB logo) to connect the [USB TO HOST] terminal on the instrument to the USB terminal of the computer. Then, install the USB-MIDI driver.

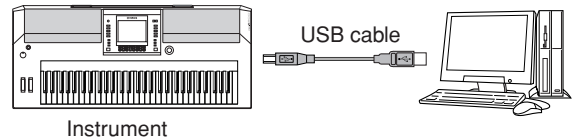

NOTE

About the [USB TO HOST] and [USB TO DEVICE] terminals

There are two different types of USB terminals on the instrument: [USB TO HOST] and [USB TO DEVICE]. Take care not to confuse the two terminals and the corresponding cable connectors. Be careful to connect the proper plug in the proper direction. Explanations on the [USB TO DEVICE] terminal follow in the next section.

CAUTION

Precautions when using the [USB TO HOST] terminal

When connecting the computer to the [USB TO HOST] terminal, make sure to observe the following points. Failing to do so risks freezing the computer and corrupting or losing data. If the computer or the instrument freezes, turn the power to the instrument off and restart the computer.

- Before connecting the computer to the [USB TO HOST] terminal, exit from any power-saving mode of the computer (such as suspended, sleep, standby), and quit any open application software, also turns off the power to the instrument.
- Execute the following before turning the power to the instrument off or unplugging the USB cable to/from the instrument/computer.
 - Quit any open application software on the computer.
 - Make sure that data is not being transmitted from the instrument. (Data is transmitted only by playing notes on the keyboard or playing back a song.)
- **While a USB device is connected to the instrument, you should wait for six seconds or more between these operations: When turning the power of the instrument off then on again, or when alternately connecting/disconnecting the USB cable.**

NOTE

- The instrument will begin transmission a short time after the USB connection is made.
- When using a USB cable to connect the instrument to your computer, make the connection directly without passing through a USB hub.
- For information on setting up your sequence software, refer to the owner's manual of the relevant software.

• **Connection by [MIDI] terminals**

There are two ways to connect the instrument via MIDI to a computer. If you have a MIDI interface built into your computer, connect the MIDI OUT terminal of the computer interface to the [MIDI IN] terminal of the instrument, and connect the [MIDI OUT] terminal of the instrument to the MIDI IN terminal of the interface.

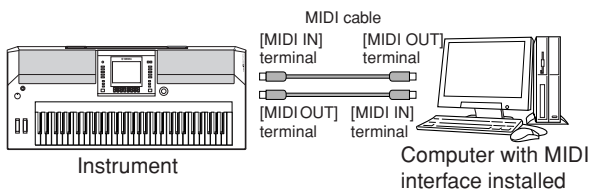

The second connection possibility involves a separate, external MIDI interface connected to the computer via a USB port or a serial port (modem or printer terminal). Using standard MIDI cables, connect the MIDI OUT terminal of the external interface to the [MIDI IN] terminal of the instrument, and connect the [MIDI OUT] terminal of the instrument to the MIDI IN terminal of the interface.

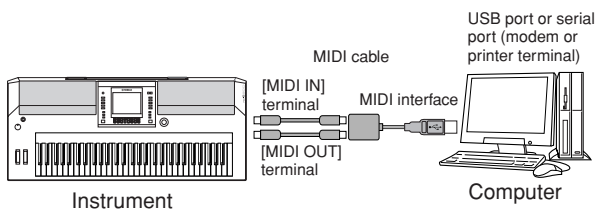

NOTE

Make sure to use the appropriate MIDI interface for your computer.

Connecting to a USB Storage Device (6) via the [USB TO DEVICE] terminal)

By connecting the instrument to a USB storage device with a standard USB cable, you can save data you've created to the connected device, as well as read data from the connected device.

NOTE

About the [USB TO HOST] and [USB TO DEVICE] terminals
 There are two different types of USB terminals on the instrument: [USB TO HOST] and [USB TO DEVICE]. Take care not to confuse the two terminals and the corresponding cable connectors. Be careful to connect the proper plug in the proper direction. Explanations on the [USB TO HOST] terminal can be found in the previous section.

Using USB Storage Devices

This type is used to connect the instrument to a USB storage device, and allows you to save data you've created to the connected device, as well as read data from the connected device. The following description generally explains about how to connect and use them. Before using a USB storage device, be sure to read "Handling the USB Storage Device (USB Flash Memory/Floppy Disk, etc)" on page 23.

- 1 **Connect the USB storage device to the [USB TO DEVICE] terminal with a standard USB cable.**
- 2 **After that, exit once from the selection display then return to the display (or press the Tab switch buttons [◀] and [▶] simultaneously from the selection display). The USB tabs (USB 1, USB 2, etc.) are automatically called up, allowing you to save files and play back music data from the devices.**

NOTE

Checking remaining memory on the USB storage device

You can check this in the display called up by the following operation:
 [FUNCTION] → [J] UTILITY → TAB [◀][▶] MEDIA
 Select the device by using the [A]/[B] buttons in this display and press [F] (PROPERTY).

NOTE

Even with a computer connected to the [USB TO HOST] terminal and a USB storage device connected to the [USB TO DEVICE] terminal, you cannot access the USB storage device from the computer via the instrument.

Formatting USB storage media

For details, see page 66.

CAUTION

The format operation overwrites any previously existing data. Proceed with caution.

Backing up your data to a computer

■ **Backing up the instrument data to a computer**

Once you've saved data to a USB storage device, you can copy the data to the hard disk of your computer, then archive and organize the files as desired. Simply reconnect the device as shown below.

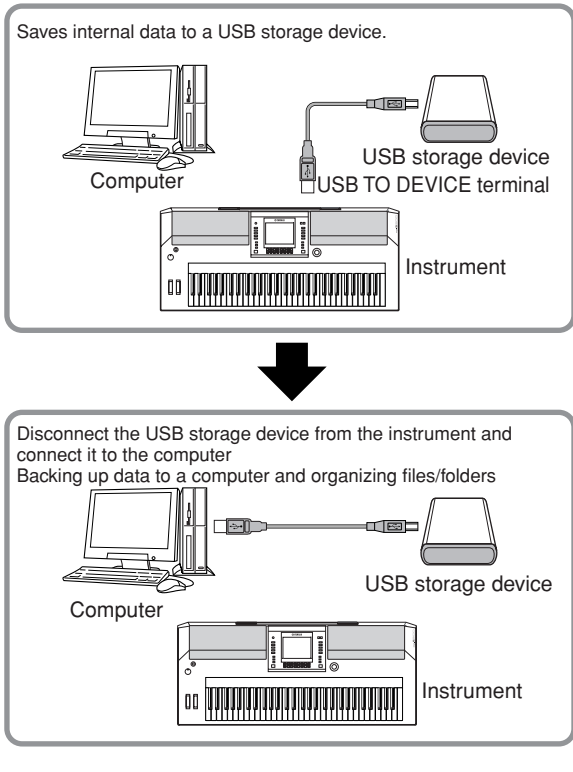

Copying files from a computer hard disk to a USB storage device

Files contained on the hard disk of a computer can be transferred to the instrument by first copying them to the storage media, then connecting the storage device to the instrument.

Not only files created on the instrument itself but also Standard MIDI files and Style File-formatted Style files created on other devices can be copied to a USB storage device from the hard disk of the computer. Once you've copied the data, connect the device to the [USB TO DEVICE] terminal of the instrument, and play back the data on the instrument.

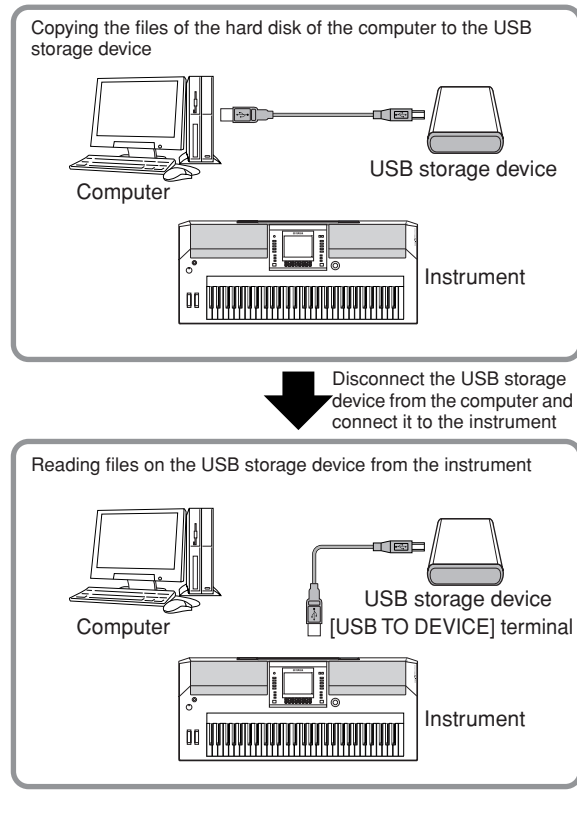

What is MIDI?

Put simply, MIDI is a data transfer standard that allows easy and comprehensive control among electronic/digital music instruments and other devices. To get a better idea of what MIDI does, let's first consider acoustic instruments, such as a grand piano and a classical guitar. With the piano, you strike a key, and a hammer inside hits some strings and plays a note. With the guitar, you directly pluck a string and the note sounds. But how does a digital instrument go about playing a note?

Acoustic guitar note production

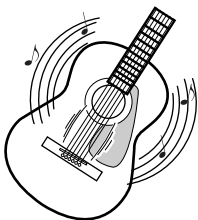

Pluck a string and the body resonates the sound.

Digital instrument note production

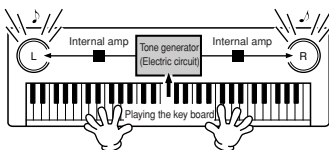

Based on playing information from the keyboard, a sampled note stored in the tone generator is played through the speakers.

As shown in the illustration above, in an electronic instrument the sampled note (previously recorded note) stored in the tone generator section (electronic circuit) is played based on information received from the keyboard.

Now, let's examine what happens when we playback a recording. When you play back a music CD (for example, a solo piano recording), you're hearing the actual sound (vibration in air) of the acoustic instrument. This is called audio data, to distinguish it from MIDI data.

Recording and playing back the performance of an acoustic instrument (audio data)

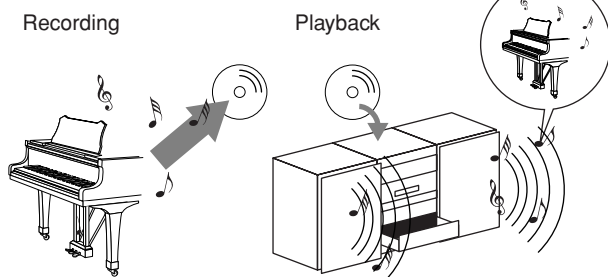

In the above example, the actual acoustic sounds of the pianist's performance are captured in the recording as audio data, and this is recorded to CD. When you play back that CD on your audio system, you can hear the actual piano performance. The piano itself is not necessary, since the recording contains the actual sounds of the piano, and your speakers reproduce them.

Recording and play back the performance of a digital instrument (MIDI data)

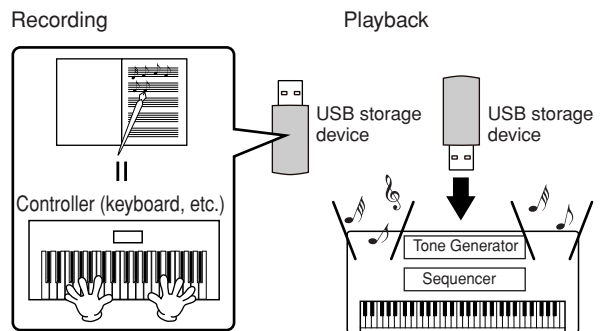

NOTE

In the case of digital instruments, the audio signals are sent through output jacks (such as [AUX OUT]) on the instrument.

The "controller" and "tone generator" in the illustration above are equivalent to the piano in our acoustic example. Here, the player's performance on the keyboard is captured as MIDI song data (see illustration below). In order to record the audio performance on an acoustic piano, special recording equipment is needed. However, since the PSR-OR700 features a built-in sequencer that lets you record performance data, this recording equipment is unnecessary. Instead, your digital instrument allows you to both record and play back the data.

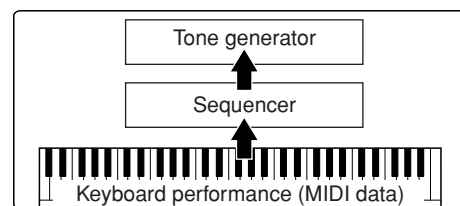

However, we also need a sound source to produce the audio, which eventually comes from your speakers. The tone generator of the instrument fills this function. The recorded performance is reproduced by the sequencer, playing back the song data, using a tone generator capable of accurately producing various instrument sounds — including that of a piano. Looked at in another way, the relation of the sequencer and the tone generator is similar to that of the pianist and the piano — one plays the other. Since digital instruments handle playback data and the actual sounds independently, we can hear our piano performance played by another instrument, such as guitar or violin.

NOTE

Even though it is a single musical instrument, the PSR-OR700 can be thought of as containing several electronic components: a controller, a tone generator, and a sequencer.

Finally, we'll take a look at the actual data that gets recorded and that serves as the basis for playing the sounds. For example, let's say you play a "C" quarter note using the grand piano sound on the instrument's keyboard. Unlike an acoustic instrument that puts out a resonated note, the electronic instrument puts out information from the keyboard such as "with what voice," "with which key," "about how strong," "when was it pressed" and "when was it released." Then each piece of information is changed into a number value and sent to the tone generator. Using these numbers as a basis for sound generation, the tone generator plays the stored sampled note.

Example Keyboard Data

Voice number (with what voice)	01 (grand piano)
Note number (with which key)	60 (C3)
Note on (when was it pressed) and note off (when was it released)	Timing expressed numerically (quarter note)
Velocity (strength at which it was played)	120 (strong)

Panel operations on the instrument, such as playing the keyboard and selecting voices, are processed and stored as MIDI data. The auto accompaniment Styles and Songs also consist of MIDI data.

MIDI is an acronym that stands for Musical Instrument Digital Interface, which allows electronic musical instruments to communicate with each other, by sending and receiving compatible Note, Control Change, Program Change and various other types of MIDI data, or messages.

The instrument can control a MIDI device by transmitting note related data and various types of controller data. The instrument can be controlled by incoming MIDI messages which automatically determine the tone generator mode, select MIDI channels, voices and effects, change parameter values and of course play the voices specified for the various parts.

NOTE

MIDI data has the following advantages over audio data:

- The amount of data is much less.
- The data can be effectively and easily edited, even to the point of changing voices and transforming the data.

MIDI messages can be divided into two groups: Channel messages and System messages.

Channel Messages

The PSR-OR700 is an electronic instrument that can handle 16 MIDI channels (or reception of 32 channels for MIDI data reception when using the [USB] terminal). This is usually expressed as "it can play 16 instruments at the same time." Channel messages transmit information such as Note ON/OFF, Program Change, for each of the 16 channels.

Message Name	Operation/Panel Setting
Note ON/OFF	Messages which are generated when the keyboard is played. Each message includes a specific note number which corresponds to the key which is pressed, plus a velocity value based on how hard the key is played.
Program Change	For selecting Voices (with control change bank select MSB/LSB settings)
Control Change	Volume, panpot (Mixing Console), MODULATION Wheel operation etc.
Pitch Bend	PITCH BEND Wheel operation

NOTE

The performance data of all Songs and Styles is handled as MIDI data.

MIDI Channels

MIDI performance data is assigned to one of sixteen MIDI channels. Using these channels, 1–16, the performance data for sixteen different instrument parts can be simultaneously sent over one MIDI cable.

Think of the MIDI channels as TV channels. Each TV station transmits its broadcasts over a specific channel. Your home TV set receives many different programs simultaneously from several TV stations and you select the appropriate channel to watch the desired program.

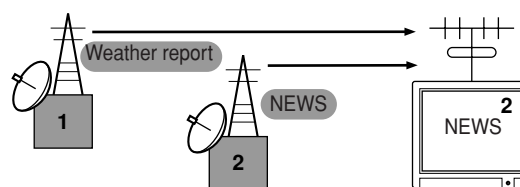

MIDI operates on the same basic principle. The transmitting instrument sends MIDI data on a specific MIDI channel (MIDI Transmit Channel) via a single MIDI cable to the receiving instrument. If the receiving instrument's MIDI channel (MIDI Receive Channel) matches the Transmit Channel, the receiving instrument will sound according to the data sent by the transmitting instrument.

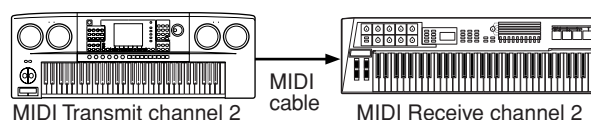

NOTE

The instrument's keyboard and internal tone generator are also connected by MIDI. → LOCAL CONTROL (page 180)

For example, several parts or channels can be transmitted simultaneously, including the Style data (as shown on the next page).

Example: Recording a performance with the auto accompaniment (Style playback) sound of the instrument to an external sequencer

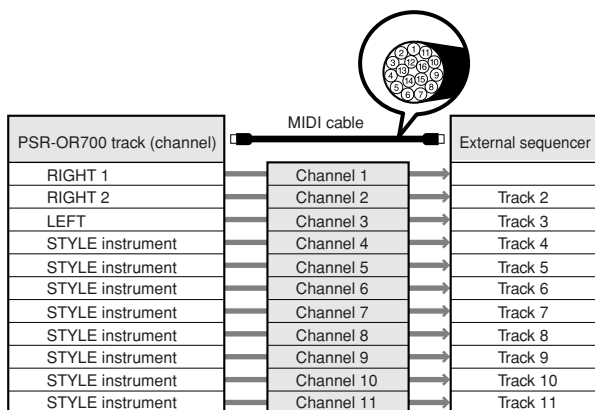

As you can see, it is essential to determine which data is to be sent over which MIDI channel when transmitting MIDI data (page 180). The instrument also allows you to determine how the received data is played back (page 181).

System Messages

This is data that is used in common by the entire MIDI system. These include System Exclusive messages for transferring data unique to each instrument manufacturer and Realtime messages for controlling the MIDI device.

Message Name	Operation/Panel Setting
System Exclusive Message	Effect type settings (Mixing Console), etc.
Realtime Messages	Clock setting, Start/stop operation

The messages transmitted/received by the PSR-OR700 are shown in the MIDI Data Format and MIDI Implementation Chart in the Data List. The Data List is available at the Yamaha website. (See page 5.)

What You Can Do With MIDI

- Record your performance data (1–16 channels) using the auto accompaniment features on an external sequencer (or computer with sequencer software). After recording, edit the data with the sequencer, then play it back on the instrument.

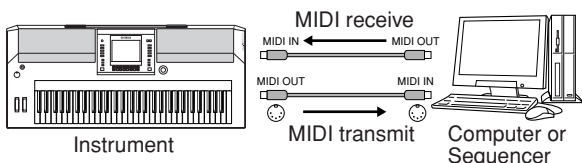

When you want to use the instrument as an XG-compatible multi-timbral tone generator, set the receive part for MIDI channels 1-16 to "SONG" in MIDI/USB 1 in MIDI Receive (page 181).

- Controlling from an external MIDI keyboard

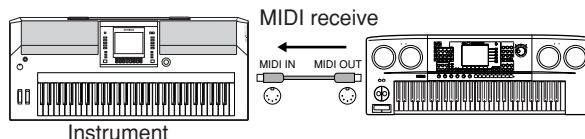

MIDI Data Compatibility

This section covers basic information on data compatibility: whether or not other MIDI devices can playback the data recorded by PSR-OR700, and whether or not the PSR-OR700 can playback commercially available song data or song data created for other instruments or on a computer. Depending on the MIDI device or data characteristics, you may be able to play back the data without any problem, or you may have to perform some special operations before the data can be played back. If you run into problems playing back data, please refer to the information below.

Sequence Formats

Song data is recorded and stored in a variety of different systems, referred to as "sequence formats."

Playback is only possible when the sequence format of the Song data matches that of the MIDI device. The PSR-OR700 is compatible with the following formats.

● **SMF (Standard MIDI file)**

This is the most common sequence format. Standard MIDI Files are generally available as one of two types: Format 0 or Format 1. Many MIDI devices are compatible with Format 0, and most commercially available software is recorded as Format 0.

- The PSR-OR700 is compatible with both Format 0 and Format 1.
- Song data recorded on the PSR-OR700 is automatically saved as SMF Format 0.

● **ESEQ**

This sequence format is compatible with many of Yamaha's MIDI devices, including the PSR-S900/S700 series instruments. This is a common format used with various Yamaha software.

- The PSR-OR700 is compatible with ESEQ.

● **XF**

The Yamaha XF format enhances the SMF (Standard MIDI File) format with greater functionality and open-ended expandability for the future. The PSR-OR700 is capable of displaying lyrics when an XF file containing lyric data is played. (SMF is the most common format used for MIDI sequence files. The PSR-OR700 is compatible with SMF Formats 0 and 1, and records "song" data using SMF Format 0.)

● **Style File**

The Style File Format (SFF) combines all of Yamaha's auto accompaniment know-how into a single unified format.

Voice Allocation Format

With MIDI, Voices are assigned to specific numbers, called “program numbers.” The numbering standard (order of voice allocation) is referred to as the “voice allocation format.”

Voices may not play back as expected unless the voice allocation format of the song data matches that of the compatible MIDI device used for playback. The PSR-OR700 is compatible with the following formats.

NOTE

Even if the devices and data used satisfy all the conditions above, the data may still not be completely compatible, depending on the specifications of the devices and particular data recording methods.

● **GM System Level 1**

This is one of the most common voice allocation formats.

Many MIDI devices are compatible with GM System Level 1, as is most commercially available software.

● **GM System Level 2**

“GM System Level 2” is a standard specification that enhances the original “GM System Level 1” and improves Song data compatibility. It provides for increased polyphony, greater voice selection, expanded voice parameters, and integrated effect processing.

● **XG**

XG is a major enhancement of the GM System Level 1 format, and was developed by Yamaha specifically to provide more Voices and variations, as well as greater expressive control over Voices and effects, and to ensure compatibility of data well into the future. Song data recorded on the PSR-S900/S700 using Voices in the XG category is XG-compatible.

● **DOC (Disk Orchestra Collection)**

This voice allocation format is compatible with many of Yamaha’s MIDI devices, including the PSR-OR700 series instruments.

● **GS**

GS was developed by the Roland Corporation. In the same way as Yamaha XG, GS is a major enhancement of the GM specifically to provide more Voices and Drum kits and their variations, as well as greater expressive control over Voices and effects.

MIDI Settings

In this section, you can make MIDI-related settings for the instrument. The PSR-OR700 gives you a set of ten pre-programmed templates that let you instantly and easily reconfigure the instrument to match your particular MIDI application or external device. Also, you can edit the pre-programmed templates and save up to ten of your original templates to the USER display. You can then save all these original templates as a single file to USB storage devices, in the MIDI SETUP selection display (called up by pressing [FUNCTION] → [I] UTILITY → TAB [◀][▶] SYSTEM RESET).

Basic Operation

- 1 Call up the operation (MIDI template selection) display.

Function → [I] MIDI

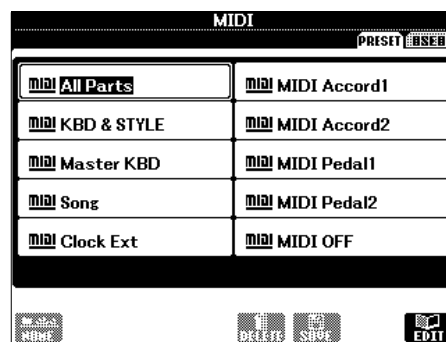

- 2 To use the pre-programmed templates or to edit them

Press the TAB [◀] button to select the PRESET display. Press one of the [A]-[J] buttons to select a MIDI template.

To use the templates already saved to the USER display or to edit them

Press the TAB [▶] button to select the USER display. Press one of the [A]-[J] buttons to select a MIDI template.

- 3 To edit a template, press the [8▼] (EDIT) button to call up the MIDI display for editing.

The individual parameters settings are shown for the selected template. Here you can edit each parameter.

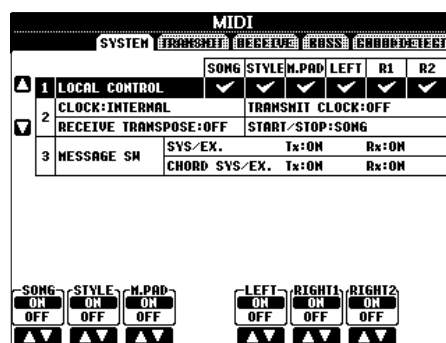

4 Use the TAB [◀][▶] buttons to call up the relevant setting display.

SYSTEM display	MIDI System Settings (page 180)
TRANSMIT display	MIDI Transmission Settings (page 180)
RECEIVE display	MIDI Reception Settings (page 181)
BASS display	Settings for the bass note of chord for Style playback via MIDI reception data (page 182)
CHORD DETECT display	Settings for the chord type for Style playback via MIDI reception data (page 182)

5 When you've finished editing, press the [EXIT] button to return to the MIDI template selection display (PRESET or USER).

6 Select the USER tab display to save the data by using the TAB [◀][▶] buttons (page 67).

Pre-Programmed MIDI Templates

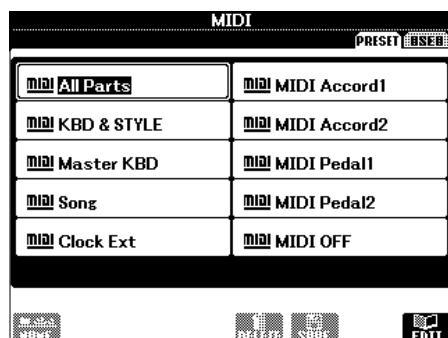

Template name	Description
All Parts	Transmits all parts including the keyboard parts (RIGHT 1, 2, and LEFT), with the exception of Song parts.
KBD & STYLE	Basically the same as “All Parts” with the exception of how keyboard parts are managed. The right-hand parts are handled as “UPPER” instead of RIGHT 1 and 2 and the left-hand part is handled as “LOWER.”
Master KBD	In this setting, the instrument functions as a “master” keyboard, playing and controlling one or more connected tone generators or other devices (such as a computer/sequencer).
Song	All transmit channels are set to correspond to Song channels 1–16. This is used to play Song data with an external tone generator and to record Song data to an external sequencer.
Clock Ext	Playback (Song or Style) synchronizes with an external MIDI clock instead of the instrument’s internal clock. This template should be used when you wish to set the tempo on the MIDI device connected to the instrument.
MIDI Accord 1	MIDI accordions allow you to transmit MIDI data and play connected tone generators from the keyboard and bass/chord buttons of the accordion. This template lets you play melodies from the keyboard and control Style playback on the instrument with the left-hand buttons.
MIDI Accord 2	Basically the same as “MIDI Accord 1” above, with the exception that the chord/bass notes you play with your left hand on the MIDI Accordion are recognized also as MIDI note events.
MIDI Pedal 1	MIDI pedal units allow you play connected tone generators with your feet (especially convenient for playing single note bass parts). This template lets you play/control the chord root in Style playback with a MIDI pedal unit.
MIDI Pedal 2	This template lets you play the bass part for Style playback by using a MIDI pedal unit.
MIDI OFF	No MIDI signals are sent or received.

SYSTEM display

MIDI System Settings

The explanations here apply to the SYSTEM display to be called up in step 4 of the “Basic Operation” on page 177.

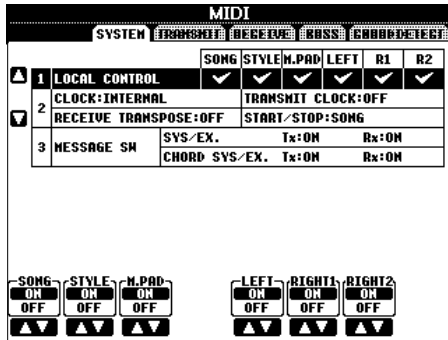

LOCAL CONTROL

Turns the Local Control for each part on or off. When Local Control is set to “ON,” the keyboard of the instrument controls its own (local) internal tone generator, allowing the internal voices to be played directly from the keyboard. If you set Local to “OFF,” the keyboard and controllers are internally disconnected from the instrument’s tone generator section so that no sound is output when you play the keyboard or use the controllers. For example, this allows you to use an external MIDI sequencer to play the instrument’s internal voices, and use the instrument keyboard to record notes to the external sequencer and/or play an external tone generator.

Clock setting, etc.

CLOCK

Determines whether the instrument is controlled by its own internal clock or a MIDI clock signal received from an external device. INTERNAL is the normal Clock setting when the instrument is being used alone or as a master keyboard to control external devices. If you are using the instrument with an external sequencer, MIDI computer, or other MIDI device, and you want to synchronize it to that device, set this parameter to the appropriate setting: MIDI, USB 1, or USB 2. In this case, make sure that the external device is connected properly (e.g., to the instrument’s MIDI IN terminal), and that it is properly transmitting a MIDI clock signal. When this is set for control by an external device (MIDI, USB 1 or USB 2), the Tempo is indicated as “Ext.” in the Main display.

TRANSMIT CLOCK

Turns MIDI clock (F8) transmission on or off. When set to OFF, no MIDI clock or Start/Stop data is transmitted even if a Song or Style is played back.

RECEIVE TRANPOSE

Determines whether or not the instrument’s transpose setting (page 58) is applied to the note events received by the instrument via MIDI.

START/STOP

Determines whether incoming FA (start) and FC (stop) messages affect Song or Style playback.

MESSAGE SW

SYS/EX.

The “Tx” setting turns MIDI transmission of MIDI System Exclusive messages on or off. The “Rx” setting turns MIDI reception and recognition of MIDI System Exclusive messages generated by external equipment on or off.

CHORD SYS/EX.

The “Tx” setting turns MIDI transmission of MIDI chord exclusive data (chord detect. root and type) on or off. The “Rx” setting turns MIDI reception and recognition of MIDI chord exclusive data generated by external equipment on or off.

TRANSMIT display

MIDI Transmit Settings

The explanations here apply to the TRANSMIT display to be called up in step 4 of the “Basic Operation” on page 177. This determines which parts will be sent as MIDI data and over which MIDI channel the data will be sent.

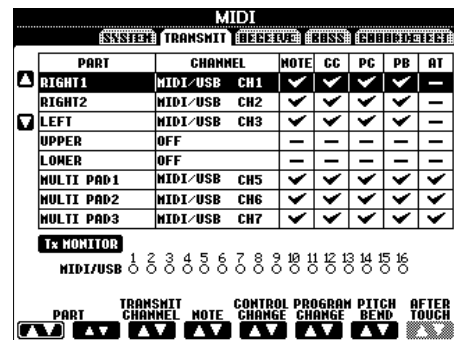

Operation

Select the part to be transmitted and the channel via which the selected part will be transmitted. You can also determine the types of data to be sent.

● With the exception of the next two parts, the configuration of the parts is the same as those already explained elsewhere in this manual.

UPPER

The keyboard part played on the right side of the keyboard from the Split Point for the Voices (RIGHT1 and/or 2).

LOWER

The keyboard part played on the left side of the keyboard from the Split Point for the Voices. This is not affected by the on/off status of the [ACMP] button.

● **Tx MONITOR**

The dots corresponding to each channel (1-16) flash briefly whenever any data is transmitted on the channel(s).

NOTE

When different parts are assigned to the same transmit channel

If the same transmit channel is assigned to several different parts, the transmitted MIDI messages are merged to a single channel — resulting in unexpected sounds and possible glitches in the connected MIDI device.

NOTE

About the protected Songs

Write-protected Songs cannot be transmitted even if the proper Song channels 1–16 are set to be transmitted.

■ **MIDI messages which can be transmitted or received (recognized)**

The following MIDI messages can be set on the TRANSMIT/RECEIVE display.

- Note (Note events).....page 164
- CC (CONTROL CHANGE)page 164
- PC (PROGRAM CHANGE).....page 164
- PB (Pitch Bend).....page 164
- AT (Aftersustain).....page 164

RECEIVE display

MIDI Receive Settings

MIDI						
CHANNEL	PART	NOTE	CC	PC	PB	AT
MIDI/USB 1 CH1	SONG	✓	✓	✓	✓	✓
MIDI/USB 1 CH2	SONG	✓	✓	✓	✓	✓
MIDI/USB 1 CH3	SONG	✓	✓	✓	✓	✓
MIDI/USB 1 CH4	SONG	✓	✓	✓	✓	✓
MIDI/USB 1 CH5	SONG	✓	✓	✓	✓	✓
MIDI/USB 1 CH6	SONG	✓	✓	✓	✓	✓
MIDI/USB 1 CH7	SONG	✓	✓	✓	✓	✓
MIDI/USB 1 CH8	SONG	✓	✓	✓	✓	✓

Rx MONITOR		1	2	3	4	5	6	7	8	9	10	11	12	13	14	15	16
MIDI/USB1	○	○	○	○	○	○	○	○	○	○	○	○	○	○	○	○	○
USB2	○	○	○	○	○	○	○	○	○	○	○	○	○	○	○	○	○

CHANNEL	PART	NOTE	CONTROL CHANGE	PROGRAM CHANGE	PITCH BEND	AFTER TOUCH
▲	▲	▲	▲	▲	▲	▲

The explanations here apply to the RECEIVE display to be called up in step 4 of the “Basic Operation” on page 177. This determines which parts will receive MIDI data and over which MIDI channels the data will be received.

Operation

Select the channel to be received and the part via which the selected channel will be received. You can also determine the types of data to be received.

- The PSR-OR700 can receive MIDI messages over 32 channels (16 channels x 2 ports) by USB connection.
- With the exception of the next two parts, the configuration of the parts is the same as those already explained elsewhere in this manual.

● **KEYBOARD**

The received note messages control the instrument’s keyboard performance.

● **EXTRA PART 1-5**

There are five parts specially reserved for receiving and playing MIDI data. Normally, these parts are not used by the instrument itself. The PSR-OR700 can be used as a 32-channel multi-timbral tone generator by using these five parts in addition to the general parts.

● **Rx MONITOR**

The dots corresponding to each channel (1–16) flash briefly whenever any data is received on the channel(s).

NOTE

Parameter Lock

You can “lock” specific parameters (e.g., effect, split point, etc.) to make them selectable only via the panel controls (page 133).

■ **MIDI transmission/reception via the USB terminal and MIDI terminals**

The relationship between the [MIDI] terminals and the [USB] terminal which can be used for transmitting/receiving 32 channels (16 channels x 2 ports) of the MIDI messages is as follows:

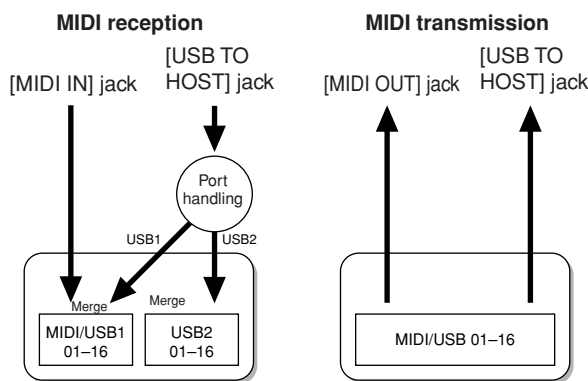

BASS display

Setting the Bass Note for Style Playback via MIDI Receive

The explanations here apply to the BASS display to be called up in step 4 of the “Basic Operation” on page 177.

These settings let you determine the bass note for Style playback, based on the note messages received via MIDI. The note on/off messages received at the channel(s) set to “ON” are recognized as the bass note of the chord of Style playback. The bass note will be detected regardless of the [ACMP] or split point settings. When several channels are simultaneously set to “ON,” the bass note is detected from merged MIDI data received over the channels.

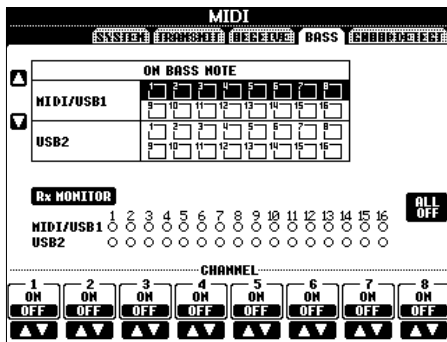

Operation

Select the channel and set the “ON/OFF” for that channel. Use the All OFF item to set all channels to OFF.

CHORD DETECT display

Setting the Chord Type for Style Playback via MIDI Receive

The explanations here apply to the CHORD DETECT display to be called up in step 4 of the “Basic Operation” on page 177.

These settings let you determine the chord type for Style playback, based on the note messages received via MIDI. The note on/off messages received at the channel(s) set to “ON” are recognized as the notes for detecting chords in Style playback. The chords to be detected depend on the fingering type. The chord type will be detected regardless of the [ACMP] or split point settings. When several channels are simultaneously set to “ON,” the chord type is detected from merged MIDI data received over the channels.

The operation procedure is basically the same as that of the BASS display.

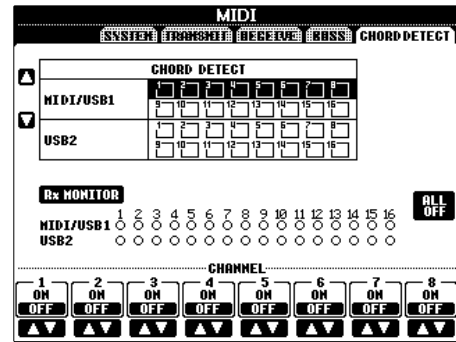

Displaying the Voice Program Change Number

Determines whether or not the Voice bank and number are shown in the Voice selection display. This is useful when you want to check which bank select MSB/LSB values and program change number you need to specify when selecting the Voice from an external MIDI device.

You can set this in the display called up by the following operations: [FUNCTION] → [J] UTILITY → TAB [◀][▶] CONFIG 2. Switch the DISPLAY VOICE NUMBER menu ON and OFF.

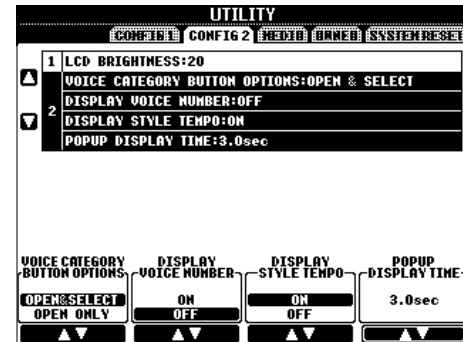

NOTE

- The numbers displayed here start from “1.” Accordingly the actual MIDI program change numbers are one lower, since that number system starts from “0.”
- For the GS Voices, this feature is not available (the program change numbers are not shown).

Overall

The instrument does not turn on.

- Securely insert the female plug into the socket on the instrument, and the male plug into a proper AC outlet.

A click or pop is heard when the power is turned on or off.

- Electrical current is being applied to the instrument. This is normal.

Noise is heard from the instrument's speakers.

- Noise may be heard if a mobile phone is used near the instrument or if the phone is ringing. Turn off the mobile phone, or use it further away from the instrument.

The letters in the display cannot be read, because the display is too bright (or dark).

- Use the [LCD CONTRAST] knob to adjust for optimum visibility.
- Adjust the brightness of the display (page 20).

The overall volume is too low, or, no sound is heard.

- The master volume may be set too low. Set it to an appropriate level with the [MASTER VOLUME] dial.
- All keyboard parts are set to off. Use the PART ON/OFF [RIGHT 1]/[RIGHT 2]/[LEFT] button to turn it on.
- The volume of the individual parts may be set too low. Raise the volume in the BALANCE display (page 41).
- Make sure the desired channel is set to ON (page 105).
- Headphones are connected, disabling the speaker output. Unplug the headphones.
- The [FADE IN/OUT] button is on, muting the sound. Press the [FADE IN/OUT] button to turn the function off.
- Make sure the Local Control function is set to ON (page 180).

Not all simultaneously played notes sound.

- You are probably exceeding the maximum polyphony (page 187) of the instrument. When the maximum polyphony is exceeded, the earliest played notes will stop sounding, letting the latest played notes sound.

The keyboard volume is lower than the Song/Style playback volume.

- The volume of the keyboard parts may be set too low. Raise the volume in the BALANCE display (page 41).

Keys do not sound at the proper pitch.

- Make sure the Performance Assistant function is off on the operation display (page 44).

Certain notes sound at the wrong pitch.

The Scale parameter has probably been set to something other than "Equal," changing the tuning system of the keyboard. Make sure "Equal" is selected as the Scale in the Scale Tune display (page 99).

– There is a slight difference in sound quality among different notes played on the keyboard.

– Some Voices have a looping sound.

– Some noise or vibrato is noticeable at higher pitches, depending upon the voice.

- This is normal and is a result of the instrument's sampling system.

Some Voices will jump an octave in pitch when played in the upper or lower registers.

- This is normal. Some voices have a pitch limit which, when reached, causes this type of pitch shift.

The Main display does not appear even when turning the power on.

- This may occur if a USB storage device has been installed to the instrument. Installation of some USB storage device may result a long interval between turning the power on and appearance of the Main display. To avoid this, turn the power on after disconnecting the device.

Files/Folders

Some characters of the file/folder name are garbled.

- The language settings have been changed. Set the appropriate language for the file/folder name (page 19).

An existing file is not shown.

- The file extension (.MID, etc.) may have been changed or deleted. Manually rename the file, adding the appropriate extension, on a computer.

The data contained in the USB storage device is not shown on the instrument itself.

- Data files with names of more than 50 characters cannot be handled by the instrument. Rename the file, reducing the number of characters to 50 or less.

Demo

How can I stop the demo?

- Press the [EXIT] button.

Voice

The Voice selected from the Voice Selection display does not sound.

- Check whether or not the selected part is turned on (page 78).
- To select the Voice for the right-hand key range, press the PART SELECT [RIGHT 1] button. For the Voice to be layered in the right-hand range, press the PART SELECT [RIGHT 2] button. To select the Voice for the left-hand key range, press the PART SELECT [LEFT] button.

The sound seems strange or different than expected when changing a rhythm Voice (drum kit, etc.) of the Style or Song from the Mixer.

- When changing the rhythm/percussion Voices (drum kits, etc.) of the Style and Song from the VOICE parameter, the detailed settings related to the drum voice are reset, and in some cases you may be unable to restore the original sound. In the case of Song playback, you can restore the original sound by returning to the beginning of the Song and playing back from that point. In the case of Style play, you can restore the original sound by selecting the same Style again.

Tremolo/Trill cannot be applied to the Organ Flute Voice.

- This is normal; Tremolo and Trill settings in the Harmony/Echo display are not effective for Organ Flute Voices.

The Harmony function does not operate.

- Harmony cannot be used with the Full Keyboard or AI Full Keyboard fingering modes. Select an appropriate fingering mode (page 104).

When a Voice is changed, the previously selected effect is changed.

- Each Voice has its own suitable preset settings, which are automatically recalled when the corresponding Voice Set parameters are turned on (page 98).

The Voice produces excessive noise.

- Certain Voices may produce noise, depending on the Harmonic Content and/or Brightness settings in the FILTER page of the Mixing Console display (page 86).

The sound is distorted or noisy.

- The volume may be turned up too high. Make sure all relevant volume settings are appropriate.
- This may be caused by certain effects. Try canceling all unnecessary effects, especially distortion-type effects (page 88).
- Adjust the sound using the [8 ▲ ▼] (TOTAL GAIN ADJ.) buttons from the display shown in step 6 of "Editing and Saving the selected EQ" (page 91), if you are using the Master EQ.
- Some filter resonance settings in the VOICE SET display (page 94) can result in distorted sound. Adjust these settings if necessary.
- Noise may occur depending on the settings made in the Filter display of the Mixing Console. Adjust the Harmonic Content or Brightness controls in the Filter display (page 86).

The sound does not change when replacing Voices with the Song Auto Revoice feature.

- Depending on the particular Song data, there are some instances where Song Auto Revoice has no effect, even when replacing Voices.

The sound of the Voice doesn't change, even when editing the Voice.

- Keep in mind that adjustments made to the parameters may not make much change in the actual sound depending on the original settings of the Voice.

Voices other than those in the Preset display cannot be selected for Step recording.

- This is normal.

Style

Style playback does not start.

- Make sure to press the STYLE CONTROL [START/STOP] button.
- MIDI Clock may be set to "EXTERNAL." Make sure this is set to "INTERNAL" (page 180).

Only the rhythm channel plays.

- Make sure the Auto Accompaniment function is turned on; press the [ACMP] button.
- You may be playing keys in the right hand range of the keyboard. Make sure to play keys in the chord range of the keyboard.

Styles cannot be selected.

- If the size of the Style data is large (about 120 KB or greater), the Style cannot be selected because the data is too large to be ready by the instrument.

The desired chord is not recognized or output by the auto accompaniment.

- You may not be playing the correct keys for indicating the chord. Refer to "Chord Types Recognized in the Fingering Mode" of the Data List. The Data List is available at the Yamaha website. (See page 5.)
- You may be playing the keys according to a different fingering mode, and not the one currently selected. Check the accompaniment mode, and play the keys according to the selected mode (page 104).

Syncro Stop cannot be turned on.

- Syncro Stop cannot be turned on when the fingering mode is set to "Full Keyboard" or "AI Full Keyboard," or when the [ACMP] button is set to off. Make sure the fingering mode is set to something besides "Full Keyboard" or "AI Full Keyboard" and set the [ACMP] button to on.

Auto accompaniment chords are recognized regardless of the split point or where chords are played on the keyboard.

- This is normal if the fingering mode is set to "Full Keyboard" or "AI Full Keyboard." If either of these is selected, chords are recognized over the entire range of the keyboard, irrespective of the split point setting. If desired, select a different fingering mode (page 104).

When playing back one Style and selecting another, the newly selected Style doesn't play at the proper Tempo.

- You can select whether the appropriate tempo will be called up automatically or not by using the TEMPO parameter in the STYLE CHANGE BEHAVIOR function.

Starting a Song while playing back a Style stops Style playback.

This is because Song playback has priority. The two ways shown below let you play back a Style and Song simultaneously.

- Set the Song to Synchro Start standby, then start the Style.
- Start the Style playback after playing back a Song.

The level balance of the various Parts becomes wrong or unexpected sounds are output when selecting a Style or a Voice after selecting a Song.

- The level balance of the Parts can change and unexpected sounds can be produced because of the effects applied to each Part.

The "Off" setting is not shown for the Play Type parameter in the Assembly (Style Creator) feature.

- The selected section is set to record enable. Release the recording assignment by pressing the appropriate [1 ▼]-[8 ▼] button in the recording channel display (TAB [◀] button → BASIC tab → [F] REC CH).

The channels BASS-PHR2 cannot be edited in Channel Edit.

- This is normal; BASS-PHR2 channels of the Preset Styles cannot be edited.

Registration memory

The Song/Style registered to the Registration Memory cannot be called up.

- If the registered Song/Style is contained on USB storage device and the USB storage device is not connected to the instrument, the Song/Style cannot be called up. Connect the appropriate USB storage device containing the Song/Style data.

The order for calling up Registration Memory settings is not shown on the Registration Sequence setting display.

- The bank containing the Registration has not been selected. Select the appropriate bank (page 132).

When using the Freeze function of the Registration Memory, the On/Off setting of the Left Part does not change even when changing the Registration Memory setting.

- The Left Part On/Off setting is included in the Style group. Remove the checkmark from "STYLE" in the Freeze setting display (page 134).

Even though a Registration Memory setting containing a User/USB voice is selected, the File Selection display shows a Preset Voice.

- This is normal; even with the Preset Voice shown, the actual sounding Voice is the selected User/USB Voice. When a User/USB Voice is saved to the User/USB drive, the actual data is divided into two separate types: 1) the source Preset Voice itself, and 2) the parameter settings as set in the Voice Set. When you recall a Registration Memory setting containing a User/USB Voice, the instrument selects the Preset voice (on which the User/USB Voice is based), then applies the relevant parameter settings to it — so that your original User/USB Voice is sounded.

Song

Songs cannot be selected.

- This may be because the language settings have been changed. Set the appropriate language for the Song file name.
- If the size of the Song data is large (about 300 KB or greater), the Song cannot be selected because the data is too large to be read by the instrument.

Song playback does not start.

- "New Song" (a blank Song) has been selected. Make sure to select an appropriate Song in the Song Selection display (page 36).
- Make sure to press the SONG [▶ / ■■] (PLAY/PAUSE) button.
- The Song has been stopped at the end of the Song data. Return to the beginning of the Song by pressing the SONG [■] (STOP) button.
- In the case a Song to which write-protect has been applied ("Prot. 2 Edit" is shown at the upper left of the Song name), the original file may not be in the same folder. It cannot be played back unless the original file (showing "Prot.2 Orig" at the upper left of the Song name) is in the same folder.
- In case of a Song to which write-protect has been applied ("Prot. 2 Edit" is shown at the upper left of the Song name), the original file name may have been changed. Rename the file with the original file name (so that "Prot.2 Orig" is shown at the upper left of the Song name).
- In case of a Song to which write-protect has been applied ("Prot. 2 Edit" is shown at the upper left of the Song name), the file icon may have been changed. Songs to which write-protect has been applied cannot be played back when the file icon of the original has been changed.
- MIDI Clock may be set to "EXTERNAL." Make sure this is set to "INTERNAL" (page 180).

Song playback stops before the Song is finished.

- The Guide function is turned on. (In this case, playback is "waiting" for the correct key to be played.) Press the [GUIDE] button to turn off the guide function.

The Song last selected before turning off the power is no longer available.

- If the Song last selected before turning off the power is contained in a USB storage device, you'll need to reconnect the same USB storage device to call up the Song again.

The measure number is different from that of the score in the Song Position display, shown by pressing the [◀◀]/[▶▶] (REW/FF) buttons.

- This happens when playing back music data for which a specific, fixed tempo is set.

In the AB Repeat function, the B point cannot be set.

- The A point has not been set. Set the B point only after setting the A point.

When playing back a Song, some channels do not play.

- Playback of these channels may be set to "OFF." Turn playback on for those channels that are set to "OFF" (page 142).

A Song to which write-protect has been applied ("Prot. 2 Edit" is shown at the upper left of the Song name) cannot be moved to an external media such as a SmartMedia card or floppy disk.

- A Song to which write-protect has been applied cannot be moved to an external media such as SmartMedia/floppy disk, etc. Use the [USB TO DEVICE] terminal to move the song to a USB flash memory device connected to this instrument.

Guide

The melody still plays back, even when specifying Track 1 as the part to be muted for one-handed practice.

- A part other than the melody part has been assigned to Track 1. Reassign the channel containing the melody to Track 1 (page 141).

Score

When displaying the music score, long notes that have been entered, such as whole notes and ties, are not displayed correctly.

- Long notes, such as whole notes and ties, may not be shown in the music score display exactly as they were entered. Selecting "Tenuto" by pressing the [H] button before inputting each note in the Step Record display (page 149) may solve the problem.

The tempo, beat, measure and music notation is not displayed correctly.

- Some Song data for the instrument has been recorded with special "free tempo" settings. For such Song data, the tempo, beat, measure and music notation will not be displayed correctly.

The note name partially obscures the note in the display.

- When several notes occur close to each other, the note name may obscure the note at left.

The music score of the right-hand/left-hand part is not displayed.

- The appropriate channels have not been assigned to the right-hand and left-hand parts. Set the Track 1 and Track 2 channels to "AUTO" (page 141).

The notation in the display is cut off, with the middle of a measure starting on the next line.

- When all the notes of a measure cannot fit on one line, the remaining notes in the measure are carried over to the next line.

Dotted notes are indicated as rests.

- This is normal; sometimes dotted notes are indicated as rests.

Chords are not displayed.

- If the selected Song does not contain chord data, chords are not displayed.

Lyrics (Karaoke)

Lyrics are not displayed.

- If the selected Song does not contain lyric data, lyrics are not displayed.

Some of the lyrics overlap each other.

- This happens for Songs containing many lyrics.

Performance assistant technology

Performance assistant technology does not work appropriately.

- Press the SONG [■] (STOP) button to stop Song playback, then set the [ACMP] and PART ON/OFF [LEFT] to off. Finally, restart the Song.

Specifications

		PSR-OR700	
Sound Source		AWM Stereo Sampling	
Keyboard		61 keys (C1–C6 with Initial Touch)	
Display		320 x 240 dots QVGA B/W LCD	
Voice	Music Score, Lyrics	YES	
	Polyphony (max)	96	
	Voice Selection	360 voices + 480 XG voices 22 Drum/SFX Kits + GM2 + GS voices for GS Song playback	
	MegaVoice	10	
	Live! Voice	14	
	Cool! Voice	18	
	Sweet! Voice	11	
	Organ Flutes! Voice	10	
Regular Voice	297		
Voice Editing (Voice Set)		YES	
Effects	Effect Blocks	Reverb/Chorus/DSP	
	Effect Types	Reverb/Chorus/DSP	
		Master EQ	5 Preset + 2 User
		Part EQ	28 Parts
Accompaniment Style	Accompaniment Styles	314	
	Pro Styles	302	
	Session Styles	12	
	MegaVoice/Style	YES	
	Fingering	Single Finger, Fingered, Fingered On Bass, Multi Finger, AI Fingered, Full Keyboard, AI Full Keyboard	
	Style Creator	YES	
	OTS (One Touch Setting)	4 for each Style	
	OTS Link	YES	
	Music Finder	Preset	YES
		Edit	YES
	RAM Capacity	120 KB	
Song	Preset Songs	5 samples	
	Guide	Follow Lights, Any Key, Karao-Key	
	Performance assistant technology	YES	
	Recording	Quick Recording, Multi Recording, Step Recording, Song Editing	
		Record Channels	16
	RAM Capacity	300 KB	
Multi Pad	Preset	4 Pads × 80 Banks	
Memory Device	USB Flash Memory	YES	
	Floppy Disk (2HD, 2DD)	External Adaptor (via USB TO DEVICE)	
	Hard Disk	External Adaptor (via USB TO DEVICE)	
	Flash Memory (Internal)	560 KB	
	Memory Card (SmartMedia, etc.)	External Adaptor (via USB TO DEVICE)	
Tempo	Tempo Range	5 - 500, Tap Tempo	
	Metronome	Yes	
		Sound	Bell on/off
Registration Memory	Buttons	8	
	Regist. Sequence / Freeze	YES	

		PSR-OR700
Others	Demo	YES
	Language for Display	5 Languages (English, German, French, Spanish, Italian)
	Direct Access	YES
	Transpose	Keyboard/Song/Master
	Scale Type	9
Computer Connection	USB to HOST	YES
	USB to DEVICE	YES
Other Connectors		PHONES, MIDI (IN, OUT), FOOT PEDAL (1, 2), AUX IN (R, L/L+R), OUTPUT (R, L/L+R), LAN
Pedal Functions		VOLUME, SUSTAIN, SOSTENUTO, SOFT, GLIDE, PORTAMENTO, PITCHBEND, MODULATION, DSP VARIATION, SONG PLAY/PAUSE, STYLE START/STOP, etc.
Amplifiers/ Speakers	Amplifiers	12 W × 2
	Speakers	(12 cm + 5 cm) × 2
Power Consumption		35 W
Dimensions [W × D × H]		1003 mm × 433 mm × 148 mm (39 5/8" × 17 1/8" × 5 7/8")
Weight		11.5 kg (25 lbs., 5 5/8 oz)
Optional accessories	Headphones	HPE-150/HPE-30
	Footswitch	FC4/FC5
	Foot Controller	FC7
	Floppy Disk Drive	UD-FD01
	AC Power Adaptor	PA-300B/PA-300
	Keyboard stand	L-6/L-7 (The exterior size of the PSR-OR700 is beyond the limits as described in the L-6 Assembly Instructions. However, we have determined through tests that the stand can be safely used for the instrument.)

* Specifications and descriptions in this owner's manual are for information purposes only. Yamaha Corp. reserves the right to change or modify products or specifications at any time without prior notice. Since specifications, equipment or options may not be the same in every locale, please check with your Yamaha dealer.

Numerics

1-16 148, 158

A

A-B Repeat 42
 AI 104
 AI FINGERED 104
 AI FULL KEYBOARD 104
 Any key 142
 ASSEMBLY 119
 Auto Accompaniment Feature 46
 AUTO REVOICE SETUP 87

B

BALANCE 41
 BASIC 115
 BASS 182
 BAYAT 100
 Brightness 20

C

Chain Playback 138
 CHANNEL 123, 158
 CHANNEL ON/OFF 105
 Characters 71
 CHORD 148, 158
 CHORD DETECT 182
 CHORD FINGERING 103
 Chord Tutor function 50
 COMMON 93
 CONFIG 1 35, 48, 105
 CONFIG 2 20, 182
 Contrast 19
 CONTROLLER 93
 Cool! 77
 COPY 68
 CUT 69

D

Data List 5
 DELETE 69
 Demo 24
 Demo (Voice) 32
 [DEMO] button 12
 [DIGITAL RECORDING] button 12
 Direct Access 61
 DOC (Disk Orchestra Collection) 177
 Drums 77

E

EDIT 118
 Edit (Effect) 89
 Edit (EQ) 91
 Edit (Lyrics) 158
 Edit (Music Finder) 111
 Edit (OTS) 51
 Edit (Song) 158
 Edit (Style) 120
 Edit (Voice) 92
 EFFECT 86

Effect Return Level 89
 Effect Type 88
 EFFECT/EQ 95
 Entering characters 71
 EQ (Equalizer) 86
 EQUAL TEMPERAMENT 100
 ESEQ 176
 EXIT 65

F

Factory Reset 72
 Factory-programmed Settings 72
 FADE IN/OUT (Song) 137
 FADE IN/OUT (Style) 48
 Fade In/Out time 137
 FADE IN/OUT/HOLD TIME 105
 Fast forward 138
 Favorite 110
 File 64
 File Selection Display 27, 66
 File Selection Display Basic Operation 65
 File Selection Display Configuration 64
 File/Folder Operations 66
 FILTER 86, 165
 FINGERED 104
 FINGERED ON BASS 104
 Flash Memory 23
 Folder 64
 Follow lights 142
 FOOT PEDAL 168
 FOOTAGE 96, 97
 Format 66
 FREEZE 134
 FULL KEYBOARD 104
 Function display 28

G

GM System Level 1 177
 GM System Level 2 177
 GROOVE 121
 GS 177
 Guide 40, 141

H

HARMONY 95
 HARMONY/ECHO 82
 Headphones 18
 Hz 81

I

ICON 70

K

Karaoke 57
 Karao-key 142
 Keyboard Parts 78
 KEYBOARD/PANEL 33, 58
 KIRNBERGER 100

L

Language	19
LCD	12
Left	78
Left Hold	50
Live!	77
Lyrics	57, 166

M

Main Display	26, 62
MASTER TUNE	81
[MASTER VOLUME] dial	17
MEAN-TONE	100
MEDIA	66, 140, 172
MegaVoice	77
MELODIC MINOR	126
Messages	60
Metronome	34
MIDI	174
MIDI recording	43, 143
MIDI Settings	177
MIDI Templates	179
MIXING CONSOLE	84
Modulation Wheel	34
MULTI FINGER	104
Multi Pad Creator	128
Multi Pads	13
Multi track recording	143
Music Finder	55
Music Rest	18

N

NAME	70
Notation	39

O

One Touch Setting	51
One-Handed Practice	40
Organ Flutes	77, 96
OTS Link	51
Owner Name	21

P

PANEL PART	85
PARAMETER	124
Part	78
PASTE	68, 69
Pause	138
Pedal polarity	168
percussion sounds	32
performance assistant technology	44
Phrase Mark	138
Pitch	81
Pitch Bend Wheel	33
Portamento Time	93
Practice Function	141
PRESET	27
Pro	103
PROPERTY	172
Prot. 1	68

Prot. 2 Edit	68
Prot. 2 Orig	68
PURE MAJOR	100
PURE MINOR	100
PYTHAGOREAN	100

Q

QUANTIZE	123
Quick Recording	143
QUICK START	139

R

RANDOM	138
RAST	100
Realtime Recording	114
REC MODE	158
RECEIVE	181
Record	43
Record (Song)	143
Record (Style)	114
REGISTRATION MEMORY	131
REGISTRATION SEQUENCE	134
REPEAT MODE	37, 138
Repertoire	56
Revoice	87
Rewind	138
Right 1	78
Right 2	78

S

SAVE	67
Save (Music Finder)	112
SCALE TUNE	99
Score	39
Search (Music Finder Records)	108
Section Set	107
Session	103
Set the polarity of the pedal	168
SFX	77
SINGLE FINGER	104
SMF (Standard MIDI file)	176
Song	12, 36
SONG CH 1-8/9-16	85
Song channels	147
SOUND	94
Sound effects	32
[STANDBY/ON] switch	12, 17
Step Recording	114, 143
Stop ACMP	106
Style	12, 46
Style Assembly	114
Style Change Behavior	107
Style Creator	114
Style File Format (SFF)	176
STYLE PART	85, 147
STYLE SETTING/SPLIT POINT	106
Style Structure	114
Style Touch	106
Sweet!	77
Synchro Start (Song)	137
Synchro Start (Style)	48
Synchro Stop	49

Synchro Stop Window	106
SYS/EX.	158
SYSTEM	180

T

Tap function	137
TAP TEMPO	48
Tempo	34
Time Signature	35
Top	138
TOUCH	33, 53
TRANSMIT	180
Transpose	58, 81
TUNE	86

U

UP	65
USB Storage Device	23
[USB TO DEVICE] terminal	13
[USB TO HOST] terminal	13
USER	27

V

Vibrato	95
Voice	30, 77
VOICE buttons	13
Voice Program Change Number	182
VOICE SET	92
VOL/VOICE	85
Volume balance	41
VOLUME/ATTACK	97

W

WERCKMEISTER	100
--------------------	-----

X

XF	176
XG	177

Panel Button Chart

The position of the button on the panel can be confirmed by the Panel Controls (page 14).

Number

[1 ▲ ▼]–[8 ▲ ▼] 44

A

[A]–[J] 39

[ACMP] 30

[AUTO FILL IN] 29

B

[BALANCE] 40

[BREAK] 33

C

[CHANNEL ON/OFF] 42

D

DATA ENTRY dial 50

[DEMO] 9

[DIRECT ACCESS] 43

Drum Kit Icons 70

[DSP] 67

E

ENDING/rit. [I]/[II]/[III] 34

[ENTER] 51

[EXIT] 49

[EXTRA TR] 15

F

[FADE IN/OUT] 27

[FREEZE] 56

[FUNCTION] 46

G

[GUIDE] 14

H

[HARMONY/ECHO] 63

I

INTRO [I]/[II]/[III] 31

L

[LCD CONTRAST] 38

[LYRICS] 12

M

MAIN VARIATION [A]/[B]/[C]/[D] 32

[MASTER VOLUME] 2

[MEMORY] (SCALE MEMORY) 6

[MEMORY] (REGISTRATION MEMORY) 57

[METRONOME] 24

[MIXING CONSOLE] 41

[MODULATION] wheel 4

[MONO] 66

MULTI PAD CONTROL [1]–[4] 60

MULTI PAD CONTROL [SELECT] 59

MULTI PAD CONTROL [STOP] 61

[MUSIC FINDER] 52

O

ONE TOUCH SETTING [1]–[4] 62

[OTS LINK] 28

P

[PART SELCT], [PART ON/OFF] 53

[PITCH BEND] wheel 3

R

REGIST BANK [–]/[+] 55

REGISTRATION MEMORY [1]–[8] 58

[REPEAT] 13

S

SCALE MEMORY buttons 7

SCALE SETTING buttons 5

[SCALE TUNE] 48

[SCORE] 11

SONG [▶ / ■■] (PLAY/PAUSE) 20

SONG [◀◀]/[▶▶] (REW/FF) 21

SONG [■] (STOP) 19

SONG [REC] 18

SONG [SELECT] 10

[STANDBY/ON] 1

STYLE buttons 22

STYLE CONTROL [START/STOP] 37

[SUSTAIN] 65

[SYNC START] 36

[SYNC STOP] 35

T

TAB [◀][▶] 45

[TAP TEMPO] 25

TEMPO [–]/[+] 26

[TOUCH] 64

[TR 1] 17

[TR 2] 16

TRANSPOSE [–]/[+] 23

U

UPPER OCTAVE [–]/[+] 69

[USB] 47

V

[VARI.] 68

VOICE buttons 54

Limited Warranty

90 DAYS LABOR

1 YEAR PARTS

Yamaha Corporation of America, hereafter referred to as Yamaha, warrants to the original consumer of a product included in the categories listed below, that the product will be free of defects in materials and/or workmanship for the periods indicated. This warranty is applicable to all models included in the following series of products:

PSR SERIES OF PORTATONE ELECTRONIC KEYBOARDS

If during the first 90 days that immediately follows the purchase date, your new Yamaha product covered by this warranty is found to have a defect in material and/or workmanship, Yamaha and/or its authorized representative will repair such defect without charge for parts or labor.

If parts should be required after this 90 day period but within the one year period that immediately follows the purchase date, Yamaha will, subject to the terms of this warranty, supply these parts without charge. However, charges for labor, and/or any miscellaneous expenses incurred are the consumers responsibility. Yamaha reserves the right to utilize reconditioned parts in repairing these products and/or to use reconditioned units as warranty replacements.

THIS WARRANTY IS THE ONLY EXPRESS WARRANTY WHICH YAMAHA MAKES IN CONNECTION WITH THESE PRODUCTS. ANY IMPLIED WARRANTY APPLICABLE TO THE PRODUCT, INCLUDING THE WARRANTY OF MERCHANTABILITY ABILITY IS LIMITED TO THE DURATION OF THE EXPRESS WARRANTY. YAMAHA EXCLUDES AND SHALL NOT BE LIABLE IN ANY EVENT FOR INCIDENTAL OR CONSEQUENTIAL DAMAGES.

Some states do not allow limitations that relate to implied warranties and/or the exclusion of incidental or consequential damages. Therefore, these limitations and exclusions may not apply to you.

This warranty gives you specific legal rights. You may also have other rights which vary from state to state.

CONSUMERS RESPONSIBILITIES

If warranty service should be required, it is necessary that the consumer assume certain responsibilities:

1. Contact the Customer Service Department of the retailer selling the product, or any retail outlet authorized by Yamaha to sell the product for assistance. You may also contact Yamaha directly at the address provided below.
2. Deliver the unit to be serviced under warranty to: the retailer selling the product, an authorized service center, or to Yamaha with an explanation of the problem. Please be prepared to provide proof purchase date (sales receipt, credit card copy, etc.) when requesting service and/or parts under warranty.
3. Shipping and/or insurance costs are the consumers responsibility.* Units shipped for service should be packed securely.

*Repaired units will be returned PREPAID if warranty service is required within the first 90 days.

IMPORTANT: Do NOT ship anything to ANY location without prior authorization. A Return Authorization (RA) will be issued that has a tracking number assigned that will expedite the servicing of your unit and provide a tracking system if needed.

4. Your owners manual contains important safety and operating instructions. It is your responsibility to be aware of the contents of this manual and to follow all safety precautions.

EXCLUSIONS

This warranty does not apply to units whose trade name, trademark, and/or ID numbers have been altered, defaced, exchanged removed, or to failures and/or damages that may occur as a result of:

1. Neglect, abuse, abnormal strain, modification or exposure to extremes in temperature or humidity.
2. Improper repair or maintenance by any person who is not a service representative of a retail outlet authorized by Yamaha to sell the product, an authorized service center, or an authorized service representative of Yamaha.
3. This warranty is applicable only to units sold by retailers authorized by Yamaha to sell these products in the U.S.A., the District of Columbia, and Puerto Rico. This warranty is not applicable in other possessions or territories of the U.S.A. or in any other country.

Please record the model and serial number of the product you have purchased in the spaces provided below.

Model _____ Serial # _____ Sales Slip # _____

Purchased from _____ Date _____
(Retailer)

YAMAHA CORPORATION OF AMERICA
Electronic Service Division
6600 Orangethorpe Avenue
Buena Park, CA 90620

KEEP THIS DOCUMENT FOR YOUR RECORDS. DO NOT MAIL!

FCC INFORMATION (U.S.A.)

1. IMPORTANT NOTICE: DO NOT MODIFY THIS UNIT!

This product, when installed as indicated in the instructions contained in this manual, meets FCC requirements. Modifications not expressly approved by Yamaha may void your authority, granted by the FCC, to use the product.

2. **IMPORTANT:** When connecting this product to accessories and/or another product use only high quality shielded cables. Cable/s supplied with this product MUST be used. Follow all installation instructions. Failure to follow instructions could void your FCC authorization to use this product in the USA.
3. **NOTE:** This product has been tested and found to comply with the requirements listed in FCC Regulations, Part 15 for Class "B" digital devices. Compliance with these requirements provides a reasonable level of assurance that your use of this product in a residential environment will not result in harmful interference with other electronic devices. This equipment generates/uses radio frequencies and, if not installed and used according to the instructions found in the users manual, may cause interference harmful to the operation of

other electronic devices. Compliance with FCC regulations does not guarantee that interference will not occur in all installations. If this product is found to be the source of interference, which can be determined by turning the unit "OFF" and "ON", please try to eliminate the problem by using one of the following measures:

Relocate either this product or the device that is being affected by the interference.

Utilize power outlets that are on different branch (circuit breaker or fuse) circuits or install AC line filter/s.

In the case of radio or TV interference, relocate/reorient the antenna. If the antenna lead-in is 300 ohm ribbon lead, change the lead-in to co-axial type cable.

If these corrective measures do not produce satisfactory results, please contact the local retailer authorized to distribute this type of product. If you can not locate the appropriate retailer, please contact Yamaha Corporation of America, Electronic Service Division, 6600 Orangethorpe Ave, Buena Park, CA90620

The above statements apply ONLY to those products distributed by Yamaha Corporation of America or its subsidiaries.

* This applies only to products distributed by YAMAHA CORPORATION OF AMERICA.

(class B)

OBSERVERA!

Apparaten kopplas inte ur växelströmskällan (nätet) så länge som den är ansluten till vägguttaget, även om själva apparaten har stängts av.

ADVARSEL: Netspændingen til dette apparat er IKKE afbrudt, så længe netledningen sidder i en stikkontakt, som er tændt — også selvom der er slukket på apparatets afbryder.

VAROITUS: Laitteen toisiopiiriin kytketty käyttökytkin ei irroita koko laitetta verkosta.

(standby)

This product contains a high intensity lamp that contains a small amount of mercury. Disposal of this material may be regulated due to environmental considerations.

For disposal information in the United States, refer to the Electronic Industries Alliance web site: www.eiae.org

* This applies only to products distributed by YAMAHA CORPORATION OF AMERICA.

(mercury)

COMPLIANCE INFORMATION STATEMENT (DECLARATION OF CONFORMITY PROCEDURE)

Responsible Party : Yamaha Corporation of America
Address : 6600 Orangethorpe Ave., Buena Park,
Calif. 90620
Telephone : 714-522-9011
Type of Equipment : Electronic Keyboard
Model Name : PSR-OR700

This device complies with Part 15 of the FCC Rules.

Operation is subject to the following two conditions:

- 1) this device may not cause harmful interference, and
- 2) this device must accept any interference received including interference that may cause undesired operation.

See user manual instructions if interference to radio reception is suspected.

* This applies only to products distributed by YAMAHA CORPORATION OF AMERICA.

(FCC DoC)

IMPORTANT NOTICE FOR THE UNITED KINGDOM Connecting the Plug and Cord

IMPORTANT. The wires in this mains lead are coloured in accordance with the following code:

BLUE : NEUTRAL
BROWN : LIVE

As the colours of the wires in the mains lead of this apparatus may not correspond with the coloured markings identifying the terminals in your plug proceed as follows:

The wire which is coloured BLUE must be connected to the terminal which is marked with the letter N or coloured BLACK.

The wire which is coloured BROWN must be connected to the terminal which is marked with the letter L or coloured RED.

Making sure that neither core is connected to the earth terminal of the three pin plug.

* This applies only to products distributed by Yamaha-Kemble Music (U.K.) Ltd.

(2 wires)

For details of products, please contact your nearest Yamaha representative or the authorized distributor listed below.

Pour plus de détails sur les produits, veuillez-vous adresser à Yamaha ou au distributeur le plus proche de vous figurant dans la liste suivante.

Die Einzelheiten zu Produkten sind bei Ihrer unten aufgeführten Niederlassung und bei Yamaha Vertragshändlern in den jeweiligen Bestimmungsländern erhältlich.

Para detalles sobre productos, contacte su tienda Yamaha más cercana o el distribuidor autorizado que se lista debajo.

NORTH AMERICA

CANADA

Yamaha Canada Music Ltd.
135 Milner Avenue, Scarborough, Ontario,
M1S 3R1, Canada
Tel: 416-298-1311

U.S.A.

Yamaha Corporation of America
6600 Orangethorpe Ave., Buena Park, Calif. 90620,
U.S.A.
Tel: 714-522-9011

CENTRAL & SOUTH AMERICA

MEXICO

Yamaha de México S.A. de C.V.
Calz. Javier Rojo Gómez #1149,
Col. Guadalupe del Moral
C.P. 09300, México, D.F., México
Tel: 55-5804-0600

BRAZIL

Yamaha Musical do Brasil Ltda.
Rua Joaquim Floriano, 913 - 4º andar, Itaim Bibi,
CEP 04534-013 Sao Paulo, SP. BRAZIL
Tel: 011-3704-1377

ARGENTINA

Yamaha Music Latin America, S.A.
Sucursal de Argentina
Viamonte 1145 Piso 2-B 1053,
Buenos Aires, Argentina
Tel: 1-4371-7021

PANAMA AND OTHER LATIN AMERICAN COUNTRIES/ CARIBBEAN COUNTRIES

Yamaha Music Latin America, S.A.
Torre Banco General, Piso 7, Urbanización Marbella,
Calle 47 y Aquilino de la Guardia,
Ciudad de Panamá, Panamá
Tel: +507-269-5311

EUROPE

THE UNITED KINGDOM

Yamaha-Kemble Music (U.K.) Ltd.
Sherbourne Drive, Tilbrook, Milton Keynes,
MK7 8BL, England
Tel: 01908-366700

IRELAND

Danfay Ltd.
61D, Sallynoggin Road, Dun Laoghaire, Co. Dublin
Tel: 01-2859177

GERMANY

Yamaha Music Central Europe GmbH
Siemensstraße 22-34, 25462 Rellingen, Germany
Tel: 04101-3030

SWITZERLAND/LIECHTENSTEIN

Yamaha Music Central Europe GmbH,
Branch Switzerland
Seefeldstrasse 94, 8008 Zürich, Switzerland
Tel: 01-383 3990

AUSTRIA

Yamaha Music Central Europe GmbH,
Branch Austria
Schleiergasse 20, A-1100 Wien, Austria
Tel: 01-60203900

CZECH REPUBLIC/SLOVAKIA/ HUNGARY/SLOVENIA

Yamaha Music Central Europe GmbH,
Branch Austria, CEE Department
Schleiergasse 20, A-1100 Wien, Austria
Tel: 01-602039025

POLAND

Yamaha Music Central Europe GmbH
Sp.z o.o. Oddział w Polsce
ul. 17 Stycznia 56, PL-02-146 Warszawa, Poland
Tel: 022-868-07-57

THE NETHERLANDS/ BELGIUM/LUXEMBOURG

Yamaha Music Central Europe GmbH,
Branch Benelux
Clarissenhof 5-b, 4133 AB Vianen, The Netherlands
Tel: 0347-358 040

FRANCE

Yamaha Musique France
BP 70-77312 Marne-la-Vallée Cedex 2, France
Tel: 01-64-61-4000

ITALY

Yamaha Musica Italia S.P.A.
Viale Italia 88, 20020 Lainate (Milano), Italy
Tel: 02-935-771

SPAIN/PORTUGAL

Yamaha-Hazen Música, S.A.
Ctra. de la Coruna km. 17, 200, 28230
Las Rozas (Madrid), Spain
Tel: 91-639-8888

GREECE

Philippos Nakas S.A. The Music House
147 Skiathou Street, 112-55 Athens, Greece
Tel: 01-228 2160

SWEDEN

Yamaha Scandinavia AB
J. A. Wettergrens Gata 1
Box 30053
S-400 43 Göteborg, Sweden
Tel: 031 89 34 00

DENMARK

YS Copenhagen Liaison Office
Generatorvej 6A
DK-2730 Herlev, Denmark
Tel: 44 92 49 00

FINLAND

F-Musiikki Oy
Kluuvikatu 6, P.O. Box 260,
SF-00101 Helsinki, Finland
Tel: 09 618511

NORWAY

Norsk filial av Yamaha Scandinavia AB
Grini Næringspark 1
N-1345 Østerås, Norway
Tel: 67 16 77 70

ICELAND

Skifan HF
Skeifan 17 P.O. Box 8120
IS-128 Reykjavik, Iceland
Tel: 525 5000

OTHER EUROPEAN COUNTRIES

Yamaha Music Central Europe GmbH
Siemensstraße 22-34, 25462 Rellingen, Germany
Tel: +49-4101-3030

AFRICA

Yamaha Corporation,
Asia-Pacific Music Marketing Group
Nakazawa-cho 10-1, Hamamatsu, Japan 430-8650
Tel: +81-53-460-2312

MIDDLE EAST

TURKEY/CYPRUS

Yamaha Music Central Europe GmbH
Siemensstraße 22-34, 25462 Rellingen, Germany
Tel: 04101-3030

OTHER COUNTRIES

Yamaha Music Gulf FZE
LOB 16-513, P.O.Box 17328, Jubel Ali,
Dubai, United Arab Emirates
Tel: +971-4-881-5868

ASIA

THE PEOPLE'S REPUBLIC OF CHINA

Yamaha Music & Electronics (China) Co., Ltd.
25/F., United Plaza, 1468 Nanjing Road (West),
Jingan, Shanghai, China
Tel: 021-6247-2211

HONG KONG

Tom Lee Music Co., Ltd.
11/F., Silvercord Tower 1, 30 Canton Road,
Tsimshatsui, Kowloon, Hong Kong
Tel: 2737-7688

INDONESIA

PT. Yamaha Music Indonesia (Distributor)
PT. Nusantik
Gedung Yamaha Music Center, Jalan Jend. Gatot
Subroto Kav. 4, Jakarta 12930, Indonesia
Tel: 21-520-2577

KOREA

Yamaha Music Korea Ltd.
8F, 9F, Dongsung Bldg. 158-9 Samsung-Dong,
Kangnam-Gu, Seoul, Korea
Tel: 080-004-0022

MALAYSIA

Yamaha Music Malaysia, Sdn., Bhd.
Lot 8, Jalan Perbandaran, 47301 Kelana Jaya,
Petaling Jaya, Selangor, Malaysia
Tel: 3-78030900

PHILIPPINES

Yupangco Music Corporation
339 Gil J. Puyat Avenue, P.O. Box 885 MCPO,
Makati, Metro Manila, Philippines
Tel: 819-7551

SINGAPORE

Yamaha Music Asia Pte., Ltd.
#03-11 A-Z Building
140 Paya Lebar Road, Singapore 409015
Tel: 747-4374

TAIWAN

Yamaha KHS Music Co., Ltd.
3F, #6, Sec.2, Nan Jing E. Rd. Taipei.
Taiwan 104, R.O.C.
Tel: 02-2511-8688

THAILAND

Siam Music Yamaha Co., Ltd.
891/1 Siam Motors Building, 15-16 floor
Rama 1 road, Wangmai, Pathumwan
Bangkok 10330, Thailand
Tel: 02-215-2626

OTHER ASIAN COUNTRIES

Yamaha Corporation,
Asia-Pacific Music Marketing Group
Nakazawa-cho 10-1, Hamamatsu, Japan 430-8650
Tel: +81-53-460-2317

OCEANIA

AUSTRALIA

Yamaha Music Australia Pty. Ltd.
Level 1, 99 Queensbridge Street, Southbank,
Victoria 3006, Australia
Tel: 3-9693-5111

NEW ZEALAND

Music Houses of N.Z. Ltd.
146/148 Captain Springs Road, Te Papapa,
Auckland, New Zealand
Tel: 9-634-0099

COUNTRIES AND TRUST TERRITORIES IN PACIFIC OCEAN

Yamaha Corporation,
Asia-Pacific Music Marketing Group
Nakazawa-cho 10-1, Hamamatsu, Japan 430-8650
Tel: +81-53-460-2312



Yamaha Home Keyboards Home Page (English only)

<http://music.yamaha.com/homekeyboard>

Yamaha Manual Library

<http://www.yamaha.co.jp/manual/>

U.R.G., Pro Audio & Digital Musical Instrument Division, Yamaha Corporation
© 2007 Yamaha Corporation

WJ21200
70?APZC?.?-01A1
Printed in Indonesia