



Performance Gear Wireless

Quick Start Guide

Mise en service rapide
Schnelles Einrichten

Preparación Rápida
Installazione rapida

Montagem Rápida
クイックセットアップ

快速設置指南
빠른 설정

Быстрая настройка
الإعداد السريع

1

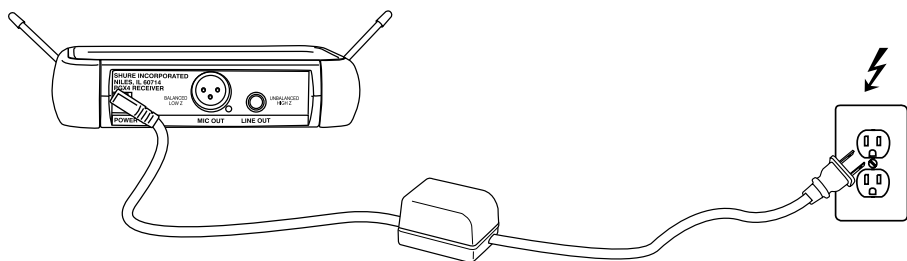

connect receiver power cable

2

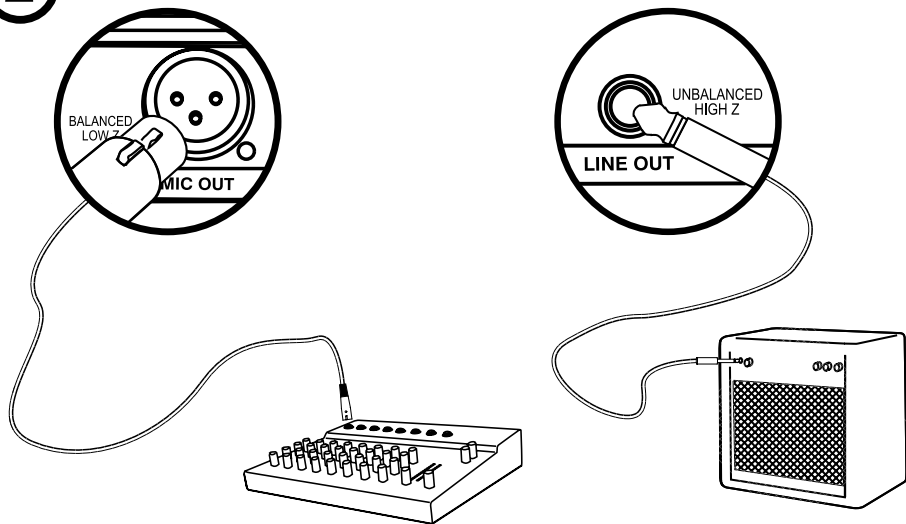

connect mixer or amplifier

3

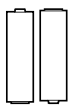

2 x AA

add transmitter batteries

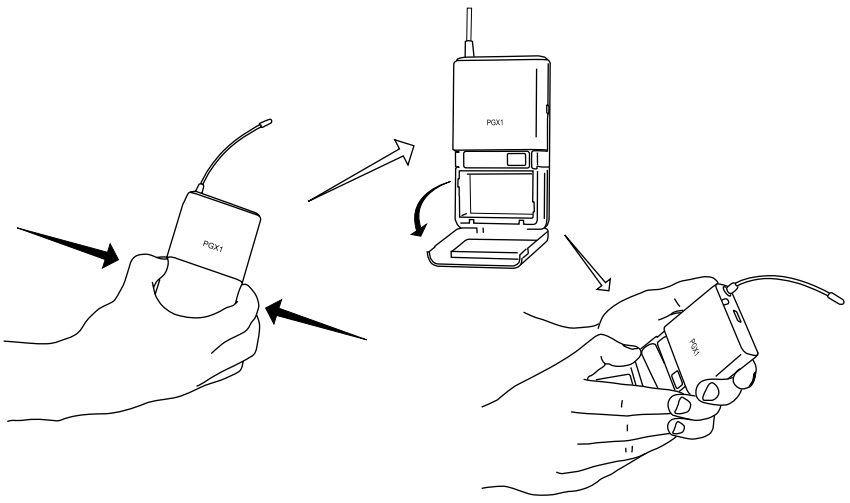

PGX1

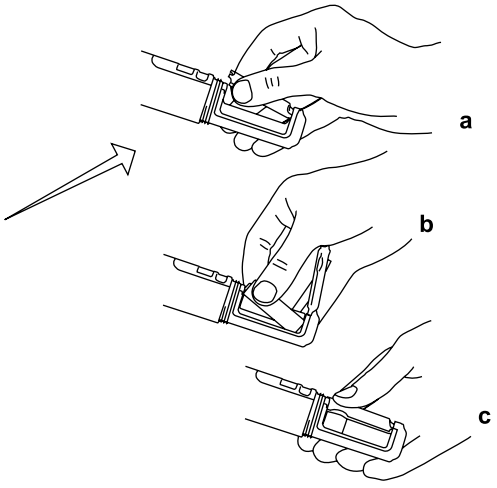
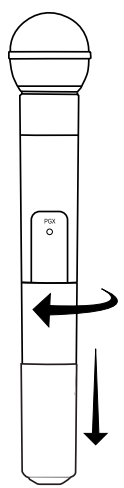

PGX2

4

power

scan for a clear channel and power up

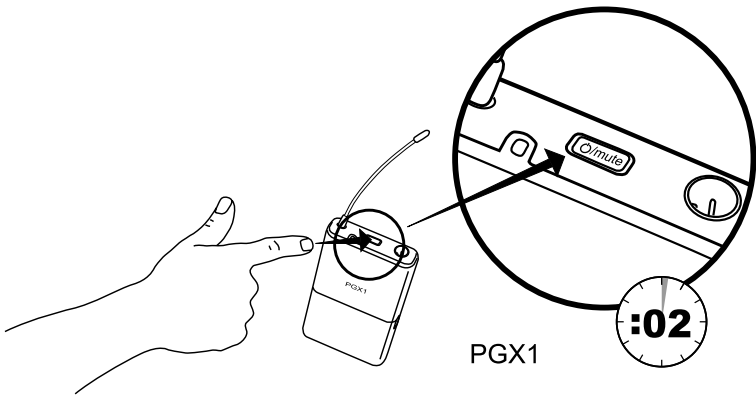
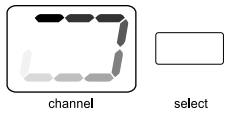
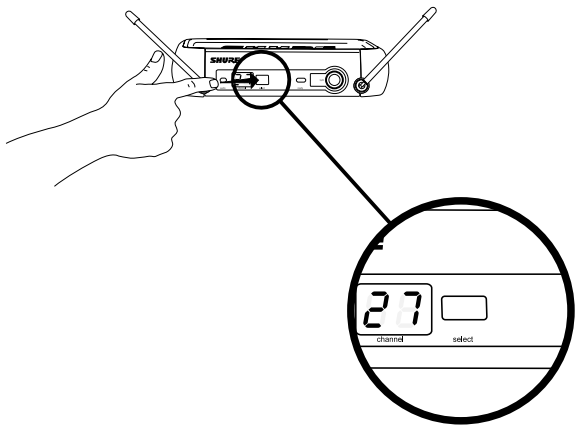

PGX1

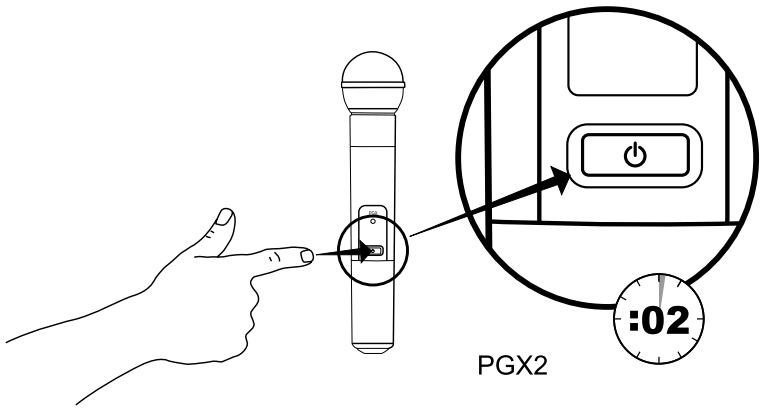

PGX2





5

ready ?

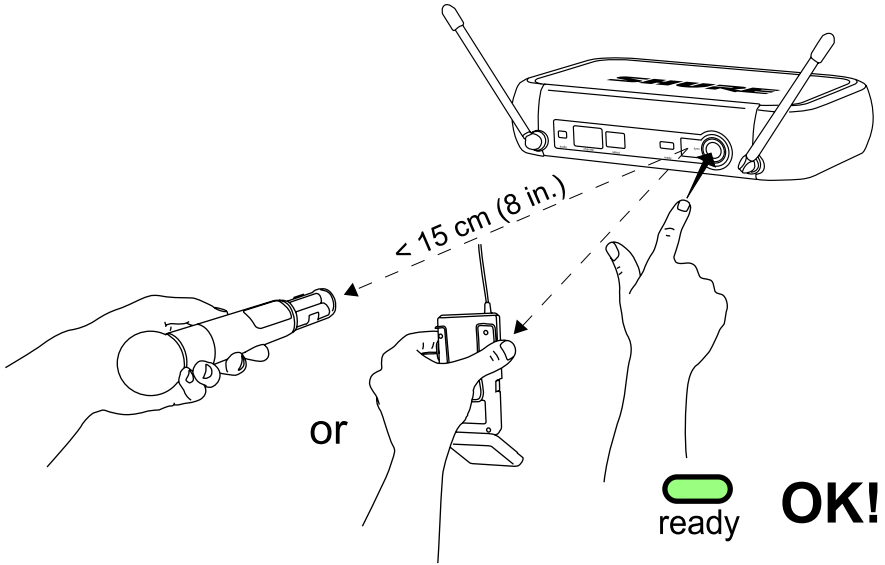
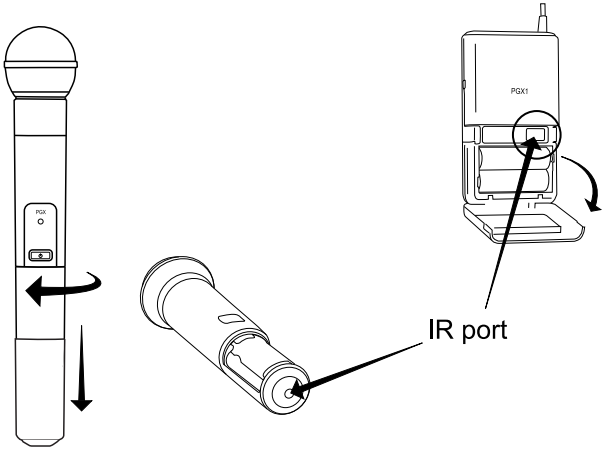
automatic transmitter setup





 For detailed system information, see page 1 of the PGX user guide.

 Pour plus de détails sur le système, voir la page 11 du guide d'utilisation du PGX.

 Detaillierte Informationen zum System befinden sich auf Seite 21 der PGX-Bedienungsanleitung.

 Para información más detallada del sistema, vea la página 31 de la guía del usuario del sistema PGX.

 Per informazioni dettagliate sul sistema, consultare pagina 41 della guida all'uso del sistema PGX.

 Para informações detalhadas sobre o sistema consulte a página 51 do guia do usuário do PGX.

 システム情報の詳細は、PGX取扱説明書の61ページを参照してください。

 关于详细的系统信息，请参看PGX用户手册第71页。

 상세한 시스템 정보에 대해서는 PGX 사용자 안내서의 81 페이지를 참조하십시오.

 Подробные сведения о системе см. на с. тр. 91 руководства пользователя PGX.

