

First Edition June. 2004

Index

1. Introduction	2
2. What's in the Box	2
3. Key Features	3
4. System Requirements	4
5. Exterior Features	5
1. Breakout Box	5
2. PCI Card	5
3. I/O Cable	6
6. Hardware Installation	7
1. Preparation for hardware installation	7
2. Installing the MAYA1010 PCI card	8
7. Software Installation	9
8. MAYA1010 Panel	13
1. File	13
2. Config	14
3. Mapper	14
4. DirectWIRE 3.0	15
5. Control Panel	15
6. Mixer Panel	17
9. Configuring MAYA 1010	18
1. Windows Multimedia Setup	18
2. 5.1 Surround Sound for DVD Player Applications	18
3. ASIO 2.0 Applications	19
4. Sonar	20
5. Cakewalk	20
6. Sound Forge	20
10. DirectWIRE 3.0	22
1. What is DirectWIRE?	22
2. DirectWIRE Panel	22
3. DirectWIRE Examples	23
11. Circuit Diagram of MAYA1010	26
12. Specifications	27
13. Warranty	29

All features are subject to change without prior notice

1. Introduction

Thank you for choosing the AUDIOTRAK MAYA1010. MAYA1010 is a unique PCI multimedia digital audio interface also with a breakout box. We designed MAYA1010 with many powerful functions that will satisfy both beginners and professionals looking for high quality digital audio solutions.

Even if you are an experienced professional, please take some time to read through this user manual and familiarize yourself with the MAYA1010's features and operation. You may also want to refer to your audio software's documentation to better understand how the MAYA1010's features are integrated with the program. Your experience and enjoyment of your MAYA1010 will be greatly enhanced by a good working knowledge of your audio software.

2. What's in the Box

Your MAYA1010 package contains the following:

- MAYA1010 Breakout Box
- MAYA1010 PCI Interface Card
- MIDI I/O, Digital I/O Cable Connector
- User Manual
- Windows driver software CD

3. Key Features

1. Extremely High Quality ADC and DAC

MAYA1010 supports up to 96KHz sampling rate for digital recording. Full 24Bit/192KHz resolution DAC (96KHz bandwidth) with full duplex operation is available over 10 simultaneous inputs and outputs. The MAYA1010 will prove its value in Multi-track Recording, Mastering or DVD Audio applications.

2. Professional digital recording device

MAYA1010 is a professional digital recording device for hard disk recording applications. MAYA1010 is fully compatible with multi-track recording software such as Sonar/Cakewalk, Cubase, Logic, and Nuendo; mastering software such as Sound Forge and Wave Lab; software sampler like GigaStudio, EXS, and Halion and most of Virtual Instruments such as Reason and Reactor.

3. Multimedia / 7.1 channels surround sound device

MAYA1010 delivers ultra high-quality sound and adds unique features to your Windows audio system. MAYA1010 supports all popular audio formats such as MPEG, MP3, WAV, and multimedia formats such as DVD, Video CD, Flash and Internet Broadcasting.

Digital audio is becoming more and more popular and with MAYA1010, you can complete your Desk Top Music Production System easily. MAYA1010 will be the center of your DTMP system providing professional studio quality sound, and easy access to the world of digital music and multimedia.

4. DirectWIRE3.0 support

DirectWIRE3.0 is AUDIOTRAK's unique application that allows you to virtually patch all of your digital audio internally between various software programs. In this latest version, support for patching hardware inputs and mixing multiple audio streams at the inputs has been added. With E-WDM, MAYA1010 can simplify the hassles of wiring externally for inter-driver/inter-application audio data transfer. Especially when you use software synthesizers or virtual instruments, DirectWIRE 3.0 will help simplify your setup.

4. System Requirements

MAYA1010 is a multimedia digital audio device with many functions, not just a simple soundcard. So although MAYA1010 has low CPU dependability, to take full advantage of MAYA1010, your computer needs to meet the minimum system requirements. Faster CPU, faster hard disk, and larger amounts of RAM are generally recommended.

Minimum System Requirements

1. 1 Intel Pentium III CPU or equivalent AMD CPU
2. Motherboard with Intel chipsets(BX,820,815 and so on) or VIA chipsets
3. At least 256MB of RAM
4. One available PCI slot
5. Microsoft Windows 98SE, Windows 2000 or Windows XP operating system.
6. Ultra DMA66/100 and 5400rpm hard disk drive
7. Active speakers or speakers with powered amplifier.

5. Exterior Features

1. Breakout Box

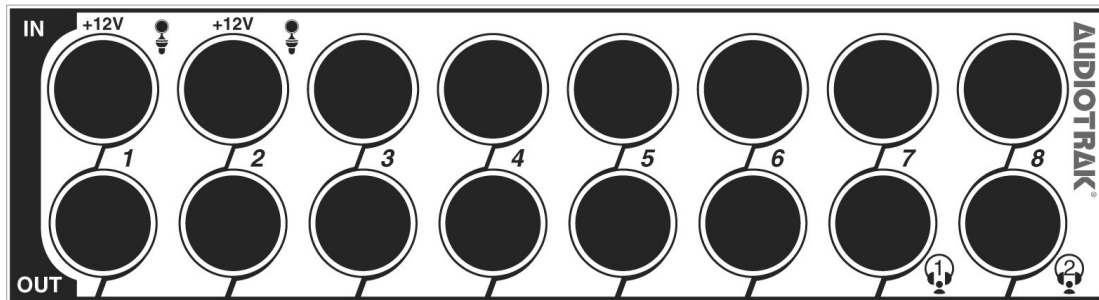

- 1) **MIC inputs (Input 1~2)** – Two 1/4" TRS phone jack type MIC input ports
- 2) **Line Inputs (Input 1~8)** – Eight analog line input ports with balanced TRS phone connector
- 3) **Line Outputs (Output 1~8)** – Eight analog line output ports with unbalanced TS phone connector
- 4) **Headphone Outputs (Output 7~8)** – Two 1/4" TRS phone jack type headphone output ports

2. PCI Card

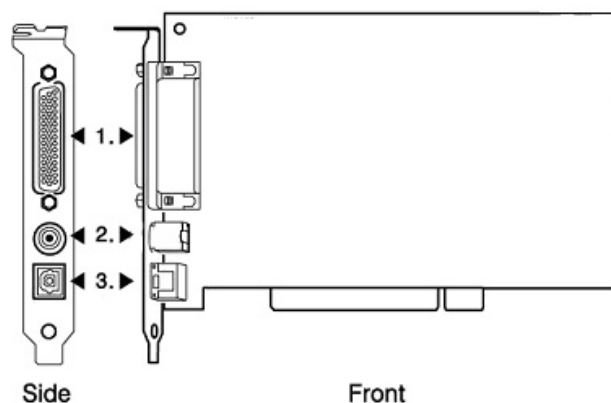

- 1) **D-Sub Connector** - Connects MAYA1010 PCI card with the breakout box
- 2) **Cable Connector** - Connects with included MIDI I/O and coaxial digital I/O cable
- 3) **Digital Optical Output** - Digital output via optical connector

3. I/O Cable

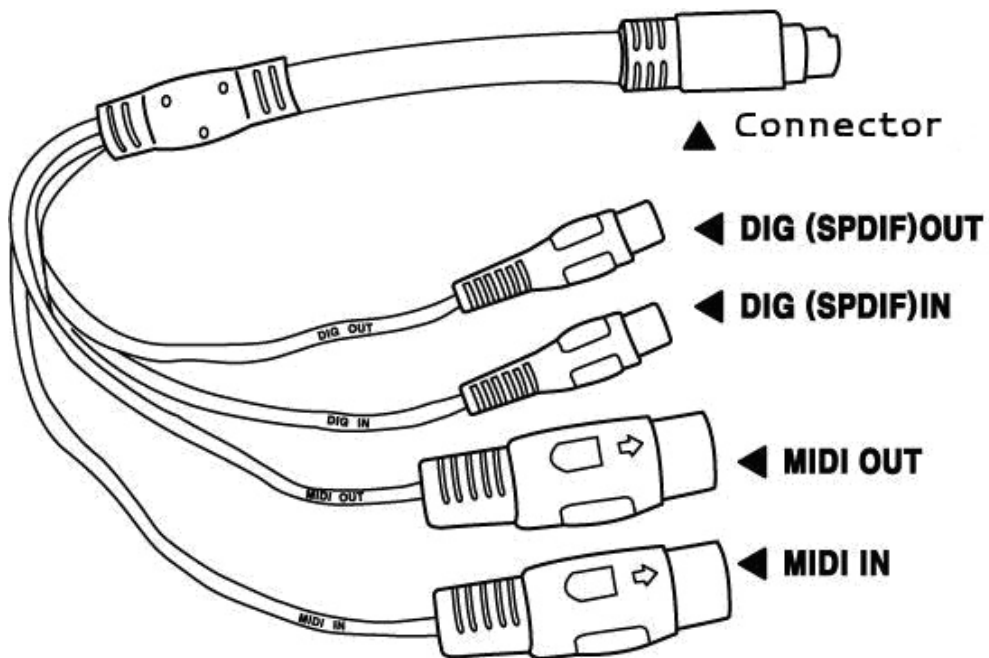

- 1) **Connector** – Connects to MAYA1010 PCI card's cable connector
- 2) **DIG I/O** - Coaxial digital (S/PDIF) input and output connectors
- 3) **MIDI I/O** - Standard MIDI input and output connectors

6. Hardware Installation

MAYA1010 requires multiple installation steps:

- PCI card installation
- Driver installation

Also you need to understand how to connect MAYA1010 to other external devices such as MIC, amp, mixer, and recording devices such as MD or DAT players.

1. Preparation for hardware installation

MAYA1010 PCI card and other components in the computer can easily be damaged by electrical shock. You need to use an anti-static device that can discharge the static electricity of your body to avoid potential static damage to the cards.

- 1) MAYA1010 PCI card is packaged in an anti static plastic pouch. Do not open the pouch until you're ready to install the card.
- 2) Turn off the computer and remove the power cable from your computer's power supply.
- 3) Remove the cover. Make sure that you have an available PCI slot in your motherboard to install MAYA1010. Please refer to your computer's user manual on how to remove the cover.
- 4) To avoid possible static shock to the computer parts, discharge it by touching the computer case or something grounded. We recommend you to use an anti-static device such as an anti-static wrist band.
- 5) When you need to hold the MAYA1010 PCI card, please hold it on the guide or edge of card. Do not grab the card by the board.

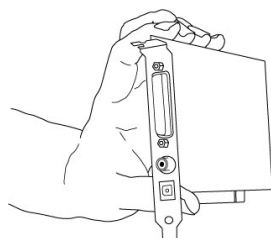

2. Installing MAYA1010 PCI card

- 1) Look for an empty PCI slot. If you do not know which one is a PCI slot, please read the following:

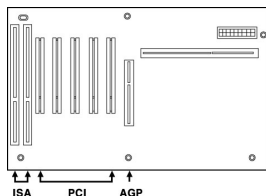

- 2) The PCI slot is the most common and is used for a wide range of devices from the soundcard to the modem. Usually, the PCI slot is the white-colored slot. It should not be too hard to find the PCI slot for MAYA1010.
- 3) If there is a guide blocking the empty slot, please remove the guide using the proper screwdriver.

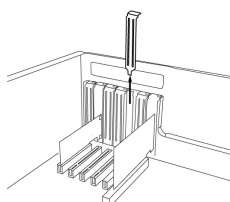

- 4) Put the MAYA1010 PCI card into the slot and make sure it is placed in the slot correctly. Insert the card into the slot and then tighten the screw. Close the case.

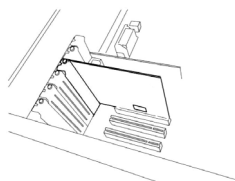

- 5) connect it to the breakout box using the provided cable.

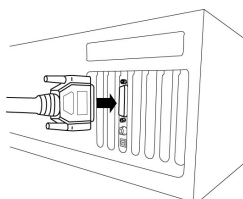

- 6) Connect the I/O cable's connector to the MAYA1010 PCI card.

7. Software Installation

After completing the hardware installation, you need to install the Windows driver. The installation steps in Windows 98SE, Windows 2000 and Windows XP vary, but they are similar between the different versions of Windows. The installation steps shown below are based on Windows XP installation.

Note: Depending on your system, you may need the Windows installation CD.

Note: MAYA1010 installs several drivers during its installation process. Windows will repeatedly prompt you to reboot the system, but unless the driver installation is completely finished, **DO NOT** reboot the system. After complete installation, restart your computer.

1. Turn on your computer. Windows will automatically detect a new device and prompt you with Found New Hardware Wizard screen. Choose “Install from a list or specific location” and click Next.

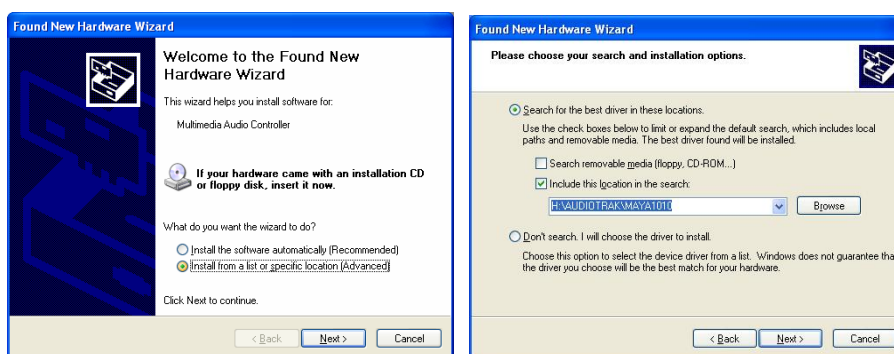

2. Choose “Search for the best driver in these locations” and specify the location of the driver. Insert the provided driver CD into the CD-Rom drive and select “Include this location in the search” and click Browse to find the driver’s location. For example, it is E:\AUDIOTRAK\MAYA1010\, if E:\ is your CD-Rom drive.

3. During installation in Windows 2000 and Windows XP, you will be prompted

with a message warning that the driver software has not passed Windows Logo testing. Select Continue Anyway and proceed with the installation. The driver is completely tested and verified by AUDIOTRAK, and safe to use.



4. When you see the Completing the Found New Hardware Wizard screen, click Finish to complete the installation.

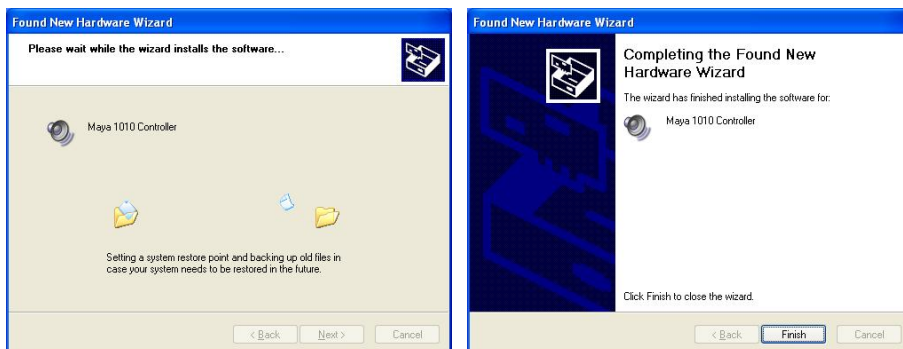

5, Windows will automatically continue to install the MAYA1010 Audio driver.



6. Again, choose "Search for the best driver in these locations" and specify the

location of the driver. Select “Include this location in the search” and click Browse button to find the driver’s location. For example, it is E:\AUDIOTRAK\MAYA1010\, if E:\ is your CD-Rom drive.



7. During installation in Windows 2000 and Windows XP, you will again be prompted with the Windows Digital Signature warning screen. Once again, select Continue Anyway and proceed with the installation.



8. Once the installer has finished copying the files. You will see the Installation Complete screen. Click Finish.

9. After you complete both driver installations, you will be prompted to shut down and restart your computer. Click Yes.

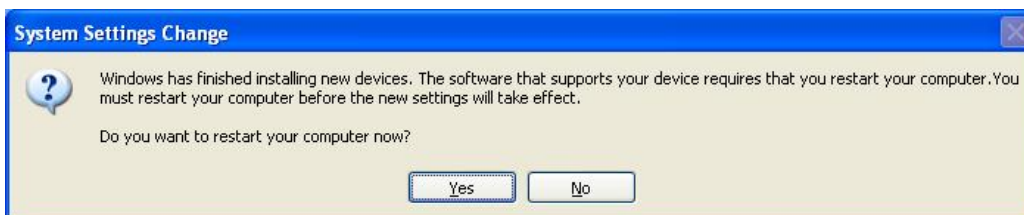

10. After restarting Windows, you will see the MAYA1010 panel icon in your

system tray (lower right corner of your desktop). Click on the icon to open the MAYA1010 panel.



11. Go to Device Manager, check the devices under ‘Sound, video and game controllers’. You will see the MAYA1010 Audio and MAYA 1010 Controller if you have completed the installation process correctly. Your MAYA1010 is ready to use.

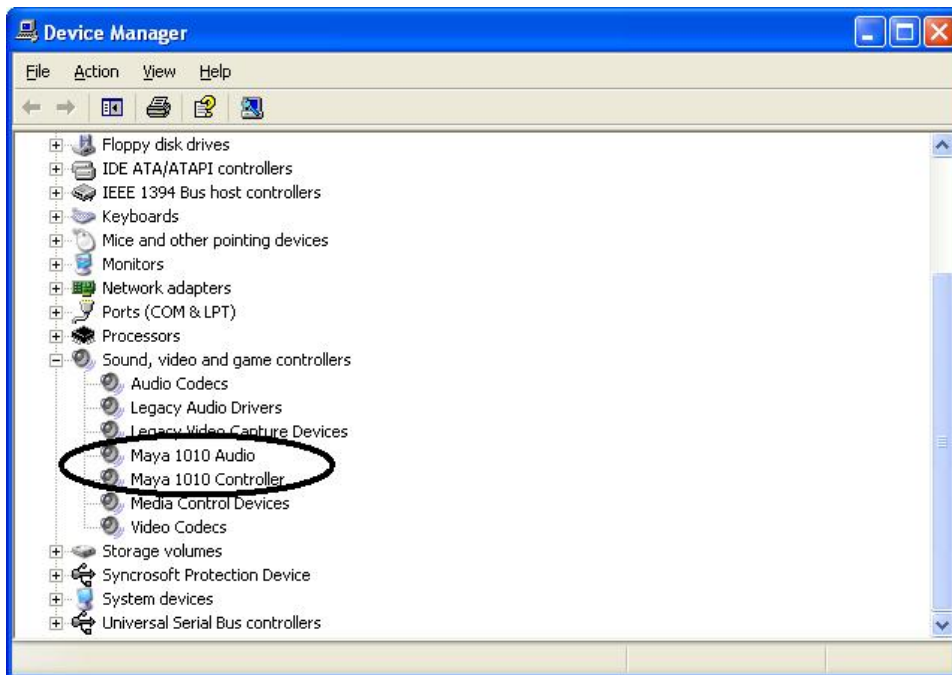

NOTE: You can see 2 MIDI devices on MIDI Music Playback item of Sounds and Audio devices properties. But you can use only “1-MAYA1010 MIDI” device.

8. MAYA1010 Panel

The MAYA1010's driver software provides a simple yet powerful interface with your computer. The panel gives you a multi-channel software mixer with ten virtual outputs from your audio software. Each output may be routed to any of the MAYA1010's eight analog or two digital outputs.

The MAYA1010 panel is installed in your system when you complete the driver installation. To open the panel, double click the  icon, which is the AUDIOTRAK logo, in the system tray.

While the MAYA1010 panel gives you great deal of control, you may find that the default settings work just fine for your needs. Just to be safe, though, we'll cover all the features of the panel in detail.



The MAYA1010 panel features pull down menus for configuration.

1. File

- 1) **Close Windows** (ALT-F4): Closes the MAYA1010 panel window. Note that this does not shut down the panel. You may open the panel again by clicking the  icon in the system tray.
- 2) **Exit**: Shuts down the MAYA1010 panel completely.

2. Config

- 1) **Mouse Wheel:** Configures the mouse wheel for volume change adjustment. Default value is $\pm 1.5\text{dB}$ per step. You can configure the steps to your preference.

Configuration	Step 1	Step 2	Step 3	Step 4
Change/Step	$\pm 1.5\text{dB}$	$\pm 3.0\text{dB}$	$\pm 6.0\text{dB}$	$\pm 12.0\text{dB}$

- 2) **Latency:** Configures the latency setting for MAYA1010. Generally, for multi-track recording we recommend higher latency for stability. For software synthesizers and mastering software, we recommend lower latency. The optimal latency setting will depend on your application and your computer system.
- 3) **Factory Default:** Allows you to revert back to the factory default setting for all configurations.
- 4) **Always On Top:** This enables the MAYA1010 panel to be always displayed on the top.

3. Mapper

Enables you to choose the input and output port when you select “MAYA 1010 2ch” device in Sounds and Audio Devices Properties as shown below.

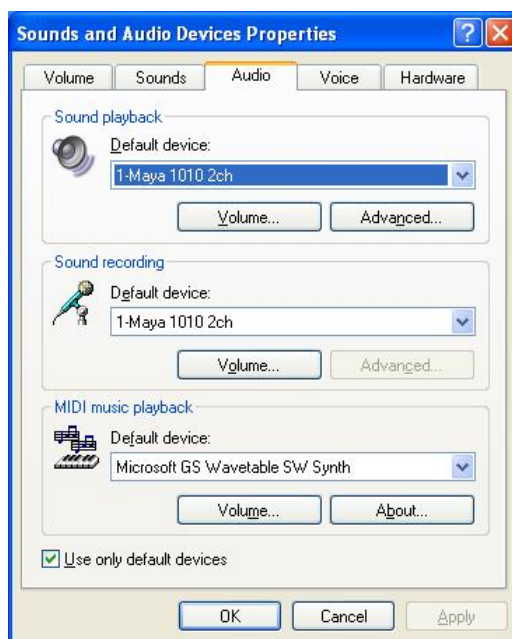

4. DirectWIRE 3.0

Clicking this menu will open the DirectWIRE 3.0 screen. DirectWIRE 3.0 is a unique feature of the E-WDM driver that transfers digital audio data internally within different applications. MME, Multi-MME, ASIO and GSIF indicate the different drivers supported by MAYA1010. The numbers along the column designate the channel number of the inputs and outputs.

Please refer to Section 10, Using DirectWIRE 3.0 on page 22 for more detailed instructions and examples on using DirectWIRE 3.0.

5. Control Panel

You can come back to the panel control screen by clicking this menu. It is also the default screen you see when you first launch the panel. Basic functions of MAYA1010 are controlled from this screen.

- 1) INPUT:** You can change the input monitoring level on all channels (1~8, S/PDIF) by clicking and dragging the fader bar. The number on the bottom shows the relative amount in dB. Clicking this number enables you to mute the channel.



You can control gain from -60dB to +15dB (0.5dB per step) on input ch 1/2. Also, input ch 1/2 supports +12V phantom power microphone. To use the microphone you must change the input level to “M” (microphone) from “L” (line input). After selecting “M”, you can select “12” (12V) on each channel for phantom power.

- 2) **OUTPUT:** You can change the output monitoring level on all channels (1~8, S/PDIF) by clicking and dragging the fader bar. The number on the bottom shows the relative amount in dB. Clicking this number enables you to mute the channel.

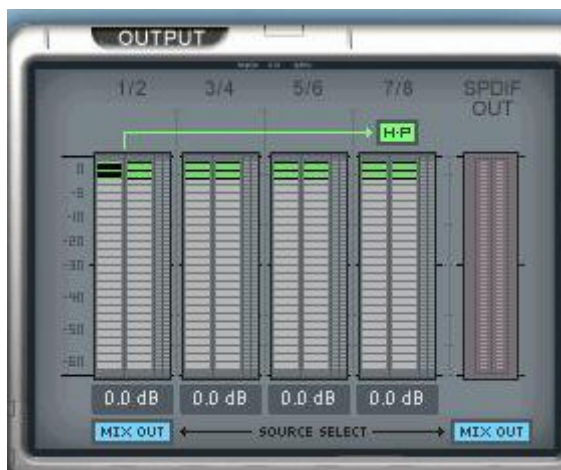

H·P: Output ch 1/2 can be used for headphone output.

MIX OUT: Hear sounds from the mixer panel. Please refer to Section 6. on page 17, for more information on the Mixer Panel. You can mix output to ch 1/2 if you select H·P or to S/PDIF.

- 3) **MASTER:** You can adjust all input / output monitoring levels by clicking and dragging the fader in the master control panel. Again the number on the bottom shows you the relative monitoring level in dB. Clicking this number enables you to mute the channel.



LINK: You can control volume of left and right channels independently by deselecting this button.

- 4) **S / R:** You can configure the sampling rate in this panel.
Auto: Automatically sets the sampling rate to your audio file's sampling rate.
22~96: You can set the sampling rate manually from 22kHz to 96kHz.
- 5) **MASTER CLOCK:** Allows you to choose the digital clock source for MAYA1010.
INT: Sets the MAYA1010's internal clock as the master clock. If other devices are set as slave, you need to use this setting.
EXT: When MAYA1010 receives digital data from an external digital device through S/PDIF coaxial digital input, the 'LOCKED' indicator will tell you that MAYA1010 is receiving the data. You can then select Digital to use the incoming digital audio data as the clock source. External device becomes the master and MAYA1010 becomes the slave.

6. Mixer Panel

Clicking this menu opens the mixer screen of MAYA1010 panel.

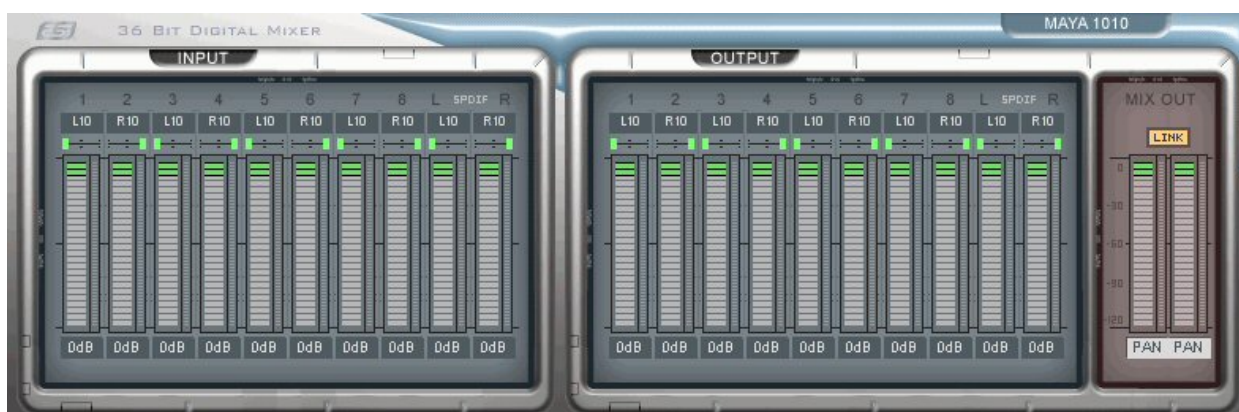

You can control panning, mixing and mute within this screen.

7. About

You can check Version information of driver.

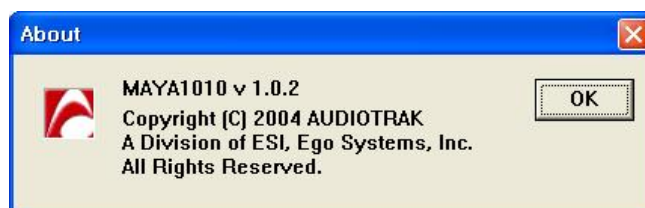

9. Configuring MAYA1010

MAYA1010 is a premium multimedia audio device for professional audio. It is simple to configure MAYA1010 for use in games to DVD surround sound. You can also configure MAYA1010 for hard disk recording using professional digital audio software. This chapter includes the setup guide for some common applications. MAYA1010 supports applications that use WDM, MME, ASIO, GSIF and Direct Sound.

NOTE: Only the basic setup options for the applications are shown in this chapter. For more detailed setup options please refer to the software manual.

1. Windows Multimedia Setup

To configure MAYA1010 for Windows multimedia applications:

Go to Control Panel → Sounds and Audio Device Properties → Audio tab. Select “2-Maya 1010 10ch” driver as your playback device.

2. 5.1 Surround Sound for DVD Player Applications

To configure MAYA1010 for 5.1 channel surround sound DVD player:

Go to Control Panel → Sounds and Audio Device Properties → Audio tab. Select “6-Maya 1010 10ch” driver as your playback and recording device.

NOTE: You must check “Enable DMA” in your DVD-Rom drive settings. If not, you may not get a crisp image during DVD playback.

Set speaker configurations in your software DVD player to “6 Speaker.” You’re ready to enjoy DVD with 5.1 channel surround sound.

This is an example of 5.1 channel surround sound route for MAYA1010. The order may vary for different versions of Windows.

MAYA1010 Output	1	2	3	4	5	6
Speaker	Front Left	Front Right	Center	Woofers	Surround Left	Surround Right

PowerDVD 5.0 supports 8 channel surround speaker outputs as shown below. However, most of DVD titles only have 5.1 surround sounds. You can enjoy Dolby Digital DVD with just 6 speaker setting.

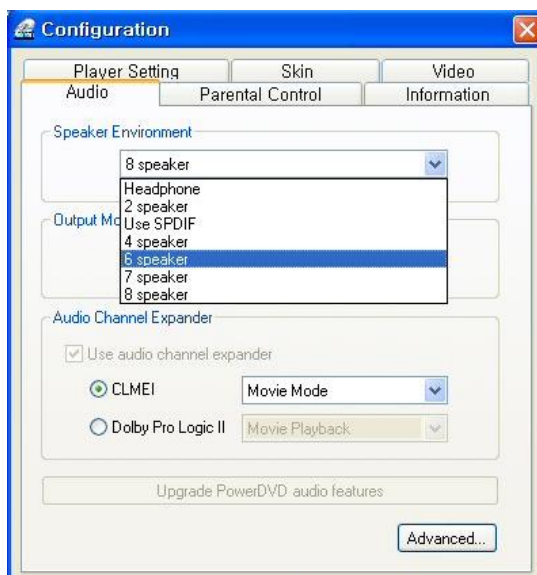

3. ASIO 2.0 Applications

1) Cubase VST

After launching Cubase VST, go to Options -> AudioSetup → System. Select “ASIO 2.0 – MAYA1010” as ASIO device and “MAYA1010 Clock” as Audio clock source.

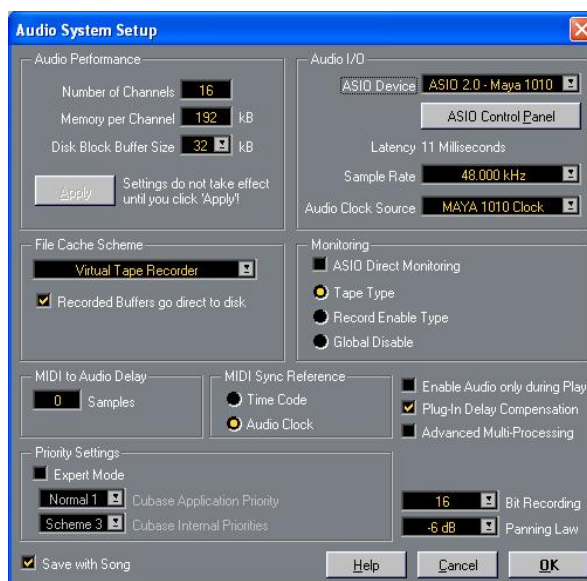

2) Nuendo or Cubase SX / SL / SE

After launching Nuendo or Cubase, go to Device → Device Setup → VST Multitrack. Select “ASIO 2.0 – MAYA1010” as ASIO device and “MAYA1010 Clock” as Audio clock source.

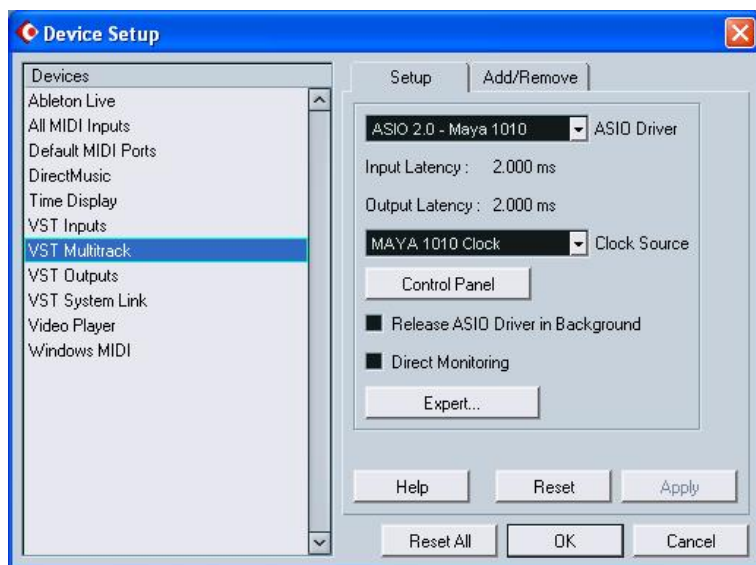

3) Logic

After launching Logic, go to Options>Preference > Audio Driver 2. And check “ASIO” and select “ASIO 2.0 – MAYA1010”.

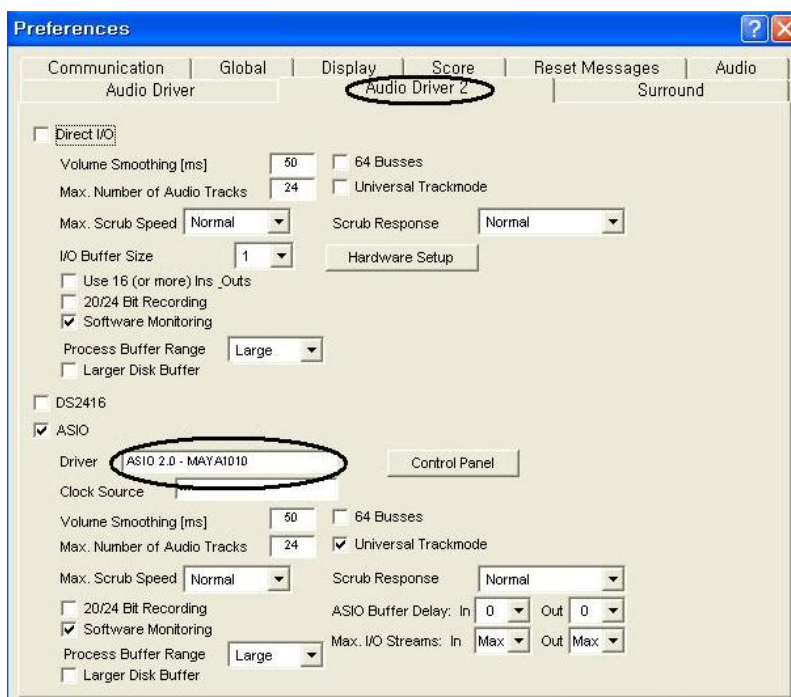

4. Sonar

Before using Sonar, change the latency setting appropriately in the console. After launching Sonar, go to Options → Audio Options→ General, select “MAYA 1010 10ch 1~10” on Playback and Record timing for WDM driver.

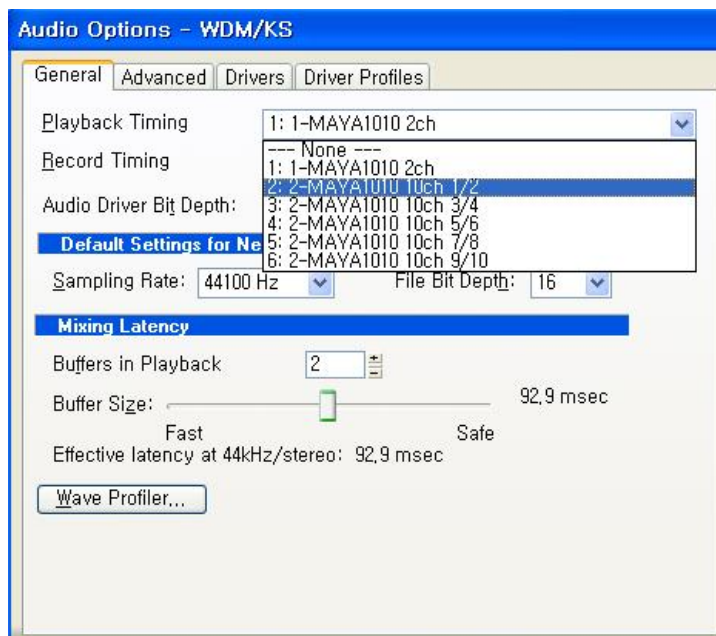

5. Sound Forge

After launching Sound Forge, go to Options → Preferences → Wave. Choose “MAYA1010 2ch” as Playback and Record device.

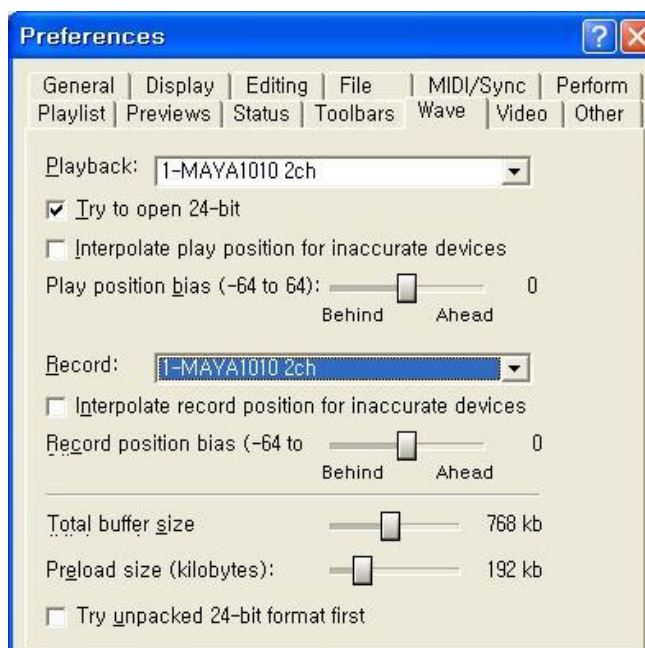

10. DirectWIRE 3.0

1. What is DirectWIRE?

DirectWIRE is a 100% purely digital wire!

DirectWIRE is a driver technology, developed by AUDIOTRAK, which can be used for routing audio streams internally within applications using E-WDM Audio MIDI drivers, exclusively developed by AUDIOTRAK.

With the DirectWIRE router, an application can record from other application's audio outputs without external wiring or any loss of data while they are running at the same time.

DirectWIRE also allows you to easily rip any audio stream in real time by transferring data through DirectWIRE from MP3s, live On-line Broadcasts, On-Demand content, and more.

2. DirectWIRE Panel

Click on DirectWIRE on the MAYA1010 panel. The DirectWIRE panel window as shown below will appear.

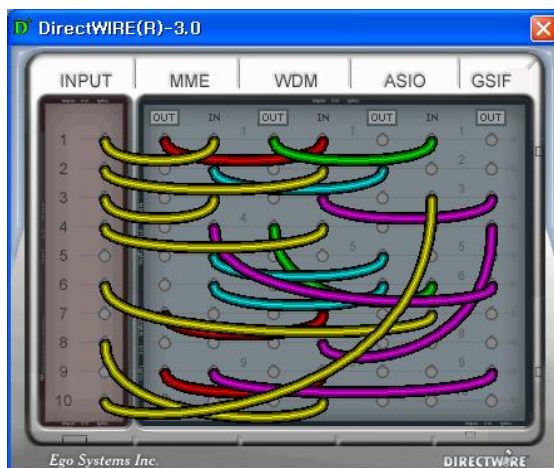

The number along the row represents the number of the input or output port. The columns represent inputs and outputs (on and off) of the respective drivers. Patch the virtual cables from one point to another as you drag your mouse.

INPUT column is a new feature of DirectWIRE 3.0. It's used to route signals from the card's hardware inputs. With MAYA1010, from INPUT 1 to 8 are identical to the each left and right channels of the analog input signal. And INPUT 9 and 10 are the left and right channels of the digital input.

MME column represents general application's I/O:

Ex.) WinAmp, WaveLab (non ASIO mode), Cakewalk, Audition, Vegas, etc.

WDM column represents Multi-MME application's I/O:

Ex.) SONAR (WDM/KS mode), PowerDVD, WinDVD, etc.

ASIO column represents ASIO application's I/O:

Ex.) Cubase, Logic, Reason, Nuendo, SONAR (ASIO mode), Samplitude, etc.

GSIF column represents GSIF applications like GigaStudio.

NOTE: Some applications support multiple driver modes.

3. DirectWIRE Examples

NOTE: Please setting DirectWIRE up first before starting application program..

- 1) Recording from WinAmp(MME) to WaveLab(MME)



Caution; If you want to record what's played back in Winamp, but don't want to hear the sound, you should click the OUT button in the MME section so that it changes to **"OUT"**

2) Recording from WinAmp(MME) to SONAR(WDM)



3) Recording from WinAmp(MME) to Cubase, Logic, Nuendo(ASIO)



4) Recording from GigaStudio(GSIF) to SONAR(WDM)



5) Recording from GigaStudio(GSIF) to Cubase(ASIO)

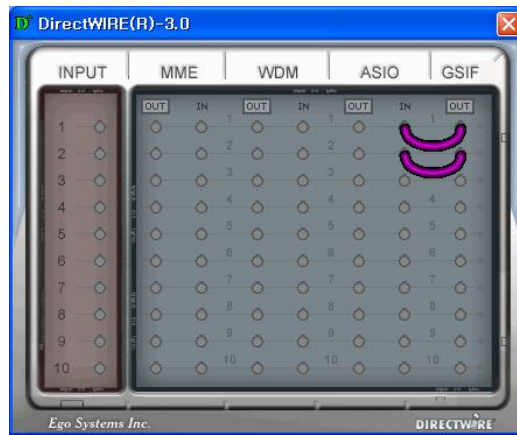

6) Let's say you want to quickly dub some vocal over an audio track. It's very simple with DirectWIRE 3.0. You just have to make connections similar to these.



11. Circuit Diagram of MAYA1010

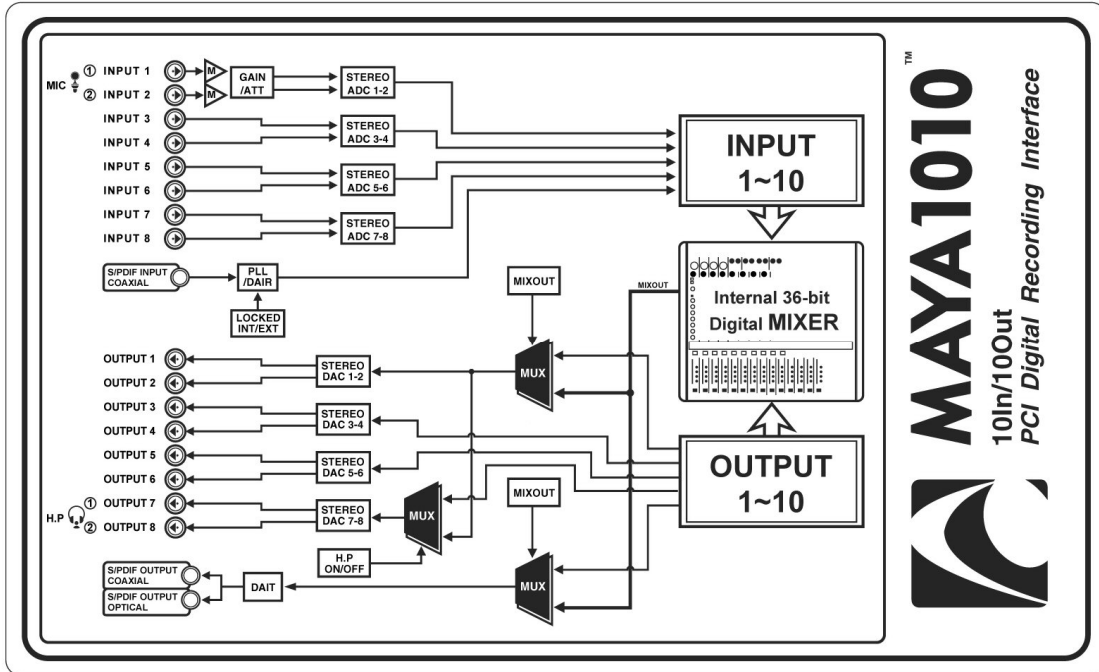

12. Specifications

<Analog Audio>

1. Analog Inputs

- 1) Connector Type: 1/4" female TRS-type, balanced or unbalanced (ch 1~8)
- 2) Peak level: 0dBFS @ +6.5dBV (-10dBV nominal)
- 3) Impedance: 10k ohms minimum
- 4) Att. & Gain Control: -60dB ~ +15dB (0.5dB step size) *ch1, 2ch only

2. Analog Outputs

- 1) Connector Type: 1/4" female TS-type, unbalanced (ch 1~8)
- 2) Peak level: +6.2dBV @ 0dBFS (-10dBV nominal)
- 3) Impedance: 100 ohms
- 4) Attenuation Control: -60dB ~ 0dB (0.5dB step size)

3. Mic Preamplifier

- 1) Peak level: 0dBFS @ -40dBV
- 2) Gain Adjustment: Gain +31dB up + -60 ~ +15dB (0.5dB step size)
- 3) +12V phantom power supply

4. Headphone Amplifier

- 1) Load Impedance Range: 32-600 ohm (for the best performance)
- 2) Output Power: 125mW @ 32ohm per channel

<Digital Audio>

1. Internal 20ch /36-bit Digital Mixer(Input 10ch/Output 10ch)

- 2. Sample rate supports: (22.05,24)*,32,44.1,48,88.2,96KHz : *analog only

3. A/D Converter

- 1) Signal to Noise Ratio: 107dB (A-weighted) @ fs=48kHz
- 2) Dynamic Range: 107dB (-60dBFS with A-weighted) @ fs=48kHz
- 3) S/(N+D)(-1dB): 100dB @ fs=48kHz
- 4) Interchannel Isolation: -110dB
- 5) Resolution: 24-Bit

4. D/A Converter

- 1) Signal to Noise Ratio: 112dB (A-weighted) @ fs=44.1kHz
- 2) Dynamic Range (S/N): 112dB (60dBFS with A-weighted) @ fs=44.1kHz
- 3) THD+N: -94dB @ fs=44.1kHz
- 4) Interchannel Isolation: -100dB
- 5) Resolution: 24-Bit / 192KHz

5. Digital Input

- 1) Connector Type: RCA(provided via breakout cable)
- 2) Format: IEC-60958 Consumer(S/PDIF coaxial)
- 3) Sampling Rate: 44.1,48,88.2,96KHz
- 4) Resolution: 24-Bit

6. Digital Output

- 1) Connector Type: RCA(provided via breakout cable), Optical(on board)
- 2) Format: IEC-60958 Consumer(S/PDIF coaxial)
- 3) Sampling Rate: 44.1,48,88.2,96KHz
- 4) Resolution: 24-Bit

<MIDI>

7. MIDI I/O

- 1) 1-in, 1-out; 16 MIDI channels in and out
- 2) Connector Type: Standard MIDI 5-pin DIN (provided via breakout cable)

13. Warranty

Trademarks

AUDIOTRAK and MAYA1010 are trademarks of Ego Systems Inc. Windows is a trademark of Microsoft Corporation. Other product and brand names are trademarks or registered trademarks of their respective companies.

End User Warranty

Ego Systems, Inc. warrants this product, under normal use, to be free of defects in materials and workmanship for a period of One(1) year from date of purchase, so long as: the product is owned by the original purchaser, with proof of purchase from an authorized AUDIOTRAK dealer. This warranty explicitly excludes power supplies and included cables which may become defective as a result of normal wear and tear.

In the event that AUDIOTRAK receives, from an original purchaser and within the warranty coverage period, written notice of defects in materials or workmanship, AUDIOTRAK will either replace the product, repair the product, or refund the purchase at its option. To obtain warranty service, the original purchaser or his authorized dealer must fill the support contact form at <http://audiotrak.net/support.htm>. In the event repair is required, shipment to and from AUDIOTRAK and possible handling charges shall be borne by the purchaser. AUDIOTRAK will not accept returns without prepaid shipments. In the event that repair is required, a Return Authorization number must be obtained from AUDIOTRAK. After this number is obtained, the unit should be shipped back to AUDIOTRAK in a protective package with a description of the problem and the Return Authorization clearly written on the package. All such returns must be shipped to Ego Systems, Inc. headquarters in Seoul, Korea (or US Office).

In the event that AUDIOTRAK determines that the product requires repair because of user misuse or regular wear, it will assess a fair repair or replacement fee. The customer will have the option to pay this fee and have the unit repaired and returned, or not pay this fee and have the unit returned and un-repaired.

The remedy for breach of this warranty shall not include any other damages. AUDIOTRAK will not be liable for consequential, special, indirect, or similar damages or claims including loss of profit or any other commercial damage, even if its agents have been advised of the possibility of such damages, and in no event will AUDIOTRAK's liability for any damages to the purchaser or any other person exceed the price paid for the product., regardless of any form of the claim. AUDIOTRAK specifically disclaims all other warranties, expressed or implied. Specifically, AUDIOTRAK makes no warranty that the product is fit for any particular purpose.

The FCC and CE Regulation Warning

This device complies with Part 15 of the FCC Rules. Operation is subject to the following two conditions : (1) this device may not cause harmful interference, and (2) this device must accept any interference received, including interference that may cause undesired operation. Caution : Any changes or modifications in construction of this device with are not expressly approved by the party responsible for compliance, could void the user's authority to operate equipment.

NOTE : This equipment has been tested and found to comply with the limits for a Class A digital device, pursuant to Part 15 of the FCC Rules. These limits are designed to provide reasonable protection against harmful interference when the equipment is operated in a commercial environment. This equipment generates, uses, and can radiate radio frequency energy and, if not installed and used in accordance with the instruction manual, may cause harmful interference to radio communications. Operation of this equipment in a residential area is likely to cause harmful interference in which case the user will be required to correct the interference at his own expense. If necessary, consult an experienced radio/television technician for additional suggestions.

Correspondence

For technical support inquiries, contact your nearest dealer or EGO SYSTEMS directly at:

Ego Systems Inc.
Suite 1206, Woolim e-BIZ Center,
16 Yangpyoung-dong 3-ga,
Youngdungpo-gu, Seoul, Korea
www.esi-pro.com

Technical Support on web: <http://www.audiotrak.net/support.htm>