

iStomp™

Owner's Manual



DECLARATION OF CONFORMITY

Manufacturer's Name: DigiTech
Manufacturer's Address: 8760 S. Sandy Parkway
Sandy, Utah 84070, USA

With regard to Directive 2005/32/EC and EC Regulation 1275/2008 of 17 December 2008, this product is designed, produced, and classified as Professional Audio Equipment and thus is exempt from this Directive.

declares that the product:

Product name: iStomp

Roger Johnsen
Director, Engineering
Signal Processing
8760 S. Sandy Parkway
Sandy, Utah 84070, USA
Date: December 9, 2011

Product option: all (requires Class II power adapter that conforms to the requirements of EN60065, EN60742, or equivalent.) DSC-iOS

conforms to the following Product Specifications:

Safety: IEC 60065 -01+Amd 1
EMC: EN 55022:2006
EN 55024:1998
FCC Part 15

European Contact: Your local DigiTech Sales and Service Office or

Harman Signal Processing
8760 South Sandy Parkway
Sandy, Utah
84070 USA
Ph: (801) 566-8800
Fax: (801) 568-7583

Supplementary Information:

The product herewith complies with the requirements of the:

Low Voltage Directive 2006/95/EC
EMC Directive 2004/108/EC.
RoHS Directive 2002/95/EC
WEEE Directive 2002/96/EC
EC Regulation 278/2009

ELECTROMAGNETIC COMPATIBILITY

This device complies with part 15 of the FCC Rules and the Product Specifications noted on the Declaration of Conformity. Operation is subject to the following two conditions:

- this device may not cause harmful interference, and
- this device must accept any interference received, including interference that may cause undesired operation.

Operation of this unit within significant electromagnetic fields should be avoided.

- use only shielded interconnecting cables.

Conforms to ICES-003

Conforme á ICES-003

Conforms to EN55022



If you want to dispose of this product, do not mix it with general household waste. There is a separate collection system for used electronic products in accordance with legislation that requires proper treatment, recovery, and recycling.

Private households in the 25 member states of the EU, in Switzerland and Norway may return their used electronic product free of charge to designated collection facilities or to a retailer (if you purchase a similar new one).

For countries not mentioned above, please contact your local authorities for a correct method of disposal.

By doing so you will ensure that your disposed product undergoes the necessary treatment, recovery, and recycling and thus prevent potential negative effects on the environment and human health.

WARNING

For your protection, read the following:

Important Safety Instructions

1. Read these instructions.
2. Keep these instructions.
3. Heed all warnings.
4. Do not use this apparatus near water.
5. Clean only with dry cloth.
6. Do not block any ventilation openings. Install in accordance with the manufacturer's instructions.
7. Do not install near any heat sources such as radiators, heat registers, stoves, or other apparatus (including amplifiers) that produce heat.
8. Protect the power cord from being walked on or pinched particularly at plugs, convenience receptacles, and the point where they exit from the apparatus.
9. Unplug this apparatus during lightning storms or when unused for long periods of time.
10. No user serviceable parts inside. Refer all servicing to qualified service personnel. Servicing is required when the apparatus has been damaged in any way, such as power-supply cord or plug is damaged, liquid has been spilled or objects have fallen into the apparatus, the apparatus has been exposed to rain or moisture, does not operate normally, or has been dropped.
11. **WARNING:** To reduce the risk of fire or electric shock, do not expose this apparatus to rain or moisture.
12. Refer to labels on the unit, including bottom cover, or other markings and pertinent information.

Warranty

We at **DigiTech**[®] are very proud of our products and back up each one we sell with the following warranty:

1. Please register online at www.digitech.com within ten days of purchase to validate this warranty.
2. DigiTech warrants this product, when used solely within the U.S., to be free from defects in materials and workmanship under normal use and service.
3. DigiTech liability under this warranty is limited to repairing or replacing defective materials that show evidence of defect, provided the product is returned to DigiTech WITH RETURN AUTHORIZATION, where all parts and labor will be covered up to a period of one year. This warranty is extended, for the iStomp pedal hardware only, to a period of six years when the product has been properly registered through our website. A Return Authorization number may be obtained from DigiTech by telephone. The company shall not be liable for any consequential damage as a result of the product's use in any circuit or assembly.
4. Proof-of-purchase is considered to be the burden of the consumer.
5. DigiTech reserves the right to make changes in design, or make additions to, or improvements upon this product without incurring any obligation to install the same on products previously manufactured.
6. The consumer forfeits the benefits of this warranty if the product's main assembly is opened and tampered with by anyone other than a certified DigiTech technician or, if the product is used with AC voltages outside of the range suggested by the manufacturer.
7. The foregoing is in lieu of all other warranties, expressed or implied, and DigiTech neither assumes nor authorizes any person to assume any obligation or liability in connection with the sale of this product. In no event shall DigiTech or its dealers be liable for special or consequential damages or from any delay in the performance of this warranty due to causes beyond their control.

NOTE: The information contained in this manual is subject to change at any time without notification. Some information contained in this manual may also be inaccurate due to undocumented changes in the product or operating system since this version of the manual was completed. The information contained in this version of the owner's manual supersedes all previous versions.

Introduction

Thank you for purchasing the DigiTech® iStomp™ Downloadable Pedal. The iStomp is a configurable stompbox which you can purchase and download different pedals into. The iStomp looks and performs just like a standard stompbox with control knobs, a footswitch, and a bypass/active LED indicator, but provides much more flexibility than any other pedal available.

Using iOS devices as the programming interface, you can choose from a vast library of pedals and download them directly into the iStomp using the Stomp Shop™ app (available for free on the Apple® App Store™). Upgrading your pedals has just become as easy as a download!

Included Items

- iStomp Downloadable Pedal
- DigiTech DSC-iOS Cable
- Power Supply
- Online Warranty Registration Information Card
- Owner's Manual
- iStomp Effect Labels
- DigiTech Redline™ overdrive and Total Recall™ digital delay pedals included

Features

- 4 knobs for controlling pedal settings
- Mono and stereo inputs & outputs
- Rugged metal footswitch
- DSC Download port
- Power supply included
- Free Stomp Shop™ app
- Growing library of great pedals to choose from
- Multiple pedal categories (including: Compression, Overdrive, Distortion, Chorus, Flanger, Phaser, Modulation, Pitch, Filter, Delay, Reverb, and more)

Requirements

- Any iOS device capable of running iOS 4.0 or later
- iTunes® account
- Internet connection to your iOS device
- Stomp Shop™ app (free download from the Apple® App Store™)

iPhone, iPod Touch, and iPad are trademarks of Apple Inc., registered in the U.S. and other countries.

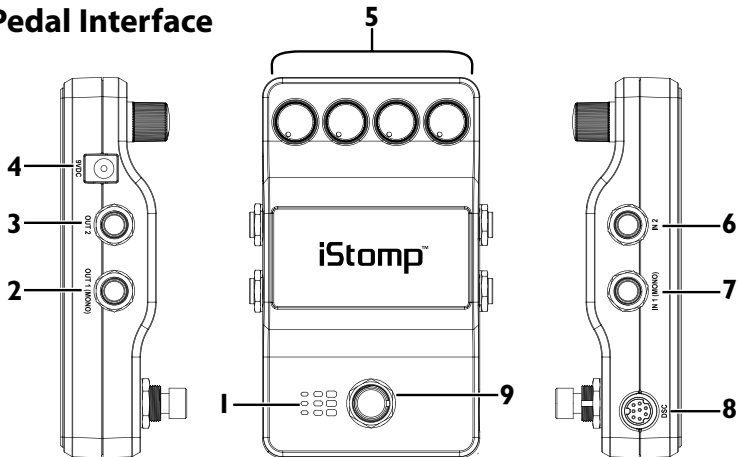

Pedal Interface



1. **Indicator LED** – This multi color LED indicates when the effect is turned on or off. If a delay pedal is downloaded into the iStomp, this LED will flash when used with Tap Tempo to show the delay time (see page 13 “Delay Tap Tempo” for information on Tap Tempo). Using the Stomp Shop app, the color of this LED can be customized for each downloaded pedal.
2. **OUT 1 (Mono) Jack** – Connect this output when only a single guitar amplifier is being used.
3. **OUT 2 Jack** – Connect this output to a second guitar amplifier when a second amp is being used.
4. **DC Power Input** – Connect only the included power supply to this jack.
5. **Knobs** – These knobs are used to control the pedal settings. The function of each of these knobs varies depending on which pedal has been loaded into the iStomp. Knob assignments for each pedal can be viewed in the “Info” window in the Stomp Shop app.

6. **IN 2 Jack** – Connect a second input to this jack for stereo operation when stereo pedals are used. IN 1 and IN 2 are fed through the effect and then to OUT 1 and OUT 2 and will keep true stereo separation between channels when both inputs are used. **Note:** IN 2 is disabled when a mono effect is loaded, such as distortion (tap the INFO button to see which pedals do not support IN 2).
7. **IN 1 (Mono) Jack** – When only a single input is needed, this jack is to be used. Signals will be heard at both outputs regardless if the effect is on and off. Pedals that only require a single input (compressors, overdrives, distortions, etc...) should only use IN 1 (Mono) since IN 2 is disabled in these pedals.
8. **DSC Download Port** – The download port is used for programming the pedal from your iOS device via the included DSC-iOS cable.
9. **Footswitch** – Press this footswitch to turn the effect on and off. If a delay pedal is loaded into the iStomp hardware, this footswitch can also be used to set the delay time by enabling the Tap Tempo function (see page 13 “Delay Tap Tempo” for more information on Tap Tempo).

Quick Start

1. Launch the App Store from your compatible iOS device and install the DigiTech Stomp Shop app.
2. Connect your iOS device to the iStomp (as described on page 8).
3. Launch the Stomp Shop app.
4. Browse through the different pedals and find one you would like to try or buy. Selecting the **TRY**  option allows you to download and use the pedal for free for 5 minutes. Selecting the **BUY**  option allows you to purchase the pedal. Purchased pedals will appear in the “My Pedals” view.
5. From the “My Pedals” view, scroll to the pedal you would like to use then click the **LOAD**  button to load the pedal into the iStomp.
6. Wait for the prompt indicating the load is complete.

iStomp to iOS Device Connection

The iStomp connects to the iOS device via the included 30-pin to 8-pin DSC-iOS cable. Plug the 30-pin connector into the sync port on the iOS device. Next, align the 8-pin DIN connector arrow side up and plug into the iStomp's DSC download port.

Power must be provided to the iStomp using the included power supply in order to download pedals into the iStomp from the connected iOS device. Follow the instructions as outlined in the Quick Start on page 7.

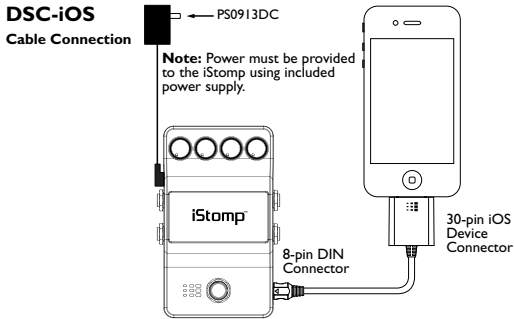

Audio Connections

The iStomp has stereo 1/4" audio inputs and outputs. The pedal that is loaded into the iStomp will determine which inputs and outputs are active. For mono in pedals, only IN 1 is active and can be used – IN 2 is disabled on all mono in pedals. From the Stomp Shop app, tap the **INFO**  button for the pedal to view its cable connection requirements. When using mono in pedals, both outputs will be active and can be used.

When stereo pedals are loaded into the iStomp, you have the option of using the pedal in a mono or stereo configuration. Therefore, you can use the IN 1 and OUT 1 connections (mono), the IN 1 and both OUT 1 and OUT 2 connections (mono in/stereo out), or both IN 1/IN 2 and OUT 1/OUT 2 connections (stereo in/stereo out). Connection diagrams are provided on the preceding pages.

Connection Diagrams

Mono In / Mono Out

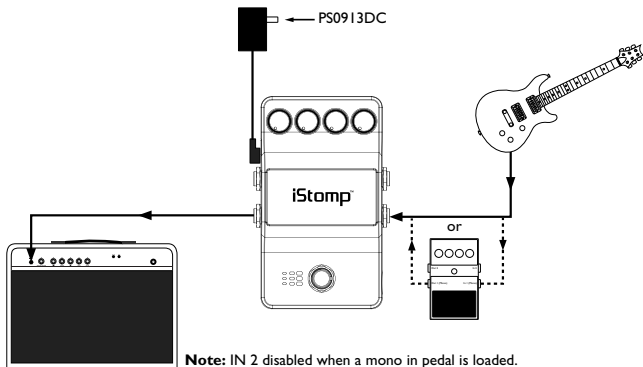

Mono In / Dual Mono or Stereo Out

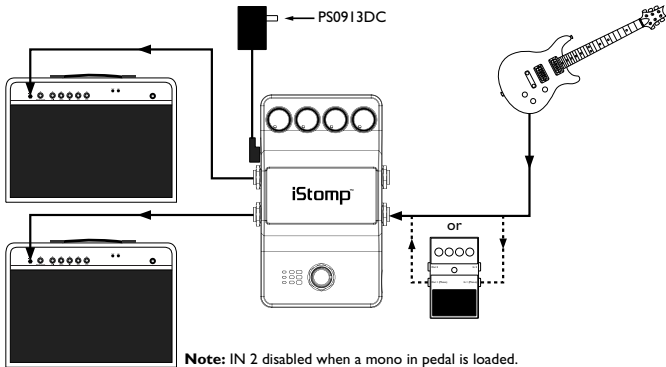

Mono or Stereo In / Stereo Out

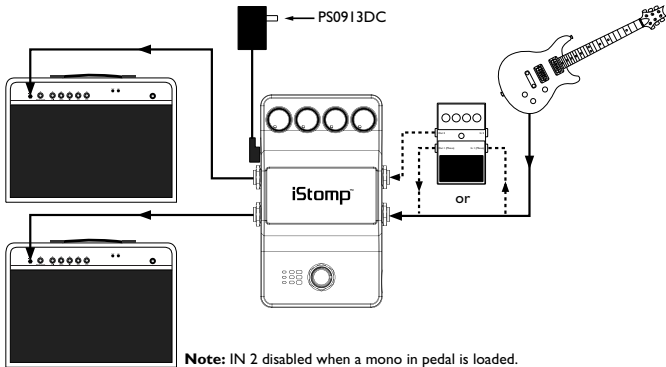

Delay Tap Tempo

In some of the delay pedals that the iStomp can be programmed with, the footswitch can be used as a tap tempo switch for setting the delay time during a live performance. Tap the **INFO**  button to see which delay pedals support Tap Tempo. To enable the Tap Tempo function, follow these steps:

1. Press and hold the **Footswitch** for at least 2 seconds. The **Indicator LED** will first light solid showing that the delay effect has been turned on and then it will begin flashing. The flashing indicates Tap Tempo mode is now active and the **Indicator LED** will flash at the current delay time's duration.
2. Tap the **Footswitch** at least two times to set a new delay time. The last two pedal tap intervals set the delay time. While Tap Tempo is active, the **TIME** knob can be used as a multiplier selector. A multiplier changes the repeat rate by a fixed multiple of the tap interval. There are three multiplier settings across the range of the knob.

From the minimum to maximum setting, they are:

- ♪ Eighth Note
- ♪. Dotted Eighth Note
- ♪ Quarter Note (1:1 tap reference)



Experiment with different settings to help you get the most from the delays iStomp has to offer.

3. To exit Tap Tempo mode, press and hold the **Footswitch** for at least 2 seconds until the **Indicator LED** stops flashing and lights solid again.

Once Tap Tempo mode is exited, the tapped delay time will remain active until the **TIME** knob is moved or the power is turned off.

Using The Stomp Shop App



TRY

The Stomp Shop lets you try pedals before you buy. The process is simple:

1. Connect your iOS device to the iStomp.
2. Select a pedal in the Stomp Shop app that you want to demo.
3. Tap the **TRY**  button and confirm downloading the demo.

The pedal will now download into the iStomp hardware and when complete you have a 5 minute demo time to try out the effect.* After the 5 minutes expire, the pedal will go into bypass and revert back to the last effect loaded from My Pedals.

***Note:** the iOS device must remain connected to the iStomp hardware during the demo period. Disconnecting it will terminate the demo.



INFO

INFO



The INFO button can be tapped to present a window with a description of the pedal, knob controls information, and recommended input/output routing.





PLAY

Curious what a specific Stomp Shop pedal sounds like? Each pedal includes a sound clip to give you an idea what sounds the pedal can generate.

1. Tap the **PLAY**  button and the sound clip will begin playing.
2. Tapping on the effect image will toggle the effect on and off so you can hear what the sound clip sounds like with and without the effect.
3. Tap the **STOP**  button to stop the sound clip playback.



BUY

Buying pedals from the Stomp Shop is easy:

1. Select a pedal in the Stomp Shop app you want to buy.
2. Tap the **BUY**  button and confirm your purchase.

The pedal will now download into the My Pedals view of the Stomp Shop app indicating that you now own it. From here you can download the pedal into the iStomp hardware.



LOAD

Changing your iStomp pedal takes less than a minute.

1. Connect your iOS device to the iStomp.
2. In the My Pedals view of the app, select the pedal that you want to download.
3. Tap the **LOAD**  button and confirm downloading the pedal.



The download takes approximately 30 seconds. When complete, the pedal will be in a bypassed state. You can then turn on the effect and begin using it. *

***Note:** After the download has completed, it is recommended to turn all knobs fully counter-clockwise before turning the effect on, after which you can then enable the effect and adjust the knobs to the desired settings.



LED

You can customize the LED color for any effect you load into the iStomp hardware.

1. Connect your iOS device to the iStomp
2. Select a pedal that you own in the My Pedals view.
3. Tap the **LED**  button and the LED Color window will appear.
4. Tap on the color you want to set the LED to be. You will see the colors change on the iStomp hardware as you select them.
5. Tap the **Close**  icon to close the LED Color window.

iStomp Labels

Included with the iStomp are reusable labels for some of the most popular pedal effects offered in the Stomp Shop. When you buy and download any of these pedals to your iStomp hardware, you can customize the pedal by adding the corresponding effect label to the top of the chassis.

For instance, the iStomp comes with the Redline™ overdrive preloaded. If you want to keep the Redline effect, just peel the Redline label away from the backing and place it in the recessed area over the iStomp logo. We have also included 3 blank labels that you can add your own personal touch to.

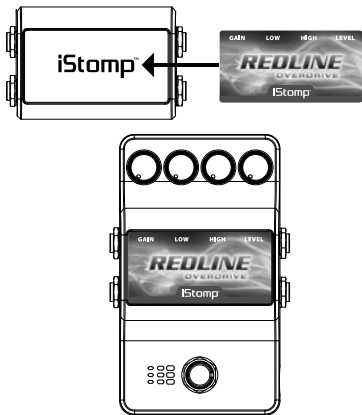

Specifications

Controls:	On/Off Footswitch, 4 Control Knobs
Audio Jacks:	Input 1 (Mono), Input 2, Output 1 (Mono), Output 2
Connector Cable:	Proprietary DSC-iOS Cable
Input Impedance:	500 kOhm (mono), 1 MOhm (stereo)
Output Impedance:	100 Ohms
Frequency Response:	20 Hz – 20 kHz +/- 1.7 dB (through DSP)
SNR:	>101dB (A weighted)
Power Consumption:	150 mA @ 9 VDC
Power Supply:	PS0913DC-01 (US, JA, EU) PS0913DC-02 (AU, UK)
Dimensions:	4.9" (L) x 3.15" (W) x 1.65" (H)
Weight:	0.6 lbs.



DigiTech® is a registered trademark of Harman

Copyright - Harman
Printed in China

iStomp Downloadable Pedal
Owner's Manual - 5001814-C

8760 South Sandy Parkway
Sandy, Utah 84070
PH (801) 566-8800
FAX (801) 566-7005
www.digitech.com

GreenEdge
by HARMAN
Designed in the USA