

Traps Drums

A400



**Thank you for purchasing
a Traps A400 drum kit.**

**Please check the contents before
continuing to build your new drum kit**

www.trapsdrums.com

Contents of kit



Also included but not shown
Drum stool
Pair of drum sticks



**13" high hats, 14" crash
and 18" ride**



Instructions for assembly

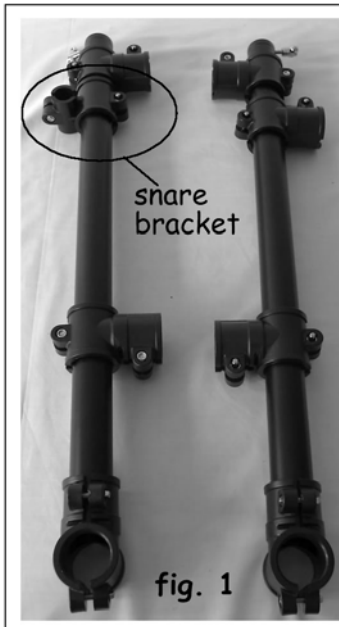

Step 1.

Take the two upright tubes (identified as the medium length tubes with the screw locks in) and assemble them as per fig.1. Make sure they are a mirror image of each other and that you configure the snare bracket (indicated in fig. 1) on the correct side for either right handed or left handed use.

fig. 1

Step 2

Take one of the shortest lengths of tube and fit a foot to one end. Now slide the tube through the bottom bracket on one of the uprights assembled in step 1.

Fit another foot to the other end. Now align the upright to be in the centre as shown in fig.2 Now tighten the bracket up. Repeat the same process for the second upright.

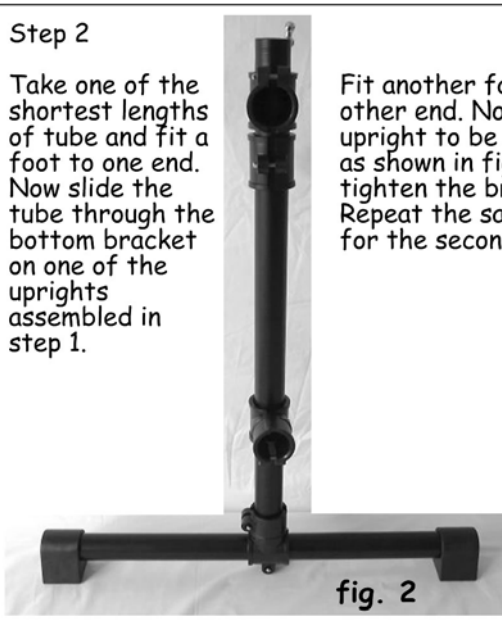

fig. 2



fig. 3

Step 3.

Loosely fix two brackets to the remaining bar (longest tube)



fig. 5

Step 5.

Assemble the bass drum into position as shown in fig. 5. (Make sure the tab on the bottom of the bass drum is towards you) This process is best achieved with the 2 mounting brackets not done up too tightly so that they can be adjusted to suit. Also make sure that the wing nuts on the bass drum are loose to allow the drum to slide on to the hex drum mounts. When the drum is correctly positioned tighten the brackets on the frame and the wing nuts on the bass drum



Detail view of one of the wing nuts on the bass drum

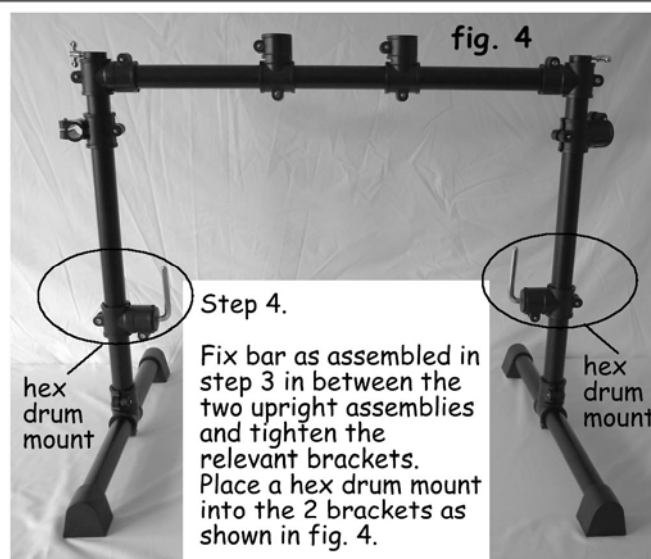

fig. 4

Step 4.

Fix bar as assembled in step 3 in between the two upright assemblies and tighten the relevant brackets. Place a hex drum mount into the 2 brackets as shown in fig. 4.

hex drum mount

hex drum mount

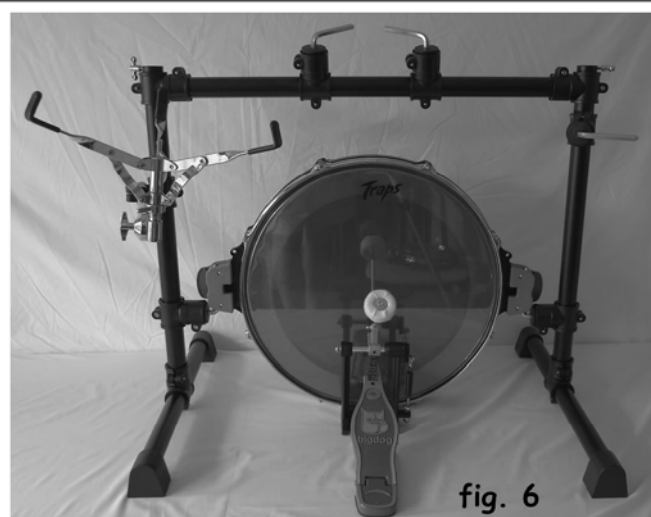

fig. 6

Step 6.

Fix the bass drum pedal and snare drum hardware as shown in fig. 6.

The bass drum pedal is fixed to the tab at the bottom of the bass drum by tightening up the pedal clamp wing nut as shown in fig. 7. Also fit the remaining 3 hex drum mounts as shown in fig. 6

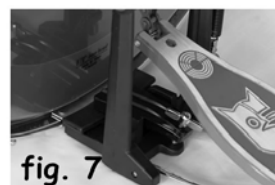

fig. 7



fig. 8

Step 7.

Attach the 2 cymbal arms as shown in fig. 8



fig. 9

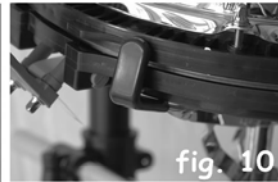

fig. 10

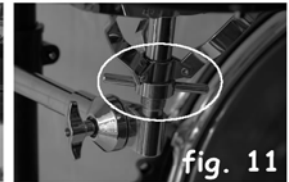

fig. 11

Step 8.

Fit the snare drum to the snare drum hardware as shown in fig. 9
 Make sure the snare is correctly located in the centre of the 3 grips (see fig. 10) then tighten the clamp using the wing nut in fig. 11.



Step 9.

Slide the 3 toms on to their respective hex drum mounts and tighten their wing nuts.
 Finish the kit by attaching the cymbals and making up the supplied high hat stand.
 Now adjust the position of the drums to suit your style.
 Tune your heads.

You should now be ready to start drumming.
 We hope your new Traps kit will bring you many years of pleasure.

Please check out the website for news and information on additional products from Traps

www.trapsdrums.com