

XENYX 1622FX 1832FX 2222FX 2442FX

User's Manual

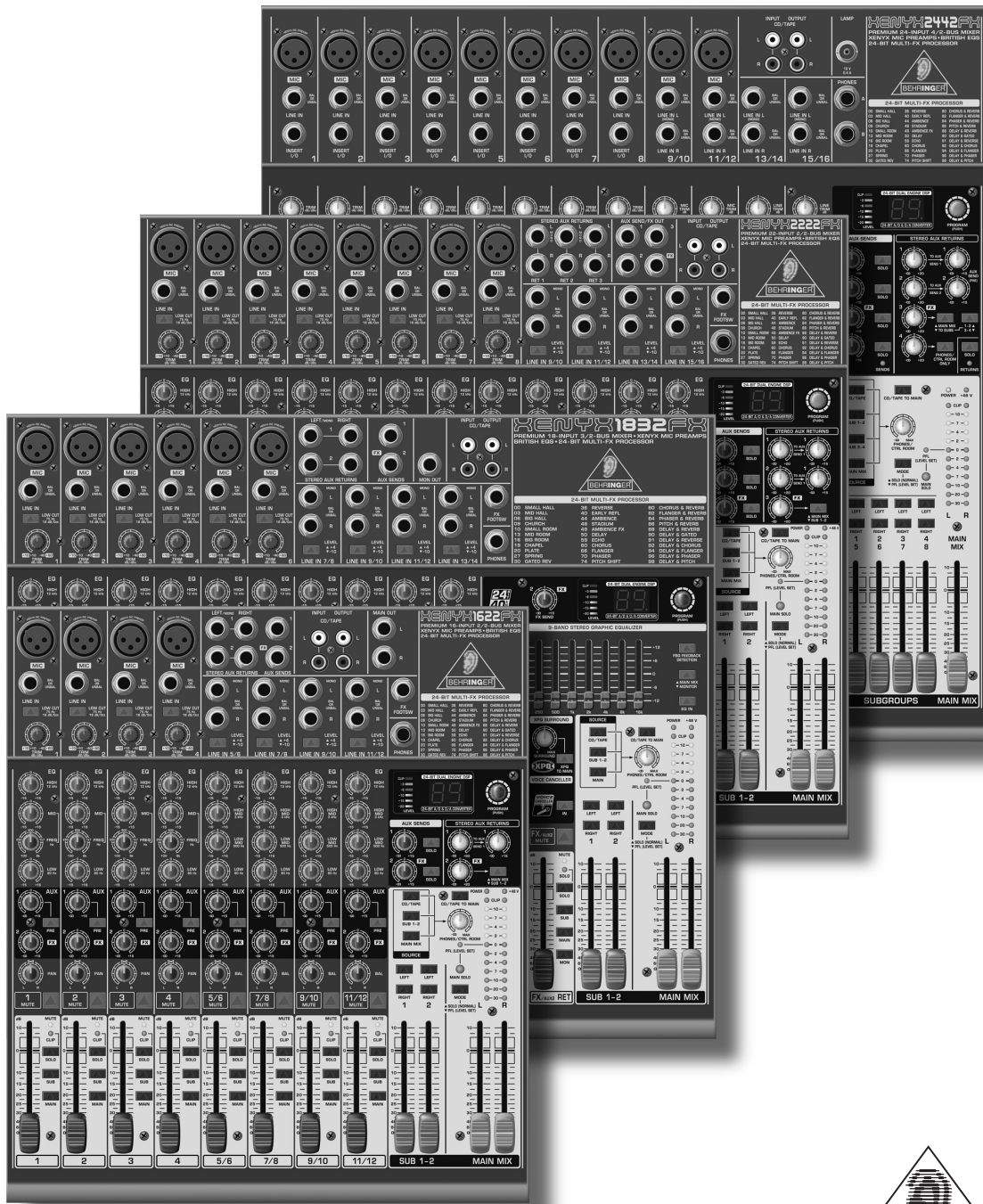

Version 1.0 January 2006



www.behringer.com



IMPORTANT SAFETY INSTRUCTIONS



CAUTION: To reduce the risk of electric shock, do not remove the top cover (or the rear section). No user serviceable parts inside; refer servicing to qualified personnel.

WARNING: To reduce the risk of fire or electric shock, do not expose this appliance to rain and moisture. The apparatus shall not be exposed to dripping or splashing and no objects filled with liquids, such as vases, shall be placed on the apparatus.



This symbol, wherever it appears, alerts you to the presence of uninsulated dangerous voltage inside the enclosure—voltage that may be sufficient to constitute a risk of shock.



This symbol, wherever it appears, alerts you to important operating and maintenance instructions in the accompanying literature. Please read the manual.

DETAILED SAFETY INSTRUCTIONS:

- 1) Read these instructions.
- 2) Keep these instructions.
- 3) Heed all warnings.
- 4) Follow all instructions.
- 5) Do not use this apparatus near water.
- 6) Clean only with dry cloth.
- 7) Do not block any ventilation openings. Install in accordance with the manufacturer's instructions.
- 8) Do not install near any heat sources such as radiators, heat registers, stoves, or other apparatus (including amplifiers) that produce heat.
- 9) Do not defeat the safety purpose of the polarized or grounding-type plug. A polarized plug has two blades with one wider than the other. A grounding type plug has two blades and a third grounding prong. The wide blade or the third prong are provided for your safety. If the provided plug does not fit into your outlet, consult an electrician for replacement of the obsolete outlet.
- 10) Protect the power cord from being walked on or pinched particularly at plugs, convenience receptacles, and the point where they exit from the apparatus.
- 11) Only use attachments/accessories specified by the manufacturer.
- 12) Use only with the cart, stand, tripod, bracket, or table specified by the manufacturer, or sold with the apparatus. When a cart is used, use caution when moving the cart/apparatus combination to avoid injury from tip-over.



13) Unplug this apparatus during lightning storms or when unused for long periods of time.

14) Refer all servicing to qualified service personnel. Servicing is required when the apparatus has been damaged in any way, such as power supply cord or plug is damaged, liquid has been spilled or objects have fallen into the apparatus, the apparatus has been exposed to rain or moisture, does not operate normally, or has been dropped.

15) **CAUTION** - These service instructions are for use by qualified service personnel only. To reduce the risk of electric shock do not perform any servicing other than that contained in the operation instructions unless you are qualified to do so.

FOREWORD



Dear Customer,
I'm sure you're one of those people who have devoted themselves body and soul to your chosen area and no doubt this has made you an expert in your field.

Well, for over 30 years, my passion has been music and electronics. This not only led me to establish BEHRINGER, but also enabled me to share my enthusiasm with our employees. During all the years I've been involved with studio technology and end users, I have

developed a feel for the things that really count, such as sound quality, reliability and ease of use. What is more, I have always had the desire to test the boundaries of what is technically feasible.

It was precisely this motivation that prompted me to start work on a new series of mixing consoles. Since our EURORACKs had already set new standards world-wide, I knew the development objectives behind the next generation of mixing consoles had to be especially ambitious.

Thus, the concept and design of the new XENYX mixing consoles bear my signature. The design work, the entire circuit diagram and PCB development, and even the mechanical concepts are my own work. I carefully selected each individual component - with the aim of pushing the mixing consoles' combining analog and digital technologies to their limits.

My vision was to enable you, the user, to give free rein to your true potential and creativity. The result is mixing consoles that combine incredible performance with intuitive operability. They cannot fail to impress with their extremely flexible routing possibilities plus a fantastic wealth of functions. Innovative technologies, such as the completely new XENYX Mic Preamps and the "British" EQs, guarantee optimum sound quality. And extraordinarily high-quality components provide unrivalled reliability, even under extreme loads.

Thanks to the quality and ease of use of your new XENYX mixing console you'll soon come to appreciate that I, both personally and in my capacity as musician and sound engineer, put you, the end user, first and that these products were only possible because of the passion and the attention to detail that went into them.

Thank you for the confidence you have placed in us by purchasing the XENYX mixing console. I should also like to thank all those who, with their personal commitment and passion, have helped me create this impressive series of mixing consoles.

Kindest regards,

Uli Behringer

TABLE OF CONTENTS

11. INTRODUCTION 4

- 1.1 General mixing console functions 4
- 1.2 The user's manual 5
- 1.3 Before you get started 5
 - 1.3.1 Shipment 5
 - 1.3.2 Initial operation 5
 - 1.3.3 Online registration 5

2. CONTROL ELEMENTS AND CONNECTORS 5

- 2.1 Mono channels 5
 - 2.1.1 Microphone and line inputs 5
 - 2.1.2 Equalizer 6
 - 2.1.3 Monitor and effects busses (Aux sends) 6
 - 2.1.4 Routing switch, PAN, SOLO and channel fader... 7
- 2.2 Stereo channels 7
 - 2.2.1 Channel inputs 7
 - 2.2.2 Equalizer stereo channels 7
 - 2.2.3 Aux sends stereo channels 7
 - 2.2.4 Routing switch, solo and channel fader 8
- 2.3 Interface panel and main section 8
 - 2.3.1 MON control, aux sends 1, 2 and 3 (FX) 8
 - 2.3.2 Aux send jacks 8
 - 2.3.3 Stereo aux return connectors 8
 - 2.3.4 The monitor section of the 1832FX 9
 - 2.3.5 Stereo aux return control 9
 - 2.3.6 Supplement to 1832FX 10
 - 2.3.7 XPQ Surround function (1832FX only) 10
 - 2.3.8 CD/Tape input, CD/tape output 10
 - 2.3.9 Lamp socket (2442FX only) 11
 - 2.3.10 Level meter and monitoring 11
 - 2.3.11 Subgroups and main mix fader 12

3. GRAPHIC 9-BAND EQUALIZER (1832FX only) 12

4. DIGITAL EFFECTS PROCESSOR 12

5. REAR PANEL CONNECTORS 13

- 5.1 Main mix outputs, insert points and control room outputs 13
- 5.2 Subgroup outputs 13
- 5.3 Inserts 13
- 5.4 Direct outputs (2442FX only) 13
- 5.5 Voltage supply, phantom power supply and fuse 13

6. INSTALLATION 14

- 6.1 Rack mounting 14
- 6.2 Cable connections 14
 - 6.2.1 Audio connections 14

7. SPECIFICATIONS 16

8. WARRANTY 17



1. INTRODUCTION

Congratulations! In purchasing the BEHRINGER XENYX you have acquired a mixer whose small size belies its incredible versatility and audio performance.

The XENYX Series represents a milestone in the development of mixing console technology. With the new XENYX microphone preamps including phantom power as an option, balanced line inputs and a powerful effects section, the mixing consoles in the XENYX Series are optimally equipped for live and studio applications. Owing to state-of-the-art circuitry your XENYX console produces a warm analog sound that is unrivalled. With the addition of the latest digital technology these best-in-class consoles combine the advantages of both analog and digital technology.

XENYX Mic Preamp

The microphone channels feature high-end XENYX Mic Preamps that compare well with costly outboard preamps in terms of sound quality and dynamics and boast the following features:

- ▲ 130 dB dynamic range for an incredible amount of headroom
- ▲ A bandwidth ranging from below 10 Hz to over 200 kHz for crystal-clear reproduction of even the finest nuances
- ▲ The extremely low-noise and distortion-free circuitry guarantees absolutely natural and transparent signal reproduction
- ▲ They are perfectly matched to every conceivable microphone with up to 60 dB gain and +48 volt phantom power supply
- ▲ They enable you to use the greatly extended dynamic range of your 24-bit/192-kHz HD recorder to the full, thereby maintaining optimal audio quality

„British EQ“

The equalizers used for the XENYX Series are based on the legendary circuitry of top-notch consoles made in Britain, which are renowned throughout the world for their incredibly warm and musical sound character. Even with extreme gain settings these equalizers ensure outstanding audio properties.

Multi-effects processor



Additionally, your XENYX mixing console has an effects processor with 24-bit A/D and D/A converters included, which gives you 100 presets producing first-class reverb, delay and modulation effects plus numerous multi-effects in excellent audio quality.



The XENYX mixing consoles are equipped with a state-of-the-art switched-mode power supply (SMPS). Unlike conventional circuitry an SMPS provides an optimum supply current regardless of the input voltage. And thanks to its considerably higher efficiency a switched-mode power supply uses less energy than conventional power supplies.

FBQ Feedback Detection System



The FBQ Feedback Detection System integrated into the graphic EQ of your 1832FX is one of this mixer's most outstanding features.

This ingenious circuitry lets you immediately recognize and eliminate feedback frequencies. The FBQ Feedback Detection System uses the LEDs in the frequency band faders of the graphic EQ to indicate the critical frequencies. This way, what once used to be a labor-intensive search for feedback frequencies is now an activity that even a child could master.



Voice Cancellor

We have added another useful feature to the XENYX 1832FX: the Voice Cancellor.

The Voice Cancellor is a filter circuitry that filters out vocal portions from a track. Therefore, this mixing console is

ideally suited for use as a karaoke machine. This feature is also an optimal solution for singers who need accompanying music for their rehearsals.

USB/Audio interface

The USB interface supplied with the unit is a perfect match for the XENYX Series and serves as a powerful recording interface to your PC or MAC®. It supports the digital transmission of signals on up to four channels with max. 48 kHz and extremely low latency. When wired to the CD/TAPE INPUT and OUTPUT connectors, the interface transfers the stereo mix from the console directly to a computer. Both the recording signal and the playback signal from the computer can be monitored at the same time. In this way, you can use several recording runs to produce complete multi-track recordings.

CAUTION!

 We should like to draw your attention to the fact that extreme volumes may damage your hearing and/or your headphones or loudspeakers. Turn the MAIN MIX faders and phones control in the main section fully down before you switch on the unit. Always be careful to set the appropriate volume.

1.1 General mixing console functions

A mixing console fulfils three main functions:

▲ Signal processing:

Preamplification

Microphones convert sound waves into voltage that has to be amplified several-fold; then, this voltage is turned into sound that is reproduced in a loudspeaker. Because microphone capsules are very delicate in their construction, output voltage is very low and therefore susceptible to interference. Therefore, mic signal voltage is amplified directly at the mixer input to a higher signal level that is less prone to interference. This higher, interference-safe signal level has to be achieved through amplification using an amplifier of the highest quality in order to amplify the signal and add as little noise to it as possible. The XENYX Mic Preamp performs this role beautifully, leaving no traces of noise or sound coloration. Interference that could take place at the preamplification level could affect signal quality and purity, and would then be passed on to all other devices, resulting in inaccurate sounding program during recording or playback.

Level-setting

Signals fed into the mixer using a DI-box (Direct Injection) or the output of a sound card or a keyboard, often have to be adjusted to the operating level of your mixing console.

Frequency response correction

Using the equalizers found in each channel strip, you can simply, quickly and effectively adjust the way a signal sounds.

Effects mixing

In addition to the effects processor contained in your mixer, using the insert connectors on the mono channels and both aux busses lets you insert additional signal processors into your signal path.

▲ Signal distribution:

Individual signals adjusted at each channel strip are laid out at the aux sends and returns, and are either fed into external effects processors or fed back to the internal effects processor. Then, the signals are brought back into the main mix either via the aux return connectors or via direct internal wiring. The mix for the on-stage musicians is also created using the aux sends (monitor mix). Similarly, for example, signals for recording equipment, power amplifiers, headphones and 2-track outputs can also be taken.



▲ **Mix:**

All other mixing console functions fall under this vital category. Creating a mix means primarily adjusting the volume levels of individual instruments and voices to one another as well as giving them the appropriate weight within the overall frequency spectrum. Likewise, you'll have to sensibly spread individual voices across the stereo image of a signal. At the end of this process, adjusting the level of the entire mix to other equipment in the signal path is required (e. g. recorder/crossover/amplifier).

The control surface of BEHRINGER mixing consoles is optimized in such a way that these functions become easy to fulfil while the signal path remains simple to follow.

1.2 The user's manual

The user's manual is designed to give you both an overview of the controls, as well as detailed information on how to use them. In order to help you understand the links between the controls, we have arranged them in groups according to their function. If you need to know more about specific issues, please visit our website at <http://www.behringer.com>. Additional information and explanations about various music industry/audio technology terminology can be found on individual product pages as well as in the glossary.

👉 **The block diagram supplied with the mixing console gives you an overview of the connections between the inputs and outputs, as well as the associated switches and controls.**

1.3 Before you get started

1.3.1 Shipment

Your mixing console was carefully packed in the factory to guarantee safe transport. Nevertheless, we recommend that you carefully examine the packaging and its contents for any signs of physical damage, which may have occurred during transit.

👉 **If the unit is damaged, please do NOT return it to us, but notify your dealer and the shipping company immediately, otherwise claims for damage or replacement may not be granted.**

1.3.2 Initial operation

Be sure that there is enough space around the unit for cooling purposes and to avoid over-heating please do not place your mixing console on high-temperature devices such as radiators or power amps. The console is connected to the mains via the supplied cable. The console meets the required safety standards. Blown fuses must only be replaced by fuses of the same type and rating.

👉 **Please note that all units must be properly grounded. For your own safety, you should never remove any ground connectors from electrical devices or power cables, or render them in-operative.**

👉 **Please ensure that only qualified people install and operate the mixing console. During installation and operation, the user must have sufficient electrical contact to earth, otherwise electrostatic discharges might affect the operation of the unit.**

1.3.3 Online registration

Please do remember to register your new BEHRINGER equipment right after your purchase by visiting www.behringer.com (alternatively www.behringer.de) and kindly read the terms and conditions of our warranty carefully.

Should your BEHRINGER product malfunction, our goal is to have it repaired as quickly as possible. To arrange for warranty service, please contact the retailer from whom the equipment was purchased. Should your BEHRINGER dealer not be located in your vicinity, you may directly contact one of our subsidiaries. Corresponding contact information is included in the original equipment packaging (Global Contact Information/European Contact Information). Should your country not be listed, please contact the distributor nearest you. A list of distributors can be found in the support area of our website (www.behringer.com).

Registering your purchase and equipment with us helps us process your repair claims quicker and more efficiently.

Thank you for your cooperation!



2. CONTROL ELEMENTS AND CONNECTORS

This chapter describes the various control elements of your mixing console. All controls, switches and connectors will be discussed in detail.

2.1 Mono channels

2.1.1 Microphone and line inputs



Fig. 2.1: Connectors and controls of mic/line inputs

MIC

Each mono input channel offers a balanced microphone input via the XLR connector and also features switchable +48 V phantom power supply for condenser microphones. The XENYX preamps provide undistorted and noise-free gain as is typically known only from costly outboard preamps.

👉 **Please mute your monitor system before you switch on phantom power. Otherwise potentially damaging thumps will be sent to your speakers. Please also note the instructions in chapter 5.5 "Voltage supply, phantom power and fuse".**

LINE IN

Each mono input also has a balanced line input on a 1/4" jack. You can also connect unbalanced devices using mono jacks to these inputs.

👉 **Please remember that you can use either the microphone input or the line input of a channel, but not both at the same time!**

XENYX 1622FX/1832FX/2222FX/2442FX

INSERT

Insert points enable the processing of a signal with dynamic processors or equalizers. They are sourced pre-fader, pre-EQ and pre-aux send. Detailed information on using insert points can be found in chapter 5.3.

 Unlike the 2442FX, the 1622FX, 1832FX and 2222FX have their insert points located on the rear of the console.

TRIM

Use the *TRIM* control to adjust the input gain. This control should always be turned fully counter-clockwise whenever you connect or disconnect a signal source to one of the inputs.

The scale has 2 different value ranges: the first value range (+10 to +60 dB) refers to the MIC input and shows the **amplification** for the signals fed in there.

The second value range (+10 to -40 dB) refers to the line input and shows its **sensitivity**. The settings for equipment with standard line-level signals (-10 dBV or +4 dBu) look like this: While the TRIM control is turned all the way down, connect your equipment. Set the TRIM control to the external devices' standard output level. If that unit has an output signal level display, it should show 0 dB during signal peaks. For +4 dBu, turn up TRIM slightly, for -10 dBV a bit more. Fine-tuning of a signal being fed in is done using the level meter. To route the channel signal to the level meter, you have to press the SOLO switch and set the MODE switch in the main section to PFL (LEVEL SET).

Using the TRIM control, drive the signal to the 0-dB mark. This way you have a vast amount of drive headroom for use with very dynamic signals. The CLIP display should light up only rarely, preferably never. While fine-tuning, the equalizer should be set to neutral.

LOW CUT

Additionally, the mono channels of the mixing consoles have a high-slope *LOW CUT* filter for eliminating unwanted, low-frequency signal components (75 Hz, 18 dB/octave).

2.1.2 Equalizer

All mono input channels have a 3-band equalizer with semi-parametric mid bands. All bands provide boost or cut of up to 15 dB. In the central position, the equalizer is off (flat).

The circuitry of the British EQs is based on the technology used in the best-known top-of-the-line consoles and providing a warm sound without any unwanted side effects. The result are extremely musical equalizers which, unlike simple equalizers, cause no side effects such as phase shifting or bandwidth limitation, even with extreme gain settings of ±15 dB.



All models

Fig. 2.2: Equalizer of the input channels

The upper (HIGH) and the lower (LOW) bands are shelving filters that increase or decrease all frequencies above or below their cut-off frequency. The cut-off frequencies of the upper and lower bands are 12 kHz and 80 Hz respectively. For the mid range, the console features a semi-parametric equalizer with a filter quality (Q) of 1 octave, tunable from 100 Hz to 8 kHz. Use

the MID control to set the amount of boost or cut, and the FREQ control to determine the central frequency.

2.1.3 Monitor and effects busses (Aux sends)

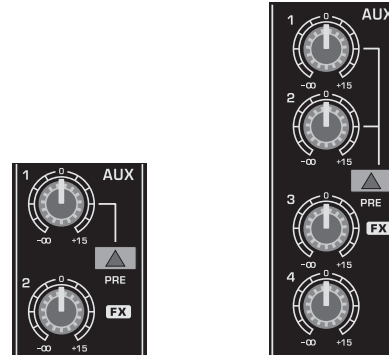

XENYX1622FX

XENYX2442FX

Fig. 2.3: Aux Send control MON and FX in the channel strips

Monitor and effects busses (AUX sends) source their signals via a control from one or more channels and sum these signals to a so-called bus. This bus signal is sent to an aux send connector (for monitoring applications: MON OUT) and then routed, for example, to an active monitor speaker or external effects device. In the latter case, the effects return can then be brought back into the console via the aux return connectors.

All monitor and effects busses are mono, are tapped into post EQ and offer amplification of up to +15 dB.

Pre-fader/post-fader

When using effects on a channel signal, it is usual to have the aux send post fader so that the balance between effect and dry signal stays constant even when the channel fader is altered. If this were not the case, the effects signal of the channel would remain audible even when the channel fader is turned all the way down. For monitoring, the aux sends are generally pre-fader, i.e. they operate independently of the position of the channel fader.

PRE

When the *PRE* switch is pressed down, the associated aux send is taken pre-fader.

FX

The aux send marked *FX* offers a direct route to the built-in effects processor and is therefore post-fader and post-mute. Please refer to chapter 4 "DIGITAL EFFECTS PROCESSOR" for detailed information.

 If you are using the built-in effects processor, make sure that STEREO AUX RETURN 3 has nothing plugged into it (2442FX and 2222FX), otherwise the internal effects return will be muted. This is not relevant if you use the FX OUT jack to drive an external effects device.

 1622FX and 1832FX: On these consoles, the above note refers to the STEREO AUX RETURN 2 jacks as these models do not have a dedicated effect output.

2.1.4 Routing switch, PAN, SOLO and channel fader

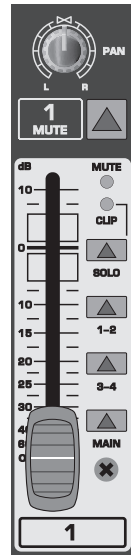

XENYX2442FX

Fig. 2.4: The panorama and routing controls and the channel fader

PAN

The *PAN* control determines the position of the channel signal within the stereo image. When working with subgroups, you can use the *PAN* control to assign the signal to just one output, which gives you additional flexibility in recording situations. For example, when routing to subgroups 3 and 4, panning hard left will route the signal to group output 3 only, and panning hard right will route to group output 4 only.

MUTE

The *MUTE* switch breaks the signal path pre-channel fader, hence muting that channel in the main mix. The aux sends which are set to post-fader are likewise muted for that channel, while the pre-fader monitor paths remain active irrespective of whether the channel is muted or not.

MUTE LED

The *MUTE* LED indicates a muted channel.

CLIP-LED

The *CLIP*-LED lights up when the input signal is driven too high. If this happens, back off the *TRIM* control and, if necessary, check the setting of the channel EQ.

SOLO

The *SOLO* switch is used to route the channel signal to the solo bus (Solo In Place) or to the PFL bus (Pre Fader Listen). This enables you to listen to a channel signal without affecting the main output signal. The signal you hear is taken either before the pan control (PFL, mono) or after the pan and channel fader (Solo, stereo) (cf. chap. 2.3.10 "Level meters and monitoring").

SUB (1-2 and 3-4)

The *SUB* switch routes the signal to the corresponding subgroups. The 2442FX has 4 subgroups (1-2 and 3-4).

MAIN

The *MAIN* switch routes the signal to the main mix bus.

The channel fader determines the channel's volume in the main mix (or submix).

2.2 Stereo channels

2.2.1 Channel inputs

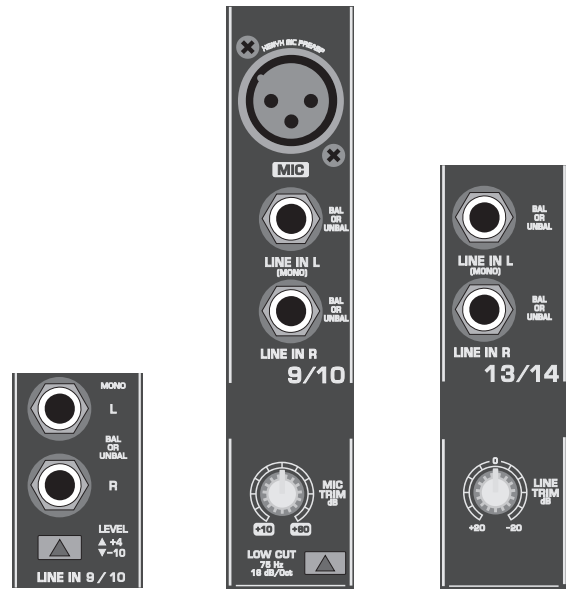

XENYX2222FX

XENYX2442FX

XENYX2442FX

Fig. 2.5: The various stereo channel inputs

Each stereo channel has two balanced line level inputs on jacks for left and right channels. Channels 9/10 and 11/12 on the 2442FX feature an additional XLR microphone jack with phantom power. If only the left jack (marked "L") is used, the channel operates in mono. The stereo channels are designed to handle typical line level signals, and, depending on model, have a level switch (+4 dBu or -10 dBV) and/or a line TRIM control. Both jack inputs will also accept unbalanced connectors.

LOW CUT and MIC TRIM

These two control elements operate on the XLR connectors of the 2442FX, and are used to filter out frequencies below 75 Hz (LOW CUT) and to adjust microphone levels (MIC TRIM).

LINE TRIM

Use this control to adjust the line signal levels on channels 13-16 (2442FX only).

LEVEL

For level matching, the stereo inputs on the 1622FX, 1832FX and 2222FX have a *LEVEL* switch to select between +4 dBu and -10 dBV. At -10 dBV (homerecording level), the input is more sensitive than at +4 dBu (studio level).

2.2.2 Equalizer stereo channels

The stereo channels contain a stereo EQ section. The cut-off frequencies of the high and low bands are 12 kHz and 80 Hz respectively, while the center frequencies of the high-mid and low-mid bands are 3 kHz and 500 Hz respectively. The HIGH and LOW controls have the same characteristics as the EQ in the mono channels. Both mid range bands are of the peak filter type. A stereo EQ is superior to two mono EQs on a stereo signal as two separate EQs will usually result in a discrepancy between left and right channels.

2.2.3 Aux sends stereo channels

In principle, the aux sends of the stereo channels function the same way as those of the mono channels. As the aux sends are mono, the send from a stereo channel is first summed to mono before it reaches the aux bus.



XENYX 1622FX/1832FX/2222FX/2442FX

2.2.4 Routing switch, solo and channel fader



Fig. 2.6: Balance control and mute switch

BAL

The BAL(ANCE) control has a similar function to the PAN control in the mono channels.

The balance control determines the levels of the left and right input signals relative to each other before both signals are routed to the left/right main mix bus (or odd/even subgroup).

The remaining control elements in the stereo channels perform the same functions as their counterparts in the mono channels (MUTE switch, MUTE and CLIP LEDs, SOLO switch, SUB and MAIN switches and channel fader).

2.3 Interface panel and main section

Where it was useful to trace the signal flow from top to bottom in order to gain an understanding of the channel strips, we now look at the mixing console from left to right. The signals are, so to speak, collected from the same point on each of the channel strips and then routed to the main section all together.

2.3.1 MON control, aux sends 1, 2 and 3 (FX)

Turning up the AUX 1 control in a channel routes the signal to the aux send bus 1.

As the 1832FX is equipped with an additional monitor path, its first aux control in the channel strips is named MON. The console also has a dedicated master fader (MON SEND) for this aux path.

AUX SEND 1, 2 and 4

The AUX SEND 1 control governs the master send level of the mix created by the individual channel AUX 1 sends.

Likewise, the AUX SEND 2 control is the master control for the aux 2 bus, and AUX SEND 4 controls the AUX 4 bus.

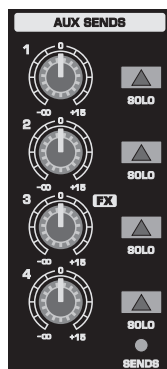

XENYX2442FX

Fig. 2.7: The AUX SEND controls of the main section!

AUX SEND 3 (FX)

The FX control determines the signal level for effects processing, i.e. regulates the level to an external (or the internal) effects device.

1622FX and 1832FX: On these consoles, this function is performed by the AUX SEND 2 control (FX).

SOLO

You can use the SOLO switch to separately monitor the aux sends via the CONTROL ROOM/PHONES outputs and check these with the level meters.

If you want to monitor the signal of just one AUX bus, none of the other SOLO SWITCHES should be pressed and the MODE switch should be in the SOLO position (not depressed).

2.3.2 Aux send jacks

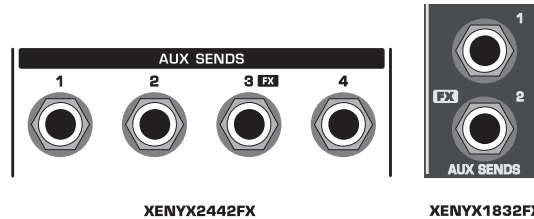

Fig. 2.8: Aux send jacks

AUX SEND jacks

The AUX SEND jack should be used when hooking up a monitor power amp or active monitor speaker system. The relevant aux path should be set pre-fader.

On the 2222FX, aux send 1 is hard wired as pre-fader and hence called MON. Model 1832FX has a dedicated monitor output (MON OUT jack), cf. chapter 2.3.4.

As already mentioned, the aux sends in the channels—if set post-fader—can be used to connect to external effects devices.

AUX SEND (FX)

The AUX SEND (FX) jack carries the master aux mix (from the channel's FX controls). You can connect this to an external effects device to process the FX bus. The processed signal can then be brought from the effects device back into the STEREO AUX RETURN jacks.

2.3.3 Stereo aux return connectors

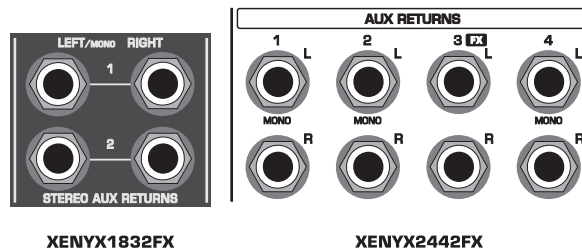

Fig. 2.9: The aux return connectors

On the 2222FX, 1832FX and 1622FX the STEREO AUX RETURN jacks are located on the front panel of the unit.

STEREO AUX RETURN

The STEREO AUX RETURN 1 jacks generally serve as the return for the effects mix (created using the post-fader aux sends) by connecting the output of an external effects device. If only the left jack is connected, the AUX RETURN is automatically switched to mono.

You can also use these jacks as additional line inputs.

All stereo aux returns are balanced, but can of course also be used with unbalanced connectors. If you use an aux send for monitoring, the associated unused stereo aux returns are available for other line level signals (e.g. keyboards).

A signal fed into the stereo return jacks can be output via an aux send jack. More information on this can be found in chapter 2.3.5 "STEREO AUX RETURN 1/2 (TO AUX SEND)".

STEREO AUX RETURN FX

The STEREO AUX RETURN FX jacks accept the effects mix

return (created using the channel FX sends). If these jacks are already in use as additional inputs, you can route the effects signal back into the console via a different channel. The advantage of this is that you can now use that channel's EQ on the effects return signal.

☞ In this instance, the FX control of the channel being used as an effects return should be turned fully counterclockwise, otherwise feedback problems could occur!

☞ If you wish to use the internal effects processor, do not plug any connectors into the STEREO AUX RETURN FX jacks, unless you want to tap the processed signal via the FX OUT (2222FX and 2442FX only).

2.3.4 The monitor section of the 1832FX

One of the ways that the 1832FX differs from the other models of this series is that it has a separate monitor output.



XENYX1832FX

Fig. 2.10: Monitor output of the 1832FX

The first aux send (MON) on this console is used to set up the monitor mix from the channels and route it to the *MON SEND* fader.

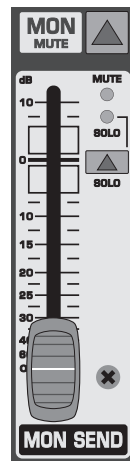

XENYX1832FX

Fig. 2.11: Monitor fader of the 1832FX

MUTE

Press the *MUTE* switch to mute the monitor send.

SOLO

The *SOLO* switch routes the monitor send to the solo bus (post-fader and post-mute) or to the PFL bus (pre-fader and pre-mute). The position of the *MODE* switch in the main section determines which of the buses is selected.

2.3.5 Stereo aux return control

STEREO AUX RETURN 1

The *STEREO AUX RETURN 1* control determines the level of this signal in the main mix. If *STEREO AUX RETURN 1* is used as effects return, this will determine the level of the effects when mixed with any "dry" channel signal.

☞ When used in this way, the effects device should be set at 100% effect.



XENYX2442FX

Fig. 2.12: Stereo aux return and stereo aux return (to aux send) controls

STEREO AUX RETURN 1/2 (TO AUX SEND)

The two right-hand *STEREO AUX RETURN* controls have a special function: they can be used to add an effect to a monitor mix. An example follows (1622FX wired to an effects device):

Monitor mix with effect

In this instance, your effects device should be set up as follows: the *AUX SEND 2* jack should be connected to the L/Mono input of your effects device, with its outputs coming back into the *STEREO AUX RETURN 1* jacks.

Connect the *AUX SEND 1* jack output to the amplifier of your monitor system. The *AUX SEND 1* master control determines the overall volume of the monitor mix.

Using the *STEREO AUX RETURN (TO AUX SEND)* control, the effect signal can now be blended into the monitor mix.

You can easily use the headphones distribution amplifier BEHRINGER POWERPLAY PRO HA4700/HA8000 to provide four (HA8000: eight) stereo headphone mixes for your studio.

The following table shows which jacks on the console can be used for this purpose.

External effects device receives signal from	External effects device routes signal back to	The effect signal reaches the monitor mix via
...
1622FX		
AUX SEND 2	STEREO AUX RETURN 1 connectors	STEREO AUX RETURN 1 (TO AUX SEND 1) control
1832FX		
AUX SEND 1	STEREO AUX RETURN 2 connectors	MONITOR switch of the FX/AUX 2 RET
2222FX		
AUX SEND 2	STEREO AUX RETURN connectors 1 or 2	STEREO AUX RETURN 1 (TO AUX SEND 1) control
2442FX		
AUX SEND 2	STEREO AUX RETURN 1 connectors	STEREO AUX RETURN 1 (TO AUX SEND 1) control
optional:		
AUX SEND 1	STEREO AUX RETURN 2 connectors	STEREO AUX RETURN 2 (TO AUX SEND 2) control

Tab. 2.1: Connectors and controls for monitor mix with effect

STEREO AUX RETURN FX

On consoles 1622FX and 1832FX this is the *STEREO AUX RETURN 2*, on consoles 2222FX and 2442FX this is the *STEREO AUX RETURN 3*.



XENYX 1622FX/1832FX/2222FX/2442FX

Use the STEREO AUX RETURN FX control to determine the level of the signal routed from the AUX RETURN FX jacks to the main mix. If nothing is connected to these jacks, the output of the built-in effects module will appear.

MAIN MIX / TO SUBS

This switch routes the signal fed in via the STEREO AUX RETURN FX jacks either to the main mix (not pressed) or to the submix (pressed).

On the 2442FX you can select which subgroup the signal is assigned to (switches 1-2 / 3-4, to the right of MAIN MIX / TO SUBS).

SOLO RETURNS

Additionally, this model allows you to route the aux returns together to the solo bus and the PFL bus. The LED lights up when Solo is on.

STEREO AUX RETURN 4 (2442FX only)

This control behaves the same way as the other stereo aux returns. Additionally, it provides for a simple monitor path using the switch PHONES/CTRL ROOM ONLY.

PHONES/CTRL ROOM ONLY

Use this switch to route the signal appearing at the AUX RETURN 4 jacks to the control room and headphones outputs.

2.3.6 Supplement to 1832FX

The 1832FX has a stereo fader for the AUX RETURN FX and offers a variety of routing options: MUTE disables the effect return (but not PFL of course!), SOLO routes it to the Solo or PFL busses, SUB to the subgroups and MAIN to the main mix.

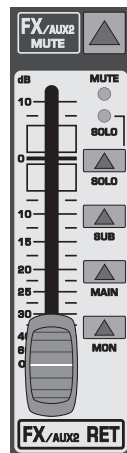

XENYX1832FX

Fig. 2.13: The FX/AUX 2 return fader of the 1832FX

MON

The MON switch routes the signals appearing at the AUX RETURN 2 jacks to the monitor path, along with the monitor signals from the channels.

If you wish to route the effect signal to the monitor mix, you can also switch aux 1 to pre-fader, drive the effect device from the aux 1 output and return the effect signal via AUX RETURN 2 to the monitor signal.

2.3.7 XPQ Surround function (1832FX only)



XENYX1832FX

Fig. 2.14: Control elements of the surround function



The XPQ surround function can be enabled/disabled with the XPQ TO MAIN switch. This is a built-in effect that widens the stereo width, thus making the sound more lively and transparent. Use the SURROUND control to determine the intensity of this effect.

VOICE CANCELLER



Here, you have a filter circuitry that lets you almost entirely remove the vocal portion of a recording. The filter is constructed in such a way that voice frequencies are targeted without majorly affecting the rest of the signal. Additionally, the filter seizes only the middle of the stereo image, exactly there where the vocals are typically located.

Connect the signal sources you wish to process using the Voice Cancellor to the CD/TAPE INPUT connectors. The Voice Cancellor circuitry is not available for other inputs.

Possible applications for the Voice Cancellor are obvious: you can very simply stage background music for Karaoke events. Of course, you can also do this at home or at your rehearsal room before you hit the stage. Singers with their own band can practice singing difficult parts using a complete playback from a tape player or a CD, thus minimizing rehearsal time.

2.3.8 CD/Tape input, CD/tape output

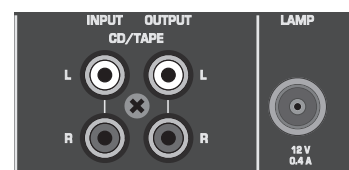

XENYX2442FX

Fig. 2.15: 2-track connectors and lamp socket

CD/TAPE INPUT

The CD/TAPE INPUT jacks (RCA) are designed to accept a 2-track recorder (e.g. DAT recorder), or they can be used as stereo line input. The output signal of a second XENYX or the BEHRINGER ULTRALINK PRO MX882 can also be connected here. If you connect the output of a hi-fi amplifier (with a source selection switch) to the CD/TAPE INPUT, you can easily listen to additional sources (e.g. cassette recorder, MD player, sound card, etc.).

Using the voice canceller function (1832FX only), you can process all signals being brought into your mixing console via these connectors.

CD/TAPE OUTPUT

These connectors are wired in parallel to the MAIN OUT and carry the main mix signal (unbalanced). Connect this to the inputs of your recording device. The final output level can be adjusted

GB

via the high-precision MAIN MIX fader.

ⓘ If you connect a compressor or a noise gate post 2-track output, the main mix fader will probably not be able to create a satisfactory fade-out effect.

2.3.9 Lamp socket (2442FX only)

Use this BNC socket to connect a gooseneck lamp (12 V DC, max. 0.5 A).

2.3.10 Level meter and monitoring

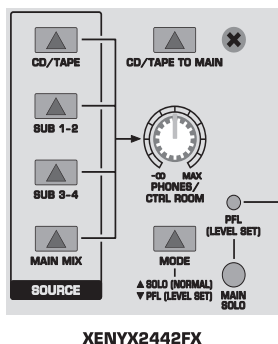

Fig. 2.16: Control room and phones sections of the 2442FX

CD/TAPE

The CD/TAPE switch routes the signal from the CD/TAPE INPUT jacks to the level meter, the CONTROL ROOM OUT outputs and the PHONES jack—this is a simple way to check recorded signals via monitor speakers or headphones.

SUB 1-2 or SUB

The SUB 1-2 switch routes subgroup 1-2 to the level meter, CONTROL ROOM OUT and phones.

SUB 3-4

The SUB 3-4 switch performs a similar function for subgroup 3-4 (2442FX only).

MAIN MIX

The MAIN MIX switch sends the main mix to the CONTROL ROOM OUT and the PHONES output as well as to the level meter.

PHONES/CTRL ROOM

Use this control to adjust the control room output level and the headphones volume.

CD/TAPE TO MAIN

When the CD/TAPE TO MAIN switch is depressed, the 2-track input is routed to the main mix and thus serves as an additional input for tape machines. You can also connect MIDI instruments or other signals here that do not require any further processing. At the same time, this switch disables the main mix to tape output link.

POWER

The blue POWER LED indicates that the device is switched on.

+48 V

The red “+48 V” LED lights up when phantom power is switched on. Phantom power is required to operate condenser microphones.

ⓘ While phantom power is switched on, do not connect or disconnect microphones on the mixer (or the stagebox/wallbox). Connect any microphones before switching on phantom power. Additionally, monitor/PA speakers should be muted before you activate the phantom power supply. After switching on, wait approx. one minute before adjusting the input gain so that the system has time to stabilize.

LEVEL METER

The high-precision level meters always give you an accurate display of signal level.

LEVEL SETTING:

When recording to digital recorders, the recorder’s meter should not go into overload. This is because, unlike analog recordings, it takes only slightly excessive levels to create unpleasant digital distortion.

When recording to analog, the VU meters of the recording machine should reach approx. +3 dB with low-frequency signals (e.g. kick drum). Due to their inertia, VU meters tend to display too low a signal level at frequencies above 1 kHz. You should only drive instruments such as a Hi-Hat as far as -10 dB. Snare drums should be driven to approx. 0 dB.

ⓘ The peak meters of your XENYX display level almost independent of frequency. A recording level of 0 dB is recommended for all types of signal.

MODE

The MODE switch determines whether the channels’ SOLO switch operates as PFL (Pre Fader Listen) or as solo (Solo In Place).

PFL (LEVEL SET)

To activate the PFL function, press the MODE switch. The PFL function should, as a rule, be used for level setting (TRIM). The signal is sourced pre-fader and assigned to the mono PFL bus. In “PFL” mode, only the left side of the peak meter is in operation. A PFL’d channel should be driven to the 0 dB mark of the VU meter.

SOLO (NORMAL)

When the MODE switch is not depressed, the stereo solo bus is active. Solo is actually short for “Solo In Place”. This is the customary method for listening to an individual signal or to a group of signals. As soon as a solo switch is pressed, all channels not solo selected are muted in the monitor path (control room and phones). A channel’s position in the stereo image is maintained. The solo bus carries the output signals of the channel pan controls, the aux sends and the stereo line inputs. On the 2442FX all aux returns, and on the 1832FX only aux return 2 can be routed to the solo bus. The solo bus is, as a rule, taken post-fader.

ⓘ The PAN control in the channel strip offers a constant power characteristic. This means that the signal is always at a constant level, irrespective of position in the stereo panorama. If the PAN control is moved fully left or right, the level in that channel increases by 4 dB. This ensures that, when set at the center of the stereo image, the audio signal does not appear louder. For this reason, with the solo function activated (Solo in Place), audio signals from channels with PAN controls that have not been moved fully left or right are displayed at a lower volume than in the PFL function.

As a rule, solo signals are monitored via the control room outputs and headphones jack and are displayed by the level meters. If a solo switch is pressed, the signals from the tape input, the subgroups and the main mix are cut from these outputs and the level meter.

MAIN SOLO

The MAIN SOLO LED lights up as soon as a channel or aux send solo switch is pressed. The MODE switch must be set to “Solo”.

PFL (LEVEL SET)

The PFL (LEVEL SET) LED indicates that the peak meter is set to PFL mode.



Fig. 2.17: PHONES jack



XENYX 1622FX/1832FX/2222FX/2442FX

PHONES jack

You can connect headphones to this 1/4" stereo jack (2442FX: 2 phones jacks). The signal routed to the PHONES connection is the same as that routed to the control room output.

2.3.11 Subgroups and main mix fader

You use the high-precision quality faders to control the output level of the subgroups and the main mix.

LEFT/RIGHT switch

The switches located above the subgroup faders assign the subgroup signal either to the left or right side of the main bus. Similarly, it can be routed to both sides or none at all. In the latter case, the submix is present only at the corresponding subgroup outputs.

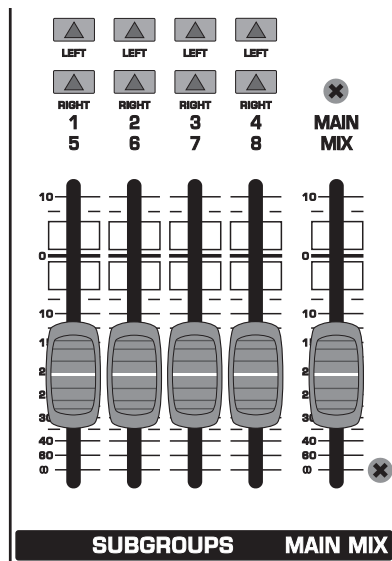

XENYX2442FX

Fig. 2.18: Subgroup and main mix faders

3. GRAPHIC 9-BAND EQUALIZER (1832FX only)

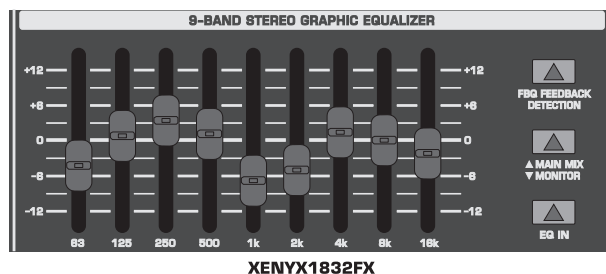

Fig. 3.1: The graphic stereo equalizer of the 1832FX

The graphic stereo equalizer allows you to tailor the sound to the room acoustics.

EQUALIZER

Use this switch to activate the graphic equalizer.

MAIN MIX/MONITOR

This toggles the graphic equalizer between the main mix and the monitor mix. With the switch up (not depressed), the equalizer is active in stereo on the main mix, and inactive on the monitor mix.

When the switch is depressed the equalizer is active in mono on the monitor mix, and inactive on the main mix.

FBQ FEEDBACK DETECTION



The switch turns on the FBQ Feedback Detection System. It uses the LEDs in the frequency band faders to indicate the critical frequencies. On a per-need basis, lower the frequency range in question somewhat in order to avoid feedback.

The graphic stereo equalizer has to be turned on in order to use this function.

Logically, at least one (ideally several) microphone channels have to be open for feedback to occur at all!

Feedback is particularly common when stage monitors ("wedges") are concerned, because monitors project sound in the direction of microphones. Therefore, you can also use the FBQ Feedback Detection for monitors by placing the equalizer in the monitor bus (see MAIN MIX/MONITOR).

4. DIGITAL EFFECTS PROCESSOR

24-BIT MULTI-EFFECTS PROCESSOR

Here you can find a list of all presets stored in the multi-effects processor. This built-in effects module produces high-grade standard effects such as reverb, chorus, flanger, delay and various combination effects. Use the Aux Send FX on the channels and the Aux Send FX master control to determine the input signal of the effects processor.

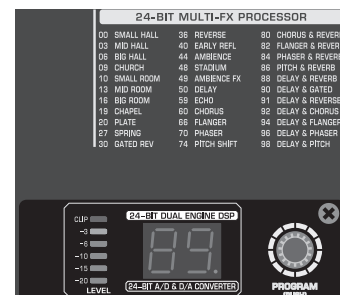

Fig. 4.1: Digital effects module

The built-in stereo effects processor has the advantage that it does not need to be wired up. This excludes the danger of humming or level mismatch right from the start and thus considerably facilitates use.

These effect presets are classical "mixing effects". If you move the STEREO AUX RETURN FX control, you mix the channel signal (dry) and the effect signal. You can control the balance between the two signals with the channel fader and the STEREO AUX RETURN FX control.

FX OUT

Mixing consoles 2222FX and 2442FX have a separate output for the effects device, which is unbalanced and stereo (tip = left signal; ring = right signal; sleeve = ground/shielding). Thus, you can record, for example, a vocal track enhanced with reverb in parallel to a "dry" vocal track; when doing the mix-down later on, you can freely determine the amount of reverb added.

The 2442FX has the effect output on the rear, 2222FX has it located next to the aux sends on the front panel.

FX FOOTSW.

Connect a standard foot switch to the foot switch jack and use this to switch the effects processor on and off. A light at the bottom of the display indicates whether the effects processor has been muted by the foot switch.

In Chapter 6.2 you will find an illustration showing how to connect your foot switch correctly.

LEVEL

The LED level meter on the effects module should display a

sufficiently high level. Take care to ensure that the clip LED only lights up at peak levels. If it is lit constantly, you are overloading the effects processor and this could cause unpleasant distortion.

PROGRAM

You can select the effect preset by turning the *PROGRAM* control. The display flashes with the number of the current preset. To recall the selected preset, press on the button; the flashing stops. You can also recall the selected preset with the foot switch.

5. REAR PANEL CONNECTORS

5.1 Main mix outputs, insert points and control room outputs

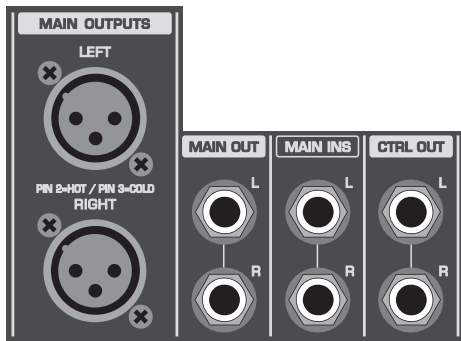

XENYX2442FX

Fig. 5.1: Main Mix outputs, main mix insert points and control room outputs

MAIN OUTPUTS

The *MAIN* outputs carry the MAIN MIX signal and are on balanced XLR jacks with a nominal level of +4 dBu. In parallel with this, 1/4" phone jacks carry the main mix signal in a balanced format (1622FX: here, the phone jack outputs are unbalanced and located on the front panel).

CONTROL ROOM OUTPUTS (CTRL OUT)

The control room output is normally connected to the monitoring system in the control room and carries the stereo mix or, when selected, the solo signals.

MAIN INS(ERTS) (2442FX only)

These are the insert points for the main mix. In the signal path, they are post-main mix amp, but pre-main fader(s). Use them to insert, for example, a dynamics processor or graphic equalizer. Please also note the information on insert points in chapter 5.3.

5.2 Subgroup outputs

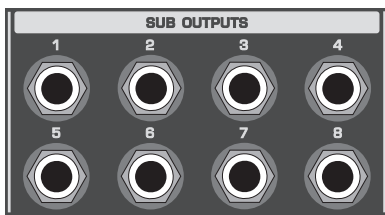

XENYX2442FX

Fig. 5.2: Subgroup outputs

SUB OUTPUTS

The subgroup outputs are unbalanced and provide the mix of those channels assigned to each subgroup with the SUB switch (2442FX: switches 1-2 or 3-4) next to the channel faders. Thus, you can, for example, route a subgroup to a second console or use the output as a recording output in parallel to the main outputs. In this way, you can record several tracks simultaneously. With an 8-track recorder, use Y cables and wire the inputs of your

machine so that you have 2 x 4 tracks available (e.g. channel 1 to track 1 and 2, etc.). In the first pass, you can record the tracks 1, 3, 5 and 7, in the second the tracks 2, 4, 6 and 8.

The XENYX 2442FX already has subgroup outputs wired in parallel (1-5, 2-6, etc.).

5.3 Inserts

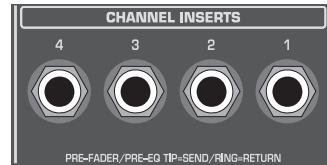

XENYX1622FX

Fig. 5.3: Insert points

On the 2442FX the channel insert points are located on the control panel between the line input and the TRIM control.

Insert points are very useful to process channel signals with dynamic processors or equalizers. Unlike reverb or other effects devices, whose signals are usually added to the dry signal, dynamic processors are most effective on the complete signal. In this case, aux send paths are a less-than-perfect solution. It is better to interrupt the signal path and insert a dynamic processor and/or equalizer. After processing, the signal is routed back to the console at precisely the same point it left. However, the channel signal path is interrupted only if a plug is inserted into the corresponding jack (stereo phone plug: tip = signal output; ring = return input). All mono input channels are equipped with inserts. They are pre-fader, pre-EQ and pre-aux send. Inserts can also be used as pre-EQ direct outputs, without interrupting the signal path. To this end, you will need a cable fitted with mono phone plugs on the tape machine or effect device end, and a bridged stereo phone plug on the console side (tip and ring connected).

5.4 Direct outputs (2442FX only)

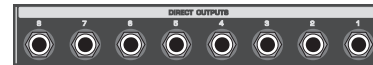

XENYX2442FX

Fig. 5.4: Direct outputs

DIRECT OUTPUTS

The direct outputs of the 2442FX (1 each per mono input channel) are ideal for recording if several tracks are to be recorded simultaneously. These unbalanced phone jacks are post-EQ, post-mute and post-fader.

5.5 Voltage supply, phantom power supply and fuse

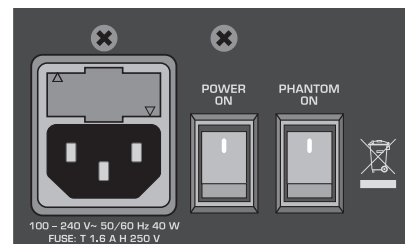

Alle Modelle

Fig. 5.5: Voltage supply and fuse

FUSE HOLDER/IEC MAINS RECEPTACLE

The console is connected to the mains via the cable supplied,



XENYX 1622FX/1832FX/2222FX/2442FX

which meets the required safety standards. Blown fuses must only be replaced by fuses of the same type and rating. The mains connection is made via a cable with IEC mains connector. An appropriate mains cable is supplied with the equipment.

POWER switch

Use the **POWER** switch to turn on the mixing console. The **POWER** switch should always be in the "Off" position when you are about to connect your unit to the mains.

To disconnect the unit from the mains, pull out the main cord plug. When installing the product, ensure that the plug is easily accessible. If mounting in a rack, ensure that the mains can be easily disconnected by a plug pull or by an all-pole disconnect switch on or near the rack.

Attention: The **POWER** switch does not fully disconnect the unit from the mains. Unplug the power cord completely when the unit is not used for prolonged periods of time.

PHANTOM switch

The **PHANTOM** switch activates the phantom power (necessary to operate condenser microphones) on the XLR sockets of the mono channels. The red +48 V LED illuminates when phantom power is on. As a rule, dynamic microphones can still be used with phantom power, provided that they are wired in a balanced configuration. In case of doubt, contact the microphone manufacturer!

Connect microphones before you switch on the phantom power supply. Please do not connect microphones to the mixer (or the stagebox/wallbox) while the phantom power supply is switched on. In addition, the monitor/PA loudspeakers should be muted before you activate the phantom power supply. After switching on, wait approx. one minute to allow for system stabilization.

Caution! Please also note the information given in chapter 6.2.1 "Audio connections".

SERIAL NUMBER

Please note the important information on the serial number given in chapter 1.3.3.

6. INSTALLATION

6.1 Rack mounting

The packaging of your mixing console contains two 19" rack mounts for installation on the side panels of the console.

Before you can attach the rack mounts to the mixing console, you need to remove the screws holding the left and right side panels. Then, use these screws to fasten the two rack mounts, each specifically to one side. With the rack mounts installed, you can mount the mixing console in a commercially available 19" rack. Be sure to allow for proper air flow around the unit, and do not place the mixing console close to radiators or power amps, so as to avoid overheating.

Only use the screws holding the mixing console side panels to fasten the 19" rack mounts.

6.2 Cable connections

You will need a large number of cables for the various connections of the console. The illustrations below show the wiring of these cables. Be sure to use only high-grade cables.

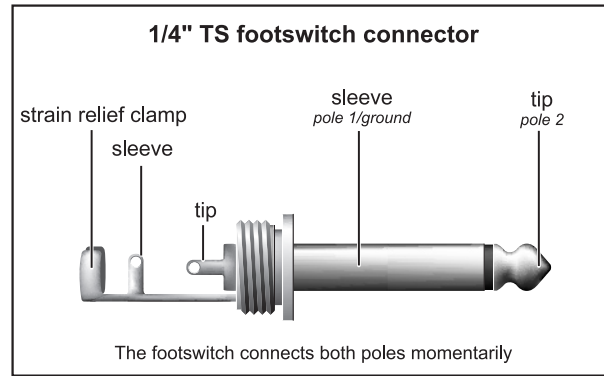

Fig. 6.1: Foot switch connector

6.2.1 Audio connections

Please use commercial RCA cables to wire the 2-track inputs and outputs.

You can, of course, also connect unbalanced devices to the balanced input/outputs. Use either mono plugs, or use stereo plugs to link the ring and shaft (or pins 1 & 3 in the case of XLR connectors).

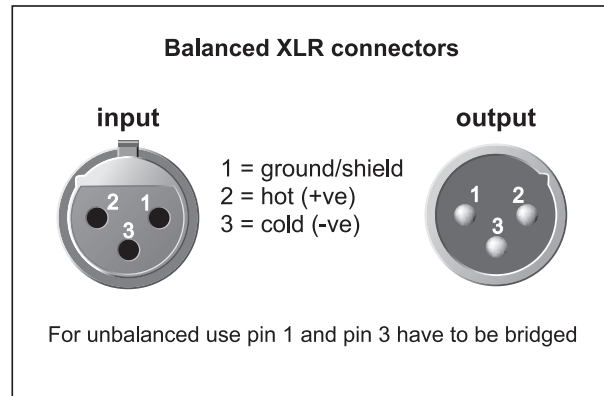

Fig. 6.2: XLR connections

Caution! You must never use unbalanced XLR connectors (PIN 1 and 3 connected) at the MIC input jacks if you want to use the phantom power supply.

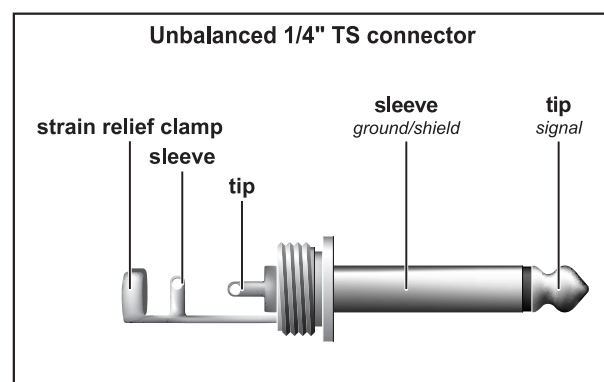

Fig. 6.3: 1/4" mono plug

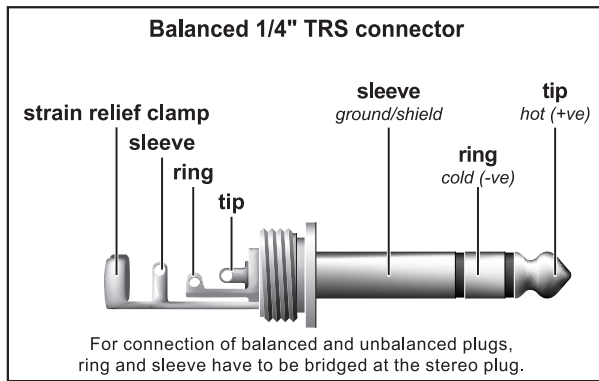

Fig. 6.4: 1/4" stereo plug

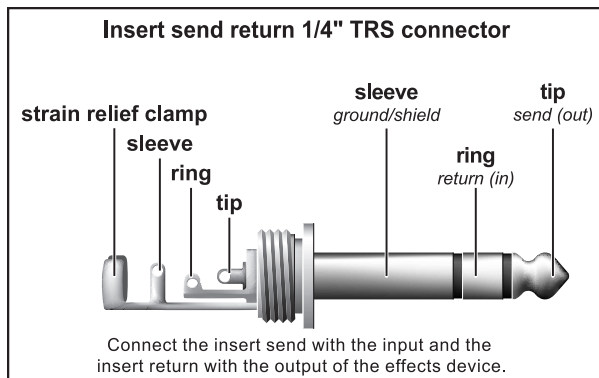

Fig. 6.5: Insert send/return stereo plug

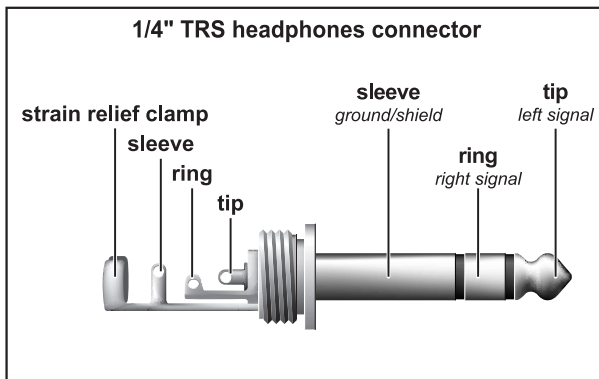

Fig. 6.6: Stereo plug for headphones connection

7. SPECIFICATIONS



Microphone inputs (XENYX Mic Preamp)	
Type	XLR, electronically balanced, discrete input circuit
Mic E.I.N. (20 Hz - 20 kHz)	
@ 0 Ω source resistance	-134 dB / 135.7 dB A-weighted
@ 50 Ω source resistance	-131 dB / 133.3 dB A-weighted
@ 150 Ω source resistance	-129 dB / 130.5 dB A-weighted
Frequency response	<10 Hz - 150 kHz (-1 dB), <10 Hz - 200 kHz (-3 dB)
Gain range	+10 to +60 dB
Max. input level	+12 dBu @ +10 dB Gain
Impedance	approx. 2.6 kΩ balanced
Signal-to-noise ratio	110 dB / 112 dB A-weighted (0 dBu In @ +22 dB gain)
Distortion (THD+N)	0.005% / 0.004% A-weighted
Line input	
Type	1/4" TRS connector electronically balanced
Impedance	approx. 20 kΩ balanced 10 kΩ unbalanced
Gain range	-10 to +40 dB
Max. input level	30 dBu
Fade-out attenuation¹ (Crosstalk attenuation)	
Main fader closed	90 dB
Channel muted	89 dB
Channel fader closed	89 dB
Frequency response	
Microphone input to main out	
<10 Hz - 90 kHz	+0 dB / -1 dB
<10 Hz - 160 kHz	+0 dB / -3 dB
Stereo inputs	
Type	1/4" TRS connector, electronically balanced
Impedance	approx. 20 kΩ
Max. input level	+22 dBu
EQ mono channels	
Low	80 Hz / ±15 dB
Mid	100 Hz - 8 kHz / ±15 dB
High	12 kHz / ±15 dB
EQ stereo channels	
Low	80 Hz / ±15 dB
Low Mid	500 Hz / ±15 dB
High Mid	3 kHz / ±15 dB
High	12 kHz / ±15 dB
Aux sends	
Type	1/4" TS connector, unbalanced
Impedance	approx. 120 Ω
Max. output level	+22 dBu
Stereo aux returns	
Type	1/4" TRS connector, electronically balanced
Impedance	approx. 20 kΩ bal. / 10 kΩ unbal.
Max. input level	+22 dBu

Main outputs	
Type	XLR, electronically balanced and 1/4" TRS balanced
1622FX only:	1/4" TS connector unbalanced
Impedance	approx. 240 Ω symm. / 120 Ω unbalanced
Max. output level	+28 dBu +22 dBu (1622FX)
Control room outputs	
Type	1/4" TS connector unbalanced
Impedance	approx. 120 Ω
Max. output level	+22 dBu
Headphones outputs	
Type	1/4" TRS connector, unbalanced
Max. output level	+19 dBu / 150 Ω (+25 dBm)
DSP	
Converter	24-bit Sigma-Delta, 64/128-times oversampling
Sampling rate	40 kHz
Main mix system data²	
Noise	
Main mix @ -∞	
Channel fader @ -∞	-101 dB -100 dB (2442FX)
Main mix @ 0 dB,	
Channel fader @ -∞	-93 dB -96 dB (1622FX) -87 dB (2442FX)
Main mix @ 0 dB,	
Channel fader @ 0 dB	-81 dB -83 dB (1622FX) -80 dB (2442FX)
Power supply	
Mains voltage	100 to 240 V~, 50/60 Hz
Power consumption	37 W (1622FX) 43 W (1832FX) 46 W (2222FX) 47 W (2442FX)
Fuse	100 - 240 V ~: T 1.6 A H 250 V
Mains connection	Standard IEC receptacle
Physical	
1622FX	
Dimensions (H x W x D)	approx. 3 7/8" x 11 7/8" x 13 7/8" (97 mm x 301mm x 351mm)
1832FX / 2222FX	
Dimensions (H x W x D)	approx. 3 7/8" x 16 1/16" x 14 1/16" (97 mm x 408 mm x 367 mm)
2442FX	
Dimensions (H x W x D)	approx. 5 3/8" x 16 1/2" x 17 1/4" (136 mm x 418 mm x 438 mm)
Weight (net)	
1622FX	approx. 3.3 kg
1832FX	approx. 4.7 kg
2222FX	approx. 4.8 kg
2442FX	approx. 5.9 kg

Measuring conditions:

- 1: 1 kHz rel. to 0 dBu; 20 Hz - 20 kHz; line input; main output; unity gain.
- 2: 20 Hz - 20kHz; measured at main output. Channels 1 - 4 unity gain; EQ flat; all channels on main mix; channels 1/3 as far left as possible, channels 2/4 as far right as possible. Reference = +6 dBu.

BEHRINGER is constantly striving to maintain the highest professional standards. As a result of these efforts, modifications may be made from time to time to existing products without prior notice. Specifications and appearance may differ from those listed or illustrated.

8. WARRANTY

§ 1 OTHER WARRANTY RIGHTS AND NATIONAL LAW

1. This warranty does not exclude or limit the buyer's statutory rights provided by national law, in particular, any such rights against the seller that arise from a legally effective purchase contract.

2. The warranty regulations mentioned herein are applicable unless they constitute an infringement of national warranty law.

§ 2 ONLINE REGISTRATION

Please do remember to register your new BEHRINGER equipment right after your purchase by visiting www.behringer.com (alternatively www.behringer.de) and kindly read the terms and conditions of our warranty carefully.

Registering your purchase and equipment with us helps us process your repair claims quicker and more efficiently.

Thank you for your cooperation!

§ 3 WARRANTY

1. BEHRINGER (BEHRINGER International GmbH including all BEHRINGER subsidiaries listed on the enclosed page, except BEHRINGER Japan) warrants the mechanical and electronic components of this product to be free of defects in material and workmanship for a period of one (1) year* from the original date of purchase, in accordance with the warranty regulations described below. If the product shows any defects within the specified warranty period that are not excluded from this warranty as described under § 5, BEHRINGER shall, at its discretion, either replace or repair the product using suitable new or reconditioned parts. In the case that other parts are used which constitute an improvement, BEHRINGER may, at its discretion, charge the customer for the additional cost of these parts.

2. If the warranty claim proves to be justified, the product will be returned to the user freight prepaid.

3. Warranty claims other than those indicated above are expressly excluded.

§ 4 RETURN AUTHORIZATION NUMBER

1. To obtain warranty service, the buyer (or his authorized dealer) must call BEHRINGER (see enclosed list) during normal business hours **BEFORE** returning the product. All inquiries must be accompanied by a description of the problem. BEHRINGER will then issue a return authorization number.

2. Subsequently, the product must be returned in its original shipping carton, together with the return authorization number to the address indicated by BEHRINGER.

3. Shipments without freight prepaid will not be accepted.

§ 5 WARRANTY REGULATIONS

1. Warranty services will be furnished only if the product is accompanied by a copy of the original retail dealer's invoice. Any product deemed eligible for repair or replacement under the

terms of this warranty will be repaired or replaced.

2. If the product needs to be modified or adapted in order to comply with applicable technical or safety standards on a national or local level, in any country which is not the country for which the product was originally developed and manufactured, this modification/adaptation shall not be considered a defect in materials or workmanship. The warranty does not cover any such modification/adaptation, irrespective of whether it was carried out properly or not. Under the terms of this warranty, BEHRINGER shall not be held responsible for any cost resulting from such a modification/adaptation.

3. Free inspections and maintenance/repair work are expressly excluded from this warranty, in particular, if caused by improper handling of the product by the user. This also applies to defects caused by normal wear and tear, in particular, of faders, crossfaders, potentiometers, keys/buttons, tubes, guitar strings, illuminants and similar parts.

4. Damages/defects caused by the following conditions are not covered by this warranty:

- ▲ improper handling, neglect or failure to operate the unit in compliance with the instructions given in BEHRINGER user or service manuals.
- ▲ connection or operation of the unit in any way that does not comply with the technical or safety regulations applicable in the country where the product is used.
- ▲ damages/defects caused by force majeure or any other condition that is beyond the control of BEHRINGER.

5. Any repair or opening of the unit carried out by unauthorized personnel (user included) will void the warranty.

6. If an inspection of the product by BEHRINGER shows that the defect in question is not covered by the warranty, the inspection costs are payable by the customer.

7. Products which do not meet the terms of this warranty will be repaired exclusively at the buyer's expense. BEHRINGER will inform the buyer of any such circumstance. If the buyer fails to submit a written repair order within 6 weeks after notification, BEHRINGER will return the unit C.O.D. with a separate invoice for freight and packing. Such costs will also be invoiced separately when the buyer has sent in a written repair order.

§ 6 WARRANTY TRANSFERABILITY

This warranty is extended exclusively to the original buyer (customer of retail dealer) and is not transferable to anyone who may subsequently purchase this product. No other person (retail dealer, etc.) shall be entitled to give any warranty promise on behalf of BEHRINGER.

§ 7 CLAIM FOR DAMAGES

Failure of BEHRINGER to provide proper warranty service shall not entitle the buyer to claim (consequential) damages. In no event shall the liability of BEHRINGER exceed the invoiced value of the product.

* Customers in the European Union please contact BEHRINGER Germany Support for further details.



Technical specifications and appearance subject to change without notice. The information contained herein is correct at the time of printing. The names of companies, institutions or publications pictured or mentioned and their respective logos are registered trademarks of their respective owners. Their use neither constitutes a claim of the trademarks by BEHRINGER® nor affiliation of the trademark owners with BEHRINGER®. BEHRINGER® accepts no liability for any loss which may be suffered by any person who relies either wholly or in part upon any description, photograph or statement contained herein. Colours and specification may vary slightly from product. Products are sold through our authorised dealers only. Distributors and dealers are not agents of BEHRINGER® and have absolutely no authority to bind BEHRINGER® by any express or implied undertaking or representation. No part of this manual may be reproduced or transmitted in any form or by any means, electronic or mechanical, including photocopying and recording of any kind, for any purpose, without the express written permission of BEHRINGER Spezielle Studioteknik GmbH. BEHRINGER® is a registered trademark.

ALL RIGHTS RESERVED. © 2006 BEHRINGER Spezielle Studioteknik GmbH,
Hanns-Martin-Schleyer-Str. 36-38, 47877 Willich-Münchheide II, Germany.
Tel. +49 2154 9206 0, Fax +49 2154 9206 4903