

# WK-200 WK-500

## USER'S GUIDE

Please keep all information for future reference.

### Safety Precautions

Before trying to use the keyboard, be sure to read the separate "Safety Precautions".

## GUÍA DEL USUARIO

Guarde toda la información para futuras consultas.

### Precauciones de seguridad

Antes de intentar usar el teclado, asegúrese de leer las "Precauciones de seguridad" separadas.

ES

English

Español

## NOTICE

This equipment has been tested and found to comply with the limits for a Class B digital device, pursuant to Part 15 of the FCC Rules. These limits are designed to provide reasonable protection against harmful interference in a residential installation. This equipment generates, uses and can radiate radio frequency energy and, if not installed and used in accordance with the instructions, may cause harmful interference to radio communications. However, there is no guarantee that interference will not occur in a particular installation. If this equipment does cause harmful interference to radio or television reception, which can be determined by turning the equipment off and on, the user is encouraged to try to correct the interference by one or more of the following measures:

- Reorient or relocate the receiving antenna.
- Increase the separation between the equipment and receiver.
- Connect the equipment into an outlet on a circuit different from that to which the receiver is connected.
- Consult the dealer or an experienced radio/TV technician for help.

## FCC WARNING

Changes or modifications not expressly approved by the party responsible for compliance could void the user's authority to operate the equipment.

## Declaration of Conformity

Model Number: WK-200/WK-500

Trade Name: CASIO COMPUTER CO., LTD.

Responsible party: CASIO AMERICA, INC.

Address: 570 MT. PLEASANT AVENUE, DOVER, NEW JERSEY 07801

Telephone number: 973-361-5400

This device complies with Part 15 of the FCC Rules, Operation is subject to the following two conditions:

(1) This device may not cause harmful interference, and (2) this device must accept any interference received, including interference that may cause undesired operation.

## Important!

Please note the following important information before using this product.

- Before using the optional AC Adaptor to power the unit, be sure to check the AC Adaptor for any damage first. Carefully check the power cord for breakage, cuts, exposed wire and other serious damage. Never let children use an AC adaptor that is seriously damaged.
- Never attempt to recharge batteries.
- Do not use rechargeable batteries.
- Never mix old batteries with new ones.
- Use recommended batteries or equivalent types.
- Always make sure that positive (+) and negative (-) poles are facing correctly as indicated near the battery compartment.
- Replace batteries as soon as possible after any sign they are getting weak.
- Do not short-circuit the battery terminals.
- The product is not intended for children under 3 years.
- Use only a CASIO AD-5 (for WK-200) or AD-12 (for WK-500) adaptor.
- The AC adaptor is not a toy.
- Be sure to disconnect the AC adaptor before cleaning the product.



This mark applies in EU countries only.



Manufacturer:  
CASIO COMPUTER CO.,LTD.  
6-2, Hon-machi 1-chome, Shibuya-ku, Tokyo 151-8543, Japan

Responsible within the European Union:  
CASIO EUROPE GmbH  
Bornbarch 10, 22848 Norderstedt, Germany

- Company and product names used in this manual may be registered trademarks of others.
- Any reproduction of the contents of this manual, either in part or its entirety, is prohibited. Except for your own, personal use, any other use of the contents of this manual without the consent of CASIO is prohibited under copyright laws.
- IN NO EVENT SHALL CASIO BE LIABLE FOR ANY DAMAGES WHATSOEVER (INCLUDING, WITHOUT LIMITATION, DAMAGES FOR LOSS OF PROFITS, BUSINESS INTERRUPTION, LOSS OF INFORMATION) ARISING OUT OF THE USE OF OR INABILITY TO USE THIS MANUAL OR PRODUCT, EVEN IF CASIO HAS BEEN ADVISED OF THE POSSIBILITY OF SUCH DAMAGES.
- The contents of this manual are subject to change without notice.

# Contents

## **General Guide ..... E-4**

- Using the 10-key Pad (18) ..... E-6
- FUNCTION Button (29) Functions ..... E-6

## **Getting Ready to Play ..... E-8**

- Preparing the Music Stand ..... E-8
- Power Supply ..... E-8

## **Playing the Digital Keyboard..... E-9**

- Turning on Power and Playing ..... E-9
- Using Headphones ..... E-9
- Changing Keyboard Response to Touch Pressure (Touch Response)..... E-10
- Adjusting Display Contrast ..... E-10
- Using the Metronome ..... E-11

## **Controlling the Keyboard Sounds..... E-12**

- Select from a variety of musical instrument sounds ..... E-12
- Layering Two Tones ..... E-13
- Splitting the Keyboard between Two Different Tones ..... E-13
- Using Reverb ..... E-14
- Using Chorus ..... E-14
- Using a Pedal ..... E-15
- Changing the Pitch (Transpose, Tuning, Octave Shift)..... E-15
- Using the Pitch Bend Wheel to Shift the Pitch of Notes (WK-500 Only) ..... E-16

## **Sampling Sounds and Playing Them on the Digital Keyboard ..... E-17**

- Connection and Preparation..... E-17
- Sampling and Playing a Melody Sound (Melody Sampling) ..... E-18
- Incorporating a Sampled Sound into a Drum Set (Drum Sampling) ..... E-20
- Other Sampling Functions ..... E-22

## **Playing Built-in Songs..... E-25**

- Playing the Demo Songs ..... E-25
- Playing Back a Particular Song..... E-26
- Increasing the Selection of Songs ..... E-28

## **Using Built-in Songs to Master Keyboard Play ..... E-29**

- Phrases ..... E-29
- Step Up Lesson Flow ..... E-29
- Selecting the Song, Phrase, and Part You Want to Practice..... E-30
- Lessons 1, 2, and 3..... E-31
- Lesson Settings ..... E-32
- Using Auto Step Up Lesson..... E-34

## **Music Challenge Keyboard Game ..... E-35**

## **Using Auto Accompaniment... E-36**

- Playing the Rhythm Part Only ..... E-36
- Playing All Parts ..... E-37
- Using Auto Accompaniment Effectively ..... E-39
- Using One-Touch Preset ..... E-40
- Using Auto Harmonize ..... E-41

## **Editing Auto Accompaniment Patterns..... E-42**

## **Saving Keyboard Setups to Registration Memory ..... E-46**

- To save a setup to registration memory ..... E-47
- To recall a setup from registration memory ..... E-47

## **Recording Your Keyboard Play ..... E-48**

- Recording and Playing Back Keyboard Play ... E-48
- Using Tracks to Record and Mix Parts ..... E-49
- Recording Two or More Songs, and Selecting One for Playback..... E-51
- Recording while Playing Along with a Built-in Song..... E-51
- Saving Recorded Data on an External Device ..... E-52

**Other Useful Digital Keyboard****Functions ..... E-53**

Changing the Scale of the Keyboard.....	E-53
Using Music Preset .....	E-56
Using the Arpeggiator.....	E-56
Deleting User Song Data.....	E-57
Deleting All Data in Digital Keyboard Memory .....	E-58

**Using a Memory Card****(WK-500 Only) ..... E-59**

SD Memory Card and Card Slot Precautions .....	E-59
Inserting and Removing an SD Memory Card.....	E-60
Formatting an SD Memory Card.....	E-60
Saving Digital Keyboard Data to an SD Memory Card.....	E-61
Loading Data from an SD Memory Card into Digital Keyboard Memory .....	E-62
Deleting Data from an SD Memory Card.....	E-63
Playing Back Data from an SD Memory Card.....	E-64
SD Memory Card Error Messages .....	E-64

**Connecting External****Devices ..... E-65**

Connecting a Computer .....	E-65
MIDI Settings.....	E-66
Storing and Loading Digital Keyboard Memory Data.....	E-68
Connecting to Audio Equipment.....	E-69

**Reference..... E-70**

Troubleshooting .....	E-70
Specifications.....	E-72
Operating Precautions .....	E-73
Error Messages.....	E-74
Song List .....	E-75

**MIDI Implementation Chart****Included Accessories**

- Music Stand
- Song Book
- Leaflets
  - Safety Precautions
  - Appendix
  - Other (Warranty, etc.)

Items included as accessories are subject to change without notice.

**Separately Available Accessories**

- You can get information about accessories that are separately for this product from the CASIO catalog available from your retailer, and from the CASIO website at the following URL.

<http://world.casio.com/>

# General Guide

- In this manual, the term “Digital Keyboard” refers to the WK-200/WK-500.
- Illustrations in this User’s Guide show the WK-500.
- **In this manual, buttons and other controllers are identified using the numbers shown below.**

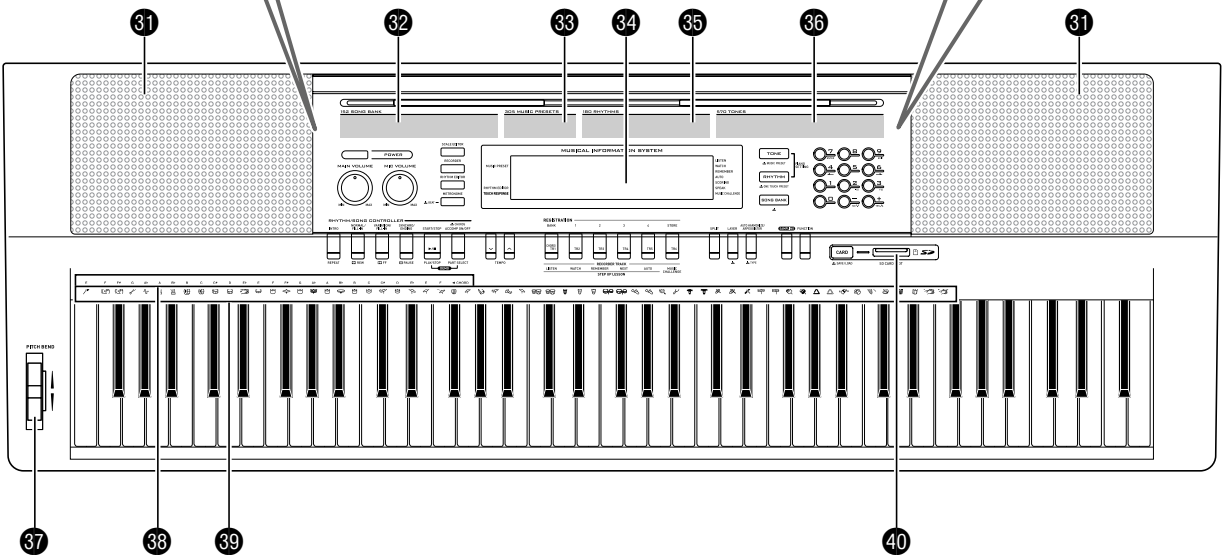
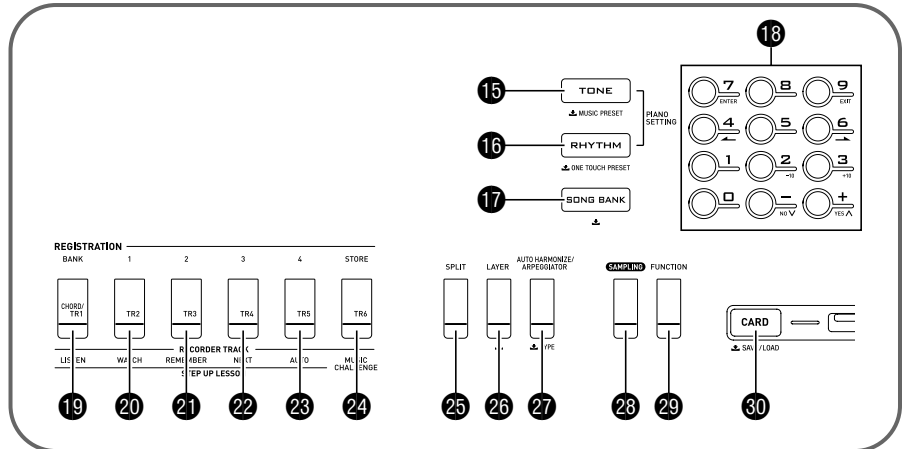
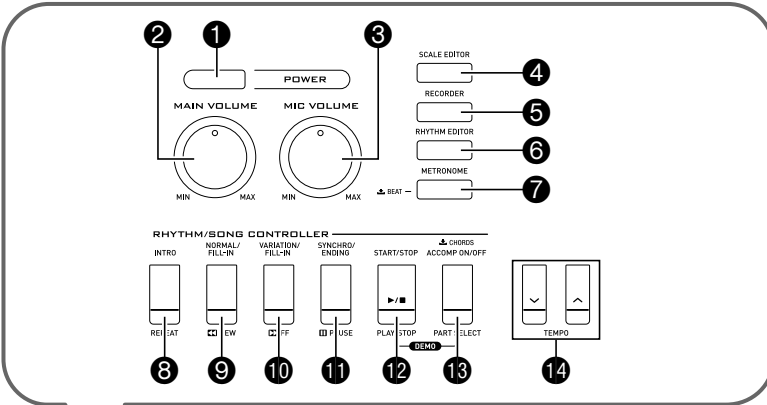

- ❶ **POWER** button ⓘE-9, 24, 44, 47, 49, 55, 68
- ❷ **MAIN VOLUME** knob ⓘE-9
- ❸ **MIC VOLUME** knob ⓘE-17
- ❹ **PRESET SCALE** button (WK-200)  
**SCALE EDITOR** button (WK-500) ⓘE-53, 54, 55
- ❺ **RECORDER** button ⓘE-48, 49, 50, 51, 52
- ❻ **RHYTHM EDITOR** button ⓘE-42, 43
- ❼ **METRONOME, BEAT** button ⓘE-11
- ❽ **INTRO, REPEAT** button ⓘE-27, 32, 39, 42, 43
- ❾ **NORMAL/FILL-IN, REW** button  
ⓘE-26, 30, 36, 39, 42, 43
- ❿ **VARIATION/FILL-IN, FF** button  
ⓘE-26, 30, 39, 42, 43
- ⓫ **SYNCHRO/ENDING, PAUSE** button  
ⓘE-26, 39, 40, 42, 43
- ⓬ **START/STOP, PLAY/STOP** button  
ⓘE-25, 26, 28, 31, 32, 36, 48, 50, 51, 52, 64
- ⓭ **ACCOMP ON/OFF, CHORDS, PART SELECT**  
button ⓘE-25, 28, 30, 32, 37, 41, 42, 43, 52, 67
- ⓮ **TEMPO** buttons ⓘE-11, 27, 40
- ⓯ **TONE, MUSIC PRESET** button  
ⓘE-9, 12, 18, 20, 21, 22, 24, 56
- ⓰ **RHYTHM, ONE TOUCH PRESET** button  
ⓘE-12, 19, 20, 22, 36, 40, 43, 47, 48, 51, 55
- ⓱ **SONG BANK** button ⓘE-26, 28, 30, 51
- ⓲ Number buttons, [-]/[+] buttons ⓘE-6
- ⓳ **BANK, CHORD/TR1, LISTEN** button  
ⓘE-19, 31, 46, 47
- ⓴ **Area1, TR2, WATCH** button  
ⓘE-19, 31, 46, 47, 50, 55
- ⓵ **Area2, TR3, REMEMBER** button  
ⓘE-19, 32, 46, 47, 50, 55
- ⓶ **Area3, TR4, NEXT** button ⓘE-19, 30, 46, 47, 50, 55
- ⓷ **Area4, TR5, AUTO** button ⓘE-19, 34, 46, 47, 50, 55
- ⓸ **STORE, TR6, MUSIC CHALLENGE** button  
ⓘE-19, 35, 47, 50, 55
- ⓹ **SPLIT** button ⓘE-13, 14
- ⓺ **LAYER** button ⓘE-13, 16
- ⓻ **AUTO HARMONIZE/ARPEGGIATOR, TYPE** button  
ⓘE-41, 56, 57
- ⓼ **SAMPLING** button ⓘE-18, 19, 20, 21
- ⓽ **FUNCTION** button ⓘE-6
- ⓾ **CARD, SAVE/LOAD** button (WK-500 only)  
ⓘE-60, 61, 62, 63, 64
- ⓿ Speakers
- Ⓚ Song Bank list
- Ⓛ Music Preset list
- Ⓜ Display
- Ⓨ Rhythm list
- Ⓩ Tone list
- ⓐ **PITCH BEND** wheel (WK-500 only) ⓘE-16
- ⓑ CHORD root names ⓘE-37
- ⓓ Percussion instrument list ⓘE-12
- ⓔ **SD CARD SLOT** (WK-500 only) ⓘE-60

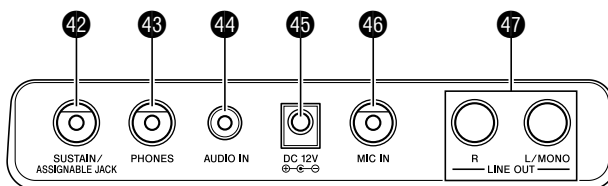
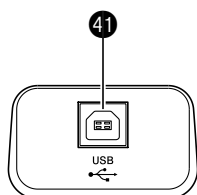

- ❶ **USB** port ⓘE-65
- ❷ **SUSTAIN/ASSIGNABLE JACK** ⓘE-15
- ❸ **PHONES/OUTPUT** jack (WK-200)  
**PHONES** jack (WK-500) ⓘE-9, 69
- ❹ **AUDIO IN** jack ⓘE-17, 69
- ❺ **DC 9V terminal** (WK-200)  
**DC 12V terminal** (WK-500) ⓘE-8
- ❻ **MIC IN** jack ⓘE-17
- ❼ **LINE OUT R, L/MONO** jack (WK-500 only)  
ⓘE-69

## Using the 10-key Pad (18)

Use the number buttons and the [-] and [+] buttons to change the settings of the parameters that appear in the upper left area of the display.

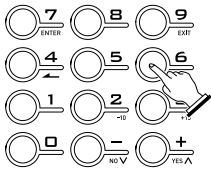

### Number Buttons

Use the number buttons to enter numbers and values.

- Enter the same number of digits as the currently displayed value.

*Example:* To enter tone number 001, input 0 → 0 → 1.

#### NOTE

- Negative values cannot be input using the number buttons. Use [-] (decrease) and [+] (increase) instead.

### [-] and [+] Buttons

You can use the [-] (decrease) and [+] (increase) buttons to change the displayed number or value.

- Holding down either button scrolls the displayed setting.
- Pressing both buttons at the same time will revert to the initial default setting or the recommended setting.

## FUNCTION Button (29) Functions

You can use the FUNCTION button (29) to adjust the reverb effect, to delete data, and to perform a wide range of other Digital Keyboard operations.

### To select a function

1. Press 29 to display the function menu.
2. Use the 18 (10-key) [4] (←) and [6] (→) keys to display the function you want.
  - You can exit the function menu by pressing 29.
  - After selecting functions 8 through 12, press the 18 (10-key) [7] (ENTER) key to display the menu item's submenu. Then use [4] (←) and [6] (→) to select an item. You can exit a submenu by pressing the 18 (10-key) [9] (EXIT) key.
3. Refer to the indicated pages for details about each function.



	Function	Display	See Page
1	Transpose	Trans.	E-15
2	Accompaniment Volume	AcompVol	E-40
3	Song Volume	Song Vol	E-28
4	Touch Response	Touch	E-10
5	Tuning	Tune	E-15
6	Reverb	Reverb	E-14
7	Chorus	Chorus	E-14
8	Sampling	SAMPLING	
	Automatic Sampling Start	AutoStrt	E-22
	Automatic Sampling Stop	AutoStop	E-23
	Sampled Tone Protect	(Protect)	E-24
9	Step Up Lesson	LESSON	
	Voice Fingering Guide	Speak	E-32
	Note Guide	NoteGuid	E-33
	Performance Evaluation	Scoring	E-33
	Phrase Length	PhraseLn	E-33
10	Other Settings	OTHER	
	Arpeggiator Hold	ArpegHld	E-57
	Pedal Effect	Jack	E-15
	Pitch Bend Range (WK-500 only)	Bend Rng	E-16
	Accompaniment Scale	AcompScl	E-55
	LCD Contrast	Contrast	E-10
11	MIDI Settings	MIDI	
	Keyboard Channel	Keybd Ch	E-66
	Navigate Channels	Navi. Ch	E-66
	Local Control	Local	E-67
	Accomp Out	AcompOut	E-67
12	Delete	DELETE	
	Sampled Sound Delete	(tone name)	E-23
	User Rhythm Delete	(rhythm name)	E-45
	User Song Delete	(song name)	E-57
	All Data Delete	All Data	E-58

### IMPORTANT!

- The tone and other parameters revert to their initial defaults whenever you turn on power (page E-9).

# Getting Ready to Play

## Preparing the Music Stand

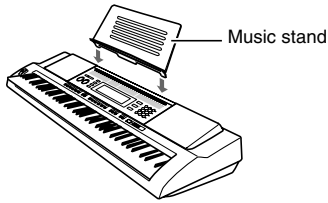

## Power Supply

Either an AC adaptor or batteries can be used to power this Digital Keyboard. Normally, use of AC adaptor power is recommended.

- The AC adaptor does not come with this Digital Keyboard. Purchase it separately from your retailer. See page E-3 for information about options.

## Using the AC Adaptor

Use the AC adaptor when you want to power the Digital Keyboard from a household electrical outlet.

**Specified AC Adaptor: AD-5 (WK-200)  
AD-12 (WK-500)**

DC 9V terminal (WK-200)  
DC 12V terminal (WK-500)

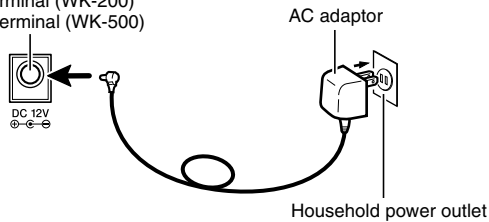

## IMPORTANT!

- Be sure to turn off Digital Keyboard power before connecting or disconnecting the AC adaptor.

## Using Batteries

### IMPORTANT!

- Be sure to turn off power before loading batteries.
- It is up to you to prepare six commercially available D-size batteries. Do not use oxyride batteries or any other nickel based batteries.

1. Open the battery cover on the bottom of the Digital Keyboard.

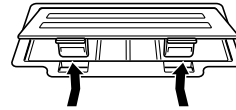

2. Load six D-size batteries into the battery compartment.

Make sure the positive  $\oplus$  and negative  $\ominus$  ends of the batteries are facing as shown in the illustration.

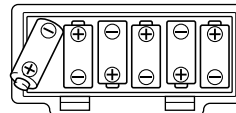

3. Insert the tabs of the battery cover into the holes on the side of the battery compartment, and close the cover.

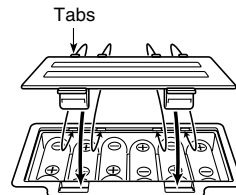

### Low Battery Indication

The indicator shown below starts to flash to let you know when battery power is low. Replace the batteries with new ones.

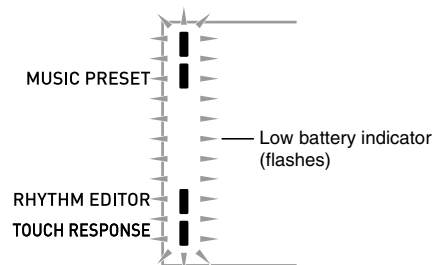

# Playing the Digital Keyboard

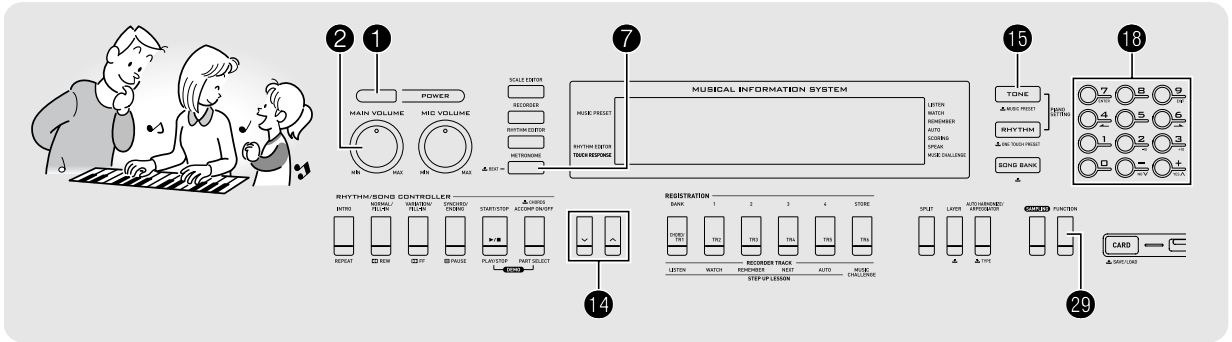

## Turning on Power and Playing

1. Press **1**.  
This turns on power.
2. Try playing something on the keyboard. Use **2** to adjust volume.

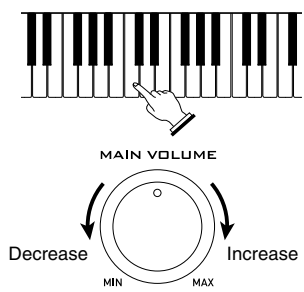

### IMPORTANT!

- Turning off the Digital Keyboard causes most current settings to be cleared. The Digital Keyboard will revert to initial settings the next time you turn it on.
- This is true for all settings except for sample sound protection. Once you turn it on it remains on until you turn it off again.

### Auto Power Off (Using Batteries)

While you are using batteries for power, power will turn off automatically if you do not perform any operation for about six minutes. Auto Power Off is disabled while the AC adaptor is being used for power.

#### Disabling Auto Power Off

You can disable Auto Power Off to ensure that power is not turned off automatically during a concert, etc.

1. While holding down **15**, turn on power.  
Auto Power Off will be disabled.

## Using Headphones

Using headphones cuts off output from the built-in speakers, which means you can practice playing even late at night without disturbing others.

- Be sure to turn down the volume level before connecting headphones.

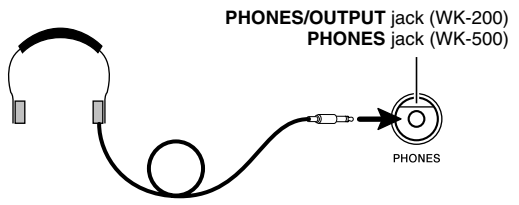

### NOTE

- Headphones do not come with the Digital Keyboard.
- Use commercially available headphones. See page E-3 for information about options.

### IMPORTANT!

- Do not listen to very high volume output over headphones for long period. Doing so creates the risk of hearing damage.
- If you are using headphones that require an adaptor plug, make sure you do not leave the adaptor plugged in when removing the headphones.

## Changing Keyboard Response to Touch Pressure (Touch Response)

Touch Response alters tone volume in accordance with keyboard pressure (speed). This provides you some of the same expressivity you get on an acoustic piano.

### Keyboard Instrument Sound Intensity

■ **Sound intensity depends on the speed that keys are pressed.**

People normally believe that the stronger the pressure applied to a piano keyboard, the louder the sound. Actually, however, the intensity of the notes played depends on the speed at which keys are pressed. Notes are louder when keys are pressed quickly, and quieter when keys are pressed slowly. Keeping this in mind as you play a keyboard musical instrument lets you control note volume without striving to apply too much pressure with your fingertips.

■ **The playability of an acoustic piano**

Your Digital Keyboard provides you with key touch that is the next best thing to an acoustic piano. Note volume changes automatically in accordance with key press speed.

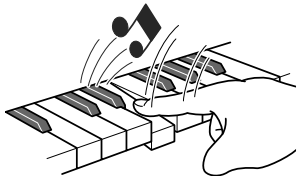

Pressing fast produces louder notes.

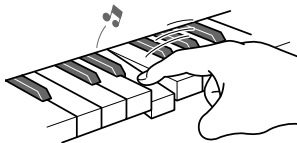

Pressing slowly produces softer notes.

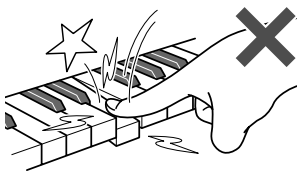

Do not try to use too much pressure.

## Changing Touch Response Sensitivity

Use the procedure below to control how much the volume of played notes change in accordance with playing speed. Select the setting that best matches your playing style.

1. Press **[29]** and then use the **[18]** (10-key) **[4]** (←) and **[6]** (→) keys to display “Touch” (page E-6).



2. Use **[18]** (10-key) **[-]** and **[+]** keys to select one of the three Touch Response sensitivity settings.

<b>Off (oFF)</b>	Touch Response is turned off. Sound volume is fixed, regardless of key press speed.
<b>Type 1 (1)</b>	Normal Touch Response
<b>Type 2 (2)</b>	More sensitive Touch Response than Type 1

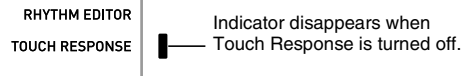

## Adjusting Display Contrast

1. Press **[29]** and then use the **[18]** (10-key) **[4]** (←) and **[6]** (→) keys to display “OTHER” (page E-6).

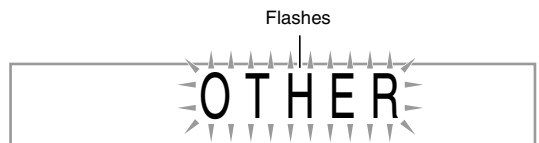

2. Press **[18]** (10-key) **[7]** (ENTER) key.
3. Use the **[18]** (10-key) **[4]** (←) and **[6]** (→) keys to display “Contrast”.



4. Use the **[18]** (10-key) **[-]** and **[+]** keys to adjust the contrast.
  - The contrast setting range is 01 to 17.

## Using the Metronome

The metronome lets you play and practice along with a steady beat to help keep you on tempo.

### Start/Stop

#### 1. Press **7**.

This starts the metronome.

This pattern changes with each beat.

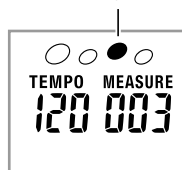

#### 2. Press **7** again to stop the metronome.

### Changing the Beats Per Measure

You can configure the metronome to use a bell sound for the first beat of each measure of the song you are playing.

- You can specify 0, or a value from 2 to 6 as the number of beat per measure.
- When playing a built-in song, the beats per measure setting (which determines when the bell sounds) is configured automatically for the currently selected song.

#### 1. Hold down **7** until the beats per measure setting screen appears on the display.

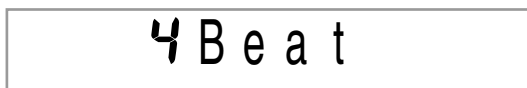

- If you do not perform any operation for a few seconds after the beats per measure setting screen appears, the display will return to the screen displayed before you pressed **7**.

#### 2. Use **10** (10-key) to enter the number of beats per measure.

- The bell will not sound if you specify 0 for this setting. In this case, all beats are indicated by a click sound. This setting lets you practice with a steady beat, without worrying how many beats there are in each measure.

## Changing the Metronome Tempo

Use the following procedure to change the tempo of the metronome.

#### 1. Press **14**.

Use **V** (slower) and **^** (faster) to change the tempo setting. Holding down either button changes the setting at high speed.

- Pressing **^** and **V** at the same time will initialize the tempo setting in accordance with the currently selected song or rhythm.
- Pressing **14** causes the tempo value to flash on the display. While the tempo value is flashing, you can use **10** (10-key) to change it.

Note that you must input leading zeros, so 89 is input as 089.

- The tempo value will stop flashing if you do not perform any operation for a short while.

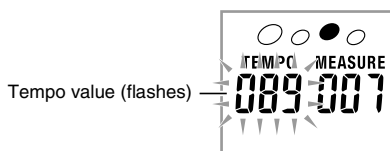

## Changing the Metronome Sound Volume

The metronome volume setting is changed automatically with the volume level of the currently selected Auto Accompaniment or song. The metronome volume cannot be adjusted independently.

- For information about changing the Auto Accompaniment volume, see page E-40.
- For information about changing the song volume, see page E-28.

### NOTE

- You cannot adjust the balance between the metronome and note volume during Auto Accompaniment and built-in tune play.

# Controlling the Keyboard Sounds

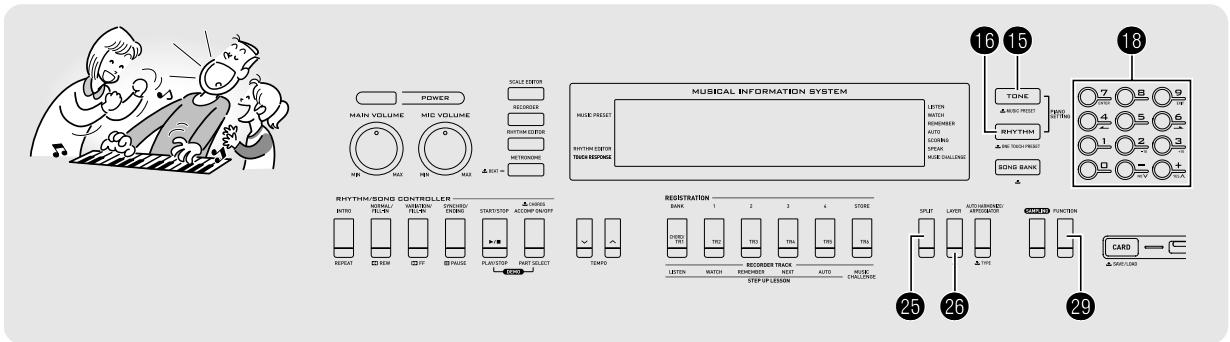

## Select from a variety of musical instrument sounds

Your Digital Keyboard lets you select tones for a wide variety of musical instrument sounds, including violin, flute, orchestra, and more. Even the same song sound takes on a different feel by changing the instrument type.

### To select an instrument for playing

#### 1. Press **15**.



#### 2. Use **18** (10-key) to select the tone number you want.

The corresponding tone number and tone name will appear on the screen.

#### NOTE

- See the separate "Appendix" for a complete list of available tones.
- Use the number buttons to enter the tone number. Specify three digits for the tone number.  
*Example:* To select 001, enter 0 → 0 → 1.
- When one of the drum sets is selected, each keyboard key is assigned a different percussion sound.

### 3. Try playing something on the keyboard.

The tone of the instrument you selected will sound.



### Playing with a Piano Tone (Piano Setup)

#### 1. Press **15** and **16** at the same time.

This selects the grand piano tone.

#### Settings

Tone Number	: "001"
Reverb	: "06"
Transpose	: 00
Touch Response	: Off: Returns to initial default On: No change
Pedal Effect	: SUS
Rhythm Number	: "161" (WK-200), "181" (WK-500)
Accompaniment	: Rhythm part only
Local Control	: On
Drum Assign	: Off
Split	: Off
Layer	: Off
Chorus	: Off
Octave Shift (Upper)	: 0
Auto Harmonize	: Off
Arpeggiator	: Off
Scale	: Equal

## Layering Two Tones

You can use the following procedure to layer two different tones (such as piano and strings) so they sound simultaneously when you press a keyboard key.

### 1. Select the first tone you want to use.

Press **15** and then use **10** (10-key) to select the tone you want.

Example: 026 ELEC.PIANO 1 (WK-500)

TONE 026 E . P i a n o 1

### 2. Press **26**.

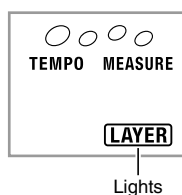

### 3. Use **10** (10-key) to select the second tone you want.

Example: 212 STRINGS (WK-500)

TONE 212 S t r i n g s

### 4. Play something on the keyboard.

Both tones sound at the same time.

### 5. Pressing **26** again to unlayer the keyboard (so it plays only the tone you selected in step 1).

- Each press of **26** toggles between layered (two tones) and unlayered (one tone).

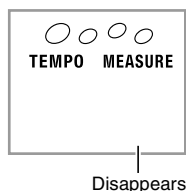

## Splitting the Keyboard between Two Different Tones

You can use the procedure below to assign different tones to the right range and left range of the keyboard, so it sounds like you are playing an ensemble between two instruments.

### To select the two tones for a split keyboard

#### 1. Select the tone for the right side range (page E-12).

Press **15** and then use **10** (10-key) to select the tone you want.

Example: 335 FLUTE 1 (WK-500)

TONE 335 F l u t e 1

#### 2. Press **25**.

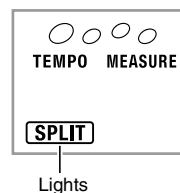

#### 3. Use **10** (10-key) to select the left side range tone you want.

Example: 056 VIBRAPHONE 1 (WK-500)

TONE 056 V i b e s 1

#### 4. Play something on the keyboard.

This will sound the tones assigned to the left and right side ranges of the keyboard.

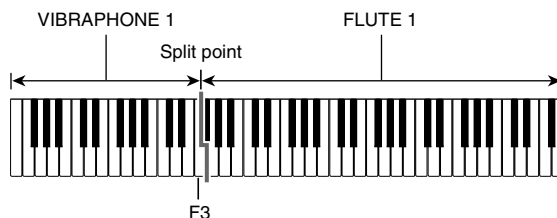

**5. Pressing  $\text{25}$  again to unsplit the keyboard (so it plays only the tone you selected in step 1).**

- Each press of  $\text{25}$  toggles between split (two tones) and unsplit (one tone).

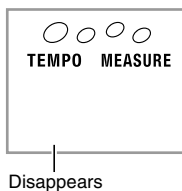

**NOTE**

- If you turn on both layer and split, layering will be applied to the right side range of the keyboard only.

**To change the split point**

**1. While holding down  $\text{25}$ , press the keyboard key where you want the split point to be.**

The key you press will become the lowest note of the right side range of the split keyboard.

*Example: Setting middle C (C4) as the split point.*

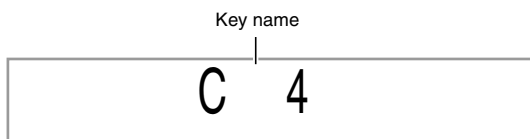

**Using Reverb**

Reverb adds reverberation to notes. You can change the duration of the reverb.

- 1. Press  $\text{29}$  and then use the  $\text{18}$  (10-key) [4] ( $\leftarrow$ ) and [6] ( $\rightarrow$ ) keys to display “Reverb” (page E-6).**



- 2. Use the  $\text{18}$  (10-key) [-] and [+] keys to select the reverb setting you want.**

Off (oFF)	Turns off reverb.
1 to 10	The larger the number selected, the longer the reverb duration.



Indicator disappears when reverb is turned off.

**Using Chorus**

Chorus is a function that adds depth and breadth to notes. It makes you sound as if you are playing multiple instruments.

- 1. Press  $\text{29}$  and then use the  $\text{18}$  (10-key) [4] ( $\leftarrow$ ) and [6] ( $\rightarrow$ ) keys to display “Chorus” (page E-6).**

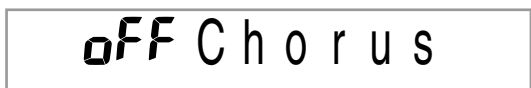

- 2. Use the  $\text{18}$  (10-key) [-] and [+] keys to select the chorus type you want.**

There are five chorus types, plus an off setting.

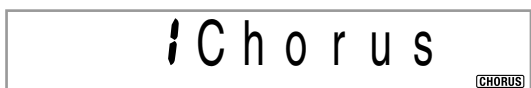

Indicator disappears when chorus is turned off.

- The actual effect produced by chorus depends on the tone you are using.



## Using a Pedal

A pedal can be used to change notes in various ways while playing.

- A pedal unit does not come with the Digital Keyboard. Purchase one separately from your retailer. See page E-3 for information about options.

## Connecting a Pedal Unit

Connect an optional pedal unit.

### SUSTAIN/ASSIGNABLE JACK

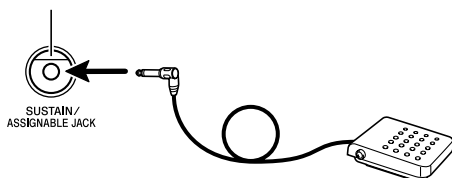

## Selecting the Pedal Effect

1. Press **29** and then use the **18** (10-key) [4] (←) and [6] (→) keys to display “OTHER” (page E-6).

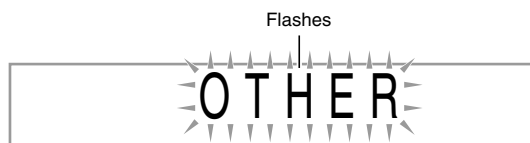

2. Press **18** (10-key) [7] (ENTER) key.
3. Use the **18** (10-key) [4] (←) and [6] (→) keys to display “Jack”.

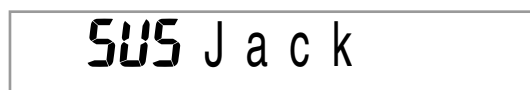

4. Use the **18** (10-key) [-] and [+] keys to select the pedal effect you want.

- The following shows the available pedal effects.

<b>Sustain (SUS)</b>	Sustains notes played while the pedal is depressed. Organ and other similar tone notes are sustained even if the pedal is not pressed.
<b>Sostenuto (SoS)</b>	Sustains notes that are playing when the pedal is depressed before the keyboard keys are released.
<b>Soft (SFT)</b>	Slightly softens notes played while the pedal is depressed.
<b>Rhythm (rHy)</b>	Pressing the pedal starts and stops Auto Accompaniment or song playback.

## Changing the Pitch (Transpose, Tuning, Octave Shift)

### Changing the Pitch in Semitone Steps (Transpose)

The transpose feature lets you change the pitch, in semitone steps. A simple operation lets you instantly change the pitch to match that of a singer.

- The transpose setting range is -12 to +12 semitones.

1. Press **29**.

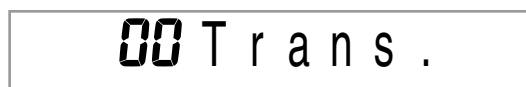

2. Use the **18** (10-key) [-] and [+] keys to select the transpose setting you want.

### Fine Tuning (Tuning)

Use the tuning feature when you need to adjust the pitch slightly to play along with another musical instrument. Also, some artists perform their music with slightly altered tuning. You can use the tuning feature to adjust tuning so it exactly matches a performance on a CD.

- The tuning setting range is -99 to +99 cents.

1. Press **29** and then use the **18** (10-key) [4] (←) and [6] (→) keys to display “Tune” (page E-6).

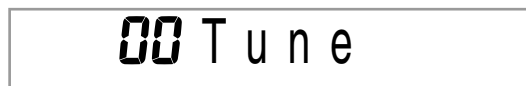

2. Use the **18** (10-key) [-] and [+] keys to adjust the tuning.

## Octave Shift

Octave Shift lets you raise or lower the pitch of the keyboard notes in octave units.

- The octave shift setting range is -2 to +2 octaves.
- When using Split (page E-13), you can individually set the left and right keyboard ranges to the pitches you want.

### 1. Keep pressing **26** until the screen shown below appears on the display.

If you want to use Split, turn on Split before pressing **26**.

- If you do not perform any operation for a few seconds after this screen appears, the display will return to the previous screen automatically.



### 2. Use the **18** (10-key) [-] and [+] keys to shift the octave.

- Split On : This step affects the right side keyboard range only.
- Split Off : This step affects the entire keyboard range.

### 3. Press **26**.

- Split On : The screen shown below will appear. Use the **18** (10-key) [-] and [+] keys to shift the octave for the left side keyboard range.
- Split Off : The screen shown below will appear. Advance to step 4.



### 4. Press **26** again.

## Using the Pitch Bend Wheel to Shift the Pitch of Notes (WK-500 Only)

You can use the pitch bend wheel to slide the pitch of notes smoothly upwards and downwards. This technique makes it possible to produce effects that are similar to sounds produced when bending notes on a saxophone or electric guitar.

### To play with the pitch bend wheel

#### 1. While playing a note on the keyboard, rotate the pitch bend wheel on the left of the keyboard upwards or downwards.

The amount the note bends depends on how much you rotate the pitch bend wheel.

- Do not have the pitch bend wheel rotated as you turn on the Digital Keyboard.

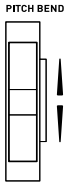

### Specifying the Pitch Bend Range

Use the following procedure to specify how much the pitch of the note changes whenever the pitch bend wheel is rotated upwards or downwards. You can specify a range from 0 to 12 semitones (one octave).

#### 1. Press **26** and then use the **18** (10-key) [4] (←) and [6] (→) keys to display "OTHER" (page E-6).

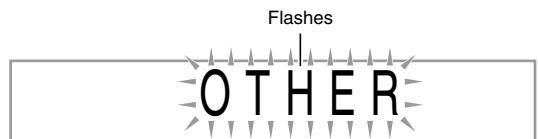

#### 2. Press **18** (10-key) [7] (ENTER) key.

#### 3. Use the **18** (10-key) [4] (←) and [6] (→) keys to display "Bend Rng".

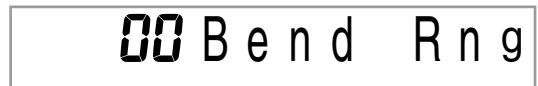

#### 4. Use the **18** (10-key) [-] and [+] keys to change the range.



# Sampling Sounds and Playing Them on the Digital Keyboard

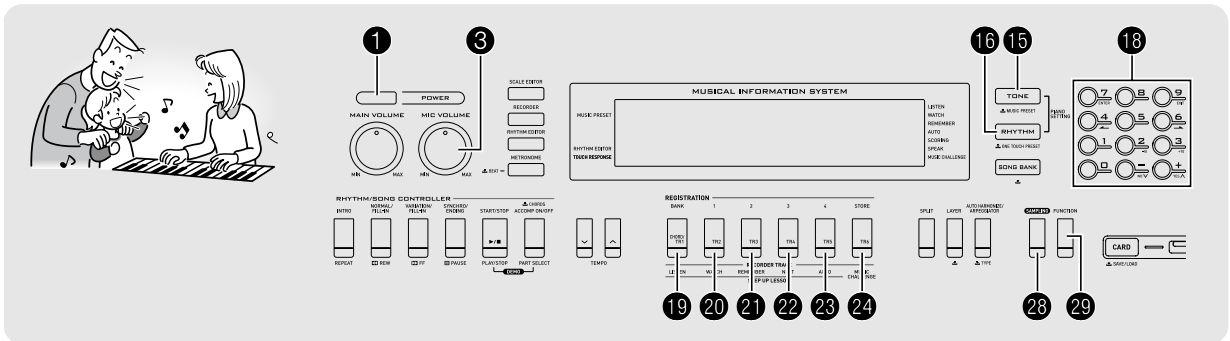

You can sample a sound from a microphone, a portable audio player, or other device, and then play the sound on the keyboard. For example, you could sample the bark of your dog and then use the sound in a melody. You also can sample and use passages from a CD. The sampling feature is a great way to create new sounds that are highly creative.

## Connection and Preparation

### IMPORTANT!

- Before connecting, make sure that the Digital Keyboard, external devices, and/or the microphone all are turned off.

### 1. Connect a microphone or external device to the Digital Keyboard.

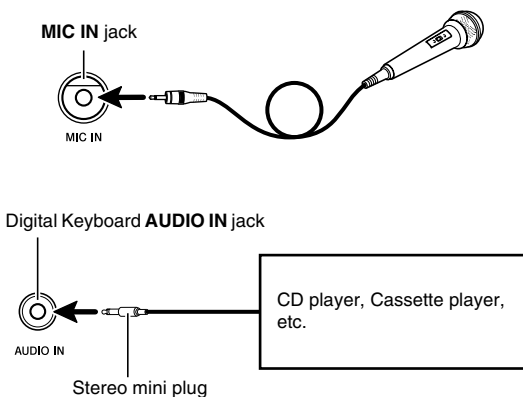

### NOTE

- You also could connect a commercially available microphone.
- Connection of an external device requires commercially available connecting cords, supplied by you. Connecting cords should have a stereo mini plug on one end and a plug that matches the configuration of the external device on the other end.

### 2. Turn down the volume levels of the external device and the Digital Keyboard.

### 3. Turn on the external device or microphone, and then turn on the Digital Keyboard.

- When using a microphone, adjust the input volume level with ③.

### NOTE

- It will take a few seconds after you turn on the Digital Keyboard before you will be able to use the microphone.
- Sampled sounds are recorded in monaural.

## Sampling and Playing a Melody Sound (Melody Sampling)

Use the procedures in this section to sample a sound and play it as the melody part on the Digital Keyboard.

- Up to five sampled sounds can be stored in Digital Keyboard memory as tone numbers 671 through 675 (WK-200: 571 through 575). Simply select the tone number where the sound you want is located to assign the sound to the keyboard.

### To sample a sound

- Press **15** and then use **10** (10-key) to enter the tone number (WK-500: 671 to 675) (WK-200: 571 to 575) where you want to store the sampled sound.

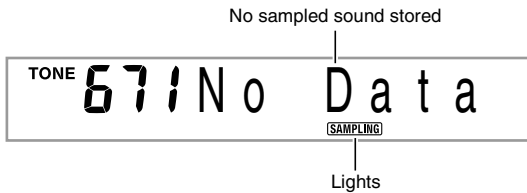

- In place of the above steps, you could press **28** and **15** at the same time and then select a tone number.

- Press **28**.

This enters sampling standby.

The allowable sampling time (in seconds) will appear on the display momentarily and then the display will change to the following.

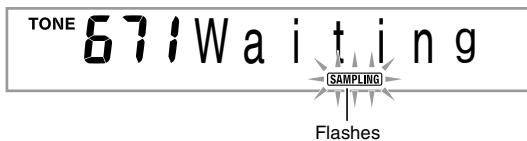

- Output the sound from the external device. In the case of a microphone, output the sound in the direction of the microphone.

Sampling will start automatically.



- After the sound you want to sample is finished, press **28**.

Sampling will stop when you release **28**.

- Even if you do not press **28**, sampling will stop automatically whenever there is no more sound being input from the external device or microphone. Sampling also will stop automatically 10 seconds after it is started.

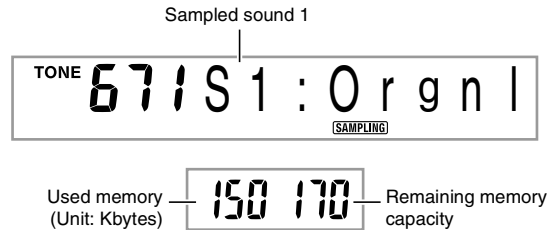

- Play something on the Digital Keyboard.

### NOTE

- You may not be able to get 10 seconds of sampling if Digital Keyboard memory is low due to storage of other data. If this happens, deleting other memory data you no longer need will free up memory space and you should be able to sample for 10 seconds. See "Deleting a Sampled Sound" on page E-23 for more information.

### IMPORTANT!

- Sampling sound and storing it will delete any sound data currently stored under the same tone number. To help ensure that you do not accidentally delete important data, be sure to read "Protecting Against Accidental Deletion of Sampled Sounds" on page E-24.

### ■ How sampled sounds are played

Pressing Middle C (C4) will play back the original sound. The keys to the left and right of C4 play the sound at different pitches.

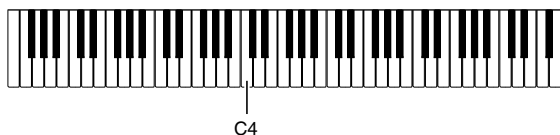

### Looping a Sampled Sound

You can use the following procedure to loop a sampled sound so it continues to repeat, as you play on the Digital Keyboard.

1. Press **16**.
2. While holding down **23**, press **24**.  
This enters repeat standby.



3. Press the button (**19** to **23**) that corresponds to the melody sampling tone number you want to select.  
This will start looped playback of the selected sound.

To select this tone number:		Press this button:
WK-500	WK-200	
671	571	<b>19</b>
672	572	<b>20</b>
673	573	<b>21</b>
674	574	<b>22</b>
675	575	<b>23</b>

4. Press the same button again to stop playback.
5. Press **24** to return to the screen that was displayed before step 2 of this procedure.

### Changing the Volume of Sampled Sound Looped Playback

You can use the following procedure to change the volume level of the looped playback of each sampled sound, if you want.

1. Press the button of the sampled sound whose volume you want to change (**19** to **23**).
  - This will cause the sounds loop to sound.
2. While the loop is sounding hold down the same sampled sound button (**19** to **23**) as you press any keyboard key.
  - Pressing the keyboard key quickly will increase sample sound volume, while pressing slowly will decrease volume.
3. After the sampled sound is at the volume level you want, release its button (**19** to **23**).

## Applying Effects to a Sampled Sound

You can apply various effects to sampled sounds.

1. Press **15** and then use **18** (10-key) to enter the tone number (WK-500: 671 to 675) (WK-200: 571 to 575) to which you want to apply effects.
2. Press **15** to cycle through the available effects, described below.

Effect Type (Display)	Description
Original (Orgnl)	Normal sampled tone (no looping, no effect).
Loop 1 (Loop1)	Loops the sampled sound.
Loop 2 (Loop2)	Loops the sample sound and raises the pitch of the resonating sound when the keyboard key is released.
Loop 3 (Loop3)	Loops the sample sound and lowers the pitch of the resonating sound when the keyboard key is released.
Pitch 1 (Ptch1)	Changes the pitch from low to high, at an increasing rate.
Pitch 2 (Ptch2)	Changes the pitch from high to low, at a decreasing rate.
Pitch 3 (Ptch3)	Changes the pitch from high to low, at a decreasing rate, and then raises the pitch when the key is released.
Tremolo (Trem1)	Alternates volume between high and low.
Funny 1 (Funy1)	Adds vibrato and changes the pitch by a gradually increasing amount.
Funny 2 (Funy2)	Alternates between high pitch and low pitch.
Funny 3 (Funy3)	Adds vibrato and changes the pitch from low to high.

- Avoid assigning the same sampled sound to the keyboard for play along and for looped play. Doing so will cause, the Loop 1 effect to be applied to the keyboard tone while looped play of the sampled sound is being performed.

## Incorporating a Sampled Sound into a Drum Set (Drum Sampling)

You can use the procedure to change the drum sounds that are assigned to each keyboard key.

- You can store up to three drum sets and store them as tone numbers 676, 677, and 678 (WK-200: 576, 577, and 578). Simply select the tone number where the drum set you want is located to assign the drum set sounds to the keyboard.

1. Press **16**.  
**16** lights.
2. Press **15** and then use **18** (10-key) to enter the tone number (WK-500: 676, 677, or 678) (WK-200: 576, 577, or 578) for the drum set whose sounds you want to change.

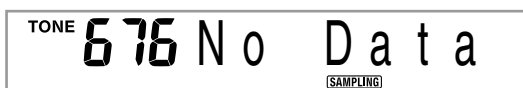

Lights

- In place of the above steps, you could press **28** and **16** at the same times and then select a tone number.

3. Press **28**.

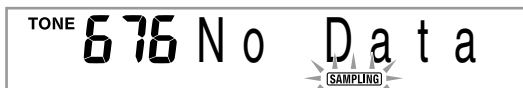

Flashes

4. Press the keyboard key to which you want to assign the drum sound you are about to sample.

This enters sampling standby.

The allowable sampling time (in seconds) will appear on the display momentarily and then the display will change to the following.



Flashes

**5. Output the sound from the external device. In the case of a microphone, output the sound in the direction of the microphone.**

Sampling will start automatically.



Lights

**6. After the sound you want to sample is finished, press  $\text{\textcircled{28}}$ .**

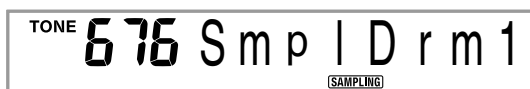

Remaining memory capacity

Sampling will stop when you release  $\text{\textcircled{28}}$ .

- Even if you do not press  $\text{\textcircled{28}}$ , sampling will stop automatically whenever there is no more sound being input from the external device or microphone. Sampling also will stop automatically 10 seconds after it is started.

**7. Press the keyboard key.**

**NOTE**

- You can repeat steps 3 through 6 to change other sounds that make up the currently selected drum set. There are eight sounds per drum set.
- You may not be able to get 10 seconds of sampling if Digital Keyboard memory is low due to storage of other data. If this happens, deleting other memory data you no longer need will free up memory space and you should be able to sample for 10 seconds. See "Deleting a Sampled Sound" on page E-23 for more information.

**IMPORTANT!**

- **Sampling a sound will delete any sound data currently assigned to the same keyboard key. To help ensure that you do not accidentally delete important data, be sure to read "Protecting Against Accidental Deletion of Sampled Sounds" on page E-24.**

**Editing Sampled Drum Set Sounds**

You can use the procedures in this section to copy the drum sound assigned to one keyboard key to another key, to change the pitch of a sound, and to delete a sampled sound.

1. Press  $\text{\textcircled{15}}$  and then use  $\text{\textcircled{16}}$  (10-key) to enter the tone number (WK-500: 676, 677, or 678) (WK-200: 576, 577, or 578) for the drum set you want.
2. Press  $\text{\textcircled{28}}$ .
3. Press  $\text{\textcircled{29}}$ .



Flashes at high speed

This is the editing mode.

- While in the editing mode, you can copy a sound, change the pitch of a sound, or delete a sound (each of which is described below). Pressing  $\text{\textcircled{29}}$  again exits the editing mode and returns to step 2 of this procedure.



Indicates keyboard keys that have sounds assigned.

**■ To copy a sampled sound from one key to another**

While holding down the keyboard key to which the sampled sound you want to copy is assigned, press the keyboard key to which you want to copy it.

*Example:* To copy sampled sound of key C4 to key D4



Indicates the keyboard key whose sound was copied.

- A keyboard key that already has a sampled sound assigned cannot be selected as a copy destination.

### ■ To change the pitch of a sampled sound

While holding down the keyboard key of the sampled sound whose pitch you want to change, use the **10** (10-key) [-] and [+] keys to change the pitch.

- You can change the pitch within a range of -64 to 63 semitones.

### ■ To delete a keyboard key's sampled sound

While holding down the keyboard key whose sound you want to delete, press **16**. In response to the "DelSure?" message that appears, press the **10** (10-key) [+] button to delete, or [-] to cancel the delete operation.

- Deleting a sampled sound will return the key to its initial default built-in sound.

*Example:* To delete the sound assigned to key D4

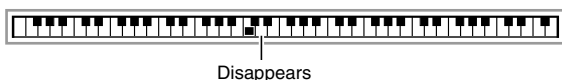

### Using a Drum Sampling Tone in Auto Accompaniment

Use the following procedure to change the rhythm part of an Auto Accompaniment pattern to a drum set sound that you sampled.

1. Press **16** and then use **10** (10-key) to enter the rhythm number of the Auto Accompaniment pattern you want.

You cannot use a Drum Sampling Tone in a user rhythm, so do not select a user rhythm in the above step.

2. Press **15** and then use **10** (10-key) to enter the tone number of the sampling drum set that contains the sound you want to use.

3. Press **15**.

This changes the rhythm part of the Auto Accompaniment pattern you selected in step 1 to the sampled sound you selected in step 2.

- To change the Auto Accompaniment rhythm part back to its original sound, press **15** again.

#### NOTE

- Some rhythm part drum sounds cannot be replaced by sampled sounds.

## Other Sampling Functions

### Changing to a Manual Sampling Start

Normally when the Digital Keyboard is in sampling standby, it will start sampling automatically whenever it detects sound input. You can use the following procedure to enable manual sampling start, which will cause sampling to wait until you press a button to start it. You can use this to insert silence before the sampled sound.

1. Press **29** and then use the **10** (10-key) [4] (←) and [6] (→) keys to display "SAMPLING" (page E-6).

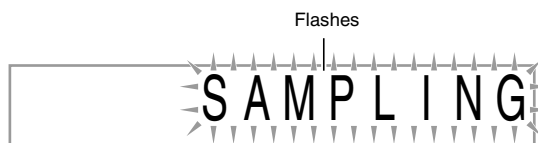

2. Press the **10** (10-key) [7] (ENTER) key.



3. Press the **10** (10-key) [-] key to turn off automatic sampling start.

This enables manual sampling start, which operates as described below.

- Melody sampling (page E-18): Sampling starts when you release **29**, which you press in step 2 of the sampling procedure.
- Drum sampling (page E-20): Sampling starts when you release the Digital Keyboard key you press in step 4 of the sampling procedure.

#### ! IMPORTANT!

- When manual sampling start is enabled, sampling starts when you release **29** or the keyboard key, not when you press it. Sampling does not start if you hold down the button or key.



## Changing to Manual Sampling Stop

Normally the Digital Keyboard will stop sampling automatically whenever it detects there is no sound input. You can use the following procedure to enable manual sampling stop, which will cause sampling to continue until you press a button to stop it. You can use this to insert silence after the sampled sound.

1. Press **29** and then use the **18** (10-key) [4] (←) and [6] (→) keys to display “SAMPLING” (page E-6).
2. Press the **18** (10-key) [7] (ENTER) key.
3. Press the **18** (10-key) [6] (→) key.

on Auto Stop

4. Press the **18** (10-key) [-] key to turn off automatic sampling stop.

Even when there is no sound input from an external device, sampling will continue until you press and release **29** or a keyboard key.

### IMPORTANT!

- When manual sampling stop is enabled, sampling stops when you release **29** or the keyboard key, not when you press it. Sampling does not stop if you hold down the button or key.

## Deleting a Sampled Sound

You can use the following procedure to specify a sampled tone number and delete its data.

1. Press **29** and then use the **18** (10-key) [4] (←) and [6] (→) keys to display “DELETE” (page E-6).

Flashes

DELETE

2. Press the **18** (10-key) [7] (ENTER) key.

671S1:Orgnl

SAMPLING

Used memory (Unit: Kbytes) 150 170 Remaining memory capacity

3. Use the **18** (10-key) [-] and [+] keys to select the tone number of the data you want to delete.
4. Press the **18** (10-key) [7] (ENTER) key. This displays a delete confirmation message.

Sure?

5. Press the **18** (10-key) [+] (YES) key to delete the data, or [-] (NO) or [9] (EXIT) to cancel the delete operation.
  - After the delete procedure is complete, “Complete” will appear on the display followed by the screen in step 2 of the above procedure.

### IMPORTANT!

- For information about deleting individual drum sounds in a drum sampling set, see “Editing Sampled Drum Set Sounds” on page E-21.

## Protecting Against Accidental Deletion of Sampled Sounds

You can use the following procedure to protect each sampled sound against accidental deletion.

1. Press **15** and then use **18** (10-key) to enter the tone number of the sampled tone you want to protect.
2. Press **29** and then use the **18** (10-key) [4] (←) and [6] (→) keys to display “SAMPLING” (page E-6).
3. Press the **18** (10-key) [7] (ENTER) key.
4. Use the **18** (10-key) [4] (←) and [6] (→) keys to display “Protect”.

The digital display shows the word "oFF" in a smaller font followed by "Protect" in a larger font.

5. Press the **18** (10-key) [+] key to turn on protection.

Once protected a tone cannot be deleted.  
A protected tone is indicated as shown below.

Protected

The digital display shows "671\*1:Orgnl". Above the "1" is a starburst icon with arrows pointing outwards, indicating protection. Below the "1" is a small box containing the word "SAMPLING".

### ■ Saving Sample Data on an External Device

- SD memory card (WK-500 only) (page E-61)
- Computer (page E-68)

### ■ Maintaining Sampled Sound Data in Memory

After you save sampled sound data in memory, it will remain there as long as power is supplied to the keyboard. However, if you disconnect the AC adaptor when there are no batteries loaded, sampled sound data will be deleted.

#### Tips for Maintaining Data

- Use both batteries and the AC adaptor together.
- Make sure that batteries with sufficient power are loaded whenever you disconnect the AC adaptor.
- Connect the AC adaptor to the keyboard and plug it into a power outlet before replacing batteries.

Before connecting or disconnecting the AC adaptor or replacing batteries, first press **1** to turn off power.

# Playing Built-in Songs

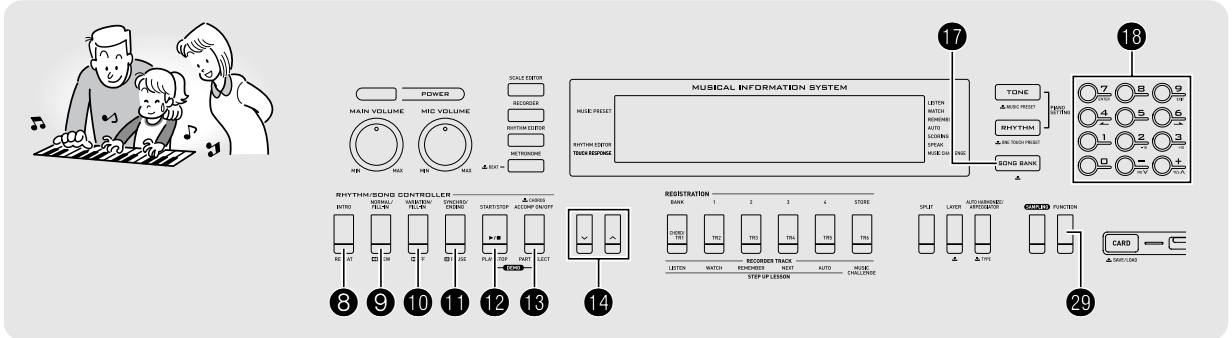

With this Digital Keyboard, built-in tune data is referred to as “songs”. You can listen to the built-in songs for your own enjoyment, or you can play along with them for practice.

## NOTE

- In addition to simple listening enjoyment, the built-in songs can be used with the lesson system (page E-29) for practice.
- You can increase the number of tunes using your SD memory cards (WK-500 only) (page E-62) or computer (page E-65).

## Playing the Demo Songs

Use the following procedure to play back built-in songs.

### 1. Press 12 and 13 at the same time.

This will start playback of the demo songs.

- See page E-75 for information about song numbers and the song sequence.
- Demo playback always starts from song number 151.



Flashes

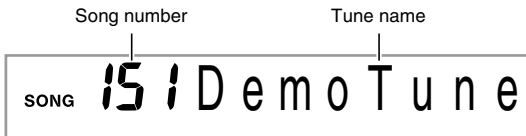

### 2. To change to another song while demo playback is in progress, use 18 (10-key) [-] and [+] keys to enter the song number you want (page E-6).

This will cause demo playback to jump to the song whose number you entered.

- You cannot use 18 (10-key) number buttons to select a song.

### 3. To stop demo playback, press 12.

Demo playback continues until you stop it by pressing 12.

## Playing Back a Particular Song

Use the procedure below to play back one of the built-in songs. You can play along on the keyboard with song playback.

### Start/Stop

#### 1. Press **17**.



#### 2. Use **18** (10-key) to enter the number of the song you want.

- See page E-75 for a complete list of available songs.

#### 3. Press **12**.

This starts playback of the song.

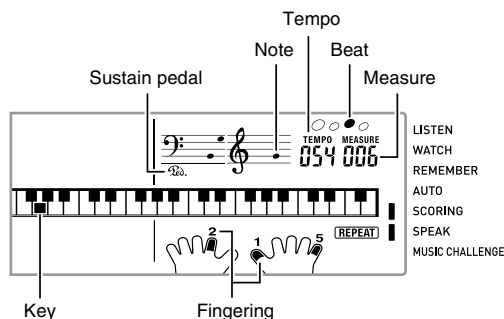

#### 4. Press **12** again to stop playback.

Song playback will continue (repeat) until you press **12** to stop it. You can cancel song repeat by pressing **8** ("REPEAT" indicator disappears from the display).

## Pause, Skip Forward, Skip Back

Use the operations in this section to perform pause, skip forward, and skip back operations.

### ■ Pause

#### 1. Press **11**.

This pauses song playback.

#### 2. Press **11** again to resume playback from the point where you paused it.

### ■ Skip Forward

#### 1. Press **10**.

This skips song playback forward to the next measure.

Each press of **10** skips ahead one measure. Holding down **10** skips forward at high speed until you release it.

- Pressing **10** while song playback is stopped performs lesson function phrase skip forward (page E-30).

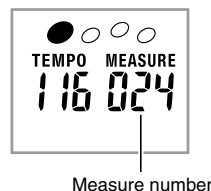

### ■ Skip Back

#### 1. Press **9**.

This skips song playback back to the previous measure.

Each press of **9** skips back one measure. Holding down **9** skips back at high speed until you release it.

- Pressing **9** while song playback is stopped performs lesson function phrase skip back (page E-30).

### Repeating Playback of Specific Measures

You can use the procedure in this section to repeat particular measures for practice playing along until you master it. You can specify the start measure and the end measure of the section you want to play and practice.

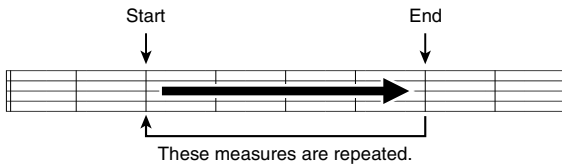

1. Press **Ⓜ** to temporarily turn off song repeat (“REPEAT” disappears from the display).
2. When song playback reaches the measure you want to specify as the start measure, press **Ⓜ**. This specifies the measure as the start measure.

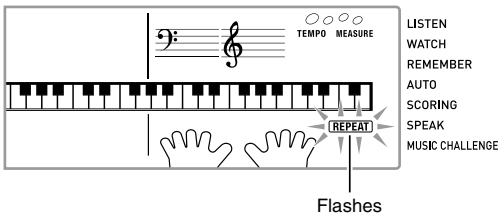

3. When playback reaches the measure you want to select as the end measure, press **Ⓜ** again. This specifies the measure as the end measure and starts repeat playback of the measures in the specified range.
  - During repeat play you can use **Ⓛ** to pause playback, **Ⓜ** to skip forward, or **Ⓛ** to skip back.

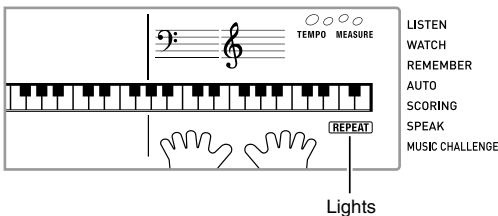

4. Pressing **Ⓜ** again returns to normal playback. Changing the song number clears the start measure and end measure of the repeat operation.

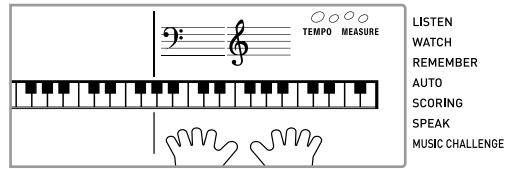

### Changing Playback Speed (Tempo)

You can use the following procedure to change the speed (tempo) in order to slow down playback to practice difficult passages, etc.

1. Press **Ⓜ**.
  - Use **Ⓜ** (slower) and **Ⓜ** (faster) to change the tempo setting. Holding down either button changes the setting at high speed.
  - Pressing **Ⓜ** and **Ⓜ** at the same time will return the current song to its original default tempo.
  - Pressing **Ⓜ** causes the tempo value to flash on the display. While the tempo value is flashing, you can use **Ⓜ** (10-key) to change it. The tempo value will stop flashing if you do not perform any operation for a short while.
  - Changing the song number will return the song to its original default tempo.

## Adjusting the Song Volume

Use the following procedure to adjust the balance between the volume of what you play on the keyboard and song playback volume.

1. Press **29** and then use the **19** (10-key) [4] (←) and [6] (→) keys to display “Song Vol” (page E-6).

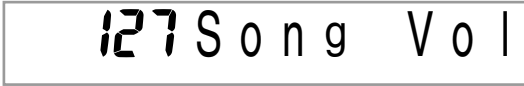

2. Use the **18** (10-key) [-] and [+] keys to adjust the song volume.

## Playing with the Tone as Song Playback

The procedure below lets you select the same keyboard tone as the one being used in the song and play along with your favorite tunes.

1. After selecting a song, hold down **17** for about two seconds until the displayed tone name changes to the tone name of the song.
  - If your currently selected tone is the same as the song tone, the display contents will not change.

2. Play along with song playback.

### NOTE

- If you select a song that uses different tones for left and right hand play, the right hand part tone is assigned to the keyboard.

## Turning Off the Part of One Hand for Practice (Part Select)

You can turn off the right hand part or the left hand part of a song during playback and practice playing along with the remaining part.

1. Press **15** to select the part you want to turn off. Each press of **15** cycles through the settings shown below.

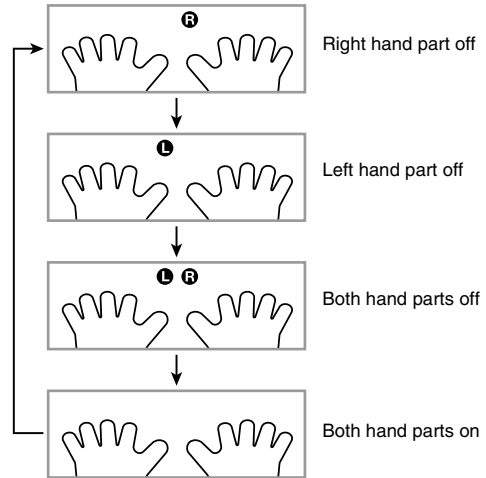

2. Press **12**.

This starts playback in accordance with the setting you selected in step 1.

### NOTE

- During playback with one part turned off, only the notes of the part that is turned off are shown on the display.

## Increasing the Selection of Songs

You can load song data from an external device and increase the selection of songs available on the keyboard. See the following pages for more information.

- SD memory card (WK-500 only) (page E-62)
- Computer (page E-68)

### NOTE

- For information about how to delete song data loaded from an external device, see page E-57.

# Using Built-in Songs to Master Keyboard Play

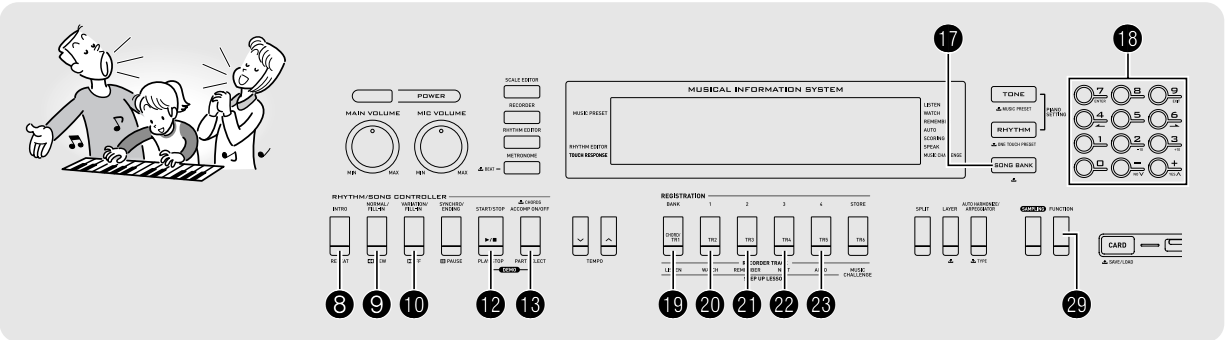

To master a song, it is best to break it up into shorter parts (phrases), master the phrases, and then put everything together. Your Digital Keyboard comes with a Step Up Lesson feature that helps you to do just that.

## Phrases

The built-in songs are pre-divided into phrases to help you master keyboard play.

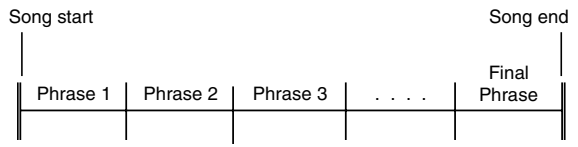

## Step Up Lesson Flow

Step Up Lesson takes you through practice of the right hand part, left hand part, and both hand parts for each phrase of a song. Master all of the phrases and you master the song.

- Phrase 1**
- Right Hand Lesson 1, 2, 3
  - Left Hand Lesson 1, 2, 3
  - Both Hand Lesson 1, 2, 3



Repeat the above to practice phrase 2, 3, 4, and so on, until you reach the final phrase of the song.

After mastering all of the phrases, practice the entire song.



Now you have mastered the entire song!

### Messages that Appear during Lessons

The following are the messages that appear on the display during Step Lessons.

Message	Description
<Phrase>	Appears when you select a phrase, when a lesson starts, etc. <ul style="list-style-type: none"> <li>Note that certain phrases will cause "Wait" to appear instead of "Phrase".</li> </ul>
<Wait>	Appears when the lesson starts with an intro or fill-in phrase that is not included in the phrases to be practiced. Play toll advance automatically to the next phrase after the un-included phrase plays, so wait until then to start playing on the keyboard.
NextPhrs	Appears when advancing automatically to the next phrase. This message appears following a phrase for which "Wait" (see above) is displayed, and during an Auto Step Up Lesson (page E-34).
From top	This message appears during Auto Step Up Lesson (page E-34) immediately before practice from Phrase 1 up until the phrase currently being practiced.
Complete	Appears at the end of Auto Step Up Lesson (page E-34).

### Selecting the Song, Phrase, and Part You Want to Practice

First, select the song, phrase, and part you want to practice.

#### 1. Select the song you want to practice (page E-26).

This will select the first phrase of the song.

#### 2. Press **22** (or **10**) to move forward one phrase, or **9** to move back one phrase.

- Holding down **10** or **9** scrolls through phrases at high speed.
- The Digital Keyboard remembers the last phrase you practiced for up to 20 songs. To recall the last practice phrase for the current song (if it is available), hold down **22**.

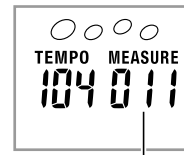
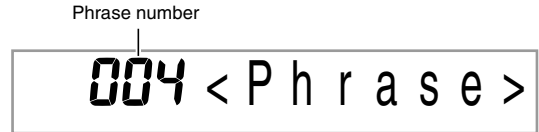

First measure of the selected phrase

#### 3. Press **13** to select the part you want to practice.

Each press of **13** cycles through the settings shown below.

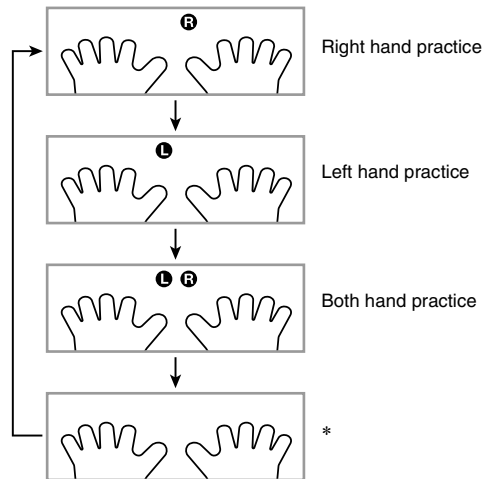

\* This indicator (setting) is skipped if you press **13** while a lesson is in progress.

#### 4. Hold down **17** for about two seconds.

The same tone used for song playback will be assigned to the keyboard (page E-28).



## Lessons 1, 2, and 3

Now it is time to start the lessons. First, select the song and part you want to practice.

### Lesson 1: Listen to the song.

First, listen to the example a few times to familiarize yourself with what it sounds like.

#### 1. Press **19**.

This starts example play.

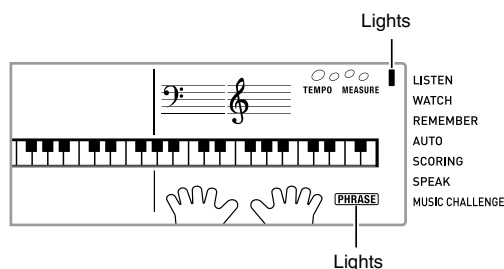

#### 2. To stop Lesson 1, press **19** or **12**.

### Lesson 2: Watch how the song is played.

Play the song on the keyboard. During this lesson, the display shows the key you need to press next. Voice fingering guide also uses a simulate voice to announce which finger you should use. Follow the instructions to press the correct keyboard keys and play the notes. Don't worry if you play the wrong note. Song playback will wait until you play the correct note. Take your time and play at your own pace.

#### 1. Press **20**.

This starts Lesson 2.

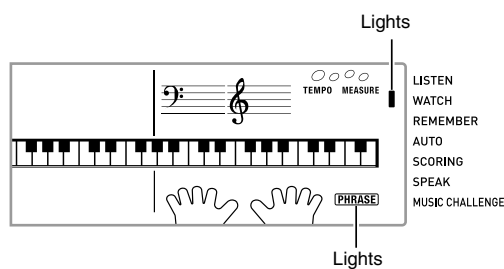

#### 2. Play notes on the keyboard in accordance with the instructions provided on the display and by voice fingering guide.

During this lesson, the display shows the key you need to press next. Voice fingering guide uses a simulate voice to announce which finger you should use.

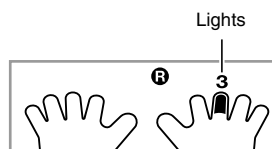
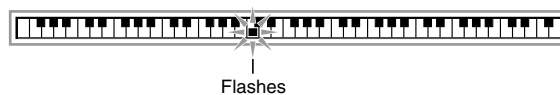

#### <Lesson 2 Guidance>

Master playing the correct note with the correct finger as instructed by the guidance. Practice playing with the correct timing.



Song playback will wait for you to play the correct note.

- Keyboard key goes from flashing to lit.
- Note guide sounds the correct note to be played.
- Voice Fingering Guide tells you what finger to use.



Pressing the correct keyboard key causes song playback to resume and the key for the next note flashes.

#### 3. To stop Lesson 2, press **20** or **12**.

- If you complete Lesson 2 play to the end, a score that rates your play appears on the screen.

<b>Bravo!</b>	You pass! Advance to the next lesson.
<b>Again!</b>	Go back and try again.

### Lesson 3: Remember what you learned as you play.

Though song playback stands by waiting for you to press the correct keys as in Lesson 2, the Digital Keyboard does not provide any guidance about what note you need to play next. Remember everything you have learned up to Lesson 2 as you play.

#### 1. Press 21.

This starts Lesson 3.

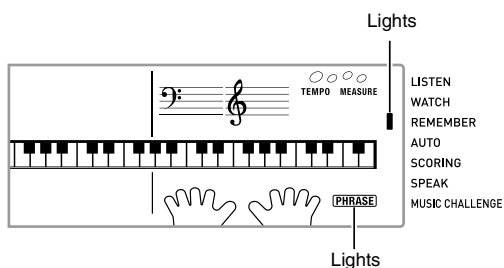

#### 2. Play the song along with the song playback.

##### <Lesson 3 Guidance>

Press the keyboard keys you learned in Lesson 2.



Song playback will wait for you to play the correct note.

- Note guide sounds the correct note to be played.



If you are still unable to press the correct keyboard key, the Digital Keyboard will display keyboard guidance and voice fingering guide will tell you what finger to use, just as in Lesson 2.



Pressing the correct key will cause song playback to resume.

#### 3. To stop Lesson 3, press 21 or 12.

- If you complete Lesson 3 play to the end, a score that rates your play appears on the screen the same as with Lesson 2.

### Playing a Particular Song All the Way Through

After you successfully complete all of the phrases in Lessons 1, 2, and 3, it is time to try playing the entire song from beginning to end.

#### 1. Use 18 to turn off both hand parts and then press 12.

Try playing with both hands and find out how the Digital Keyboard evaluates your effort.

## Lesson Settings

### Playing without Phrase Repeat

You can turn off phrase repeat for Lessons 1, 2, and 3.

#### 1. Press 8.

This disables phrase repeat play.

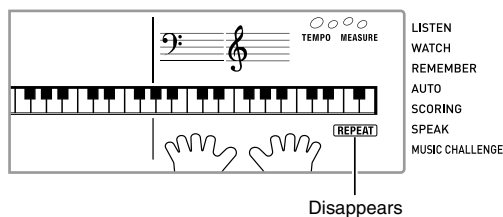

### Turning Off Voice Fingering Guide

Use the following procedure to turn off voice fingering guide, which tells you which finger to use to play each note in Lesson 2 and Lesson 3.

#### 1. Press 29 and then use the 18 (10-key) [4] (←) and [6] (→) keys to display "LESSON" (page E-6).



#### 2. Press 18 (10-key) [7] (ENTER) key.



3. Press the **18** (10-key) [-] key to select the OFF setting.

Indicator disappears  
when voice fingering  
guide is turned off.

SCORING  
SPEAK  
MUSIC CHALLENGE

### Turning Off Note Guide

Use the following procedure to turn off note guide, which sounds the note to be played next in Lesson 2 and Lesson 3.

1. Press **29** and then use the **18** (10-key) [4] (←) and [6] (→) keys to display “LESSON” (page E-6).
2. Press **18** (10-key) [7] (ENTER) key.
3. Use the **18** (10-key) [4] (←) and [6] (→) keys to display “NoteGuid”.

on NoteGuid

4. Press the **18** (10-key) [-] key to select the OFF setting.

### Turning Off Performance Evaluation

Use the following procedure to turn off performance evaluation, which evaluates your performance and displays a score in Lesson 2 and Lesson 3.

1. Press **29** and then use the **18** (10-key) [4] (←) and [6] (→) keys to display “LESSON” (page E-6).
2. Press **18** (10-key) [7] (ENTER) key.
3. Use the **18** (10-key) [4] (←) and [6] (→) keys to display “Scoring”.

on Scoring

4. Press the **18** (10-key) [-] key to select the OFF setting.

Indicator disappears  
when performance  
evaluation is turned off.

SCORING  
SPEAK  
MUSIC CHALLENGE

### Changing the Phrase Length

You can use the following procedure to change the length of lesson phrases, or to configure the lesson feature so the song is played all the way through, without being divided into phrases.

1. Press **29** and then use the **18** (10-key) [4] (←) and [6] (→) keys to display “LESSON” (page E-6).
2. Press **18** (10-key) [7] (ENTER) key.
3. Use the **18** (10-key) [4] (←) and [6] (→) keys to display “PhraseLn”.

PrE PhraseLn

4. Use the **18** (10-key) [-] and [+] keys to select the phrase length you want.

Off (oFF)	The phrase length is from the beginning to the end of the song.
Preset (PrE)	Phrase lengths are as specified in the song.

The following options are available for songs loaded from external sources only.

Short (Ln1)	Length of one phrase is one measure.
Middle (Ln2)	Length of one phrase is two measures.
Long (Ln3)	Length of one phrase is four measures.

## Using Auto Step Up Lesson

With Auto Step Up Lesson, the Digital Keyboard advances through each lesson automatically.

### 1. Select the song and part you want to practice (page E-26).

### 2. Press **23**.

Listen to the first phrase in Lesson 1.

- In Lesson 1, the sample phrase is played only once before advancing to Lesson 2.

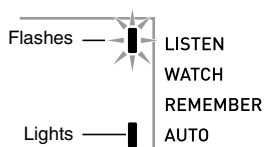

### 3. Auto Step Up Lesson stops automatically after you are able to get through all of the lessons successfully.

- In Lesson 2 and Lesson 3, the Digital Keyboard advances to the next lesson if you are able to achieve the "Bravo!" evaluation result.
- To cancel a lesson, press **23** or **12**.

#### NOTE

- You can change the step and phrase during Auto Step Up Lesson using **9**, **10**, and **19** to **22**.
- Starting Auto Step Up Lesson automatically turns on phrase repeat (page E-32) and play evaluation (page E-33). These features cannot be turned off during lessons.

## Auto Step Up Lesson Procedure

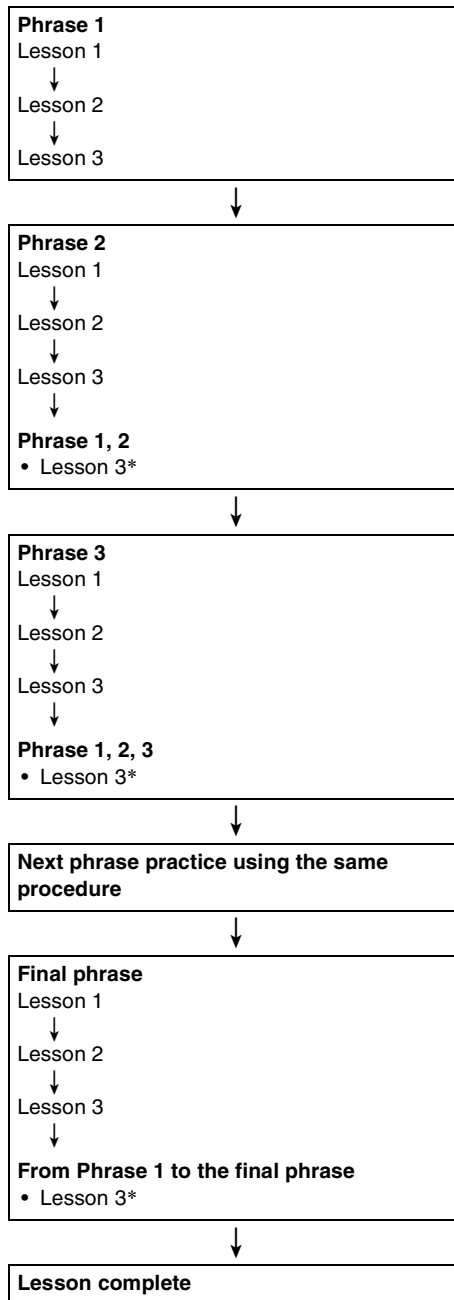

\* Auto Step Up Lesson advances to the next phrase, regardless of whether the "Bravo!" result is attained.

# Music Challenge Keyboard Game

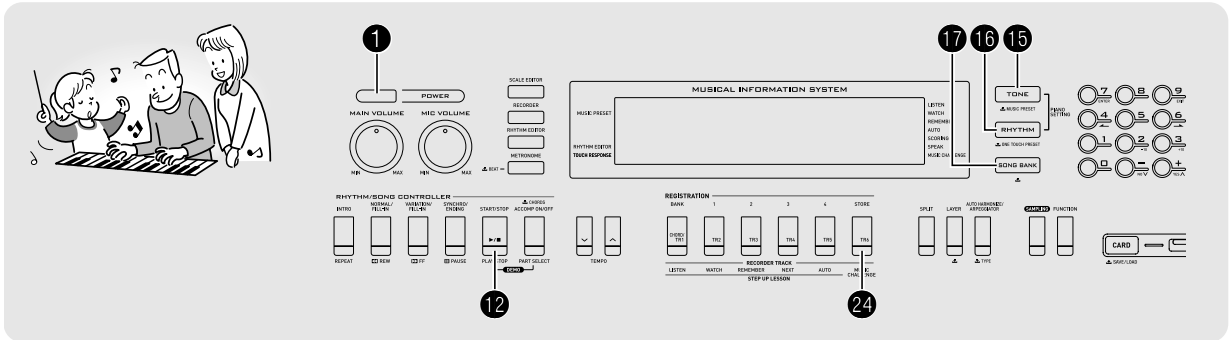

Music Challenge is a game in which the object is to press keys in accordance with the on-screen keyboard as quickly as possible.

1. Press **17**.
2. Press **24**.

This causes a key on the on-screen keyboard to start to flash, and starts the Music Challenge song.

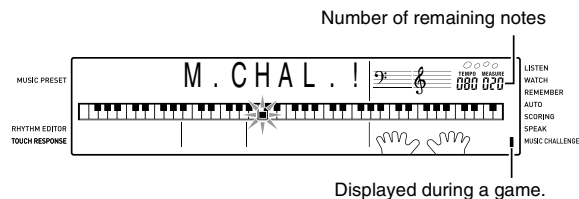

3. After the key changes from flashing to lit, press it as quickly as you can.

This causes the on-screen keyboard key to go out to let you know that you cleared the first note. The next on-screen keyboard key starts to flash, so get ready to press the next key.

- The time it takes you to press the keyboard key after the on-screen key lights appears on the display (Unit: 0.1 sec). The shorter the time, the higher your score.
- Pressing a keyboard key before the on-screen key goes from flashing to lit, will not advance to the next note.



4. The game ends when you advance successfully through 20 notes.

- Your playing time appears on the display. After a short while, the playing time display changes to a score. To clear the score from the display, press **15**, **16**, or **17**.
- You can cancel a game at any time by pressing **24** or **12**.

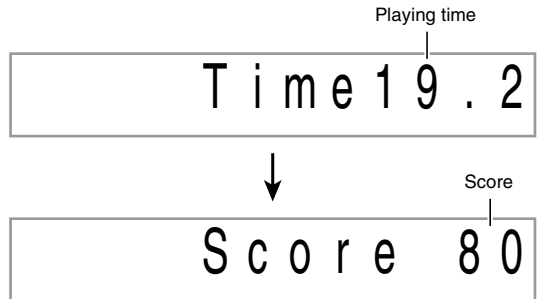

## NOTE

- The notes used for each game are selected randomly.
- The tempo of the game songs cannot be changed.
- All buttons except **1**, **12**, and **24** are disabled while a game is in progress.

# Using Auto Accompaniment

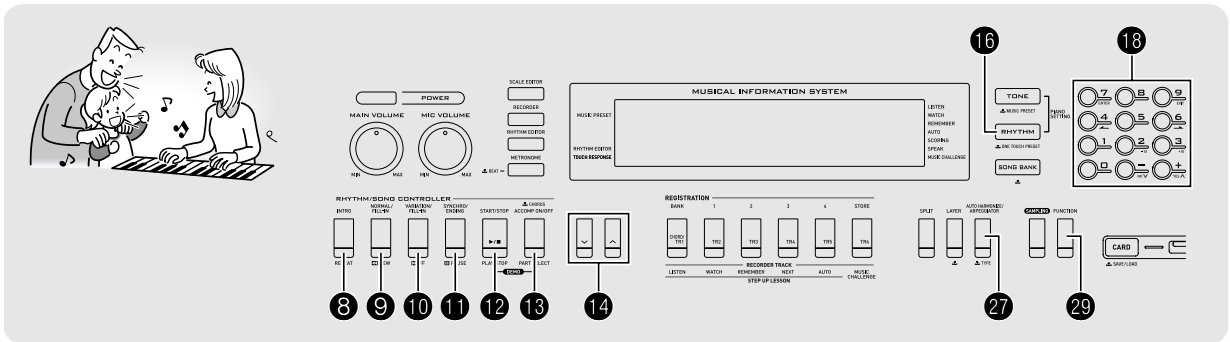

With Auto Accompaniment, simply select an accompaniment pattern. Each time you play a chord with your left hand the appropriate accompaniment will play automatically. It's like having a personal backup group along with you wherever you go.

## NOTE

- Auto Accompaniments are made up of the following three parts.
  - (1) Rhythm
  - (2) Bass
  - (3) Harmony

You can have only the rhythm part play, or you can have all three parts play at the same time.

## Playing the Rhythm Part Only

The rhythm part is the foundation each Auto Accompaniment. Your Digital Keyboard comes with a variety of built-in rhythms, including 8-beat and waltz. Use the following procedure to play the basic rhythm part.

## Starting and Stopping the Rhythm Part Only

- Press **16**.

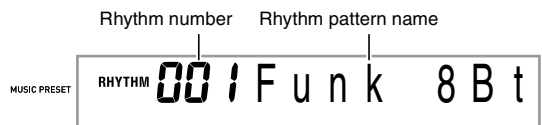

- Use **18** (10-key) to select the rhythm number you want.

- See the separate "Appendix" for information about individual rhythms.

- Press **12** or **9**.

This starts the rhythm.

This pattern changes with each beat.

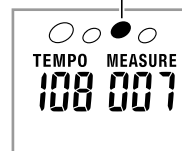

- Play along with the rhythm.

- To stop the rhythm, press **12** again.

## Playing All Parts

### Auto Accompaniment with Chords

Playing a chord with your left hand automatically adds bass and harmony accompaniment parts to the currently selected rhythm. It is just like having your own personal back up group on call.

**1. Start play of the Auto Accompaniment rhythm part.**

**2. Press **13**.**

This enables chord input on the accompaniment keyboard.

Accompaniment keyboard

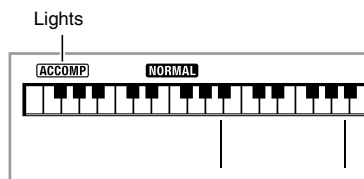
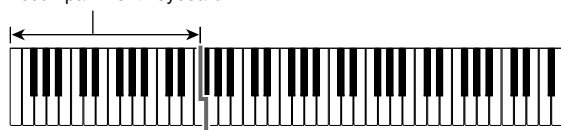

**3. Use the accompaniment keyboard to play chords.**

This will cause bass and harmony Auto Accompaniment parts to be added to the rhythm part.

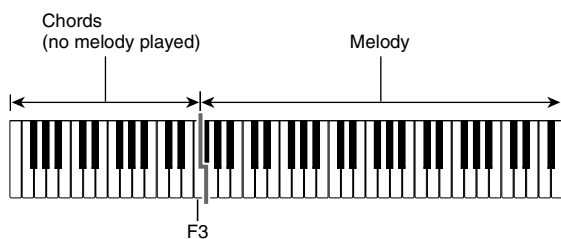

Example: Pressing D-F<sup>#</sup>-A-C on the accompaniment keyboard

↓  
Accompaniment for the D-F<sup>#</sup>-A-C chord (D7) sounds.

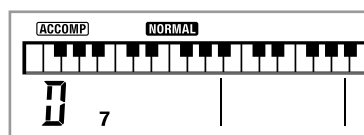

**4. Play other chords with left hand as you play the melody with your right hand.**

**5. Pressing **13** again returns to rhythm only accompaniment.**

### NOTE

- For information about starting Auto Accompaniment as soon as a chord is played, see “Using Synchro Start” on page E-40.
- You can use the split point to change the size of the accompaniment keyboard range (page E-14).

### Selecting a Chord Input Mode

You can select from among the following five chord input modes.

- FINGERED 1
- FINGERED 2
- FINGERED 3
- CASIO CHORD
- FULL RANGE CHORD

**1. Hold down **13** until the chord input mode selection screen appears on the display.**

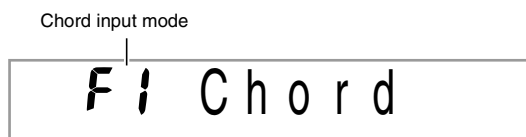

**2. Use the **13** (10-key) [-] and [+] keys to select the chord input mode you want.**

- For information about each chord input mode, see the separate “Appendix”.
- If you do not perform any operation after the chord input mode selection screen appears, the display will return automatically to the screen that was displayed before you held down **13**.

**FINGERED 1, 2, and 3**

With these three input modes, you finger 3-note or 4-note chords on the accompaniment keyboard. Note that with some chords, even if you do not finger the third or fifth note, they will be played anyway.

Accompaniment keyboard

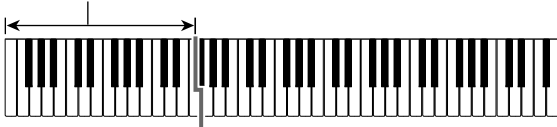

**FINGERED 1**

Play the component notes of the chord on the keyboard.



**FINGERED 2**

Unlike FINGERED 1, 6th input is not possible. m7 or m7<sup>b</sup>5 is input.



**FINGERED 3**

Unlike FINGERED 1, allows input of fraction chords with the lowest keyboard note as the bass note.



**CASIO CHORD**

With CASIO CHORD, you can use simplified fingerings to play the four types of chords described below.

Accompaniment keyboard

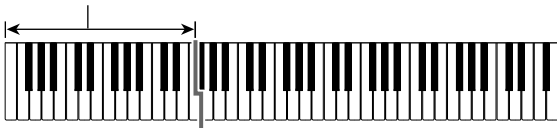

**CASIO CHORD Fingering**

Chord Type	Example
<p><b>Major Chords</b> Letters above the accompaniment keyboard indicate the chord assigned to each key. Pressing a single accompaniment area key in the CASIO CHORD mode will play the major chord whose name is marked above the key. All of the accompaniment area keys that are marked with the same chord name will play exactly the same chord.</p>	<p>C (C Major)</p>
<p><b>Minor Chords</b> To play a minor chord, press the accompaniment area key that corresponds to the major chord, while also pressing one other accompaniment area key to the right.</p>	<p>Cm (C Minor)</p>
<p><b>Seventh Chords</b> To play a seventh chord, press the accompaniment area key that corresponds to the major chord, while also pressing two other accompaniment area keys to the right.</p>	<p>C7 (C Seventh)</p>
<p><b>Minor Seventh Chords</b> To play a minor seventh chord, press the accompaniment area key that corresponds to the major chord, while also pressing three other accompaniment area keys to the right.</p>	<p>Cm7 (C Minor Seventh)</p>

**NOTE**

- When playing a minor, seventh, or minor seventh chord, it makes no difference whether the additional keys you press are black or white.

**FULL RANGE CHORD**

With this mode, you can use the full range of the keyboard to play chords and the melody.

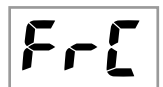

Accompaniment keyboard / Melody keyboard





## Using Auto Accompaniment Effectively

### Auto Accompaniment Pattern Variations

Use the following procedures to play intro and ending patterns, to play fill-in patterns, and to play variations of basic Auto Accompaniment patterns.

#### Auto Accompaniment Variation

Each Auto Accompaniment pattern has a basic “normal pattern” as well as a “variation pattern”.

##### 1. Press ⑩.

This starts the variation pattern.

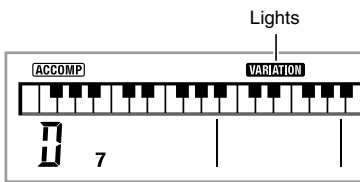

##### 2. Pressing ⑨ returns to normal pattern.

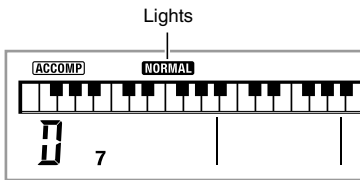

#### Auto Accompaniment Intro

Use the following procedure to play an intro of a few measures.

##### 1. Press ⑧.

This starts the intro pattern. Normal pattern play will start when the intro pattern is finished.

- If you press ⑩ while an intro pattern is being played, the variation pattern will start when the intro pattern is finished.

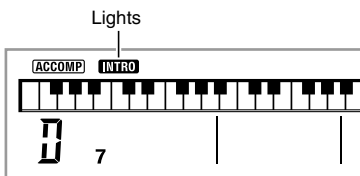

#### Auto Accompaniment Fill-in

Use the procedure below to play a fill-in pattern during a performance.

- A “fill-in” is a short phrase played where you want to change the mood of a piece. A fill-in pattern can be used to create a link between two melodies or an accent.
- Normal and variation patterns have their own unique fill-in patterns.

##### Normal Pattern Fill-in

##### 1. While a normal pattern is playing, press ⑨.

This plays the fill-in for the normal pattern.

- Normal pattern play will resume after the fill in pattern is complete.

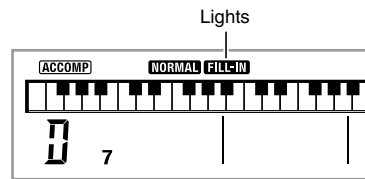

##### Variation Pattern Fill-in

##### 1. While a variation pattern is playing, press ⑩.

This plays the fill-in for the variation pattern.

- Variation pattern play will resume after the fill in pattern is complete.

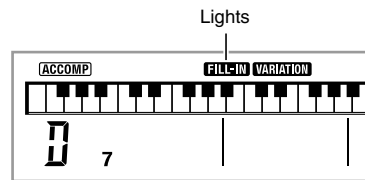

#### Auto Accompaniment Ending

Use the following procedure to play an ending of a few measures.

##### 1. While an Auto Accompaniment is playing, press ⑪.

This will play the ending pattern and then stop Auto Accompaniment play automatically.

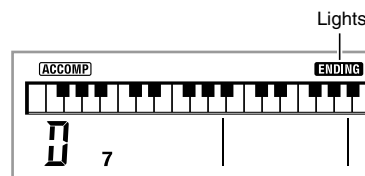

## ■ Using Synchro Start

Use the following procedure to configure the Digital Keyboard to start Auto Accompaniment play as soon as you press a keyboard key.

### 1. Press **11**.

This enters accompaniment start standby.

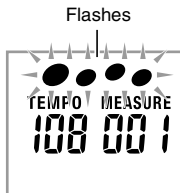

### 2. Play a chord on the keyboard.

This will start full part accompaniment (normal).

Any of the following operations can be performed while in synchro standby to start a non-normal pattern.

- To start with intro pattern, press **9**.
- To start with variation pattern play, press **10**.

## Changing Auto Accompaniment Speed (Tempo)

Use the following procedure to change Auto Accompaniment speed to a level that suits you.

### 1. Press **14**.

Use **∇** (slower) and **∧** (faster) to change the tempo setting. Holding down either button changes the setting at high speed.

- Pressing **∇** and **∧** at the same time will initialize the tempo setting in accordance with the currently selected rhythm.
- While the tempo value is flashing, you also can use **10** (10-key) to change it.
- If you do not perform any operation for a few seconds after the tempo setting screen appears, the display will return to the screen displayed before you pressed **14**.

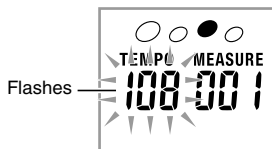

## Adjusting the Accompaniment Volume

Use the following procedure to adjust the balance between what you are playing on the keyboard and the volume of the Auto Accompaniment.

1. Press **29** and then use the **10** (10-key) [4] (**←**) and [6] (**→**) keys to display "AcompVol" (page E-6).



2. Use the **10** (10-key) [**-**] and [**+**] keys to adjust the accompaniment volume.

## Using One-Touch Preset

With One-Touch Preset, the Digital Keyboard automatically configures optimal tone, tempo, and other settings in accordance with the rhythm pattern you select.

1. Hold down **16** until the current tone screen appears on the display.

This will automatically apply the One-Touch Preset settings in accordance with the rhythm pattern that is currently selected.

2. Play a chord on the keyboard.

This will start accompaniment automatically.

## Using Auto Harmonize

Auto Harmonize automatically adds harmony to notes you play with your right hand, which adds rich depth to the melody of your performances. You can select from among 12 types of Auto Harmonize to suit the type of music you are playing.

### NOTE

- Auto Harmonize is controlled using the same button  as the Arpeggiator (page E-56). Because of this, these two functions cannot be used at the same time.

### 1. Press to enable Auto Accompaniment with chords (ACCOMP indicator lit) (page E-37).

- Auto Harmonize cannot be used while FULL RANGE CHORD is selected as the chord input mode. Select another mode if you want to use Auto Harmonize.

### 2. Hold down until the Auto Harmonize or Arpeggiator type number and type name appear on the display.

- If you do not perform any operation for a few seconds, the display will return to previous screen automatically.

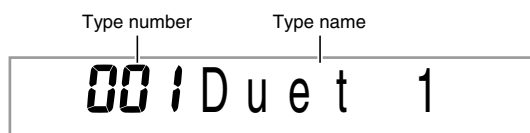

### 3. Use the (10-key) [-] and [+] keys to select the Auto Harmonize type you want.

- 013 through 102 are Arpeggiator types (page E-56). Do not select them when using the Auto Harmonize.

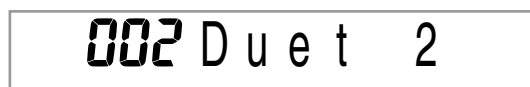

Type number	Type Name	Description
001	Duet 1	Adds close (separated by 2 to 4 degrees) 1-note harmony below the melody note.
002	Duet 2	Adds open (separated by more than 4 to 6 degrees) 1-note harmony below the melody note.
003	Country	Adds country style harmony.
004	Octave	Adds the note from the next lower octave.
005	5th	Adds the fifth degree note.
006	3-Way Open	Adds 2-note open harmony, for a total of three notes.
007	3-Way Close	Adds 2-note close harmony, for a total of three notes.
008	Strings	Adds harmony that is optimal for strings.
009	4-Way Open	Adds 3-note open harmony, for a total of four notes.
010	4-Way Close	Adds 3-note close harmony, for a total of four notes.
011	Block	Adds block chord notes.
012	Big Band	Adds big band style harmony.

### 4. Press to turn on Auto Harmonize.

If you play chords with your left hand and the melody with your right hand, harmony notes will be added to the melody.

- Press  again to turn off Auto Harmonize.

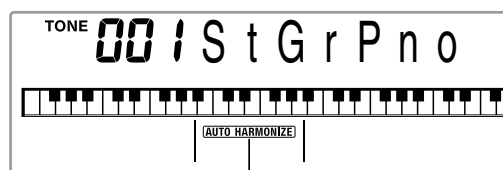

Lit when on

# Editing Auto Accompaniment Patterns

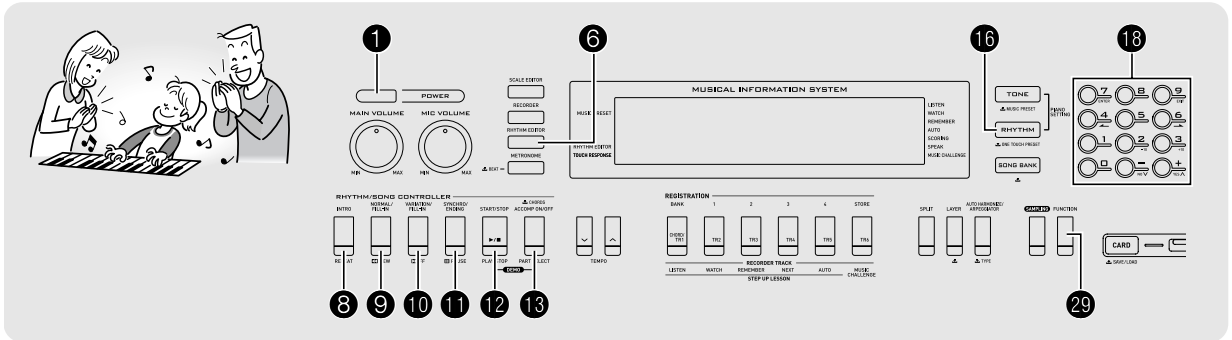

You can use the procedure in this section to edit the Digital Keyboard's built-in Auto Accompaniment rhythm patterns and create your own "user rhythms".

- You can store up to 10 user rhythms in Digital Keyboard memory, using rhythm numbers 201 through 210 (WK-200: 181 through 190).

## ■ Editable Accompaniment Patterns and Instrument Parts

Any of the following parts that make up each rhythm that is assigned a rhythm number can be edited. Accompaniment patterns (intro, fill-in, etc.): 6 types  
Instrument parts (drum, bass, etc.): 8 types

Instrument Parts		Accompaniment Pattern					
		INTRO	NORMAL	NORMAL FILL-IN	VARIATION	VARIATION FILL-IN	ENDING
1	Drum	I-1	N-1	NF-1	V-1	VF-1	E-1
2	Percussion	I-2	N-2	NF-2	V-2	VF-2	E-2
3	Bass	I-3	N-3	NF-3	V-3	VF-3	E-3
4	Chord 1	I-4	N-4	NF-4	V-4	VF-4	E-4
5	Chord 2	I-5	N-5	NF-5	V-5	VF-5	E-5
6	Chord 3	I-6	N-6	NF-6	V-6	VF-6	E-6
7	Chord 4	I-7	N-7	NF-7	V-7	VF-7	E-7
8	Chord 5	I-8	N-8	NF-8	V-8	VF-8	E-8

Button 13 ↓

Button 8   9   9   10   10   11

## ■ Editable Contents

- Rhythm number
- Part on/off
- Tone number
- Volume level
- Left-right speaker balance (panning)
- Reverb depth (reverb send)
- Chorus depth (chorus send)

## To edit and save an Auto Accompaniment

- Select the number of the rhythm you want to edit.
- Press 6.

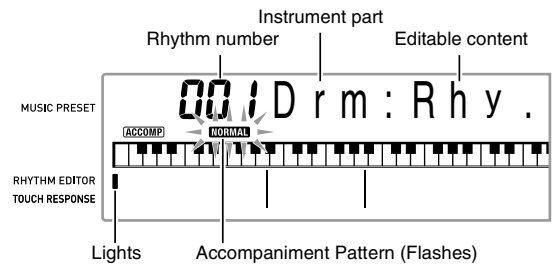

If the "Err Mem Full" message appears on the display, see page E-74 for information about what you should do.

**3. Press a button from 8 to 11 to select the Accompaniment Pattern you want to edit.**

The name of the pattern will appear on the display.



10 Variation selected

Pattern selected by each button

- 8: Intro
- 9: Normal, Normal Fill-in  
(Each press toggles the selection.)
- 10: Variation, Variation Fill-in  
(Each press toggles the selection.)
- 11: Ending

**4. Press 13 to select the instrument part you want to edit.**

The part number of the part you select will flash on the display.

Parts that contain data. Flashing: Part selected for editing.

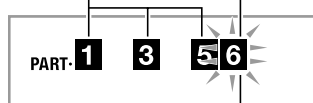

Part 6 (Chord 3)

**5. Press 16.**

This will display the rhythm number.

**6. Use the 18 (10-key) [-] and [+] keys to select the rhythm number you want to assign to the instrument part you are editing.**

A different rhythm number is assigned for each instrument part.

- You can play the data of the currently selected rhythm number by pressing 12.
- All of the eight instrument parts of an intro (I-1 to 8) must have the same rhythm number. If you assign rhythm 003 to I-1, for example, 003 also will be assigned automatically to parts I-2 through I-8. If you then assign rhythm 004 to part I-2, for example, I-1 and all of the other parts also will change to 004. All of the eight parts of an ending (E-1 to E-8) also must have the same rhythm number.

**7. To edit the other contents, press 29 to display the screen for the setting you want.**

- Each press of 29 will cycle through the settings shown below, from 1 through 6.
- Use the 16 (10-key) [-] and [+] keys to change the currently selected setting.
- You can play the current settings of the editable part by pressing 12.

	Setting Type	Display	Settings
1	Part on/off	Part	On/Off
2	Tone number*	Tone	001 - 553 (WK-200) 001 - 653 (WK-500)
3	Volume level	Vol.	000 - 127
4	Left-right speaker balance (panning)	Pan	-64 - 0 - 63
5	Reverb depth (reverb send)	Rvb	000 - 127
6	Chorus depth (chorus send)	Cho.	000 - 127

\* Instrument parts 1 and 2 can be assigned drum set tones only.

**8. Repeat steps 4 through 7 as many times as necessary to edit the parts you want for the pattern you selected in step 3.**

- If you change the rhythm number in step 6, the editable contents (1 through 6 in the above table) you last configured in step 7 of this procedure will be overwritten with the settings of the newly selected rhythm.

**9. Repeat steps 3 through 8 as many times as necessary to edit the accompaniment patterns you want (intro through ending).**

**10. Press 6.**



This will display a message asking if you want to save the user rhythm.

**11-1. Press the  (10-key) [-] key to exit without saving.**

This displays the delete confirmation message.  
Press the  (10-key) [+] key to exit the editing procedure.

**11-2. Press the  (10-key) [+] key to save the data.**





- Use  (10-key) [-] and [+] keys to select the rhythm number you want to save.
- You can edit the user rhythm name. Use the  (10-key) [4] (←) and [6] (→) keys to move the cursor to the character you want to change, and then use [+] and [-] to change the character.

!	"	#	\$	%	&	'	(	)	
*	+	,	-	.	/	0	1	2	3
4	5	6	7	8	9	:	;	<	=
>	?	@	A	B	C	D	E	F	G
H	I	J	K	L	M	N	O	P	Q
R	S	T	U	V	W	X	Y	Z	[
¥	]	^	_	`	a	b	c	d	e
f	g	h	i	j	k	l	m	n	o
p	q	r	s	t	u	v	w	x	y
z	{		}						

**12. Press  (10-key) [7] (ENTER) key.**

This will display a message asking if you want to save the user rhythm.

- Press the  (10-key) [+] key to save the data.
- Press the  (10-key) [-] key to return to the screen that was displayed before you pressed [7] (ENTER) key.

 **IMPORTANT!**

- **If you select a user rhythm number that already contains data, the existing data will be replaced by the new data.**

 **NOTE**

- You cannot change the tone assigned to the keyboard while an Auto Accompaniment editing (rhythm edit) operation is in progress.

**■ Saving User Rhythm Data on an External Device**

- SD memory card (WK-500 only) (page E-61)
- Computer (page E-68)

**■ Maintaining User Rhythm Data in Memory**

After you save user rhythm data in memory, it will remain there as long as power is supplied to the keyboard. However, if you disconnect the AC adaptor when there are no batteries loaded, user rhythm data will be deleted.

**Tips for Maintaining Data**

- Use both batteries and the AC adaptor together.
- Make sure that batteries with sufficient power are loaded whenever you disconnect the AC adaptor.
- Connect the AC adaptor to the keyboard and plug it into a power outlet before replacing batteries.

Before connecting or disconnecting the AC adaptor or replacing batteries, first press  to turn off power.

## To delete saved data

The following procedure cannot be performed while an Auto Accompaniment editing (rhythm edit) operation is in progress.

1. Press **29** and then use the **18** (10-key) [4] (**←**) and [6] (**→**) keys to display “DELETE” (page E-6).

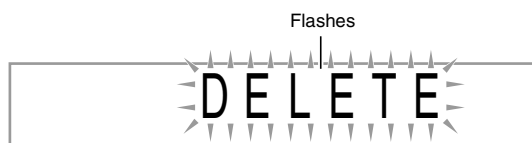

Used memory (Unit: Kbytes)

150 170

Remaining memory capacity

2. Press the **18** (10-key) [7] (ENTER) key.

3. Press the **18** (10-key) [6] (**→**) key.

User rhythm name

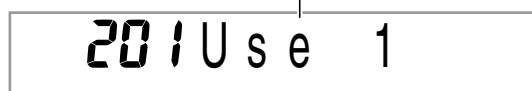

4. Use the **18** (10-key) [-] and [+] keys to select the user rhythm you want to delete.

5. Press the **18** (10-key) [7] (ENTER) key.

This displays a delete confirmation message.



6. Press the **18** (10-key) [+] (YES) key.

After the delete procedure is complete, “Complete” will appear followed by the screen in step 2 of the above procedure.

- To cancel the delete operation, press [-] (NO) or [9] (EXIT) in place of [+] (YES).

# Saving Keyboard Setups to Registration Memory

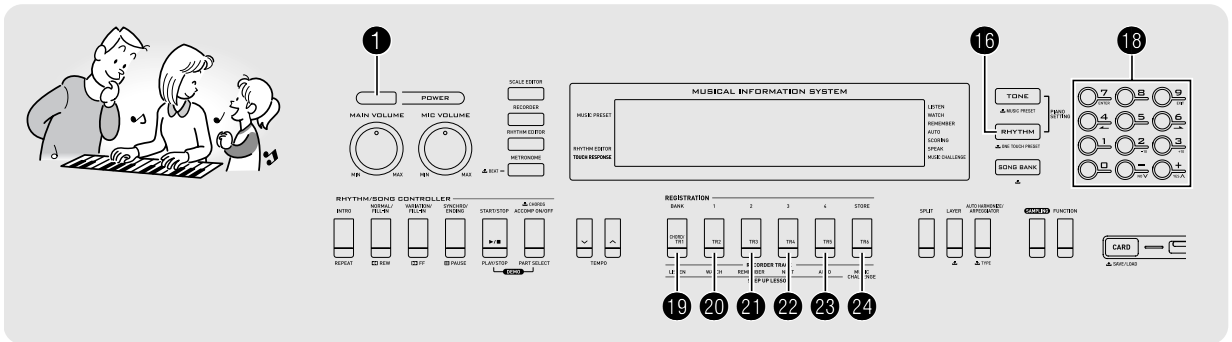

Registration memory lets you store Digital Keyboard setups (tone, rhythm, etc.) for instant recall whenever you need them. Registration memory simplifies performance of complex pieces that require successive tone and rhythm changes.

You can have up to 32 setups in Registration memory at one time. 19 and 20 to 23 are used for recording.

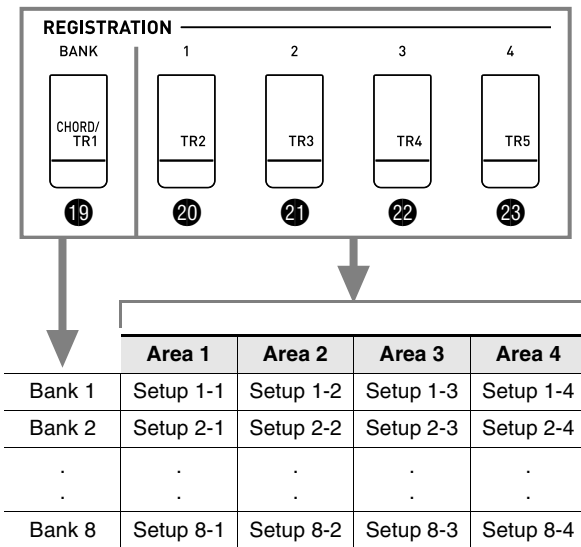

- Each press of bank select button 19 cycles through the bank numbers, from 1 to 8.
- Pressing a button from 20 to 23 selects the corresponding area in the currently selected bank.

## Registration Save Example

This example saves the data shown in the table below to the following setups in Bank 1.

- Initial melody setup saved to Setup 1-1.
- Second melody setup saved to Setup 1-2.
- Third melody setup saved to Setup 1-3.

	Setup 1-1	Setup 1-2	Setup 1-3
Tone Number	001	062	001
Rhythm Number	118	005	089
Tempo	080	140	089

## Registration Memory Data

The following is the complete list of data that is saved to a registration memory setup.

- Tone numbers (main, layer, split)
- Rhythm number
- Tempo
- Auto Harmonize
- Transpose
- Split point
- Touch Response
- Octave shift
- Chord fingerings
- Accompaniment volume
- Arpeggiator setting (on, off, type)
- Synchro start
- Reverb (on, off, type)
- Chorus (on, off, type)
- Bend Range (WK-500 only)
- Accomp (on, off)
- Arpeggiator hold (on, off)
- Layer (on, off)
- Split (on, off)
- Pedal effect



## To save a setup to registration memory

### 1. Press **16**.

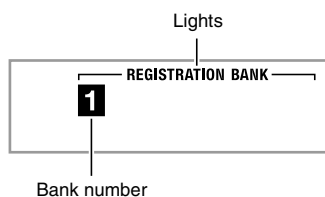

### 2. Configure the tone, rhythm, and other settings you can to include in the setup.

### 3. Press **19** to select the bank you want.

Each press of **19** cycles through the bank numbers.

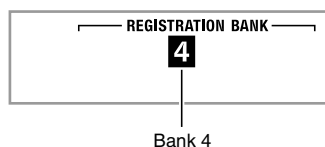

- You also can select a bank by holding down **19** as you use the **16** (10-key) number buttons to enter a bank number.

### 4. While holding down **24**, press a button from **20** to **23** to select an area.

This will save the settings you configured in step 2 into the applicable setup.

- If there is anything already stored in the setup, it will be replaced (deleted) by the new setup.

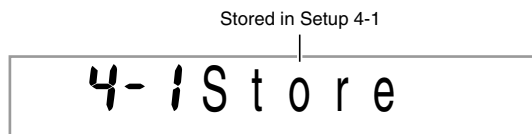

## To recall a setup from registration memory

### 1. Press **19** to select the bank that contains the setup you want to recall.



### 2. Use buttons **20** to **23** to select the area whose setup you want to recall.

This will recall the registration memory setup and automatically configure the Digital Keyboard settings accordingly.

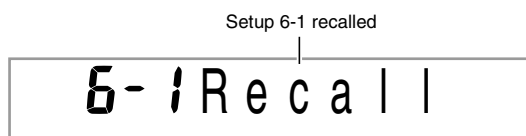

#### NOTE

- Notes currently being sounded by the keyboard may stop if you recall a setup that causes a change in octave shift (page E-16). To keep this from happening, either select a setup that does not cause a change in the octave shift setting, or hold down the pedal (which will cause notes currently being played to be sustained).

#### ■ Saving registration Data on an External Device

- SD memory card (WK-500 only) (page E-61)
- Computer (page E-68)

#### ■ Maintaining Data in Registration Memory

After you save data in registration memory, it will remain there as long as power is supplied to the keyboard. However, if you disconnect the AC adaptor when there are no batteries loaded, data in registration memory will be deleted.

#### Tips for Maintaining Data

- Use both batteries and the AC adaptor together.
- Make sure that batteries with sufficient power are loaded whenever you disconnect the AC adaptor.
- Connect the AC adaptor to the keyboard and plug it into a power outlet before replacing batteries.

Before connecting or disconnecting the AC adaptor or replacing batteries, first press **1** to turn off power.

# Recording Your Keyboard Play

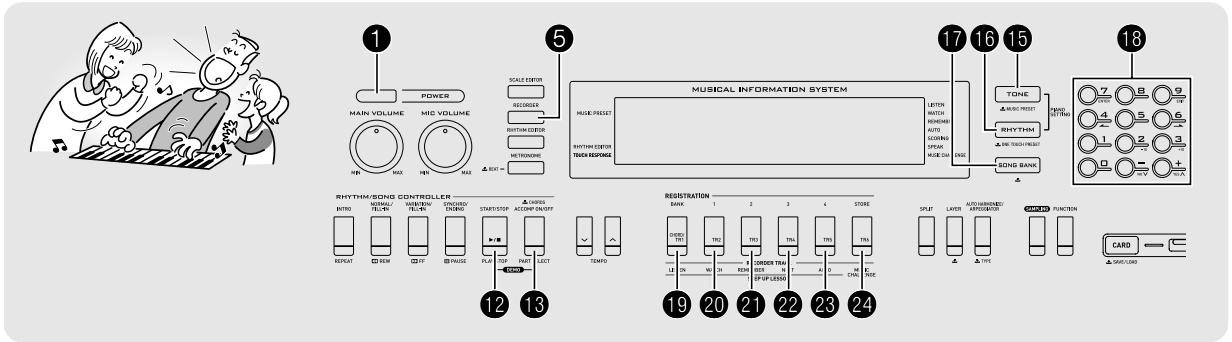

The recorder feature lets you record your keyboard play.

## Recording and Playing Back Keyboard Play

Use the following procedure to record everything you play on the keyboard.

1. Press **16**.
2. Press **5**.

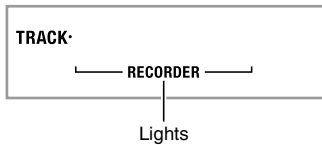

3. Press **5** again.  
This will enter record standby.

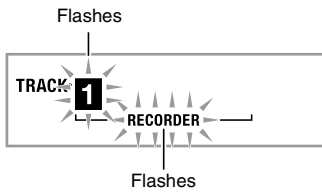

4. Configure the tone, rhythm, and other settings you want to use.

5. Start playing.

Recording starts as soon as you play something on the keyboard.

### NOTE

- You can use Auto Accompaniment while playing. If you do, Auto Accompaniment also will be recorded.

6. To stop recording, press **12**.

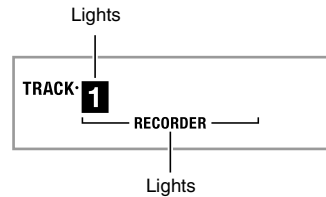

7. To play back what you have recorded, press **12** again.

Each press of **12** starts and stops playback.

## 8. Press **F5** twice to exit the recorder mode.

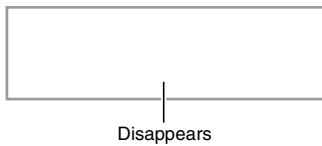

- The flashing on the screen shown in step 3 becomes faster when remaining recorder memory capacity becomes less than 100 notes.
- Total recorder memory capacity is approximately 12,000 notes. Recording will stop automatically when there is no more unused recorder memory remaining.
- Each press of **F5** cycles through the settings shown below. You can listen to the recorded data as many times as you like by pressing **F12** while in playback standby.

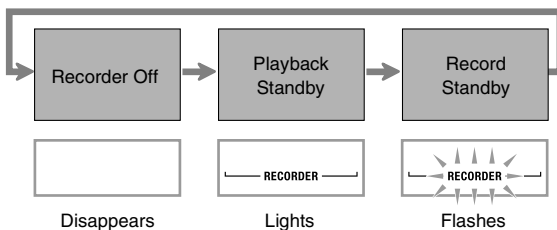

### ■ To delete recorded data

After step 3 of the above procedure, do hold down **F5** (without pressing any keyboard key) until the message "Tr.Del?" appears on the display. Press **[+]** (YES) to delete the data, or **[-]** (NO) to cancel the delete operation.

### ! IMPORTANT!

- Turning off the Digital Keyboard while recording is in progress will cause any data in recorder memory to be deleted.
- A new recording replaces (deletes) previously recorded contents.

### ■ Maintaining Data in Recorder Memory

After you save data in recorder memory, it will remain there as long as power is supplied to the keyboard. However, if you disconnect the AC adaptor when there are no batteries loaded, data in recorder memory will be deleted.

#### Tips for Maintaining Data

- Use both batteries and the AC adaptor together.
- Make sure that batteries with sufficient power are loaded whenever you disconnect the AC adaptor.
- Connect the AC adaptor to the keyboard and plug it into a power outlet before replacing batteries.

Before connecting or disconnecting the AC adaptor or replacing batteries, first press **F1** to turn off power.

## Using Tracks to Record and Mix Parts

You can divide a song according to various types of parts (instrument, left and right hand, etc.), and record each part to a specific track. You can mix up to six tracks (the original track plus five additional tracks) into a final song.

### ■ About tracks

Tracks are numbered from 1 to 6.

- If you do not specify a track number when recording, recording is performed to Track 1 automatically.

In addition to what you play on the keyboard, the following information also is recorded.

#### • Track 1

Settings:

Tone number, rhythm number, tempo, reverb, chorus, chords, layer/split settings, Auto Harmonize/Arpeggiator setting

Operations:

Pedal, pitch bend wheel (WK-500 only), INTRO button, SYNCHRO/ENDING button, NORMAL/FILL-IN button, VARIATION/FILL-IN button

#### • Tracks 2 through 6

Tone number, pedal operation, pitch bend wheel operation (WK-500 only)

**To record to Tracks 1 through 6**

**1. Record the first part to Track 1.**

To record to Track 1, perform steps 1 through 4 under "Recording and Playing Back Keyboard Play" (page E-48).

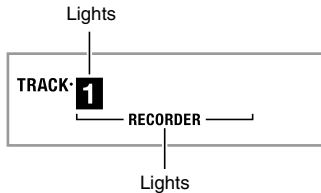

**2. Press 5.**

This will enter record standby.

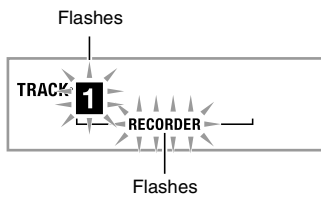

**3. Press a button from 20 to 24 to select the track number of the next track to which you want to record.**

This will enter record standby for the track you selected.  
Example: Track 2

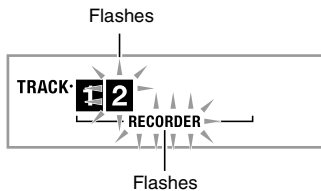

- If you want to use a different tone than the one you used in Track 1, press 15 and then use 10 (10-key) to input the tone number.

**4. Press 12.**

This will start playback of what you recorded up to this point in other tracks and record what you play on the keyboard to the currently selected track. Play the notes you want on the keyboard.

**5. To stop recording, press 12.**

- To play back what you have recorded, press 12 again. Each press of 12 starts and stops playback.



**6. Repeat steps 2 through 5 to record the other tracks.**

**7. After you finish recording all of the tracks, press 12.**

- This will start playback of the recorded tracks. Press 12 to stop or restart playback.
- At this time you can turn off playback of specific tracks using buttons 19 to 24. Pressing a key toggles playback of each track on (track number displayed) or off (track number not displayed).
- If you want to re-record a track, press 5. This will return to step 2 of the above procedure. Only the tracks that are turned on (displayed) above will play as you re-record.

Example: Tracks 2 and 3 selected

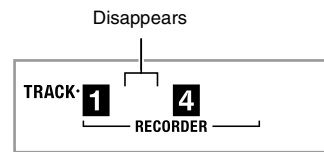

**8. Press 5 twice to exit the recorder mode.**

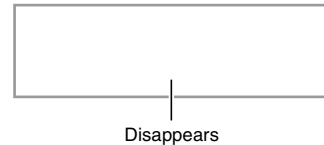

**To delete a recorded track**

After step 3 of the above procedure, do hold down 5 (without pressing any keyboard key) until the message "Tr.Del?" appears on the display. Press [+] (YES) to delete the track, or [-] (NO) to cancel the delete operation.

## Recording Two or More Songs, and Selecting One for Playback

You can record up to five songs (numbered 1 through 5) in memory. After that, you can select a specific song for playback.

### 1. Press **16**.

### 2. Press **5**.

A song number will appear in the upper left corner of the display for a few seconds. While it is, use **18** (10-key) to specify the number of the song you want to record or play back. The song number will disappear if you do not perform any operation.

*Example: Track 2*

502 Play No.

### 3. Press **5** to record, or **12** to play back.

To stop recording or playback, press **12**.

### 4. Press **5** twice to exit the recorder mode.

#### ■ To delete recorded data

After step 2 of the above procedure, do hold down **5** (without pressing any keyboard key) until the message "Song Del?" appears on the display. Press **+** (YES) to delete the song, or **-** (NO) to cancel the delete operation.

## Recording while Playing Along with a Built-in Song

This section explains how to play along and record along with one of the Digital Keyboard's built-in songs.

### ● The following operations and settings also are recorded along with your keyboard play.

Tone number, song number, pedal operation, tempo, reverb, chorus, layer/split settings, pitch bend wheel operation (WK-500 only)

#### NOTE

- There can be only one recording of keyboard play with a built-in song in recorder memory. Making a new recording replaces (deletes) previously recorded data.

### 1. Press **17**.

### 2. Press **5**.

This will enter playback standby.

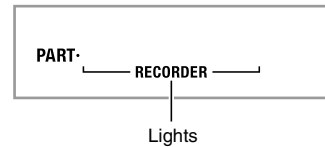

### 3. Press **5** again.

This will enter record standby.

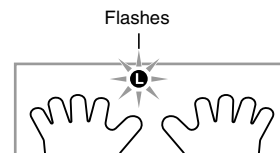
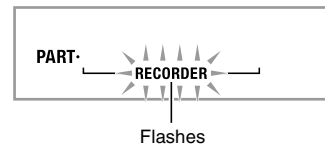

### 4. Use **18** (10-key) to enter the song number you want to assign to the recording.

5. Press **18** to cycle through the parts in the sequence shown below.

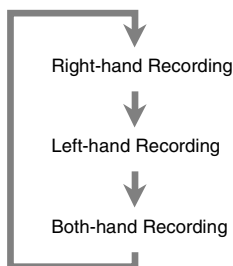

Example: Left-hand part recording

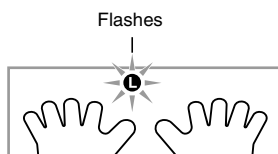

- Configure tone and tempo settings at this time as well.

6. Press **12** to start built-in song playback and recorder recording.

Play along with the playback.

- To stop recording part way through, press **12**.

7. Recording will stop automatically when the end of the built-in song is reached.

This will enter playback standby.

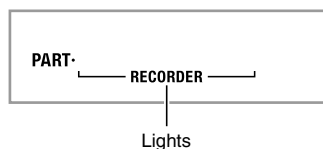

8. Press **12**.

This will start playback of what you recorded.

- Each press of **12** starts and stops playback.

9. Press **5** twice to exit the recorder mode.

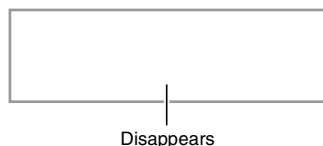

■ To delete recorded data

After step 2 of the above procedure, do hold down **5** until the message "Song Del?" appears on the display. Press **[+]** (YES) to delete the song.

## Saving Recorded Data on an External Device

You can save data you record with the Digital Keyboard onto an SD memory card or on your computer's hard disk. In the case of an SD memory card, you can save recorded song data as a standard MIDI file (SMF 0 format).

■ To save data to an SD memory card (WK-500 only)

See page E-61.

■ To save data on your computer's hard disk

See page E-68.

# Other Useful Digital Keyboard Functions

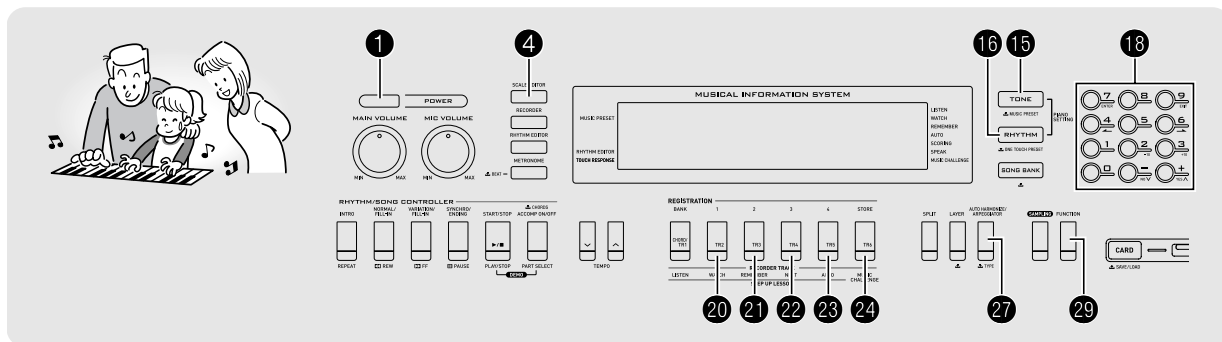

## Changing the Scale of the Keyboard

You can use the procedure in this section to change the scale (tuning system) of the keyboard from the standard equal temperament to another scale that is more suitable for playing Indian music, Arabic music, ancient classics, etc.

### Using the Scale Editor (WK-500 Only)

The Scale Editor provides you the following four options for changing the scale.

	Display Indicator	Description
Scale Fine Tune	"Fin" "ScalMode"	Changes the tuning value in 1-cent steps within the range of +99 to -99 cents.
Quarter Tone	"qUA" "ScalMode"	Lowers the tuning value by -50 cents. Use the option to lower the E and G notes of the scale for Arabic music.
Preset	"PrE" "ScalMode"	Use this option to select from among a collection of preset scales.
Equal Temperament	"EqU" "ScalMode"	Changes the scale to the standard equal temperament.

1. Press 4 and 29 at the same time.

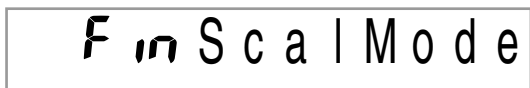

2. Use the 18 (10-key) [-] and [+] keys to select the Scale Editor option you want.

- If you do not perform any operation for a few seconds after the selection screen appears, the display will return to the previous screen automatically.

3. Press 4.

Now you can perform one of the scale editing operations described below.

### Scale Fine Tune

1. Press the key whose note you want to change, and then use the 18 (10-key) [-] and [+] keys to change the tuning value.
2. After you are finished, press 4 to assign the scale to the keyboard.



The keyboard key(s) whose notes were changed will be lit.

■ Quarter Tone

1. Press the key whose note you want to change, and then press the **10** (10-key) [-] key to reduce the tuning value by -50 cents. You can return to the original tuning by pressing [+].
2. After you are finished, press **4** to assign the scale to the keyboard.

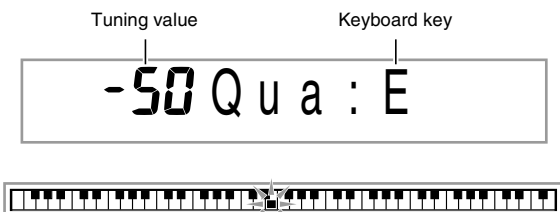

The keyboard key(s) whose notes were changed will be lit.

**NOTE**

- You can perform a Quarter Tone operation without using the Scale Editor (page E-53). Hold down the **4** button and press the desired keyboard key. This will lower the tuning value of the keyboard key by -50 cents. If the tuning value of the key you press was previously lowered by -50 cents, performing the above operation will raise it +50 cents, which returns to its original value.

■ Preset

1. Use the **10** (10-key) [-] and [+] keys to select the preset scale you want. After selecting a scale, press the key on the keyboard that you want to use as the root key (C to B).
2. After you are finished, press **4** to assign the scale to the keyboard.



No.	Scale name	Display
01	Pure Major	PureMajr
02	Pure Minor	PureMinr
03	Pythagorean	Pythagor
04	Kirnberger 3	Kirnbrg3
05	Werckmeister	Wercmeis
06	Mean-Tone	MeanTone
07	Rast	Rast
08	Bayati	Bayati
09	Hijaz	Hijaz
10	Saba	Saba
11	Dashti	Dashti
12	Chahargah	Chaharga
13	Segah	Segah
14	Gurjari Todi	GujrTodi
15	Chandrakauns	Cndrkuns
16	Charukeshi	Carukesi

■ Equal Temperament

Select this option to change the keyboard scale to the standard equal temperament.

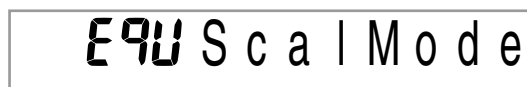



### Recalling a Preset Scale (WK-200 Only)

You can use the following procedure to select from among 17 preset scales, including the standard Equal Temperament.

1. Press **16**.
2. Press **4**.

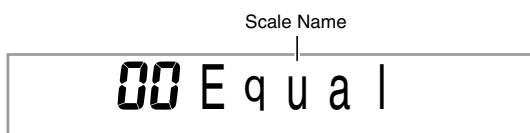

3. Use the **18** (10-key) [-] and [+] keys to select the preset scale you want. After selecting a scale, press the key on the keyboard that you want to use as the root key (C to B).

- There are a total of 17 scales: the 16 shown in the table above (page E-54) plus Equal Temperament (Number: 00, Scale Name: Equal).

4. After you are finished, press **4** to assign the scale to the keyboard.

### Saving User Scales (WK-500 Only)

You can store up to four “user scales” configured by you in memory for later recall when you need them.

#### ■ To save a user scale

1. Press **16**.
2. Press **4**.
3. While holding down **24**, press a button from **20** to **23** to select an area.

#### ■ To recall a user scale

1. Press **16**.
2. Press **4**.
3. Use buttons **20** to **23** to select the user scale you want to recall.

### ■ Saving Data on an External Device (WK-500 only)

- SD memory card (page E-61)
- Computer (page E-68)

### ■ Maintaining Data in User Scale Memory (WK-500 only)

After you save data in user scale memory, it will remain there as long as power is supplied to the keyboard. However, if you disconnect the AC adaptor when there are no batteries loaded, data in user scale memory will be deleted.

#### Tips for Maintaining Data

- Use both batteries and the AC adaptor together.
- Make sure that batteries with sufficient power are loaded whenever you disconnect the AC adaptor.
- Connect the AC adaptor to the keyboard and plug it into a power outlet before replacing batteries.

Before connecting or disconnecting the AC adaptor or replacing batteries, first press **1** to turn off power.

### Using the Current Scale Notes for Auto Accompaniments

You can use the following procedure to reflect the scale you adjusted using the scale fine tune or the quarter tone function, or the preset scale you selected with the preset function in Auto Accompaniments.

1. Press **29** and then use the **18** (10-key) [4] (←) and [6] (→) keys to display “OTHER” (page E-6).

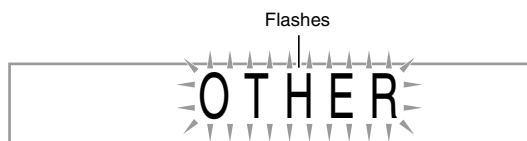

2. Press **18** (10-key) [7] (ENTER) key.
3. Use the **18** (10-key) [4] (←) and [6] (→) keys to display “AcompSci”.
4. Use the **18** (10-key) [+] key to select on.

## Using Music Preset

Selecting a Music Preset instantly changes the Digital Keyboard to a preset setup (tone, rhythm, tempo, etc.) for play of songs of various genres/categories. The press of a button sets up the Digital Keyboard so those songs sound exactly the way you thought they should.

- See the separate “Appendix” for a complete list of the 305 Music Presets that are available.

**1. Hold down **15** until the indicator shown below appears on the display.**

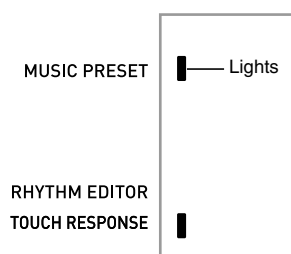

**2. Use **18** (10-key) to select the preset number you want.**

This will change the setup (tone, rhythm, etc.) of the Digital Keyboard.

- At this time the Digital Keyboard will go into Auto Accompaniment synchro start standby (page E-40).
- Pressing **15**, **16**, or **17** will return to the screen that was displayed before you held down in step 1, above.

**3. Play along on the keyboard with the accompaniment.**

## Using the Arpeggiator

The Arpeggiator makes it possible to play an arpeggio pattern automatically. There are 90 different arpeggio patterns from which to choose in order to match the music you are playing.

### NOTE

- The Arpeggiator is controlled using the same button **27** as Auto Harmonize (page E-41). Because of this, these two functions cannot be used at the same time.

**1. Hold down **27** until the Auto Harmonize or Arpeggiator type number and type name appear on the display.**

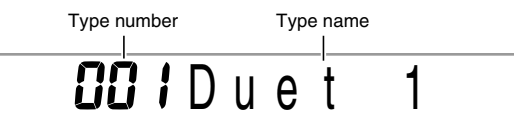

**2. Use the **16** (10-key) [-] and [+] keys to select the Arpeggiator type you want.**

- 001 through 012 are Auto Harmonize types (page E-41). Do not select them when using the Arpeggiator.

Octave

- 1 .. Uses the actual notes played.
- 2 .. Uses the actual notes played plus the same notes one octave.
- 4 .. Uses the actual notes played plus the same notes three octaves.

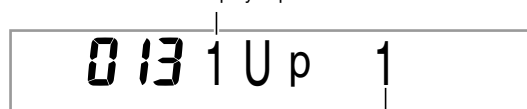

Speed (The number of arpeggio notes per beat)

Type number	Type Name	Description
013 - 030	Up	Rising
031 - 048	Down	Falling
049 - 066	U/D A	Repeat pattern alternating between rising and falling (Type A)
067 - 084	U/D B	Repeat pattern alternating between rising and falling (Type B)
085 - 102	Random	Random arrangement of notes of the pressed keys

### 3. Press **[27]** to turn on Arpeggiator.

Playing a chord on the keyboard will start arpeggio play.

- Press **[27]** again to turn off Arpeggiator.

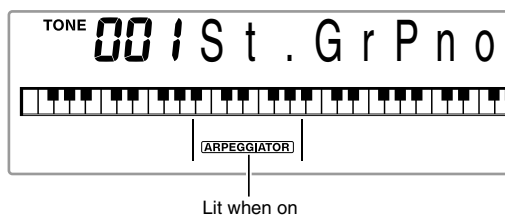

#### NOTE

- The tempo setting of the Arpeggiator is the same as that set for the metronome (page E-11).

### Sustaining an Arpeggio (Arpeggiator Hold)

Use the following procedure when you want an arpeggio pattern to keep playing after you release the keyboard keys.

1. Press **[29]** and then use the **[18]** (10-key) [4] (**←**) and [6] (**→**) keys to display "OTHER" (page E-6).

2. Press **[18]** (10-key) [7] (ENTER) key.



3. Press the **[18]** (10-key) [+] key to select the ON setting.

## Deleting User Song Data

You can use the following procedure to delete user song data stored as song numbers 153 through 162.

1. Press **[29]** and then use the **[18]** (10-key) [4] (**←**) and [6] (**→**) keys to display "DELETE" (page E-6).

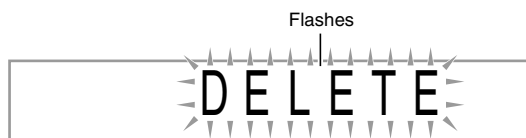

Used memory (Unit: Kbytes)

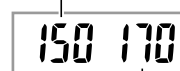

Remaining memory capacity

2. Press the **[18]** (10-key) [7] (ENTER) key.

3. Press the **[18]** (10-key) [6] (**→**) button twice.



4. Use the **[18]** (10-key) [-] and [+] keys to select the user song you want to delete.

5. Press the **[18]** (10-key) [7] (ENTER) key.  
This displays a delete confirmation message.

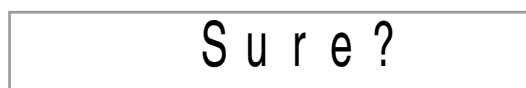

6. Press the **[18]** (10-key) [+] (YES) key.

After the delete procedure is complete, "Complete" will appear followed by the screen in step 2 of the above procedure.

- To cancel the delete operation, press [-] (NO) or [9] (EXIT) in place of [+] (YES).

## Deleting All Data in Digital Keyboard Memory

Use the following procedure when you want to delete sampled sounds, user songs and all other data, except for recorded songs, currently in Digital Keyboard memory.

### IMPORTANT!

- Performing this procedure also will delete protected sampled sound data (page E-24).
- This operation does not delete recorded song data.

1. Press **[ON]** and then use the **[10-key]** [4] (**[←]**) and [6] (**[→]**) keys to display “DELETE” (page E-6).

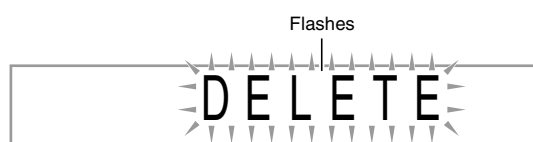

Used memory (Unit: Kbytes)



Remaining memory capacity

2. Press the **[10-key]** [7] (**[ENTER]**) key.
3. Use the **[10-key]** [4] (**[←]**) and [6] (**[→]**) keys to display “All Data”.

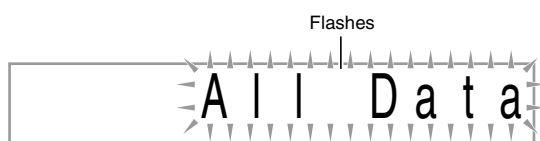

4. Press the **[10-key]** [7] (**[ENTER]**) key.  
This displays a delete confirmation message.

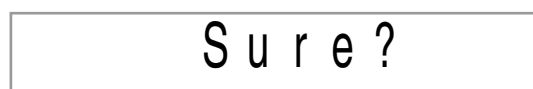

5. Press the **[10-key]** [4] (**[YES]**) key.

After the delete procedure is complete, “Complete” will appear followed by the screen in step 2 of the above procedure.

- To cancel the delete operation, press **[−]** (NO) or **[9]** (EXIT) in place of **[+]** (YES).

# Using a Memory Card (WK-500 Only)

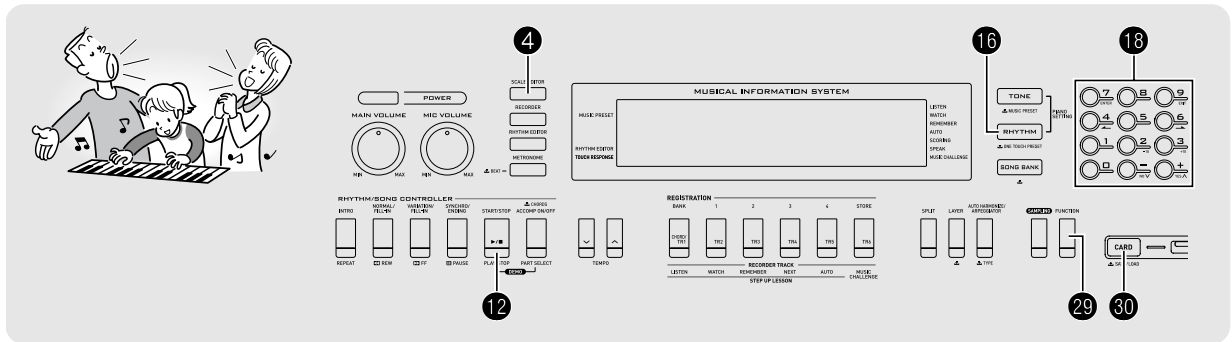

Your Digital Keyboard's SD memory card slot makes it possible for you to store record memory and other data on a commercially available SD memory card.



### Supported SD Memory Cards

Your Digital Keyboard supports the use of memory cards up to 2 GB. Use of any SD memory card with greater capacity is not supported. See the instructions that come with the SD memory card for information about its capacity.

### User data that can be saved and loaded

Data Type	Description	File Name Extension
Sampled sound (page E-18)	Sampled sound data	TW7 DW7*1
User rhythms (page E-42)	Edited Auto Accompaniment data	AC7
User songs (page E-28)	Song data imported from an external device (cannot be saved to an SD memory card).	CM2 MID*2
Recorded songs (page E-48)	Recorded song data	SP7 SL7*3
User scale memory (page E-53)	Edited scale data	ST7
Registration setups (page E-46)	Tone and rhythm setup settings	RM7
All data	Above data	AL7

\*1: Sampled drum set sounds

\*2: Standard MIDI file (format 0, 1)

\*3: Data recorded playing along with built-in song

### IMPORTANT!

- Use only SD memory cards. Operation is not guaranteed when any other type of memory card is used.

## SD Memory Card and Card Slot Precautions

### IMPORTANT!

- When using an SD memory card, make sure you observe all of the precautions in the instructions that come with it.
- SD memory cards have a write-protect switch that you can use to protect against accidental deletion of data.
- Avoid using an SD memory card under the following conditions. Such conditions can corrupt data stored on the memory card.
  - Areas subjected to high temperature, high humidity, and corrosive gas
  - Areas subjected to strong electrostatic charge and digital noise
- Never touch the contacts of an SD memory card when loading it or removing it from the Digital Keyboard.
- While data is being stored to or recalled from an SD memory card, never perform any other Digital Keyboard operation or remove the SD memory card. Doing so can corrupt the data on the card and damage the card slot.
- Never insert anything besides an SD memory card into the card slot. Doing so creates the risk of malfunction.
- Electrostatic charge discharging from your fingers or the SD memory card to the card slot can cause malfunction of the Digital Keyboard. If this happens, turn the Digital Keyboard off and then back on again.
- An SD memory card can become quite warm after very long use in the SD memory card slot. This is normal and does not indicate malfunction.

## Inserting and Removing an SD Memory Card

### IMPORTANT!

- Note that the SD memory card must be oriented correctly when you insert it into the SD memory card slot. Trying to force the memory card into the slot can damage the card and the slot.

1. With the top of the SD memory card facing upwards (so you can see it), carefully insert the card into the keyboard's SD memory card slot (40) until stops with a click.

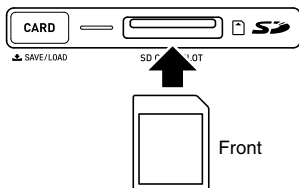

2. Press the SD memory card into the card slot and then release it.

This will cause the card to disengage and eject partially. Pull the card out of the slot.

## Formatting an SD Memory Card

### IMPORTANT!

- Before using an SD Memory card, first be sure to format it on the Digital Keyboard.
- Before performing the procedure below, check to make sure that the SD memory card does not contain any data you might need.
- The SD memory card format performed by the Digital Keyboard is a "quick format". If you want to completely delete all of the data on the card, format it on your computer or using some other device.

1. Insert the SD memory card you want to format into the Digital Keyboard's card slot.

- Make sure that the write-protect switch of the SD memory card is not in the write-protect position.

2. Press 29 and 30 at the same time.

Crd Format

3. Press the 18 (10-key) [7] (ENTER) key.

This will display the format confirmation screen.

Crd Sure ?

4. Press the 18 (10-key) [+] (YES) key.

The message "Pls wait" will appear on the display. Do not perform any operation while this message is displayed. "Complete" appears on the display after formatting is complete.

- To cancel the format operation, press [-] (NO) or [9] (EXIT) in place of [+] (YES).

Pls wait



Complete

## Saving Digital Keyboard Data to an SD Memory Card

Use the following procedure to save Digital Keyboard data to an SD memory card.

### 1. On the Digital Keyboard, select the data you want to save as described below.

To save this type of data	Do this
Sampled sound	Select the tone number of the sampled sound you want to save.
User rhythm	Select the rhythm number of the user rhythm you want to save.
Recorded song	Select the song you want to save and put the Digital Keyboard in playback standby.
User scale memory	Press <b>18</b> and then <b>4</b> .
Registration data	Select one of the Digital Keyboard's default built in tones or rhythms.
All data	

- You cannot save a user song (song data loaded from an external device) to an SD memory card.
- See page E-59 for information about data types.

### 2. Insert a SD memory card into the Digital Keyboard's card slot.

### 3. Hold down **30** until the button lights.

- To cancel data save, press **30** again.
- Example: Saving a sampled sound*

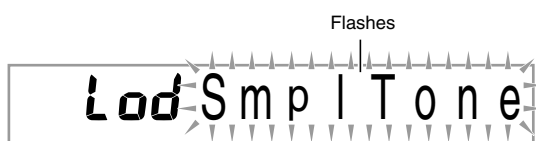

### 4. Use the **18** (10-key) [4] (←) and [6] (→) keys to display one of the settings shown below.

- You also could use [-] and [+].

To save this data	Display this screen
Sampled sound	"SAV" "SmpITone"
User rhythm	"SAV" "UserRhy."
Recorded song	"SAV" "Rec.Song"
Recorded song (SMF 0 format)	"SAV" "SMF 0"
User Scale Memory	"SAV" "ScaleMem"
Registration data	"SAV" "Regist."
All data	"SAV" "All Data"

Saving a recording made while playing along with a built-in song in SMF 0 format will save only what was played on the keyboard.

### 5. Press the **18** (10-key) [7] (ENTER) key.

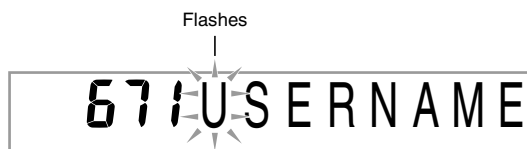

- Enter the file name of the data you are saving. Use the **18** (10-key) [4] (←) and [6] (→) keys to move the cursor to the character you want to change, and then use [+] and [-] to change the character.
- Pressing [9] (EXIT) will return to the screen that was displayed before you pressed [7] (ENTER).

### 6. Press the **18** (10-key) [7] (ENTER) key.

This will save the data to the SD memory card.



- If there is a file with the same name already on the SD memory card, a message will appear asking if you want to overwrite it. Press the **18** (10-key) [+] (YES) key to overwrite, or [-] (NO) or [9] (EXIT) to cancel.



**NOTE**

- You can input the following characters in a file name.

0	1	2	3	4	5	6	7	8	9
A	B	C	D	E	F	G	H	I	J
K	L	M	N	O	P	Q	R	S	T
U	V	W	X	Y	Z	\$	&	_	'
(	)	-	^	{	}	@	~	`	

- The Digital Keyboard displays the “~” character as “→”.

**SD Memory Card Data (File) Storage Locations**

The above procedure stores Digital Keyboard data in a folder named “MUSICDAT” on the SD memory card.

- The “MUSICDAT” folder is created automatically when you format the SD memory card on the Digital Keyboard (page E-60).
- If you store a file in any location other than inside the “MUSICDAT” folder, you will not be able to recall, delete, or play the file on the Digital Keyboard. You also will not be able to recall, delete, or play any file you store inside of a subfolder you create inside the “MUSICDAT” folder.
- The message “No File” will appear on the display if you try to perform a recall, delete, or play operation while there is no file inside the “MUSICDAT” folder.

## Loading Data from an SD Memory Card into Digital Keyboard Memory

Use the following procedure to load data from an SD memory card into Digital Keyboard memory.

**IMPORTANT!**

- Whenever you copy a file to the SD memory card that you plan to recall on the Digital Keyboard, be sure to store the file in the SD memory card’s “MUSICDAT” folder.

**1. On the Digital Keyboard, select the data you want to load as described below.**

To load this type of data	Do this
Sampled sound	Select the tone number of the sampled sound you want to load.
User rhythm	Select the rhythm number of the user rhythm you want to load.
User song	Select the song number of the song you want to load.
Recorded song	Select the song you want to load and put the Digital Keyboard in playback standby.
User scale memory	Press <b>10</b> and then <b>4</b> .
Registration data	Select one of the Digital Keyboard's default built in tones, songs, rhythms, etc.
All data	

**2. Insert the SD memory card that contains the data into the Digital Keyboard’s card slot.**

**3. Hold down **30** until the button lights.**

- To cancel data load, press **30** again.

**4. Use the **13** (10-key) [4] (←) and [6] (→) keys to display one of the settings shown below.**

- You also could use [-] and [+].

To load this data	Display this screen
Sampled sound	“Lod” “SmpITone”
User rhythm	“Lod” “UserRhy.”
User song	“Lod” “UserSong”
Recorded song	“Lod” “Rec.Song”
User scale memory	“Lod” “ScaleMem”
Registration data	“Lod” “Regist.”
All data	“Lod” “All Data”



### 5. Press the **[18]** (10-key) **[7]** (ENTER) key.

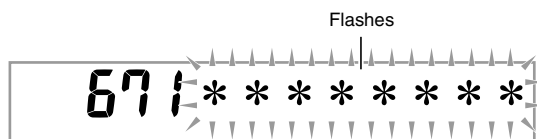

- Pressing **[9]** (EXIT) will return to the screen that was displayed before you pressed **[7]** (ENTER).

### 6. Use the **[18]** (10-key) **[-]** and **[+]** keys to select the data (file) you want to load.

### 7. Press the **[18]** (10-key) **[7]** (ENTER) key.

This will load the data into Digital Keyboard memory.

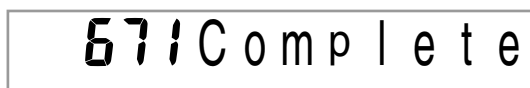

- If there is already data stored in the user area where you are trying to load data, an overwrite confirmation message will appear. Press the **[18]** (10-key) **[+]** (YES) key to overwrite, or **[-]** (NO) or **[9]** (EXIT) key to cancel.



## Deleting Data from an SD Memory Card

Use the following procedure to delete data saved on an SD memory card.

### 1. On the Digital Keyboard, select the data you want to delete as described below.

To delete this type of data	Do this
Sampled sound	Select the tone number of the sampled sound.
User rhythm	Select the rhythm number of the user rhythm.
User song	Select the song number of the user song.
Recorded song	Select the song and put the Digital Keyboard in playback standby.
User scale memory	Press <b>[18]</b> and then <b>[4]</b> .
Registration data	Select one of the Digital Keyboard's default built in tones, songs.
All data	

### 2. Insert a SD memory card into the Digital Keyboard's card slot.

### 3. Hold down **[30]** until the button lights.

- To cancel data delete, press **[30]** again.

### 4. Use the **[18]** (10-key) **[4]** (←) and **[6]** (→) keys to display one of the settings shown below.

- You also could use **[-]** and **[+]**.

To delete this type of data	Display this screen
Sampled sound	"dEL" "SmplTone"
User rhythm	"dEL" "UserRhy."
User song	"dEL" "UserSong"
Recorded song	"dEL" "Rec.Song"
User scale memory	"dEL" "ScaleMem"
Registration data	"dEL" "Regist."
All data	"dEL" "All Data"

5. Press the **10** (10-key) [7] (ENTER) key.

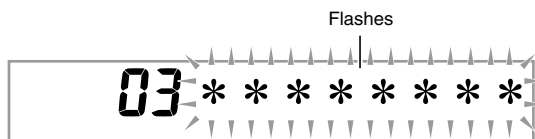

- Pressing [9] (EXIT) will return to the screen that was displayed before you pressed [7] (ENTER).

6. Use the **10** (10-key) [-] and [+] keys to select the number of the data (file) you want to delete.

7. Press the **10** (10-key) [7] (ENTER) key.

This will display the delete confirmation screen.

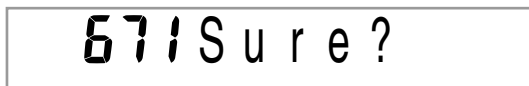

8. Press the **10** (10-key) [+] (YES) key.

- To cancel the delete operation, press [-] (NO) or [9] (EXIT) in place of [+] (YES).

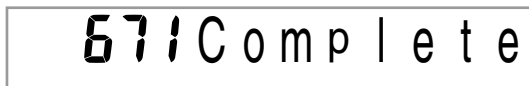

## Playing Back Data from an SD Memory Card

You can use the following procedure to play back user song data (page E-59) directly from an SD memory card.

### IMPORTANT!

- Whenever you copy a file to the SD memory card that you plan to play on the Digital Keyboard, be sure to store the file in the SD memory card's "MUSICDAT" folder (page E-62).

1. Insert the SD memory card that contains the data into the Digital Keyboard's card slot.

2. Press **30**.

This will display the file numbers and song names for the data stored on the display.

3. Use **10** (10-key) to select the song you want to play.

4. Press **12**.

This will start playback.

- Each press of **12** starts and stops playback.

## SD Memory Card Error Messages

For information about SD memory card error messages, see page E-74.

# Connecting External Devices

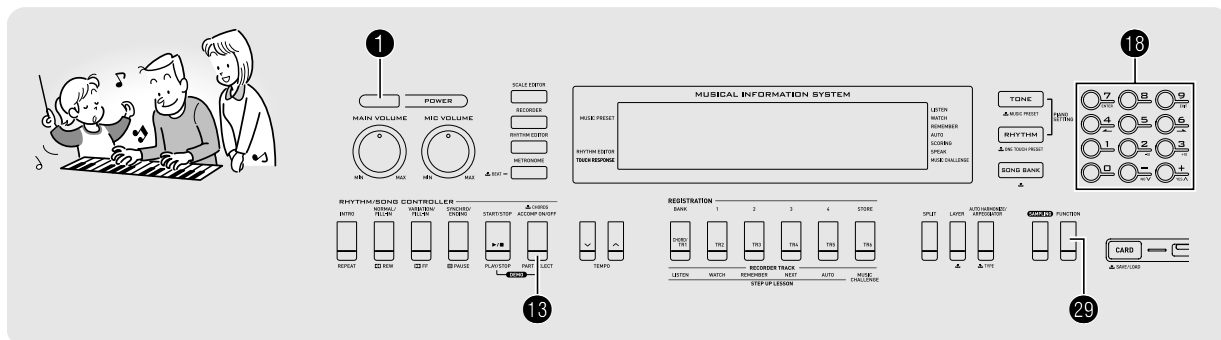

## Connecting a Computer

You can connect the Digital Keyboard to a computer and exchange MIDI data between them. You can send play data from the Digital Keyboard to music software running on your computer, or you can send MIDI data from your computer to the Digital Keyboard for playback.

### Minimum Computer System Requirements

The following shows the minimum computer system requirements for sending and receiving MIDI data. Check to make sure that your computer complies with these requirements before connecting the Digital Keyboard to it.

#### • Operating System

Windows® XP (SP2 or later)\*1

Windows Vista® \*2

Mac OS® X (10.3.9, 10.4.11 or later, 10.5.2 or later)

\*1: Windows XP Home Edition

Windows XP Professional (32-bit)

\*2: Windows Vista (32-bit)

#### • USB port

### IMPORTANT!

- Never connect to a computer that does not conform to the above requirements. Doing so can cause problems with your computer.

## Connecting the Digital Keyboard to Your Computer

### IMPORTANT!

- Make sure you follow the steps of the procedure below exactly. Connecting incorrectly can make data send and receive impossible.

#### 1. Turn off the Digital Keyboard and then start up your computer.

- Do not start up the music software on your computer yet!

#### 2. After starting up your computer, use a commercially available USB cable to connect it to the Digital Keyboard.

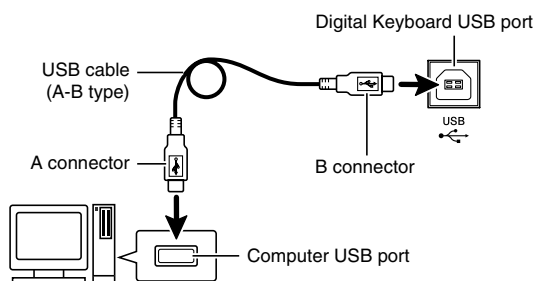

#### 3. Turn on the Digital Keyboard.

- If this is the first time you are connecting the Digital Keyboard to your computer, the driver software required to send and receive data will be installed on your computer automatically.

#### 4. Start up your computer's music software.

## 5. Configure the music software settings to select one of the following as the MIDI device.

CASIO USB-MIDI : (For Windows Vista, Mac OS X)  
 USB Audio Device : (For Windows XP)

- For information about how to select the MIDI device, see the user documentation that comes with the music software you are using.

### IMPORTANT!

- Be sure to turn on the Digital Keyboard first before starting up your computer's music software.

### NOTE

- Once you are able to connect successfully, there is no problem with leaving the USB cable connected when you turn off your computer and/or Digital Keyboard.
- This Digital Keyboard conforms to General MIDI Level 1 (GM).
- For detailed specifications and connections that apply to MIDI data send and receive by this Digital Keyboard, see the latest support information provided by the website at the following URL.  
<http://world.casio.com/>

## MIDI Settings

### Keyboard Channel

A keyboard channel is the channel used for sending Digital Keyboard data to a computer. You can select the channel you want for sending Digital Keyboard data to a computer.

- The keyboard channel setting range is 01 to 16.

1. Press **29** and then use the **18** (10-key) [4] (←) and [6] (→) keys to display "MIDI" (page E-6).

Flashes



2. Press **18** (10-key) [7] (ENTER) key.

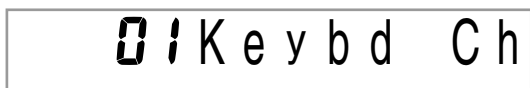

3. Use the **18** (10-key) [-] and [+] keys to change the keyboard channel.

## Navigate Channels

The navigate channels can be used to display only the notes of a particular channel (part) as on-screen guide information from among the note information of a tune sent from the computer.

### Specifying the Navigate Channels

From among the 16 available channels (numbered 01 to 16), you can specify any two neighboring channels (such as 05 and 06) as navigate channels. The smaller numbered channel is the navigate (L) channel, while the larger numbered channel is the navigate (R) channel. Specifying the navigate (R) channel will automatically configure the navigate (L) channel as well.

1. Press **29** and then use the **18** (10-key) [4] (←) and [6] (→) keys to display "MIDI" (page E-6).
2. Press **18** (10-key) [7] (ENTER) key.
3. Use the **18** (10-key) [4] (←) and [6] (→) keys to display "Navi. Ch".

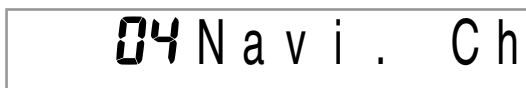

4. Use the **18** (10-key) to specify the navigate (R) channel.

This also will automatically configure the next lower channel number as the navigate (L) channel.

### ■ Turning Off the Navigate Channel Sound and Playing the Part on the Keyboard

You can turn off the sound on one or both of the navigate channels and play the cancelled part on the keyboard yourself.

#### 1. Press **[F6]** to select the channel setting you want to turn off.

Each press of **[F6]** cycles through settings (1) through (4) described below.

- If you turn off one channel, you can play the cancelled part on the keyboard using the same tone as the channel you turned off. If you turn off both channels (option (3)), what you play on the keyboard sounds using the tone of the navigate (R) channel.

Selected channel indicator appears.

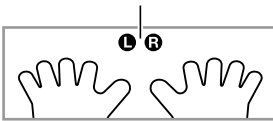

	Navigate (L) Channel		Navigate (R) Channel	
	Sound	On-screen Guide	Sound	On-screen Guide
(1) R only displayed	○	×	×	○
(2) L only displayed	×	○	○	×
(3) LR displayed	×	○	×	○
(4) LR nor displayed	○	○	○	○

### Local Control

There are times when exchanging data with a computer when you may not want the Digital Keyboard to sound notes you play on its keyboard. The local control setting lets you do just that.

1. Press **[F29]** and then use the **[F18]** (10-key) [4] (←) and [6] (→) keys to display “MIDI” (page E-6).
2. Press **[F18]** (10-key) [7] (ENTER) key.
3. Use the **[F18]** (10-key) [4] (←) and [6] (→) keys to display “Local”.

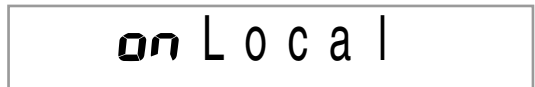

4. Use the **[F18]** (10-key) [-] and [+] keys to specify the local control setting.

### Accomp Out

Enabling the Accomp Out setting causes Auto Accompaniment data to be sent to the computer.

1. Press **[F29]** and then use the **[F18]** (10-key) [4] (←) and [6] (→) keys to display “MIDI” (page E-6).
2. Press **[F18]** (10-key) [7] (ENTER) key.
3. Use the **[F18]** (10-key) [4] (←) and [6] (→) keys to display “AccompOut”.



4. Use the **[F18]** (10-key) [-] and [+] keys to turn Accomp Out on or off.

## Storing and Loading Digital Keyboard Memory Data

You can transfer sampled sounds, recorded songs, and other data in Digital Keyboard memory to a computer for storage. You also can load standard MIDI file (SMF) data, and Auto Accompaniment data you download from the CASIO website to the Digital Keyboard, which greatly expands the Song Bank songs and Auto Accompaniment patterns available to you. A special Data Manager application is required in order to transfer data to and from the Digital Keyboard.

### Data Types Supported for Data Transfer

The same types of data that you can store to or recall from an SD memory card (page E-59) can be transferred to and from the Digital Keyboard. Note, that recorded song data can be transferred to a computer in the Digital Keyboard's native format only. You cannot save recorded song data to a computer as a standard MIDI file (SMF format). With the WK-500 (only), you can save and recall scale memory data.

### Downloading Data Manager

- 1. Go to the CASIO WORLDWIDE site at the following URL.**  
<http://world.casio.com/>
- 2. At the site, select a geographic area or country.**
- 3. After accessing the area site, navigate to the minimum computer system requirements for Data Manager for this product.**
  - You should be able to find a link to Data Manager information on the product introduction page of this product. If you cannot find such a link, use the search form of the area site where you are located to enter the model name of this product and search for it.
  - Note that site contents are subject to change without notice.
- 4. Check if your computer system complies with the minimum requirements for Data Manager.**
- 5. Download Data Manager and its user's guide to your computer.**
- 6. Follow the procedure in the user's guide that you downloaded in step 5 to install and use Data Manager.**
  - You can download accompaniment data from the Internet Data Expansion system of the CASIO MUSIC SITE (<http://music.casio.com/>) and load it into the memory of this Digital Keyboard. Note that there is not any accompaniment data intended specifically for this model, so you should use data for other models.

### NOTE

- Since the accompaniment data is for other models, you may experience some abnormalities when playing it on this model.

### ■ Maintaining Data in Memory

After you save data in memory, it will remain there as long as power is supplied to the keyboard. However, if you disconnect the AC adaptor when there are no batteries loaded, saved data will be deleted.

#### Tips for Maintaining Data

- Use both batteries and the AC adaptor together.
- Make sure that batteries with sufficient power are loaded whenever you disconnect the AC adaptor.
- Connect the AC adaptor to the keyboard and plug it into a power outlet before replacing batteries.

Before connecting or disconnecting the AC adaptor or replacing batteries, first press  to turn off power.

## Connecting to Audio Equipment

This Digital Keyboard can be connected to commercially available stereo, amplifier, or recording equipment, to a portable audio player or other equipment.

### Outputting Keyboard Notes to Audio Equipment

Connection requires commercially available connecting cords, supplied by you.

#### IMPORTANT!

- Turn off the external device when making connections. After connecting, turn down the Digital Keyboard and external device volume levels whenever turning power on or off.
- After connecting, turn on the Digital Keyboard and then the external device.
- If keyboard notes sound distorted when they are sounded from external audio equipment, lower the Digital Keyboard's volume setting.

#### ■ WK-200

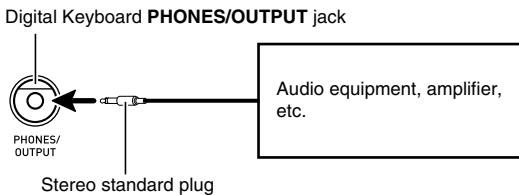

#### ■ WK-500

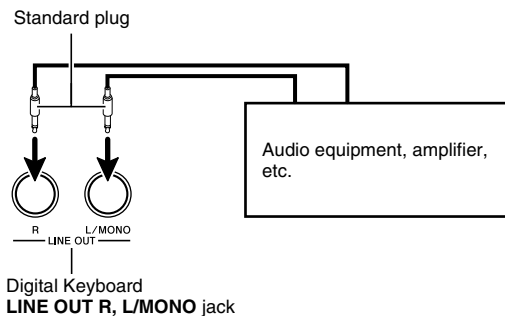

## Playing an External Device from the Digital Keyboard

Connection requires commercially available connecting cords, supplied by you. The connecting cords should have a stereo mini plug on one end and a plug that matches the configuration of the external device on the other end.

#### IMPORTANT!

- Turn off the Digital Keyboard when making connections. After connecting, turn down the Digital Keyboard and external device volume levels whenever turning power on or off.
- After connecting, turn on the external device and then the Digital Keyboard.
- If notes are distorted when they are sounded on the external device, lower the volume setting of the external device.

Digital Keyboard AUDIO IN jack

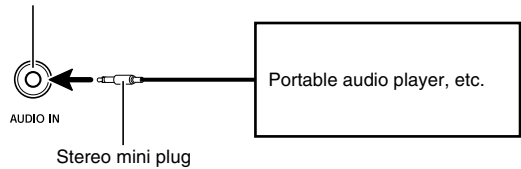

## Troubleshooting

Symptom	Action
<b>Included Accessories</b>	
I can't find something that should be here.	Carefully check inside all of the packing materials.
<b>Power Requirements</b>	
Power will not turned on.	<ul style="list-style-type: none"> <li>• Check the AC adaptor or make sure that the batteries are facing correctly (page E-8).</li> <li>• Replace the batteries with new ones or switch over to AC adaptor power (page E-8).</li> </ul>
The Digital Keyboard outputs a loud sound and then suddenly powers down.	Replace the batteries with new ones or switch over to AC adaptor power (page E-8).
The Digital Keyboard suddenly powers down after a few minutes.	This happens when Auto Power Off (page E-9) is triggered.
<b>Display</b>	
The display keeps going out or are flashing.	Replace the batteries with new ones or switch over to AC adaptor power (page E-8).
On-screen keyboard keys or notes remain on the display.	A Step Up Lesson is in progress and the Digital Keyboard is waiting for you to play the next note in the song. To stop this from happening, cancel the lesson (page E-31).
Screen contents are visible only from straight ahead.	This is dues to production limitations. It does not indicate malfunction.
<b>Sound</b>	
Nothing happens when I press any keyboard key.	<ul style="list-style-type: none"> <li>• Adjust the main volume setting (page E-9).</li> <li>• Check if something is plugged into <b>4</b> (WK-200: PHONES/ OUTPUT jack) (WK-500: PHONES jack) on the back of the Digital Keyboard.</li> <li>• If there is no sampled sound in memory, nothing will play if you press a keyboard key while a tone in the range of 671 to 678 (WK-200: 571 to 578) is selected (page E-18).</li> <li>• Turn power off and then back on to initialize all keyboard settings (page E-9).</li> </ul>
Nothing happens or notes do not play normally when I play notes on the left side of the keyboard.	Press <b>15</b> to disable chord input in the accompaniment keyboard area (page E-37).
Nothing happens when I start an Auto Accompaniment.	<ul style="list-style-type: none"> <li>• With rhythms 190, and 192 to 200 (WK-200: 170, and 172 to 180), nothing will sound until you play a chord on the keyboard. Try playing a chord (page E-37).</li> <li>• Check and adjust the accompaniment volume setting (page E-40).</li> <li>• If there is no user rhythm stored in memory, Auto Accompaniment will not start when you press <b>12</b> while a rhythm in the range of 201 to 210 (WK-200: 181 to 190) is selected (page E-42).</li> <li>• Turn power off and then back on to initialize all Digital Keyboard settings (page E-9).</li> </ul>
Nothing happens when I start playback of a built-in song.	<ul style="list-style-type: none"> <li>• It takes a little time after you press the button until the song starts to play. Wait for a moment for the song to start.</li> <li>• Check and adjust the song volume (page E-28).</li> <li>• If there is no user song stored in memory, song playback will not start when you press <b>16</b> while a song in the range of 153 to 162 is selected (page E-28).</li> <li>• Turn power off and then back on to initialize all Digital Keyboard settings (page E-9).</li> </ul>



Symptom	Action
The metronome does not sound.	<ul style="list-style-type: none"> <li>• Check and adjust the accompaniment volume setting (page E-40).</li> <li>• Check and adjust the song volume (page E-28).</li> <li>• Turn power off and then back on to initialize all Digital Keyboard settings (page E-9).</li> </ul>
Notes keep sounding, without stopping.	<ul style="list-style-type: none"> <li>• Turn power off and then back on to initialize all Digital Keyboard settings (page E-9).</li> <li>• Replace the batteries with new ones or switch over to AC adaptor power (page E-8).</li> </ul>
Some notes are cut off while they are playing.	Notes are cut off whenever the number of notes being sounded exceeds the maximum polyphony value of 48 (24 for some tones). This does not indicate malfunction. See “Maximum Polyphony” in the “Tone List” in the separate “Appendix”.
The volume or tone setting I made has changed.	<ul style="list-style-type: none"> <li>• Adjust the main volume setting (page E-9).</li> <li>• Turn power off and then back on to initialize all Digital Keyboard settings (page E-9).</li> <li>• Replace the batteries with new ones or switch over to AC adaptor power (page E-8).</li> </ul>
Output volume does not change even though I change my keyboard touch.	<ul style="list-style-type: none"> <li>• Change the Touch Response setting (page E-10).</li> <li>• Turn power off and then back on to initialize all Digital Keyboard settings (page E-9).</li> </ul>
In certain keyboard ranges, the volume and tone quality sound are slightly different from those in other keyboard ranges.	This is due to system limitations. It does not indicate malfunction.
With some tones, octaves do not change at the far ends of the keyboard.	This is due to system limitations. It does not indicate malfunction.
The pitch of the notes does not match other accompanying instruments or sounds strange when played long with other instruments.	<ul style="list-style-type: none"> <li>• Check and adjust the transpose (page E-15) and tuning settings (page E-15).</li> <li>• Turn power off and then back on to initialize all Digital Keyboard settings (page E-9).</li> </ul>
The reverb of notes seems to change suddenly.	<ul style="list-style-type: none"> <li>• Check and adjust the reverb setting (page E-14).</li> <li>• Turn power off and then back on to initialize all Digital Keyboard settings (page E-9).</li> </ul>
<b>Operation</b>	
When I perform a skip forward or skip back operation, the skip operation moves multiple song measures instead of only a single measure.	While song playback is stopped or a Step Up Lesson is in progress, skip forward and skip back operations are performed in phrase units (page E-26).
Tone, rhythm, and other settings revert to their initial defaults whenever you turn on the Digital Keyboard.	Though Digital Keyboard settings reset when you turn off the Digital Keyboard, you can save setups to registration memory for instant recall whenever you need them (page E-46).
<b>Computer Connection</b>	
I can't exchange data between the Digital Keyboard and a computer.	<ul style="list-style-type: none"> <li>• Check to make sure that the USB cable is connected to the Digital Keyboard and computer, and that the device is selected correctly with your computer's music software settings (page E-65).</li> <li>• Turn off the Digital Keyboard and then exit the music software on your computer. Next, turn the Digital Keyboard back on and then restart the music software on your computer.</li> </ul>

## Specifications

<b>Models</b>	WK-200 / WK-500
<b>Keyboard</b>	76 standard-size keys
Touch Response	2 types, Off
<b>Maximum Polyphony</b>	48 notes (24 for certain tones)
<b>Tones</b>	
Built-in Tones	WK-200: 570 WK-500: 670
Sampling Tones	Up to 8 (Melody Sampling: 5, Drum Sampling: 3)* Up to 10 seconds
Functions	Layer, Split
<b>Reverb</b>	1 to 10, Off
<b>Chorus</b>	1 to 5, Off
<b>Metronome</b>	
Beats per Measure	0, 2 to 6
Tempo Range	30 to 255
<b>Song Bank</b>	
Built-in Songs	152
User Songs	Up to 10*
<b>Step Up Lesson</b>	
Lessons	4 (Listen, Watch, Remember, Auto)
Lesson Part	L, R, LR
Functions	Repeat, Voice Fingering Guide, Note Guide, Performance Evaluation
<b>Music Challenge</b>	20 notes
<b>Auto Accompaniment</b>	
Built-in Rhythms	WK-200: 180 WK-500: 200
User Rhythms	Up to 10 (Accompaniment Edit)*
<b>Registration</b>	32 (4 setups × 8 banks)
<b>Recorder</b>	Real-time recording, playback
Keyboard Play	5 songs, 6 tracks
Playing Along with a Built-in Songs	1 song (L, R, LR)
Memory Capacity	Approximately 12,000 notes (total for 6 songs)
<b>Other Functions</b>	
Transpose	±1 octaves (-12 to +12 semitones)
Octave Shift	Upper/Lower ±2 octaves
Tuning	A4 = approx. 440 Hz ±100 cents
Scale Tuning	Scale Fine Tune (WK-500 only), Quarter Tone (WK-500 only), Preset Scales
Music Preset	305
One Touch Preset	WK-200: 180 WK-500: 200
Auto Harmonize	12 types
Arpeggiator	90 types
<b>MIDI</b>	16 multi-timbre received, GM Level 1 standard
<b>Musical Information Function</b>	Tone, Rhythm, Song Bank, numbers and names; staff notation, fingering, pedal operation, tempo, measure and beat number, chord name, etc.
<b>Pitch Bend Wheel (WK-500 only)</b>	
Pitch Bend Range	0 to 12 semitones
<b>SD Memory Cards (WK-500 only)</b>	
Supported SD Memory Cards	2GB or less
Functions	SMF playback, file storage, file recall, file delete, card format

<b>Inputs/Outputs</b>	
USB port	TYPE B
Sustain/Assignable jack	Standard jack (sustain, sostenuto, soft, rhythm start/stop)
Phones/Output jack (WK-200)	Stereo standard jack Output Impedance: 200Ω, Output Voltage: 4.5V (RMS) MAX
Phones jack (WK-500)	Stereo standard jack
Line Out R, L/MONO jacks (WK-500 only)	Standard jack × 2 Output Impedance: 2.3kΩ, Output Voltage: 1.5V (RMS) MAX
Audio In jack	Stereo mini jack Input Impedance: 9kΩ, Input Sensitivity: 200mV
Mic In jack	Standard jack Input Impedance: 3kΩ, Input Sensitivity: 10mV
<b>Power Jack</b>	WK-200: 9V DC WK-500: 12V DC
<b>Power Supply</b>	2-way
Batteries	6 D-size zinc-carbon batteries or alkaline batteries
Battery Life	WK-200: Approximately 5 hours continuous operation on zinc-carbon batteries WK-500: Approximately 4 hours continuous operation on alkaline batteries
AC Adaptor	WK-200: AD-5 WK-500: AD-12
Auto Power Off	Approximately 6 minutes after last key operation (Operates during battery use only)
<b>Speakers</b>	WK-200: 12cm × 2 (Output: 2.5W + 2.5W) WK-500: 12cm × 2 + 5cm × 2 (Output: 6.0W + 6.0W)
<b>Power Consumption</b>	WK-200: 9V --- 7.7W WK-500: 12V --- 18W
<b>Dimensions</b>	118.7 × 40.0 × 15.5 cm (46 3/4 × 15 3/4 × 6 1/8 inch)
<b>Weight</b>	WK-200: Approximately 7.2kg (15.9 lbs) (without batteries) WK-500: Approximately 7.8kg (17.2 lbs) (without batteries)

• Design and specifications are subject to change without notice.

\* This data is stored in a shared memory area with a total capacity of approximately 320Kbytes (1Kbyte = 1,024bytes).

## Operating Precautions

Be sure to read and observe the following operating precautions.

### ■ Location

Avoid the following locations for this product.

- Areas exposed to direct sunlight and high humidity
- Areas subjected to temperature extremes
- Near a radio, TV, video deck, or tuner

The above devices will not cause malfunction of the product, but interference from the product can cause audio or video interference of a nearby device.

### ■ User Maintenance

- Never use benzene, alcohol, thinner, or other chemical agents to clean the product.
- To clean the product or its keyboard, wipe with a soft cloth moistened in a weak solution of water and a mild neutral detergent. Wring all excess moisture from the cloth before wiping.

### ■ Included and Optional Accessories

Use only accessories that are specified for use with this product. Use of unauthorized accessories creates the risk of fire, electric shock, and personal injury.

### ■ Weld Lines

Lines may be visible on the exterior of the product. These are “weld lines” that result from the plastic molding process. They are not cracks or scratches.

### ■ Musical Instrument Etiquette

Always be aware of others around you whenever using this product. Be especially careful when playing late at night to keep the volume at levels that do not disturb others. Other steps you can take when playing late at night are closing the window and using headphones.

## Error Messages

Display Message	Cause	Action
<b>Err CardFull</b>	There is not enough room available on the SD memory card.	<ul style="list-style-type: none"> <li>Delete some of the files on the SD memory card to make room for new data (page E-63).</li> <li>Use a different SD memory card.</li> </ul>
<b>Err Card R/W</b>	The SD memory card is damaged.	Use a different SD memory card.
<b>Err Convert</b>	There is not enough unused memory available to save recorded song data to an SD memory card as an SMF 0 format file.	Delete some or all of the following user data from memory to make room for new data. Sampled sounds (page E-17), user rhythms (page E-42), user songs (page E-28)
<b>Err Exist</b>	A sampled drum set sound cannot be copied (page E-21) to a keyboard key because the key already has a sampled sound assigned to it.	<ul style="list-style-type: none"> <li>Delete the sampled sound that is currently assigned to the key you are copying to (page E-22).</li> <li>Copy the sampled sound to another key that does not yet have a sampled sound assigned to it.</li> </ul>
<b>Err Format</b>	<ol style="list-style-type: none"> <li>The format of the SD memory card is not compatible with this Digital Keyboard.</li> <li>The SD memory card is damaged.</li> </ol>	<ol style="list-style-type: none"> <li>Format the SD memory card (page E-60).</li> <li>Use a different SD memory card.</li> </ol>
<b>Err Limit</b>	The tone number you selected before starting sampling already has the allowable maximum of eight sampled sounds assigned to it.	<ul style="list-style-type: none"> <li>Delete the one or more of the sampled sounds currently assigned to the tone number (page E-22).</li> <li>Select another tone number that has less than eight sampled sounds currently assigned to it (page E-20).</li> </ul>
<b>Err Mem Full</b>	<ol style="list-style-type: none"> <li>There is not enough memory available to play back song data from an SD memory card.</li> <li>There is not enough memory available for sampling or Auto Accompaniment editing.</li> </ol>	Delete some or all of the following user data from memory to make room for new data. Sampled sounds (page E-17), user rhythms (page E-42), user songs (page E-28)
<b>Err No Card</b>	<ol style="list-style-type: none"> <li>The SD memory card is not set correctly in the card slot.</li> <li>The SD memory card was removed part way through a card access operation.</li> </ol>	<ol style="list-style-type: none"> <li>Remove the memory card and reinsert it correctly (page E-60).</li> <li>Never remove a SD memory card from the card slot while a card access operation is in progress.</li> </ol>
<b>Err No Data</b>	There is no data in the selected user area (tone, rhythm, song number, etc.)	Select a Digital Keyboard user area that contains data.
<b>Err No File</b>	There is no folder named "MUSICDAT" on the SD memory card.	<ul style="list-style-type: none"> <li>Use a computer to create a folder named "MUSICDAT" on the SD memory card (page E-62).</li> <li>Format the SD memory card on the Digital Keyboard (page E-60).</li> </ul>
<b>Err NotSMF01</b>	You are attempting to play back SMF Format 2 song data.	Playback of SMF Format 0 or 1 only is supported.
<b>Err Protect</b>	<ol style="list-style-type: none"> <li>The SD memory card is write protected.</li> <li>Sampled sounds are protected.</li> </ol>	<ol style="list-style-type: none"> <li>Adjust the SD memory card's write protect switch to enable data storage.</li> <li>Unprotect one or more of the sampled sounds, which will allow it to be overwritten or deleted.</li> </ol>
<b>Err ReadOnly</b>	You are attempting to save a file using the same name as an existing read-only file.	<ul style="list-style-type: none"> <li>Save the new file to a different card or use another name.</li> <li>Remove the read-only attribute of the exiting file on the SD memory card and try again.</li> <li>Use a different SD memory card.</li> </ul>
<b>Err SizeOver</b>	<ol style="list-style-type: none"> <li>The song data on the SD memory it too big to play back.</li> <li>Auto Accompaniment editing cannot be performed because the accompaniment pattern or instrument part data is too large.</li> </ol>	<ol style="list-style-type: none"> <li>This Digital Keyboard can play back song data files with a maximum size of about 320Kbytes.</li> <li>Select a different accompaniment pattern or instrument parts.</li> </ol>
<b>Err WrongDat</b>	<ol style="list-style-type: none"> <li>The data on the SD memory card is corrupted.</li> <li>The data on the SD memory card is a type that is not supported by this Digital Keyboard.</li> </ol>	—

## Song List

## SONG BANK

WORLD	
001	TWINKLE TWINKLE LITTLE STAR
002	LIGHTLY ROW
003	LONG LONG AGO
004	ON TOP OF OLD SMOKEY
005	SAKURA SAKURA
006	WHEN THE SAINTS GO MARCHING IN
007	AMAZING GRACE
008	AULD LANG SYNE
009	COME BIRDS
010	DID YOU EVER SEE A LASSIE?
011	MICHAEL ROW THE BOAT ASHORE
012	DANNY BOY
013	MY BONNIE
014	HOME SWEET HOME
015	AURA LEE
016	HOME ON THE RANGE
017	ALOHA OE
018	SANTA LUCIA
019	FURUSATO
020	GREENSLEEVES
021	JOSHUA FOUGHT THE BATTLE OF JERICHO
022	THE MUFFIN MAN
023	LONDON BRIDGE
024	UNDER THE SPREADING CHESTNUT TREE
025	SIPPIN' CIDER THROUGH A STRAW
026	GRANDFATHER'S CLOCK
027	ANNIE LAURIE
028	BEAUTIFUL DREAMER
029	IF YOU'RE HAPPY AND YOU KNOW IT, CLAP YOUR HANDS
030	MY DARLING CLEMENTINE
031	LITTLE BROWN JUG
032	HOUSE OF THE RISING SUN
033	SHE WORE A YELLOW RIBBON
034	YANKEE DOODLE
035	MY OLD KENTUCKY HOME
036	SZLA DZIEWECZKA
037	TROIKA
038	WALTZING MATILDA
039	ON THE BRIDGE OF AVIGNON
040	I'VE BEEN WORKING ON THE RAILROAD
041	OH! SUSANNA
042	CAMPTOWN RACES
043	JEANNIE WITH THE LIGHT BROWN HAIR
044	TURKEY IN THE STRAW
045	JAMAICA FAREWELL
EVENT	
046	SILENT NIGHT
047	WE WISH YOU A MERRY CHRISTMAS
048	JINGLE BELLS
049	JOY TO THE WORLD
050	O CHRISTMAS TREE
PIANO/CLASSICS	
051	MARY HAD A LITTLE LAMB
052	LE CYGNE FROM "LE CARNAVAL DES ANIMAUX"
053	JE TE VEUX
054	SONATA op.13 "PATHÉTIQUE" 2nd Mov.

055	HEIDENRÖSLEIN
056	AIR FROM "SUITE no.3"
057	SPRING FROM "THE FOUR SEASONS"
058	HABANERA FROM "CARMEN"
059	BRINDISI FROM "LA TRAVIATA"
060	HUNGARIAN DANCES no.5
061	MINUET IN G MAJOR
062	MUSETTE IN D MAJOR
063	GAVOTTE (GOSSEC)
064	ARABESQUE (BURGMÜLLER)
065	CHOPSTICKS
066	DECK THE HALL
067	ODE TO JOY
068	AVE MARIA (GOUNOD)
069	SONATINA op.36 no.1 1st Mov.
070	PRELUDE op.28 no.7 (CHOPIN)
071	RÊVERIE
072	GYMNOPÉDIES no.1
073	GOING HOME FROM "FROM THE NEW WORLD"
074	FÜR ELISE
075	TURKISH MARCH (MOZART)
076	SONATA op.27 no.2 "MOONLIGHT" 1st Mov.
077	ETUDE op.10 no.3 "CHANSON DE L'ADIEU"
078	THE ENTERTAINER
079	WEDDING MARCH FROM "MIDSUMMER NIGHT'S DREAM"
080	AMERICAN PATROL
081	FRÖHLICHER LANDMANN
082	LA CHEVALERESQUE
083	SONATA K.545 1st Mov.
084	LA PRIÈRE D'UNE VIERGE
085	VALSE op.64 no.1 "PETIT CHIEN"
086	LIEBESTRÄUME no.3
087	JESUS BLEIBET MEINE FREUDE
088	CANON (PACHELBEL)
089	SERENADE FROM "EINE KLEINE NACHTMUSIK"
090	MARCH FROM "THE NUTCRACKER"
091	INVENTIONEN no.1
092	PRAELUDIUM no.1 (J.S.BACH)
093	SONATINE op.20 no.1 1st Mov.
094	HUMORESKE (DVOŘÁK)
095	DOLLY'S DREAMING AND AWAKENING
096	LA FILLE AUX CHEVEUX DE LIN
097	ARABESQUE no.1 (DEBUSSY)
098	TRÄUMEREI
099	MAPLE LEAF RAG
100	NOCTURNE op.9 no.2 (CHOPIN)
EXERCISE	
101 - 150	EXERCISE I / II / III
DEMO TUNES	
151 - 152	DEMO TUNES
USER SONGS	
153 - 162	USER SONGS

# MIDI Implementation Chart

Function	Transmitted	Recognized	Remarks
<b>Basic Channel</b> Default Changed	1 1 - 16	1 - 16 1 - 16	
<b>Mode</b> Default Messages Altered	Mode 3 X * * * * * * * * * *	Mode 3 X * * * * * * * * * *	
<b>Note Number</b> True voice	4 - 127 * * * * * * * * * *	0 - 127 0 - 127 *1	
<b>Velocity</b> Note ON Note OFF	0 9nH v = 1 - 127 X 9nH v = 0	0 9nH v = 1 - 127 X 9nH v = 0.8nH V = **	** : no relation ** : sin relación
<b>After Touch</b> Key's Ch's	X X	X O	
<b>Pitch Bender</b>	X (WK-200) O (WK-500)	O	
0, 32 1 6, 38 7 10 11 64	X (WK-200) O (WK-500) *2 O X O O O X O *4	O (MSB only) O O *3 O O O O O	Bank select Modulation Data entry Volume Pan Expression Hold 1
<b>Control Change</b>			

66 67 91 93 100, 101 120 121	O *4 O *4 X O X (WK-200) O (WK-500) *2 X O	O O O O O *3 O O	Sostenuto Soft pedal Reverb send Chorus send RPN LSB, MSB All sound off Reset all controller
<b>Program Change</b> : True #	O 0 - 127 * * * * * * * * *	O 0 - 127	
<b>System Exclusive</b>	O *5	O *6 *7	
<b>System Common</b> : Song Pos : Song Sel : Tune	X X X	X X X	
<b>System Real Time</b> : Clock : Commands	O O	X X	
<b>Aux Messages</b> : Local ON/OFF : All notes OFF : Active Sense : Reset	X O X X	X O O X	
<b>Remarks</b>	<p>*1: Depends on tone *2: RPN : Pitch Bend Sensitivity (WK-500 only) *3: RPN : Pitch Bend Sensitivity, Fine Tune, Coarse Tune *4: In accordance with pedal effect setting. *5: Universal System Exclusive Messages : Master Fine Tuning, Master Coarse Tuning, Reverb Time, Chorus Type *6: Universal System Exclusive Messages : GM System On/Off, GM2 System On, Master Volume, Master Fine Tuning, Master Coarse Tuning, Reverb Time, Chorus Type, Chorus Modulation Rate *7: This model's System Exclusive Message • For details about footnotes 2, 3, 5, 6, 7, see MIDI Implementation at <a href="http://worldcasio.com/">http://worldcasio.com/</a>.</p>		

Mode 1 : OMNI ON, POLY  
Mode 3 : OMNI OFF, POLY

Mode 2 : OMNI ON, MONO  
Mode 4 : OMNI OFF, MONO

O : Yes  
X : No



This recycle mark indicates that the packaging conforms to the environmental protection legislation in Germany.

Esta marca de reciclaje indica que el empaquetado se ajusta a la legislación de protección ambiental en Alemania.

**CASIO®**