

GoPro[®]
Be a HERO. ■■■■

HERO+
LCD

USER MANUAL

/ Join the GoPro Movement



facebook.com/GoPro



youtube.com/GoPro



twitter.com/GoPro



instagram.com/GoPro

To download this user manual in a different language, visit **gopro.com/getstarted**.

Pour télécharger ce manuel de l'utilisateur dans une autre langue, rendez-vous sur **gopro.com/getstarted**.

Wenn Sie dieses Benutzerhandbuch in einer anderen Sprache herunterladen möchten, besuchen Sie **gopro.com/getstarted**.

Per scaricare questo manuale utente in un'altra lingua, visita **gopro.com/getstarted**.

Para descargar este manual de usuario en otro idioma, visite **gopro.com/getstarted**.

Para baixar este manual do usuário em outro idioma, acesse **gopro.com/getstarted**.

このユーザーマニュアルの他言語版をダウンロードするには、**gopro.com/getstarted**にアクセスしてください。

若要下載其他語言版本的使用說明書，請前往：**gopro.com/getstarted**。

如需下載本用戶手冊的其他語言版本，請訪問**gopro.com/getstarted**。

Чтобы загрузить это руководство пользователя на другом языке, посетите страницу **gopro.com/getstarted**.

/ Table of Contents

The Basics	6
Getting Started	8
Camera Displays	15
Camera Modes	18
Navigating Settings Menus	19
Camera Icons	21
Camera Menus	22
Capturing Video	24
Capturing Photos	26
Capturing Burst Photos	27
Capturing Time Lapse Photos	28
Connecting to the GoPro App	29
Transferring Files to a Computer	30
Playing Back Video and Photos	31
Settings	36
Setup Mode	42
Important Messages	48
Using the Mounts	52

/ Table of Contents

Battery	55
Troubleshooting	57
Customer Support	59
Regulatory Information	59

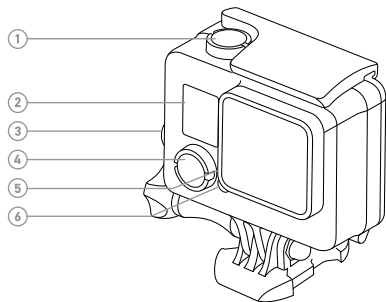

- 1. Shutter/Select Button
- 2. Camera Status Screen
- 3. Settings/Tag Button
- 4. Power/Mode Button
- 5. Wireless Status Light (blue)
- 6. Camera Status Light (red)

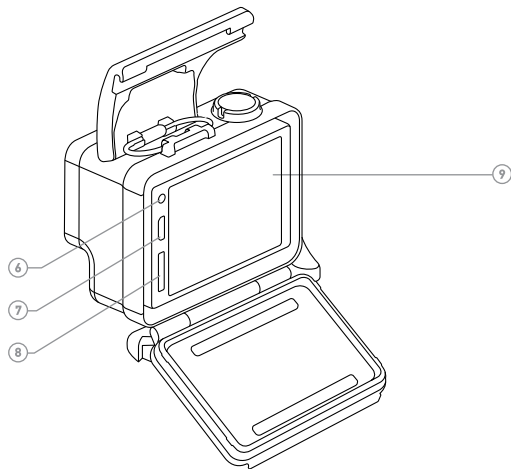

- 6. Micro-USB Port
- 7. Micro-USB Port
- 8. microSD Card Slot
(microSD card not included)
- 9. Touch Display

CHARGING THE BATTERY

The integrated battery comes partially charged. No damage occurs to the HERO+ LCD camera or battery if used before being fully charged.

1. Unlatch and open the backdoor.

Note: The camera cannot be removed from the housing.

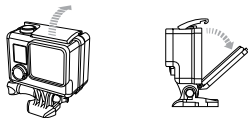

2. Charge the battery using the included USB cable.

Note: The battery cannot be removed from the camera. When charging the camera with a computer, be sure that the computer is connected to a power source. If the camera status lights do not turn on to indicate that the battery is charging, use a different USB port.

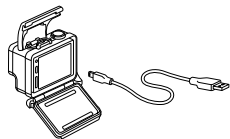

WARNING: Using a wall charger other than a GoPro Wall Charger can damage the GoPro camera battery and could result in fire or leakage. Only use chargers marked: Output 5V 1A. If you do not know the voltage and current of your charger, use the included USB cable to charge the camera from your computer.

For fastest charging, make sure the camera is powered off after connecting it to a computer or USB charging adapter. When the camera is powered off, the camera status light turns on during charging and turns off when charging is complete.

For more battery information, see [Battery](#) (page 55).



WARNING: Use caution when using your GoPro as part of your active lifestyle. Always be aware of your surroundings to avoid injury to yourself and others.

Abide by all local laws when using your GoPro and related mounts and accessories, including all privacy laws, which may restrict recording in certain areas.

INSERTING + REMOVING MICROSD CARDS

Use brand name memory cards that meet these requirements:

- microSD, microSDHC, or microSDXC (sold separately)
- Capacity up to 64GB
- Minimum of Class 10 or UHS-I rating

For a list of the recommended microSD cards, visit gopro.com/support.

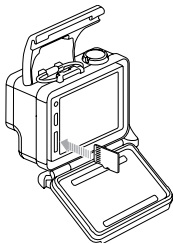

NOTICE: Use care when handling memory cards. Avoid liquids, dust, and debris. As a precaution, power off the camera before inserting or removing the card. Check manufacturer guidelines regarding use in acceptable temperature ranges.

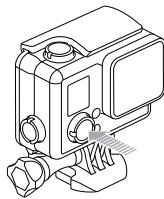

POWERING ON + OFF

To Power On:

Press the **Power/Mode** button once. The camera status lights flash three times and the sound indicator emits three beeps. When the camera status screen displays information, your camera is on.

To Power Off:

Press and hold the **Power/Mode** button for two seconds. The camera status lights flash several times and the sound indicator emits seven beeps.

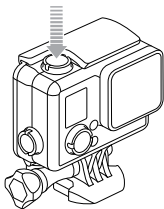

PRO TIP: If QuikCapture is enabled, you can quickly turn your camera on and immediately begin capturing video or Time Lapse photos just by pressing the **Shutter/Select** button. Short press for video, press and hold for Time Lapse photos. For details, see [QuikCapture](#) (page 45).

CAMERA BACKDOORS

Your HERO+ LCD camera comes with three types of backdoors.

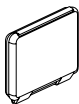

The Standard Backdoor makes the housing waterproof to 131' (40m). Use this door to protect the camera from water, dirt, sand and other environmental hazards. This backdoor reduces wind noise at speeds greater than 100mph.

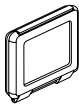

The Touch Backdoor enables access to the touch display and provides waterproof protection to 10' (3m).

NOTICE: To prevent damage to the touch display, do not exceed this depth when using this backdoor. Touch functions do not work underwater. In extreme altitude and temperatures, keep the housing unlatched until you use the camera.

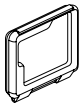







The Skeleton Backdoor is not waterproof. This backdoor enables access to the touch display, provides enhanced cooling, and allows more direct access to the microphone. Use this backdoor only when sand, excessive dirt/dust, and water damage are not a risk. This backdoor is also recommended for use inside vehicles.

CAMERA SOFTWARE UPDATES

To get the latest features and best performance from your HERO+ LCD camera, make sure you are using the most current camera software. You can update your camera software via the GoPro App or GoPro Studio software. For more information, visit gopro.com/getstarted.

CAMERA DEFAULT SETTINGS

The HERO+ LCD camera powers up with the following default settings:

	Video	1080p30, Auto Low Light
	Photo	8MP, Wide Field of View (FOV)
	Burst	10 photos in 2 seconds (5 fps)
	Time Lapse	0.5 seconds
	QuikCapture	Off
	Wireless	Off

PRO TIP: To open the settings menu for the current mode, tap the Settings icon [] or press the **Settings/Tag** button. To change general camera settings that apply to all modes, navigate to **Setup** mode.

HERO+ LCD features a status screen on the front of the camera and a larger touch display on the back.

CAMERA STATUS SCREEN

The camera status screen on the front of the camera displays the following information about modes and settings:

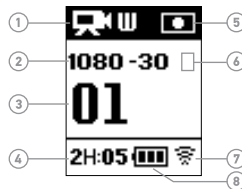

1. Camera Mode/FOV (field of view)
2. Resolution/fps (frames per second)
3. Number of Files Captured
4. Remaining Time/Files on microSD Card
5. Spot Meter (when feature is enabled)
6. Time Lapse Interval/Burst Rate (not shown)
7. Wireless
8. Battery Life

Note: The icons that appear on the camera status screen vary by mode.

TOUCH DISPLAY

The integrated touch display on the back of the camera lets you control your camera and its settings, and preview and play back videos and photos. You can also use it as a viewfinder so you can see what your camera sees for easy shot-framing.

To use the touch display with the housing door closed, attach the Touch Backdoor or the Skeleton Backdoor. For more information, see [Camera Backdoors](#) (page 13).

PRO TIP: To conserve battery power, the touch display is set to automatically sleep after 1 minute of inactivity. For details on touch display settings, see [Touch Display](#) (page 43).

Gestures

Use these gestures to navigate the touch display:

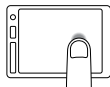

Tap the Mode Icon
Display camera modes.

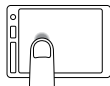

Tap the Settings Icon
Open the settings menu for the current mode.

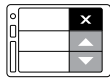

Tap the Up/Down Arrows
Move through settings lists or gallery images.

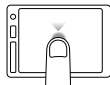







Tap
Select an item, turn a setting on/off.

/ Camera Modes

HERO+ LCD features several camera modes. Tap the mode icon on the touch display, or press the **Power/Mode** button repeatedly to cycle through the modes.

These modes appear:

	Video	Record video
	Photo	Capture a single photo
	Burst	Capture 10 photos in 2 seconds (5 fps)
	Time Lapse	Capture a series of photos at specified intervals
	Playback	Play back videos and view photos
	Setup	Adjust general camera settings

PRO TIP: To change settings for the current mode, press the **Settings/Tag** button. To change general camera settings that apply to all modes, navigate to **Setup** mode.

/ Navigating Settings Menus

With the HERO+ LCD camera, you can navigate the settings menus using the touch display or the buttons on the camera. Each camera mode has its own settings menu.

To Navigate with the Touch Display:

1. Verify that the camera is in the desired camera mode. To select a different mode, tap the mode icon, and then tap the desired mode.

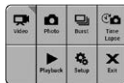

2. Tap the Settings icon [] to open the settings menu for that mode.



Arrows indicate additional options, if available.

3. Tap the down arrow to scroll through the settings for that mode.
4. Tap a setting repeatedly to cycle through the options for that setting.
5. To exit the settings menu, tap Exit.

To Navigate with the Camera Buttons:

1. Verify that the camera is in the desired camera mode. If the icon for that mode does not appear on the camera status screen, press the **Power/Mode** button repeatedly until it appears.
2. Press the **Settings/Tag** button to open the settings menu for that mode.
3. Use the **Power/Mode** button to cycle through the settings.

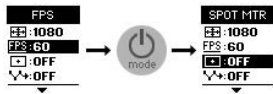

4. Press the **Shutter/Select** button to cycle through the options within a setting. To select an option, leave the option highlighted when you move to another setting.

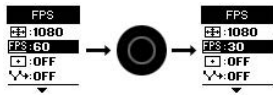

5. To go back to the previous screen or exit the settings menu, press the **Settings/Tag** button.

	Beeps		Touch Display
	Burst Photos		Video
	Date/Time		Video Format
	Delete		Video Resolution
	Frames Per Second		Wireless
	Interval		
	LEDs		
	Looping		
	Orientation		
	Photo		
	Playback		
	QuikCapture		
	Setup Mode		
	Spot Meter		
	Time Lapse		

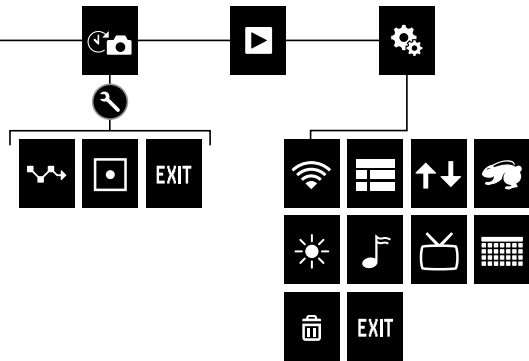
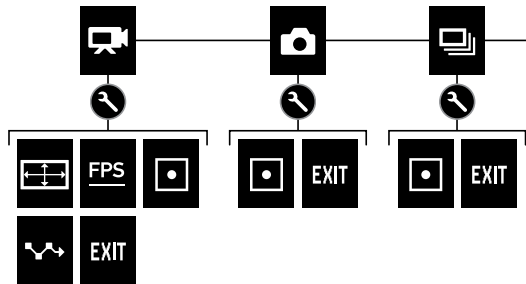

CAPTURING VIDEO

1. Tap the mode icon to display the camera modes, and then tap **Video**.
2. Press the **Shutter/Select** button. The camera beeps once and the camera status lights flash while the camera is recording.
3. To stop capturing, press the **Shutter/Select** button. The camera status lights flash three times and the camera beeps three times.

If the memory card is full or the battery is out of power, your camera automatically stops recording. Your video is saved before the camera powers off.

PRO TIP: When QuikCapture is enabled, you can turn the camera on and immediately begin capturing video just by pressing the **Shutter/Select** button. For details, see [QuikCapture](#) (page 45).

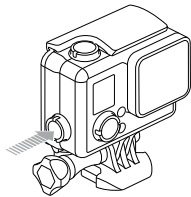

HIGHLIGHT TAGGING

You can mark specific moments in your video as they happen with HiLight Tags. HiLight Tags make it easy to find the best highlights to share.

You can add tags with your camera, the GoPro App, or the Smart Remote (sold separately). Tags are visible in the timeline during playback in the GoPro App or GoPro Studio software.

PRO TIP: In the GoPro App, tap the screen during playback to display the HiLight Tags in the timeline.

To Add a HiLight Tag with Your Camera:

While recording or playing back video, press the **Settings/Tag** button.

In **Photo** mode, you can capture photos at a resolution of 8MP with Ultra Wide FOV.

CAPTURING A SINGLE PHOTO

1. Tap the mode icon to display the camera modes, and then tap **Photo**.
2. Press the **Shutter/Select** button. The camera beeps two times, the camera status lights flash and the counter on the camera status screen increases by one.

Burst mode is perfect for capturing the definitive moment in fast-action sports. In this mode, you can capture 10 photos in 2 seconds (5 fps). The resolution for these photos is 8MP with Ultra Wide FOV.

CAPTURING BURST PHOTOS

1. Tap the mode icon to display the camera modes, and then tap **Burst**.
2. Press the **Shutter/Select** button. The camera status lights flash and the camera beeps multiple times.

Time Lapse mode captures a series photos at set intervals. You can use **Time Lapse** to capture photos of any activity, so you can choose the best ones later. You can also stitch the photos together in editing to create a time lapse video. The resolution for these photos is 8MP with Ultra Wide FOV.

CAPTURING TIME LAPSE PHOTOS

1. Tap the mode icon to display the camera modes, and then tap **Time Lapse** [].
2. Press the **Shutter/Select** button. The camera initiates countdown and the camera status lights flash each time a photo is captured.
3. To stop capturing, press **Shutter/Select** button. The camera status lights flash three times and the camera beeps three times.

PRO TIP: When QuikCapture is enabled, you can turn the camera on and immediately begin capturing Time Lapse photos just by pressing and holding the **Shutter/Select** button for two seconds. For details, see [QuikCapture](#) (page 45).

The free GoPro App lets you control your camera remotely using a smartphone or tablet. Features include full camera control, live preview, playback and sharing of content, and camera software updates.

TO CONNECT YOUR CAMERA TO THE GOPRO APP:

1. Download the GoPro App to your smartphone or tablet from the Apple® App Store, Google Play, or Windows® Phone store.
2. Open the app.
3. Follow the app's on-screen instructions to connect your camera.

Note: If needed, the default password for your camera is goprohero.

For complete pairing instructions, visit gopro.com/support.

PRO TIP: To quickly turn wireless on, press and hold the **Settings/Tag** button until the wireless screen appears. To turn wireless off, press and hold this button until the wireless status lights blink rapidly and then turn off.

To play back your video and photos on a computer, you must first transfer these files to a computer. Transferring frees up space on your microSD card for new content. You can also transfer files to a computer using a card reader (sold separately).

TO TRANSFER YOUR FILES TO A COMPUTER:

1. Download and install GoPro Studio from gopro.com/getstarted.
The HERO+ LCD camera was designed to communicate with GoPro Studio to help you easily locate and transfer your files.
2. Connect the camera to your computer using the included USB cable.
3. Short press the **Power/Mode** button to power on the camera. GoPro Studio Importer automatically opens.
4. Follow the on-screen instructions.

PRO TIP: Video files are written to your memory card in segments. When viewing this content on a computer, you might see separate files for each segment. Use GoPro Studio software to combine the files into a longer video.

You can play back your content on the camera's touch display, your computer, or smartphone/tablet (using the GoPro App). You can also play back content by inserting the microSD card directly into a device, such as a computer or compatible TV.

PLAYING BACK VIDEOS AND PHOTOS ON YOUR CAMERA

With the HERO+ LCD touch display, you can play back your videos and photos directly on your camera.

To Play Back Content Using the Touch Display:

1. Tap the mode icon, and then tap **Playback**.
2. Tap the up and down arrows to scroll through the thumbnails.
Note: For Burst and Time Lapse photos, the thumbnail displays the first photo in the series.
3. Tap a video or photo to open it in full-screen view.
4. For video, tap [▶].
5. To return to the thumbnails screen, tap [•••], and then tap [⏏].
6. To exit **Playback** mode, tap Exit.

CREATING SHORT CLIPS FROM A VIDEO

Video trimming lets you create short clips of your favorite shots from your video files. Clips are saved as new files that can be shared through the GoPro App and used during editing in GoPro Studio.

To Create a Short Clip from a Video:

1. In **Playback** mode, tap the video that contains the clip that you want to save.
2. Tap [▶] to begin playing the video.
3. When you reach the point where you want to start clipping, tap [■].
4. Tap [⋯], and then tap [✂]. By default, the duration of the clip is 5 seconds.
5. If needed, select one of these options:
 - To save a longer clip, tap the 5 sec icon repeatedly to cycle through the options. You can save a clip with a duration of 5, 15, or 30 seconds.
 - To save a photo of the frame in view, tap Still.
6. Tap [▶] to review the clip before saving it.
7. If needed, adjust the starting point of the clip by tapping the left arrow at the top of the progress bar. To adjust the ending point, tap the right arrow.

Note: If you adjust the starting or ending points, the duration of the clip remains the same.

8. Tap Save. The clip is saved as a separate video file. Still photos are saved as photo files. Your original video file is unchanged.

PRO TIP: After you create clips from a video, you can delete the original file to save space on your microSD card.

To Play Back Content Using the Camera Buttons:

1. Power on the camera.
2. Press the **Power/Mode** button repeatedly to cycle to **Playback** mode, then press the **Shutter/Select** button to select it.
3. In thumbnail preview, press the **Power/Mode** button to cycle through the thumbnails.
4. Press the **Shutter/Select** button to view a thumbnail.
5. To play a video, press the **Power/Mode** button to select [▶].
6. To return to the thumbnails:
 - a. Press the **Power/Mode** button to cycle to [⋯], and then press the **Shutter/Select** button to select it.
 - b. Press the **Power/Mode** button to cycle to the thumbnail icon [■], and then press the **Shutter/Select** button to select it.
7. To exit **Playback** mode, press the **Power/Mode** button repeatedly to cycle to Exit, then press the **Shutter/Select** button to select it.

PLAYING BACK VIDEOS AND PHOTOS ON A COMPUTER

To play back your video and photos on a computer, you must first transfer these files to your computer. For best results, visit gopro.com/getstarted to download GoPro Studio software.

To Play Back Files on a Computer:

1. Download and install GoPro Studio from gopro.com/getstarted.
The HERO+ LCD camera was designed to communicate with GoPro Studio to help you easily locate and transfer your files.
2. Connect the camera to your computer using the included USB cable.
3. Short press the **Power/Mode** button to power on the camera. GoPro Studio Importer automatically opens.
4. Follow the on-screen instructions to import the files.
5. Use the controls in GoPro Studio to play back your files.

PLAYING BACK VIDEOS AND PHOTOS ON YOUR TV

Playing back videos and photos on your TV/HDTV requires a USB card reader and a compatible TV.

Note: Some TVs do not support USB card readers.

To Play Back Content on a TV:

1. Insert the microSD card into a USB card reader (sold separately).
2. Connect the card reader to your TV.
3. Use the controls on the TV to play back your files.

PLAYING BACK CONTENT ON A SMARTPHONE/TABLET

1. Connect your camera to the GoPro App. For details, see [Connecting to the GoPro App](#) (page 29).
2. Use the controls on the app to play back your footage on your smartphone/tablet.

VIDEO SETTINGS

For instructions on changing settings, see *Navigating Settings Menus* (page 19).

Resolution, FPS, and FOV

HERO+ LCD includes the video resolutions listed below. All resolutions include Auto Low Light at the 60 fps setting. Auto Low Light automatically optimizes fps according to lighting conditions. FPS refers to frames per second. FOV refers to field of view.

Video Resolution	FPS (NTSC/PAL)	FOV (Field of View)	Screen Resolution
1080p	60/50	Ultra Wide	1920x1080, 16:9
1080p	30/25	Ultra Wide	1920x1080, 16:9
720p SuperView	60/50	Ultra Wide	1280x720, 16:9
720p	60/50	Ultra Wide	1280x720, 16:9

PRO TIP: To open the settings menu for the current mode, tap the Settings icon [] on the touch display or press the **Settings/Tag** button. To change general camera settings that apply to all modes, navigate to **Setup** mode.

Video Resolution	Best Use
1080p60	Great for capturing fast action at the highest resolution.
1080p30	Good for capturing content in low-light conditions.
720p SuperView	SuperView delivers the world's most immersive field of view. Great for point-of-view shots or when you want to capture more vertical content, such as the sky or land.
720p60	Great for capturing fast action and when full HD is not needed.

PRO TIP: Easily create epic GoPro-style videos using free GoPro Studio software. Learn more and download this software at gopro.com/getstarted.

SPOT METER

Spot Meter is good for filming into a setting where the lighting is different from where you are, such as filming the outdoors from within a car or filming a shaded environment while standing in the sun. Spot Meter automatically sets the exposure based on a single spot in the middle of the image. When Spot Meter is turned on, [] appears on the camera displays. The options for this setting are Off (default) and On.

*Note: Changes that you make to the Spot Meter setting in **Video** mode apply only to video capture. To adjust this setting for another mode (**Photo**, **Burst**, or **Time Lapse**), adjust the setting within that mode.*

INTERVAL

In **Video** mode, this setting applies only to Looping. Looping lets you continuously record and save only the best moments, which helps to conserve space on your microSD card. Available intervals for looping are 5, 20, 60, and 120 minutes. For example, if you select a 5-minute interval, the previous 5 minutes are saved when you stop recording.

You can also select Max as the interval for Looping. With this option, the camera records until the memory card is full, then overwrites the content. The default option for Looping is Off.

Note: To use Looping, be sure that your microSD card has sufficient space to create the loop segment based on the interval that you select. If the microSD card becomes full, Looping does not overwrite the content.

PRO TIP: Files are written to your memory card in segments. When viewing this content on a computer, you might see separate files for each time segment. Use GoPro Studio software to combine the files into a longer video.

PHOTO SETTINGS

For instructions on changing settings, see [Navigating Settings Menus](#) (page 19).



This setting applies only to **Time Lapse** mode. Interval determines the amount of time that passes between each captured frame. Available intervals for Time Lapse range from 0.5 seconds (default) to 60 seconds.

Interval	Examples
0.5-2 seconds	Surfing, biking, or other sport
2 seconds	Busy street corner
5-10 seconds	Sunset
10-60 seconds	Lengthy activities, such as construction projects



This setting applies to all photo capture modes: **Photo**, **Burst**, and **Time Lapse**. Spot Meter is good for capturing photos where the lighting is different from where you are, such as capturing the outdoors from within a car or capturing a shaded environment while standing in the sun. Spot Meter automatically sets the exposure based on a single spot in the middle of the image. When Spot Meter is turned on, [] appears on the camera displays. The options for this setting are **Off** (default) and **On**.

*Note: Changes that you make to the Spot Meter setting in one mode (**Photo**, **Burst**, or **Time Lapse**) apply only to that mode. To adjust this setting for another mode, adjust the setting within that mode.*

In **Setup** mode, you can change settings that apply to all camera modes. For instructions on how to change the following settings, see [Navigating Settings Menus](#) (page 19).



When wireless is on, a wireless status icon appears on the camera status screen and touch display and the blue wireless lights blink intermittently.



Setting	Description
Off (default)	
GoPro App	Camera connects to the GoPro App. For instructions on connecting to this app, see Connecting to the GoPro App (page 29).
Wi-Fi Remote Control	Camera connects to the GoPro remote control (sold separately). For instructions on pairing, see the user manual for the remote.
Wi-Fi Reset Settings	Resets your camera's wireless name and password.

Resetting Your Camera's Wireless Name and Password

1. Power on the camera.
2. Tap the mode icon, and then tap **Setup**.
3. Tap Wireless.
4. Tap the down arrow, and then tap Wi-Fi Reset Settings.
5. Tap Reset. The password is reset to the default: *goprohero*.





These settings let you manage the touch display to conserve battery power.

Setting	Description
Touch Display On/Off 	Turns the touch display on or off when the camera is powered on. The options for this setting are On (default) and Off.
Sleep 	Touch display automatically goes dark after a period of inactivity. The options for this setting are 1 minute (default), 2 minutes, 3 minutes, and Never.

↑↓ ORIENTATION

This setting eliminates the need to flip your video during editing when the camera is mounted upside down.

Setting	Description
Up (default) 	Camera is used right-side up.
Down 	Camera is used upside down.

QUIKCAPTURE

With QuikCapture, you can quickly turn your camera on and begin capturing video or Time Lapse photos. The options for this setting are On and Off (default).

Note: You cannot start QuikCapture with the GoPro remote or the GoPro App.

To Capture Video with QuikCapture:

With the camera powered off, press and release the **Shutter/Select** button. Your camera automatically powers on and begins capturing video.

To Capture Time Lapse Photos with QuikCapture:

With the camera powered off, press and hold the **Shutter/Select** button for two seconds. Your camera automatically powers on and begins capturing Time Lapse photos.

To Stop Recording:

Press and release the **Shutter/Select** button to stop recording and power off the camera.



This setting determines which camera status lights (red) to activate. The options for this setting are Both on (front and back), Both off, Front on, or Rear on. The default setting is Both on.



You can set the sound indicator to On (default) or Off.



The Video Format setting governs frame rates for recording and playback when viewing video on a TV/HDTV.

Setting	Description
NTSC (default)	Viewing video on an NTSC TV/HDTV (most televisions in North America)
PAL	Viewing video on a PAL TV/HDTV (most televisions outside of North America)



Your camera's date and time are automatically set when you connect your camera to the GoPro App or GoPro Studio software. This setting lets you manually set the date and time.



This setting lets you delete the last file, or delete all files and reformat the memory card. Deleting all files is useful after you transfer your files to your computer and want to make room on your memory card for more content. The camera status lights blink until the operation is complete.

NOTICE: If you select All/Format, the memory card is reformatted, which deletes every file on the card.

MICROSD CARD MESSAGES

NO SD	No card present. The camera requires a microSD, microSDHC, or microSDXC card (sold separately) to capture videos and photos.
FULL	Card is full. Delete files or swap card.
SD ERR	Camera is unable to read card formatting. Reformat the card in the camera.

PRO TIP: Reformat your microSD card on a regular basis to ensure that the card remains in good condition.

FILE REPAIR ICON



If your last video file was corrupted during recording, the camera displays the File Repair icon while it tries to repair the file. When this process is finished, press any button to continue using the camera.

TEMPERATURE ICON



The Temperature icon appears on the camera status screen when the camera becomes too hot and needs to cool down. Simply let it sit and cool before attempting to use it again. Your camera was designed to identify conditions of overheating and is designed to respond accordingly.

SWAPPING BACKDOORS

You can switch the backdoor of your HERO+ LCD to suit your activity and shooting conditions.

To Change the Backdoor:

1. Open the backdoor of the housing so that it hangs downwards.
2. Firmly pull the backdoor downwards until it snaps free from the main housing.
3. Line up the replacement backdoor into the hinge opening.
4. Push upwards on the backdoor until it clicks into place.

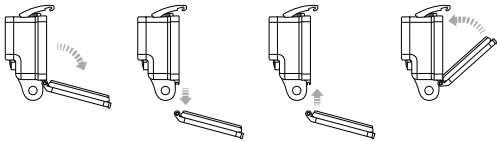

Note: The camera cannot be removed from the housing.

PRO TIP: Apply Rain-X® or a similar anti-beading solution to the camera housing lens to prevent water spots from forming when using your camera in rain or water.

PREVENTING WATER DAMAGE TO YOUR CAMERA

The rubber seal that lines the camera housing forms a waterproof barrier that protects your HERO+ LCD in wet and underwater conditions.

Keep the camera housing's rubber seal clean. A single hair or grain of sand can cause a leak and damage your camera.

After every use in salt water, rinse the outside of the camera housing with fresh water and dry. Not doing this can eventually cause corrosion of the hinge pin and salt buildup in the seal, which can cause failure.

To clean the seal, carefully remove it, rinse it in fresh water, and shake it dry (drying with a cloth may cause lint to compromise the seal). Re-install the seal into the grooves in the backdoor of the camera housing.



WARNING: Failure to follow these steps each time you use your GoPro can result in leaks that may damage or destroy your camera. Water will damage both the camera and the battery, which could cause an explosion or fire. Your warranty does not cover water damage resulting from user error.

ATTACHING YOUR CAMERA TO MOUNTS

To attach your HERO+ LCD camera to a mount, you need a Mounting Buckle and/or thumb screw, depending on the mount you are using. For more information on mounts, visit gopro.com.

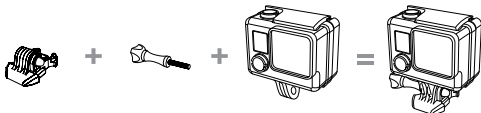

Mounting Buckle + Thumb Screw + Camera = Complete Unit

USING CURVED + FLAT ADHESIVE MOUNTS

The Curved + Flat Adhesive Mounts make it easy to attach the camera to curved and flat surfaces of helmets, vehicles, and gear. Using the Mounting Buckle, the assembled camera housing can be clicked on and off the secured Curved or Flat Adhesive Mounts.



Flat Adhesive Mount

Curved Adhesive Mount

MOUNTING GUIDELINES

Follow these guidelines when attaching mounts:

- Attach the adhesive mounts at least 24 hours prior to use. Allow 72 hours for complete adhesion.
- Adhesive mounts must be mounted only on smooth surfaces. Porous or textured surfaces do not enable a proper bond. When applying the mount, firmly press it into place and ensure full contact over the entire surface.
- Apply adhesive mounts to clean surfaces only. Wax, oil, dirt or other debris reduce adhesion, which can result in a weak bond and risk of losing the camera should the connection fail.
- Attach adhesive mounts in room temperature conditions. Mount adhesives do not bond properly if applied in cold or damp environments to cold or damp surfaces, or if the surface is not room temperature.

For more information on mounts, visit gopro.com.

WARNING: If using your camera with a GoPro helmet mount or strap, always select a helmet that meets the applicable safety standard.



Choose the right helmet for your particular sport or activity and make sure that it is the right fit and size for you. Inspect your helmet to ensure that it is in good condition and follow the helmet manufacturer's instructions on safe helmet use.

Any helmet that has sustained a major impact should be replaced. No helmet can protect against injury in every accident.

LOCKING PLUG

If you are using HERO+ LCD in sports such as surfing or skiing, use the locking plug to securely lock the Mounting Buckle fingers into place.

To Attach the Locking Plug:

1. Loop the circular ring over the thumbscrew. The circular ring acts as a leash to prevent dropping or losing the locking plug.
2. Slide the Mounting Buckle into the mount until it clicks into place.
3. Press the U-shaped part of the plug into the U-shaped space in the Mounting Buckle.

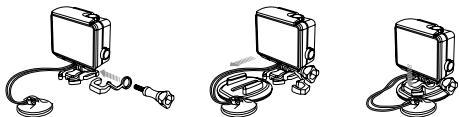

WARNING: To avoid injury in the event of an accident, do not use the locking plug or tether when using a mounting device on a helmet or other personal protective gear.

Your HERO+ LCD camera, battery, and housing are integrated. You cannot remove the camera from the housing, or remove the battery from the camera.

The battery icon displayed in the camera status screen blinks when the battery drops below 10%. If the battery reaches 0% while recording, the camera saves the file and powers off.

MAXIMIZING BATTERY LIFE

To maximize battery life, close the GoPro App or turn off wireless. To maximize battery life when shooting longer-duration activities, turn off the touch display. Extreme cold temperatures can decrease battery life. To maximize battery life in cold conditions, keep the camera in a warm place prior to use.

PRO TIP: QuikCapture helps maximize battery life. For details, see [QuikCapture](#) (page 45).

BATTERY STORAGE AND HANDLING

The camera contains sensitive components, including the battery. Avoid exposing your camera to very cold or very hot temperatures. Low or high temperature conditions may temporarily shorten the battery life or cause the camera to temporarily stop working properly. Avoid dramatic changes in temperature or humidity when using the camera, as condensation may form on or within the camera.

The integrated camera housing protects the camera and battery from water damage. For more information, see [Camera Backdoors](#) (page 13). Do not turn on your camera if the camera (inside the housing) gets wet. If your camera is already on, turn it off immediately. Allow the camera to dry thoroughly before using it again. Do not dry the camera or battery with an external heat source such as a microwave oven or hair dryer. Damage to the camera or battery caused by contact with liquid (inside the housing) is not covered under the warranty.



WARNING: Do not drop, disassemble, open, crush, bend, deform, puncture, shred, microwave, incinerate, or paint the camera. Do not insert foreign objects into any opening on the camera, such as the micro-USB port. Do not use the camera if it has been damaged—for example, if cracked, punctured, or harmed by water. Disassembling or puncturing the integrated battery can cause an explosion or fire.

MY GOPRO WON'T POWER ON

Make sure your GoPro is charged. To charge your camera, use the included USB cable and a computer. You can also use the GoPro Wall or Auto Charger.

MY GOPRO WON'T RESPOND WHEN I PRESS A BUTTON

Press and hold the **Power/Mode** button for eight seconds to reset your camera. This reset saves all of your content and settings, and powers off your camera.

MY PLAYBACK IS CHOPPY

Choppy playback is typically not a problem with the file. If your footage skips, one of these situations is likely the cause:

- Using an incompatible video player. Not all video players support the H.264 codec. For best results, use GoPro Studio software, available for free at gopro.com/getstarted.
- The computer does not meet the minimum requirements for HD playback. The higher the resolution and frame rate of your video, the harder the computer has to work to play it back. If you are using GoPro Studio software to play back your files, be sure that your computer meets the minimum system requirements, available on gopro.com/getstarted.

- Playing a high bitrate HD video file over a low bandwidth USB connection. Transfer the file to the computer to play back.

If your computer does not meet the minimum requirements, make sure that all other programs on your computer are closed.

I FORGOT MY CAMERA'S USERNAME OR PASSWORD

See *Resetting Your Camera's Wireless Name and Password* (page 43).

I POWERED OFF MY GOPRO, BUT THE BLUE LIGHT IS STILL BLINKING

The blue light indicates that wireless is on. To turn off wireless, press and hold the **Settings/Tag** button until the wireless status lights blink rapidly and then turn off.

For more answers to commonly asked questions, see gopro.com/support.

GoPro is dedicated to providing the best possible service. To reach GoPro Customer Support, visit gopro.com/support.

/ Regulatory Information

To see the complete list of country certifications, refer to the Important Product + Safety Information included with your camera.

/ Trademarks

GoPro, HERO, the GoPro logo, the GoPro Be a Hero logo, BacPac, Protune, SuperView, and Wear It. Mount It. Love It. are trademarks or registered trademarks of GoPro, Inc. in the U.S. and internationally. Other names and marks are the property of their respective owners.

