

Numark

OPERATING INSTRUCTIONS

TT200

CONTENTS

Setup & Installation	2
Platter Setup	3
Cartridge Setup	4
Interchanging Tonearm Tubes	5
Tone Arm Setup	6
Controls	7
Cable Setup	10
Operation	11
Specifications	11
Trouble Shooting	12

SETUP & INSTALLATION

This turntable has been designed exclusively for DJ use and can be setup in a variety of different ways depending on your mixing style. The turntable should rest on a level and stable surface that is clear of obstructions. If a mixer is placed between two turntables make sure that there is at least $\frac{1}{4}$ " (7mm) between the mixer and the turntables to prevent damage to the turntables and to reduce unwanted system noise.

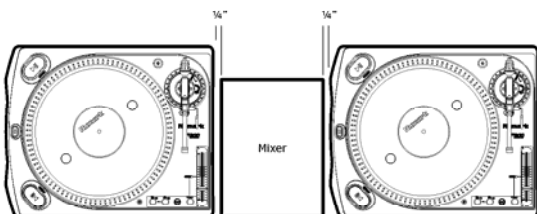
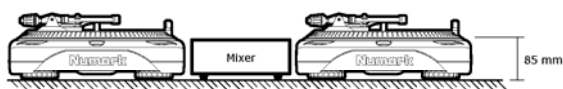
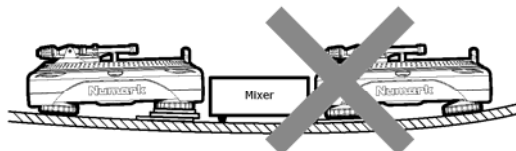

Setup Style 1 (traditional)

Best For:
Long mixes and blending techniques

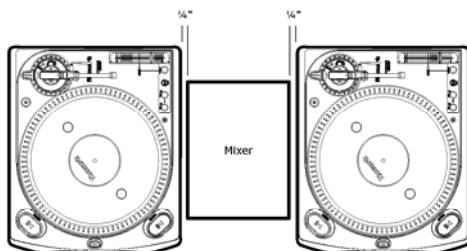

Setup Style 2 (battle style, scratching)

Best For:
Scratching, cutting, and aggressive mixing techniques

There are many variations of these setups. Find the best setup that works for your mixing style by experimenting with different turntable and mixer placements. It is strongly recommended that the top mixer surface and the top flat surface of the turntable be at the same level.

PLATTER SETUP

WARNING: Incorrect Platter setup can lead to poor turntable performance, platter instability, or permanent motor damage.

1. Start by inspecting the bottom of the aluminum platter to check that both locking pins have rubber fittings on them.
2. Next, rotate the top of the motor assembly (brass in color) so that two holes are aligned parallel with the front of the turntable.
3. Install the platter onto the center spindle and motor assembly making sure that the Numark logo and the two holes are aligned parallel with the front of the turntable.
4. The two locking pins should drop into the top of the motor assembly for a stable and secure fit. If they do not, grasp the center spindle with one hand while rotating the platter with the other until the locking pins drop into place. If the platter is properly installed, it should not wobble and should rotate smoothly without any noise.

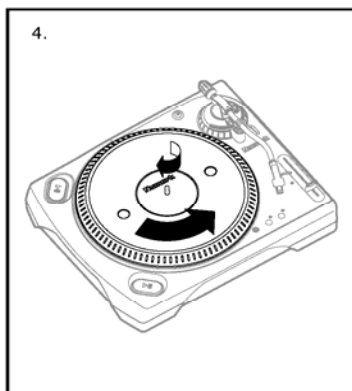
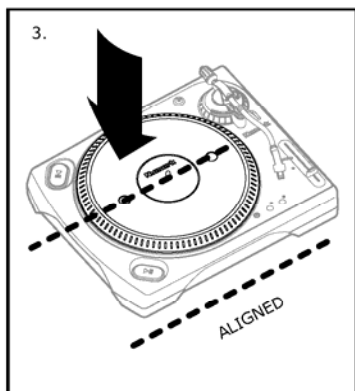
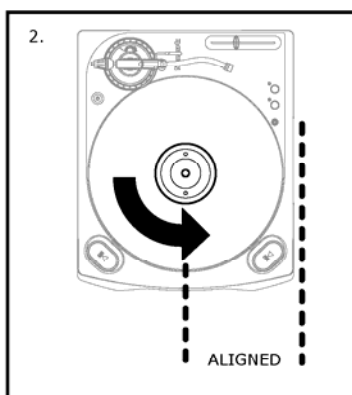
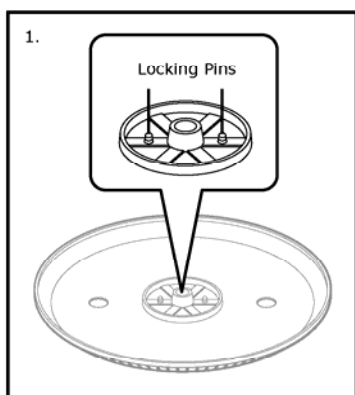

CARTRIDGE SETUP

For Head Shell Mounted Cartridges:

The cartridge that comes with this turntable should be preinstalled on the head shell. If it isn't, please follow the below instructions for installing a cartridge onto the head shell.

1. Position the head shell and the cartridge so that the four connector pins are visible. Make sure that the stylus cover is installed to prevent damage to the stylus during installation.
2. Prepare to connect the cartridge to the head shell using the green, red, blue and white connector wires.
3. Starting with the upper left pin and going clockwise install the white, the red, the green and finally the blue wires to the connector pins. Be careful not to bend the metal clips on the end of the wires. These metal connectors should never make contact with one another.
4. Using the screws and bolts that are included with the cartridge, loosely fasten the cartridge to the head shell body.
5. Once temporarily fastened, position the cartridge so that both screws are aligned with the optimum position mark on the Head shell (Numark HS 1 Head shell and Numark Cartridges only.) Moving the both screws to a mark away from the optimum position indicated on the head shell may increase or decrease performance depending on the cartridge used. For safe vinyl record treatment, the screws should always be aligned perpendicular to the head shell (any angle may increase "record burn.")
6. Once the cartridge is positioned correctly, secure the cartridge to the head shell by tightening the mounting screws.

For Integrated Head Shell Cartridges (Numark CS-1, CC-1, CX-1, etc.)

7. Align the pin on the rear of the Cartridge Assembly so that it is in a vertical position and insert it into the tone arm lock nut.
8. Secure the cartridge to the tone arm by turning the tone arm lock nut clockwise until the head shell feels secure and does not wobble to the left or right. **WARNING:** Over tightening the tone arm lock nut may result in permanent damage to the tone arm or the cartridge.
9. Remove the stylus protector before playback.

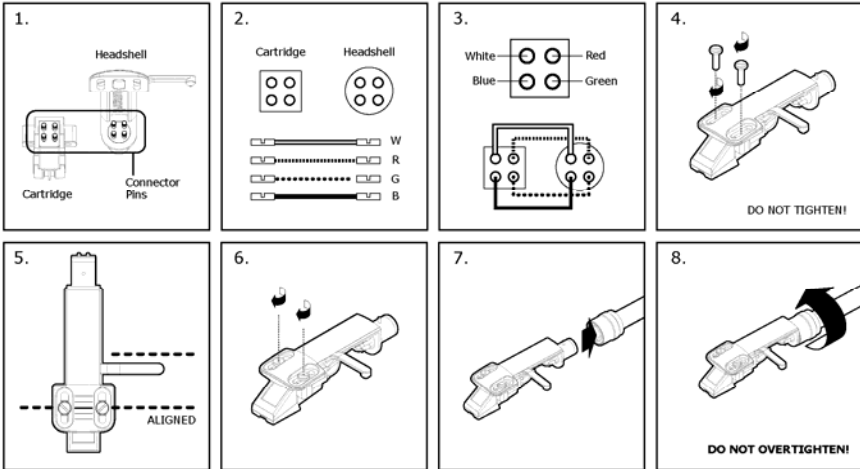

INTERCHANGING TONEARM TUBES *(sold separately)*

WARNING: An incomplete understanding of this procedure could lead to permanent damage to the headshell, your records, or the tonearm assembly.

NOTICE: Interchanging tonearm tubes unnecessarily may shorten the life of the tonearm tubes and/or tonearm components.

This turntable features the world's only tonearm assembly capable of accommodating two different tonearm tube styles: S-Shaped and Straight. The S-Shaped tube produces a higher signal to noise ratio with most cartridge assemblies. The Straight tube is ideal for heavy back-cueing or scratching. Decide which tube to use based on your mixing style.

1. Power off the turntable and any connected mixers, amplifiers or monitoring devices.
2. Remove the Cartridge from the tonearm tube that is currently installed on the tonearm tube by rotating the locking collar counter clockwise.
3. Unclip the tonearm tube from the armrest.
4. Remove the tonearm tube by rotating the locking collar counter clockwise.
5. Insert the desired tonearm into the tonearm assembly with the screws **FACING TOWARDS THE TURNTABLE BODY**.
6. Tighten the tonearm tube in place by rotating the inner collar clockwise.
WARNING: It is only necessary to tighten the tonearm tube lock collar until resistance is felt. Over tightening the tonearm tube lock collar will damage the tonearm tube.
7. Reinstall the headshell and proceed to **TONEARM SETUP**.

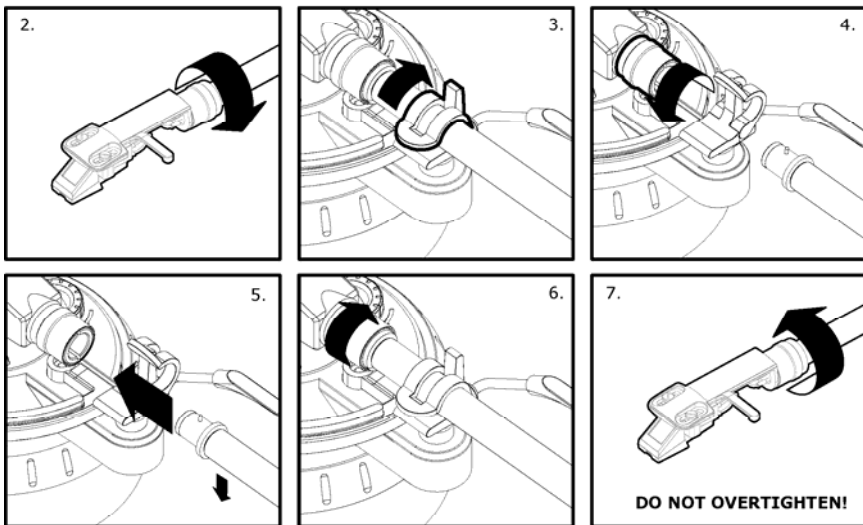

TONE ARM SETUP

A properly adjusted tone arm and cartridge setup will minimize vinyl record wear and optimize the performance of the turntable. Follow these simple steps for setting the tone arm on the turntable:

NOTE: In most cases, when using the S-Shaped tonearm tube, the additional S-Weight must be fastened to the tonearm to achieve proper stylus pressure. Balancing the Tone Arm

1. Begin the balancing process by lifting the cue lever to the up position (or make sure that the stylus protector is on the cartridge.)
2. Next, rotate the counterweight clockwise until it is in the complete forward position (NOTE: this is also the maximum amount of pressure that can be applied to the cartridge.)
3. Now there should be a feeling of weight and resistance when the head shell is raised and lowered. Begin rotating the counterweight counter-clockwise (away from the pivot point) until this weight and resistance feeling is gone. If done properly, the tone arm will pivot with very little resistance back and forth indicating that there is exactly 0 grams of stylus pressure.
4. With the counterweight in its new position further away from tone arm pivot point, grasp the scale ring of the counter weight and rotate it until "0" is in the vertical position.
5. Finally, rotate the counterweight (and scale ring) clockwise (towards the pivot point) until the desired amount of weight is reached. If the scale rotates 360 degrees beyond the zero point, the new scale ring reading should be added to 3.5.

*The included head shell and cartridge assembly requires a minimum of 3 grams and no more than 5 grams for optimum performance.

Setting the Anti-Skate Adjustment

In most cases, the Anti-Skate should be set to its minimum setting. Anti-Skate compensates for inward tracking forces that occur with certain cartridges when the stylus nears the center of the record. If the turntable is experiencing excessive skipping during back-cueing and scratching while nearing the center spindle, try increasing the Anti-Skate in the increments indicated on the dial. Start by adding an increment of 1, test its performance, then increase it more, and so on.

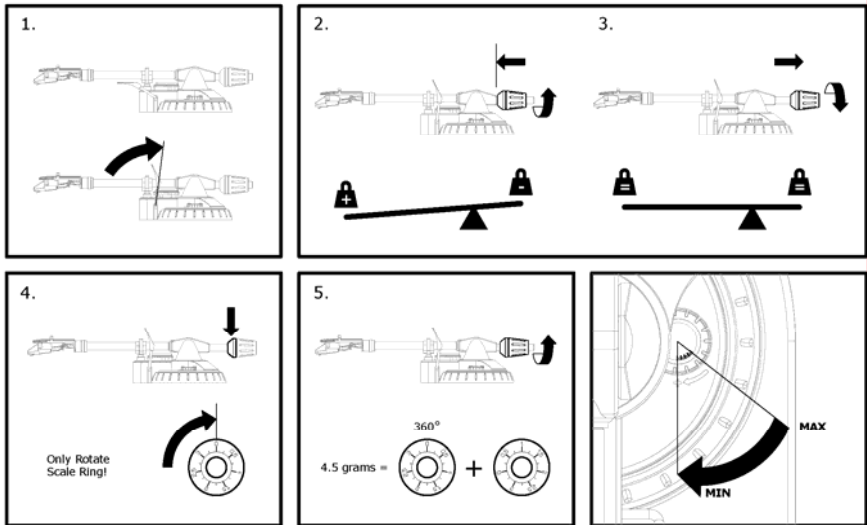

CONTROLS

General Controls

1. Power Button

Pushing this button down turns on the turntable. It illuminates red when the turntable is switched on.

2. Start/Stop Buttons

These buttons start and stop the turntable motor. Both buttons have the same function.

3. Platter

This turntable has a special edge design that has been optimized for "dragged" platter slow downs.

4. Reverse Button

Pushing this button down reverses the rotation direction of the turntable platter.

5. Pitch Slider

This slide control allows the pitch to be increased or decreased by 10%. In the center position the pitch is at 0%. When moved away from the center and towards the tone arm decreases the pitch (slows down the platter) and moving the pitch slider away from the tone arm increase the pitch (speeds up the platter)

6. Target Light

This aluminum target light can be removed and rotated depending on the head shell position and the amount of light required on the vinyl record surface.

7. Target Light Power Jack

This RCA Jack supplies power to the Target Light (sold separately). IT HAS NO AUDIO FUNCTION-DO NOT CONNECT AUDIO CORDS TO THIS POWER JACK.

8. 33 and 45 RPM Buttons

These buttons control the RPM of the turntable platter. A red LED indicates which RPM mode has been selected. When both the 33 and 45 RPM buttons are pressed, both LED's illuminate indicate 78 RPM mode has been engaged.

9. Quartz Button

The Pitch LED illuminates green when the pitch is set at 0% or the Quartz Button is engaged. When the pitch slider is moved away from zero, the LED illuminates red indicating the pitch is no longer at 0%.

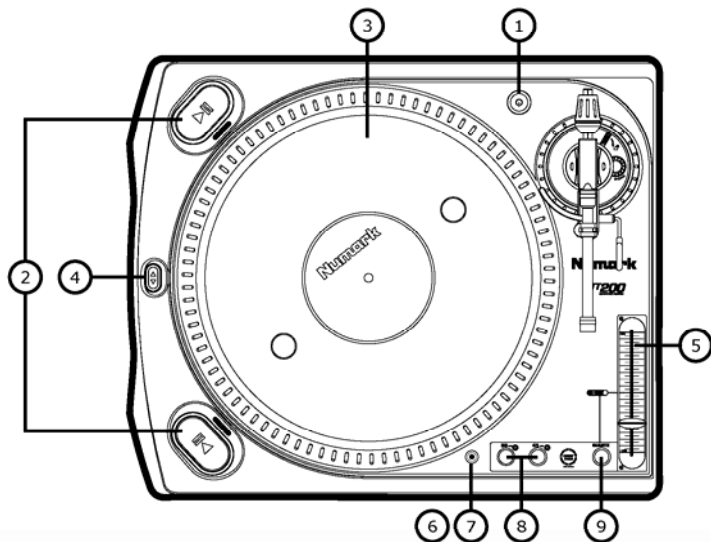

CONTROLS *continued*

Tone Arm Parts

10. Counterweight and Scale Ring and S-Weight

The Counterweight is used to balance the head shell and cartridge assembly so that the proper amount of stylus pressure is applied to the record. The S-Weight (sold separately with S-arm tube) should be used in most cases when the S-Shaped tube is used. It is fastened to the tonearm by threading it into the rear weight balance shaft. The S-weight can be stored below the counterweight in the top cabinet while not in use.

11. Height Adjust Ring

Turning this ring counter-clockwise raises the tonearm up to 6mm to accommodate for different Slipmat thicknesses. This ring can not be adjusted unless the Height Lock Lever (12) is unlocked.

12. Height Lock Lever

Turning this lever towards the direction of the arrow (clockwise) unlocks the Height Adjust Ring (11) so that the tonearm height can be adjusted.

13. Anti-Skate Adjustment

This knob is used to compensate for inward tracking forces. See tonearm setup for more details on its settings.

14. Secondary Tube Lock Collar

This collar is used to secure the tonearm tubes (straight or s-shaped) to the tonearm assembly.

WARNING:

DO NOT OVERTIGHTEN THIS LOCK COLLAR!

WARNING:

CONNECTING HEADSHELLS TO THIS COLLAR MAY DAMAGE THE INTERNAL PIN HEIGHTS OF THE CONTACTS! ONLY CONNECT NUMARK TUBES TO THE SECONDARY TUBE LOCK COLLAR.

15. Arm Clip

This specially designed arm clip secures the tone arm while it is being transported or not in use. The arm clip has been designed to remain in the up position while unlocked.

16. Tonearm Cue System

This cueing system allows the tone arm to be positioned at a certain point above the record and slowly engaged. When the lift lever is in the up position the tone arm should rest on the armrest. When the lift lever is lowered, the tone arm is slowly lowered until the stylus is resting on the record.

17. Tone Arm Lock Nut

This Aluminum nut is used to secure the head shell and cartridge assembly to the tone arm tube. See cartridge setup for more details.

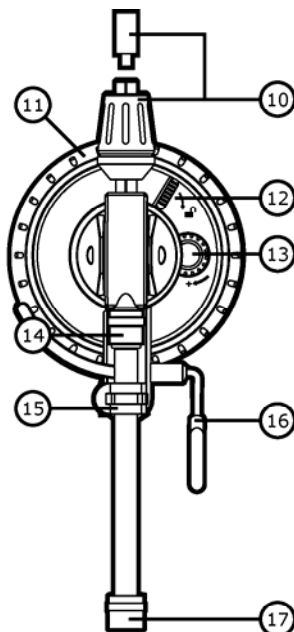

CONTROLS *continued*

Bottom Parts

18. Adjustable Rubber Dampening Feet

When all of the feet of the turntable are completely tightened, the top flat surface of the turntable will be at 85mm. Unscrewing these feet raises the turntable up to compensate for unlevelled surfaces.

19. Carrying Handles

These handles provide a secure grip so that the turntable may be comfortably transported.

20. Voltage Selector Fuse

This rotating Fuse Holder switches the internal voltage transformer between 100V, 120V, 220V and 240V. The turntable should be shipped with the proper voltage setting for your region. Check that the arrow is pointing to the proper voltage before connecting the IEC power cord to prevent damage to the turntable.

21. IEC Power Terminal

This IEC Power Terminal can be used with any IEC power cable, but it is recommended that the supplied IEC power cable be used.

22. RCA Output Jacks

These stereo output jacks allow the turntable to be connected to a compatible device with a PHONO level input.

23. Ground Screw

This Ground Screw is used to run a ground line between the turntable and the device it is connected to.

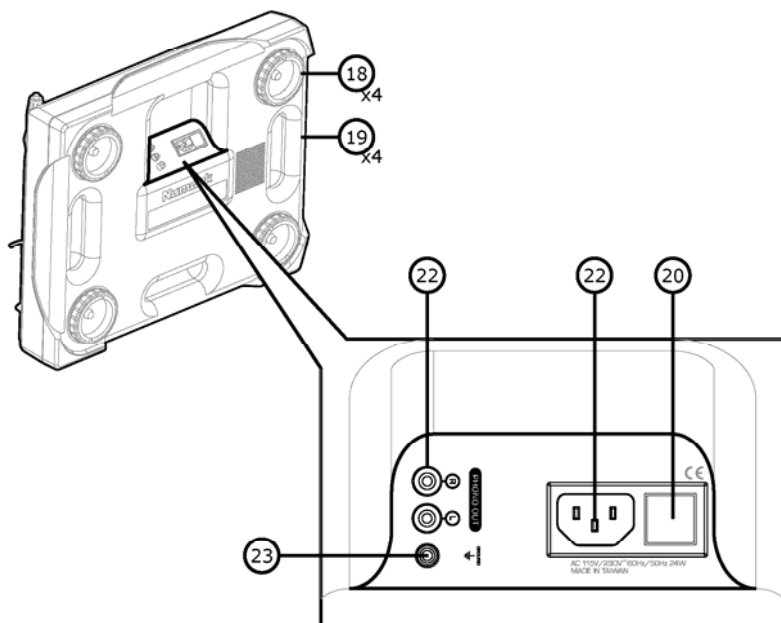

CABLE SETUP

This turntable is shipped with two sets of special cables:

- (1) Right Angle IEC Power Cord
- (1) Right Angle RCA cord w/ground wire

NOTE: Before connecting any cables, make sure that the voltage selector switch is set to the proper setting!

Making the power and audio connections:

1. Begin by lifting the turntable up from the rear handle and resting it on its side. (**NOTE:** The turntable must be supported because it is not stable in this position!)
2. First, using the side of the RCA cable with the Right Angle plugs, slightly loosen the ground screw and slide the ground clip underneath it. Tighten the ground screw against the ground clip so that the cable exits towards the IEC Power Terminal.
3. Next connect the Red Right Angle RCA Plug to the Red RCA jack with the "R" indication.
4. Then connect the White Right Angle RCA Plug to the White RCA jack with the "L" indication.
5. Finally connect the IEC power cord to the IEC Power terminal. It should only fit in the Terminal one way.
6. Rest the turntable back down on a level surface and route the cables to nearby power and audio accessories.

NOTE: When connecting this turntable to a DJ mixer, the ground wire must always be connected to prevent unwanted noise. It is also important that the RCA outputs of the turntable are connected to a mixer (or other preamp device) marked as PHONO or TURNTABLE. This turntable will not work properly if connected to a LINE LEVEL input or CD input.

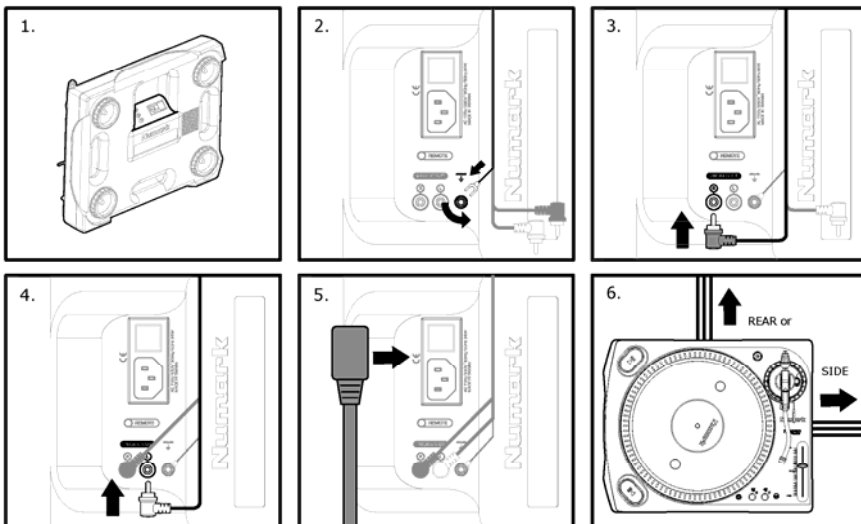

SPECIFICATIONS

Turntable Section:

Type:	3 speed, fully manual
Motor:	Direct Drive- 8 Pole, 3 Phase
Starting Torque:	1.6 kg/cm
Start Time:	0-33.33 RPM in 0.8 sec
Braking System:	Electronic Servo Brake
Platter:	Aluminum Diecast
Speeds:	33.33, 45, and 78 RPM
Wow & Flutter: Separation:	<0.2% WRMS 20 dB
Rumble:	-40dB (IEC 98A Unweighted) -50dB (IEC 98A Weighted)
Power Consumption:	35 Watts
Pitch Range:	+/-10%

Tonearm Section:

Type:	Locking collar based interchangeable tube system Diecast Aluminum 3-bearing construction
Height Range:	0-6 mm
Cue System:	Dampened Lift Lever, Arm Rest and Arm Clip
Weight:	18 lbs (8.2 kg)
Balance Weight:	7 gram S-weight 75 gram Aluminum Plated w/ 0-3.5 gram range scale
General:	
Dimensions:	370mm(W) by 460mm(D) by 135mm(H)
Weight:	18 lbs (8.2 g)

OPERATION

This turntable was designed to accommodate a variety of different mixing styles. Here are some general operation guidelines to optimize the performance of the turntable.

1. Do not place the turntable on or near a speaker or subwoofer. This may cause unwanted noise depending on the environment conditions.
2. ALWAYS use the included Slip Mat during record playback. This Slip Mat was designed to reduce friction between the platter and the record to allow for rapid back cueing and efficient scratch play.
3. Using the tone arm Cue System may prevent damage to your stylus. First lift the Cue Lever, then position the tone arm over the desired groove of the record, and finally lower the Cue Lever to slowly drop the tone arm onto the record.
4. Always secure the tone arm using the Arm Clip when not in use. This can prevent stylus damage and accidental tone arm engagement.
5. To reduce needle skipping, follow the guidelines in the Tone Arm Setup section of this manual. Too much weight on a cartridge may cause erratic skipping or stylus damage.

Another guideline that may reduce skipping is back cueing and adjusting playback tempo by applying pressure towards the center of the record near the spindle as indicated below.

Skipping induce by rapid cueing or scratching may be reduce by applying inward pressure to the side of the record instead of applying pressure down on the record (see diagram below.)

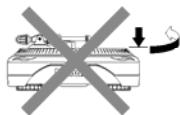

Problem	Cause?	Solution
Turntable does not turn on.	Disconnected Power Cord?	Connect Power Cord.
The sound level is very low.	The Turntable is not connected to a device with a PHONO preamp.	Connect the device to a preamp DJ mixer or an AV receiver that has an input labeled PHONO, not AUX or LINE.
The sound is on one side only.	The Cartridge is not properly wired. The Stylus is worn out. The RCA audio cord is disconnected. The RCA audio cord is damaged.	Reconnect the wires from the headshell to the cartridge. See the "Cartridge Setup" section for more detail. Replace the stylus on the cartridge. Replacement styli are available from most Numark Retailers. Properly secure the RCA cable to the preamp device and the bottom of the turntable. See the "Cable Connections" section for more detail. If the RCA cord is frequently connected and disconnected, it may have become damaged and needs to be replaced.
The output sound is very distorted.	The Cartridge is not properly wired. The Stylus is worn out.	Reconnect the wires from the headshell to the cartridge. See the "Cartridge Setup" section for more detail. Replace the stylus on the cartridge. Replacement styli are available from most Numark Retailers.
The Target Light glows inconsistently, flickers, or doesn't work at all.	The Target Light Lamp is burning or burned out.	Replace the entire target light with a compatible Numark part.
The Output sound exhibits excessive hum or buzzing.	The Turntable Grounding wires are not connected.	Connect the Turntable Ground wires to their respective Grounding Lug on all equipment (mixer, etc.)
The turntable skips like crazy.	The Turntable is on an unstable surface. The Tone Arm is not balanced properly. The Stylus is worn out. Excessive force is being applied directly down on the platter. The record is warped.	Follow the guidelines for installation in the "Setup & Installation" Section. Follow the guidelines for optimum setup in the "Tone Arm Setup" Section. Replace the stylus on the cartridge. Replacement styli are available from most Numark Retailers. Reread the "Operation" section of this manual. Buy new records.

NOTE:

Static electricity and/or other external interference may cause this unit to malfunction. To reset the unit to its normal condition, turn the power off and then on again. If the problem continues to persist, refer to the connected component's troubleshooting guides. If the problem is not resolved after checking these items, contact the nearest authorized Numark dealer.

INSIDE THE BOX:

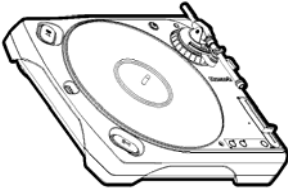

(1) TT-200 w/Straight
Tonearm

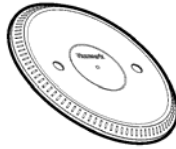

(1) Aluminum Platter



(1) Slipmat



(1) Headshell



(1) 2.5 Gram Headshell
Weight



(1) Counter Weight



(1) 45 RPM Adapter



(1) IEC Power Cable



(1) RCA Cord w/
Ground Wire



(1) Service Tool