

## Owner's Manual

Thank you, and congratulations on your choice of the Roland Percussion Sound Module TD-3.

Before using this unit, carefully read the sections entitled: "USING THE UNIT SAFELY" (p. 2) and "IMPORTANT NOTES" (p. 4). These sections provide important information concerning the proper operation of the unit. Additionally, in order to feel assured that you have gained a good grasp of every feature provided by your new unit, Owner's manual should be read in its entirety. The manual should be saved and kept on hand as a convenient reference.

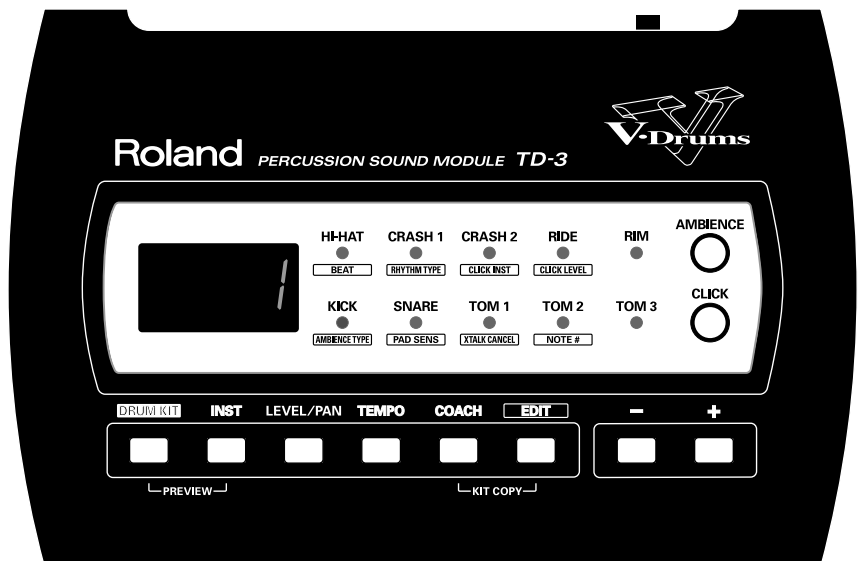

### Convention Used in This Manual

Words enclosed in square brackets indicate buttons on the panel.



**IMPORTANT:** THE WIRES IN THIS MAINS LEAD ARE COLOURED IN ACCORDANCE WITH THE FOLLOWING CODE.



BLUE: NEUTRAL  
BROWN: LIVE

As the colours of the wires in the mains lead of this apparatus may not correspond with the coloured markings identifying the terminals in your plug, proceed as follows:  
The wire which is coloured BLUE must be connected to the terminal which is marked with the letter N or coloured BLACK.  
The wire which is coloured BROWN must be connected to the terminal which is marked with the letter L or coloured RED.  
Under no circumstances must either of the above wires be connected to the earth terminal of a three pin plug.







## USING THE UNIT SAFELY

### INSTRUCTIONS FOR THE PREVENTION OF FIRE, ELECTRIC SHOCK, OR INJURY TO PERSONS

About  WARNING and  CAUTION Notices





 <b>WARNING</b>	Used for instructions intended to alert the user to the risk of death or severe injury should the unit be used improperly.
 <b>CAUTION</b>	Used for instructions intended to alert the user to the risk of injury or material damage should the unit be used improperly. * Material damage refers to damage or other adverse effects caused with respect to the home and all its furnishings, as well to domestic animals or pets.

About the Symbols





	The  symbol alerts the user to important instructions or warnings. The specific meaning of the symbol is determined by the design contained within the triangle. In the case of the symbol at left, it is used for general cautions, warnings, or alerts to danger.
	The  symbol alerts the user to items that must never be carried out (are forbidden). The specific thing that must not be done is indicated by the design contained within the circle. In the case of the symbol at left, it means that the unit must never be disassembled.
	The  symbol alerts the user to things that must be carried out. The specific thing that must be done is indicated by the design contained within the circle. In the case of the symbol at left, it means that the power-cord plug must be unplugged from the outlet.

### ALWAYS OBSERVE THE FOLLOWING









#### WARNING

- Before using this unit, make sure to read the instructions below, and the Owner's Manual. 
- Do not open (or modify in any way) the unit or its AC adaptor. 
- Do not attempt to repair the unit, or replace parts within it (except when this manual provides specific instructions directing you to do so). Refer all servicing to your retailer, the nearest Roland Service Center, or an authorized Roland distributor, as listed on the "Information" page. 
- Never use or store the unit in places that are:
  - Subject to temperature extremes (e.g., direct sunlight in an enclosed vehicle, near a heating duct, on top of heat-generating equipment); or are 
  - Damp (e.g., baths, washrooms, on wet floors); or are 
  - Humid; or are
  - Exposed to rain; or are
  - Dusty; or are
  - Subject to high levels of vibration.











#### WARNING

- This unit should be used only with a rack or stand that is recommended by Roland. 
- When using the unit with a rack or stand recommended by Roland, the rack or stand must be carefully placed so it is level and sure to remain stable. If not using a rack or stand, you still need to make sure that any location you choose for placing the unit provides a level surface that will properly support the unit, and keep it from wobbling. 
- Be sure to use only the AC adaptor supplied with the unit. Also, make sure the line voltage at the installation matches the input voltage specified on the AC adaptor's body. Other AC adaptors may use a different polarity, or be designed for a different voltage, so their use could result in damage, malfunction, or electric shock. 
- Do not excessively twist or bend the power cord, nor place heavy objects on it. Doing so can damage the cord, producing severed elements and short circuits. Damaged cords are fire and shock hazards! 

## **WARNING**

- This unit, either alone or in combination with an amplifier and headphones or speakers, may be capable of producing sound levels that could cause permanent hearing loss. Do not operate for a long period of time at a high volume level, or at a level that is uncomfortable. If you experience any hearing loss or ringing in the ears, you should immediately stop using the unit, and consult an audiologist. 
- Do not allow any objects (e.g., flammable material, coins, pins); or liquids of any kind (water, soft drinks, etc.) to penetrate the unit.   

- Immediately turn the power off, remove the AC adaptor from the outlet, and request servicing by your retailer, the nearest Roland Service Center, or an authorized Roland distributor, as listed on the "Information" page when:  

  - The AC adaptor or the power-supply cord has been damaged; or
  - If smoke or unusual odor occurs
  - Objects have fallen into, or liquid has been spilled onto the unit; or
  - The unit has been exposed to rain (or otherwise has become wet); or
  - The unit does not appear to operate normally or exhibits a marked change in performance.
- In households with small children, an adult should provide supervision until the child is capable of following all the rules essential for the safe operation of the unit. 
- Protect the unit from strong impact. (Do not drop it!) 
- Do not force the unit's power-supply cord to share an outlet with an unreasonable number of other devices. Be especially careful when using extension cords—the total power used by all devices you have connected to the extension cord's outlet must never exceed the power rating (watts/amperes) for the extension cord. Excessive loads can cause the insulation on the cord to heat up and eventually melt through. 
- Before using the unit in a foreign country, consult with your retailer, the nearest Roland Service Center, or an authorized Roland distributor, as listed on the "Information" page. 

## **CAUTION**

- The unit and the AC adaptor should be located so their location or position does not interfere with their proper ventilation. 
- This TD-3 for use only with Roland stand. Use with other stands is capable of resulting in instability causing possible injury. 
- Always grasp only the output plug or the body of the AC adaptor when plugging into, or unplugging from, this unit or an outlet. 
- At regular intervals, you should unplug the AC adaptor and clean it by using a dry cloth to wipe all dust and other accumulations away from its prongs. Also, disconnect the power plug from the power outlet whenever the unit is to remain unused for an extended period of time. Any accumulation of dust between the power plug and the power outlet can result in poor insulation and lead to fire. 
- Try to prevent cords and cables from becoming entangled. Also, all cords and cables should be placed so they are out of the reach of children. 
- Never climb on top of, nor place heavy objects on the unit. 
- Never handle the AC adaptor body, or its output plugs, with wet hands when plugging into, or unplugging from, an outlet or this unit. 
- Before moving the unit, disconnect the AC adaptor and all cords coming from external devices. 
- Before cleaning the unit, turn off the power and unplug the AC adaptor from the outlet (p. 13, p. 15). 
- Whenever you suspect the possibility of lightning in your area, disconnect the AC adaptor from the outlet. 
- Should you remove screws for attaching the stand holder, make sure to put them in a safe place out of children's reach, so there is no chance of them being swallowed accidentally. 

# IMPORTANT NOTES

In addition to the items listed under “USING THE UNIT SAFELY” on pages 2–3, please read and observe the following:

## Power Supply

- Do not connect this unit to same electrical outlet that is being used by an electrical appliance that is controlled by an inverter (such as a refrigerator, washing machine, microwave oven, or air conditioner), or that contains a motor. Depending on the way in which the electrical appliance is used, power supply noise may cause this unit to malfunction or may produce audible noise. If it is not practical to use a separate electrical outlet, connect a power supply noise filter between this unit and the electrical outlet.
- The AC adaptor will begin to generate heat after long hours of consecutive use. This is normal, and is not a cause for concern.
- Before connecting this unit to other devices, turn off the power to all units. This will help prevent malfunctions and/or damage to speakers or other devices.

## Placement

- Using the unit near power amplifiers (or other equipment containing large power transformers) may induce hum. To alleviate the problem, change the orientation of this unit; or move it farther away from the source of interference.
- This device may interfere with radio and television reception. Do not use this device in the vicinity of such receivers.
- Noise may be produced if wireless communications devices, such as cell phones, are operated in the vicinity of this unit. Such noise could occur when receiving or initiating a call, or while conversing. Should you experience such problems, you should relocate such wireless devices so they are at a greater distance from this unit, or switch them off.
- Do not expose the unit to direct sunlight, place it near devices that radiate heat, leave it inside an enclosed vehicle, or otherwise subject it to temperature extremes. Excessive heat can deform or discolor the unit.
- When moved from one location to another where the temperature and/or humidity is very different, water droplets (condensation) may form inside the unit. Damage or malfunction may result if you attempt to use the unit in this condition. Therefore, before using the unit, you must allow it to stand for several hours, until the condensation has completely evaporated.

## Maintenance

- For everyday cleaning wipe the unit with a soft, dry cloth or one that has been slightly dampened with water. To remove stubborn dirt, use a cloth impregnated with a mild, non-abrasive detergent. Afterwards, be sure to wipe the unit thoroughly with a soft, dry cloth.
- Never use benzine, thinners, alcohol or solvents of any kind, to avoid the possibility of discoloration and/or deformation.

## Repairs and Data

- Please be aware that all data contained in the unit’s memory may be lost when the unit is sent for repairs. Important data should always be backed up in another MIDI device (e.g., a sequencer), or written down on paper (when possible). During repairs, due care is taken to avoid the loss of data. However, in certain cases (such as when circuitry related to memory itself is out of order), we regret that it may not be possible to restore the data, and Roland assumes no liability concerning such loss of data.

## Additional Precautions

- Please be aware that the contents of memory can be irretrievably lost as a result of a malfunction, or the improper operation of the unit. To protect yourself against the risk of losing important data, we recommend that you periodically save a backup copy of important data you have stored in the unit’s memory in another MIDI device (e.g., a sequencer).
- Unfortunately, it may be impossible to restore the contents of data that was stored in the unit’s memory or another MIDI device (e.g., a sequencer) once it has been lost. Roland Corporation assumes no liability concerning such loss of data.
- Use a reasonable amount of care when using the unit’s buttons, sliders, or other controls; and when using its jacks and connectors. Rough handling can lead to malfunctions.
- When connecting / disconnecting all cables, grasp the connector itself—never pull on the cable. This way you will avoid causing shorts, or damage to the cable’s internal elements.
- To avoid disturbing your neighbors, try to keep the unit’s volume at reasonable levels. You may prefer to use headphones, so you do not need to be concerned about those around you (especially when it is late at night).
- Since sound vibrations can be transmitted through floors and walls to a greater degree than expected, take care not to allow such sound to become a nuisance to neighbors, especially at night and when using headphones. Although the drum pads and pedals are designed so there is a minimal amount of extraneous sound produced when they’re struck, rubber heads tend to produce louder sounds compared to mesh heads. You can effectively reduce much of the unwanted sound from the pads by switching to mesh heads.
- When you need to transport the unit, package it in the box (including padding) that it came in, if possible. Otherwise, you will need to use equivalent packaging materials.
- Use a cable from Roland to make the connection. If using some other make of connection cable, please note the following precautions.
  - Some connection cables contain resistors. Do not use cables that incorporate resistors for connecting to this unit. The use of such cables can cause the sound level to be extremely low, or impossible to hear. For information on cable specifications, contact the manufacturer of the cable.

# Contents

<b>USING THE UNIT SAFELY</b> .....	<b>2</b>
<b>IMPORTANT NOTES</b> .....	<b>4</b>
<b>Features</b> .....	<b>8</b>
<b>Panel Descriptions</b> .....	<b>9</b>
Top Panel.....	9
Rear Panel .....	10
Side Panel.....	10
<b>Setting Up the Kit</b> .....	<b>11</b>
Mounting the TD-3 on the Stand .....	11
Connecting the Pads and the Pedals .....	12
Connecting Headphones, Audio Equipment, Amps, and Other Gear .....	13
Turning On/Off the Power .....	14
Turning Off the Power.....	15
<b>Choosing a Drum Kit</b> .....	<b>16</b>
Hearing What the Kits Sound Like (Preview) .....	17
<b>Playing the Drum Kit</b> .....	<b>18</b>
Trigger Inputs and Triggering Possibilities .....	18
Playing the Pads.....	19
Head and Rim Shots.....	19
Cross Stick on the Snare Pad.....	20
Cymbal Bow Shots/Edge Shots.....	20
Cymbal Choke.....	20
Hi-Hat Control Pedal.....	21
<b>Creating Your Own Drum Kit</b> .....	<b>22</b>
Choosing a Drum Kit [DRUM KIT].....	23
Selecting Sounds [INST].....	24
Instrument Volume & Pan [LEVEL/PAN] .....	25
Ambience Settings [AMBIENCE] .....	26
Switching Ambience On/Off.....	26
Selecting the Ambience Type.....	26
Copying a Drum Kit [KIT COPY].....	27
<b>Playing with the Metronome (Click)</b> .....	<b>28</b>
Starting and Stopping the Metronome On/Off [CLICK].....	28
Tempo Adjustment [TEMPO] .....	28
Setting the Time Signature [BEAT] .....	29
Selecting a Rhythm Type [RHYTHM TYPE] .....	30
Selecting the Click Sound [CLICK INST] .....	32
Volume Adjustment [CLICK LEVEL].....	33

<b>Playing with a CD, Tape, or MD (Via MIX IN Jack)</b> .....	<b>34</b>
<b>COACH Mode</b> .....	<b>35</b>
Setting Procedure .....	35
Accuracy and Timing Exercises .....	36
Warm Up (Rhythmic Notes) .....	36
Correctly Playing in Time with the Beat (Time Check) .....	36
Quiet Count—Developing Internal Timing Sense .....	37
Speed Check—8 Measure Timing Accuracy Challenge .....	37
Endurance and Stamina Exercises .....	38
Gradual Up/Down—Tempo Increase/Decrease Exercise .....	38
Step Up/Down—Tempo Increase/Decrease in Steps .....	38
Voice “Count In” / Visual Measure Counter .....	39
Count In and Measure Counter .....	39
<b>Pad Adjustments</b> .....	<b>40</b>
Adjusting Pad Sensitivity [PAD SENS] .....	40
Eliminate Crosstalk Between Pads [XTALK CANCEL] .....	41
<b>Hi-Hat Control Pedal Adjustment</b> .....	<b>42</b>
Adjusting the Hi-Hat’s Foot Closed Level .....	42
<b>Factory Reset (Restoring the Factory Settings)</b> .....	<b>43</b>
<b>About the Pads</b> .....	<b>44</b>
Trigger Inputs and the Pads You Can Use .....	44
Trigger Input Functions .....	44
About Polarity Switch .....	44
Combinations of Pad and Trigger Input .....	45
Playing the Pads .....	46
Head Shots and Rim Shots .....	46
Cross Stick on the Snare Pad .....	46
Cymbal Bow Shots/Edge Shots/Bell Shots .....	47
Cymbal Choke .....	47
<b>Pad Configuration Possibilities</b> .....	<b>48</b>
Three Toms and Three Cymbals .....	48
Two Toms and Four Cymbals .....	49
<b>Pad and Trigger Settings</b> .....	<b>50</b>
Selecting the Pad Type (Trigger Type) .....	50
Adjusting Pad Sensitivity .....	52
Setting the Minimum Levels for the Pads (Threshold) .....	53
How Playing Dynamics Changes the Volume (Velocity Curve) .....	54
Adjusting the Trigger Signal Detection Time (Scan Time) .....	55
Detecting Trigger Signal Attenuation and Cancelling Incorrect Triggering (Retrigger Cancel) .....	56
Eliminate Crosstalk Between Pads (Crosstalk Cancel) .....	57
Double Triggering Prevention (Mask Time) .....	58
Rim Shots Response (Rim Sensitivity) .....	59
Rim/Edge Dynamic Response (Rim Gain) .....	59

- MIDI Settings ..... 60**
  - About MIDI..... 60
    - MIDI Connectors ..... 60
  - MIDI Note Number for Each Pad [NOTE#]..... 60
  - When Only Using as a MIDI Controller (Local Control) ..... 62
  - Saving Data to an External MIDI Device (Bulk Dump) ..... 62
    - Loading Data to the TD-3 ..... 63
  - Using MIDI ..... 63
    - MIDI Channel..... 63
    - Program Changes Transmitting/Receiving ..... 63
    - Control Changes Using the Hi-Hat Control Pedal ..... 63
    - Messages for Transmitting Choking Information ..... 63
    - Triggering an External Sound Module from the TD-3..... 64
    - Recording to an External Sequencer ..... 64
    - Using the TD-3 As a Sound Module ..... 64
- Troubleshooting / Error Messages..... 65**
  - Troubleshooting ..... 65
    - No Sound ..... 65
    - No Sound/Low Volume from Source Connected to the MIX IN Jack ..... 66
    - Drum Kit Does Not Sound As Intended ..... 66
    - Pad Does Not Sound As Intended ..... 66
    - Sound is Distorted ..... 66
    - Cannot Carry Out Bulk Dump ..... 66
  - Error Messages ..... 67
- Drum Kit List ..... 68**
- Drum Instrument List..... 69**
- MIDI Implementation Chart ..... 70**
- Specifications..... 71**
- Index..... 72**

# Features

## Includes Carefully Selected Sounds for All Musical Styles for Live Performance or Practice

### 32 Different Drum Kits

You can immediately start playing with a variety of drum kits, just by pushing a button. The kits have been created to cover all styles of music.

### 114 Instruments

Create your own, original kits by selecting from the instrument list.

## Expressive Possibilities

**Play Rim Shots (p. 19, p. 46), Cymbal/Hi-Hat Edge Shots (p. 20, p. 47), and Use Cymbal/Hi-Hat Choking (p. 20, p. 47)**

**Cross Stick Technique is Possible (p. 20, p. 46)**

**Hi-Hat Control Pedal Provides Natural-Sounding Hi-Hat Performance (Open, Half-Open, Closed, Foot) (p. 21)**

## Convenient Functions for Practicing

**Built-In Metronome (Click) for Practicing or Performing Uses (p. 28)**

**Internal Intelligent “Coach” Function Makes Practicing Fun and Challenging (p. 35)**

**MIX IN Jack Allows You to Practice an External Audio Source (CD, MD) (p. 34)**

## Expandability & Compatibility

**Connect a Combination of Up to 9 Pads, Cymbals, and Kick Triggers (p. 44)**

**Pads** (PD-8, PD-6, PD-7, PD-9, PD-80, PD-80R, PD-85, PD-100, PD-105, PD-120, PD-125)

**Cymbals** (CY-8, CY-6, CY-12R/C, CY-12H, CY-14C, CY-15R)

**Kick Triggers** (KD-8, KD-7, KD-80, KD-85, KD-120)

**Acoustic Drum Triggers** (RT-3T, RT-5S, RT-7K)

**Functions as a MIDI Sound Module and as a MIDI Controller. (p. 64)**



# Panel Descriptions

## Top Panel

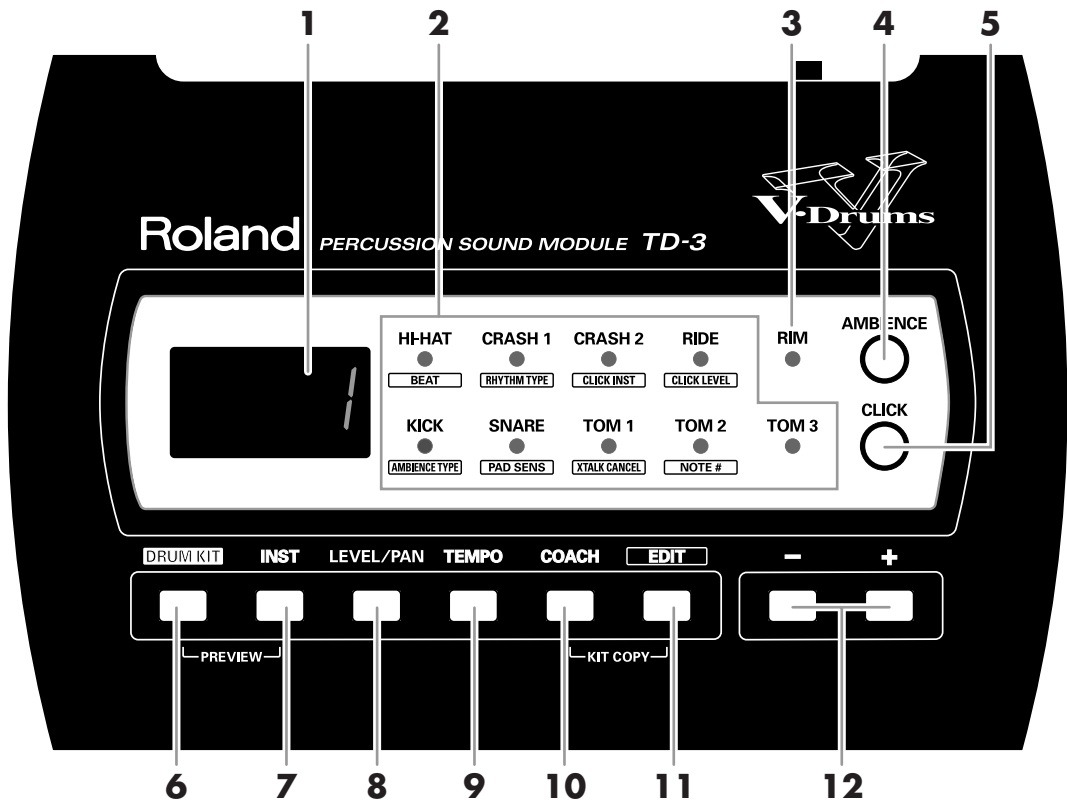

### 1. Display

The screen displays the drum kit number, tempo, parameter settings, and other such information.

### 2. Trigger Indicators

The indicator for the struck pad lights up.

When [EDIT] is pressed, the indicator corresponding to the selected parameter lights up.

### 3. Rim Indicator

This trigger indicator simultaneously lights when you strike the rim or edge.

### 4. AMBIENCE Button

Turns the ambience (Room Reverberation) on and off (p. 26).

### 5. CLICK Button

Turns the metronome (click) on/off.

### 6. DRUM KIT Button

Displays the drum kit number.

### 7. INST Button

Displays the instrument number for the pad being played.

### 8. LEVEL/PAN Button

Each press of this button alternates between level (volume) and pan (position in the stereo field—left/right).

### 9. TEMPO Button

Displays the tempo settings of the metronome.

### 10. COACH Button

This switches the TD-3 to Coach mode (p. 35).

### 11. EDIT Button

Use this for setting the kit parameters (p. 22), click parameters (p. 28) and pad parameters (p. 40, p. 50, p. 60).

### 12. +/- Button

These are used to make changes in the settings values.

## Rear Panel

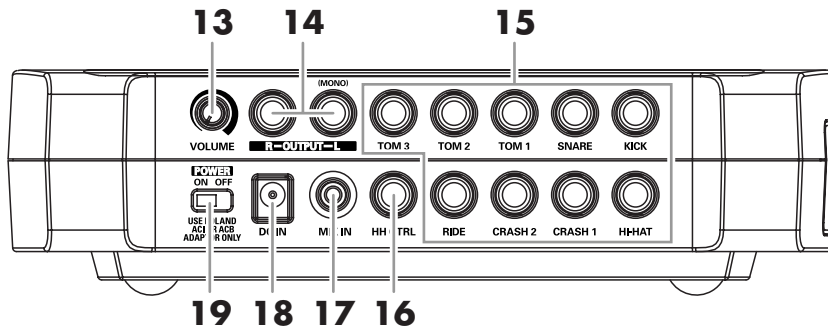

### 13. VOLUME Knob

Adjusts the volume of the TD-3 in both the headphones and various output jacks.

### 14. OUTPUT Jacks (L (MONO), R)

For connecting to your amp or audio system. For monaural output use the L/MONO jack (p. 13).

### 15. TRIGGER INPUT Jacks

For connecting pads, cymbals, and kick triggers (Optional or those included with the kit) (p. 12). For more detailed information on each trigger input, refer to **Trigger Inputs and the Pads You Can Use** (p. 44).

### 16. HH CTRL (Hi-Hat Control) Jack

Connect a hi-hat control pedal optional FD-7/FD-6; or FD-8 included with the TD-3Kit. (p. 12)

### 17. MIX IN Jack

For connecting CD, MD, cassette player, or other audio source (p. 34). Sound input to this jack will be output from the OUTPUT jacks and the PHONES jack.

### 18. AC Adaptor Jack

Connect the supplied AC adaptor to this jack (p. 13).

### 19. POWER Switch

Turns the power on/off (p. 14).

## Side Panel

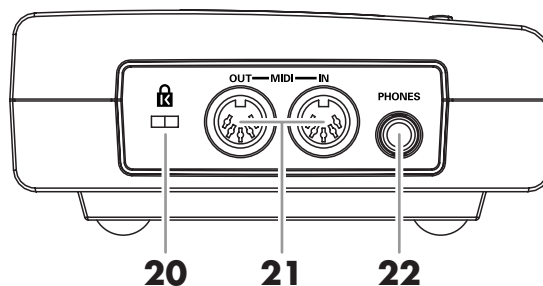

### 20. Security Slot ( )

<http://www.kensington.com/>

### 21. MIDI Connectors (IN, OUT)

**IN:** For a MIDI source (sequencer, keyboard, or other MIDI device) to play sounds in the TD-3, or to load data from a MIDI sequencer.

**OUT:** When using the TD-3/pads to play sounds in an external MIDI sound module, or when saving the TD-3's data to a MIDI sequencer.

(p. 60)

### 22. PHONES Jack

A pair of stereo headphones can be connected to this jack (p. 13). Connecting the headphones will not mute the output from the output jacks.

# Setting Up the Kit

## Mounting the TD-3 on the Stand

1. Attach the stand holder (included with the optional drum stand) to the TD-3. Using the screws attached to the bottom panel, attach the holder so the unit is oriented as shown in the diagram.

**NOTE** ONLY Use the 8 mm screws (M5 x 8) provided with the TD-3. Other screws may damage the unit.

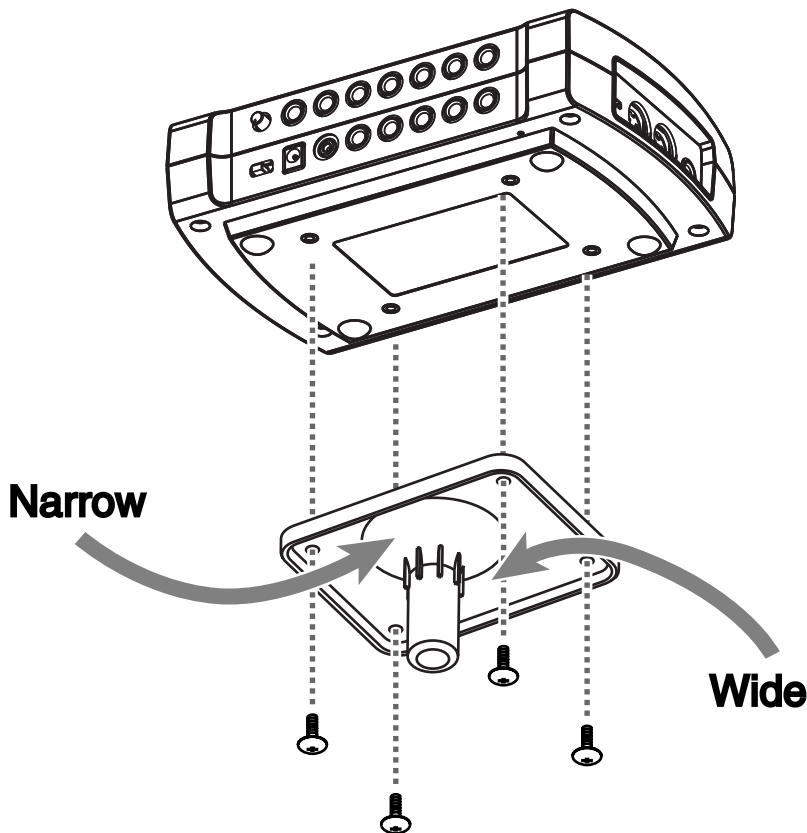

**NOTE** When turning the unit upside-down, get a bunch of newspapers or magazines, and place them under the four corners or at both ends to prevent damage to the buttons and controls. Also, you should try to orient the unit so no buttons or controls get damaged.

**NOTE** When turning the unit upside-down, handle with care to avoid dropping it, or allowing it to fall or tip over.

2. Attach the TD-3 and stand holder to the drum stand (such as the optional MDS-3C). See the owner's manual for the stand for details on assembling the drum stand and attaching the TD-3.

**MEMO** The optional APC-33 All Purpose Clamp can be attached to a pipe of 10.5mm–30 mm radius in case you want to mount the TD-3 on a cymbal stand or other such stand.

## Connecting the Pads and the Pedals

Using the provided cables, connect the pads, cymbal pads, hi-hat control pedal, and kick trigger.

### Setting Example

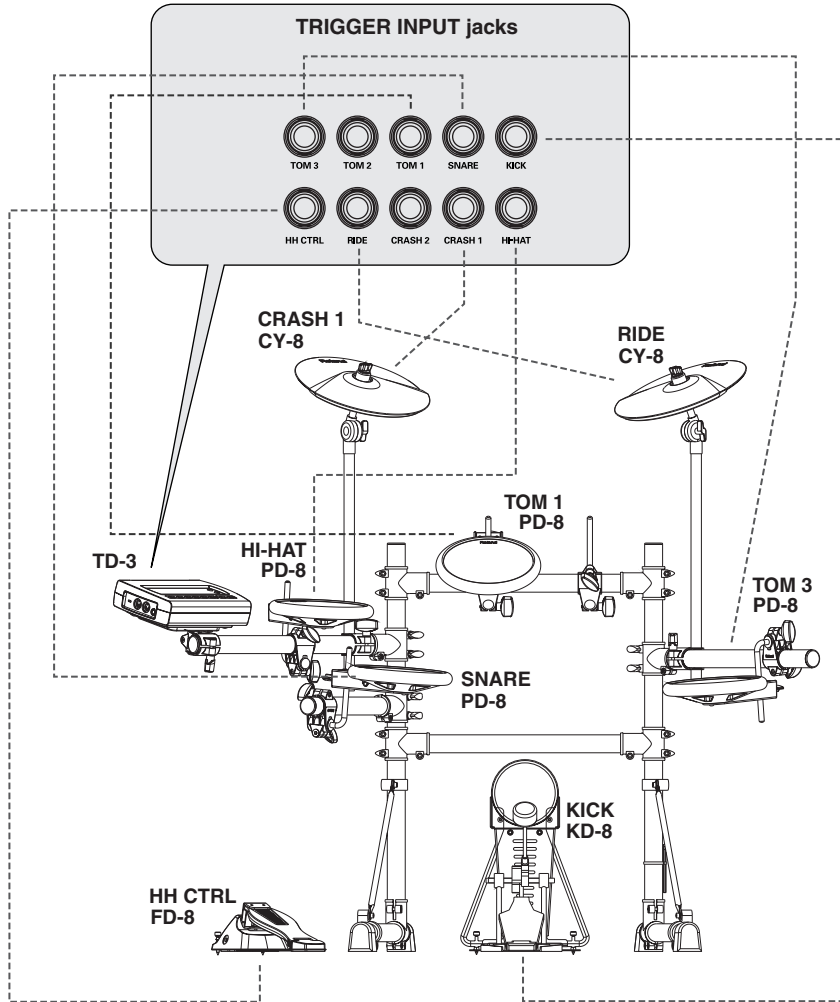

For more examples showing other ways to connect the TD-3, see “**Pad Configuration Possibilities**” (p. 48).

## Connecting Headphones, Audio Equipment, Amps, and Other Gear

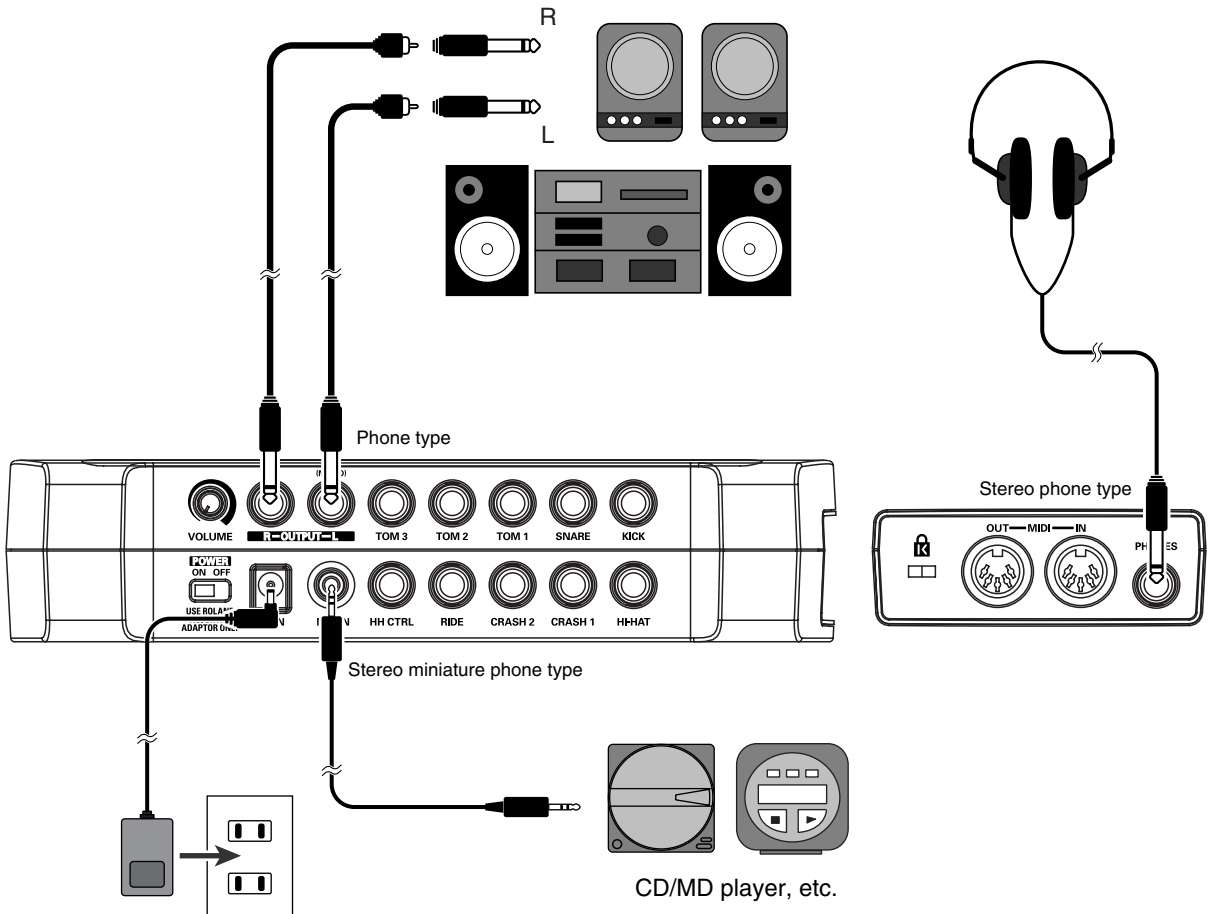

1. Turn off the power of all devices before you make connections.

**NOTE** To prevent malfunction and/or damage to speakers or other devices, always turn down the volume, and turn off the power on all devices before making any connections.

2. Connect the OUTPUT L(MONO) and R jacks on the rear panel to your audio system or amp. Headphones should ONLY be connected to the PHONES jack.
3. Connect the supplied AC adaptor to the AC adaptor jack.
4. Plug the AC adaptor plug into a power outlet.

**MEMO** The TD-3's MIX IN Jack allows you to play along with a CD or other audio sources (p. 34).

## Turning On/Off the Power

\* Once the connections have been completed (p. 12, p. 13), turn on power to your various devices in the order specified. By turning on devices in the wrong order, you risk causing malfunction and/or damage to speakers and other devices.

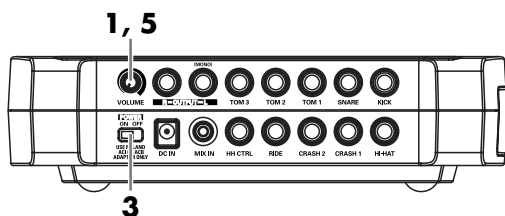

1. Turn the VOLUME knob on the TD-3's rear panel completely to the left to lower the volume to "0."
2. Turn down the volume control on the connected amp or audio system.
3. Set the POWER switch to the "ON" position to turn on the power.

\* Always make sure to have the volume level turned down before switching on power. Even with the volume all the way down, you may still hear some sound when the power is switched on, but this is normal, and does not indicate a malfunction.

### Precautions When Turning on the Power

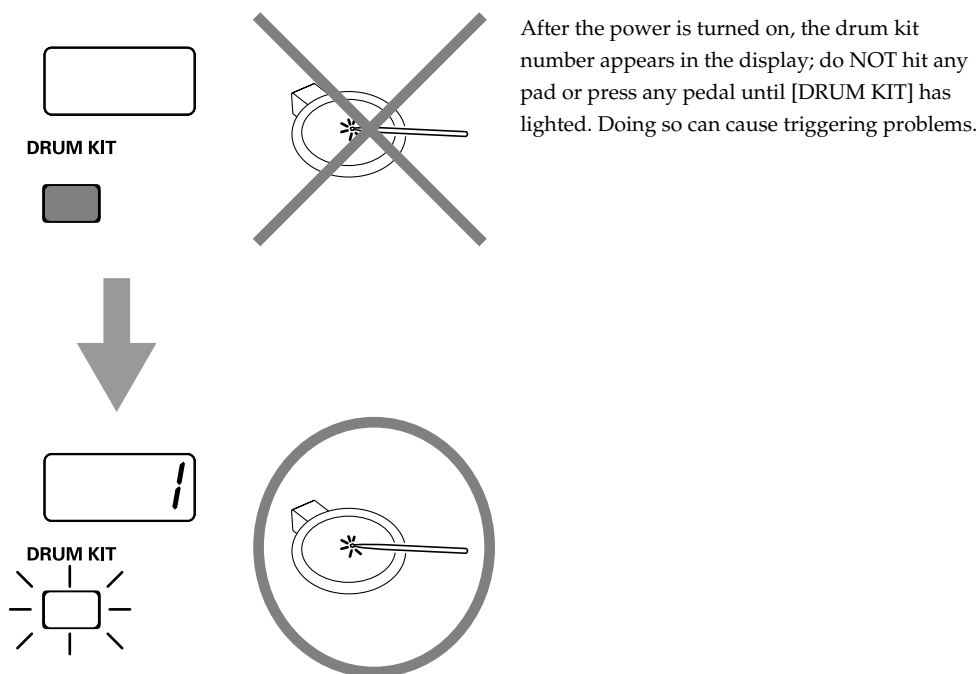

4. Turn on the power to the connected amp or audio system.
5. While hitting a pad, gradually turn the VOLUME knob to the right to adjust the volume level.

**No Sound When Hitting the Pads or Using the Pedals?**

Check the following points.

**When Using an Amp or Audio System**

- Is the amp or audio system volume setting correct?
- Are the TD-3 and the amp or audio system connected correctly?
- Is there a problem with any connector cable?
- Have the input select settings of your audio system or amp been made correctly?

**When using headphones**

- Are the headphones connected to the PHONES jack?

## Turning Off the Power

1. Completely turn down the volume of the TD-3 and any connected external devices.
2. Turn off the power to all external devices.
3. Set the TD-3's POWER switch to the "OFF" position to turn off the power.

# Choosing a Drum Kit

The TD-3 comes with 32 preset drum kits.

**MEMO** To see what types of drum kits there are, refer to “Drum Kit List” (p. 68).

**TERM** Each drum kit has its own settings: pad/instrument parameters etc. For details, refer to p. 22.

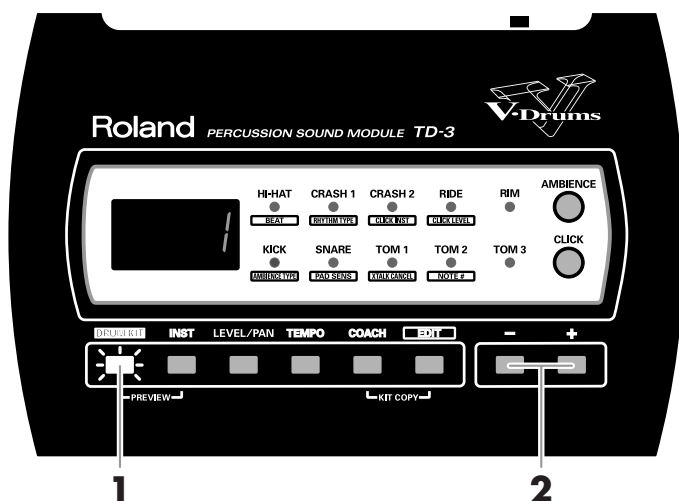

1. Press [DRUM KIT].  
[DRUM KIT] lights, and the drum kit number appears.  
Hit the pads to hear the sounds that are played.
2. Press [+] or [-] to select another kit.



## Hearing What the Kits Sound Like (Preview)

You can preview the sound of the currently selected drum kit.

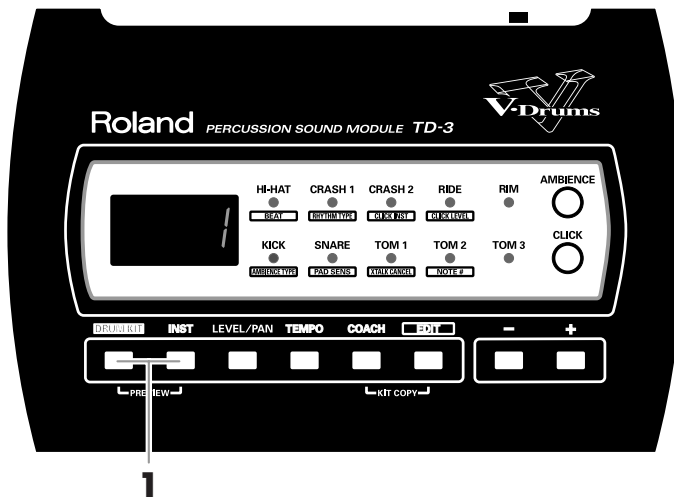

1. With a drum kit selected, hold down [DRUM KIT] and press [INST].  
The kit preview pattern is played repeatedly. (loop mode)  
Trigger or rim indicators light up for the pad whose sound is being played.

\* Kit preview patterns are always played at a tempo of 94 (quarter-note) beats per minute, regardless of the tempo setting for the metronome (p. 28).

2. Press [DRUM KIT] to stop the kit preview pattern.

**MEMO** You can press [+] and [-] while the kit preview pattern is playing to switch to other drum kits.  
Press [AMBIENCE] to turn the Ambience (p. 26) on and off.

### **NOTE** Caution Concerning Volume

When playing back the kit preview pattern, rotate the VOLUME knob to the left (counterclockwise) to bring the volume level down. The sound levels (volume) of the instruments may be louder when the preview pattern is played back.

# Playing the Drum Kit

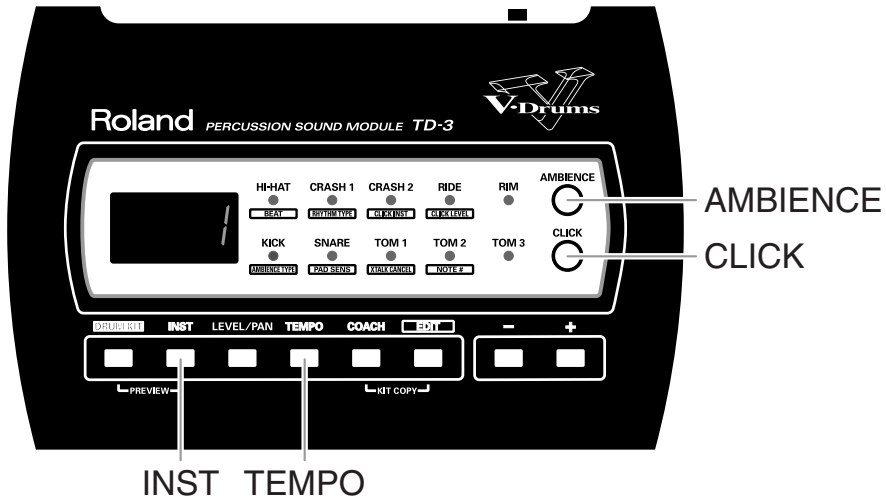

- Pressing [INST] allows you to change the instrument (p. 24).
- Pressing [AMBIENCE] switch the Ambience on and off (p. 26).
- Pressing [CLICK] (metronome) starts the metronome (p. 28).
- Press [TEMPO] to adjust the tempo (p. 28).

## Trigger Inputs and Triggering Possibilities

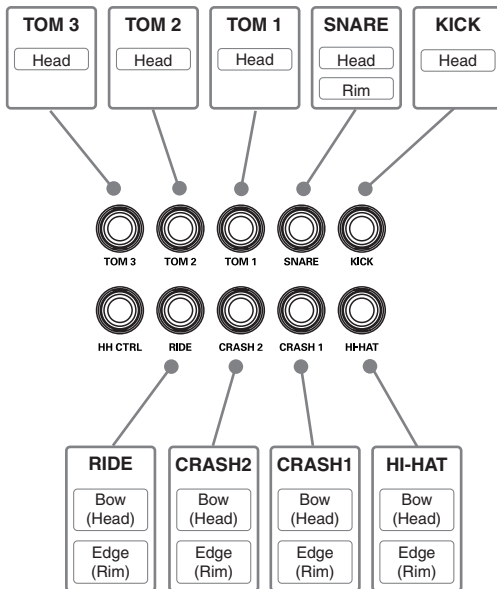

The following trigger inputs allow you to play either rim shots and cross stick on the snare pad, or cymbal edge shots and choking, and other techniques.

The trigger inputs capable of handling dual triggering pads/triggers are as follows.

- SNARE
- HI-HAT
- CRASH 1
- CRASH 2
- RIDE

# Playing the Pads

## Head and Rim Shots

### When Playing the Snare

**Head Shot**

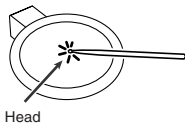

**Rim Shot**

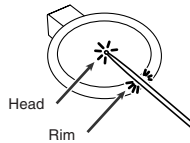

To play the sound assigned to the head, hit only the head.

To play a rim shot, you must **strike both the head and the rim of the pad simultaneously**.

**MEMO**

Be sure the Snare pad is connected to the SNARE trigger input jack.

**TIP**

Certain instrument names, for example: "S1" as the snare head instrument and "S1r" as the rim instrument are actually "matched" as it is the head and rim from the same drum.

(→ **Selecting Sounds [INST]** (p. 24))

### When Playing the Hi-Hat

**Bow Shot**

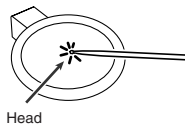

**Edge Shot**

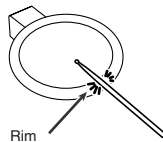

Hitting the head is like playing the bow of the hi-hat and hitting the rim is like playing the edge of the hi-hat cymbals.

**TIP**

When you select "H01" as the HI-HAT bow (head) instrument and "H02" as the edge (rim) instrument (or "H03" for the bow and "H04" for the edge), you will notice they correspond to the same hi-hat. (→ **Selecting Sounds [INST]** (p. 24))

## Cross Stick on the Snare Pad

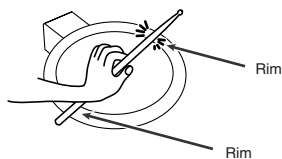

The cross stick sound is sometimes referred to as a “closed rim shot.” When using the PD-8 to play the cross stick, be sure that you **only strike the rim (outer edge) of the pad**. Placing your hand on the head (center area) of the pad might prevent the cross stick sound from being played properly.

**MEMO** Be sure the Snare pad is connected to the SNARE trigger input jack.

**TIP** To play a cross stick sound, assign “S1r,” “S2r,” “S3r,” “S4r,” “S10,” or “S11” to the rim. By selecting either “S1r,” “S2r,” “S3r,” or “S4r” as the SNARE rim instrument, you can have either rim shot or cross stick sounds depending on how you play the instrument. (→ **Selecting Sounds [INST]** (p. 24))

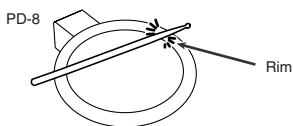

You can also trigger cross stick sounds on the PD-8 more easily **by playing just the rim strongly**.

## Cymbal Bow Shots/Edge Shots

Bow shots produce the sound assigned to the head and edge shots produce the sound assigned to the rim.

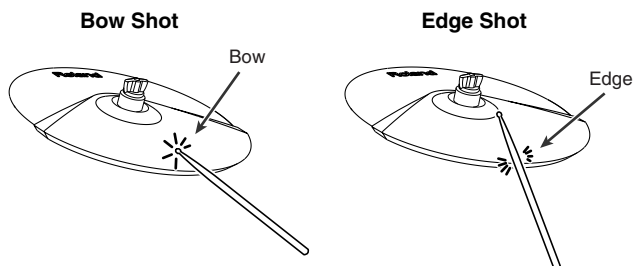

**TIP** With “rd1” or “rd4” selected for the RIDE bow (head) instrument, you can switch between the bow shot sound or the bell shot sound according your playing velocity (how hard you hit). (→ **Selecting Sounds [INST]** (p. 24))

## Cymbal Choke

Squeezing the rim portion of the pad, just after hitting it, allows you to mute or choke the sound. This technique is known as **choking**.

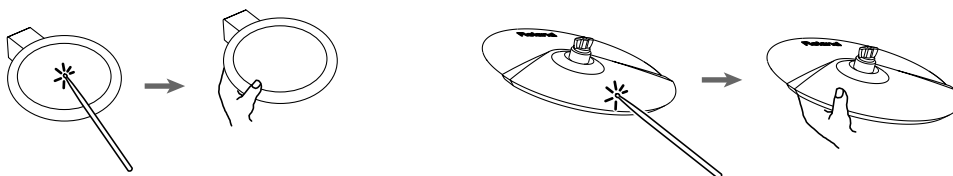

## Hi-Hat Control Pedal

Using a hi-hat control pedal (FD-8; FD-7, or FD-6), you can control the opening and closing of the hi-hat sound.

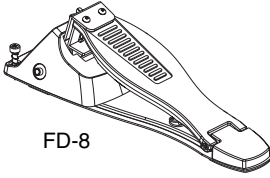

FD-8

**Open Hi-Hat:**

Strike the hi-hat without pressing the pedal

**Half Open Hi-Hat:**

Strike the hi-hat with the pedal pressed half-way

**Closed Hi-Hat:**

Strike the hi-hat with the pedal pressed

**Foot Closed:**

Completely press down the pedal

**TIP**

The volume of The Foot Closed sound can be adjusted separately. (p. 42).

**NOTE**

- Connect the hi-hat control pedal to the TD-3 before turning on the power.
- Do NOT press the pedal when turning on the power.

# Creating Your Own Drum Kit

## Drum Kits

KIT settings include sounds assigned to pads/rims, individual level, pan, Ambience Type and MIDI Note #.

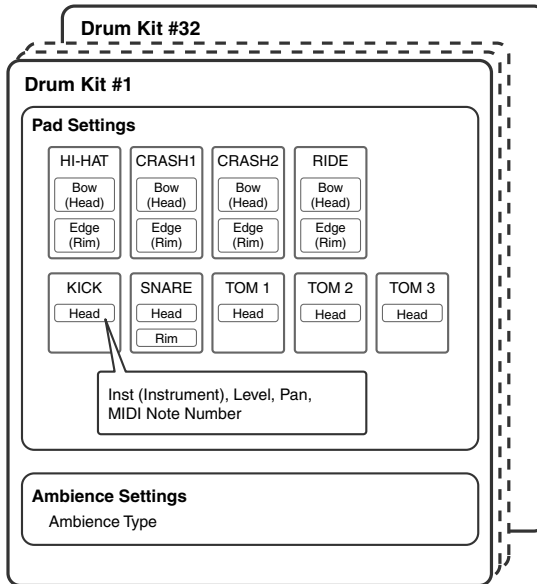

- There are 32 drum kits.
- You can modify them as you like.

**TIP** Restoring drum kits to their original factory settings is always possible. Refer to “Copying a Drum Kit [KIT COPY]” (p. 27).

## Choosing a Drum Kit [DRUM KIT]

When you change a drum kit, settings for each pad, ambience, etc. are also changed.

**MEMO** The original “Drum Kit List” can be found on p. 68.

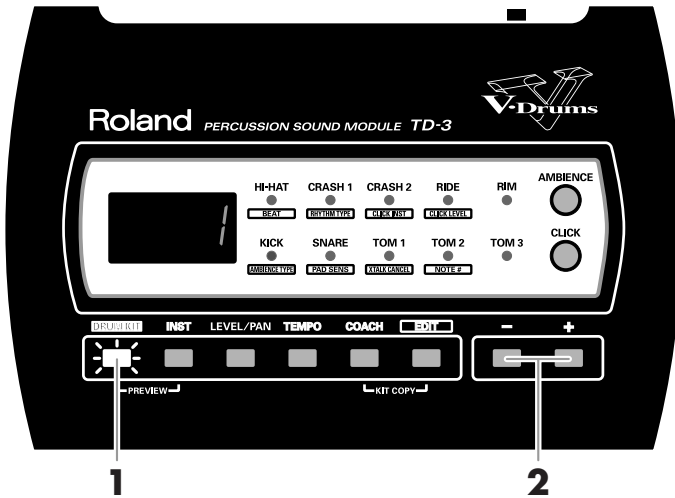

1. Press [DRUM KIT].  
[DRUM KIT] is lit and the drum kit number appears.
  2. Press [+] or [-] to select a kit.  
When holding down [+] and pressing [-] values increase rapidly.  
When holding down [-] and pressing [+] values decrease rapidly.
- DRUM KIT NUMBER:** 1–32

## Selecting Sounds [INST]

How to assign instruments (sounds) to individual pads or pedals.

When using rim/edge-capable pads, select the sounds separately by hitting either the head (bow if a Cymbal pad) or rim (edge if a Cymbal pad).

**MEMO** To see the available instruments, refer to “Drum Instrument List” (p. 69).

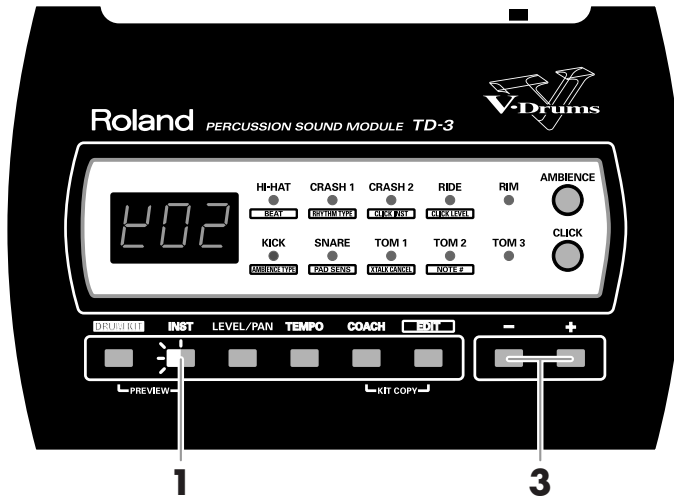

1. Press [INST].  
[INST] flashes.
2. Hit the pad you wish to set.  
The trigger indicator for the struck pad lights, and the instrument number appears.  
When the rim (edge) is struck, the rim indicator lights up.
3. Press [+] or [-] to select the instrument.  
When holding down [+] and pressing [-] values increase rapidly.  
When holding down [-] and pressing [+] values decrease rapidly.
4. Repeat Steps 2 and 3 to make the settings for other pads or pedals.
5. When you're finished, press [DRUM KIT]; the [INST] light goes off.

**NOTE** Do not turn off the power without the [INST] light having gone out. Otherwise you will lose the changes you have just made.



## Instrument Volume & Pan [LEVEL/PAN]

Every sound in the kit assigned to a pad or pedal has individual level (volume) and pan (position) controls. When using rim- and edge-capable pads, you can adjust the level for the head (or bow) and rim (or edge) individually.

Pan position for the head (bow) and rim (edge) are the same however.

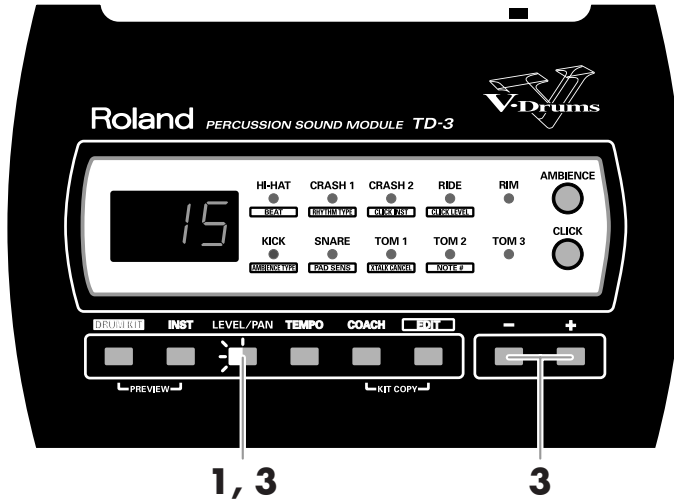

1. Press [LEVEL/PAN].  
[LEVEL/PAN] flashes.
2. Hit the pad you wish to set.  
The trigger indicator for the struck pad lights up, and the level or pan value appears in the display. When the rim (edge) is struck, the rim indicator lights up.
3. Press [LEVEL/PAN] and [+] or [-] to set the level or pan.  
The level and pan values alternate in the display each time [LEVEL/PAN] is pressed.

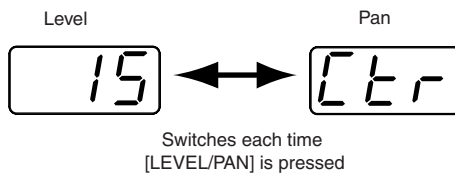

When holding down [+] and pressing [-] values increase rapidly.  
When holding down [-] and pressing [+] values decrease rapidly.  
(When using the above mentioned, “quick” mode, the pan value will stop once it reaches “Ctr.”)

**LEVEL:** 0–15

**PAN:** L15 (left)–Ctr (center)–r15 (right)

4. Repeat Steps **2** and **3** to make the settings for other pads or pedals.
5. When you’re finished, press [DRUM KIT]; the [LEVEL/PAN] light goes off.

**NOTE** Do not turn off the power without the [LEVEL/PAN] light having gone out. Otherwise you will lose the changes you have just made.

## Ambience Settings [AMBIENCE]

### Ambience (15 types)

A choice of Ambience or “room simulation” effects are available for each kit on an individual basis. The choices include different sized rooms or even a selection of “compressed” types.

## Switching Ambience On/Off

1. Press [AMBIENCE] to turn it on or off.  
If [AMBIENCE] is lit: the ambience on  
If [AMBIENCE] is unlit: the ambience off

**NOTE** Ambience On/Off settings can NOT be saved for individual drum kits.

**MEMO** If you want the Ambience on or off each time the power is turned on, press [DRUM KIT] while the Ambience is on or when off.

## Selecting the Ambience Type

The TD-3 provides 15 different pre-programmed Ambience settings. They are applied equally to all sounds in the kit.

**MEMO** Ambience is also applied to the click (metronome) sound.

1. Press [EDIT].  
[EDIT] flashes.
2. Press [EDIT] a few times until the AMBIENCE indicator is lit.  
The ambience type number appears.

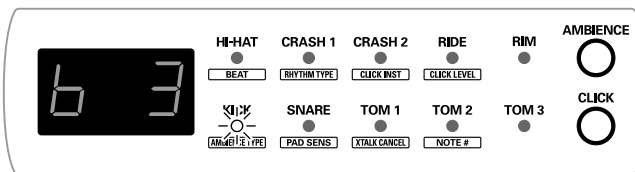

**TIP** Hold down [EDIT] and press [-] to have the indicators light in the reverse order of that when only [EDIT] is pressed.

3. Press [+] or [-] to select the ambience type.

Type	Description	
n 1, n 2, n 3	Natural room reverberation.	As the number increases the room size changes, making the effect more obvious.
b 1, b 2, b 3	Light, airy reverberation.	
d 1, d 2, d 3	Warm and mellow reverberation.	
c 1, c 2, c 3	Boosted attack gives the sound greater punch. Warm reverberation is also added.	More compression is applied as the number increases, giving the sound greater “punch.”
C 1, C 2, C 3	Boosted attack gives the sound greater punch. Shallow room reverberation is also added.	

4. When you’re finished, press [DRUM KIT]; the [EDIT] light goes off.

**NOTE** Do not turn off the power without the [EDIT] light having gone out. Otherwise you will lose the changes you have just made.

## Copying a Drum Kit [KIT COPY]

All elements of a Kit can be copied: instrument, level, pan, ambience, etc.

**NOTE** This operation will delete all settings in the currently selected drum kit. Double check before executing this function.

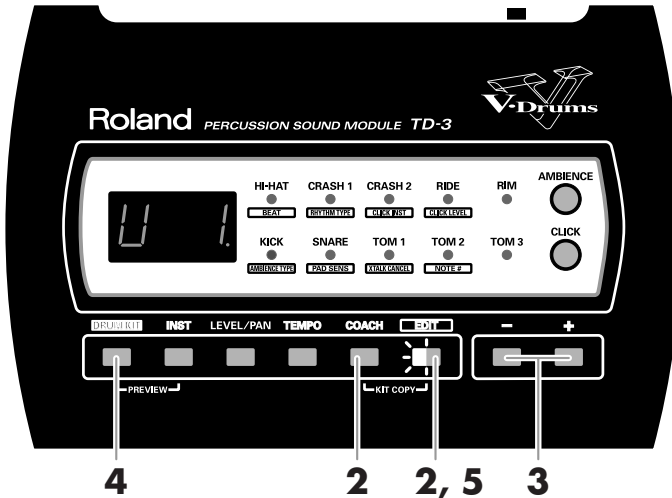

1. Select a drum kit.  
This kit becomes the copy “destination.”
2. Hold down [COACH] and press [EDIT].  
“CPy” appears and [EDIT] flashes rapidly, the kit you select here will be the copy “source.”
3. Press [+] or [-] to select the copy-source drum kit.  
When holding down [+] and pressing [-] values increase rapidly.  
When holding down [-] and pressing [+] values decrease rapidly.  
(Settings values stop changing once “P1” is reached.)

**U 1–U32:** Drum Kits

**P 1–P32:** Factory Setting Drum Kits

**MEMO** You can play the pads to hear the sounds of the copy source kit.

**MEMO** A dot (“.”) after the drum kit number lights up if you select the copy destination as the copy source.

**TIP** Drum kit marked with “P” as the copy source (P01–P32) will restore original factory drum kits.

4. Press [DRUM KIT] to cancel the operation.
5. Hold down [EDIT] to execute the copy.  
When the copy is completed, [DRUM KIT] lights up, and the drum kit number returns to the display.

# Playing with the Metronome (Click)

## Starting and Stopping the Metronome On/Off [CLICK]

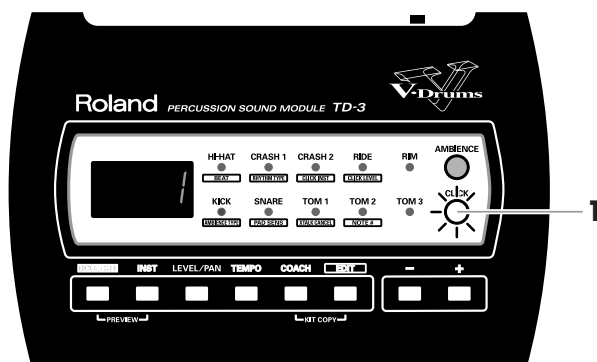

1. Press [CLICK] to turn ON and OFF. [CLICK] lights, and the click sound begins to play.

## Tempo Adjustment [TEMPO]

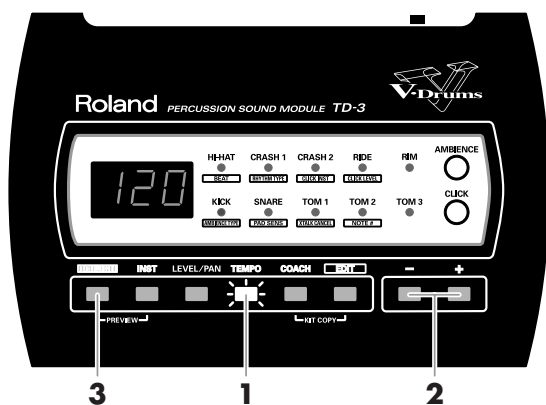

1. Press [TEMPO].
2. Press [+] or [-] to raise or lower the tempo by one BPM (Beats Per Minute).  
When holding down [+] and pressing [-] values increase a step from the current tempo setting.  
When holding down [-] and pressing [+] values decrease a step from the current tempo setting.  
**TEMPO:** 20–260
3. When you're finished, press [DRUM KIT] to return the drum kit number to the display.

**NOTE** Do not turn off the power without returning to the drum kit number display. Otherwise you will lose the changes you have just made.

## Setting the Time Signature [BEAT]

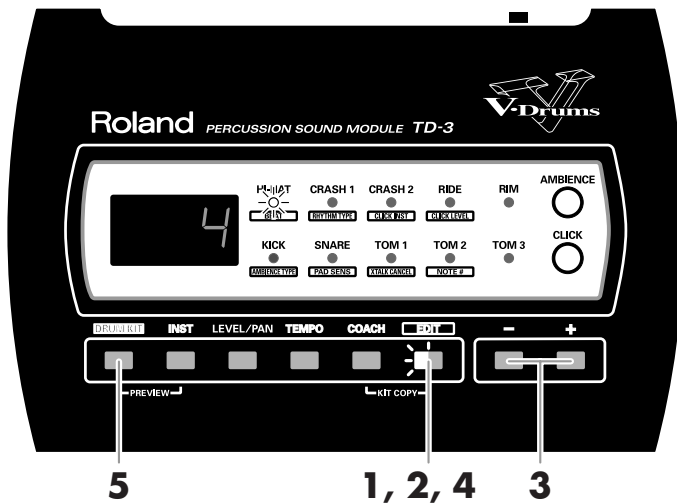

1. Press [EDIT].  
[EDIT] flashes.
2. Press [EDIT] a few times until the BEAT indicator is lit.
 

**TIP** Hold down [EDIT] and press [-] to have the indicators light in the reverse order of that when only [EDIT] is pressed.
3. Press [+] or [-] to change the time signature of the metronome.

Display	Description
□ - 7	Time signature possibilities: From 1/4 to 7/4. The first beat of each measure is accented. The "0" setting means no time signature and no beat is accented.

\* If you want to hear the metronome sound, press [CLICK].

4. Press [EDIT] to continue editing other settings.
5. When you're finished, press [DRUM KIT] to display the drum kit number.

**NOTE** Do not turn off the power without returning to the drum kit number display. Otherwise you will lose the changes you have just made.

## Selecting a Rhythm Type [RHYTHM TYPE]

1. Press [EDIT].  
[EDIT] flashes.
2. Press [EDIT] a few times until the RHYTHM TYPE indicator is lit.

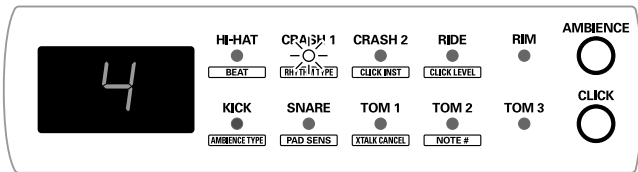

Hold down [EDIT] and press [-] to have the indicators light in the reverse order of that when only [EDIT] is pressed.

3. Press [+] or [-] to select the type of rhythm the click plays.

Display	Description	Display	Description
1	Counts at the top of the measure.	2	♩ (half note)
4	♪ (quarter note)	8	♪♪ (8th note)
8 <sup>o</sup>	♪♪ (8th note)	3	♪♪♪ (8th-note triplet)
3 <sup>o</sup>	♪♪♪ (8th-note triplet)	16	♪♪♪♪ (16th note)
16 <sup>o</sup>	♪♪♪♪ (16th note)	16 <sup>o</sup>	♪♪♪♪ (16th note)
5	♪♪♪♪♪ (16th-note quintuplet)	6	♪♪♪♪♪ (16th-note triplets)
7	♪♪♪♪♪♪ (16th-note heptuplet)		
c 3 2	3-2 son clave 	c 2 3	2-3 son clave 
r 3 2	3-2 rumba clave 	r 2 3	2-3 rumba clave 

\* If you want to hear the metronome sound, press [CLICK].

4. Press [EDIT] to continue editing other settings.
5. When you're finished, press [DRUM KIT] to display the drum kit number.

### NOTE

Do not turn off the power without returning to the drum kit number display. Otherwise you will lose the changes you have just made.

## What are Claves?

The standard clave pattern, which is the base of most Latin rhythms features a basic beat that is played over two measures in 2/2 time.

There are four types of Cuban clave rhythms: 3-2 son clave, 2-3 son clave, 3-2 rumba clave, and 2-3 rumba clave.

“Clave” is Spanish for “pivotal or key point.” Originally, any instrument used to beat out the critical notes fundamental to a piece of music was referred to as “clave,” and “claves” came to refer to the most basic rhythms played with these instruments.

**NOTE** When selecting claves for the rhythm type, set the rhythm (p. 29) to “4” (4/4 time signature; 2/2 time is shown in the score).

## Selecting the Click Sound [CLICK INST]

1. Press [EDIT].  
[EDIT] flashes.
2. Press [EDIT] a few times until the CLICK INST indicator is lit.

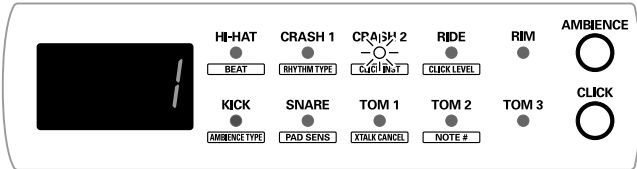

Hold down [EDIT] and press [-] to have the indicators light in the reverse order of that when only [EDIT] is pressed.

3. Press [+] or [-] to choose the sound for the metronome click.

No.	Instruments	Description
1	Metronome	Standard swinging metronome
2	Beep	Electronic beep
3	Electric	Simple electronic metronome
4	Sweep	Electronic sound that is easy to catch, even in loud environments such as when practicing live drums.
5	Zap	Electronic sound, optimal for practicing for extended periods
6	Pulse	Tight, crisp sound with no reverberation or echoes.
7	Cowbell	Adds longer echoes to the sound; also suitable for slow-tempo songs.
8	Claves	Use when practicing rumba, salsa, and other Latin rhythms with Claves selected as the Rhythm Type (p. 30).
9	Sticks	Plain, natural stick sound
10	Voice	Count using vocal and stick sounds

\* If you want to hear the metronome sound, press [CLICK].

4. Press [EDIT] to continue editing other settings.
5. When you're finished, press [DRUM KIT] to display the drum kit number.

**NOTE** Do not turn off the power without returning to the drum kit number display. Otherwise you will lose the changes you have just made.

### NOTE

- The click sound may cut out at certain tempos or with certain rhythm types.
- If "Voice" is selected and the rhythm type is set to "c32," "c23," "r32," or "r23," only the stick sound is played.



## Volume Adjustment [CLICK LEVEL]

1. Press [EDIT].  
[EDIT] flashes.
2. Press [EDIT] a few times until the CLICK LEVEL indicator is lit.

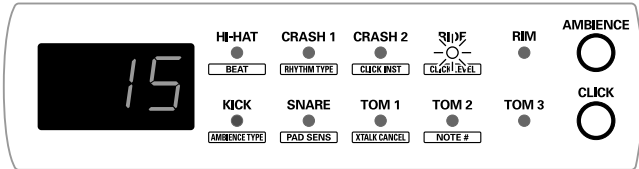

**TIP** Hold down [EDIT] and press [-] to have the indicators light in the reverse order of that when only [EDIT] is pressed.

3. Press [+] or [-] to adjust the volume of the click sound.  
**CLICK LEVEL:** 0–15  
\* *If you want to hear the metronome sound, press [CLICK].*
4. Press [EDIT] to continue editing other settings.
5. When you're finished, press [DRUM KIT] to display the drum kit number.

**NOTE** Do not turn off the power without returning to the drum kit number display. Otherwise you will lose the changes you have just made.

# Playing with a CD, Tape, or MD (Via MIX IN Jack)

The TD-3's MIX IN jack allows you to play along with a variety of external audio sources.

1. Make connections as shown in the following figure.

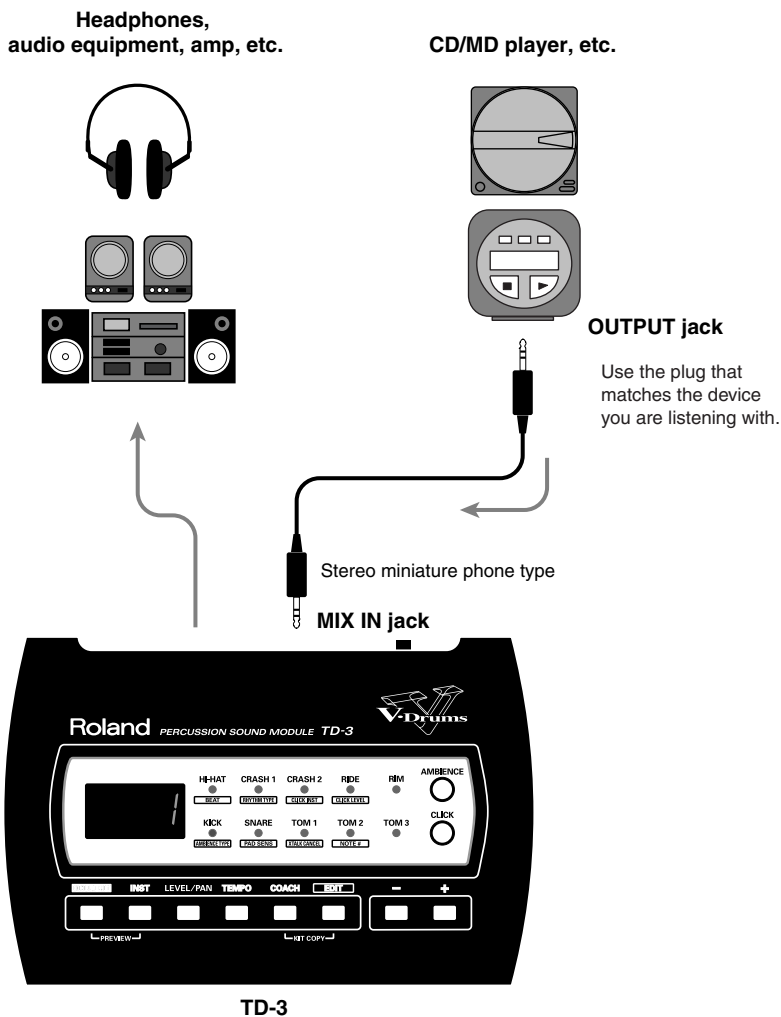

**NOTE** To prevent malfunction and/or damage to speakers or other devices, always turn down the volume, and turn off the power on all devices before making any connections.

2. When you begin playback of the audio source, the sound is output through the OUTPUT jacks and the PHONES jack of the TD-3.

**MEMO** Adjust the volume level of the playback device in balance with the drum kit, and then set your volume levels for headphones or monitor speakers.

3. Now you are ready to play drums along with what's coming through the MIX IN jack.

# COACH Mode

The TD-3's Coach mode is a unique set of exercises specifically designed to help build speed, accuracy and stamina, as well as develop better timing skills. Throughout the Coach modes, you will discover that some of them have programmable parameters, allowing you to adapt the functions to your specific needs.

## Setting Procedure

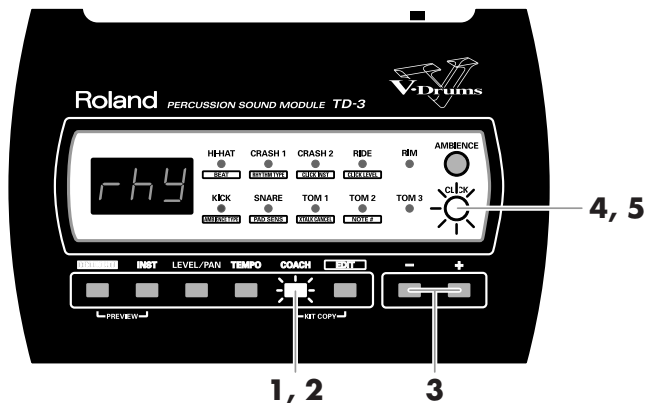

1. Press [COACH].
2. Press [COACH] a few times to select the parameter.

Display	Parameter	Practice Content	Page
<i>rhy</i>	Rhythmic Notes	Accuracy and Timing Exercise (4 types)	p. 36
<i>tch</i>	Time Check		
<i>qct</i>	Quiet Count		
<i>spd</i>	Speed Check		
<i>gud</i>	Gradual Up/Down	Endurance and Stamina Exercise (2 types)	p. 38
<i>sud</i>	Step Up/Down		
<i>cnt</i>	Count In	Adding Finishing Touches to What You Have Practiced	p. 39

**TIP** You can hold down [COACH] and press [-] to select parameters in the reverse order of that when only [COACH] is pressed.

3. Press [+] or [-] to select the variation.
4. Press [CLICK] to begin the exercise.
5. To finish the exercise, press [CLICK] again.

**NOTE** Selecting the Coach mode while the Metronome is working stops the metronome.

**MEMO** In Coach mode, you can press [TEMPO] to change the tempo before pressing [CLICK] to start the exercise. Adjust the tempo using [+] or [-].

## Accuracy and Timing Exercises

### Warm Up (Rhythmic Notes)

Rhythmic Notes is an excellent warm up exercise as well as a good method for learning rhythmic note values. After a two measure count-in, the metronome plays through a series of note intervals or beat divisions. Each one is played for 2 measures before moving on to the next interval level. The exercise starts with half notes, stepping up through intervals to 16th-note triplets, and then back down to half notes again.

1. In the Coach mode, press [COACH] until " r h y " is displayed.
2. Press [+] or [-] to select the variation.

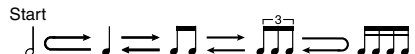
P-5 :  (initial setting)

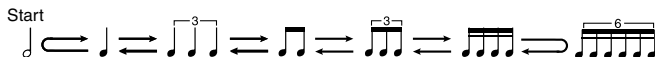
P-7 : 

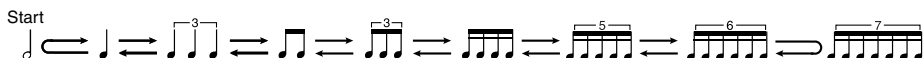
P-9 : 

3. Press [CLICK] to begin the exercise.
4. To finish the exercise, press [CLICK] again.

**MEMO** You can change tempo during the exercise using [+] or [-].

### Correctly Playing in Time with the Beat (Time Check)

Time Check mode is designed to develop good timing skills through visual use of the display. As you play along with the metronome, your performance is measured against the timing of the click, and the result is displayed.

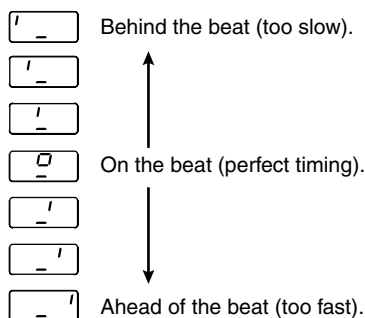

1. In the Coach mode, press [COACH] until " t c h " is displayed.
2. Press [+] or [-] to select the level.  
 E S y : Checks performance using relatively easier timing. (initial setting)  
 H r d : Checks performance using more exact timing.

\* Not possible with Hi-Hat controller, Foot Closed timing.

3. Press [CLICK] to start the exercise.
4. To stop the exercise, press [CLICK] again.

**MEMO** You can change tempo during the exercise by pressing [+] or [-].

## Quiet Count—Developing Internal Timing Sense

Quiet Count mode is designed to develop your internal tempo “clock.” The click will play at a fixed volume level for a cycle of 1, 2, 3, 4, 6, or 8 measures, and will play the equal amount or 1 or 2 measures (see below) at a level that is barely audible. This cycle repeats until you press [CLICK] to stop it.

1. In the Coach mode, press [COACH] until “ $\text{9}\text{C}\text{E}$ ” is displayed.
2. Press [+] or [-] to select the variation.
 

$\text{1}\text{-}\text{1}$ : 1 measure cycle	$\text{1}\text{E}\text{1}$ : 3 (with) plus 1 (quiet) measure cycle
$\text{1}\text{-}\text{2}$ : 2 measure cycle	$\text{1}\text{E}\text{2}$ : 6 (with) plus 2 (quiet) measure cycle
$\text{1}\text{-}\text{4}$ : 4 measure cycle (initial setting)	
$\text{1}\text{-}\text{8}$ : 8 measure cycle	
3. Press [CLICK] to start the exercise.
4. To stop the exercise, press [CLICK] again.

**MEMO** You can change tempo during the exercise using [+] or [-].

## Speed Check—8 Measure Timing Accuracy Challenge

Speed Check mode is very similar to the Time Check mode (p. 36) except here you must play 8 measures in time with the metronome. If you do this correctly, then the tempo will advance 5 beats per minute. This will continue until the click’s maximum tempo is achieved.

1. In the Coach mode, press [COACH] until “ $\text{5P}\text{d}$ ” is displayed.
2. Press [+] or [-] to select the level.
 

$\text{E}\text{S}\text{y}$ : Checks performance using relatively easier timing. (initial setting)
$\text{H}\text{r}\text{d}$ : Checks performance using more exact timing.

*\* Not possible with Hi-Hat controller, Foot Closed timing.*
3. Once [CLICK] is pressed, there will be a two measure count in before Speed Check begins. The beats played on the pad are measured against the timing of the click, and the result is displayed.

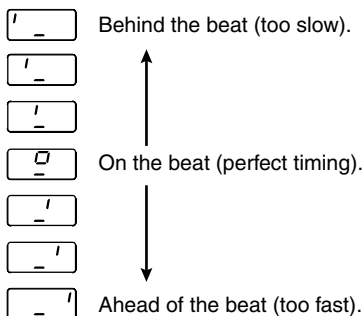

When you play correctly, the display will flash the next tempo (+5 BPM).  
If you don’t, then the display flashes the current tempo twice.

*\* The maximum tempo of the TD-3’s metronome is 260.*

4. To stop the exercise, press [CLICK] again.
 

**MEMO** Press [+] or [-] to display the current tempo.

### What is BPM?

BPM is an abbreviation for “Beats Per Minute” (number of quarter-note beats in a one-minute period). Also means “tempo.”

## Endurance and Stamina Exercises

### Gradual Up/Down—Tempo Increase/Decrease Exercise

Gradual Up/Down mode is designed to increase playing stamina by slowly increasing and then decreasing the speed of the click. In this mode, the click's tempo will increase by one beat per minute (1 BPM) after every two beats (or one beat) until it reaches the click's maximum tempo. After the maximum tempo is achieved, the click's tempo will decrease by one beat per minute (1 BPM) after every two beats (or one beat). This will continue until it reaches back to the click's starting tempo and then repeat the process.

1. In the Coach mode, press [COACH] until "  $\text{GUD}$  " is displayed.
2. Press [+] or [-] to select the variation.  
 $b-1$  : The tempo will increase and/or decrease by 1 BPM for every one beat.  
 $b-2$  : The tempo will increase and/or decrease by 1 BPM for every two beats. (initial setting)
3. Press [CLICK] to start the exercise.
4. When you're finished, press [CLICK] again.



After starting the click, you can set the desired maximum tempo by pressing [-] when it reaches the desired tempo. To clear the maximum tempo, press [+] (initial value: 260).

### Step Up/Down—Tempo Increase/Decrease in Steps

Step Up/Down mode is similar to Gradual Up/Down, also good for developing endurance and speed. The metronome will play for eight measures and then increase the tempo in steps (you select) until it reaches the maximum tempo. Then it will decrease in tempo in the same manner until it reaches the original starting tempo.

1. In the Coach mode, press [COACH] until "  $\text{SUD}$  " is displayed.
2. Press [+] or [-] to select the variation.  
 $t-2$  : The tempo will increase and/or decrease by 2 BPM for every eight measures. (initial setting)  
 $t-5$  : The tempo will increase and/or decrease by 5 BPM for every eight measures.  
 $\square t r$  : After each eight measures, the tempo will increase and/or decrease relative to the current tempo.
3. Press [CLICK] to begin the exercise.
4. To finish the exercise, press [CLICK] again.



After starting the click, you can set the desired maximum tempo by pressing [-] when it reaches the desired tempo. To clear the maximum tempo, press [+] (initial value: 260).

# Voice "Count In" / Visual Measure Counter

## Count In and Measure Counter

The Coach mode features a "voice count-in" function that can be very useful for practicing or even in a live situation.

There is also a visual measure counter in the display of the TD-3 (1–999 measures).

The options are explained below.

1. In the Coach mode, press [COACH] until "  $\square$   $\square$   $\square$  " is displayed.
2. Press [+] or [-] to select the variation.  
OFF: The click sound stops playing after the count is finished.  
ON: The click continues playing after the count (using the tone set as the click instrument). (initial setting)
3. Press [CLICK] to start the exercise.
4. When you're finished, press [CLICK] again.

**MEMO** The voice setting is always used for the Coach count, regardless of the click's tone setting.

**MEMO** You can change tempo during the exercise using [+] or [-].

# Pad Adjustments

## Adjusting Pad Sensitivity [PAD SENS]

You can adjust the sensitivity of the pads to accommodate your personal playing style. This allows you to have more dynamic control over the sound volume, based on how hard you play.

**TIP** Sensitivity settings are automatically set to the most efficient values for each pad when you select the trigger type (p. 50). Adjust as needed.

1. Press [EDIT].  
[EDIT] flashes.
2. Press [EDIT] a few times until the PAD SENS indicator is lit.  
The PAD SENS value is displayed.

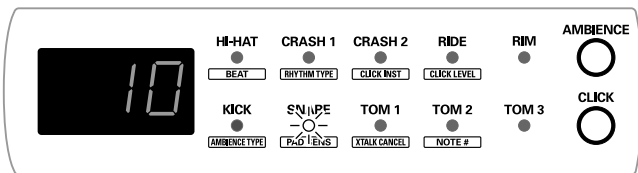

**TIP** Hold down [EDIT] and press [-] to have the indicators light in the reverse order of that when only [EDIT] is pressed.

3. Hit the pad you wish to set.  
The trigger indicator for the struck pad lights momentarily.
4. Press [+] or [-] to adjust the sensitivity of the pads.  
Higher sensitivity allows the pad to produce a loud volume even when played softly.  
Lower sensitivity will keep the pad producing a low volume even when played forcefully.  
Set the velocity at a value of 127 when you strike the pad most forcefully.

**PAD SENS:** 1–16

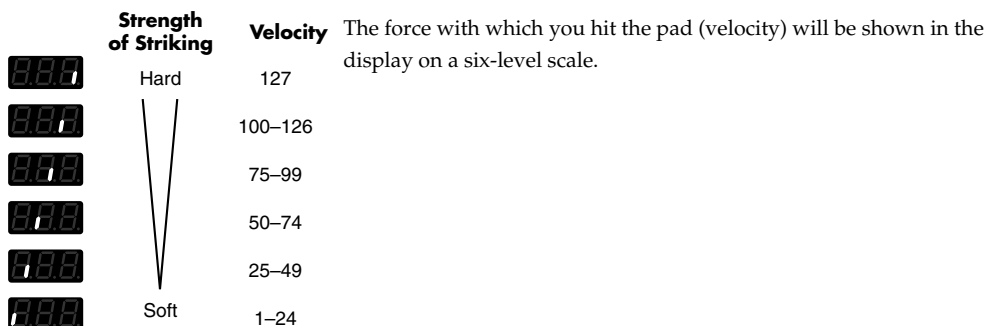

5. Repeat Steps 3 and 4 to make any other necessary pad sensitivity adjustments.
6. Press [EDIT] to continue editing other settings.
7. When you're finished, press [DRUM KIT]; the [EDIT] light goes off.

**NOTE** Do not turn off the power without the [EDIT] light having gone out. Otherwise you will lose the changes you have just made.



## Eliminate Crosstalk Between Pads [XTALK CANCEL]

When two pads are mounted on the same stand, hitting one pad may trigger the sound from another pad unintentionally (This is called **crosstalk**.) Eliminate this by adjusting Crosstalk Cancel on the pad that is sounding inadvertently.

**TIP** In some cases, you can prevent crosstalk between two pads by increasing the distance between them.

**NOTE** You cannot prevent crosstalk from pads connected to other drum sound modules. In that case, mount them far apart or on different stands.

1. Press [EDIT].  
[EDIT] flashes.
2. Press [EDIT] a few times until the XTALK CANCEL indicator is lit.  
The XTALK CANCEL value is displayed.

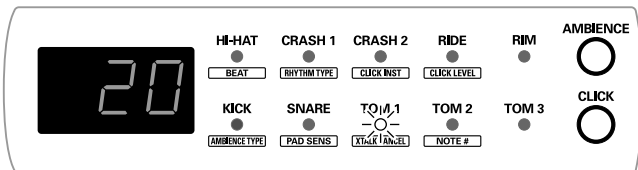

**TIP** Hold down [EDIT] and press [-] to have the indicators light in the reverse order of that when only [EDIT] is pressed.

3. Hit the pad you wish to set.  
The trigger indicator for the struck pad lights momentarily.  
**Crosstalk Example: If you hit the snare pad and the hi-hat cymbal also sounds**  
Raise the "Xtalk Cancel (Crosstalk Cancel)" for the pad being used for the hi-hat. The hi-hat cymbal pad will be less prone to receive crosstalk from other pads.
4. Press [+] or [-] to adjust the value.  
If the value is set too high, and two pads are played simultaneously, the one that is struck less forcefully may not sound. Be careful and set this parameter to the minimum value required to prevent crosstalk.  
With a setting of "OFF," crosstalk prevention will not work.  
**XTALK CANCEL:** OFF, 20, 25, 30, 35, 40, 45, 50, 55, 60, 65, 70, 75, 80
5. Hit the pad to check the setting.
6. Repeat Steps 3–5 until the crosstalk is eliminated.
7. Press [EDIT] to continue editing other settings.
8. When you're finished, press [DRUM KIT]; the [EDIT] light goes off.

**NOTE** Do not turn off the power without the [EDIT] light having gone out. Otherwise you will lose the changes you have just made.

**TIP** If you want to make more detailed pad settings, refer to "Pad and Trigger Settings" (p. 50).

# Hi-Hat Control Pedal Adjustment

## Adjusting the Hi-Hat's Foot Closed Level

The volume of the sound played when pressing the hi-hat control pedal can be adjusted.

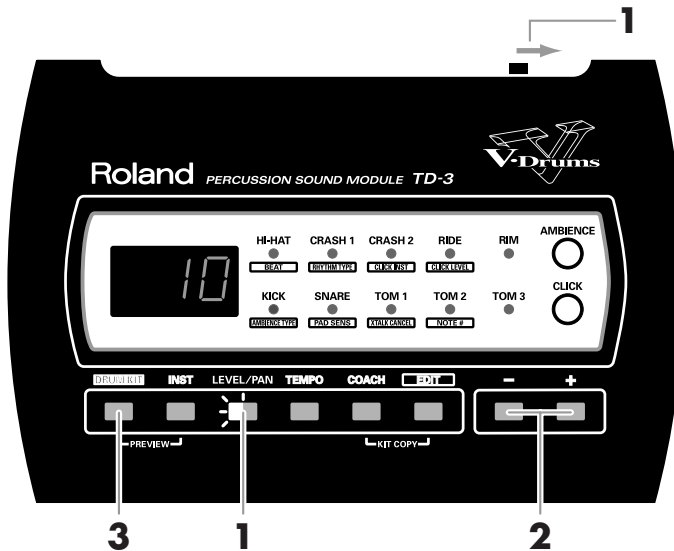

1. Be sure the POWER is OFF, then hold down [LEVEL/PAN] and turn on the power. "Pedal Modify" appears in the scroll display, then the Foot Closed level is indicated, and [LEVEL/PAN] flashes.
2. Press [+] or [-] to adjust the Foot Closed level.  
**Value:** 0–15  
(initial value: 10)

**TIP** When adjusting the OVERALL hi-hat volume, follow the instructions in "Instrument Volume & Pan [LEVEL/PAN]" (p. 25).

3. When you're finished, press [DRUM KIT]; the [LEVEL/PAN] light goes off.

**NOTE** Do not turn off the power without the [LEVEL/PAN] light having gone out. Otherwise you will lose the changes you have just made.

# Factory Reset

## (Restoring the Factory Settings)

This restores the TD-3 to the original factory settings.  
Power must be OFF before starting this process.

**NOTE** This will erase all changes made to the TD-3's settings. To save this data, use the "Bulk Dump" operation to save to an external MIDI device. (→ p. 62)

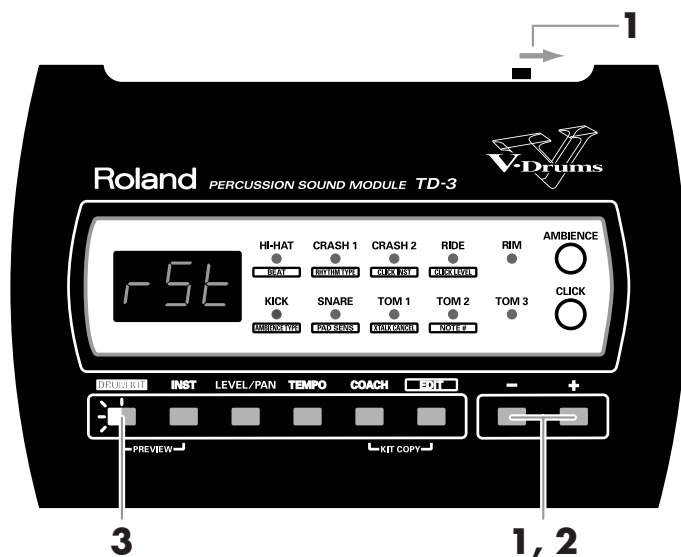

1. While holding down [+] and [-], turn on the power.  
The following information is indicated in the display, and [DRUM KIT] flashes rapidly.

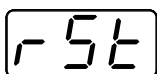

\* To cancel the Factory Reset, turn off the power.

2. Press [+] or [-] to select the settings to be restored.  
r5t : Complete factory reset.  
t, t : Restores only the drum kit settings.
3. Hold down [DRUM KIT] to execute Factory Reset.

**NOTE** Do NOT turn off the power during the Factory Reset Process. This could damage the TD-3's internal memory.



## Combinations of Pad and Trigger Input

To enjoy the maximum potential of the TD-3 and your pads, be sure to review the following chart, selecting pads best suited for your needs.

			Trigger Input Jack								
			KICK	SNARE	TOM 1	TOM 2	TOM 3	HI-HAT	CRASH1	CRASH2	RIDE
Kick Trigger	KD-7	Head	○	○	○	○	○	○	○	○	○
	KD-8	Head	○	○	○	○	○	○	○	○	○
	KD-80	Head	○	○	○	○	○	○	○	○	○
	KD-85	Head	○	○	○	○	○	○	○	○	○
	KD-120	Head	○	○	○	○	○	○	○	○	○
Pad	PD-6	Head	○	○	○	○	○	○	○	○	○
	PD-7 PD-9	Head	○	○	○	○	○	○	○	○	○
		Rim, Choke	/	○	/	/	/	○	○	○	○
	PD-8	Head	○	○	○	○	○	○	○	○	○
		Rim, Choke	/	○	/	/	/	○	○	○	○
	PD-80	Head	○	○	○	○	○	○	○	○	○
	PD-80R	Head	○	○	○	○	○	○	○	○	○
	PD-85	Rim	/	○	/	/	/	X	X	X	X
	PD-100	Head	○	○	○	○	○	○	○	○	○
	PD-105	Head	○	○	○	○	○	○	○	○	○
		Rim	/	○	/	/	/	X	X	X	X
	PD-120	Head	○	○	○	○	○	○	○	○	○
PD-125	Rim	/	○	/	/	/	⊗	⊗	⊗	⊗	
Cymbal	CY-6	Head (Bow)									
		Rim (Edge), Choke	/	○	/	/	/	○	○	○	○
	CY-8	Head (Bow)		○				○	○	○	○
		Rim (Edge), Choke	/	○	/	/	/	○	○	○	○
	CY-12H	Head (Bow)		○				○	○	○	○
		Rim (Edge), Choke	/	○	/	/	/	○	○	○	○
	CY-14C	Head (Bow)		○				○	○	○	○
		Rim (Edge), Choke	/	○	/	/	/	○	○	○	○
	CY-12R/C CY-15R *1	Head (Bow)		○				○	○	○	○
		Rim (Edge/Bell), Choke	/		/	/	/				

○: Can be used.

X: Cannot be used.

Slash: These trigger inputs do not handle rim trigger signals.

\*1: With the CY-12R/C and CY-15R, you can choke and play either edge shots or bell shots.

See p. 47 or refer to the CY-12R/C or CY-15R Owner's Manual.

## Playing the Pads

### Head Shots and Rim Shots

To play a head shot, hit only the head.

To play a rim shot, **hit both the head and the rim of the pad simultaneously.**

**With the following pads head and rim shots are available.**

PD-7, PD-8, PD-9, PD-80R, PD-85, PD-105, PD-120, PD-125:

**With the following pads only head shots are available.**

PD-6, PD-80, PD-100:

#### Head Shot

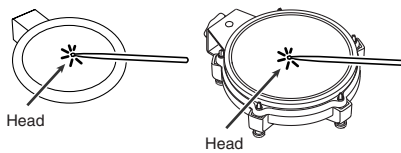

#### Rim Shot

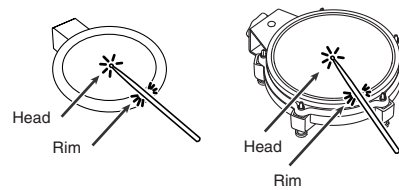

**MEMO** When using rim shots on the PD-80R, PD-85, PD-105, PD-120, or PD-125, connect the pad to the SNARE trigger input jack with a STEREO cable.

**TIP** Certain instrument names, for example: “S1” as the snare head instrument and “S1r” as the rim instrument are actually “matched” as it is the head and rim from the same drum.  
(→ **Selecting Sounds [INST]** (p. 24))

### Cross Stick on the Snare Pad

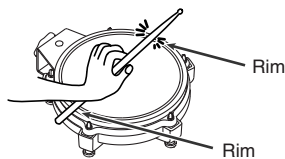

The cross stick sound is sometimes referred to as a “closed rim shot.”

When you perform a cross stick, the rim instrument is played.

When using the PD-80R, PD-85, PD-105, PD-120, or PD-125 to play the cross stick, be sure that you **only strike the rim (outer edge) of the pad.**

Placing your hand on the head (center area) of the pad might prevent the cross stick sound from being played properly.

**MEMO** To play cross stick on the PD-80R, PD-85, PD-105, PD-120, or PD-125, connect the pad with a Stereo cable to the SNARE trigger input jack.

**TIP** To play a cross stick sound, assign “S1r,” “S2r,” “S3r,” “S4r,” “S10,” or “S11” to the rim. By selecting either “S1r,” “S2r,” “S3r,” or “S4r” as the SNARE rim instrument, you can have either rim shot or cross stick sounds sound depending on your playing dynamics.  
(→ **Selecting Sounds [INST]** (p. 24))

## Cymbal Bow Shots/Edge Shots/Bell Shots

Bow shots produce the sound assigned to the head and edge shots produce the sound assigned to the rim.

The following pads can produce bow shots and edge shots.

CY-6, CY-8, CY-12H, CY-14C:

The following pads can produce bow shots and edge or bell shots.

CY-12R/C, CY-15R:

Bell shots are played by striking the bell somewhat strongly with the shoulder of the stick.

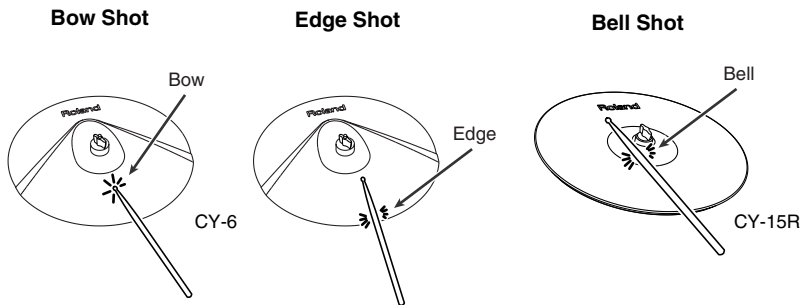

**MEMO** When playing edge shots with the CY-12R/C or CY-15R, use the BOW/EDGE output; for bell shots, use the BOW/BELL output.

**TIP** If making bell shots with the CY-12R/C or CY-15, select “rd2” or “rd5” as the bell instrument.

**TIP** With “rd1” or “rd4” selected for the RIDE bow (head) instrument, you can switch between the bow shot sound or the bell shot sound according your playing velocity (how hard you hit).  
(→ **Selecting Sounds [INST]** (p. 24))

## Cymbal Choke

Squeezing the rim portion of the pad, just after hitting it, allows you to mute or choke the sound.

This technique is known as **choking**.

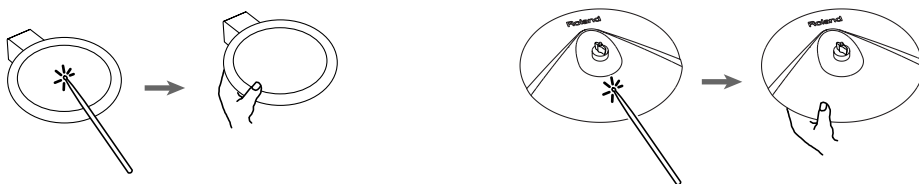

# Pad Configuration Possibilities

## Three Toms and Three Cymbals

TD-3Kit with a PD-85, CY-8 (+ 1 MDY-10U)

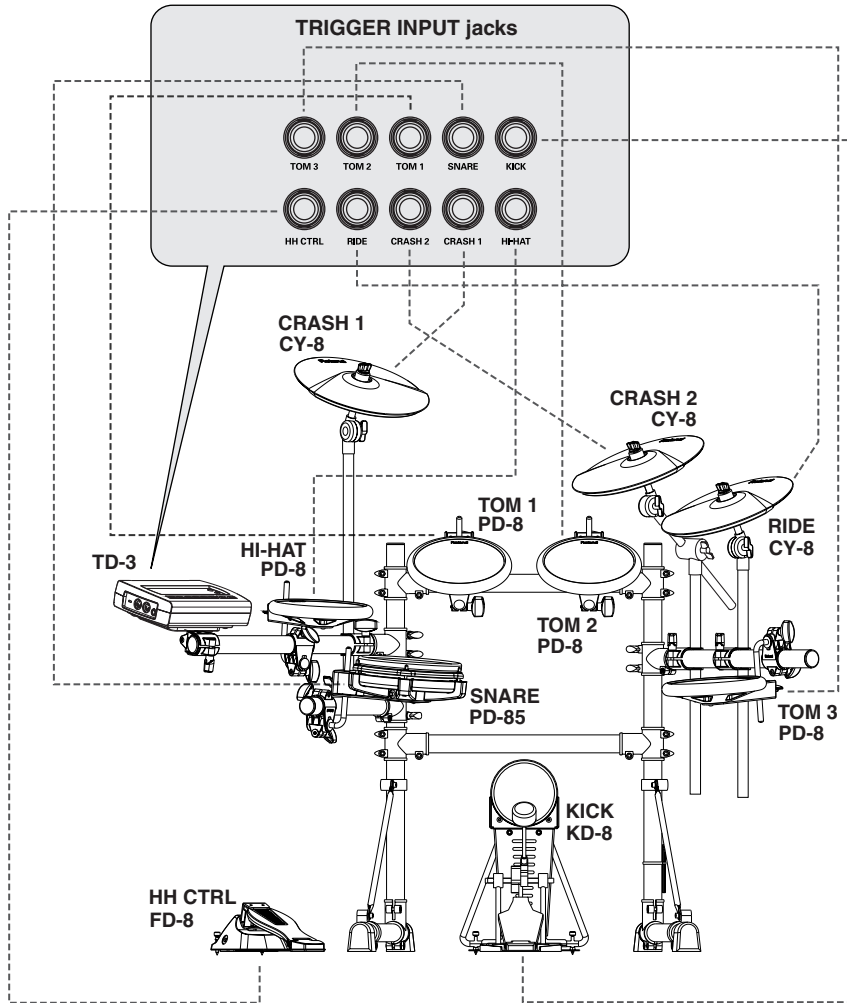

This setup shows a TD-3Kit with a PD-85, CY-8 (+ MDY-10U) added.

The PD-85 is for the snare, and PD-8 that had been used as the snare is now a tom.

\* Set the trigger type for trigger input SNARE to "B□r" (p. 50).



## Two Toms and Four Cymbals

TD-3Kit with two CY-8s (+ 2 MDY-10Us)

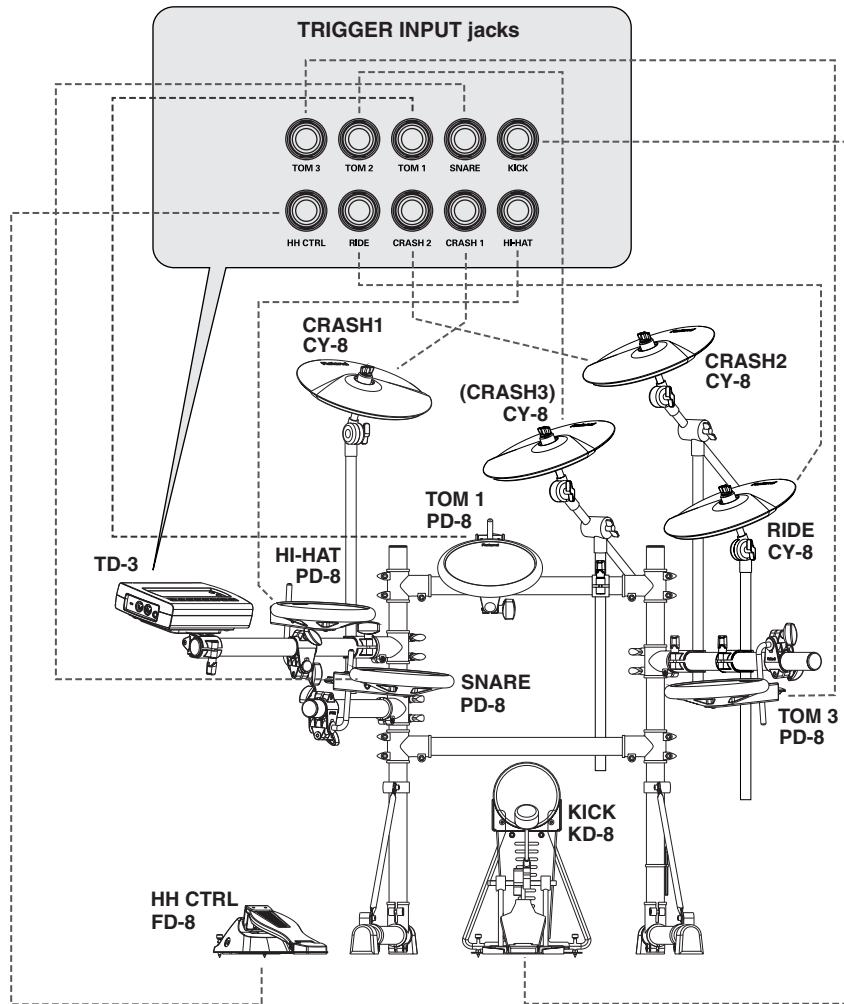

This setup shows a TD-3Kit with two CY-8s (+ 2 MDY-10Us) for a total of four cymbals.

Connecting the cymbal pads to the TOM 1–3 trigger input jacks allows four or more cymbals to be used.



You can use four toms by connecting a pad to the TOM 1–3 and/or CRASH 2/CRASH 1 trigger input jack.



Set the trigger type for each trigger input to match the pad or cymbal used (p. 50).

# Pad and Trigger Settings

You can make more advanced settings for the pads.

The **trigger parameters** (except the Xtalk Cancel) are automatically set to the most efficient values for each pad when you select the trigger type. Make settings for the parameters as needed.

The following is a list of the trigger parameters.

Parameter	Display	Page
Trigger Type	<i>LP</i>	p. 50
Pad Sensitivity	<i>55</i>	p. 52 (p. 40)
Threshold	<i>hr</i>	p. 53
Velocity Curve	<i>cr</i>	p. 54
Scan Time	<i>55</i>	p. 55
Retrigger Cancel	<i>rc</i>	p. 56
Crosstalk Cancel	<i>crs</i>	p. 57 (p. 41)
Mask Time	<i>ms</i>	p. 58
Rim Sensitivity	<i>rs</i>	p. 59
Rim Gain	<i>rg</i>	p. 59

## Selecting the Pad Type (Trigger Type)

To be sure the TD-3 accurately receives signals sent from the pads, select the **trigger type** (the type of pads being used).

Set each trigger input as described below.

**Settings optimized for the TD-3Kit are provided in factory settings on the TD-3.**

### What is the Trigger Type?

A trigger type is a group of trigger settings with values optimally adjusted for a particular pad. When you select a trigger type for a connected pad, each of the parameters is set to the most appropriate values for that pad, allowing you to play it without encountering problems with the settings. Only when factors unrelated to the selection of the proper trigger type prevent you from getting good results in performance should you fine-tune the individual parameters for the pad you are using.

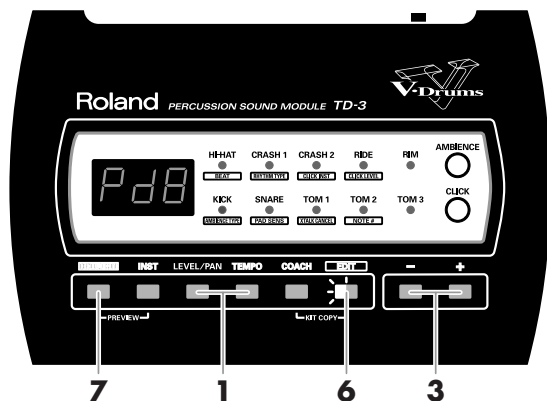

1. Hold down [LEVEL/PAN] and press [TEMPO].  
[EDIT] flashes.
2. Hit the pad you wish to set.  
The trigger indicator for the struck pad lights.
3. Press [+] or [-] to select the trigger type.

Pad	Value (Display)
PD-8	Pd8
PD-6, PD-7, PD-9	Pd
PD-80, PD-80R, PD-85	80r
PD-100, PD-105	105
PD-120, PD-125	125
KD-7, KD-8	Kd8
KD-80, KD-85, KD-120	Kd
CY-8	CY8
CY-6, CY-12R/C, CY-12H, CY-14C, CY-15R	CY
RT-7K	t7t
RT-5S	t55
RT-3T	t3t

\* The RT-7K, RT-5S, and RT-3T are Roland acoustic drum triggers.

4. Repeat Steps **2-3** to set the trigger type for each pad.  
**MEMO** This setting applies to both the head and rim.
5. Strike the pads and press the pedals to check the following.
  - Are sounds being played with all pads and pedals?
  - Is the right instrument for each pad being played?

If the correct sound is not being played, check the pad settings once more and refer to **“Troubleshooting”** (p. 65).

6. To make other settings, press [EDIT] to select another trigger parameter.
7. When you’re finished, press [DRUM KIT]; the [EDIT] light goes off.

**NOTE** Do not turn off the power without the [EDIT] light having gone out. Otherwise you will lose the changes you have just made.

**MEMO** The “Xtalk Cancel” (Crosstalk Cancel) value does not change when the trigger type is changed. Adjust this as necessary in accordance with the pad you are using and the playing conditions (p. 57).

## Adjusting Pad Sensitivity

You can adjust the sensitivity of the pads to accommodate your personal playing style. This allows you to have more dynamic control over the sound volume, based on how hard you play.

1. Hold down [LEVEL/PAN] and press [TEMPO].  
[EDIT] flashes.
2. Press [EDIT] a few times until " 505 " is displayed.  
" 505 " appears in the display, then the pad sensitivity value is indicated.
3. Hit the pad you wish to set.  
The trigger indicator for the struck pad lights.
4. Press [+] or [-] to adjust the sensitivity of the pads.

### Pad Sensitivity: 1-16

Higher sensitivity allows the pad to produce a loud volume even when played softly. Lower sensitivity will keep the pad producing a low volume even when played forcefully. The force with which you hit the pad (velocity) will be shown in the display on a six-level scale. Set the velocity at a value of 127 when you strike the pad most forcefully.

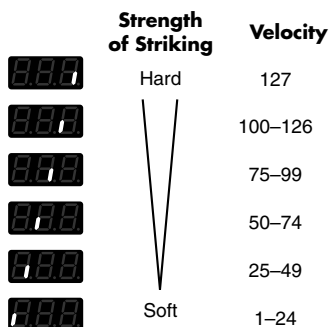

5. Press [EDIT] to continue editing other settings.
6. When you're finished, press [DRUM KIT]; the [EDIT] light goes off.

**NOTE** Do not turn off the power without the [EDIT] light having gone out. Otherwise you will lose the changes you have just made.

**MEMO** You can also make the settings using the procedure on p. 40.

## Setting the Minimum Levels for the Pads (Threshold)

This setting allows a trigger signal to be received only when the pad is above a determined force level (velocity). This can be used to prevent a pad from sounding because of vibrations from other pads. In the following example, B will sound but A and C will not sound.

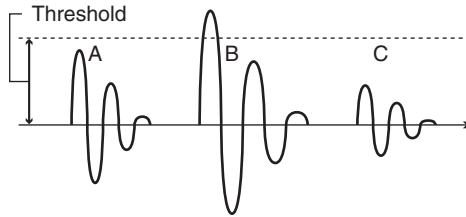

1. Hold down [LEVEL/PAN] and press [TEMPO].  
[EDIT] flashes.
2. Press [EDIT] a few times until "  $\epsilon hr$  " is displayed.  
"  $\epsilon hr$  " appears in the display, then the threshold value is indicated.
3. Hit the pad you wish to set.  
The trigger indicator for the struck pad lights.
4. Press [+] or [-] to set the threshold.

**Threshold:** 0–15

When set to a higher value, no sound is produced when the pad is struck lightly.

Gradually raise the "Threshold" value while striking the pad. Check this and adjust accordingly. Repeat this process until you get the perfect setting for your playing style.

5. Press [EDIT] to continue editing other settings.
6. When you're finished, press [DRUM KIT]; the [EDIT] light goes off.

**NOTE** Do not turn off the power without the [EDIT] light having gone out. Otherwise you will lose the changes you have just made.

## How Playing Dynamics Changes the Volume (Velocity Curve)

This setting allows you to control the relation between playing velocity (striking force) and changes in volume. Adjust this curve until the response feels as natural as possible.

1. Hold down [LEVEL/PAN] and press [TEMPO].  
[EDIT] flashes.
2. Press [EDIT] a few times until "CUR" is displayed.  
"CUR" appears in the display, then the velocity curve value is indicated.
3. Hit the pad you wish to set.  
The trigger indicator for the struck pad lights.

4. Press [+] or [-] to adjust the curve.

### Velocity Curve

#### LINEAR (LNR)

The standard setting. This produces the most natural correspondence between playing dynamics and volume change.

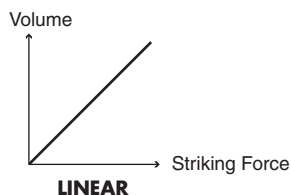

#### EXPONENTIAL 1, EXPONENTIAL 2 (EP1 EP2)

Compared to LINEAR, strong dynamics produce a greater change.

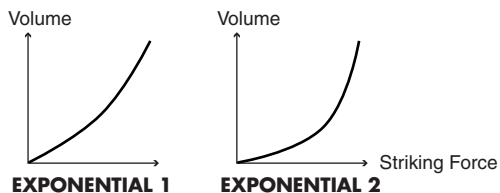

#### LOG1, LOG2 (LG1 LG2)

Compared to LINEAR, a soft playing produces a greater change.

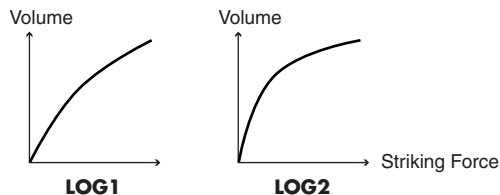

#### SPLINE (SPL)

Extreme changes are made in response to playing dynamics.

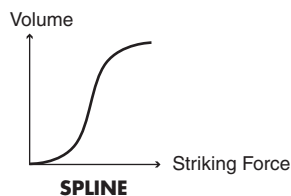

#### LOUD1, LOUD2 (LD1 LD2)

Very little dynamic response, making it easy to maintain strong volume levels. If using drum triggers, these settings help maintain stable levels.

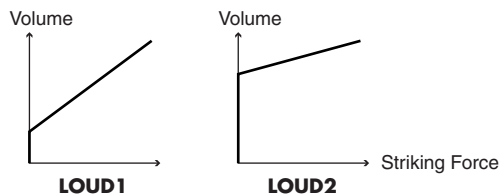

5. Press [EDIT] to continue editing other settings.
6. When you're finished, press [DRUM KIT]; the [EDIT] light goes off.

**NOTE** Do not turn off the power without the [EDIT] light having gone out. Otherwise you will lose the changes you have just made.

## Adjusting the Trigger Signal Detection Time (Scan Time)

Since the rise time of the trigger signal waveform may differ slightly depending on the characteristics of each pad or acoustic drum trigger (drum pickup), you may notice that identical hits (velocity) may produce sound at different volumes. If this occurs, you can adjust the “SCAN TIME” so that your way of playing can be detected more precisely.

As the value is set higher, the time it takes for the sound to be played increases.

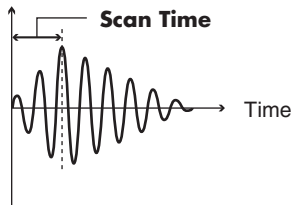

1. Hold down [LEVEL/PAN] and press [TEMPO].  
[EDIT] flashes.
2. Press [EDIT] a few times until “SCAN” is displayed.  
“SCAN” appears in the display, then the scan time value is indicated.
3. Hit the pad you wish to set.  
The trigger indicator for the struck pad lights.
4. Press [+] or [-] to adjust the scan time.  
**Scan Time:** 0–4.0 ms (0.1 ms steps)

### Making the settings

While repeatedly hitting the pad at a constant force, gradually raise the Scan Time value from 0 msec, until the resulting volume stabilizes at the loudest level. At this setting, try both soft and loud strikes, and make sure that the volume changes appropriately.

The force with which you hit the pad (velocity) will be shown in the display on a six-level scale.

Set the velocity at a value of 127 when you strike the pad most forcefully.

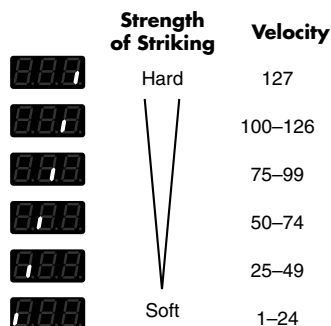

5. Press [EDIT] to continue editing other settings.
6. When you’re finished, press [DRUM KIT]; the [EDIT] light goes off.

**NOTE** Do not turn off the power without the [EDIT] light having gone out. Otherwise you will lose the changes you have just made.

## Detecting Trigger Signal Attenuation and Cancelling Incorrect Triggering (Retrigger Cancel)

Important if you are using acoustic drum triggers. Such triggers can produce altered waveforms, which may also cause inadvertent sounding at Point A in the following figure.

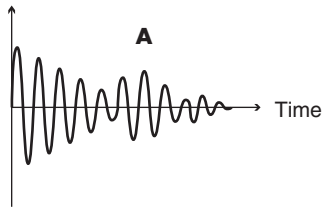

This occurs in particular at the decaying edge of the waveform. Retrigger Cancel detects such distortion in and prevents retriggering from occurring.

Although setting this to a high value prevents retriggering, it then becomes easy for sounds to be omitted when the drums played fast (roll etc.). Set this to the lowest value possible while still ensuring that there is no retriggering.

### MEMO

You can also eliminate this problem of retriggering with the Mask Time setting. Mask Time does not detect trigger signals if they occur within the specified amount of time after the previous trigger signal was received. Retrigger Cancel detects the attenuation of the trigger signal level, and triggers the sound after internally determining which trigger signals were actually generated when the head was struck, while weeding out the other false trigger signals that need not trigger a sound.

1. Hold down [LEVEL/PAN] and press [TEMPO].  
[EDIT] flashes.
2. Press [EDIT] a few times until " r t " is displayed.  
" r t " appears in the display, then the retrigger cancel value is indicated.
3. Hit the pad you wish to set.  
The trigger indicator for the struck pad lights.
4. Press [+] or [-] to adjust the value.

**Retrigger Cancel:** 0–15

### Making the settings

While repeatedly striking the pad, raise the "Retrigger Cancel" value until retriggering no longer occurs.

5. Press [EDIT] to continue editing other settings.
6. When you're finished, press [DRUM KIT]; the [EDIT] light goes off.

### NOTE

Do not turn off the power without the [EDIT] light having gone out. Otherwise you will lose the changes you have just made.



## Eliminate Crosstalk Between Pads (Crosstalk Cancel)

When two pads are mounted on the same stand, hitting one pad may trigger the sound from another pad unintentionally (This is called **crosstalk**.) Eliminate this by adjusting Crosstalk Cancel on the pad that is sounding inadvertently.

1. Hold down [LEVEL/PAN] and press [TEMPO].  
[EDIT] flashes.
2. Press [EDIT] a few times until “ 5 ” is displayed.  
“ 5 ” appears in the display, then the crosstalk cancel value is indicated.
3. Hit the pad you wish to set.  
The trigger indicator for the struck pad lights.  
If the hi-hat cymbal also sounds when hitting a snare pad, set the Crosstalk Cancel for the pad being used for the hi-hat. As this value is raised, the hi-hat cymbal pad will be less prone to receive crosstalk from other pads.
4. Press [+] or [-] to adjust the value.  
**Crosstalk Cancel:** OFF, 20, 25, 30, 35, 40, 45, 50, 55, 60, 65, 70, 75, 80  
**Crosstalk Example: If you hit the snare pad and the hi-hat cymbal also sounds**  
Raise the “Xtalk Cancel (Crosstalk Cancel)” for the pad being used for the hi-hat. The hi-hat cymbal pad will be less prone to receive crosstalk from other pads.  
If the value is set too high, and two pads are played simultaneously, the one that is struck less forcefully may not sound. Be careful and set this parameter to the minimum value required to prevent crosstalk. With a setting of “OFF,” crosstalk prevention will not work.
5. Press [EDIT] to continue editing other settings.
6. When you're finished, press [DRUM KIT]; the [EDIT] light goes off.

**NOTE** Do not turn off the power without the [EDIT] light having gone out. Otherwise you will lose the changes you have just made.

**MEMO** You can also make the settings using the procedure on p. 41.

## Double Triggering Prevention (Mask Time)

When playing a kick pad the beater can bounce back and hit the pad a second time immediately after the intended note—with acoustic drums sometimes the beater stays against the head—this causes a single hit to “double trigger” (two sounds instead of one). The Mask Time setting helps to prevent this. Once a pad has been hit, any additional trigger signals occurring within the specified “MASKTIME” (0–64 msec) will be ignored.

When set to a high value, it will be difficult to play very quickly. Set this to as low a value as you can.

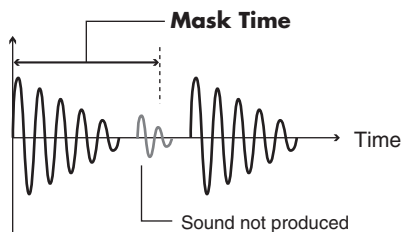

1. Hold down [LEVEL/PAN] and press [TEMPO].  
[EDIT] flashes.
2. Press [EDIT] a few times until “*MSH*” is displayed.  
“*MSH*” appears in the display, then the mask time value is indicated.
3. Hit the pad you wish to set.  
The trigger indicator for the struck pad lights.

4. Press [+] or [-] to set the mask time.

**Mask Time:** 0–64 ms (4 ms steps)

### Making the settings

Adjust the “Mask Time” value while playing the pad.

When using a kick trigger, try to let the beater bounce back and hit the head very quickly, then raise the “Mask Time” value until there are no more sounds made by the beater rebound.



If two or more sounds are being produced when you strike the head just once, then adjust Retrigger Cancel.

5. Press [EDIT] to continue editing other settings.
6. When you’re finished, press [DRUM KIT]; the [EDIT] light goes off.



Do not turn off the power without the [EDIT] light having gone out. Otherwise you will lose the changes you have just made.

## Rim Shots Response (Rim Sensitivity)

When a PD-80R, PD-85, PD-105, PD-120, PD-125 pad, or RT-5S (trigger) is connected to the SNARE TRIGGER INPUT, you can adjust the sensitivity of the rim response.

1. Hold down [LEVEL/PAN] and press [TEMPO].  
[EDIT] flashes.
2. Press [EDIT] a few times until “ r 15 ” is displayed.  
“ r 15 ” appears in the display, then the rim sensitivity value is indicated.
3. Hit the pad you wish to set.  
The trigger indicator for the struck pad lights.
4. Press [+] or [-] to adjust the sensitivity of the rim.  
**Rim Sensitivity:** OFF, 1–20

### Making the settings

Setting this to a higher value makes it easier to get rim sounds. When set to “OFF,” playing a rim shot produces the sound assigned to the head. Increasing the value excessively may cause the rim instrument to sound as well when the head is struck.

When the trigger type is set to something other than “ 80r , ” “ 105 , ” “ 125 , ” or “ 155 , ” a horizontal line ( - - - ) appears, and you cannot make adjustments.

5. Press [EDIT] to continue editing other settings.
6. When you’re finished, press [DRUM KIT]; the [EDIT] light goes off.

**NOTE** Do not turn off the power without the [EDIT] light having gone out. Otherwise you will lose the changes you have just made.

## Rim/Edge Dynamic Response (Rim Gain)

When a PD-7/8/9, PD-80R/85, PD-105/120/125, CY series pad, or RT-5S (trigger) is connected to the SNARE, HI-HAT, CRASH 1, CRASH 2, or RIDE TRIGGER INPUT, you can adjust the relation between your playing velocity (force) on the rim/edge and the resulting volume level.

1. Hold down [LEVEL/PAN] and press [TEMPO].  
[EDIT] flashes.
2. Press [EDIT] a few times until “ r 10 ” is displayed.  
“ r 10 ” appears in the display, then the rim gain value is indicated.
3. Hit the pad you wish to set.  
The trigger indicator for the struck pad lights.
4. Press [+] or [-] to adjust the rim signal level.  
**Rim Gain:** 0.5–2.0

When the trigger type is set to “ 100 , ” “ 100 , ” “ 100 , ” or “ 100 , ” a horizontal line ( - - - ) appears, and you cannot make adjustments.

5. Press [EDIT] to continue editing other settings.
6. When you’re finished, press [DRUM KIT]; the [EDIT] light goes off.

**NOTE** Do not turn off the power without the [EDIT] light having gone out. Otherwise you will lose the changes you have just made.

# MIDI Settings

## About MIDI

MIDI (Musical Instrument Digital Interface) is a standard that allows performance data and other information to be exchanged among electronic musical instruments and computers. With a MIDI cable connecting MIDI connectors equipped devices, you can play multiple instruments with a single keyboard, have multiple MIDI instruments perform in ensemble, program the settings to change kits automatically to match the performance as the song progresses, and more. To use the TD-3 pads as a MIDI controller, or for recording from the pads to an external sequencer is easy. Using the TD-3 as a sound module with an external sequencer is also simple. Please read the following information about MIDI.

## MIDI Connectors

The TD-3 has two types of MIDI connectors.

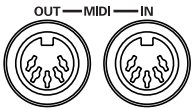

### MIDI IN Connector

This receives MIDI messages transmitted from an external MIDI device. These messages can play the TD-3's internal sounds, change kits or load previously saved data (p. 63).

### MIDI OUT Connector

Pad performance data (note #, velocity, etc.) is transmitted from this connector to connected MIDI devices. You can also save your settings to a MIDI sequencer (Bulk Dump; p. 62).

## MIDI Note Number for Each Pad [NOTE#]

Each drum kit can have its own set of MIDI note numbers to be transmitted/received by each pad, useful for advanced purposes.

Normally, you'll never need to change them, but remember that the Open Hi-Hat's default setting is 46 (A#2). The closed hi-hat default setting is 42 (F#2) and the pedal-close hi-hat default setting is 44 (G#2). These change together to open and close the hi-hat.

*\* If the open hi-hat note number is set to "60 (C 4)," the note number for the closed hi-hat becomes "56 (G#3)" and the note number for the pedal hi-hat becomes "58 (A#3)."*

More about factory-set note numbers can be found here: "Drum Kit Note Numbers" (p. 61).

1. Press [EDIT].  
[EDIT] flashes.
2. Press [EDIT] a few times until the NOTE# indicator is lit.

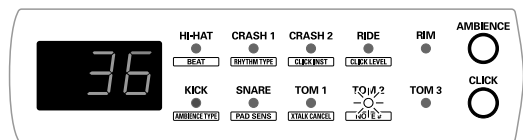

3. Hit the pad you wish to set.  
The trigger indicator for the struck pad lights momentarily.
4. Press [+] or [-] to set the note number.  
When holding down [+] and pressing [-] values increase rapidly. When holding down [-] and pressing [+] values decrease rapidly.  
**Note Number:** 0 (C -)-127 (G 9), OFF  
*\* If you select a note number already set for a different pad, the note number will flash.*
5. Repeat Steps 3 and 4 for any other pads you want to set.
6. When you're finished, press [DRUM KIT]; the [EDIT] light goes off.

### NOTE

Do not turn off the power without the [EDIT] light having gone out. Otherwise you will lose the changes you have just made.

## Playing an External MIDI Device from Pads Connected to the TD-3

Set the MIDI note numbers (same as key numbers on a keyboard) that will be transmitted by the TD-3 pads.

Match this to the note number of the sound that you wish to play on the external sound module or sampler.

### When Setting Multiple Pads to the Same Note Number

If overlapping note numbers are received from an external MIDI device playing the TD-3, priority is given to the instruments assigned in the following order.

1. KICK
2. SNARE
3. TOM 1
4. TOM 2
5. TOM 3
6. HI-HAT
7. CRASH 1
8. CRASH 2
9. RIDE

If note numbers for the head and rim are duplicated, only the head instrument is played.

#### Example:

Note Number "38 (D 2)" is set for the head and rim of Trigger Input SNARE and the head of Trigger Input TOM1. In this case, when Note Number 38 (D 2) is received, the instrument assigned to the head of Trigger Input SNARE is played.

## Drum Kit Note Numbers

Note No.	
18	
19	
20	
21	
22	CLOSED HI-HAT (Edge)
23	
-----	
C1	
24	
25	OPEN HI-HAT (Edge)
26	
27	
28	
29	
30	
31	
32	
33	
34	
35	
-----	
C2	
36	KICK
37	
38	SNARE (Head)
39	
40	SNARE (Rim)
41	TOM 3
42	CLOSED HI-HAT (Bow)
43	
44	PEDAL HI-HAT
45	TOM 2
46	OPEN HI-HAT (Bow)
47	
-----	
C3	
48	TOM 1
49	CRASH 1 (Bow)
50	
51	RIDE (Bow)
52	CRASH 2 (Edge)
53	RIDE (Edge)
54	
55	CRASH 1 (Edge)
56	
57	CRASH 2 (Bow)
58	
59	
-----	
C4	
60	

\* When a note number received is assigned to a pad, the corresponding trigger indicator then lights up. (You cannot check the timing in Coach mode.)

### When Only Using as a MIDI Controller (Local Control)

This is required when you want to trigger sounds in an external sound module and/or record your performance on an external MIDI sequencer, and NOT use the TD-3's internal sounds. If that is your need, then turn Local Control to "OFF." The trigger signals from the pads go directly to the MIDI OUT. See diagram below.

The TD-3's default mode is with Local Control "ON."

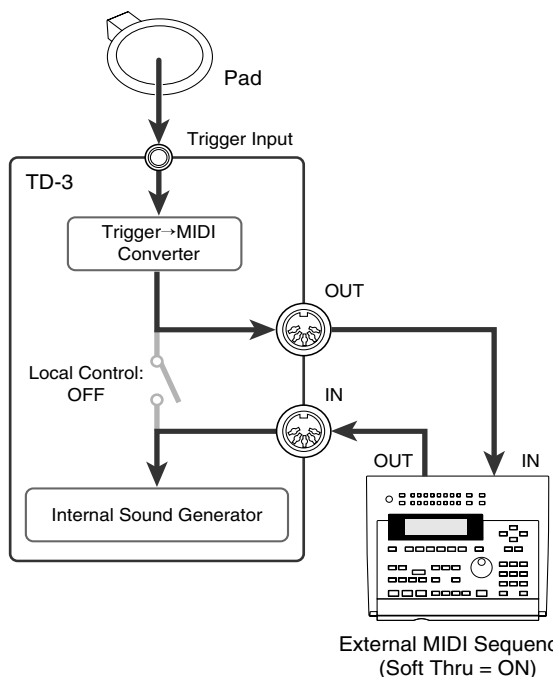

#### NOTE

If you make connections and record as shown, with a setting of Local Control On, MIDI note "feedback" will occur and the TD-3 will not sound right.

#### 1. Hold down [INST] and turn the TD-3's power on.

"Local Control OFF" appears in the scroll display, and Local Control is switched off.

Hitting the pads creates no sound from the TD-3. (the trigger indicators do light up.)

#### 2. If you turn the power off, Local Control will be set to ON when the power is turned on again.

The pads function normally, triggering the TD-3's internal sounds.

\* Local Control is always switched on when the power is turned on without [INST] being pressed.

### Saving Data to an External MIDI Device (Bulk Dump)

You can save all of the TD-3's drum kits, general settings, and more to an external MIDI sequencer.

Use the external sequencer as you would when recording musical data, following steps on the TD-3 as shown below.

#### 1. Connect the TD-3's MIDI OUT connector with a MIDI cable to the MIDI IN connector of the external sequencer.

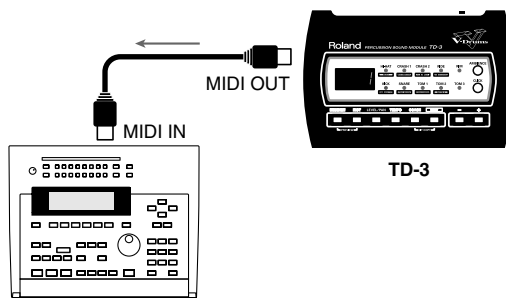

External MIDI Sequencer

#### 2. While holding down [DRUM KIT], turn the TD-3's power on.

"bulk duMP" appears in the scroll display, then "ALL" is displayed, and [DRUM KIT] flashes.

#### 3. Press [+] or [-] to select the content to be saved.

*ALL* : All data, including the setup (trigger, pad, and other settings) and drum kits are transmitted.

*1-32* : All data for Drum Kits 1-32 is transmitted.

*SETUP* : Only setup data is transmitted.

#### 4. Start recording with the external sequencer.

#### 5. Hold down [DRUM KIT] to begin transmitting the data.

"DUMP" appears in the display while the data is being transmitted.

#### 6. Be sure that the transmission is finished, then stop recording with the external sequencer.

#### 7. Turn the TD-3's power off.

#### MEMO

For more information concerning external MIDI devices be sure to read the respective owner's manual.

**NOTE**

Bulk Dump is one kind of System Exclusive message. Be sure to use an external MIDI sequencer that is capable of recording System Exclusive messages. In addition, confirm that the sequencer is not set to "Do not receive System Exclusive messages."

**NOTE**

Device ID, a Roland's MIDI System Exclusive message, is used in distinguishing among multiple devices, and the value for this setting is called the Device ID number. The Device ID number on the TD-3 is fixed at "17."

## Loading Data to the TD-3

This loads back the data that was saved to a sequencer or other external MIDI device to the TD-3.

**NOTE**

At this time, all the TD-3's current data is overwritten. Make sure you have made the needed back-up.

1. **Connect the TD-3's MIDI IN connector with a MIDI cable to the MIDI OUT connector of the external sequencer.**

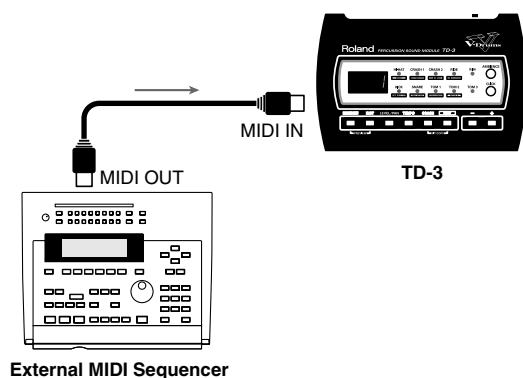

2. **Press [DRUM KIT] to display the drum kit number.**
3. **Press "PLAY" on the sequencer to transmit the data to the TD-3.**

Received data is then written into the memory of the TD-3.

## Using MIDI

### MIDI Channel

The TD-3's transmit and receive channel is fixed at "10."

### Program Changes Transmitting/Receiving

#### Drum Kit

The drum kit program change numbers are identical to the drum kit numbers and cannot be changed.

**MEMO**

The TD-3's drum kits are switched when a Program Change message is received from an external MIDI device.

### Control Changes Using the Hi-Hat Control Pedal

Hi-Hat Control Pedal transmits Control Change Number 4 (Foot Control).

**Transmitted data:** 0-127

### Messages for Transmitting Choking Information

When choking, the messages are transmitted as polyphonic after touch.

#### Note Number

The note number set for the head and rim of the pad.

#### Transmitted data

when the rim is pressed: 7FH

when the rim is released: 00H

### Triggering an External Sound Module from the TD-3

#### HINT

Doing this allows you to play sounds in the TD-3 and sounds in an external MIDI sound module simultaneously.

1. Connect the TD-3's MIDI OUT connector with a MIDI cable to the MIDI IN connector of the external MIDI device.

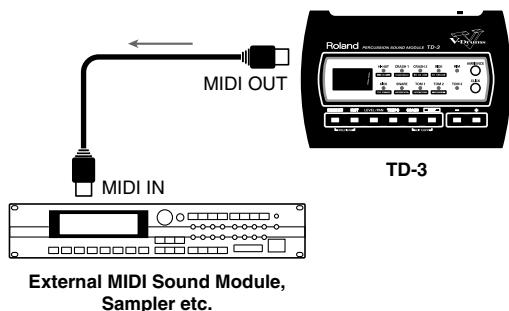

2. Set the external MIDI device's MIDI receive channel to 10.
3. Set the note number to be transmitted from each pad (p. 60).

Match this to the note number of the sound you wish to play on the external MIDI sound module or sampler.

### Recording to an External Sequencer

This makes the settings that allow performances of the pads to be recorded by an external MIDI sequencer.

1. Use MIDI cables to connect the MIDI connectors of the TD-3 and MIDI sequencer as shown in the following figure.

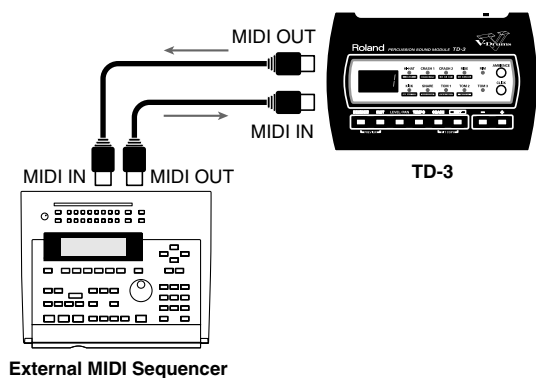

2. Hold down [INST] and turn the TD-3's power on. Local Control is set to "OFF."
3. Set both the external MIDI sequencer's MIDI transmit and receive channels to 10 if needed.
4. Start recording on the external MIDI sequencer.
5. Everything you play on the pads will be recorded in the sequencer.
6. When you're finished, stop recording.
7. Play the MIDI sequencer, and you'll hear what you just recorded.

### Using the TD-3 As a Sound Module

Here, the TD-3 is used as a sound module. You can connect a MIDI-compatible keyboard or pads for performance.

1. Connect the TD-3's MIDI IN connector with a MIDI cable to the MIDI OUT connector of the external MIDI device.

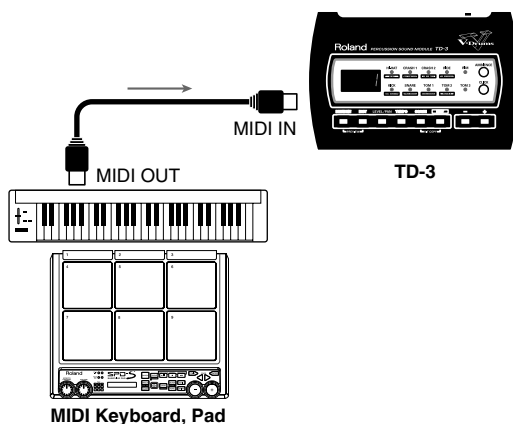

2. Set the external MIDI device's MIDI transmit channel to 10.
3. When playing the external MIDI device, the TD-3 will sound.



# Troubleshooting / Error Messages

## Troubleshooting

This section outlines points to check if you experience problems, and what to do about them.

### No Sound

#### No Sound

##### Is the [VOLUME] down?

Rotate the [VOLUME] knob to be sure.

##### Is Local control set to "OFF?" (p. 62)

Local Control should be set to "ON" if an external sequencer is not being used. Turn the power OFF once, then ON.

#### No Sound from One or More Pads

##### Is the volume level of an instrument lowered? (p. 25)

Press [LEVEL/PAN] and set the instrument level.

##### Is the pad connected correctly? (p. 12)

Make sure that pad / input connections are correct.

Use only the provided cables to connect the pads.

##### Is the instrument set to #114 (OFF)? (Drum Instrument List; p. 69)

#114 (OFF) means OFF.

Select an instrument numbered 1-113.

#### Cannot Play Rim Shots/Edge Shots

##### Is the pad rim/edge shot capable? Connected to the trigger input that is rim/edge capable? Using a Stereo cable? (p. 18)

When using the PD-80R, PD-85, PD-105, PD-120, or PD-125 to play rim shots, connect to Trigger Input "SNARE."

When using the PD-7, PD-8, PD-9, CY-6, CY-8, CY-12R/C, CY-12H, CY-14C, or CY-15R to play rim shots (or edge/bell shots) or choking, connect to Trigger Input "SNARE," "HI-HAT," "CRASH1," "CRASH2," or "RIDE."

The PD-6, PD-80, and PD-100 have no rim/edge possibility.

##### Is the Rim Sensitivity set to "0?" (p. 59)

Press [+] to set this to anything other than "0."

You need to set the "Rim Sensitivity" when using the PD-80R, PD-85, PD-105, PD-120, or PD-125 to play rim shots.

#### Cross Stick Does Not Work

##### Is the pad connected to a trigger input that is capable of handling edge/rim signals? (p. 18)

When using the PD-80R, PD-85, PD-105, PD-120, or PD-125 to play cross sticks, connect to SNARE trigger input jack. (Stereo Cable)

##### Has the correct instrument been assigned to the rim? (Drum Instrument List; p. 69)

When playing cross stick, select either "S1r," "S2r," "S3r," "S4r," "S10," or "S11" for the SNARE rim instrument.

##### Are you playing the cross stick correctly? (p. 20, p. 46)

Playing cross stick on electronic drums is a bit different. Be sure your hand or stick does not strike the head also.

#### No Sound When the Pad is Hit Softly

##### Did you hit or touch a pad or press a pedal during the TD-3's power up process?

Using the procedure of p. 14, turn the power on once again. DO NOT touch any pads or pedals during the TD-3's power up. When the TD-3 is turned on, it carries out a check of the pads. If you strike a pad or press the pedal anytime during this process, the pads cannot be checked properly, resulting in incorrect functioning of the pads.

#### No Click/Metronome Sound

##### Does [CLICK] light? (p. 28)

Press [CLICK] to light the button.

##### Is the click volume level set to "0?" (p. 33)

Press [EDIT] a number of times to select "CLICK LEVEL," then press [+] to set this to anything other than "0."

## No Sound/Low Volume from Source Connected to the MIX IN Jack

**Could you be using a connection cable that contains a resistor?**

Use a connection cable that does not contain a resistor.

**Check the volume level of the connected audio source.**

See the owner's manual for the device if there's a problem.

## Drum Kit Does Not Sound As Intended

### No Ambience Applied

**Is the Ambience set to "OFF?" (p. 26)**

Press [AMBIENCE], then switch the setting to "ON."

## Pad Does Not Sound As Intended

### Pad Not Playing Correctly

**Is the trigger type setting correct?**

Set the trigger type (p. 50).

**Is the pad's sensitivity setting correct?**

Set the pad sensitivity (p. 40, p. 52).

*\* For fullest expression in performance, we recommend the exclusive use of Roland pads.*

**Is the KD-80, KD-85, KD-120, PD-80, PD-80R, PD-85, PD-100, PD-105, PD-120, or PD-125 head tightened uniformly?**

Refer to the owner's manual for the pad you are using, then adjust the head tension. This is very important for proper triggering.

### Wrong Sound Plays

**Is there a mistake in the head and rim selection? (p. 24)**

As you can make separate settings for the head and rim, confirm the trigger input, then adjust.

**Are you playing the rim shot (p. 19, p. 46) and cross stick (p. 20, p. 46) correctly?**

To play rim shots, strike the head and rim simultaneously. For cross stick, be sure your hand or stick does not touch the head.

## Sound is Distorted

### Sound in Headphones Distorted

**Sometimes, setting the output too high certain tones can the sound seem distorted.**

Turn down the VOLUME. Or check your headphones.

### Output Sound Is Distorted

**Check your input levels on your mixer or amp. Check individual level and pan positions.**

Press [LEVEL/PAN] to display the instrument level, then press [-] to lower the level for the pad instrument.

You can suppress distortion by setting the pan near the center.

Press [LEVEL/PAN] to display the instrument's pan setting, then press [+] or [-] to adjust the setting.

## Cannot Carry Out Bulk Dump

**Is the MIDI connection/cable correct? (p. 62)**

If you wish to save a bulk dump on an external device, connect the TD-3's MIDI OUT connector to the external sequencer's MIDI IN connector.

**Is the external MIDI device set to NOT receive MIDI Exclusive messages?**

Refer to the owner's manual for the external MIDI device, then set it so that the reception of System Exclusive data is enabled.

*\* System Exclusive data is a kind of data used only by a particular device; bulk dump data is one type of System Exclusive data.*

## Error Messages

Display	Meaning	Action
<i>Er 1</i>	Data in the TD-3's memory may be corrupted.	" <i>rst</i> " appears when [DRUM KIT] is pressed. Hold down [DRUM KIT] once more. Only the settings for the corrupted portion are subject to Factory Reset (doing so will erase any changes you have made). If this does not resolve the problem, consult your Roland dealer or nearest Roland Service Center.
<i>Er 2</i>	A problem has occurred with the internal system.	Consult your Roland dealer or nearest Roland Service Center.
<i>Midi buf Full</i> (Scroll Display)	A large amount of MIDI messages were received, and could not be processed completely.	Double check your MIDI connections (p. 62, p. 64). If this does not solve the problem, reduce the amount of MIDI messages being transmitted to the TD-3.
<i>Midi Off lin</i> (Scroll Display)	Something has caused a break in communication with the external MIDI device.	Verify your MIDI connections.
<i>Midi Checksum</i> (Scroll Display)	The checksum value of a system exclusive message was incorrect.	Correct the checksum value.
<i>Midi Err</i> (Scroll Display)	The TD-3 failed to receive a MIDI message correctly.	Transmit the MIDI message to the TD-3 once again.

# Drum Kit List

---

No.	Name
1	Acoustic
2	Groove
3	Oldies
4	2 Step
5	Ballad
6	Electronic
7	Techno House
8	Hip-Hop
9	Jazz
10	Disco Beat
11	Open Rock
12	Standard
13	Acid House
14	TR-808
15	Dirty
16	Jungle
17	Funk
18	Latin House
19	Abstract
20	Club Mix
21	Jazz Fusion
22	Garage House
23	Light Tuning
24	Brushes
25	R&B
26	Techno Cumbia
27	Classic R&B
28	Pop-Rock
29	Timbales Kit
30	Conga Kit
31	Percussion Set 1
32	Percussion Set 2

# Drum Instrument List

No.	Display	Name
-----	---------	------

## KICK

1	K01	Wood Kick
2	K02	Rock Kick
3	K03	Tight Kick
4	K04	Ambient Kick
5	K05	Muffle Kick
6	K06	Jazz Kick
7	K07	Hard Attack Kick
8	K08	Latin Kick
9	K09	Club Kick 1
10	K10	Club Kick 2
11	K11	Club Kick 3
12	K12	Club Kick 4
13	K13	808 Kick
14	K14	909 Kick

## SNARE

15	S1	Bright Snare	
16	S1r	Bright Snare Rim	*1
17	S2	Vintage Snare	
18	S2r	Vintage Snare Rim	*1
19	S3	Vintage Snare 2	
20	S3r	Vintage Snare 2 Rim	*1
21	S4	Funk Snare	
22	S4r	Funk Snare Rim	*1
23	S5	Piccolo Snare	
24	S5r	Piccolo Snare Rim	
25	S6	Brass Snare	
26	S6r	Brass Snare Rim	
27	S7	Rock Snare	
28	S7r	Rock Snare Rim	
29	S8	Ballad Snare	
30	S9	Brush Snare	
31	S9r	Brush Snare Rim	
32	S10	Cross Stick 1	
33	S11	Cross Stick 2	
34	S12	Club Snare 1	
35	S13	Club Snare 2	
36	S14	Club Snare 3	
37	S15	Club Snare 4	
38	S16	Club Snare 5	
39	S17	Club Snare 6	
40	S18	Club Snare 7	
41	S19	Club Snare 8	
42	S20	Club Snare 9	
43	S21	808 Snare	
44	S22	909 Snare	
45	S23	909 Clap	

## TOM

46	t1.1	Power Tom 12"
47	t1.2	Power Tom 14"
48	t1.3	Power Tom 16"
49	t2.1	Rock Tom 12"
50	t2.2	Rock Tom 13"
51	t2.3	Rock Tom 16"
52	t3.1	Clear Tom 10"
53	t3.2	Clear Tom 12"
54	t3.3	Clear Tom 14"
55	t3.4	Clear Tom 16"
56	t4.1	Jazz Tom 12"
57	t4.2	Jazz Tom 13"
58	t4.3	Jazz Tom 16"
59	t5.1	808 Tom 1
60	t5.2	808 Tom 2
61	t5.3	808 Tom 3
62	t6.1	Electronic Tom 1
63	t6.2	Electronic Tom 2
64	t6.3	Electronic Tom 3

## HI-HAT

65	H01	Lite HH
66	H02	Lite HH Edge
67	H03	Dark HH
68	H04	Dark HH Edge
69	H05	Club HH
70	H06	808 HH
71	H07	909 HH
72	H08	Triangle HH
73	H09	Shaker & Pedal Claves
74	H10	Tambourine & Pedal Cowbell

## RIDE

75	Rd1	Pop Ride (Bow/Bell sw)	*2
76	Rd2	Pop Ride Bell	
77	Rd3	Pop Ride Edge	
78	Rd4	Jazz Ride (Bow/Bell sw)	*2
79	Rd5	Jazz Ride Bell	
80	Rd6	Jazz Ride Edge	

## CRASH

81	Cr1	Dark Thin Crash 16"
82	Cr2	Medium Crash 16"
83	Cr3	Thin Crash 18"
84	Cr4	Medium Thin Crash 18"
85	Cr5	Paper Thin Crash 14"
86	Cr6	Splash 8"
87	Cr7	China 16"
88	Cr8	808 Cymbal

## PERCUSSION

89	P01	Claves	
90	P02	Shaker	
91	P03	Tambourine	
92	P04	Cowbell 1	
93	P05	Cowbell 2	
94	P06	Wood Block Hi	
95	P07	Wood Block Lo	
96	P08	Triangle Open	
97	P09	Triangle Close	
98	P10	Sleigh Bell	
99	P11	Tree Chimes	
100	P12	Timbale Hi	
101	P13	Timbale Rim	
102	P14	Timbale Lo	
103	P15	Conga Hi	
104	P16	Conga Closed Slap	
105	P17	Conga Lo	
106	P18	Bongo Hi	
107	P19	Bongo Closed Slap	
108	P20	Bongo Lo	
109	SP1	Wood Block Lo/Hi sw	*3
110	SP2	Timbale Hi/Rim sw	*3
111	SP3	Conga Hi/Slap sw	*3
112	SP4	Bongo Hi/Slap sw	*3
113	SP5	Shaker/Claves sw	*3

## OFF

114	oFF	Off
-----	-----	-----

## Click Instruments

No.	Name
1	Metronome
2	Beep
3	Electric
4	Sweep
5	Zap
6	Pulse
7	Cowbell
8	Claves
9	Sticks
10	Voice

\*1: Velocity switching "snare rim" sound, played softly produces a cross stick sound, and when played harder, produces a rim shot sound (p. 20, p. 46).

\*2: Velocity switching sound. With playing dynamics (velocity), you can play the "bow" or "bell" sound (p. 20, p. 47).

\*3: Velocity switching percussion sound same principle as mentioned above.

# MIDI Implementation Chart

Function...	Transmitted	Recognized	Remarks
Basic Channel Default Changed	10 X	10 X	
Mode Default Messages Altered	Mode 3 X *****	Mode 3 X *****	
Note Number : True Voice	0-127 *****	0-127 0-127	
Velocity Note On Note Off	<input type="radio"/> 99H, v = 1-127 <input type="radio"/> 89H, v = 64	<input type="radio"/> X	
After Touch Key's Channel's	<input type="radio"/> X	<input type="radio"/> X	
Pitch Bend	X	X	
Control Change 4	<input type="radio"/>	<input type="radio"/>	Foot control
Program Change : True Number	<input type="radio"/> *****	<input type="radio"/> 0-31	Program No. 1-32
System Exclusive	<input type="radio"/>	<input type="radio"/>	
System Common : Song Position : Song Select : Tune Request	X X X	X X X	
System Real Time : Clock : Commands	X X	X X	
Aux Messages : All Sound Off : Reset All Controllers : Local On/Off : All Notes Off : Active Sensing : System Reset	X X X X <input type="radio"/> X	<input type="radio"/> <input type="radio"/> X X <input type="radio"/> X	
Notes			

Mode 1 : OMNI ON, POLY  
Mode 3 : OMNI OFF, POLY

Mode 2 : OMNI ON, MONO  
Mode 4 : OMNI OFF, MONO

: Yes  
 : No

# Specifications

## TD-3: Percussion Sound Module

### Instruments

Drum Instruments: 114

Click Instruments: 10

### Drum Kits

32

### Effect

Ambience (15 types)

### Click Tempo

20–260

### Coach Mode

Menu: 7

Variation: 20

### Display

7 segments, 3 characters (LED)

### Connectors

Trigger Input Jack x 9

Hi-Hat Control Jack

Output Jacks (L/MONO, R)

Phones Jack (stereo phone type)

Mix In Jack (stereo miniature phone type)

MIDI Connectors (IN, OUT)

### Output Impedance

1.0 k ohms

### Power Supply

AC Adaptor (DC 9V)

### Current Draw

1,000 mA

### Dimensions

220 (W) x 144 (D) x 59.5 (H) mm

8-11/16 (W) x 5-11/16 (D) x 2-3/8 (H) inches

### Weight

550 g / 1 lb 4 oz (excluding AC Adaptor)

### Accessories

Owner's Manual

AC Adaptor (ACI/ACB/PSB-1U Series)

Screw (M5 x 8) x 4

### Options

Pads

(PD-6, PD-7, PD-8, PD-9, PD-80, PD-80R, PD-85, PD-100, PD-105, PD-120, PD-125)

Cymbals

(CY-6, CY-8, CY-12H, CY-12R/C, CY-14C, CY-15R)

Kick Triggers

(KD-7, KD-8, KD-80, KD-85, KD-120)

Hi-Hat Control Pedals

(FD-7, FD-8)

Stands

(MDS-3C, MDS-6, MDS-8C, MDS-10, MDS-20)

Cymbal Mounts

(MDY-10U)

Pad Mounts

(MDH-10U)

*\* In the interest of product improvement, the specifications and/or appearance of this unit are subject to change without prior notice.*

# Index

## A

- AC Adaptor Jack ..... 10, 13
- AMBIENCE ..... 18, 26

## B

- BEAT ..... 29
- Bell Shot ..... 47
- Bow Shot ..... 19–20, 47
- BPM ..... 37
- Bulk Dump ..... 62

## C

- Choking ..... 20, 47, 63
- Claves ..... 31
- CLICK ..... 18, 28
- Click
  - Instruments ..... 69
  - On/Off ..... 28
  - Rhythm Type ..... 30
  - Sound ..... 32
  - Tempo ..... 28
  - Time Signature ..... 29
  - Volume ..... 33
- CLICK INST ..... 32
- CLICK LEVEL ..... 33
- COACH ..... 35
- Compression ..... 26
- Connection ..... 12–13, 34
- Control Change ..... 63
- Copy ..... 27
- Count In ..... 39
- Cross Stick ..... 20, 46
- Crosstalk Cancel ..... 41, 57
- Cuban Clave ..... 31

## D

- Display ..... 9
- Drum Instrument List ..... 69
- DRUM KIT ..... 23
- Drum Kit ..... 16, 22
- Drum Kit List ..... 68
- Drum Stand ..... 11

## E

- Edge Shot ..... 19–20, 47

## F

- Factory Reset ..... 43

## G

- Gradual Up/Down ..... 38

## H

- Head Shot ..... 19
- Head Shots ..... 46
- HH CTRL Jack ..... 10
- Hi-Hat Control Pedal ..... 21, 42, 63

## I

- INST ..... 18, 24

## K

- KIT COPY ..... 27

## L

- Latin Rhythm ..... 31
- LEVEL/PAN ..... 25
- Local Control ..... 62

## M

- Mask Time ..... 58
- Metronome ..... 28
- MIDI ..... 60
- MIDI Channel ..... 63
- MIDI Connector ..... 10, 60
- MIDI Implementation Chart ..... 70
- MIX IN Jack ..... 10, 34



**N**

Note Number ..... 60–61, 63  
NOTE# ..... 60

**O**

OUTPUT Jack ..... 10, 13

**P**

Pad ..... 19, 44  
PAD SENS ..... 40  
Pad Sensitivity ..... 40, 52  
Pan ..... 25  
PHONES Jack ..... 10, 13  
Polarity Switch ..... 44  
Power  
    Off ..... 15  
    On ..... 14  
POWER Switch ..... 10  
Preview ..... 17  
Program Change ..... 63

**Q**

Quiet Count ..... 37

**R**

Rear Panel ..... 10  
Retrigger Cancel ..... 56  
RHYTHM TYPE ..... 30  
Rhythmic Notes ..... 36  
Rim Gain ..... 59  
Rim Indicator ..... 9  
Rim Sensitivity ..... 59  
Rim Shot ..... 19, 46  
Rumba Clave ..... 31

**S**

Scan Time ..... 55  
Setting ..... 11  
Side Panel ..... 10  
Son Clave ..... 31  
Speed Check ..... 37  
Stand Holder ..... 11  
Step Up/Down ..... 38

**T**

TEMPO ..... 18, 28  
Threshold ..... 53  
Time Check ..... 36  
Time Signature ..... 29  
Top Panel ..... 9  
Trigger Indicator ..... 9  
Trigger Input Functions ..... 44  
TRIGGER INPUT Jack ..... 10, 18, 44  
Trigger Type ..... 50

**V**

Velocity Curve ..... 54  
Volume  
    Click ..... 33  
    Hi-Hat's Foot Closed ..... 42  
    Instrument ..... 25  
VOLUME Knob ..... 10

**X**

XTALK CANCEL ..... 41

# MEMO



This product complies with the requirements of European Directive 89/336/EEC.

For EU Countries

## FEDERAL COMMUNICATIONS COMMISSION RADIO FREQUENCY INTERFERENCE STATEMENT

For the USA

This equipment has been tested and found to comply with the limits for a Class B digital device, pursuant to Part 15 of the FCC Rules. These limits are designed to provide reasonable protection against harmful interference in a residential installation. This equipment generates, uses, and can radiate radio frequency energy and, if not installed and used in accordance with the instructions, may cause harmful interference to radio communications. However, there is no guarantee that interference will not occur in a particular installation. If this equipment does cause harmful interference to radio or television reception, which can be determined by turning the equipment off and on, the user is encouraged to try to correct the interference by one or more of the following measures:

- Reorient or relocate the receiving antenna.
- Increase the separation between the equipment and receiver.
- Connect the equipment into an outlet on a circuit different from that to which the receiver is connected.
- Consult the dealer or an experienced radio/TV technician for help.

This device complies with Part 15 of the FCC Rules. Operation is subject to the following two conditions:

- (1) This device may not cause harmful interference, and
- (2) This device must accept any interference received, including interference that may cause undesired operation.

Unauthorized changes or modification to this system can void the users authority to operate this equipment.  
This equipment requires shielded interface cables in order to meet FCC class B Limit.

For Canada

### NOTICE

This Class B digital apparatus meets all requirements of the Canadian Interference-Causing Equipment Regulations.

### AVIS

Cet appareil numérique de la classe B respecte toutes les exigences du Règlement sur le matériel brouilleur du Canada.

