



Soundtrack Pro

User Manual

To view the user manual, click a topic in the drawer on the side. Otherwise, click a link below.

- [Late-Breaking News](#)
- [Soundtrack Pro Support](#)
- [Soundtrack Pro on the Web](#)
- [Apple Training Centers](#)
- [Feedback](#)



 Apple Computer, Inc.
© 2005 Apple Computer, Inc. All rights reserved.

Under the copyright laws, this manual may not be copied, in whole or in part, without the written consent of Apple. Your rights to the software are governed by the accompanying software license agreement.

The Apple logo is a trademark of Apple Computer, Inc., registered in the U.S. and other countries. Use of the “keyboard” Apple logo (Option-Shift-K) for commercial purposes without the prior written consent of Apple may constitute trademark infringement and unfair competition in violation of federal and state laws.

Every effort has been made to ensure that the information in this manual is accurate. Apple Computer, Inc. is not responsible for printing or clerical errors.

Apple Computer, Inc.
1 Infinite Loop
Cupertino, CA 95014-2084
408-996-1010
www.apple.com

Apple, the Apple logo, AppleScript, DVD Studio Pro, iTunes, Final Cut, Final Cut Pro, FireWire, Logic, Mac, Mac OS, Macintosh, QuickTime, and Soundtrack are trademarks of Apple Computer, Inc., registered in the U.S. and other countries.

Finder is a trademark of Apple Computer, Inc.

Apple Care is a service mark of Apple Computer, Inc., registered in the U.S. and other countries.

Production stills from the films “Koffee House Mayhem” and “A Sus Ordenes” provided courtesy of Refuge Films. “Koffee House Mayhem” © 2004 Jean-Paul Bonjour; “A Sus Ordenes” © 2004 Eric Escobar.
<http://www.refugefilms.com>

Other company and product names mentioned herein are trademarks of their respective companies. Mention of third-party products is for informational purposes only and constitutes neither an endorsement nor a recommendation. Apple assumes no responsibility with regard to the performance or use of these products.

Contents

Preface	7 An Introduction to Soundtrack Pro
	7 What Is Soundtrack Pro?
	9 Resources for Learning About Soundtrack Pro
	10 Soundtrack Pro Onscreen User Manual
	10 Apple Websites
Chapter 1	13 Setting Up Your System
	13 System Considerations
	15 Connecting Audio Equipment
	19 Example Hardware Setups
Chapter 2	23 The Soundtrack Pro Interface
	24 Project Window
	33 Media and Effects Manager
	40 Utility Window
Chapter 3	45 Getting Started With Soundtrack Pro
	45 Two Kinds of Projects
	47 Setting Up Your Workspace
	50 Playing Projects
	56 Locating and Adding Audio Files
	68 Previewing Audio Files
	71 Using Undo and Redo
	72 Using Snap
	74 Reconnecting Media Files
	75 Setting Soundtrack Pro Preferences
Chapter 4	81 Working With Multitrack Projects
	81 Creating and Opening Multitrack Projects
	82 Closing Multitrack Projects
	82 Setting Project Properties
	86 Setting the Project Length
	86 Saving Multitrack Projects
	87 Adding Audio Files to a Multitrack Project

	89	Viewing and Editing Clip Properties
	90	Tracks, Busses, and Outputs
Chapter 5	93	Working in the Timeline
	94	Moving Around in the Timeline
	99	Working With Tracks, Busses, and Outputs in the Timeline
	107	Editing Audio Clips in the Timeline
	119	Working With Markers
Chapter 6	123	Working in the Mixer
	124	Steps in Mixing
	125	Working With Channel Strips in the Mixer
	134	Working With Effects and Sends in the Mixer
	138	Setting the Overall Project Volume Level
	140	Listening to a Temporary Mono Mix
	140	Recording Audio in the Mixer
	140	Recording Automation in the Mixer
	141	Creating Multiple Mixes
	141	Things to Keep in Mind While Mixing
Chapter 7	143	Working in the Waveform Editor
	144	Getting Started With Audio File Projects
	152	Playing Audio Files in the Waveform Editor
	154	Editing Audio Files in the Waveform Editor
	161	Processing Audio Files
	170	Working With Actions
	177	Analyzing an Audio File
	181	Using Markers in the Waveform Editor
	181	Scripting Actions in the Waveform Editor
Chapter 8	183	Working With Video in Soundtrack Pro
	183	Supported Video File Formats
	184	Adding a Video to a Project
	185	Playing the Video
	188	Viewing Video Details
	189	Working With a Video's Audio
	190	Using the Time Display and Time Ruler With Video
	191	Using Markers With Video
	194	Removing a Video From a Project
Chapter 9	195	Working With Audio Effects
	195	Realtime and Processing Effects
	196	Audio Effects Included With Soundtrack Pro
	207	Working With Realtime Effects

	216	Working With Processing Effects
	217	Working With Effect Presets
Chapter 10	219	Working With Automation
	219	Working With Envelopes
	228	Recording Automation Data
	229	Working With Timeslices
Chapter 11	235	Recording Audio in Soundtrack Pro
	235	Getting Ready to Record
	236	Recording Audio in the Timeline
	239	Saving Recorded Clips
	240	Recording Audio in the Mixer
	240	Recording Audio in the Waveform Editor
Chapter 12	243	Using Control Surfaces With Soundtrack Pro
	243	Connecting Control Surfaces
	244	Adding and Deleting Control Surfaces
	245	Premapped Controls
	245	Mapping Commands to Control Surface Buttons
	246	Recording Control Surface Automation
Chapter 13	247	Exporting Multitrack Projects
	248	Exporting a Project Mix
	248	Exporting Selected Tracks, Busses, and Outputs
	250	Exporting With Compressor
	252	Distributing a Multitrack Project and its Media Files Together
Chapter 14	253	Using Soundtrack Pro With Apple Professional Applications
	253	Using Soundtrack Pro With Final Cut Pro
	258	Using Soundtrack Pro With Motion
	260	Using Soundtrack Pro With DVD Studio Pro
	261	Using Soundtrack Pro With Other Applications
Appendix A	263	Using Apple Loops Utility
	263	What Is Apple Loops Utility?
	264	The Apple Loops Utility Interface
	269	Opening Files in Apple Loops Utility
	270	Tagging Files in Apple Loops Utility
	271	Working With Transients
	273	Saving Changes to Files
	273	Removing Files From the Assets Drawer
	274	Apple Loops Utility Preferences
	275	Apple Loops Utility Keyboard Shortcuts

Appendix B	279	Soundtrack Pro Keyboard Shortcuts
	279	General and File
	279	Windows, Tabs, and Layouts
	280	Project Playback and Setting the Playhead
	281	General Editing
	281	Editing Audio Clips in the Timeline
	282	Adjusting Audio Clips in the Timeline
	282	Navigating in the Timeline
	283	Editing Audio Files in the Waveform Editor
	284	Tracks and Markers
	284	Video Out
	285	Recording
Appendix C	287	Audio Basics
	287	Basic Audio Concepts
	289	Recording Sound
Appendix D	293	Solutions to Common Problems and Customer Support
	294	Solutions to Common Problems
	295	Calling AppleCare Support
Index	297	

An Introduction to Soundtrack Pro

Soundtrack Pro gives you the tools you need to create high-quality soundtracks for your video productions.

Recent years have seen a revolution in working with digital audio, matching the revolution in digital video editing and postproduction. Now, using a personal computer with a fast processor and enough RAM, video editors and other creative professionals can manipulate the audio for their video projects with the same power and flexibility as the video.

What Is Soundtrack Pro?

Soundtrack Pro is a new professional audio application for Macintosh computers that gives you the tools to perform a wide range of audio postproduction tasks. Using Soundtrack Pro, you can edit audio files, repair field recordings, perform multitrack arranging and mixing, synchronize audio and video, analyze and fix common audio problems, and perform creative sound design.

You can work in two kinds of projects in Soundtrack Pro: *multitrack projects* and *audio file projects*. In multitrack projects, you add and arrange audio clips on the Timeline, where you can edit audio clips, synchronize audio and video, and automate volume, pan, and other changes over time using envelopes. You can also record audio directly to a track in the Timeline. You mix multitrack projects in the Mixer, which includes a channel strip for each track, bus, and output in the project. In both the Timeline and the Mixer you can add and adjust professional-quality realtime effects, including compression, EQ, and reverb. You can export your project mix to an audio file or to a QuickTime movie, export using Compressor, and also export individual tracks, busses, and outputs.

In audio file projects, you can edit audio files in the Waveform Editor for tasks ranging from audio repair to sound design. In the Waveform Editor, you can perform precise edits down to the individual sample level. You can perform edits nondestructively using actions, which include processing effects and other operations, and can turn off or completely reorder actions. You can analyze audio files in the Waveform Editor for a range of common audio problems, including clicks and pops, hum, and phase issues, and automatically fix problems detected by analysis.

Soundtrack Pro is designed to work with Final Cut Pro and with other Apple professional applications, allowing you to send video and audio files back and forth between the applications as you work on both the video and the audio. Soundtrack Pro also includes a large selection of Apple Loops that you can use to add Foley effects, background ambience, sound effects, and music transitions to your projects. Apple Loops tagged as looping files automatically match the tempo and key of the project, allowing you to use them in the same project.

Soundtrack Pro includes the following features:

- *Powerful audio editing:* You can edit audio files nondestructively in the Waveform Editor. You can edit audio files graphically with sample accurate precision, and process files using actions, which can be reordered and turned on or off individually.
- *Analysis and repair of common audio problems:* The Waveform Editor features analysis of audio files. You can choose which problems to analyze the file for, then fix the problems detected by analysis either individually or in a single operation. Selected problems are highlighted in the waveform display for easy viewing.
- *Advanced mixing capabilities:* You can mix multitrack projects in the Mixer, which displays a virtual mixing console for a project. Using the channel strips in the Mixer, you can adjust levels, mute and solo tracks, and add realtime effects. You can create submixes using busses, and send audio to multiple physical outputs using outputs.
- *Add professional-quality effects:* Soundtrack Pro includes high-quality effects plug-ins from the Logic Pro effects library that you can use in your projects, including the Space Designer convolution reverb. You can also install third-party effects in the Audio Units plug-in format.
- *Record and edit automation:* You can record movements to sliders and other onscreen controls, play back the automation, and edit it in the Timeline.
- *Support for control surfaces:* In addition to recording movements of onscreen controls, you can connect a supported control surface, and record automation of control surface movements.

- *Synchronized video display:* You can add a video to a project and view it in the Video tab, or display the video on an external video monitor. Audio/video synchronization is accurate both onscreen and on the external monitor, up to HD resolutions. You can accurately place audio clips to sync with specific frames or points in time in the video.
- *Audio recording capability:* You can record audio directly in tracks in the Soundtrack Pro Timeline, including recording multiple takes.
- *Integrated workflow with Final Cut Pro:* You can send a clip from the Final Cut Pro Timeline to Soundtrack Pro and edit the clip in the Waveform Editor. When you save the clip, it is automatically updated in your Final Cut Pro project. You can also send clips or sequences to a Soundtrack Pro multitrack project.

Resources for Learning About Soundtrack Pro

This manual describes the Soundtrack Pro interface, commands, and menus, and gives step-by-step instructions for creating Soundtrack Pro projects and for accomplishing specific tasks. It also includes information on setting up your system and on audio basics. It is designed to provide the information you need to get up to speed quickly so you can take full advantage of the intuitive interface and powerful features of Soundtrack Pro.

If you want to start by learning how to set up audio hardware to use with Soundtrack Pro, read Chapter 1, “Setting Up Your System,” on page 13. If you want to learn about the features and controls in the Soundtrack Pro interface, read Chapter 2, “The Soundtrack Pro Interface,” on page 23. If you want to jump right in and start using the application, skip ahead to Chapter 3, “Getting Started With Soundtrack Pro,” on page 45. If you want to read about editing audio files in the Waveform Editor, turn to Chapter 7, “Working in the Waveform Editor,” on page 143.

In addition to this manual, Soundtrack Pro provides other sources of support.

Soundtrack Pro Onscreen User Manual

The Soundtrack Pro onscreen user manual allows you to access information directly onscreen while you're working in Soundtrack Pro. To view this information, choose Help > Soundtrack Pro User Manual. The Soundtrack Pro onscreen user manual is a fully hyperlinked version of the *Soundtrack Pro User Manual*, enhanced with many features that make locating information quick and easy.

- The homepage provides quick access to various features, including Late-Breaking News, the index, and the Soundtrack Pro website.
- A comprehensive bookmark list allows you to quickly choose what you want to see and takes you there as soon as you click the link.

In addition to these navigational tools, the Soundtrack Pro onscreen user manual gives you other means to locate information quickly:

- All cross-references in the text are linked. You can click any cross-reference and jump immediately to that location. Then, you can use the Preview Back button to return to where you were before you clicked the cross-reference.
- The table of contents and index are also linked. If you click an entry in either of these sections, you jump directly to that section of the user manual.
- You can also use the Find dialog to search the text for specific words or a phrase.

Apple Websites

There are a variety of Apple websites that you can visit to find additional information.

Soundtrack Pro Website

For general information and updates, as well as the latest news on Soundtrack Pro, go to:

- <http://www.apple.com/soundtrackpro>

Apple Service and Support Website

For software updates and answers to the most frequently asked questions for all Apple products, including Soundtrack Pro, go to:

- <http://www.apple.com/support/soundtrackpro>

You'll also have access to product specifications, reference documentation, and Apple and third-party product technical articles.

Other Apple Websites

Start at the Apple homepage to find the latest and greatest information about Apple products:

- <http://www.apple.com>

QuickTime is industry-standard technology for handling video, sound, animation, graphics, text, music, and 360-degree virtual reality (VR) scenes. QuickTime provides a high level of performance, compatibility, and quality for delivering digital video. Go to the QuickTime website for information on the types of media supported, a tour of the QuickTime interface, specifications, and more:

- <http://www.apple.com/quicktime>

FireWire is one of the fastest peripheral standards ever developed, which makes it great for use with multimedia peripherals, such as video camcorders and the latest high-speed hard disk drives. Visit this website for information about FireWire technology and available third-party FireWire products:

- <http://www.apple.com/firewire>

For information about seminars, events, and third-party tools used in web publishing, design and print, music and audio, desktop movies, digital imaging, and the media arts, go to:

- <http://www.apple.com/pro>

For resources, stories, and information about projects developed by users in education using Apple software, including Soundtrack Pro, go to:

- <http://www.apple.com/education>

Go to the Apple Store to buy software, hardware, and accessories direct from Apple and to find special promotions and deals that include third-party hardware and software products:

- <http://www.apple.com/store>

The way you set up your system depends on the audio equipment you plan to use.

You can use your computer's speaker or headphone jack to monitor the audio output from Soundtrack Pro. For better results, you may want to connect external monitors or speakers to your system, so that you can monitor the audio output at a higher level of quality. You may want to connect other external audio equipment such as an audio interface or a mixer, particularly if you plan to record your own audio in Soundtrack Pro.

- For information on system and hardware requirements, see the Read Before You Install document on the installation DVD.
- For information on installing the software, see the *Installing Your Software* booklet.

System Considerations

To achieve the most effective results, you should consider the following issues when setting up your system.

Processor Speed and RAM

Digital audio files require intensive processing by your computer. If you plan to work on longer or more complex projects, or use multiple effects plug-ins in your projects, a computer with a faster processor can facilitate your productivity.

Soundtrack Pro is optimized for use with computers that have a multiprocessor architecture. Working with Soundtrack Pro projects on a multiprocessor-equipped computer can make your workflow more efficient, especially when creating longer or more complex projects.

If you plan to work on large projects, it's useful to have extra random-access memory, or RAM, installed in your computer. Additional RAM allows you to play back more files simultaneously, use a greater number of effects plug-ins, and keep several multimedia applications open at the same time.

Hard Disk Space

It's also a good idea to have a large hard disk with plenty of available space to store the media (audio and video) files you use with Soundtrack Pro. As you work with the application, you'll likely want to acquire a large collection of sounds to use in your Soundtrack Pro projects. You can use audio files stored on a CD-ROM disc or other external media, but playback performance may not be as good as if the audio files are installed on a local hard disk, especially when using a large number of files.

If you store media files on an external hard disk, make sure the disk has a fast enough seek time and a high enough sustained data transfer rate for use with multimedia files. Consult the manufacturer's specifications.

Dedicated Hard Disk

If you plan to record your own audio in Soundtrack Pro, remember that every minute of stereo digital audio (recorded using a 44.1 kHz sample rate and 16-bit depth) requires roughly 10 MB of hard disk space. If you plan to record large amounts of audio, you may want to record to a dedicated hard disk.

Setting the Audio Input and Output

By default, Soundtrack Pro uses the input and output devices set in your computer's System Preferences for audio input and output. You can set the default input and output devices for Soundtrack Pro in the Recording pane of the Soundtrack Pro Preferences window, and change them for individual recording sessions in the Recording tab. For information on changing the default input and output devices Soundtrack Pro uses, see "Setting Soundtrack Pro Preferences" on page 75.

Adding Audio Units Plug-Ins to Your Computer

Soundtrack Pro includes an extensive set of professional-quality effects plug-ins. Soundtrack Pro uses effects in the Audio Units plug-in format, the native plug-in format of Mac OS X.

Audio Units plug-ins are also available from third-party manufacturers. When adding third-party effects to your computer, be sure to read the documentation, including any Read Me and installation files, that came with the plug-in. Supported Audio Units effects plug-ins appear in the Effects window under the manufacturer's name.

Soundtrack Pro does not support VST, ASIO, MAS, or RTAS effects plug-ins.

Connecting Audio Equipment

You can use a variety of audio equipment with Soundtrack Pro for both recording and playback. For information on connecting a specific piece of equipment to your computer, read the documentation that came with the equipment.

When using external audio devices, it's a good idea to connect them before opening Soundtrack Pro.

Soundtrack Pro does not support video input from devices such as camcorders or videocassette decks.

Audio Interfaces

You can connect an audio interface to your computer, and then connect microphones and musical instruments to the audio interface for recording. You can also connect output devices, such as monitors or speakers, a mixer, or an amplifier to the audio interface.

When choosing an audio interface, check the manufacturer's specifications to make sure the interface is compatible with Mac OS X v10.3. Some audio interfaces require driver software, while others are supported without the need for a driver. If the device requires a driver, make sure an up-to-date driver is included with the device, or is available from the manufacturer.

All digital audio interfaces can be susceptible to *latency*, a noticeable delay between the time the audio signal is produced and the time you hear it. When connecting an audio interface, you should connect the interface directly to the computer, rather than connecting it through a hub or daisy-chaining it through another device. Connecting an audio interface through a hub or an intermediary device can cause an unacceptable amount of latency, particularly with slower protocols such as USB.

Soundtrack Pro supports input from digital audio interfaces up to a maximum sample rate of 96 kHz and a maximum bit depth of 24 bits. If you connect an interface that uses sample rates or bit depths outside the range supported by Soundtrack Pro, an alert message appears, telling you that data from the audio interface is not compatible with the application.

FireWire (IEEE 1394)

FireWire is a professional and consumer standard for both audio and video equipment. The combination of fast data-transfer rates, high storage capacities, and plug-and-play connection makes FireWire an attractive choice for working with digital audio files. FireWire is included on all current Macintosh computers, and a number of FireWire audio interfaces are available.

There are two kinds of FireWire connectors: a 4-pin connector (typically found on video equipment) and a 6-pin connector (used for computer and audio equipment).

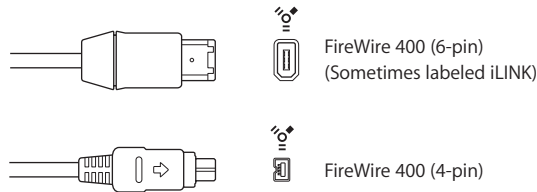

USB (Universal Serial Bus)

USB is a consumer standard used on computer peripherals and other devices. USB offers a lower data-transfer rate than FireWire, but supports plug-and-play operation and the ability to connect several devices in sequence (daisy-chaining). Some USB devices draw their power over the USB cable, while others require a separate power connection. USB is included on all current Macintosh computers.

There are two kinds of USB connectors: an A connector, typically used to connect a device to a USB hub, and a B connector, typically used to connect devices together, and also to connect a device to a computer. USB audio interfaces should always be directly connected to your computer, not connected via a hub or to the computer's display, keyboard, or another peripheral.



PCI (Peripheral Connect Interface)

PCI interfaces, unlike FireWire and USB interfaces, require that you install a dedicated sound card in your computer. PCI provides high bandwidth and fast data-transfer rates, allowing you to record and play back large numbers of files at the highest possible sample rates and bit depths.

PCMCIA

PCMCIA is a consumer standard for connecting devices to a laptop computer. PCMCIA provides a lower data-transfer rate than FireWire or USB, but provides a compact, affordable solution for connecting an audio interface to your computer, while keeping your USB and FireWire ports available for other devices. Most current Macintosh laptop computers support PCMCIA connections via a built-in card slot.

Audio Cabling

There are several types of audio cables and connectors used on professional and consumer audio equipment, at a range of prices and levels of quality. When connecting microphones and musical instruments to an audio interface or a mixer, make sure the interface has the proper input jacks for the type of connectors and cables you plan to use.

XLR

XLR cables and connectors are used on professional-quality microphones, monitors, and other musical equipment. They provide a high-quality, balanced signal at +4 dB level.



XLR connector (balanced)

1/4-Inch Audio

1/4-inch connectors (sometimes called “phone plugs”) are used on a wide variety of professional and consumer musical equipment, including musical instruments and amplifiers, speakers, and external effects devices. They can be either balanced (+4 dB) or unbalanced (–10 dB). Some devices require Tip-Ring-Sleeve (TRS) connectors to transfer the audio signal.

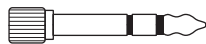

1/4-inch Tip-Ring Sleeve (TRS) connector

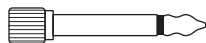

1/4-inch Tip-Ring (TR) connector

RCA

RCA connectors are used on consumer audio equipment such as home stereo systems and videocassette recorders.



Optical Digital (AES-EBU and S/PDIF)

AES-EBU and S/PDIF are both used to provide an optical digital connection to professional and consumer audio equipment, including audio interfaces, DAT (digital audio tape) machines, hardware samplers. Both carry a stereo digital signal. AES-EBU is balanced, and has an operating level of 5 volts, while S/PDIF is unbalanced and has an operating level of roughly 1/2 volt. There are adapter cables available to convert between the two protocols. S/PDIF carries additional information with the audio signal, including SCMS copy-protection information.



1/8-Inch Miniplug

Miniplug connectors are used for audio input and output to computers and on some consumer electronic devices, particularly portable ones.



Audio Output

Being able to monitor the audio output of your projects at a high level of quality is crucial to achieving professional results. In general, you should use the best output equipment your budget allows.

Speakers and Monitors

You can play back audio through your computer's speakers or headphone jack, but the audio output may not be high enough for you to evaluate your music at a professional level of quality. Connecting external speakers or monitors to your system allows you to hear the audio output with greater fidelity and a wider dynamic range. In general, you should use the highest-quality speakers or monitors you can afford in order to hear your projects at the highest level of audio quality.

For detailed information on connecting external speakers to your audio interface, see the documentation that came with the speakers.

Amplifiers

If you are recording audio from microphones, and are not running the microphone's signal through a mixer with a microphone pre-amplifier, you need to connect an amplifier to boost the microphone's signal before sending it to the computer. If you are connecting monitors or speakers that are not self-powered, you also need to connect them through an amplifier.

Mixers

Connecting a mixer to your system allows you to record audio from multiple microphones or instruments simultaneously, to play back the output from your computer through connected monitors or speakers, and to control the volume levels of both the audio input and output. Professional-quality mixers have a number of additional features, including equalization (EQ) controls, auxiliary sends and returns for adding external effects, and separate monitor and mix level controls. Mixers may also include inboard pre-amplification for microphones, making the use of a separate amplifier unnecessary.

Control Surfaces

Soundtrack Pro supports control surfaces that use the Mackie Control and Logic Control protocols. For information on connecting and using control surfaces, see Chapter 12, "Using Control Surfaces With Soundtrack Pro," on page 243.

Example Hardware Setups

The following sections provide several examples of different hardware setups.

Setting Up a System Using Powered Speakers

With this setup, you can monitor the audio output through a set of connected powered speakers.

This setup uses the following equipment:

- Your computer and display
- A set of powered speakers, including speaker wire and a power adaptor

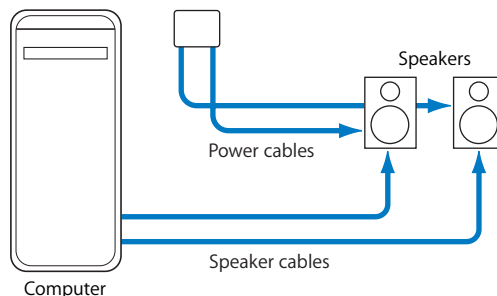

Setting Up a System Using a USB Audio Interface

With this setup, you can record audio input from microphones and musical instruments, and monitor audio output, through a USB audio interface.

This setup uses the following equipment:

- Your computer and display
- USB audio interface (from 2 to 8 channels) with USB cable to connect to your computer
- Microphone
- Musical instruments (guitar, bass, and keyboard)
- Cables to connect microphones and instruments to the audio interface
- Set of monitors or speakers

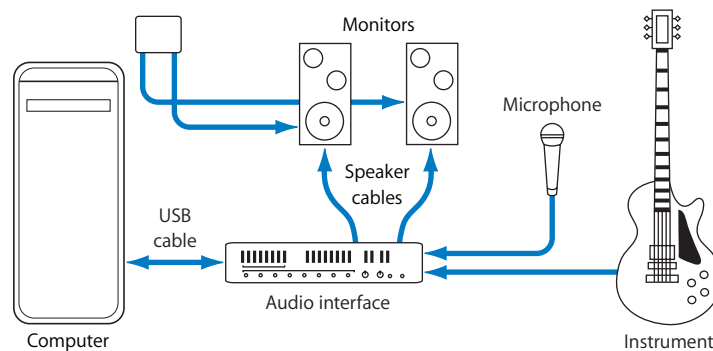

Setting Up a System Using a FireWire Interface and a Control Surface

With this setup, you can record audio input from several sources simultaneously, and monitor audio output channels independently, through a mixer connected to a FireWire audio interface.

This setup uses the following equipment:

- Your computer and display
- FireWire audio interface with FireWire cable to connect to your computer
- Control surface and MIDI interface with USB cable to connect MIDI interface to your computer
- MIDI cables to connect control surface to MIDI interface
- Set of powered monitors or speakers
- Speaker cables

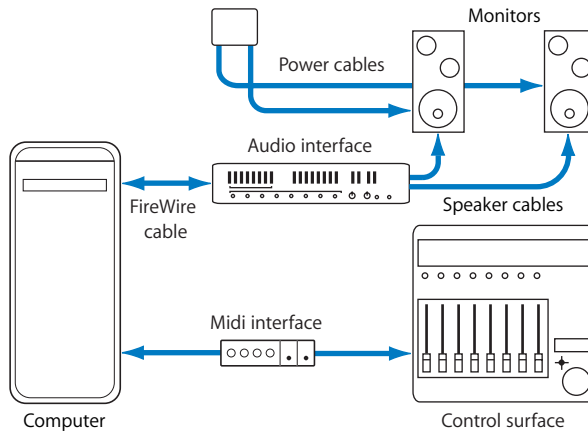

Setting Up a System Using a Video Output Device

With this setup, you can play video and audio through an external video output device. Because using a video output device can result in increased latency, you may want to combine this setup with an audio-only setup (as shown in the preceding pages), and switch between the two setups.

This setup uses the following equipment:

- Your computer and display
- Video output device (Firewire device or PCI card)
- High-quality video monitor
- Audio speakers

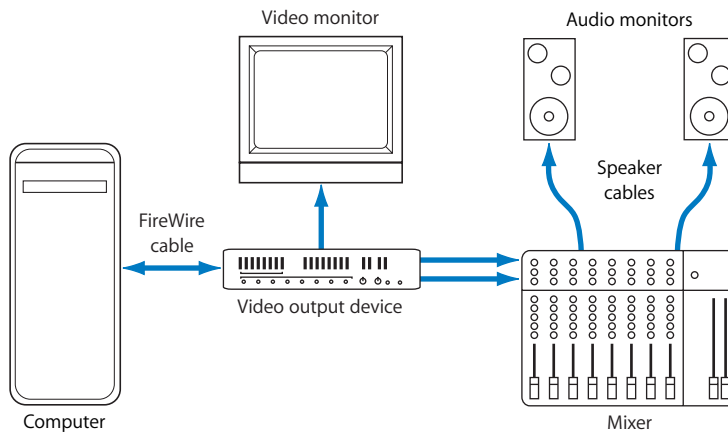

The Soundtrack Pro Interface

2

In Soundtrack Pro, you work in four main windows: the Project window, the Mixer, the Media and Effects Manager, and the Utility window.

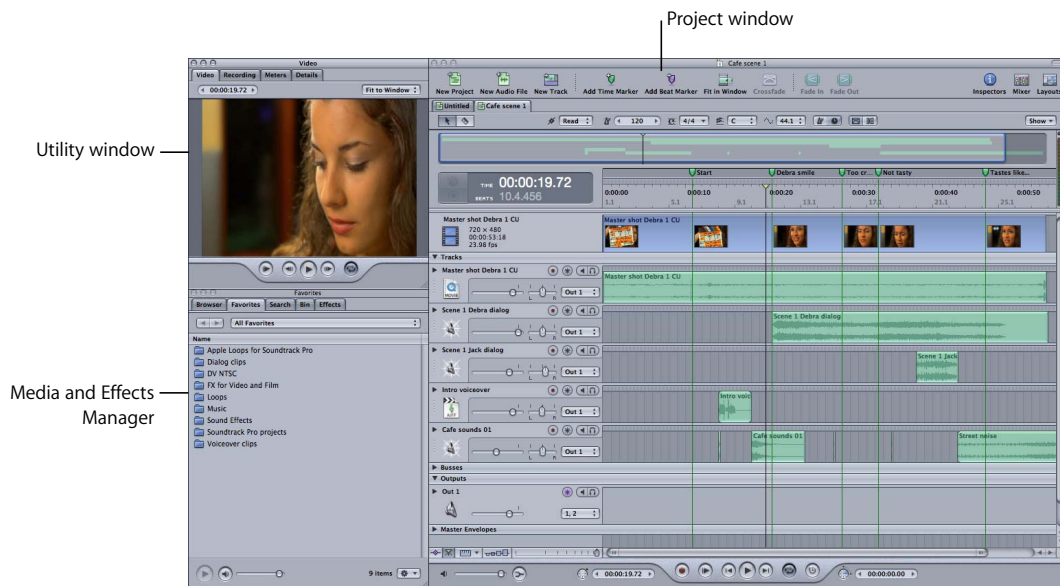

- The Project window includes the Timeline, where you arrange audio clips, and the Waveform Editor, where you edit audio files.
- The Mixer is where you mix multitrack projects. It includes channel strips for each track, bus, and output, as well as other controls.
- The Media and Effects Manager is where you locate and preview audio and video files to add to your project, and also where you add and adjust realtime effects.
- The Utility window has tabs where you can add and view a video in a project, see the master level meters, get details on clips and other items, and set up recording.

Project Window

The Project window is the “canvas” where you work on your projects. For multitrack projects, the Timeline is where you arrange and edit audio clips. For audio file projects, the Waveform Editor is where you edit audio files.

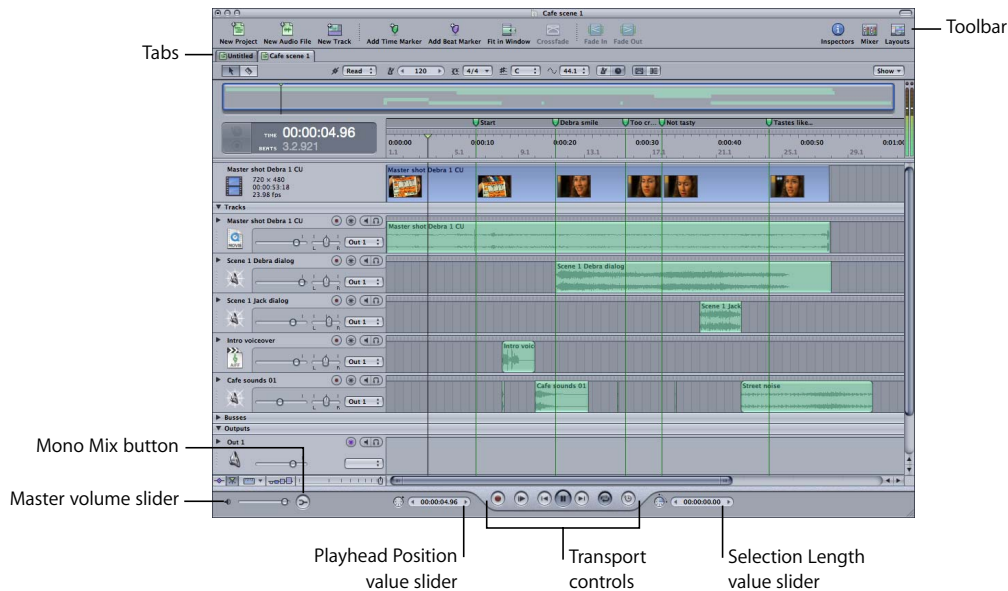

- **Toolbar:** Includes tools for common functions. You can customize which tools appear in the Toolbar.
- **Tabs:** You can switch between any projects open in the Timeline or Waveform Editor.
- **Transport controls:** Control playback and the position of the playhead, and turn recording on or off. (For more information, see “Transport Controls” on page 25.)
- **Master volume slider:** Adjusts the overall volume when you play the project. The volume level defaults to 0 dB when you create a project. Adjusting the master volume slider does not affect export volume.
- **Mono Mix button:** Click to listen to a temporary mono mix of the project.
- **Playhead Position value slider:** Displays the current playhead position. You can move the playhead by clicking the arrows, dragging, or typing a value.
- **Selection Length value slider:** Displays the length of the current Timeslice (in the Timeline) or selection (in the Waveform Editor). You can change the Timeslice or selection length by clicking the arrows, dragging, or typing a value.

Toolbar

The Toolbar is located at the top of the Project window. When you first open Soundtrack Pro, the Toolbar includes buttons for creating a new project, creating a new audio file, showing the Mixer and the Utility window, managing layouts, adding markers, and other common functions. You can customize the Toolbar, adding buttons for functions you want to access frequently. For information about customizing the Toolbar, see “Customizing the Toolbar” on page 49.



Transport Controls

You use the transport controls to control playback, set the position of the playhead, start recording, and activate the playback region.

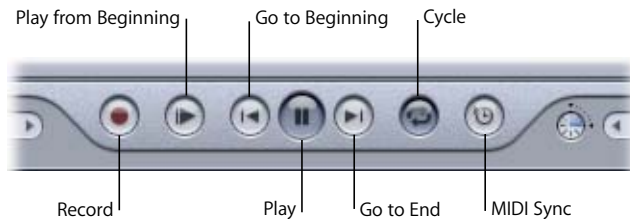

- *Record button*: Starts and stops the recording process.
- *Play from Beginning button*: Starts playback from the beginning of the project.
- *Go to Beginning button*: Moves the playhead to the beginning of the project, or to the beginning of the playback region if it is active.
- *Play/Pause button*: Starts playback at the current playhead position. If the project is playing, stops playback.
- *Go to End button*: Moves the playhead to the end of the project, or to the end of the playback region if it is active.
- *Cycle button*: Activates the playback region, if one is set in the Time ruler.
- *MIDI Sync button*: Synchronizes playback with incoming MIDI Clock and MIDI Timecode (MTC) signals.

For information on using the transport controls, see “Controlling Playback With the Transport Controls” on page 55.

Timeline

The Timeline gives you a visual representation of a multitrack project, showing the position of clips, the playhead, and other items in time. The Timeline is organized into three groups of horizontal rows called tracks, busses, and outputs. You can add and arrange audio clips in tracks, use busses to create submixes, and send audio to physical output channels using outputs. You can control the sound of each track, bus, and output using the controls in its header.

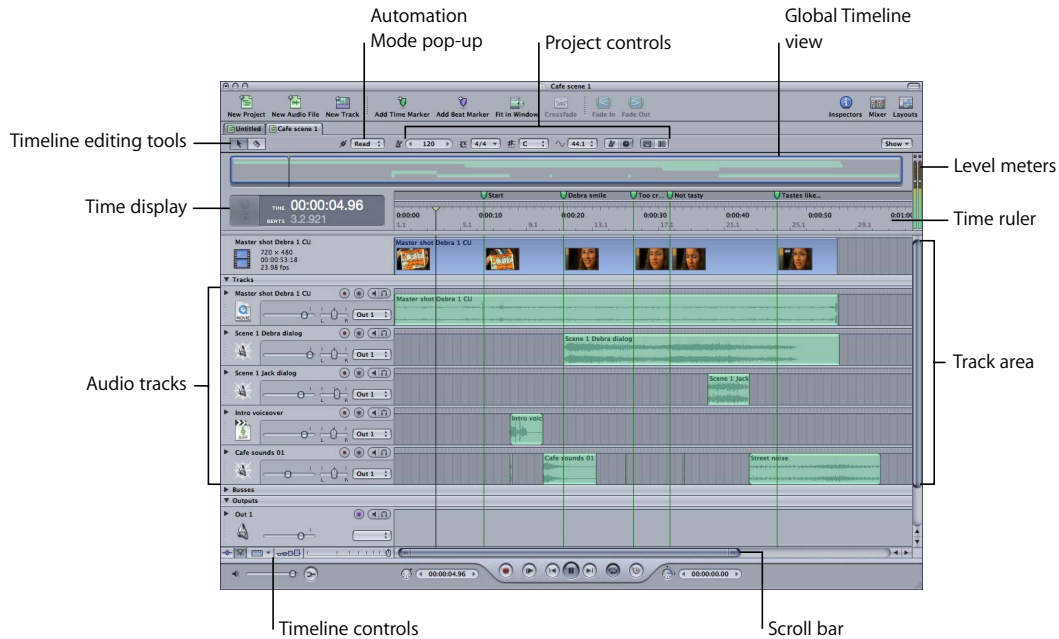

- *Timeline editing tools*: Select items using the Selection (arrow) tool, or split audio clips using the Split (razor) tool.
- *Automation Mode pop-up menu*: Choose the mode for recording automation using either the onscreen controls or an external control surface.
- *Project controls*: Set the project's time signature, tempo, key, sample rate, time format, and other properties using these controls.
- *Show pop-up menu*: Choose whether the video track, audio tracks, busses, outputs, and master envelopes are visible in the Timeline.
- *Global Timeline view*: Shows a miniature view of the entire Timeline and the playhead position, and lets you move quickly to different parts of a project.
- *Time display*: Shows the current playhead position in both Time-based and Beats-based formats. You can set the playhead by typing a new playhead position in the time display.

- *Level meters:* As the project plays, the level meters show the volume level of the first output (Output 1).
- *Time ruler:* You can precisely position clips, the playhead, and other items to a specific point in time (minutes, seconds, frames) or to a musical beat using the Time ruler.
- *Track area:* Includes horizontal rows for tracks, busses, and outputs. Also includes the playhead, envelopes, and markers.
- *Headers:* Each track, bus, and output has a header with an icon, name, volume slider, and other controls. (For more information, see “Headers” on page 27.)
- *Timeline controls:* Includes controls to show the master envelopes, turn snap on or off, set the track height, and zoom in or out. (For more information, see “Timeline Controls” on page 28.)
- *Scroll bar:* Moves the Timeline horizontally so you can see different parts of the project.

Headers

Each track, bus, and output in the Timeline has a header that includes the track name, track icon, and a set of track controls.

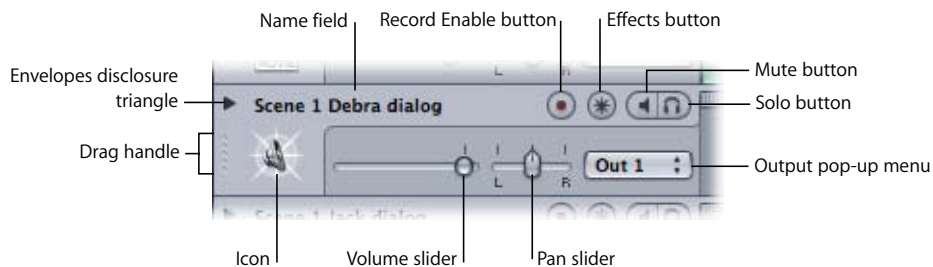

- *Drag handle:* Click to select the track, bus, or output and drag to reorder it in the Timeline.
- *Icon:* You can choose an icon for the track, bus, or output, making it easy to quickly distinguish them in a large project.
- *Name field:* You can type a new name for the track, bus, or output in the name field.
- *Record Enable button:* Enables (or disables) the track for recording when you click the Record button. Only tracks have Record Enable buttons, not busses or outputs.
- *Mute button:* Mutes (or unmutes) the track, bus, or output.
- *Solo button:* Solos (or unsolos) the track, bus, or output. Soundtrack Pro supports both multiple solo and exclusive solo.
- *Effects button:* Displays the Effects tab of the Media and Effects Manager with the track, bus, or output effects settings.
- *Envelopes disclosure triangle:* Shows the track, bus, or output envelopes in the area directly below the track.

- *Volume slider*: Sets the track, bus, or output relative volume in the overall mix.
- *Output pop-up menu*: Choose an output for the track or bus, or choose the physical output channels for the output from the menu.
- *Pan slider*: Sets the pan position of the track or bus. Appears in track and bus headers only, not in output headers.

For detailed information on using the track controls, see “Using the Track Controls” on page 102.

Timeline Controls

The lower-left corner of the Timeline contains controls for various aspects of Timeline display and operation.

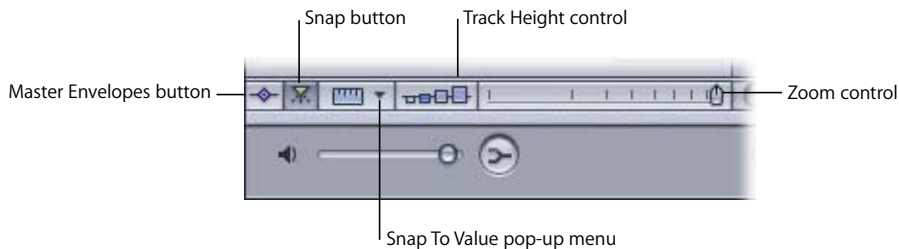

- *Master Envelopes button*: Shows or hides the master envelopes.
- *Snap button*: Turns snap on or off.
- *Snap To Value pop-up menu*: Sets the value to which items in the Timeline snap.
- *Track Height control*: Sets the height of tracks, busses, and outputs to one of four settings, from Reduced to Large.
- *Zoom control*: Click the control or drag the slider to change the zoom level. You can zoom in to edit clips precisely, or zoom out to display more of the Timeline.

For information about using master envelopes, see “Master Envelopes” on page 220. For information about snap, see “Using Snap” on page 72. For information about using the Track Height control and zoom control, see “Moving Around in the Timeline” on page 94.

Mixer

You mix your project in the Mixer. Each track, bus, and output has a channel strip in the Mixer with volume controls, mute and solo buttons, slots for adding effects, and other controls. You can view the levels for each track, bus, and output using level meters in its channel strip. You can also record audio and automate volume and pan changes in the Mixer.

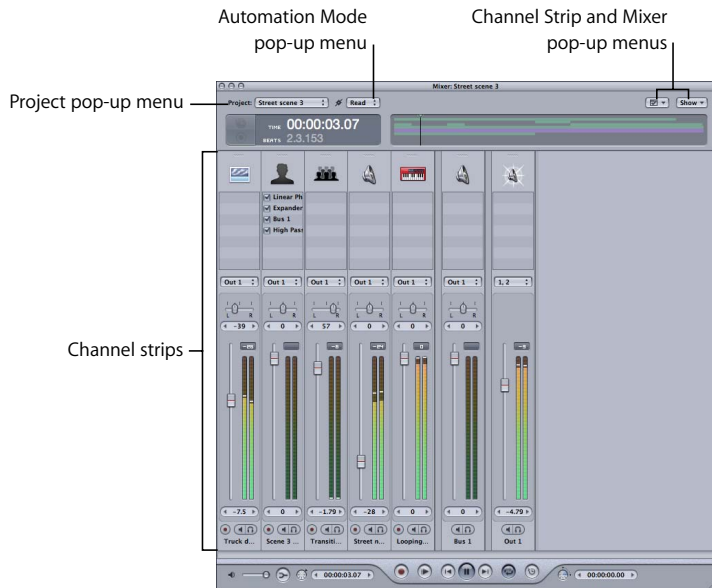

- *Project pop-up menu*: Choose which project to work on from the pop-up menu.
- *Automation Mode pop-up menu*: Choose the automation mode from the pop-up menu.
- *Channel Strip and Mixer pop-up menus*: Show or hide different sections of the channel strips and of the Mixer window.
- *Channel strips*: Each track, bus, and output has a channel strip with controls and level meters.

Each channel strip includes the following controls:

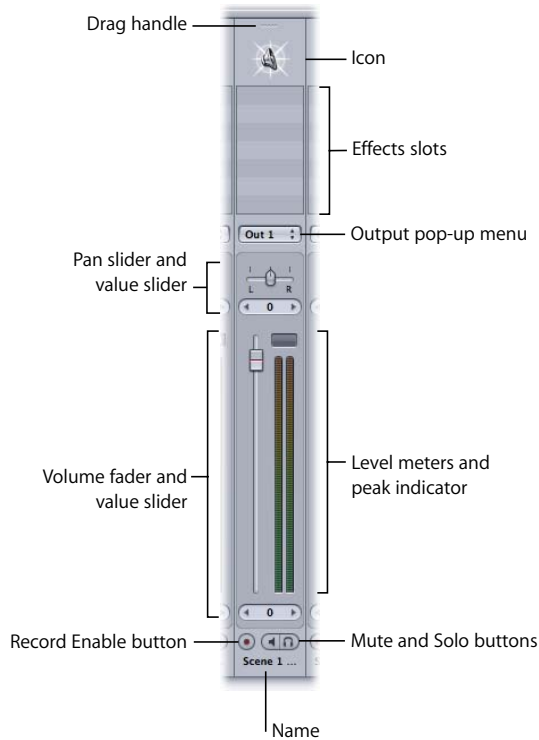

- *Drag handle:* Click to select the channel strip and drag to reorder it in the Mixer.
- *Icon:* Icons let you visually distinguish channel strips in the Mixer. Click an icon to change it.
- *Effects slots:* Show the effects and sends for the channel strip, and let you add effects and sends.
- *Output pop-up menu:* Choose an output for the track or bus channel strip or choose the physical output channels for the output channel strip from the menu.
- *Pan slider and value slider:* Set the channel strip's pan position by dragging the slider or changing the value in the value slider. You can automate pan changes by dragging the slider with the project set to the appropriate automation mode. Appear in track and bus channel strips only, not in output channel strips.
- *Volume fader and value slider:* Set the channel strip's volume level by dragging the fader or changing the value in the value slider. You can automate volume changes by dragging the slider with the project set to the appropriate automation mode.
- *Level meters with peak indicator:* Show the volume level of the channel strip in real time as the project plays. The peak indicator shows the highest level played, and changes color to indicate that clipping has occurred.

- *Record Enable button*: Click to enable the track for recording. When you click a track's Record Enable button, the Recording tab of the Utility window appears, showing the track's current recording settings. Appears in track channel strips only, not in bus or output channel strips.
- *Mute button*: Click to mute (or unmute) the channel strip.
- *Solo button*: Click to solo (or unsolo) the channel strip.
- *Name field*: You can type a new name for the channel strip.

Waveform Editor

You can edit audio files in the Waveform Editor using actions. Actions give you a powerful and flexible way to edit audio files nondestructively using professional audio processing effects and other operations. You can turn individual actions on or off, reorder actions, flatten actions, and compare the project with and without actions. You can also analyze audio files in the Waveform Editor and fix common audio problems, including clicks and pops, hum, and phase problems.

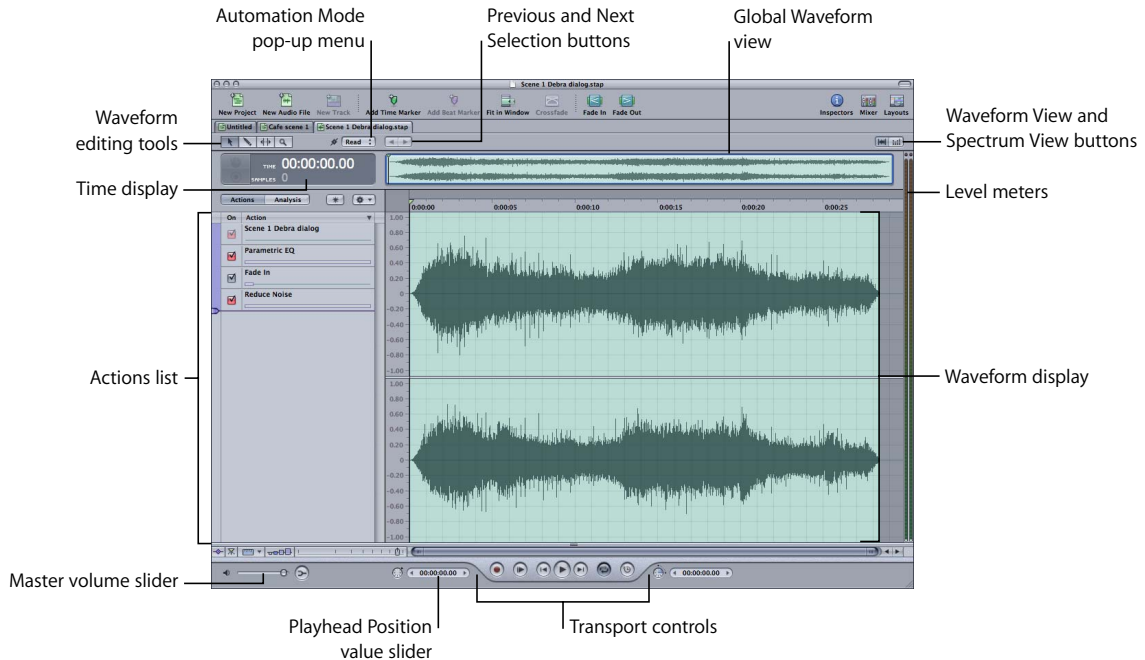

- *Waveform editing tools*: Includes the Selection, Sample Edit, Audio Stretching, and Zoom tools that you can use to graphically edit audio files.
- *Automation Mode pop-up menu*: Choose the automation mode from the pop-up menu.
- *Previous and Next Selection buttons*: Move back and forward through selections you've made in the waveform display.

- *Waveform View and Spectrum View buttons:* Change the display between Waveform view and Spectrum view.
- *Time display:* Shows the current position of the playhead.
- *Global Waveform view:* Shows you a miniature view of the entire waveform and the playhead position, and lets you move quickly to different parts of an audio file.
- *Waveform display (and editing area):* Shows the waveform of the audio file (or its frequency spectrum, in Spectrum view). You can select parts of the audio file to apply different actions to.
- *Level meters:* Show the levels of the audio file as it plays.
- *Transport controls:* Control playback and the position of the playhead, and turn recording on or off. (For more information, see “Transport Controls” on page 25.)
- *Playhead:* Shows the part of the audio file currently playing.
- *Actions and Analysis buttons:* Shows either the Actions list and related controls, or the Analysis Type, Parameter, and Analysis Results lists and related controls.

When the Actions button is active, the following items are available:

- *Effects button:* Shows the Effects tab, where you can add realtime effects to the project.
- *Actions pop-up menu:* Choose menu items to flatten actions, delete actions, and perform other operations.
- *Actions list:* Shows the actions you apply to the project.
- *Action Insert bar:* Shows where new actions will be added in the Actions list, and which actions are heard when you play the project.
- *Actions list:* You can add, select, and reorder actions in the list.

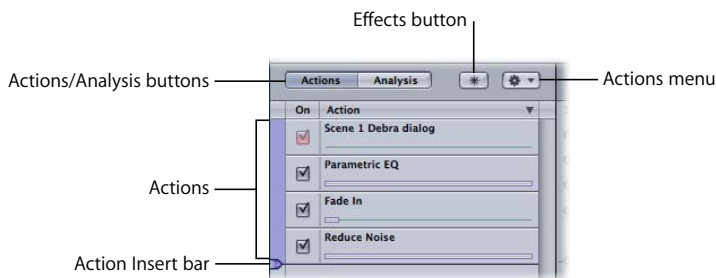

When the Analysis button is selected, the following items replace the Actions list:

- *Analysis Type list:* Lists the types of analysis you can select.
- *Parameters list:* Some analysis types (Click/Pop and Silence) have parameters you can adjust before analyzing the file. The parameters appear in this list.
- *Analyze button:* Click to analyze the file for the problems selected in the Analysis Type list.
- *Analysis Results list:* Lists items found by analyzing the file.

- *Clear Fixed button*: Removes fixed items from the Analysis Results list.
- *Magnify button*: Zooms in on the selected item in the Analysis Results list for as long as you hold down the button.
- *Fix All button*: Fixes all items in the Analysis Results list.
- *Fix button*: Fixes the selected items in the Analysis Results list.

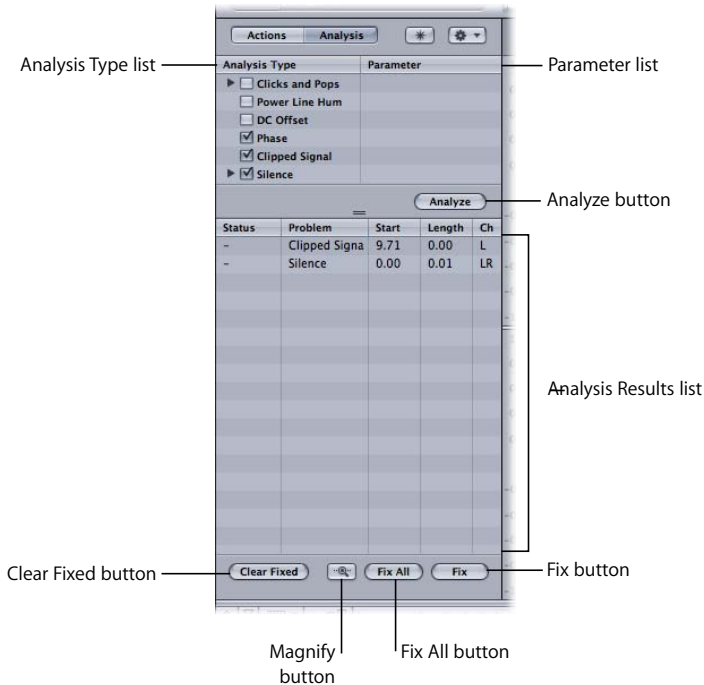

Media and Effects Manager

The Media and Effects Manager is where you locate and preview media (audio and video) to add to your project. It has five tabs: The Browser, Favorites, and Search tabs give you three different ways to find media files; the Bin gives you quick access to media files for the current project; and the Effects tab is where you add and adjust effects.

Browser Tab

The Browser tab displays the disks connected to your computer in a view similar to the Finder's list view. You can also preview files in the Browser tab, and drag them to the Timeline.

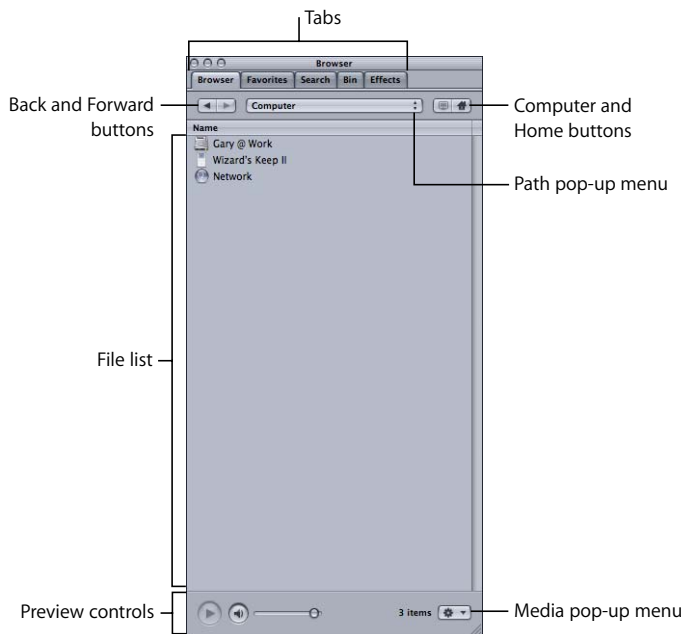

- *Back and Forward buttons:* Move through previously viewed levels of the folder hierarchy.
- *Computer button:* Displays your computer's hard disk and other storage media connected to your computer.
- *Home button:* Displays the contents of your home directory.
- *Path pop-up menu:* Displays the levels of the file path to the current location, letting you move back to a previous level.
- *File list:* Displays the files and folders at the current location.
- *Preview controls:* Include Play and Mute buttons and a volume slider. For information on using the Preview controls, see "Using the Preview Controls" on page 69.
- *Media pop-up menu:* Choose menu items to add a Favorite, add a file to the Bin, open a file in the Waveform Editor, and perform other functions.

Favorites Tab

You can store frequently used items in Favorites, so that you can easily access them directly. You can also preview files in Favorites, and drag them to the Timeline.

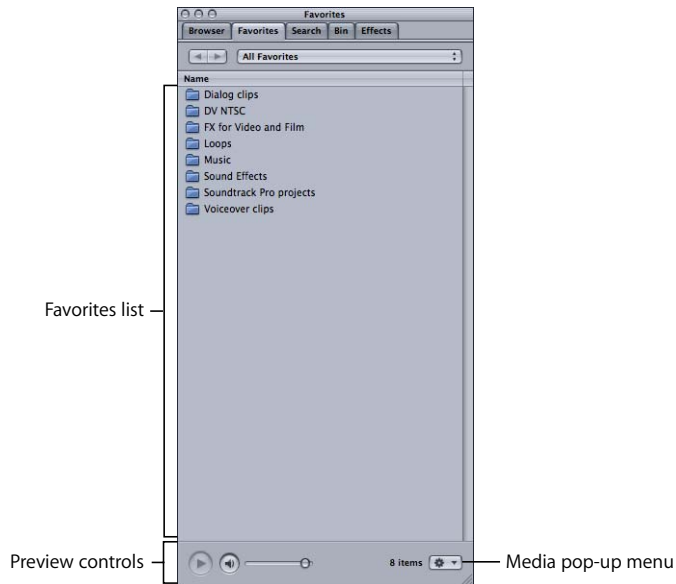

- *Back and Forward buttons*: Move through previously viewed levels of the folder hierarchy.
- *Path pop-up menu*: Displays the levels of the file path to the current location, letting you move back to a previous level.
- *Favorites list*: Displays the files and folders at the current location.
- *Preview controls*: Include Play and Mute buttons and a volume slider. For information on using the Preview controls, see “Using the Preview Controls” on page 69.
- *Media pop-up menu*: Choose menu items to remove a Favorite, add a file to the Bin, open a file in the Waveform Editor, and perform other functions.

Search Tab

The Search tab lets you locate audio files using a variety of criteria. You can perform text searches, and search for Apple Loops and other tagged file formats using keywords for instrument, genre, mood descriptors, and other categories. Matching files are displayed in the Search Results list. Once you locate the files you want to use, you can preview them in the Search Results list or drag them to the Timeline.

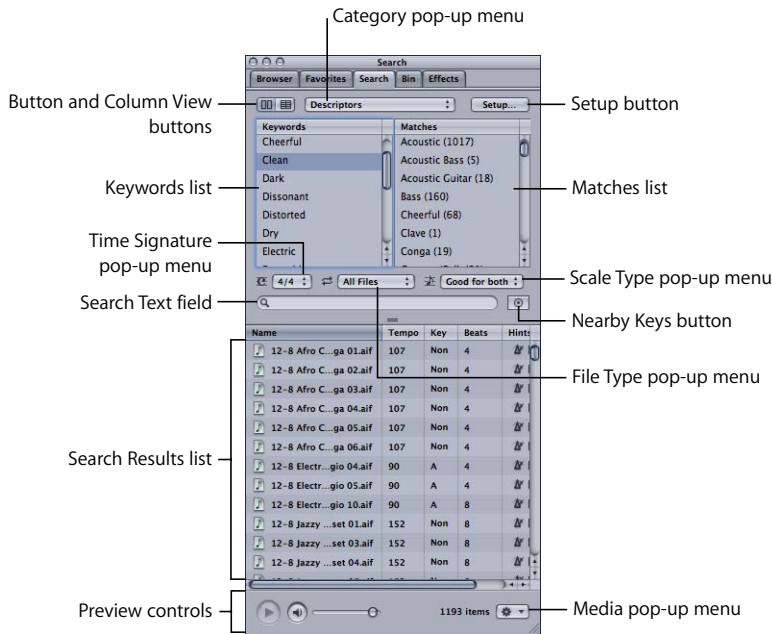

The Search tab has two views, Column view and Button view. Column view features a Keywords list containing keywords, and a Matches list with subcategories you can use to refine your searches. Button view displays a matrix of keyword buttons you can click to see matching files.

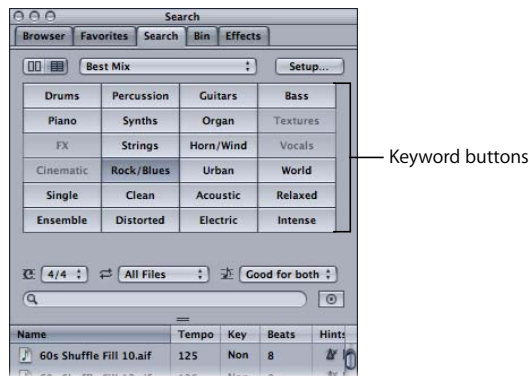

- *Button and Column view buttons:* Change the view to either Button or Column view.
- *Category pop-up menu:* Restricts the available keywords to a particular category.
- *Setup button:* Displays the Search Setup dialog, from which you add items to the Search database.
- *Time Signature pop-up menu:* Restricts search results to files with the selected time signature.
- *File Type pop-up menu:* Choose whether to display all files, or only looping or non-looping files.
- *Scale Type pop-up menu:* Restricts search results to audio files using the selected scale.
- *Keyword buttons (Button view only):* Displays files matching the keyword in the Results list.
- *Keywords list (Column view only):* Displays files matching the keyword in the Results list, and displays subcategories in the Matches list.
- *Matches list (Column view only):* Displays subcategories of the selected keywords.
- *Search Text field:* Type text in the field to display matching files whose filename or path contains the search text.
- *Nearby Keys button:* Restricts search results to keys within two semitones above or below the project key.
- *Search Results list:* Displays the files matching the selected search criteria, in alphabetical order. Includes columns displaying the tempo, key, and number of beats of each file. You can click files to preview them.
- *Add Favorite button:* Adds the selected item to Favorites.
- *Preview controls:* Include Play and Mute buttons and a volume slider. For information on using the Preview controls, see “Using the Preview Controls” on page 69.
- *Media pop-up menu:* Choose menu items to add a Favorite, add a file to the Bin, open a file in the Waveform Editor, and perform other functions.

Bin Tab

The Bin tab lists the media files added to the project. You can drag files from the Bin tab to the Timeline. You can also add files to the Bin for easy access in a project. Files not currently added to the project appear dimmed, and offline files appear in red text.

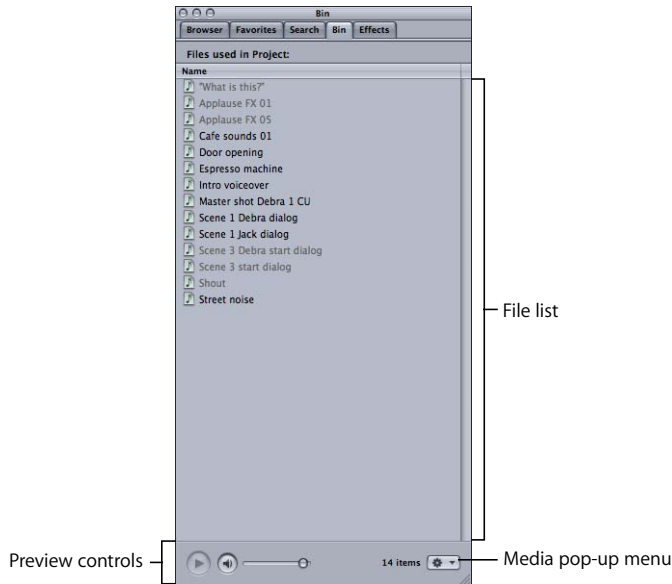

- *File list:* Displays the media files in the current project.
- *Preview controls:* Include Play and Mute buttons and a volume slider. For information on using the Preview controls, see “Using the Preview Controls” on page 69.
- *Media pop-up menu:* Choose menu items to add a Favorite, add a file to the Bin, open a file in the Waveform Editor, and perform other functions.

Effects Tab

You add effects and sends to your project and adjust effect parameters in the Effects tab. When you click the Effects button on a track, bus, output, or audio file project, the Effects tab appears showing the item's current effects settings and sends.

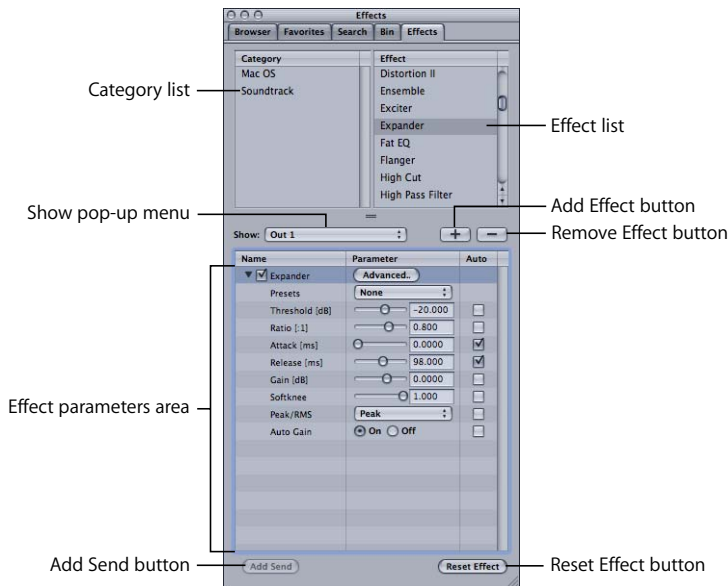

- *Category list*: Lists the categories of available effects, which are categorized by manufacturer. Click a category to see the effects for that category in the Effect list.
- *Effect list*: Lists the effects in the selected category. Double-click an effect to add it to the track, bus, or output.
- *Show pop-up menu*: Choose an item (a track, bus, or output) from the Show pop-up menu to display its effects settings.
- *Add Effect (+) button*: Adds the selected effect to the current effects chain.
- *Remove Effect (-) button*: Removes the selected effect from the current effects chain.
- *Effect Parameters area*: Displays the parameters for effects in the current effects chain. Click an effect's disclosure triangle to see its parameters. You can adjust effect parameters using the controls in the Effect Parameters area.
- *Add Send button*: Adds a send to the end of the current effects chain for the track. You can add sends only to tracks, not to busses or outputs.
- *Reset Effect button*: Resets the selected parameter or group of parameters to its default value (or values).

Utility Window

The Utility window features tabs for viewing a video in a project, observing project levels, viewing details, and setting up recording.

Video Tab

The Video tab is where you add a video to a project, view the video, and control video playback.

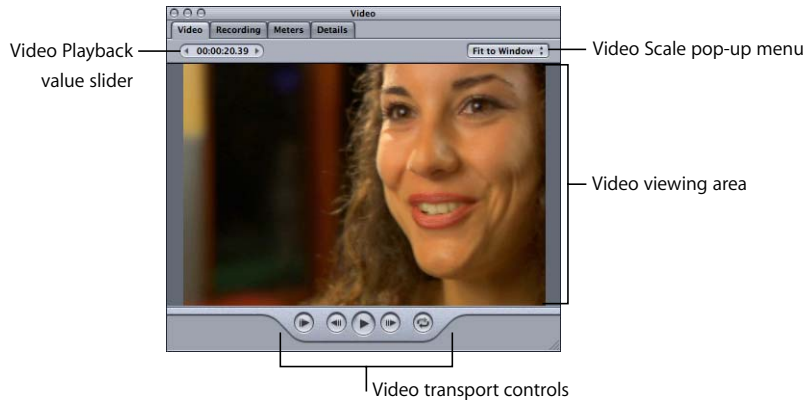

- *Video Playback value slider:* Move the video to a specific frame by dragging, clicking the left or right arrow, or double-clicking and typing a value in the value slider.
- *Video Scale pop-up menu:* Choose the scale of the video in the Video tab from the pop-up menu.
- *Video viewing area:* You add a video by dragging it into the viewing area, and watch it play in the viewing area.
- *Video transport controls:* You control playback of the video with the project using the Play from Beginning, Previous Frame, Play/Pause, Next Frame, and Cycle buttons.

Recording Tab

The Recording tab is where you edit a track's recording settings. When you click a track's Record Enable button, the Recording tab appears, displaying the track's current recording settings.

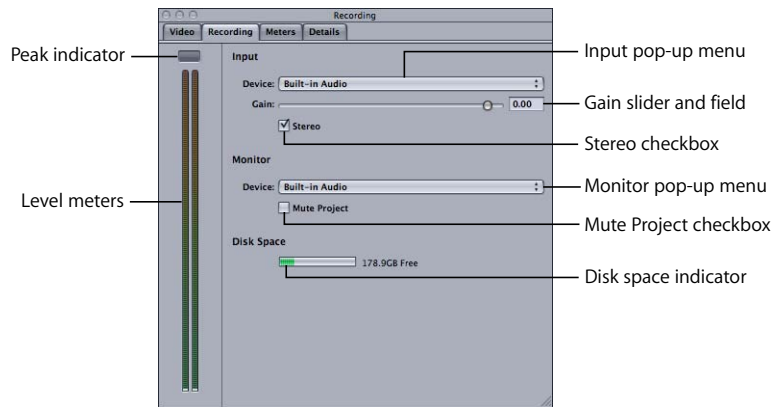

- *Peak indicator*: Shows the highest level reached by the recording input signal. If the level rises above 0 dB, the peak indicator becomes red to indicate clipping.
- *Level meters*: Show the input volume for the selected track during recording.
- *Input pop-up menu*: Choose the input device and input channel (or channels) for recording.
- *Gain slider and field*: Drag the slider or type a number in the field to set the input gain for recording.
- *Stereo checkbox*: Select to record to a stereo file, or deselect to record to a mono file.
- *Monitor pop-up menu*: Choose the output device and output channel (or channels) for monitoring during recording.
- *Mute Project checkbox*: Select to mute the project during recording, so you hear only the sound being recorded.
- *Disk space indicator*: Shows the available disk space on the recording sessions location set in Recording Preferences.

Meters Tab

The Meters tab displays stereo level meters that you can use to observe the volume of the first output in a multitrack project or the overall output for an audio file project.

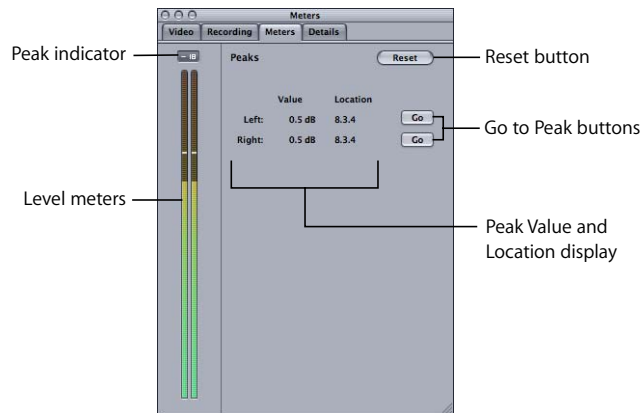

- *Peak indicator:* Shows the highest level reached as the project plays. If the level rises above 0 dB, the peak indicator becomes red to indicate clipping.
- *Level meters:* Show the output volume of the overall project as the project plays.
- *Peak Value and Location display:* For each channel, displays the highest (peak) value played, and its location.
- *Go to Peak buttons:* Move the playhead to the channel's peak.
- *Reset button:* Resets the Peak Value and Location display and the peak indicator to their default values.

Details Tab

The Details tab shows information about the currently selected media file, clip, marker, or envelope point, and gives you a way to edit clip, marker, and envelope point details. You can also view and edit details for a selection in the Waveform Editor.

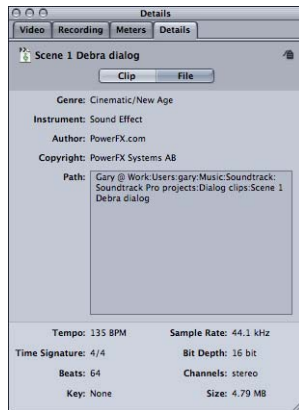

File Details

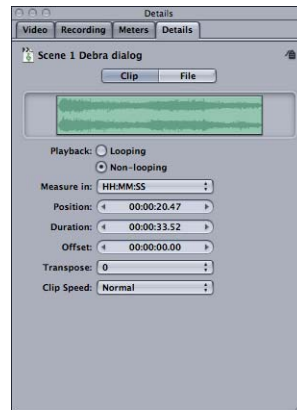

Clip Details

Audio File Details

When you select an audio file, the Details tab displays information about the file, including the file icon, hints, tags for Apple Loops and other tagged audio files, sample rate, bit depth, file size, and whether the file is a looping or non-looping file.

Video File Details

When you select a video file, the Details tab displays information about the file, including the dimensions of the video, file size, length in seconds, frame rate, and other information. You can preview the video file in the Details window by clicking the Play button in the Media and Effects Manager preview controls.

Clip Details

- *Clip display:* Displays the waveform of the selected clip.
- *Playback buttons:* Set the clip playback mode to looping or non-looping.
- *Measure in pop-up menu:* Sets the units shown in the Position, Duration, and Offset value sliders.
- *Position value slider:* Set the position (start point) of the selected clip.
- *Duration value slider:* Set the duration (length) of the selected clip.
- *Offset value slider:* Set the offset of the selected clip.
- *Transpose pop-up menu:* Choose the number of semitones to transpose a looping clip from the pop-up menu.
- *Clip Speed pop-up menu:* Choose the clip playback speed for a looping clip from the pop-up menu.

Marker Details

- *Type buttons*: Select whether the marker is a Beat marker or a Time marker.
- *Name field*: Type a name for the marker.
- *Position value slider*: Set the time position of the selected marker.
- *Measure in pop-up menu*: Choose the units for setting the marker position.

Envelope Point Details

- *Position value slider*: Set the time position of the selected envelope point.
- *Value value slider*: Set the value of the selected envelope point.
- *Measure in pop-up menu*: Sets the units shown in the Position value slider.
- *Copy from Previous Point button*: Set the value of the selected envelope point to the value of the preceding one in the envelope.
- *Copy from Next Point button*: Set the value of the selected envelope point to the value of the next one in the envelope.

Waveform Editor Selection Details

- *Measure in pop-up menu*: Sets the units shown in the Beginning, End, and Duration value sliders.
- *Beginning value slider*: Set the start position of the selection.
- *End value slider*: Set the end position of the selection.
- *Duration value slider*: Set the duration (length) of the selection.

This chapter describes the two kinds of projects you can create in Soundtrack Pro, and describes how to work with windows, use layouts, play projects, and set Soundtrack Pro preferences.

Two Kinds of Projects

You can use Soundtrack Pro to create and work with two kinds of projects: multitrack projects and audio file projects. The two project types have different project properties, and appear with different icons in the Finder. Multitrack projects and audio file projects appear as tabs in the Project window.

Multitrack Projects

Multitrack projects let you arrange audio clips in tracks in the Timeline and synchronize them to a video clip. You add clips to the Timeline from the Media and Effects Manager or from the Finder, and can also record audio directly into tracks. Each track has controls you can use to adjust volume and pan, mute or solo the track, add effects, and adjust effect parameters. The Timeline also includes busses and outputs with similar controls. You can automate volume, pan, and other controls using envelopes in the Timeline.

You mix a multitrack project in the Mixer, which features a channel strip for each track, bus, and output in the Timeline. You can adjust volume and pan, mute and solo channel strips, record audio, and record automation in the Mixer. As you work on a multitrack project, you can view it in both the Timeline and the Mixer and switch between the two.

You can export a project mix to an audio file, which you can import into Final Cut Pro or another application. You can also export selected tracks, busses, and outputs, or export a project using the Compressor application.

For information about creating, saving, and working with multitrack projects, see Chapter 4, “Working With Multitrack Projects,” on page 81. For information about working in the Timeline, see Chapter 5, “Working in the Timeline,” on page 93. For information about working in the Mixer, see Chapter 6, “Working in the Mixer,” on page 123.

Note: For multitrack projects, the audio files used in a project are not stored as part of the project file. The project file only saves references (pointers) to their location on disk. This keeps the size of the project file relatively small, and lets you use an audio file in multiple projects.

Audio File Projects

Audio file projects let you edit individual audio files using the powerful *actions* feature in the Soundtrack Pro Waveform Editor. Actions let you process an audio file or a selection nondestructively using a set of professional audio effects, perform noise reduction, add ambient noise, and perform other tasks. You can turn individual actions on or off, reorder actions, and bounce realtime effects to an action. You can analyze audio files for common problems, including clicks and pops, hum, and clipped signals, and have Soundtrack Pro fix the analyzed problems automatically. You can also cut, copy, and paste audio in the Waveform Editor. You can save an audio file as an *audio file project*, which lets you change action settings when you reopen the project in Soundtrack Pro.

For information about creating, saving, and working with audio file projects in the Waveform Editor, see Chapter 7, “Working in the Waveform Editor,” on page 143.

Setting Up Your Workspace

There are several ways you can set up the Soundtrack Pro workspace to suit your display size and workflow, whichever type of project you are creating. You can arrange windows, reorder and detach tabs in the Utility window and the Media and Effects Manager, and add and reorder buttons in the Toolbar. You can create layouts for different tasks and switch between them.

Basic Window Controls

You can move, resize, or minimize a project's windows. Most windows feature tabs, which give you flexibility in arranging the visual elements of a project.

To move a window:

- Drag the window by its title bar to a new location.

To resize a window, do one of the following:

- Drag the Size control in the lower-right corner of the window until the window is the desired size.
- Hold the pointer near the edge of a window until it becomes a Resize Window pointer, then drag the window edge left or right to resize adjacent windows together.

To minimize a window to the Dock:

- Click the minimize button in the window's title bar.

To close a window:

- Click the window's close button (or press Command-W with the window active).

Using Tabs

Soundtrack Pro uses tabbed windows so you can quickly access different project views and controls. You can switch between projects and between different controls in the Media and Effects Manager and the Utility window. Clicking the tab you want makes it active and brings it to the front. You can reorder the tabs in a window to easily access the tabs you use frequently.

To reorder tabs:

- Drag a tab left or right in the window's tab area.



You can also detach a tab from its docked position in the Utility window or the Media and Effects Manager, which creates a separate draggable, resizeable window for the tab. For example, you can drag the Bin tab to a new location so that you can easily move items from the Browser tab to the Bin tab.

To detach a tab from the Utility window or the Media and Effects Manager:

- Drag the tab out of its docked position in the window to create a separate window for the tab.

To reattach a tab:

- Drag the tab back to its original location at the top of its originating window.

Using Project Layouts

Soundtrack Pro lets you save and recall preset window arrangements called *layouts*, so that you can optimize your workspace for different tasks and different display sizes. You can show, hide, and resize windows, then save each window arrangement as a layout.

To save a project layout:

- 1 Arrange the application windows as you want them to appear.
- 2 Choose Window > Save Layout.
- 3 In the Save dialog, type a name for the layout, then click Save.

The layout is saved, and appears in the Layouts submenu.

To switch to a saved project layout:

- Choose Window > Layouts, then choose the layout you want to use from the submenu.

To delete a saved layout:

- 1 Choose Window > Manage Layouts.
- 2 In the Manage Layouts dialog, select the layout you want to delete.
- 3 Click the – (minus) button to delete the layout, then click Done.

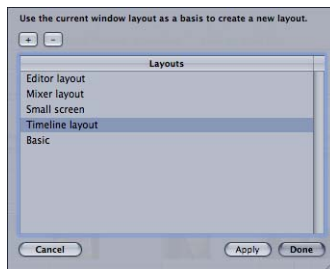

Customizing the Toolbar

The Toolbar at the top of the Project window contains buttons for frequently used commands. You can customize the Toolbar, adding buttons for the actions you use most often, and can return to the default set later.



The default set of Toolbar buttons includes buttons for creating new projects, opening project windows and tabs, adding markers, and other common commands. You can customize the Toolbar with additional buttons for adding fade ins and fade outs, processing an audio file, playing the current project through a video output device, and other commands. You can also hide the Toolbar to maximize available screen space. You customize the Toolbar by dragging items from the Customize sheet to the Toolbar.

To show the Customize sheet, do one of the following:

- Choose View > Customize Toolbar.
- Control-click the Toolbar, then choose Customize Toolbar from the shortcut menu.

The Customize sheet appears, and spaces between buttons in the Toolbar are outlined in gray.

To add a button to the Toolbar:

- Drag a button from the Customize sheet to the Toolbar.

If you drag a button between two existing buttons, the buttons move to make room for the new button.

To move a button in the Toolbar:

- Command-drag the button to a new location on the Toolbar.

You can also rearrange the Toolbar using set-width spaces, flexible spaces, and separators.

To add space or a separator to the Toolbar:

- Drag a space, flexible space, or separator from the Customize sheet to the Toolbar.

To return the Toolbar to the default set of buttons:

- Drag the default button set, located at the bottom of the Customize sheet, to the Toolbar.

You can also change the Toolbar so that it shows only icons or only text.

To show only icons in the Toolbar, do one of the following:

- Control-click the Toolbar, then choose Icon Only from the shortcut menu.
- In the Customize sheet, choose Icon Only from the Show pop-up menu.

To show only text in the Toolbar, do one of the following:

- Control-click the Toolbar, then choose Text Only from the shortcut menu.
- In the Customize sheet, choose Text Only from the Show pop-up menu.

To show both icons and text in the Toolbar, do one of the following:

- Control-click the Toolbar, then choose Icon & Text from the shortcut menu.
- In the Customize sheet, choose Icon & Text from the Show pop-up menu.

To dismiss the Customize sheet:

- When you are finishing customizing the Toolbar, click Done.

To hide the Toolbar:

- Choose View > Hide Toolbar. When the Toolbar is hidden, the menu item becomes Show Toolbar.

Playing Projects

You can play both multitrack and audio file projects as you work, so you can hear the audio in the project along with the changes you've made.

To play the project:

- Click the Play button in the transport controls (or press the Space bar). Click the Play button (or press the Space bar) again to stop playback.

As the project plays, the playhead shows the point in the project currently playing.

Soundtrack Pro lets you set the playhead and control playback of your projects in several different ways. You can use the transport controls or keyboard commands to start and stop playback and set the playhead to different points in time. You can also set a playback region to repeat playback of a specific part of the project.

Setting the Playhead

The playhead appears as a thin black line running vertically through the Timeline in multitrack projects, and through the waveform display in audio file projects. Where it crosses the Time ruler, the top of the playhead has a triangular handle that makes it easier to see its position onscreen and drag the playhead.

To set the playhead, do one of the following:

- Click anywhere in the Timeline (in a multitrack project) or the waveform display (in an audio file project) to set the playhead to that position.
- Drag the triangular handle at the top of the playhead to the position you want to set it. As you drag the playhead, you hear the audio at the current playhead position.

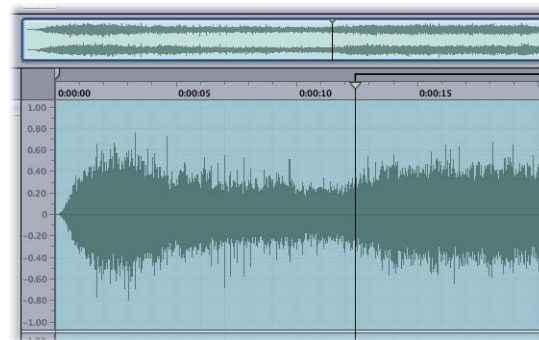

Drag the playhead where you want it or click in the waveform display.

When you set the playhead, it snaps to the nearest Snap To position if snap is turned on. For information on setting the Snap To value, see “Using Snap” on page 72. You can also set the playhead using the transport controls or using the Playhead Position value slider.

Setting the Playhead Using the Time Display

When a project is playing, the Time display constantly updates to show the current position of the playhead in both Time-based and Beats-based formats. You can also set the playhead to a new position by entering the position in the Time display.

The arrangement of the Time-based and Beats-based positions in the Time display changes depending on the time format of the project. The position matching the time format of the project appears in large, white numerals in the upper part of the Time display, and the other position appears below it in smaller, gray numerals. Each position is labeled for quick visual recognition.

For information on setting the project time format, see “Setting Project Properties” on page 82.

To set the playhead using the Time display:

- Select either the Time or Beats position in the Time display, then enter a new position. You can select the entire position or part of the position.

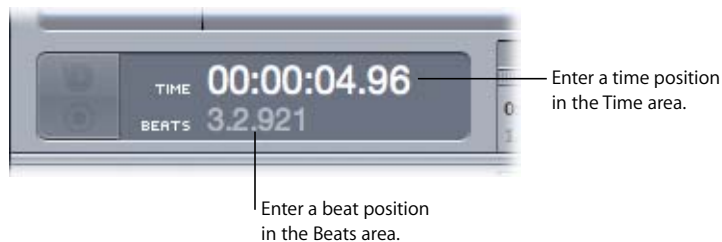

Entering Time-Based Units

When you set the playhead by entering a Time-based position in the Time display, you don't need to enter all of the punctuation. Soundtrack Pro automatically adds the correct punctuation for the format of the Time display.

For example:

- If you enter 01234321, and the Time ruler units are set to seconds, Soundtrack Pro interprets it as 01:23:43:21. This stands for 1 hour, 23 minutes, 43 seconds, and 21/100 of a second.

If you enter a partial number, Soundtrack Pro formats it with the rightmost pair of numbers as fractions of a second (or frames if a timecode format is selected), and with each successive pair of numbers to the left as seconds, minutes, and hours. Numbers omitted from a complete time position are interpreted as zeros. For best results, always enter delimiters to separate each division of time.

For example:

- If you enter 01.23, and the Time ruler units are set to seconds, Soundtrack Pro interprets it as 00:00:01.23. This stands for 1 second and 23/100 of a second.
- If you enter 0.12.34, Soundtrack Pro interprets it as 00:00:12.34. This stands for 12 seconds and 34/100 of a second.

You can select only part of the position in the Time display and enter a new number for that position. For example, you can select only seconds, or minutes and seconds. The other categories keep their present values. You can enter a time position in timecode format, in a way similar to the way you enter timecode in Final Cut Pro.

Entering Beats-Based Units

When you set the playhead by entering a Beats-based position in the Time display, you enter periods between numbers to separate measures, beats, and beat divisions. Soundtrack Pro fills out the digits in the beat division category with zeros.

For example:

- If you enter 123, Soundtrack Pro interprets it as 123.1.000. This stands for the 123rd measure, 1st beat, with no added beat divisions.
- If you enter 12.3, Soundtrack Pro interprets it as 12.3.000. This stands for the 12th measure, the 3rd beat, with no added beat divisions.
- If you enter 1.2.3, Soundtrack Pro interprets it as 1.2.300. This stands for the 1st measure, the 2nd beat, and 300/1000ths of a beat (because each beat division is 1/1000 of a beat).

You can select only part of the position in the Time display and enter a new number for that position. For example, you can select only measures, or measures and beats. The other categories keep their present values.

Setting the Playhead Using the Playhead Position Value Slider

Below and to the left of the transport controls is the Playhead Position value slider. When a project is playing, the Playhead Position value slider constantly updates to show the current position of the playhead. You can set the playhead by entering a new position in the Playhead Position value slider.

The units shown in the Playhead Position value slider depend on the project time format. For projects set to Time-based time format, the units appear as timecode, using the currently selected Time ruler units. For projects set to Beats-based format, the units appear as measures, beats, and beat divisions at the current tempo.

You can change the value in a value slider in one of several ways: you can enter a new value, by changing the value incrementally using the Decrement and Increment arrows, or by dragging the slider left or right.

To change the playhead position by entering a value:

- 1 Double-click the value slider.

The value slider becomes a value field, with the current value selected.

- 2 Type a new value into the field, using appropriate punctuation.
- 3 Press Tab or Enter to confirm the new value.

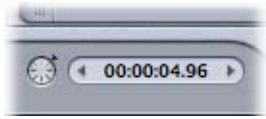

To change the playhead position in increments:

- Click the Decrement arrow to move the playhead left (earlier in time) in increments, or click the Increment arrow to move the playhead right (later in time) in increments.

To change the playhead position by dragging:

- Click in the center area of the value slider (where the numbers are), then drag left to move the playhead left (earlier in time) or drag right to move it right (later in time).

For projects set to Time-based time format, the Decrement and Increment arrows move the playhead in seconds. For projects using Beats-based time format, the arrows move the playhead in beats.

Scrubbing a Project

You can scrub a multitrack project in the Timeline or scrub an audio file project in the Waveform Editor. *Scrubbing* the project lets you hear the audio at the playhead position as you drag the playhead, so you can find a particular sound or event in the audio file.

To scrub a project:

- In the Timeline or the Waveform Editor, drag the playhead left or right at the speed you want to scrub the audio file.

You can also scrub a selection in the Waveform Editor, which is useful for determining where you want the selection to end.

To scrub a selection in the Waveform Editor:

- Hold down the Control key as you select part of an audio file.

As you drag, you hear the selection.

Controlling Playback With the Transport Controls

You use the transport controls to control playback of your project. The transport controls let you set the playhead to various points in time, start and stop playback, activate the playback region, and start a recording session to record your own audio.

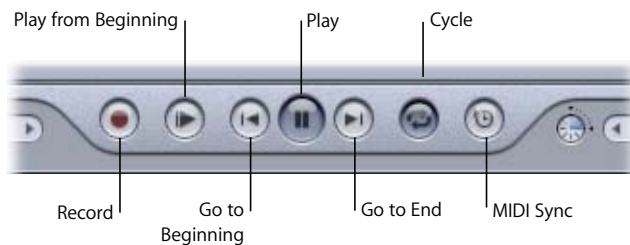

- *Record*: Starts recording at the playhead position on the track you have enabled for recording. If no track is enabled, a new track is created when recording starts.
- *Play from Beginning*: Starts playback from the beginning of the project. Playback begins immediately, whether the project is playing or is stopped when you click the button.
- *Go to Beginning*: Sets the playhead to the beginning of the project. If the playback region is active, and the playhead is after the beginning of the playback region in time, the playhead is set to the beginning of the playback region.
- *Play*: Starts playing back the project from the current playhead position. Clicking the Play button again stops playback at the current playhead position.
- *Go to End*: Sets the playhead to the end of the project. If the playback region is active, and the playhead is before the end of the playback region in time, the playhead is set to the end of the playback region.
- *Cycle*: If a playback region is set, clicking the Cycle button toggles whether the playback region is active or inactive. If no playback region is set, clicking the Cycle button sets the project to repeat from the beginning when the playhead reaches the end of the project. For information on setting the playback region, see “Working With the Playback Region” on page 98.
- *MIDI Sync*: Synchronizes playback with incoming MIDI Clock and MIDI Timecode (MTC) signals.

Controlling Playback Using Keyboard Shortcuts

There are a number of keyboard shortcuts you can use to control playback of your project. To use keyboard shortcuts, the pointer cannot be in a text field.

- *Space bar*: Plays back the project from the current playhead position. If the project is playing, pressing the Space bar sets the playhead back to the point from which the project started playing. This is equivalent to clicking the Play button.
- *Return*: Sets the playhead to the beginning of the project. If the playback region is active, pressing Return sets the playhead to the beginning of the playback region. This is equivalent to clicking the Go to Beginning button.
- *Shift-Return*: Sets the playhead to the beginning of the project, and starts playback if it is stopped. This is equivalent to clicking the Start from Beginning button.

For a complete list of Soundtrack Pro keyboard shortcuts, see Appendix B, “Soundtrack Pro Keyboard Shortcuts,” on page 279.

Locating and Adding Audio Files

You can locate media files to use in a project using the Media and Effects Manager, or drag files from the Finder. The Media and Effects Manager gives you three ways to locate audio files: the Browser, Favorites, and Search tabs. You can also store media files for a project in the Bin for easy access in a project.

Supported Audio File Formats

You can add AIFF, WAV, MP3, and AAC (except protected AAC) files to a project. You can also add QuickTime (.mov) audio files. You can import audio files with any combination of the following sample rates and bit depths:

Sample Rates

- Any sample rate from 8 kHz to 192 kHz

Bit Depths

- 8 bit
- 16 bit
- 24 bit
- 32 bit (both integer and floating point)

Note: Files with lower bit depths or sample rates do not have the same playback quality as do higher-rate formats.

Looping and Non-Looping Files

Soundtrack Pro supports two types of audio files: *looping* and *non-looping* files. Most audio files are non-looping files unless they contain tags for tempo, key, and other information.

Many of the Apple Loops that come with Soundtrack Pro, as well as other tagged audio files, can be looping files. Looping files may contain music, rhythmic sounds, or other repeating patterns. You can resize a looping file to fill any amount of time. Looping files adjust to the project tempo and key, letting you use loops recorded in different keys and at different tempos in the same project.

Non-looping files do not adjust to the project tempo and key. You can shorten or lengthen a non-looping file, but lengthening it beyond the size of the original file adds only silence to the lengthened part. You can search for non-looping files in the Search tab using the Search text field.

Both looping and non-looping files can contain tags with information about the file, including mood, genre, and musical instrument. Soundtrack Pro recognizes tags in audio files intended for use with loop-based music applications. You can open an audio file in Apple Loops Utility and add tags, and can convert a looping file to a non-looping file, or convert a non-looping file to a looping file. For information about tagging audio files using Apple Loops Utility, see Appendix A, "Using Apple Loops Utility," on page 263.

Using the Browser to Locate Files

The Browser tab shows the hard disks and other storage media connected to your computer, and lets you browse through the file hierarchy to find audio files located on disk.

To locate audio files using the Browser:

- Double-click a volume or folder in the Browser to view its contents.

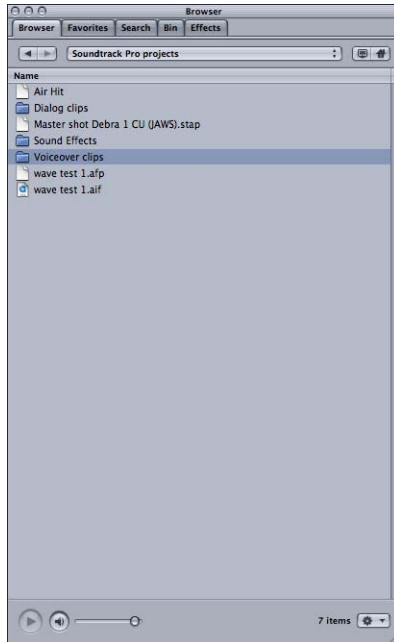

- You can move back through the previous locations in the Browser using the Forward and Back buttons, or through the levels of the file hierarchy using the Path pop-up menu.

Using Favorites to Locate Files

Favorites let you store frequently used file locations, so that you can access them directly. You can add and remove Favorites from the Media pop-up menu at the lower-right corner of the Media and Effects Manager.

To locate audio files in Favorites:

- Double-click the disk or folder you want to open.

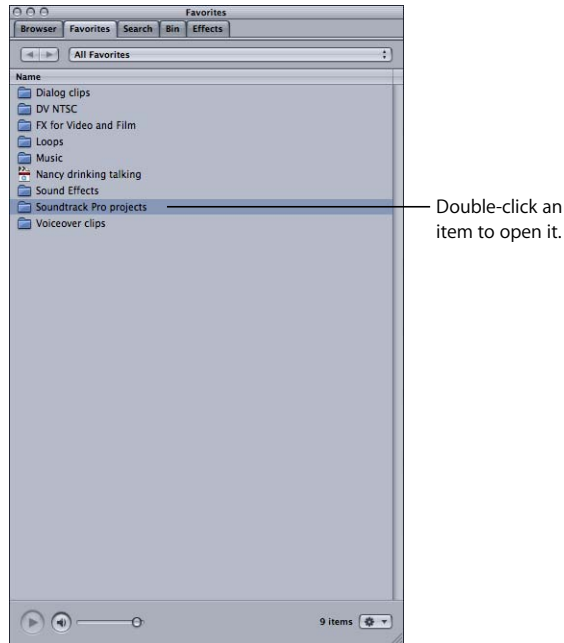

You can move back through the previous locations in the Favorites tab using the Forward and Back buttons, or through the levels of the file hierarchy using the Path pop-up menu.

Using Search to Locate Files

Using Search, you can search for media files to add to your project. Search has two views: Column view and Button view. You choose which view to display by clicking the Columns View or Button View button in the upper-left area of the window. In both views, the files matching your search criteria appear in the Search Results area, along with columns displaying additional information for tagged files. You can sort these columns by clicking the heading on top of each column. You can also perform text searches in both views, and refine your searches.

If you use Apple Loops or other tagged audio files in a project, you can search based on a variety of criteria, including musical instrument, genre, time signature, mood descriptor, and scale type. You can also search using specific keywords.

Click Search to display the Search tab in the Media and Effects Manager.

Searching for Files in Column View

In Column view, the upper area of the Media and Effects Manager displays two columns: Keywords shows the categories of files that meet the search criteria, and Matches shows the total number of matching files and any subcategories containing matching files, with the number of matching files in each.

Clicking a keyword displays the files matching that keyword in the Search Results area. You can refine your search results by narrowing the criteria using the subcategories in the Matches column.

To search for files in Column view:

- 1 Choose the type of keywords to display in the Keywords list from the Keywords pop-up menu.

You can use the Time Signature and Scale Type pop-up menus to restrict matches by those categories.

- 2 Select a keyword in the Keywords list to display matching files in the Search Results area.

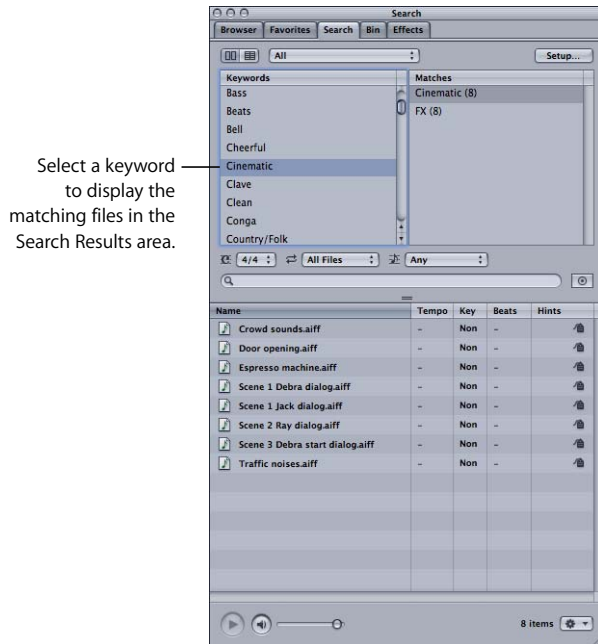

The hints, tempo, key, and number of beats for each matching file are also displayed.

You can also perform text searches, which can be especially helpful for non-tagged files. When you type text in the Search Text field, any files with the text in their file path or filename appear in the Search Results list. The number of files appears in the Matches column under “No Category.”

To search using the Search Text field:

- Enter text in the Search Text field.

As you type, files matching the characters you type appear in the Search Results field.

Refining a Search in Column View

There are several ways you can refine your searches in Column view. You can select items in the Matches column to add the matching files for each category to the search results, and you can enter text in the Search Text field to narrow your search to files that include the text in their file path. Selecting multiple keywords in the Keywords list narrows the search results to files matching all the selected keywords.

To refine your search using the Matches column:

- Click to select a match category, or Command-click to select multiple match categories.

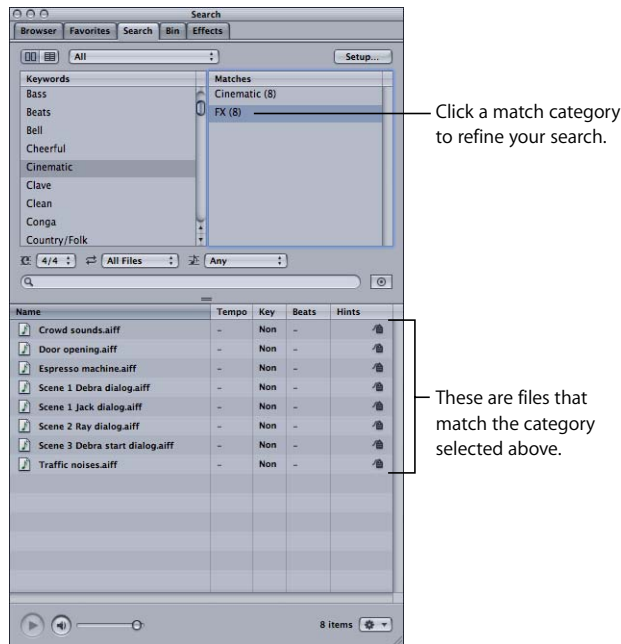

To refine your search by selecting multiple keywords:

- Shift-click to select adjacent keywords, or Command-click to select nonadjacent keywords.

Searching for Files in Button View

In Button view, the upper area of the Media and Effects Manager displays a grid of buttons, each of which is labeled with a keyword. The keywords displayed are determined by the Keywords pop-up menu; the choices are Best Mix, Instruments, Genre, Descriptors, and Custom. The keywords for each choice are fixed, and appear whether or not matching files for the keyword exist. Keywords for which no matching files exist are dimmed.

To search for files in Button view:

- 1 Choose the type of keywords to display on the keyword buttons from the Keywords pop-up menu.
- 2 You can optionally use the File Type, Time Signature, and Scale Type pop-up menus to restrict matches by those categories.
- 3 Click a keyword button to display matching files in the Search Results area.

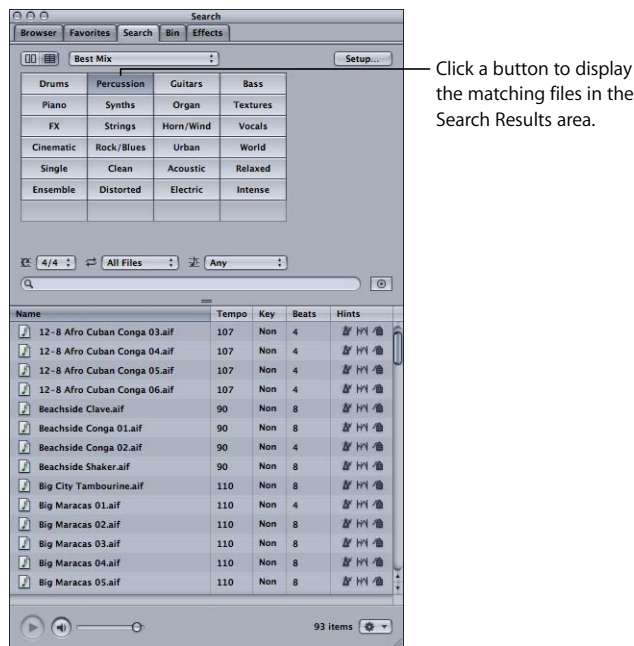

You can also perform text searches, which can be especially helpful for non-tagged files. When you type text in the Search Text field, any files with the text in their file path or filename appear in the Search Results list.

To search by file path or filename:

- Enter text in the Search Text field.
- As you type, files matching the characters you type appear in the Search Results field.

Refining a Search in Button View

There are several ways you can refine your searches in Button view. You can select multiple keyword buttons to narrow your search results to files matching all the selected keywords, and you can enter text in the Search Text field to narrow your search to files that include the text in their file path.

To refine your search using multiple keywords:

- Command-click multiple keyword buttons.

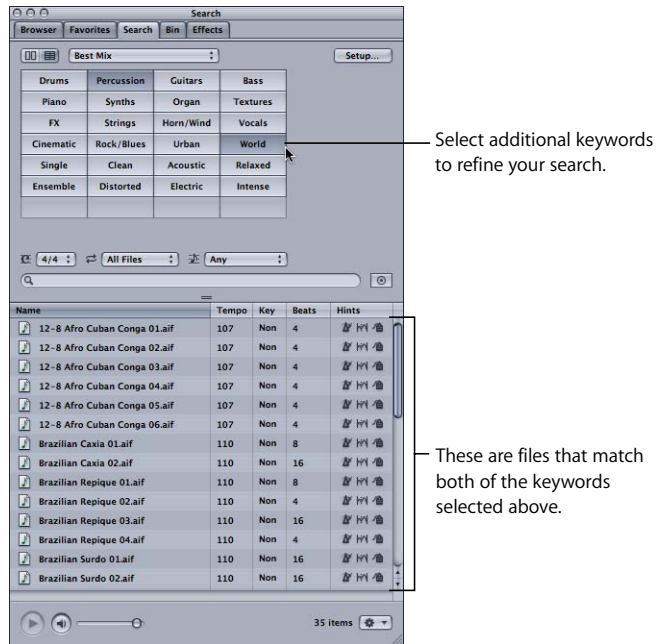

Adding Custom Keywords

You can add custom keywords, which appear in the Keywords list in Column view and on the keyword buttons in Button view. Custom keywords can be added only in Button view.

To add a custom keyword:

- 1 Choose Custom from the Keyword Type pop-up menu.
- 2 Control-click one of the buttons in the grid, then choose a custom keyword from the shortcut menu.

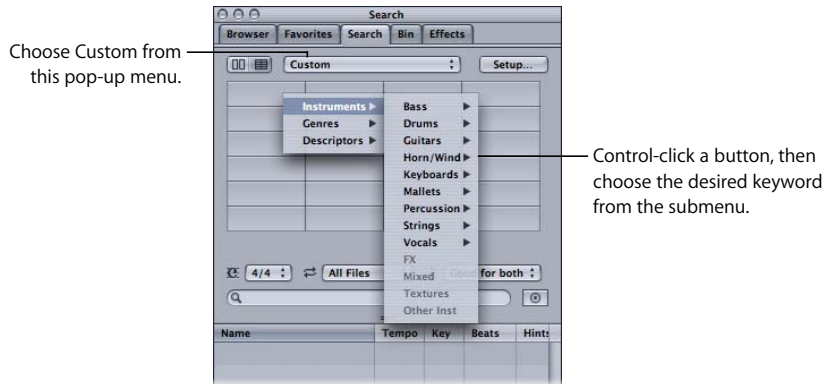

Adding a Directory to the Search Database

Search looks through all indexed directories (volumes and folders) for files that match your search criteria. Before a file can appear in Search, you must add the directory containing the file to the Search database and index the directory.

Note: The Search database does not update automatically. If you add files to an indexed directory, you must index the directory again before the files will appear in the Media and Effects Manager.

To add a directory to the Search database:

- 1 Click the Setup button at the top of the Search tab.

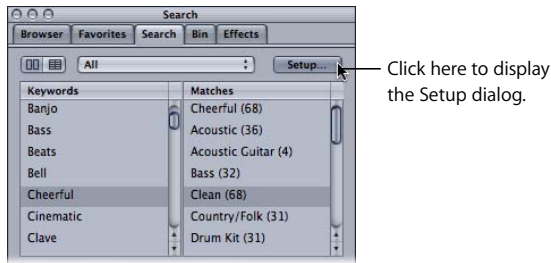

- 2 In the Setup dialog, click the Add Directory button.

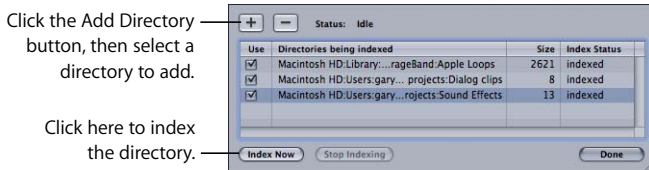

- 3 In the file dialog, navigate to the directory you want to add, then click Open.

The directory appears in the list in the Setup dialog. You can resize the Search dialog if you need to see more items in the list.

- 4 Select the directory in the list, then click the Index Now button.

Note: Indexing a large collection of files may take several minutes. The bottom of the Add Directory dialog displays the progress of the directory being indexed. If you need to interrupt the indexing process, click the Stop Indexing button. You can re-index the directory later. You can deselect items you do not wish to re-index.

- 5 When Soundtrack Pro is finished indexing the directory, click Done to return to the Media and Effects Manager.

Removing a Directory From the Search Database

If you move or change your collection of audio files, you can remove a folder from the Search database. Removing unneeded folders from the database can shorten search times and eliminate extraneous results.

To remove a folder from the Search database:

- 1 Click the Setup button at the top of the Search tab.
- 2 In the Setup dialog, select the directory you want to remove, then click the Remove Directory button.

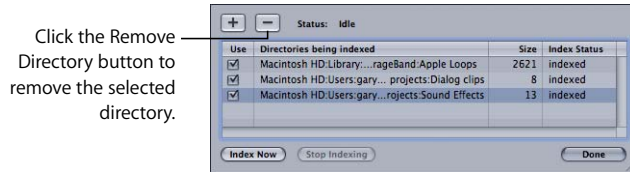

- 3 Click Done to return to the Media and Effects Manager.

Once you have added the folders containing your audio files to the Search database and indexed them, you can use Search to find the files. In both Column view and Button view, the audio files that match the search criteria appear in the Search Results area in alphabetical order. You can preview files in the File list and drag them to the Timeline. You can also add a folder to your Favorites from the Search tab.

Storing Files in the Bin

The Bin shows all of the clips added to the project. You can add audio files to the Bin for easy access to files you may want to add to the current project. Audio files appear in the Bin in alphabetical order.

To add a file to the Bin, do one of the following:

- Drag the file from the Finder to the Bin.
- Drag the file from the Browser, Favorites, or Search tab to the Bin.

Files added to the Bin but not included in the project appear dimmed in the Bin.

Previewing Audio Files

Once you locate an audio file you want to use in your project, you can preview the file in the Media and Effects Manager. When you preview files, Soundtrack Pro matches the sample rate of the file to the project sample rate. When you preview looping files, Soundtrack Pro matches their tempo and key to the project tempo and key.

To preview an audio file:

- Select the file in the Media and Effects Manager.

The selected file starts playing. If the project is playing when you preview a file, Soundtrack Pro starts playback of the previewed file on the downbeat of the next measure of the project. You can turn preview playback on and off by holding down Option and pressing the Space bar.



Audio files tagged as loops play back repeatedly when previewed. You can control the playback of the file being previewed using the preview controls. You can only preview one audio file at a time.

You can also preview video files. When you double-click a video file in the Media and Effects Manager, the video appears in a small window in the Details tab.

To preview a video file:

- 1 Click the Details tab in the Utility window to make the tab active.
- 2 Select the video file in the Media and Effects Manager.
- 3 Click the Play button in the Preview controls at the bottom of the Media and Effects Manager. To stop playback, click the Play button again.

For more information on working with video files, see Chapter 8, “Working With Video in Soundtrack Pro,” on page 183.

Using the Preview Controls

The preview area at the bottom of the Media and Effects Manager contains controls you can use when previewing audio files.

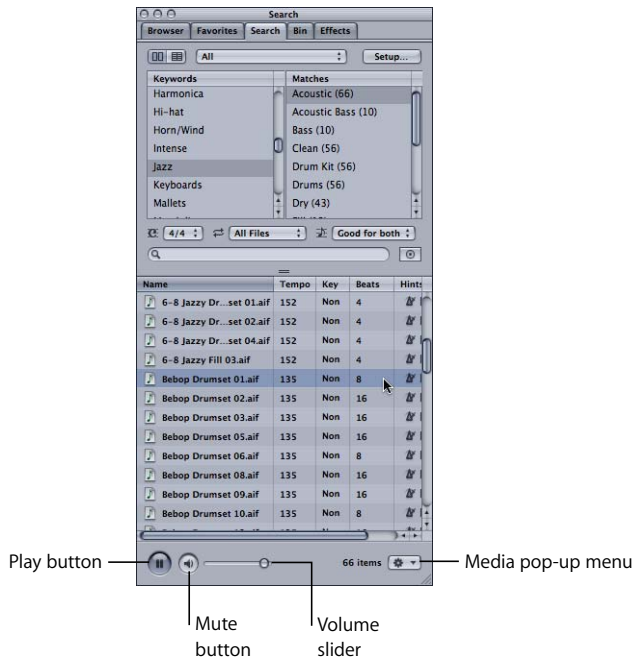

- **Play button:** Starts playback of the preview file. If the file is playing, stops playback.
- **Mute button:** Mutes playback of the preview file without stopping project playback. Clicking the button again unmutes the preview file.
- **Volume slider:** Sets the playback volume of the preview file.
- **Media pop-up menu:** Choose whether to add the file to Favorites, open it in the Waveform Editor or Apple Loops Utility, or reveal it in the Finder.

To preview an audio file with a project:

- 1 Click the Play button in the transport controls to play the project.
- 2 When the project reaches the point in time where you want to hear the preview file, select the file in the Media and Effects Manager.

To preview a file without the project (solo):

- 1 If the project is playing, click the Stop button in the transport controls to stop playback of the project.
- 2 Select the file in the Media and Effects Manager to preview the file.

You can also preview a video file using the preview controls. For information about previewing a video file, see “Playing the Video” on page 185.

Viewing Audio File Information

You can view information about an audio file in the Media and Effects Manager, the Timeline, or the Waveform Editor in the Details tab of the Utility window.

When you select an audio file in the Media and Effects Manager, the Details tab displays the file path and other information about the file. The following information is displayed in the File tab of the Details tab:

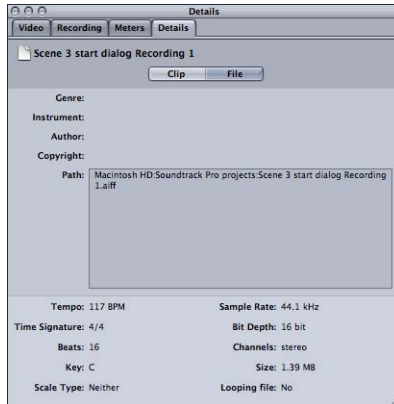

- *Name*: The name of the file
- *Hints*: The hints provided for the file. Hints are file tags that are used to search for files or for tempo and key matching.
- *Instrument*: The instrument or instrument category to which the file belongs
- *Author*: The author of the file
- *Copyright*: The copyright information for the file
- *Path*: The path to the file's location on disk
- *Tempo*: The original tempo of the file
- *Time Signature*: The time signature of the file
- *Beats*: The number of beats recorded in the file. For non-looping files, this field shows the duration (length) of the file in seconds.
- *Key*: The original key of the file
- *Sample Rate*: The sample rate at which the file was recorded
- *Bit Depth*: The bit depth at which the file was recorded
- *Channels*: The number of audio channels the file contains
- *Size*: The file size in kilobytes
- *Genre*: The musical category to which the file belongs
- *Length*: The duration of the file in seconds
- *Looping file*: Indicates whether the file is a looping file (Yes) or a non-looping file (No).

Note: The information that is displayed depends on whether or not the file is tagged. Untagged files may not display information for all categories. For more information on file tags, see Appendix A, “Using Apple Loops Utility,” on page 263.

You can also view and edit audio clip properties in the Details tab. For information about viewing and editing clip properties, see “Viewing and Editing Clip Properties” on page 89.

Using Undo and Redo

As you edit clips and perform other operations in both multitrack and audio file projects, you might need to use the Undo and Redo commands. For example, if you don’t like the last change you’ve made to a project, it can usually be undone. Then, if you decide you prefer to keep the change you just undid, you can redo the command immediately after using Undo.

You can also use the Undo and Redo commands as a quick way of trying out changes to your project. You can make changes to any aspect of the project, then use Undo to step back through changes you don’t like to the project’s previous state. If you change your mind after undoing a change or set of changes, you can always use Redo to recover the changes. At any point, you can save a new version of the project using the File > Save As command.

You can use the Undo command repeatedly to undo every change made since the project was last saved.

To undo the last change:

- Choose Edit > Undo [*item*] (or press Command-Z).

The [*item*] in the menu changes to show the last command or operation.

You can use the Redo command repeatedly to redo every undone change since the project was last saved.

To redo the last change:

- Choose Edit > Redo [*item*] (or press Command-Shift-Z).

The [*item*] in the menu changes to show the last command or operation.

Using Snap

When you move and resize clips in the Timeline, or select part of an audio file in the Waveform Editor, you usually want them to start and end at a specific point in time. To synchronize clips with a video, you may want to position them in line with a specific frame. In a music-based project, you may want to align clips with measures and beats. Soundtrack Pro includes a snap feature that causes clips, the playhead, and other items in the Timeline and Waveform Editor to “snap” to the nearest Snap To position.

Snap applies to the following operations:

- Dragging audio clips to the Timeline
- Moving audio clips
- Resizing audio clips
- Setting the playhead
- Setting the playback region
- Inserting markers
- Moving markers
- Selecting Timeslices
- Adding envelope points
- Moving envelope points
- Moving crossfade edges

You can use snap to ensure that audio clips are synchronized to a measure or beat, that they begin playing back at a precise point in time, and that they are precisely aligned with other clips in the Timeline.

When you turn on snap, the item you are moving snaps to the nearest Snap To position in the Timeline. The available Snap To values depend on the time format of the project. For projects set to Time-based format, the available Snap To values are:

- Ruler ticks
- Seconds
- Frames
- Clips on Adjacent Tracks
- Markers

For projects set to Beats-based format, the available Snap To values are:

- Ruler ticks
- 1/4 notes
- 1/8 notes
- 1/16 notes
- 1/32 notes
- 1/64 notes
- Markers
- Clips on Adjacent Tracks

To turn snap on:

- Choose View > Snap (or press G).

A checkmark next to the menu item indicates that snap is turned on. Choose View > Snap again to turn snap off.

To set the Snap To value:

- Choose View > Snap To, then choose a value from the submenu.

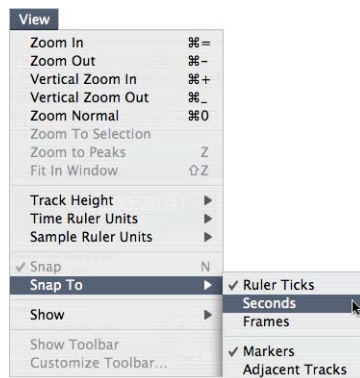

You can temporarily defeat snap while you work in the Timeline. When you defeat snap, you reverse the current snap state.

To defeat snap:

- Select the item in the Timeline, then hold down the Command key as you drag the item.

If snap is turned on, Command-dragging lets you move the item without having it snap to the nearest Snap To position. If snap is turned off, the item snaps to the nearest Snap To position. When you release the Command key, items moved in the Timeline follow the normal snap state.

Reconnecting Media Files

Because Soundtrack Pro multitrack projects contain references to media files, and not the files themselves, a multitrack project cannot play back if the media files it uses are erased or moved. When you open a multitrack project in Soundtrack Pro, the application checks to see if the media files it uses exist in the same location as they did when the project was last opened. If the media files are not in the expected location, Soundtrack Pro displays a Can't Find File dialog, with three choices.

- *Skip File*: Opens the project without reconnecting the missing file.
- *Cancel*: Cancels the Open command.
- *Find File*: Presents a dialog that lets you locate the missing file and reconnect it to the project.

If you choose to open the project without reconnecting its files, you can reconnect individual audio files from the Bin tab, and reconnect a video file in the video track in the Timeline.

To reconnect an audio file:

- 1 Do one of the following:
 - Control-click the audio file in the Bin tab, then choose “Reconnect [filename]” from the shortcut menu.
 - Select the clip in the Bin tab, then choose “Reconnect [filename]” from the Media pop-up menu.
 - Select the clip in the Timeline, then choose Clip > Reconnect.
 - Control-click the clip in the Timeline, then choose Reconnect from the shortcut menu.
- 2 In the dialog that appears, locate the audio file you want to reconnect.
- 3 Click Open to reconnect the file.

To reconnect a video file:

- 1 Control-click the video clip in the video track, then choose “Reconnect offline source” from the shortcut menu.
- 2 In the dialog that appears, locate the video file.
- 3 Click Open to reconnect the file.

Setting Soundtrack Pro Preferences

You set preferences for various aspects of Soundtrack Pro that affect both the appearance and operation of the application in the Preferences window. Some preferences apply to the current project, and some apply to new projects you create. You may want to specify some preferences before you begin working in Soundtrack Pro.

To open the Preferences window:

- Choose File > Preferences.

General Preferences

The General preferences include program startup behavior, Media and Effects Manager options, and Timeline defaults for new multitrack projects.

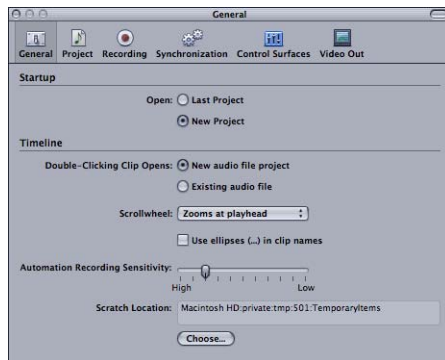

Startup

These preferences let you set the startup behavior when you open Soundtrack Pro.

- *Open Last Project button:* Reopens the last project on startup.
- *Open New Project button:* Creates a new, blank multitrack project on startup. This is the default behavior.

Timeline

These preferences let you set the default Snap To value, default track height, and other aspects of the Timeline.

- *Double-clicking Clip Opens New audio file project:* When selected, double-clicking a clip in the Timeline creates a new audio file project for the clip.
- *Double-clicking Clip Opens Existing audio file:* When selected, double-clicking a clip in the Timeline opens the audio file in the Waveform Editor.
- *Use ellipses(...) in clip names checkbox:* When selected, clips in the Timeline with long names are center-truncated with an ellipsis. "Use ellipses (...) in clip names" is deselected by default.

Note: Selecting "Use ellipses in clip names" can impact the speed at which the screen is redrawn during playback.

- *Scrollwheel pop-up menu:* Choose whether an attached mouse with a scrollwheel scrolls the Timeline or zooms in or out at the playhead position.
- *Automation Recording Sensitivity slider:* Drag to set the level of sensitivity with which onscreen and control surface movements are recorded. Setting the slider to High results in all movements being recorded.
- *Scratch Location button and display:* Click, then browse to the location of the disk or folder you want to use as the location for storing scratch files. The current location is shown in the Scratch Location display.

Project Preferences

These preferences let you set project properties and other default settings for new projects you create.

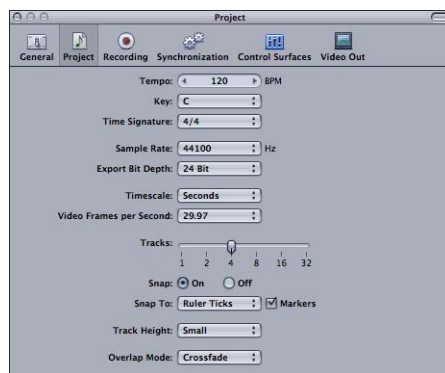

- *Tempo value slider:* Sets the default tempo for new projects in beats per minute (bpm). The range is 60 to 200 bpm.
- *Key pop-up menu:* Sets the default key for new projects. The range is any key in the chromatic scale from A to G#, or None.
- *Time Signature pop-up menu:* Sets the default time signature for new projects. The choices are 3/4, 4/4, 5/4, 6/8, and 7/8.
- *Sample Rate pop-up menu:* Sets the default sample rate for new projects. The choices are 32 kHz, 44.1 kHz (CD-quality audio), 48 kHz (DVD-quality audio), and 96 kHz.
- *Export Bit Depth pop-up menu:* Sets the export bit depth for the current project and new projects. The choices are 16-bit (CD-quality audio) and 24-bit.
- *Timescale pop-up menu:* Choose whether the overall project uses Time-based or Beats-based time format.
- *Video Frames per Second pop-up menu:* Choose which video frame rate to use for new projects.
- *Tracks slider:* Sets the default number of tracks for new multitrack projects.
- *Snap buttons:* Turn snap on or off for new multitrack projects.

- *Snap To pop-up menu:* Sets the default Snap To value for new multitrack projects. The choices are Ruler Ticks, Quarter notes, 8th notes, 16th notes, 32nd notes, 64th notes, and Clips on Adjacent Tracks.
- *Track Height pop-up menu:* Sets the default track height for new multitrack projects. The choices are Reduced, Small, Medium, and Large.
- *Overlap Mode pop-up menu:* Sets whether overlapped clips are crossfaded or truncated for new multitrack projects.

Recording Preferences

These preferences let you specify settings for recording audio.



- *Input pop-up menu:* Displays the available devices for audio input. Choose an input device from the pop-up menu.
- *Monitor pop-up menu:* Displays the available devices for monitoring audio output. Choose an output device from the pop-up menu.
- *Latency Compensation slider:* Sets the amount of latency compensation in milliseconds. If recorded audio is late, drag the slider right. If the recorded audio is early, drag the slider left.
For information on eliminating latency, see “Eliminating Recording Latency” on page 294.
- *Sessions Location display:* Displays the default location to which recording sessions are saved. You can set the save location by clicking the Choose button and navigating to a new location.

Synchronization Preferences

These preferences let you specify synchronization settings.

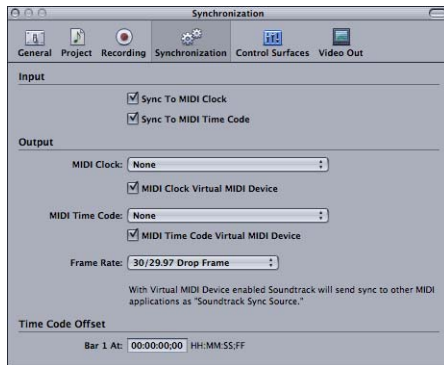

Input

- *Sync To MIDI Clock checkbox*: Sets Soundtrack Pro to receive MIDI Clock signals from a MIDI application or external device.
- *Sync To MIDI Time Code checkbox*: Sets Soundtrack Pro to receive MIDI Time Code (MTC) signals from a MIDI application or external device.

Output

- *MIDI Clock pop-up menu*: Choose the device to send MIDI Clock to, or choose None.
- *MIDI Clock Virtual MIDI Device checkbox*: Sets Soundtrack Pro to send MIDI Clock signals to MIDI applications as “Soundtrack Sync Source.”
- *MIDI Time Code pop-up menu*: Choose a device to send MTC signals to, or choose None.
- *MIDI Time Code Virtual MIDI Device checkbox*: Sets Soundtrack Pro to send MTC signals to MIDI applications as “Soundtrack Sync Source.”
- *Frame Rate pop-up menu*: Sets the frame rate for outgoing MTC signals. (Note that Soundtrack Pro automatically detects the frame rate for incoming MTC signals.)

Time Code Offset

- *Bar 1 At field*: Sets the offset of Measure 1 of your Soundtrack Pro project in SMPTE format. The offset affects both incoming and outgoing MTC signals. This should be set to the same value in all applications and devices.

Control Surfaces Preferences

These preferences let you specify settings for communicating with attached control surfaces.

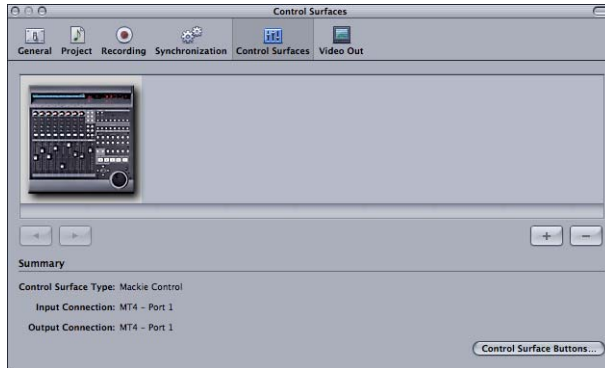

- *Control Surfaces field:* Shows the control surfaces connected to your computer. Channels and banks are assigned to control surfaces in the order they appear in the field, starting from the left.
- *Add and Delete buttons:* Add or delete the selected control surface so that Soundtrack Pro no longer connects to it.
- *Previous and Next buttons:* Change the order of the selected control surface in the Control Surfaces field.
- *Summary information:* Displays information about the selected control surface including type, input port, and output port.
- *Control Surface Buttons button:* Click to show the Control Surface Mapping window, where you can assign control surface buttons and other controls to specific commands and operations.

For information about connecting and using control surfaces, see Chapter 12, “Using Control Surfaces With Soundtrack Pro,” on page 243.

Video Out Preferences

These preferences let you specify settings for video output from Soundtrack Pro.



- *Video Output Device pop-up menu:* Choose a video output device, or choose None.
- *Use Quarter-size Frames checkbox:* Select to send video to the output device as quarter-size frames. Quarter-size frames require less data throughput and can be sent more efficiently than full-size frames.

You can arrange and mix audio clips in a multitrack project. Multitrack projects include tracks, busses, and outputs you can use to create sophisticated mixes.

When you create a multitrack project, you can set the project's properties and the project length. You locate and add media to your project using the Media and Effects Manager.

Creating and Opening Multitrack Projects

When you open Soundtrack Pro, a new, blank project appears. You can change the default startup behavior in the Preferences window. For information about setting preferences, see “Setting Soundtrack Pro Preferences” on page 75.

To create a new multitrack project:

- Choose File > New > Multitrack Project (or press Command-N).

A new, untitled project appears. You can name the project when you save it. For information on saving projects, see “Saving Multitrack Projects” on page 86.

To open an existing project:

- 1 Choose File > Open (or press Command-O).
- 2 Optionally, to view only multitrack projects in the dialog, choose Multitrack Document from the File Type pop-up menu.
- 3 Locate and select the project, then click Open.

You can also open a recently open project by choosing it from the File > Open Recent menu, and can open a project by dragging it onto the Soundtrack Pro icon in the Dock.

You can have multiple projects open in Soundtrack Pro, and cut and paste between them, but you can only play one project at a time. You can open projects created with earlier versions of Soundtrack (with the extension .loop) but can only save them as multitrack projects (with the extension .stmp)

Closing Multitrack Projects

To close a project:

- Select the project's tab in the Project window, then choose File > Close Project (or press Command-Shift-W).

Setting Project Properties

Each project has a set of project properties, which include time format, sample rate, tempo, time signature, key, and overlap mode. Each project property has a default setting, described below. You can change the project properties using the project controls in the Project window in the Timeline.



The most important project properties are time format and sample rate. The remaining properties (tempo, time signature, and key) are important for projects set to Beats-based format. For projects set to Time-based format, you can usually leave the tempo, time signature, and key properties at their default settings.

You can change the default project properties for new projects in the Project pane of the Preferences window. For information on setting preferences, see “Setting Soundtrack Pro Preferences” on page 75.

Time Format

Each multitrack project has a project time format, which can be either *Time-based* or *Beats-based* format. Setting the time format controls the appearance of the Time display, Time ruler, Timeline gridlines, and available Snap To values. For projects set to Time-based format, time is displayed using the Time ruler units chosen in the View menu. For projects set to Beats-based format, the time is displayed in measures, beats, and beat divisions. The default format is Time-based.

Setting the format to Time-based lets you align clips and other items in the Timeline with specific points in time, for example, specific frames in a video file. Setting the format to Beats-based lets you align items in the Timeline with measures, beats, and other musical units of time, regardless of tempo. You can switch between Time-based and Beats-based format while working on a project.

To set the time format:

- Click the Time Format button to set the format to Time-based, or click the Beats Format button to set the format to Beats-based.

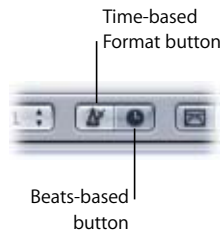

You can also set individual tracks to use a different time format than the project's time format. For information on setting a track's time format, see "Changing Track Time Format" on page 104.

Sample Rate

The project sample rate determines the number of samples per second Soundtrack Pro uses for audio playback and export. When you add audio files to your project, their sample rate is matched (upsampled or downsampled) on the fly to the project sample rate. The available sample rates are 32 kHz, 44.1 kHz, 48 kHz, 88.2 kHz, and 96 kHz. The default is 44.1 kHz, which is the standard for CD-quality audio recording.

Note: Digital video projects, including video for DVD, often use a 48 kHz sample rate. When creating a score for a video, be sure you save and export your project at the same sample rate the final video project will use.

To set the sample rate:

- Choose the sample rate from the Sample Rate pop-up menu.

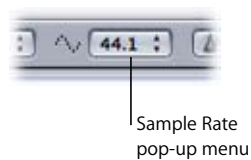

Note: If you open your project on a computer that cannot support the project sample rate, the project is resampled to the nearest rate the hardware supports for playback. When you export your project, it is exported at the project sample rate, regardless of hardware limitations. For more information on hardware sample rates, see Chapter 1, "Setting Up Your System," on page 13.

Tempo

The tempo sets the rate of the basic beat value for the project. When you add looping files to a project, their tempo is matched to the project tempo. The tempo range is from 60 to 200 beats per minute (bpm). The default tempo is 120 bpm (which equals two beats per second). You set the project tempo using the Tempo value slider in the project controls.

To set the project tempo, do one of the following:

- Click the left arrow in the Tempo value slider to decrease the tempo, or click the right arrow to increase the tempo.
- Click the value in the value slider, then drag the slider that appears left or right to change the tempo.
- Double-click the value in the value slider to select it, then type a new value.



You can change the project tempo over time using the Master Tempo envelope. For information about creating tempo changes, see “Master Envelopes” on page 220.

Time Signature

The time signature controls how measures and beats appear in the Time display and Time ruler. A project can have only one time signature, which lasts from the beginning to the end of the project. The default time signature is 4/4 (four beats per measure, with a quarter note as the beat value).

To set the project time signature:

- Choose a time signature from the Time Signature pop-up menu.

If you want to use a time signature not included in the list, choose Other, enter the time signature in the dialog that appears, then click OK.

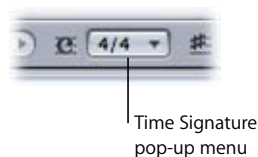

Note: The project time signature affects the format of the Playhead Position value slider. For projects using Beats-based time format, it also affects the appearance of the Time ruler and the gridlines in the Timeline. It does not affect the rhythm of audio clips. If your project uses audio clips with music in a definite time signature, make sure that the project time signature matches the time signature of the clips used in the project.

Key

The project key sets the root note (or tonic) for the project. When you add looping files to a project, their key is matched to the project key. You can set the project key to any note of the chromatic scale (from A through G#), or to None (-). The default key is A.

Note: The key does not determine the scale used (major, minor, or another scale), only the tonic or root note of the project.

To set the project key:

- Choose a key from the Key pop-up menu.



Overlap Mode

The project overlap mode determines what happens when you move an audio clip so that it partially or completely overlaps another clip on the Timeline. There are two overlap modes: crossfade mode and truncate mode.

In crossfade mode, when you drag an audio clip so that it partially overlaps another audio clip in a track in the Timeline, a crossfade is created for the overlapped part of the two audio files. You can adjust the boundaries of the crossfade in the Timeline. In truncate mode, when you drag an audio clip so that it partially overlaps another audio clip in a track in the Timeline, the overlapped part of the clip is truncated.

To set the project overlap mode:

- Click the Crossfade Mode button to set the project to crossfade mode, or click the Truncate Mode button to set the project to truncate mode.

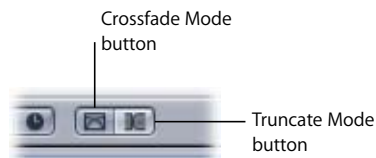

Setting the Project Length

By default, the length of a project depends on the media in the project. The project length is set to the end of the last clip in the project. If the project uses a time-based effect, and the effect extends past the end of the last clip, the project length extends to include the effect's "tail." Adding a clip to the end of the project, or adding an effect that produces a "tail," extends the project length to include the new clip or the effect's tail. You can optionally set the project to a definite length.

To set the project length:

- In the Timeline, place the playhead at the point where you want the project to end, then choose **Mark > Set End of Project**.

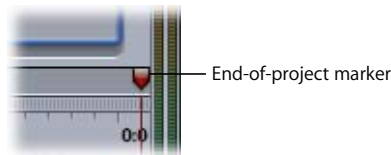

You can move the end-of-project marker to change the length of the project, or delete it if you decide you no longer want it in the project.

To delete the end-of-project marker:

- Select the marker in the Timeline, then choose **Edit > Delete** (or press the Delete key.)

Saving Multitrack Projects

To save your project:

- Choose **File > Save**.

Multitrack projects are saved as documents with the extension *.stmp*.

Important: When you save a project, the audio files used by the project are not saved as part of the project file. To play a project on another computer, you must install the audio files the project uses on that computer, or on a disk it can access. If you remove the audio files used in a project so that your computer cannot access them, you cannot play back the project.

You can save a project and the media files the project uses together. This makes it easy to move projects between computers, and ensures that all needed audio files are available for playback.

- When you select *Collect Audio Files*, the project file and all the audio files the project uses are saved in the same folder.
- When you select *Collect Video File*, the video file is included with the project and its audio files.

To save a project and its audio files together:

- 1 Choose File > Save.
- 2 In the dialog that appears, select the Collect Audio Files checkbox.
- 3 Navigate to the folder in which you want to save the project and its audio files, then click Save.

The project file, and a copy of every audio file the project uses, are saved to the selected location.

- 4 You can optionally click the New Folder button to create a new folder for the collected project. It's a good idea to save each collected project in its own folder.
- 5 If the project includes a video file, you can optionally select the Collect Video File checkbox to save the video to the selected location.

If the folder already contains any of the media files, an alert appears, asking if you want to replace the existing files.

Note: Because video files are typically very large files, saving a copy of the video file may take several minutes and may require a large amount of disk space.

You can also save a compressed version of the project. When you save a project compressed, the data used to draw the audio waveforms in the Timeline is not saved. This reduces the size of the project, but means that the waveforms must be redrawn each time the project is opened.

To save a project compressed:

- In the Save dialog, select the Save Compressed checkbox.

Adding Audio Files to a Multitrack Project

Once you've located and previewed an audio file you want to add, you drag the file to the Timeline to add it to the project. When you drag an audio file to the Timeline, Soundtrack Pro creates an *audio clip* from the audio file, and adds the clip to the project. An audio clip does not contain the actual audio data; instead, it contains a reference to the file stored on disk. Editing an audio clip in the Timeline does not change the source audio file.

Each audio clip has a playback mode. For untagged files and files tagged as non-looping files, the clip playback mode is *non-looping*. For files tagged as looping files, the clip playback mode is *looping*. If the playback mode of a clip is looping, the clip appears with notched edges to indicate where the audio file repeats when you resize the clip.

To add an audio file from the Media and Effects Manager, do one of the following:

- Drag the file from the File list in the Media and Effects Manager to a track in the Timeline.
- Drag the file from the File list between two existing tracks. A new track is created and the clip is added to the track.
- Drag the file from the File list to the empty part of the Timeline below the outputs. A new track is created and the clip is added to the track.
- Drag a file from the File list to a track or to the part of the Timeline below the existing tracks.

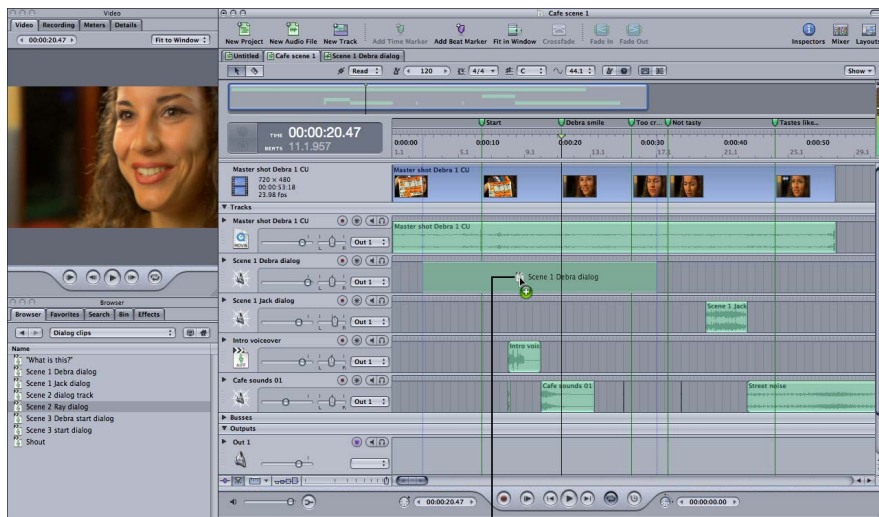

Drag the file from the Media and Effects Manager to the Timeline.

If you have adjusted the preview volume, the track volume is automatically set to the preview volume of the file.

To add an audio file from the Finder:

- Drag the file from the Finder to the Timeline to a track, between two existing tracks, or to the area below all existing tracks.

When the Bin tab of the Media and Effects Manager is active, the Bin shows all of the audio clips in the project. You can drag a clip from the list to the Timeline to add a new clip from the same audio file at a different point in time, or to a different track.

To add an audio file from the Bin tab:

- Drag the file from the Bin tab to the Timeline, either to a track or to the area below the existing tracks.

Note: When you drag an audio file to the Timeline, the file snaps to the nearest Snap To position if snap is turned on. For information on setting the Snap To value, see “Using Snap” on page 72.

Viewing and Editing Clip Properties

When you create an audio clip by dragging an audio file to the Timeline, the audio clip has a set of properties. These properties are specific to the clip, and can be different for two clips created from the same source audio file.



The following properties for the selected clip are displayed, and can be edited, in the Clip tab of the Details tab:

- *Playback buttons:* Set whether the clip is looping or non-looping. When you add an audio file to the Timeline, the clip will be non-looping unless the audio file is tagged as a looping file.
- *Measure in pop-up menu:* Sets the units shown in the Position, Duration, and Offset value sliders.
- *Position value slider:* Sets the start point for the clip in the Timeline.

- *Duration value slider*: Sets the duration of the clip. The duration of looping files is displayed in number of beats; the duration of non-looping files is displayed in seconds.
- *Offset value slider*: Sets the number of beats (for looping files) or seconds (for non-looping files) from the beginning of the source file at which the clip begins playing.
- *Transpose pop-up menu*: Sets the transposition in semitones for looping files; the range is -12 to +12 semitones.
- *Clip Speed pop-up menu*: Sets the playback speed for looping files, which can be Quadruple, Double, Normal, Half, or Quarter.

Some properties can be changed by editing the clip in the Timeline. For detailed information on editing audio clips, see “Editing Audio Clips in the Timeline” on page 107.

The name of an audio clip appears on the clip in the Timeline. By default, the entire name appears on the clip if the clip is long enough to display it. You can change the default behavior in the General pane of the Preferences window, so that long clip names are truncated from the center. For information on setting preferences, see “Setting Soundtrack Pro Preferences” on page 75.

Tracks, Busses, and Outputs

Multitrack projects contain tracks, busses, and outputs. Tracks, busses, and outputs appear as horizontal rows in the Timeline and as vertical channel strips in the Mixer. In both the Timeline and Mixer, tracks, busses, and outputs are grouped together, with a separator between each category. You can move each type within its own category, but cannot move one to either of the other categories. Each track, bus, and output has a header with its icon, name, and a set of controls.

Tracks

Tracks contain the audio you add to your project in the Timeline. Each track has a drag handle, a name, an icon, and a set of controls that appear in the track’s header in the Timeline and in its channel strip in the Mixer. Track controls include a volume slider, a pan control, an output pop-up menu, and buttons to mute or solo the track, add effects, and enable the track for recording. In addition, each channel strip includes stereo level meters you can use to watch the track’s levels, and a set of effects slots where you can add and order track effects and sends.

Busses

Using busses, you can create submixes, letting you adjust volume and pan and add effects to groups of related tracks. You use busses by adding sends to effects chains in the Effects tab or the Mixer, then routing audio from each send to a bus.

Each bus has a drag handle, a name, an icon, and a set of controls that appear in the bus's header in the Timeline and in its channel strip in the Mixer. Bus controls are the same as track controls, except that a bus does not have a Record Enable button (because you can't record audio to a bus.) The bus controls affect the audio of every track sent to that bus.

For example, you could route every dialogue track for a particular actor to a bus with the actor's name. You could adjust the volume of all the actor's dialogue using the bus volume fader, and add an EQ effect that brings out the actor's voice in the mix. You could then send (route) the bus to a particular output.

You route audio from a track to a bus by adding a send to the track in the Effects tab or in the Mixer. When you add a send, the send is assigned to a bus. You can change the bus to which a send is assigned, and can adjust the volume and pan for the send.

Outputs

Outputs let you route the audio from tracks and busses to physical outputs. If you are using external audio hardware that supports multiple physical outputs, you can add outputs to a project and choose the physical output to which each Mixer output sends its audio. You can also send audio from multiple tracks or busses to a single output, control volume and pan for all the tracks using the output's controls, and add effects to the output.

For example, you could have a bus with the dialogue tracks for each actor, and route all the dialogue busses to a single output. You could route all sound effects tracks to another output, and adjust the volume or add effects to each output. For a final stereo mix, you could route both outputs to the same pair of physical output channels (channels 1 and 2, for example).

Each output has a drag handle, a name, an icon, and a set of controls that appear in the output's header in the Timeline and in its channel strip in the Mixer. Output controls include a volume slider, a pop-up menu where you can choose the physical output channels for the output, and buttons to mute or solo the output and add effects. Each output channel strip includes stereo level meters you can use to watch the output's levels, and a set of effects slots where you can add and order effects and sends. Outputs do not have pan controls or Record Enable buttons.

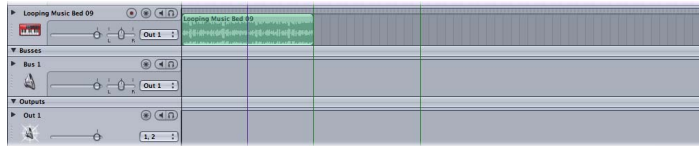

**Tracks, busses, and outputs
in the Timeline**

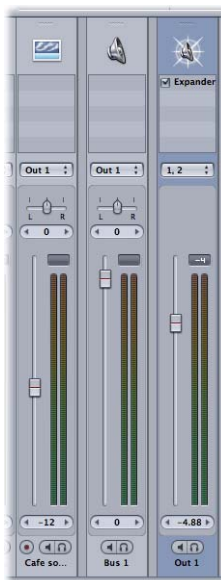

**Tracks, busses, and
outputs in the Mixer**

For information about working with tracks, busses, and outputs in the Timeline, see “Working With Tracks, Busses, and Outputs in the Timeline” on page 99. For information about working with tracks, busses, and outputs in the Mixer, see “Working With Channel Strips in the Mixer” on page 125.

The Timeline is where you arrange audio clips to build your soundtrack. You can also adjust volume and panning, add effects, and edit envelopes to control automation.

The Timeline displays a visual representation of a project, showing the point in time when audio clips start playing and their duration. You control when and how long clips play by moving and resizing them in the Timeline.

The Timeline is arranged in three sets of horizontal rows: tracks, busses, and outputs. You add audio clips to tracks, create submixes using busses, and send audio to physical output devices using outputs. For information about working with tracks, busses, and outputs, see “Tracks, Busses, and Outputs” on page 90.

The Timeline also displays vertical gridlines that make it easy to position clips precisely in time. The gridlines correspond to the divisions of time in the Time ruler. The units of time the gridlines display change depending on the time format and the current zoom level.

Moving Around in the Timeline

Soundtrack Pro provides several controls that let you change the view of the Timeline and move to different parts of your project. You can zoom in or out for a closer or wider view of the Timeline, control how many tracks are displayed in the Timeline, and change which part of the project is currently visible using the scroll bars and Timeline controls. You can split the Timeline view, and use the Global Timeline view to quickly move to different parts of your project.

Using the Scroll Bars

If the entire project cannot be displayed in the Timeline, you can scroll through the project using the horizontal scroll bar located at the bottom of the Timeline. Drag the horizontal scroll bar left or right to move the visible part of the Timeline.

If your project contains more tracks than can be displayed in the Timeline, a vertical scroll bar appears along the right edge of the Timeline. Drag the vertical scroll bar up or down to change which tracks are visible.



In the lower left of the Timeline are the Timeline controls, including the Track Height control and Zoom control.

Using the Zoom Control

You can zoom in to make precise edits in the Timeline, or zoom out for a wider view of your project using the Zoom control.

The Zoom control features a slider on a graduated scale. Moving the slider to the left or clicking the left side of the control zooms in for a closer view, displaying a smaller area of the Timeline close up. Moving the slider to the right or clicking the right side of the control zooms out for a wider view, displaying a wider area of the Timeline.

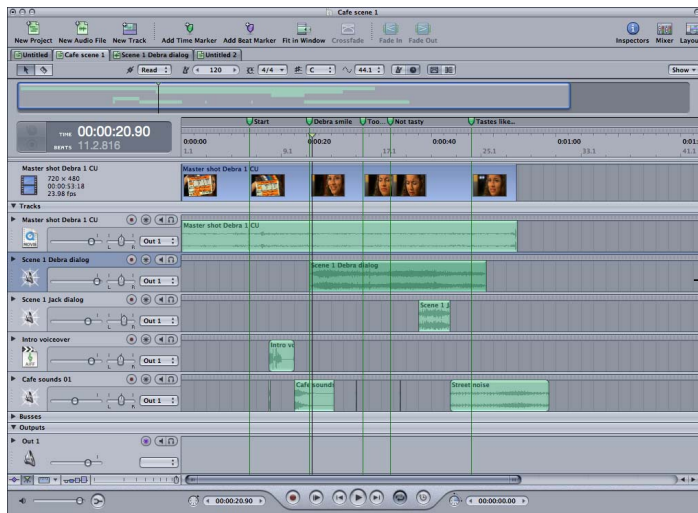
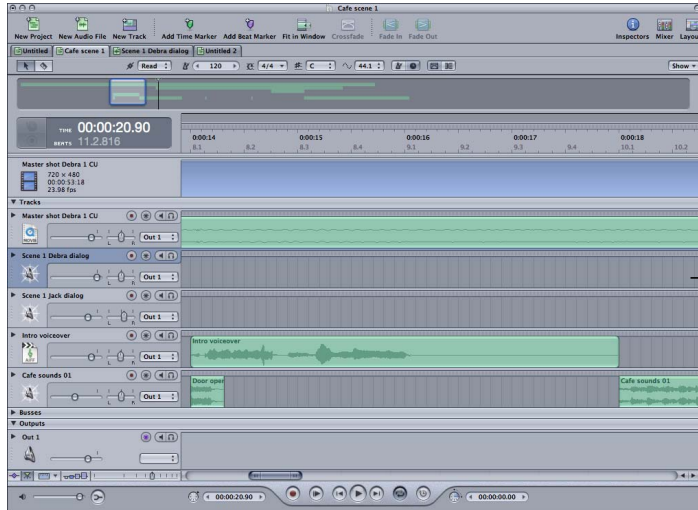

You can also zoom in and out using menu commands or keyboard shortcuts. If your mouse has a scroll wheel, you can use it to zoom in and out. You can also fit the entire project in the visible area of the Timeline.

To zoom in, do one of the following:

- Move the Zoom slider to the left.
- Click the left side of the Zoom control.
- Choose View > Zoom In.
- Press the Up Arrow key.
- Press Command-plus (+).
- If the mouse connected to your computer has a scroll wheel, move the scroll wheel.

To zoom out, do one of the following:

- Move the Zoom slider to the right.
- Click the right side of the Zoom control.
- Choose View > Zoom Out.
- Press the Down Arrow key.
- Press Command-minus (-).
- If your mouse has a scroll wheel, move the scroll wheel.

By default, when you zoom in or zoom out using the scroll wheel, the playhead remains in the same position on your screen, and the Timeline zooms in or out on both sides of the playhead. You can change the default scrollwheel behavior in the General Preferences pane.

To fit the project in the visible area of the Timeline:

- Choose View > Fit in Window (or press Shift-Z).

Setting Track Height

You set the height of tracks, busses, and outputs in the Timeline using the Track Height control. The Track Height control has four settings. The smallest rectangle sets the track height to a minimized setting, with each track (and track header) reduced to half-height, allowing more tracks to be displayed in the Timeline.

To set the height of tracks, busses, and outputs:

- Click one of the four rectangles on the Track Height control.



Using the Global Timeline View

The Global Timeline view, located above the Time display and Time ruler, shows a miniature view of the entire project. The playhead appears as a black vertical line with a triangular handle. The part of the project currently visible in the Timeline is indicated by a blue rectangle in the Global Timeline view.

To move to a new area of the Timeline using the Global Timeline view:

- Drag the visible area rectangle to a new position.

Drag this rectangle to a new position.

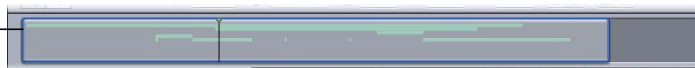

You can quickly move to different parts of the Timeline by dragging the blue rectangle. This is especially useful when working on longer projects. You can also drag the rectangle up or down to move vertically in the Global Timeline view. This is useful if your project contains more tracks, busses, and outputs than can be displayed in the Project window.

Using the Time Ruler

The Timeline has a Time ruler that shows the divisions of time in a project. You can set the playhead to a precise frame, point in time, or sample number using the Time-based units on the Time ruler, or to a specific musical measure or beat using the Beats-based units, to synchronize playback of audio clips in the Timeline.

The Time ruler changes depending on the time format of the project and the Time ruler units. If the project is currently set to Time-based format, Time-based units appear in the upper part of the ruler. If the project is set to Beats-based format, Beats-based units appear in the upper half of the ruler.



You can use the Time ruler to position clips or the playhead at a precise point in time, including synchronizing them to a specific timecode reference in a video file.

To set the playhead to a specific point in the Time ruler:

- Click the Time ruler at the point where you want to set the playhead.

Working With the Playback Region

You can create a *playback region* in a project, an area that plays back repeatedly. This is sometimes called “cycling” or “looping” playback. A project has only one playback region, but you can move and resize it as often as you want.

You also use the playback region when recording multiple takes. For information on recording, see Chapter 11, “Recording Audio in Soundtrack Pro,” on page 235.

To set the playback region:

- Drag in the bottom half of the Time ruler from the beginning of where you want the playback region to the end.

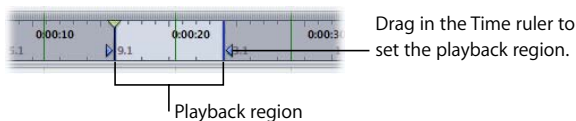

The playback region is lighter in color than the rest of the Time ruler, with triangular markers indicating its start and end points. If a playback region already exists, you can drag anywhere in the Time ruler outside of the current playback region to set the playback region to a new position.

If cycling is turned off, you must turn it on for the playback region to be active. The Cycle button darkens to indicate that the playback region is activated.

To activate the playback region:

- Click the Cycle button in the transport controls.

To move the playback region:

- Click in the bottom half of the playback region and drag it to a new position in the Timeline.

To resize the playback region:

- Select either the start point or end point handle in the Time ruler and drag to resize the playback region.

To remove the playback region:

- Click in any part of the Time ruler outside of the current playback region.

Working With Tracks, Busses, and Outputs in the Timeline

The Timeline is arranged into three groups of horizontal rows: tracks, busses, and outputs. You add audio to tracks in your project, use busses to create and control submixes, and send audio to physical output channels using outputs. Tracks, busses, and outputs are described in greater detail in “Tracks, Busses, and Outputs” on page 90.

The tracks in a project appear in the upper part of the Timeline. Busses appear below tracks, and outputs appear below busses. A separator between each group helps visually distinguish them, and disclosure triangles on each separator let you show or hide the groups.

Tracks, busses, and outputs in the Timeline correspond to channel strips in the Mixer. When you add a track, bus, or output, adjust its controls, or add effects, the same changes appear in the corresponding channel strip when you open the Mixer.

Adding Tracks, Busses, and Outputs

To add a track, do one of the following:

- Choose Multitrack > Add Track (or press Command-T).
- Control-click an open area of the Timeline, then choose Add Track from the shortcut menu.
- Control-click a track, then choose either Add Track Above or Add Track Below from the shortcut menu.

To add a bus, do one of the following:

- Choose Multitrack > Add Bus.
- Control-click a bus, then choose either Add Bus Above or Add Bus Below from the shortcut menu.

To add an output, do one of the following:

- Choose Multitrack > Add Output.
- Control-click an output, then choose either Add Output Above or Add Output Below from the shortcut menu.

Selecting Tracks, Busses, and Outputs

You can select a track, bus, or output in order to move, copy, or remove it, and can also select tracks, busses, and outputs to export. The headers of selected tracks, busses, and outputs appear darker in the Timeline.

To select a track, bus, or output, do one of the following:

- Click the drag handle along the left edge of the header for the track, bus, or output.
- Click anywhere in the row for the track, bus, or output in the Timeline.



You can select multiple tracks, busses, or outputs in the Timeline.

To select adjacent tracks, busses, or outputs:

- Shift-click the drag handle in the header of each track, bus, or output.

To select nonadjacent tracks, busses, or outputs:

- Command-click the drag handle in the header of each track, bus, or output.

Moving and Copying Tracks, Busses, and Outputs

As you work on your project, you may want to rearrange tracks, busses, and outputs. You can move and copy them to change their vertical arrangement in the track, bus, or output section of the Timeline. You cannot move one to the area for another (as indicated by the rows labeled “Tracks,” “Busses,” and “Outputs” in the Timeline).

You can only move or copy one track, bus, or output at a time.

To move a track, bus, or output:

- Drag the track, bus, or output drag handle up or down to a new vertical position. A light blue horizontal line in the header area indicates the place the track, bus, or output will be moved to when you release the mouse button.

To copy a track, bus, or output:

- Option-click the drag handle in the header for the track, bus, or output, then drag it up or down. A copy of the track, bus, or output appears when you release the mouse button.

Renaming Tracks, Busses, and Outputs

By default, tracks are numbered when created, and take the name of the first audio clip you add to them. Busses and outputs are numbered starting from one (Bus 1, Out 1, and so on). You can rename a track, bus, or output and use the names to distinguish the type of audio it contains (for example, dialogue, voiceovers, music, or sound effects), its part in the overall project, or to identify it in some other way.

To rename a track, bus, or output:

- Click the name field in the header for the track, bus, or output and type a new name.

Changing a Track, Bus, or Output Icon

You can choose a new icon from the icon grid, or add your own image to the grid.

To change the icon for a track, bus, or output, do one of the following:

- Click the icon, then select a new icon from the icon grid that appears.
- Drag a graphics file from the Finder to the icon.

Using the Track Controls

Tracks, busses, and outputs have headers, located along the left side of the Timeline. Each header contains track controls that you can use to mute or solo the track, bus, or output, adjust its volume level and pan position, add effects, and show or hide its envelopes.

Adjusting Volume

The volume slider controls the volume (the loudness relative to other tracks) of the track, bus, or output.

To adjust the volume level of a track, bus, or output:

- Drag the volume slider left or right.

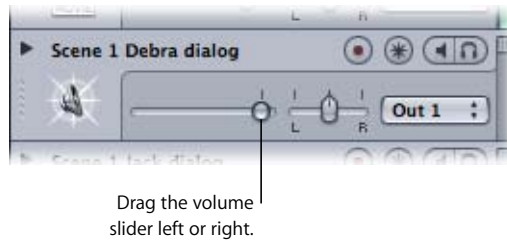

The range is -96 dB to $+6$ dB, with the default at 0 dB. Double-clicking the slider resets it to the 0 dB position.

Adjusting Pan Position

Tracks and busses also include a pan slider. The pan slider controls the *pan position* (the left-to-right placement in the stereo field) of the track.

To adjust the pan position of a track or bus:

- Drag the pan slider left or right.

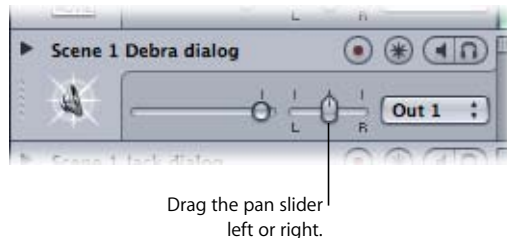

The range is -100 (full left) to $+100$ (full right), with the default at 0 (center position). Double-clicking the slider resets it to the center position.

Muting and Soloing Tracks, Busses, and Outputs

The Mute button *mutes* (silences) the track, bus, or output. You can mute multiple tracks, busses, and outputs, allowing you to hear only the remaining, unmuted ones. Muting lets you compare the sound of the project using different combinations of tracks, busses, and outputs, and hearing the result of changes you make to them.

To mute a track, bus, or output:

- Click the Mute button. Click the Mute button again to unmute the track, bus, or output.

Muted tracks, busses, and outputs appear darker in the Timeline, making it easy to identify which tracks are currently audible.

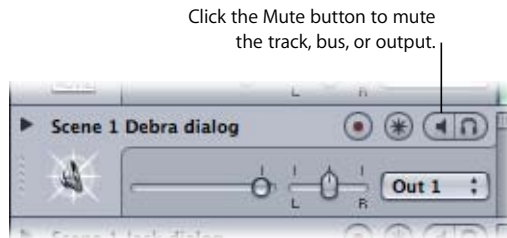

The Solo button *solos* the track, bus, or output, muting all others. Soloing a track, bus, or output lets you quickly isolate it from the rest of the project, so you can adjust the sound of the soloed track, bus, or output and make changes.

Soundtrack Pro supports *multiple solo* and *exclusive solo*. Clicking the Solo button for multiple tracks, busses, or outputs solos them and mutes all others. When you exclusively solo a track, bus, or output, all others are muted, regardless of whether they are soloed.

To solo a track, bus, or output (multiple solo):

- Click the Solo button. Click the Solo button again to unsolo the track, bus, or output.

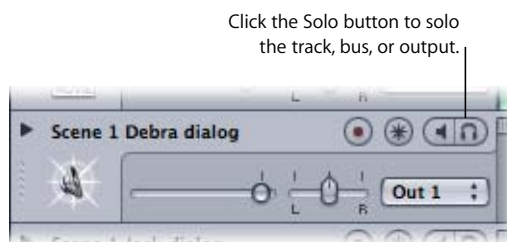

To exclusively solo a track, bus, or output:

- Option-click the Solo button. Click the Solo button again to unsolo the track, bus, or output.

When you solo tracks, busses, or outputs, the ones not soloed appear darker in the Timeline.

Changing Track Time Format

By default, tracks use the same time format as the project (Time-based or Beats-based). You can change the time format of a track, which changes the behavior of tagged clips when you change the project tempo.

When the track time format is Time-based, clips remain at the same time position (the same second or frame) when you change the project tempo. When the track time format is Beats-based, clips remain at the same beat position (the same measure, beat, and beat division) when you change the project tempo.

When you set a track to Beats-based time format, a metronome appears in the corner of the track icon.

To change a track's time format:

- 1 Select the track.
- 2 Choose Multitrack > Track Time Base, then choose a format from the submenu.

Adding Effects to a Track, Bus, or Output

Clicking the Effects button in the header for a track, bus, or output displays the Effects tab, which you use to add effects. The Effects tab also displays any effects currently assigned to the track, bus, or output.

To add effects to a track, bus, or output:

- 1 Click the Effects button in the header for the track, bus, or output.

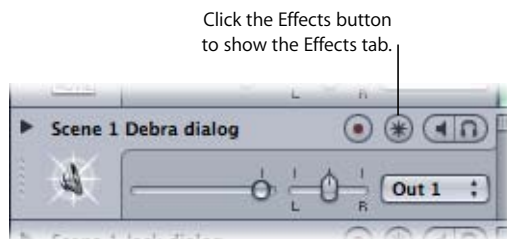

- 2 In the Effects tab, select a category in the Category list to display the effects for that category in the Effect list.



- 3 In the Effect list, do one of the following:
 - Double-click the effect you want to add.
 - Select the effect name, then click the Add Effect button.
 - Drag the effect to the Effect Parameters area.

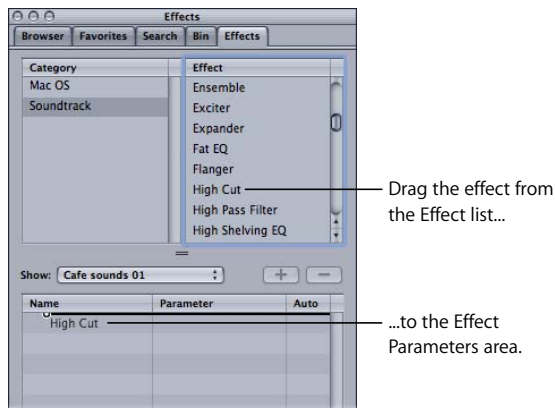

The effect now appears in the Effect Parameters area with its checkbox selected.

When you add effects to a track, bus, or output, the Effects button changes color to indicate that the track, bus, or output contains effects.

For detailed information about adding and adjusting effects, see Chapter 9, “Working With Audio Effects,” on page 195.

Showing and Hiding Track, Bus, and Output Envelopes

Clicking the automation disclosure triangle for a track or bus shows the volume and pan envelopes, which you can use to automate changes to pan position and volume level over the course of the project. Clicking the triangle for an output shows the output's volume envelope. The envelopes appear in the Timeline below the track, bus, or output. You can also add envelopes for effect parameters, which appear below the other envelopes. For information on adding envelopes for effect parameters, see Chapter 9, "Working With Audio Effects," on page 195.

To show the envelopes for a track, bus, or output:

- Click the envelopes disclosure triangle in the header for a track, bus, or output. Click the disclosure triangle again to hide the envelopes.

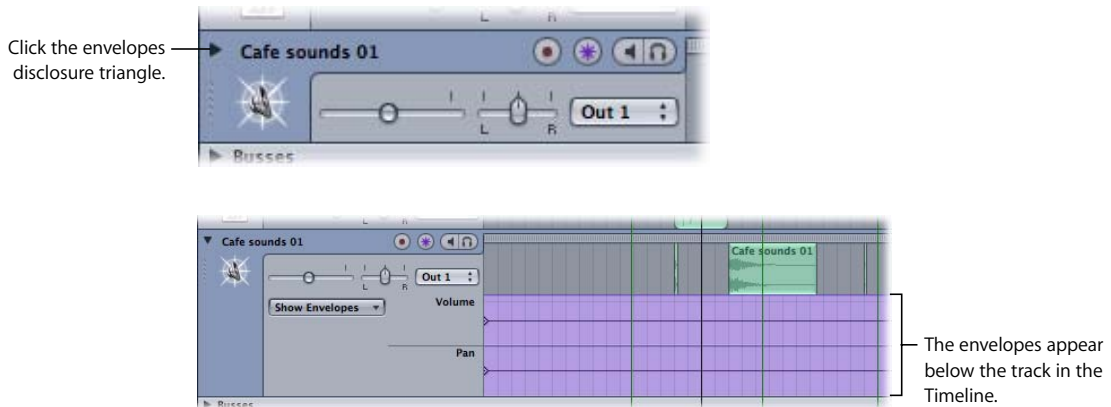

Note: If you automate controls or effects using envelopes, you hear the results whether or not the envelopes are visible.

For information on automating changes to volume, pan, and other settings, see Chapter 10, "Working With Automation," on page 219.

Removing Tracks, Busses, and Outputs

You can remove a track, bus, or output if you decide you no longer want it in a project.

To remove a track, bus, or output, do one of the following:

- Select the track, bus, or output, then choose Multitrack > Remove [item] (or press Command-Shift-T).
- Control-click in the track, bus, or output, then choose Remove [item] from the shortcut menu.

The [item] changes depending on whether a track, bus, or output is selected.

Editing Audio Clips in the Timeline

You can edit audio clips in a variety of ways in the Timeline. You can select, cut, copy, and paste clips, move, resize, transpose, split and join them, and edit them in other ways.

Selecting Audio Clips

You select the audio clips you want to edit. You can select a single clip or multiple clips, including clips in different tracks. When you select a clip, it appears darker than unselected clips.

To select an audio clip:

- Click the clip in the Timeline.

To select multiple audio clips in the same track, do one of the following:

- Command-click the clips in the Timeline.
- Drag from a point in the track before the first clip you want to select to a point after the last clip you want to select, encompassing the clips.
- If the clips are adjacent, Shift-click the clips in the Timeline.

To select multiple audio clips in different tracks:

- Shift-click or Command-click the clips in the Timeline.

To select all clips using the same source audio file, do one of the following:

- Select the clip in the Timeline or the Bin tab, then choose Clip > “Select All Occurrences of [filename].”
- Control-click the source audio file in the Bin tab, then choose “Select All Occurrences of [filename]” from the shortcut menu.

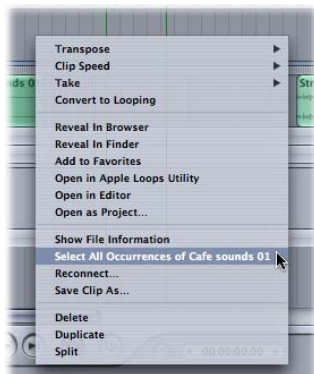

Cutting, Copying, and Pasting Audio Clips

You can cut, copy, and paste audio clips in the Timeline. You can also paste multiple copies of a clip.

To cut an audio clip:

- Select the clip in the Timeline, then choose Edit > Cut (or press Command-X).

The clip is removed from the Timeline and placed on the Clipboard.

To copy an audio clip, do one of the following:

- Select the clip in the Timeline, then choose Edit > Copy (or press Command-C).
- Option-drag the clip to the position where you want to copy it.

To paste an audio clip:

- Set the playhead at the position where you want to paste the clip, then choose Edit > Paste (or press Command-V).

The clip is pasted in the currently selected track, starting at the current playhead position. If no track is selected, the clip is pasted in the track from which it was cut or copied.

When pasting clips cut or copied from different positions in the Timeline or from multiple tracks, the following conditions apply:

- *Pasting clips from different Timeline positions:* The clip closest to the beginning of the project is pasted at the current playhead position, and the remaining clips are pasted at the same positions in time relative to the first clip as when they were cut or copied.
- *Pasting clips from multiple tracks:* The clip from the topmost track is pasted in the currently selected track, and the remaining clips are pasted at the same positions relative to the first clip as when they were cut or copied. If there are not enough tracks to accommodate the clips being pasted, a dialog appears asking if you want to create new tracks for the clips. If you choose not to create new tracks, only the clips for which tracks already exist are pasted.

When pasting audio clips, you can choose to paste multiple copies of the clip in succession. Using the Paste Repeat command, you can paste any number of copies of a clip in the selected track.

To paste multiple copies of a clip:

- 1 Cut or copy the clip.
- 2 Set the playhead to the point you want to paste the first copy of the clip.
- 3 If you want to paste the copies in a different track, select the track.
- 4 Choose Edit > Paste Special > Paste Repeat (or press Option-Command-V).
- 5 In the Paste Repeat sheet, enter the number of times you want to paste the clip.

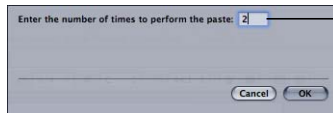

Type the number of times you want to paste the clip in the Paste Repeat sheet.

The copies are pasted in the selected track, starting at the current playhead position. If no track is selected, the copies are pasted in the same track as the cut or copied clip.



The copies are pasted in the selected track, starting at the current playhead position.

Moving Audio Clips

You can move an audio clip in the Timeline by dragging the clip to a new position. You can also move the clip to a different track.

To move an audio clip to a new time position:

- Drag the clip left or right to a new position in the Timeline.

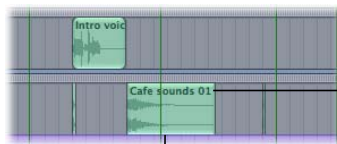

Drag a clip up or down to move it to a different track.

Drag a clip left or right to move it to a new position.

To move an audio clip to a new track:

- Drag the clip up or down to a different track.

You can also move an audio clip using the Left and Right Arrow keys with various modifier keys. Using the Option key with the Arrow keys moves the clip by one pixel at a time; using the Option and Shift keys with the Arrow keys moves the clip to the next gridline in the Timeline.

When you move a clip by one pixel, the amount the clip moves in time depends on the current zoom setting.

To nudge an audio clip in pixel increments:

- Hold down the Option key while you press the Left or Right Arrow key.

To nudge an audio clip to the next gridline:

- Hold down the Option and Shift keys while you press the Left or Right Arrow key.

Snapping Clips to Clips on Adjacent Tracks

If snap is turned on, you can snap a clip to the edges of a clip in an adjacent track (the track either directly above or directly below the track containing the clip). This is especially useful when the start and end points of clips do not fall on the current Snap To value.

To snap a clip to adjacent clips:

- Choose View > Snap To > Adjacent Tracks.

Resizing Audio Clips

You control the duration of an audio clip (the amount of time the clip plays back) by resizing the clip. When you add a clip to the Timeline, the clip has the same duration as the source audio file. You can shorten clips to play back only a part of the source file. When you lengthen a clip with looping playback mode, it repeats the source file multiple times.

To resize an audio clip:

- 1 Place the pointer at either the left or right edge of the audio clip.
The pointer changes to a Clip Resize pointer.
- 2 Click the edge of the clip and drag left or right to resize it.

When you lengthen a clip with looping playback mode, the notches at the top and bottom of the clip indicate the end of each repetition of the source audio file.

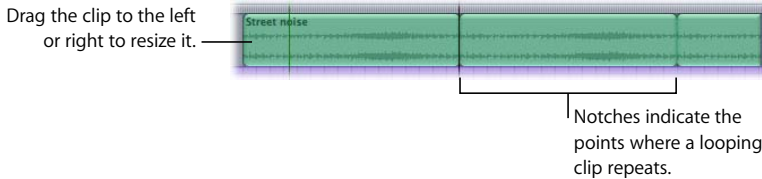

When you resize a clip by shortening its left edge, you change the point in the source audio file at which the clip starts playing, making the earlier part of the source audio inaudible. When you resize a clip by shortening its right edge, the part you shorten becomes inaudible. You cannot lengthen the left edge of a clip with non-looping playback mode beyond the beginning of the source audio file.

When you resize a clip, the edge being resized jumps to the nearest Snap To position if snap is turned on. If you want to resize the clip independently of the Snap To value, change the Snap To value, or turn off snap before you resize the clip. For information about snap, see "Using Snap" on page 72.

Creating Crossfades Between Audio Clips

Soundtrack Pro lets you easily create crossfades between two audio clips in the Timeline. *Crossfades* let you create smooth transitions between one audio clip and the next, and avoid clicks or sudden changes in loudness that can result when placing audio files one after another.

To create a crossfade between audio clips, you set the project to crossfade mode, then drag an audio clip so that it overlaps another clip. A crossfade is created for the length of the overlapped area.

To set the project to crossfade mode:

- Click the Crossfade Mode button, located above the Global Timeline view.

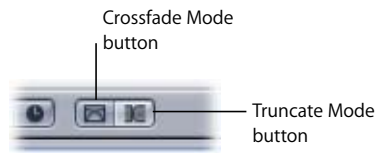

In crossfade mode, when you drag an audio clip so that it partially overlaps another audio clip in a track in the Timeline, a crossfade is created for the overlapped part of the two audio files. You can adjust the boundaries of the crossfade in the Timeline.

To create a crossfade:

- In the Timeline, drag an audio clip so that it overlaps another audio clip. The crossfade appears in the overlapped area of the two clips.

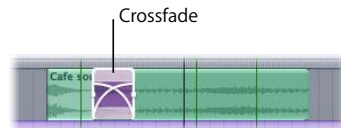

You can adjust crossfades in several ways. You can change the edges of the crossfaded clips or move the position of the crossfade without changing its length.

To adjust crossfade boundaries:

- 1 Move the pointer over the left or right edge of the crossfade. The pointer becomes a crossfade pointer.
- 2 Drag the edge of the crossfade to adjust the crossfade boundary.

To move the crossfade without changing its length:

- Drag the lower area of the crossfade left or right. As with other edits you make in the Timeline, creating a crossfade between two audio clips does not change the source audio files.

Truncating Overlapping Audio Clips

You can have Soundtrack Pro truncate the overlapping part of audio clips in the Timeline instead of crossfading them. To truncate audio clips, you set the project to truncate mode, then drag an audio clip so that it overlaps another clip.

To set the project to truncate mode:

- Click the Overlap Mode button, located above the Global Timeline view.

In truncate mode, when you drag an audio clip so that it partially overlaps another audio clip in a track in the Timeline, the overlapped part of the clip is truncated.

To truncate an audio clip:

- In the Timeline, drag another audio clip over part of the clip.

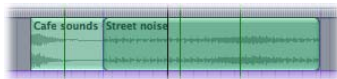

Splitting and Joining Audio Clips

You may want to use only part of the source audio file in an audio clip. Soundtrack Pro lets you split the clip into segments and use the segments in the Timeline as independent clips. You can move the segments, edit them, and split each one into additional segments.

There are two ways to split clips: using the Split (razor) tool, or using the Split menu item in the Edit menu with the playhead. Each method has advantages, depending on the situation. Using the Split tool, you can perform many splits consecutively without moving the playhead each time. Using the playhead, you can split clips in several tracks at once.

To split audio clips with the Split tool:

- 1 Click the Split Tool button above the Timeline.



- 2 Click a clip at the point where you want to split it.

To split audio clips with the playhead:

- 1 Set the playhead at the point where you want to split the clip, then select the clip or clips you want to split.

You can split multiple clips in the same operation.

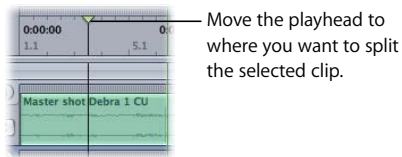

- 2 Choose Edit > Split (or press S).

Every selected clip under the playhead is split into two segments. The first segment ends at the playhead position, and the second segment begins at the playhead position.

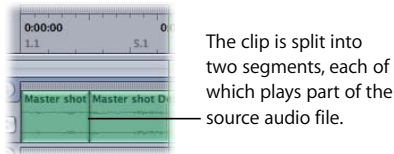

You can join clips from the same original audio file, including segments of split clips. Clips being joined must be adjacent to each other and in the same track.

To join audio clips:

- 1 Place the clips next to each other in the same track.
- 2 Select the clips, then choose Edit > Join (or press J).

When you join looping files or segments of looping files, the joined file plays to the end of the source audio file before looping. The notches in the joined file indicate the end of the source audio file.

Transposing Tagged Audio Clips

When you drag an audio file tagged with key information to the Timeline, Soundtrack Pro transposes the clip to the project key. You can transpose tagged clips to another key to create chord progressions from the same audio file or to achieve other musical effects. You can transpose a tagged clip to any interval from one octave above (+12 semitones) to one octave below (–12 semitones) its current key.

Note: Soundtrack Pro uses the key tag in the audio file to transpose it. In order to be correctly transposed, the file must be tagged.

To transpose a tagged audio clip, do one of the following:

- Select the clip, choose Clip > Transpose, then choose the number of semitones by which you want to transpose the clip up or down.
- Control-click the clip in the Timeline, choose Transpose from the shortcut menu, then choose the number of semitones by which you want to transpose the clip up or down.

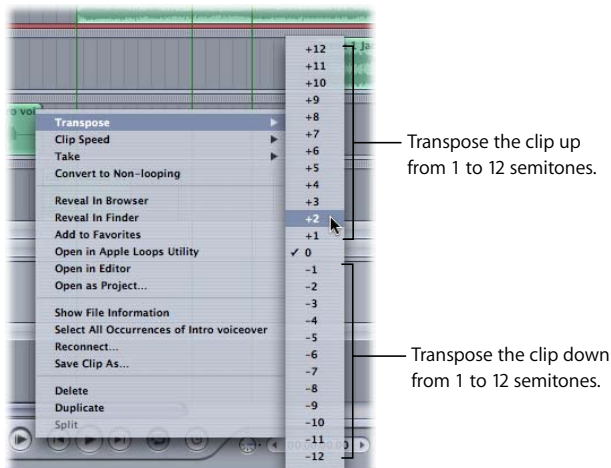

When Soundtrack Pro matches audio clips to the project key, it transposes the clips using the smallest appropriate interval. For instance, when matching a clip recorded in the key of D with a project in the key of A, the clip is transposed down five semitones (–5) rather than being transposed up seven semitones (+7), although either transposition would put the clip in the project key.

Transposing clips can lead to undesirable results, such as when the sound of the instrument recorded in the clip is moved outside its natural range. If the sound of a clip changes in an unsatisfactory way, you can try transposing the clip up or down by an octave (12 semitones) and see if you like the result better.

The following table shows the correspondence between semitones and musical intervals for transposing clips:

Number of semitones (+/-)	Musical interval
1	Minor second
2	Major second
3	Minor third
4	Major third
5	Perfect fourth
6	Tritone (diminished fifth)
7	Perfect fifth
8	Minor sixth
9	Major sixth
10	Minor seventh
11	Major seventh
12	Octave

Changing the Offset of an Audio Clip

When you add an audio clip to the Timeline, the clip plays back from the beginning of the source audio file. The point in the audio file where the clip starts playing is called the *offset*. By default, a clip's offset is zero, the beginning of the source audio file. You can change the offset so that the clip starts playing from a later point in the source audio file. This allows you to use the audio from a later part of the source file without splitting the clip.

To change the offset of a clip:

- Select the clip, then Command-Option-drag left (toward the beginning of the project).

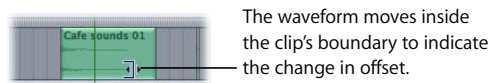
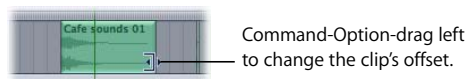

Once you have changed the offset by dragging to the left, you can also drag to the right to change the offset.

Note: You can only drag the offset to a later part of the clip's source audio file, not to a point before the beginning of the file.

When you change the offset of a clip, the waveform moves inside the clip's boundary to indicate the change in offset. The length of the clip stays the same. If the clip has not been resized, it will reach the end of the source audio file and start looping. As you move the offset by dragging, the clip's notches move to show the point at which the clip will start looping.

Changing a Clip's Playback Mode

Audio files you add to the Timeline can be either looping or non-looping. Looping files are special audio files that can be used to create repeating patterns, and include musical phrases useful for creating music beds. Audio files containing discrete, non-rhythmic sounds, sound effects, and other non-musical sounds such as dialogue or sound effects should be used as non-looping files in most cases.

When you add an audio file to the Timeline, the audio file is added as a clip with non-looping playback mode unless the audio file is tagged as a looping file. You can change the playback mode of a clip after you add it to the Timeline.

To convert the playback mode to looping, do one of the following:

- Select the clip, then choose Clip > Convert to Looping.
- Control-click the clip in the Timeline, then choose Convert to Looping from the shortcut menu.

To convert the playback mode to non-looping, do one of the following:

- Select the clip, then choose Clip > Convert to Non-Looping.
- Control-click the clip in the Timeline, then choose Convert to Non-looping from the shortcut menu.

Replacing the Source Audio in a Clip

Each audio clip in the Timeline has a set of properties specific to the clip, including duration, speed, and transposition. You can replace the source audio in the clip while preserving the clip's properties. This feature has a variety of uses, such as letting you try out similar audio files (for example, music beds or sound effects) while maintaining the clip's duration, position in the Timeline, and transposition.

For information about properties of audio clips, see "Reconnecting Media Files" on page 74.

To replace the source audio file for a clip:

- 1 In the Timeline, select the clip for which you want to replace the source audio.
- 2 Do one of the following:
 - In the Media and Effects Manager, select the audio file you want to replace the selected clip's audio with, then choose Clip > "Replace Selected Loops With [filename]."
 - In the Media and Effects Manager, Control-click the audio file you want to replace the selected clip's audio with, then choose "Replace Selected Loops With [filename]" from the shortcut menu.

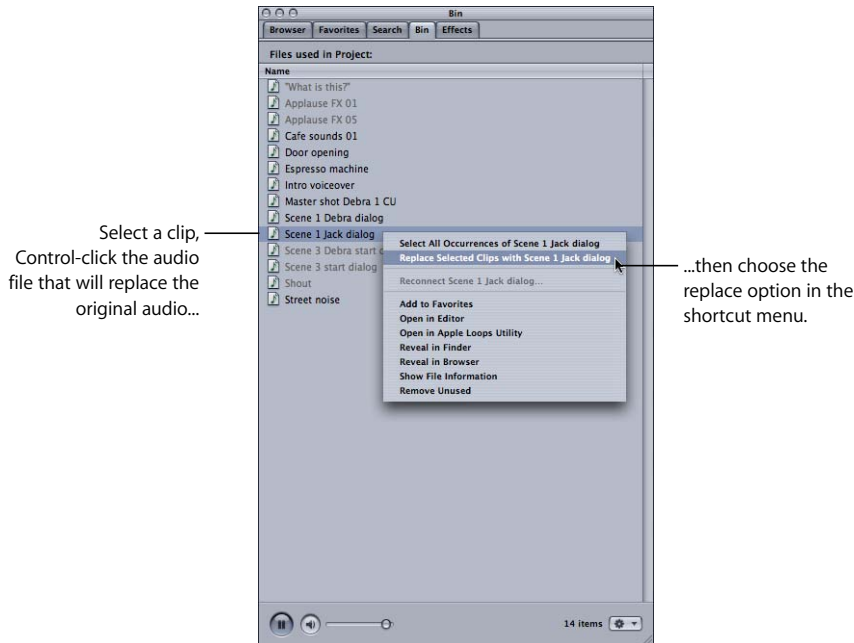

When you replace the source audio in a clip, the clip's duration and offset stay the same. Only the portion of the new source audio file equal to the clip's length plays. If the new source audio file is shorter than the clip's length, the clip loops when it reaches the end of the new source audio file. Notches appear on the clip to indicate the point at which the clip starts looping.

You can replace the source audio in all clips using the same source audio file with another source audio file by using the Select All Occurrences and Replace Selected Loops commands together.

To replace the source audio file in all clips using the same source file:

- 1 Select all occurrences of the clip for which you want to replace the source audio file, following the steps described in “Selecting Audio Clips” on page 107.
Every clip using the same source audio file is selected.
- 2 Replace the source audio file with another source audio file, following the steps described in “Replacing the Source Audio in a Clip” on page 117.

Removing Audio Clips

As you work on a project, you may decide that a clip that sounded great on its own no longer fits with the overall composition. You can remove clips from a project by deleting them from the Timeline.

To remove an audio clip:

- Select the clip, then choose Edit > Delete (or press the Delete key).

Working With Markers

Markers have a variety of uses in the Timeline and the Waveform Editor. For example, you can use markers to:

- Mark the start and end points of major sections in your project
- Indicate places you want to come back to and work on later
- Mark points where you want to synchronize the audio with the picture in a video
- Indicate where particular sounds begin and end in an audio file

Markers extend vertically through the Timeline, like the playhead. Each marker has a handle in the area above the Time ruler, letting you position the marker precisely in the Timeline.

Types of Markers

Soundtrack Pro displays Final Cut Pro HD scoring markers, and lets you add your own markers to a project. You can add two kinds of markers: time markers and beat markers. The two types can be distinguished by their handles: Time markers have green handles, and beat markers have purple handles. Final Cut Pro HD scoring markers have orange handles.

This section discusses how to work with time markers and beat markers in a project. For information about working with Final Cut Pro HD scoring markers, see “Using Final Cut Pro Scoring Markers” on page 191.

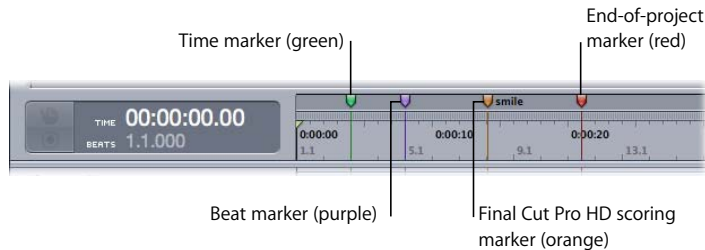

Inserting Markers

You can insert a beat marker or time marker at any point in the Timeline or Waveform Editor.

To insert a beat marker:

- Set the playhead to the point where you want to add the marker, then choose Project > Insert Beat Marker (or press the B key).

To insert a time marker:

- Set the playhead to the point where you want to add the marker, then choose Project > Insert Time Marker (or press the M key).

Naming Markers

You can name time markers and beat markers, so that each marker can provide a unique visual cue to a specific point in the Timeline or Waveform Editor. For example, you can name markers to define sections of your project (Introduction, Verse, or Chorus), to reflect what's happening in the music (Latin Rhythm or Fast Groove), or to serve as reminders for your workflow (Add Horns Here, Transpose to D, Insert Delay Effect).

To name a beat marker or time marker, do one of the following:

- Control-click the marker handle, choose Edit from the shortcut menu, type a name in the Marker Name field of the dialog that appears, then click OK.
- Make the Details tab active, select the marker, then type a name in the Name field of the Details tab.

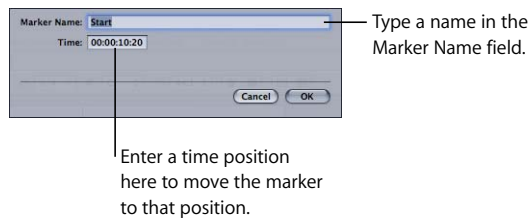

To view marker titles in the Timeline:

- Choose View > Show Marker Titles.

Moving Markers

You can move a marker either by dragging the marker's handle, or by entering a new position for the marker in an Edit dialog.

To move either a beat marker or time marker, do one of the following:

- Drag the marker by its handle, located in the area above the Time ruler, to a new position in the Timeline.
- Show the Details tab, click the marker you want to move, then enter a new position in the Position field.
- Control-click the marker handle, choose Edit from the shortcut menu, then type a new position in the Time field.

You can also select and drag multiple markers. When you move a marker by dragging, the marker's position snaps to the nearest Snap To position if snap is turned on. For information on setting the Snap To value, see "Creating Crossfades Between Audio Clips" on page 111.

Deleting Markers

To delete a marker:

- Click the marker handle to select the marker, then choose Edit > Delete (or press Delete).

You can't delete Final Cut Pro scoring markers in Soundtrack Pro.

The Mixer gives you the tools to create sophisticated mixes for your projects.

When you have added audio clips to your project and placed them in the Timeline, you mix the project. Mixing is where you balance different elements, such as dialogue, music, and sound effects, bring focus to key moments and events in the project, and create a sense of perspective by placing sounds in space. When you finish mixing, you have one or more final mixes that you can export.

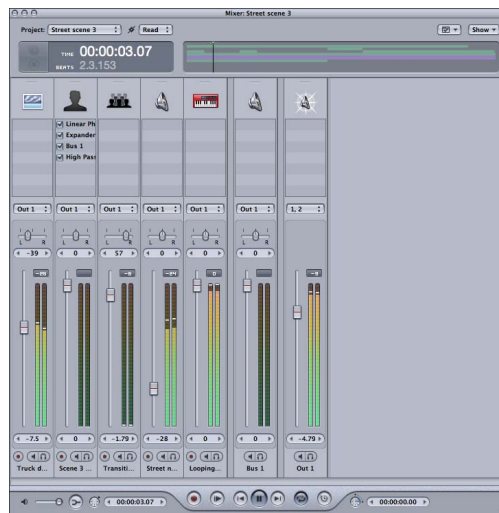

Soundtrack Pro gives you professional mixing capabilities, including the ability to create submixes and to send audio to multiple physical outputs. The Mixer provides a visual representation of your project in a virtual mixing console, with channel strips where you control different aspects of the sound. You can adjust volume and pan, mute and solo tracks, choose track outputs, add effects, and observe levels as the project plays.

Steps in Mixing

Mixing a project typically involves the following steps:

- Balancing relative volume levels
- Panning tracks to create perspective
- Adding EQ, compression, and other processing using effects
- Using automation to create changes over time
- Setting the overall project volume and eliminating clipping

You can perform these steps in any order, and move back and forth between them as you create the mix. In most situations, you finish mixing the individual tracks before making changes to the overall project. The following suggested order provides a guideline that may be useful for common situations:

Step 1: Mix main voice tracks

Solo the main voice tracks and pan to center. Add any EQ, compression, or other processing. Adjust relative volume, leaving some headroom (typically around -6 dB) in case you need to raise levels later.

Step 2: Mix other voice and middle ground tracks

With main voice tracks still soloed, solo the other dialogue, ADR, and voiceover tracks one at a time and adjust volume and pan relative to the main voice tracks. Add any processing if needed.

Step 3: Mix background tracks

With the previously mixed tracks still soloed, solo the background tracks one at a time and adjust volume and pan relative to the other tracks. Add any processing if needed.

Step 4: Make changes to the overall mix

Once you have mixed all the individual tracks in your project, add any EQ, compression, or other processing to the overall project. Adjust the overall volume to an appropriate level and remove any clipping before exporting the project.

Working With Channel Strips in the Mixer

The Mixer features a series of vertically arranged controls called *channel strips*, like the channel strips in a hardware mixing console. The channel strips in the Mixer correspond to the tracks, busses, and outputs in the project Timeline.

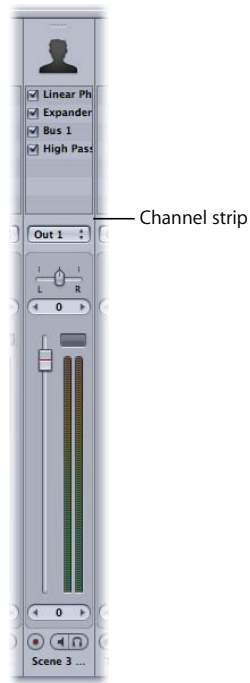

The controls a channel strip contains depend on whether it is a track, bus, or output channel strip. The controls for each type are as follows:

Track channel strips	Bus channel strips	Output channel strips
Drag handle	Drag handle	Drag handle
Icon	Icon	Icon
Effects slots	Effects slots	Effects slots
Output pop-up menu	Output pop-up menu	Output pop-up menu
Pan slider and value slider	Pan slider and value slider	—
Volume fader and value slider	Volume fader and value slider	Volume fader and value slider
Level meters with peak indicator	Level meters with peak indicator	Level meters with peak indicator
Record Enable button	—	—
Mute button	Mute button	Mute button
Solo button	Solo button	Solo button
Name	Name	Name

The channel strips in the Mixer make it easy to see the settings for all the tracks, busses, and outputs in your project at once, and to adjust those settings relative to each other as you create the overall mix.

In the Mixer, the channel strips appear in order corresponding to their order in the Timeline. Top-to-bottom order in the Timeline corresponds to left-to-right order in the Mixer. You can reorder tracks in the Mixer, and have the new order reflected in the Timeline. Changes you make to controls such as volume and pan also show up in the track controls when you open the project in the Timeline.

Adding Channel Strips to the Mixer

You can add a channel strip for a track, bus, or output in the Mixer in the same way you add a track, bus, or output in the Timeline.

To add a track channel strip:

- Choose Multitrack > Add Track.

To add a bus channel strip:

- Choose Multitrack > Add Bus.

To add an output channel strip:

- Choose Multitrack > Add Output.

Selecting Channel Strips

You can select a channel strip in order to move, copy, or remove it. Selected channel strips appear darker in the Mixer.

To select a channel strip, do one of the following:

- Click the drag handle at the top of the channel strip.
- Click any empty part of the channel strip.

You can select multiple channel strips in the Mixer.

To select adjacent channel strips:

- Shift-click the channel strips you want to select.

To select nonadjacent channel strips:

- Command-click the channel strips you want to select.

Reordering Channel Strips

You can change the order of channel strips in the Mixer. When you open the Mixer, the order of channel strips corresponds to the order of tracks, busses, and outputs in the Timeline. Because channel strips are oriented horizontally in the Mixer, top-to-bottom order in the Timeline corresponds to left-to-right order in the Mixer. Reordering channel strips in the Mixer also changes their order in the Timeline.

In the Mixer, as in the Timeline, channel strips of the same type (track, bus, or output) are grouped together. You can reorder a channel strip within its own group, but cannot move it to a group of a different type. You can only move one channel strip at a time.

To reorder a channel strip:

- Drag the channel strip by its drag handle left or right to a new position.

Copying Channel Strips

You can copy channel strips in the Mixer. You can copy a channel strip within its own group, but cannot copy it to a group of a different type. You can only copy one channel strip at a time.

To copy a channel strip:

- Option-click the channel strip's drag handle, then drag it left or right.

A copy of the channel strip appears when you release the mouse button.

Setting Channel Strip Volume Levels

You set relative volume levels to balance the various parts of the project. You set the volume level of a channel strip using the channel strip volume fader or value slider.

Different sounds can have different apparent loudness at the same volume level, so perceived loudness does not precisely correspond to numeric values on the volume faders. You determine the appropriate volume level by listening to the track and adjusting its level in the overall mix.

To set the volume level of a channel strip, do one of the following:

- Drag the volume fader up to raise (increase) the volume, or drag it down to lower (decrease) the volume.
- Click along the length of the volume fader at the point you want to set the volume level.
- Click the left or right arrows on the edges of the volume value slider.
- With the pointer over the center of the volume value slider, hold down the mouse button and drag left or right.
- Click the center of the volume value slider, then type a new value.

The scale is from -96 to $+6$ dB. The default level is 0 (zero) dB.

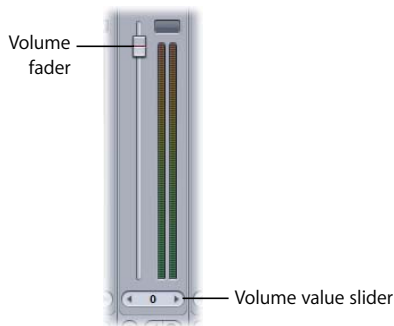

To return the volume fader to the default level:

- Double-click the knob in the volume fader.

As you adjust track volume, watch the level meters next to the volume fader to make sure that the track is not clipping. For information about preventing clipping, see “Setting the Overall Project Volume Level” on page 138.

Setting Channel Strip Pan Position

You pan sounds to different positions to place them in the stereo field from left to right. You set the pan position of a track or bus channel strip using the channel strip pan slider or value slider. You can't pan an output channel strip.

To set the pan position of a channel strip, do one of the following:

- Drag the pan slider left or right to the pan position you want.
- Click along the length of the pan slider at the point you want to set the pan position.
- Click the left or right arrow on the edges of the pan value slider.
- With the pointer over the center of the pan value slider, hold down the mouse button and drag left or right.
- Click the center of the pan value slider, then type a new value.

The scale is from -100 to 100, with 0 (zero) as the center value. Negative values are left of center, and positive values are right of center. The default is 0.

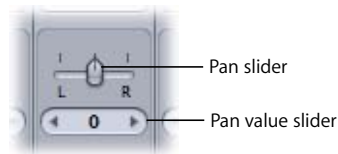

To return the pan slider to the default level:

- Double-click the knob in the pan slider.

Setting Channel Strip Output

On a hardware mixing console, you can send signals to different physical outputs. You can create outputs in Soundtrack Pro, assign tracks and busses to different outputs, and assign outputs to physical output channels on connected audio devices. You can send audio from as many tracks and busses to the same output as you want.

To set the output for a track or bus:

- In the channel strip for the track or bus, choose the output from the Output pop-up menu.

For outputs in the Mixer, the Output menu lists the available physical output channels (and channel pairs) for audio output devices connected to your computer.



To set the physical output channel for an output in the Mixer:

- In the channel strip for the output, choose the physical output channel, or pair of channels, from the Output pop-up menu.

Note: You can create outputs independently of the audio hardware connected to your computer, and route audio to an output that does not correspond to a physical output. In most situations, each output in a project should correspond to a physical output on the audio interface or other hardware connected to your computer. Outputs that do not correspond to a physical output will not be heard. You may set as many outputs in a project to the same physical output device or output channel as you like.

Muting and Soloing Channel Strips

You can mute and solo channel strips in the Mixer in order to hear or silence specific tracks, busses, or outputs.

To mute a channel strip:

- Click the channel strip's Mute button. Click the button again to unmute the channel strip.

To solo a channel strip:

- Click the channel strip's Solo button. Click the button again to unsolo the channel strip.

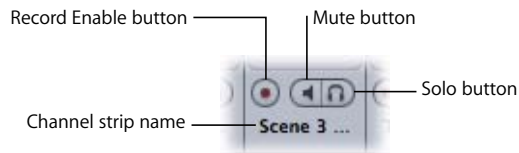

To exclusively solo a channel strip:

- Option-click the Solo button. Click the Solo button again to unsolo the track, bus, or output.

When you export a project, all unmuted tracks, busses, and outputs are included in the exported file. If you export a track, bus, or output that is muted (including being muted by having another track soloed), the exported file will contain no audio.

Enabling Track Channel Strips for Recording

You can enable a track channel strip for recording. When you enable a track channel strip for recording, audio will be recorded on the track when you click the Record button in the transport controls. You can't record to a bus or output channel strip.

To enable a track channel strip for recording:

- Click the Record Enable button in the channel strip. Click the button again to disable the channel strip for recording.

You can record only to a track, not to a bus or an output.

Renaming Channel Strips

You can rename a channel strip to help you remember its content or purpose in the overall mix.

To rename a channel strip:

- Click the channel strip's name (at the bottom of the channel strip) to select it, then type a new name.

Changing a Channel Strip Icon

You can change the icon of a channel strip. Icons do not affect the sound, but are useful as a quick visual reference for the channel strip, particularly for projects with many tracks, busses, or outputs.

To change a channel strip icon:

- Press and hold the icon you want to change, then choose a new icon from the icon menu.



Showing and Hiding Sections of the Mixer

You can show or hide sections of the Mixer window and of the channel strips. Hiding sections of the Mixer and the channel strips can be helpful especially when using Soundtrack Pro with a smaller computer display, or when working on projects with a large number of tracks, busses, or outputs.

You can show or hide any of the following sections of the Mixer:

- Navigation display (Time display and Global Timeline view)
- Transport controls
- Tracks
- Busses
- Outputs

To hide a section of the Mixer:

- Choose the section you want to hide from the Show pop-up menu, located at the upper right of the Mixer.

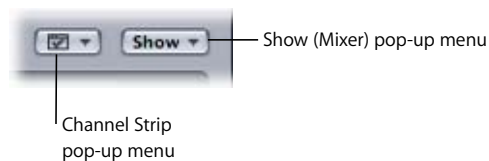

You can show or hide any of the following sections of the channel strips:

- Icons
- Effects slots
- Output pop-up menus
- Pan controls
- Volume faders and level meters

To hide a section of the channel strips:

- Choose the section you want to hide from the Channel Strip pop-up menu.

The visible sections of the channel strips appear with a checkmark in the Channel Strips pop-up menu.

Using the Channel Strip Level Meters

Each channel strip includes stereo level meters to the right of its volume fader. You can use the level meters to observe each channel strip's level as the project plays. The level meters range from -96 dB to 0 dB, moving from bottom to top as the level increases. The segments of the level meters run from green through yellow to orange as the level increases.

At the top of each set of level meters is a peak indicator. As the project plays, the value in decibels of the highest level reached appears in the peak indicator. If the level rises above 0 dB, the peak indicator becomes red and shows the value 0 (zero). The values shown in each peak indicator remain until you play the project again, close the project, or reset the peak indicator.

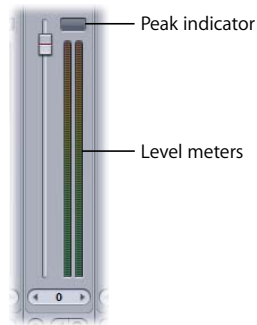

To reset a peak indicator:

- Click the peak indicator.

To reset all peak indicators, do one of the following:

- Option-click the peak indicator in any channel.
- Click the Reset button in the Meters tab of the Utility window.

The peak indicators can help identify where clipping occurs in the project. For information about removing clipping, see “Setting the Overall Project Volume Level” on page 138.

Removing Channel Strips

You can remove a channel strip from the Mixer if you decide you no longer want it in the project.

To remove a channel strip:

- 1 Select the channel strip.
- 2 Choose Multitrack > Remove [item].

The term indicated by [item] changes in the menu depending on whether a track, bus, or output is selected.

Note: If audio from a track is sent to a bus or output, and you remove the bus or output, the audio from the track will not be heard when you play the project.

Working With Effects and Sends in the Mixer

You can add effects to a channel strip in the Mixer, show effects settings, turn effects on and off, replace an effect, and delete effects. You can also adjust effects settings in the Effects tab or in the effect's advanced settings window.

Adding Effects to a Channel Strip

You can add effects, turn effects off and on, and reorder effects in a channel strip.

Note: Before adding an effect to a track, it's a good idea to solo the track so that you can hear how the effect changes its sound, separate from the other tracks in the project.

To add an effect to a channel strip:

- Control-click an empty effects slot in the channel strip, choose Add Effect from the shortcut menu, then choose one of the available effects from the categories in the submenu.



Showing Channel Strip Effects Settings

Once you add an effect, you can view and adjust its settings in the Effects tab.

To show an effect's settings in the Effects tab:

- In the channel strip, Control-click the effect, then choose Show *[effect name]* Settings from the shortcut menu.

The Effects tab becomes active, and shows the selected effect's settings.

To show an effect's settings in the Effects tab:

- In the channel strip, Control-click the effect, then choose Show *[effect name]* Settings from the shortcut menu.

The Effects tab becomes active, and shows the selected effect's settings.

Some effects have a floating advanced settings window with sliders and other controls you can use to adjust effect parameters.

To show advanced settings for an effect, do one of the following:

- Double-click the effect name in the channel strip.
- Control-click the effect, then choose Show *[effect name]* Advanced Settings from the shortcut menu.

The effect's advanced settings window appears.

For information on working in the advanced settings window, see "Advanced Settings for Realtime Effects" on page 215.

Reordering Effects in the Mixer

You can reorder effects in the Mixer as well as in the Effects tab. When you reorder effects, you change the order in which the audio is processed by each effect, which can change the sound drastically.

To reorder an effect in the Mixer:

- Drag the effect up or down in the effects slot area to change its order.

Turning Effects Off and On

You can turn off a channel strip's effects. Turning off an effect lets you hear the channel strip without the effect, while preserving the current effects settings.

To turn off an effect in a channel strip, do one of the following:

- Deselect the checkbox to the left of the effect name.
- Control-click the effect, then choose *Disable [effect name]* from the shortcut menu.

To turn off all effects in a channel strip:

- Control-click an effects slot, then choose *Disable All Effects* from the shortcut menu.

To turn on an effect again, do one of the following:

- Select the checkbox to the left of the effect name.
- Control-click the effect, then choose *Enable [effect name]* from the shortcut menu.

To turn on all effects in a channel strip:

- Control-click an effects slot, then choose *Enable All Effects* from the shortcut menu.

Replacing an Effect

You can replace an effect in a channel strip with another effect. When you replace an effect with another effect, the new effect has its default settings, regardless of the settings of the previous effect.

To replace an effect in a channel strip:

- Control-click the effect, choose *Replace [effect name]* from the shortcut menu, then choose a new effect from the submenu.

Deleting Effects From a Channel Strip

You can delete an effect if you decide you don't want to use it in a channel strip. You can also delete all effects from a channel strip.

To delete an effect from a channel strip, do one of the following:

- Select the effect, then choose *Edit > Delete* (or press the Delete key.)
- Control-click the effect, then choose *Delete [effect name]* from the shortcut menu.

To delete all effects from a channel strip:

- Control-click an effects slot, then choose *Delete All Effects* from the shortcut menu.

For more information about working with effects, including information on uses of different effects and adjusting effect parameters, see Chapter 9, "Working With Audio Effects," on page 195.

Adding Sends to a Channel Strip

You can add sends to a channel strip, show send settings in the Effects tab, bypass a send, or remove a send in the Mixer.

To add a send to a channel strip:

- Control-click an empty effects slot in the channel strip, choose Add Send from the shortcut menu, then choose one of the available effects from the categories in the submenu.

When you add a send, the audio is routed from the send to a bus. By default, the first send you add to an effects chain is routed to Bus 1, the second send is routed to Bus 2, and so on, if the default bus exists. You can choose the bus to which a send is routed.

Reordering Sends in the Mixer

You can reorder sends in the Mixer as well as in the Effects tab. When you reorder sends, you change which effects are routed to the send, which can change the sound drastically.

To reorder a send in the Mixer:

- Drag the send up or down in the effects slot area to change its order.

Showing Send Settings

You can show the settings for a send in the Effects tab. Send settings include volume, pan, and the bus to which the send is routed.

To show settings for a send:

- In the Mixer, Control-click the send, then choose Show Send Settings from the shortcut menu.

The Effects tab becomes active, with the settings for the send visible in the Effect Parameters area.

Turning Sends Off and On

You can turn sends off, and turn them back on. When you turn off a send, the audio is not routed to the send bus, and is not heard.

To turn off a send in a channel strip, do one of the following:

- Deselect the checkbox to the left of the send name.
- Control-click the send, then choose Disable Send from the shortcut menu.

To turn on an effect again:

- Select the checkbox to the left of the effect name.

Setting the Overall Project Volume Level

As you finalize a project mix, you set the overall project volume to the appropriate level. Certain formats or methods of distribution may require that the project conform to a particular maximum level. In general, you set the overall volume of the project to the highest level at which no clipping occurs at any point in the project.

Clipping occurs when the digital audio signal exceeds the maximum level that can be reproduced accurately. Unlike analog audio, digital audio is completely unforgiving of clipping, which creates sharp distortion of the audio signal. Soundtrack Pro projects clip whenever the output displayed in the level meters exceeds zero decibels (0 dB). It's important to eliminate clipping from projects before exporting the final mix. For more information about digital distortion, see Appendix C, "Audio Basics," on page 287.

You can monitor audio output levels using the level meters in the Mixer, the Project window, and the Meters tab. In the Mixer, each channel strip has stereo level meters that show the levels for that channel strip. In the Project window and the Meters tab, the level meters show the levels for the first output (Output 1). The Meters tab includes additional controls and displays to help you maintain proper audio levels and eliminate clipping.

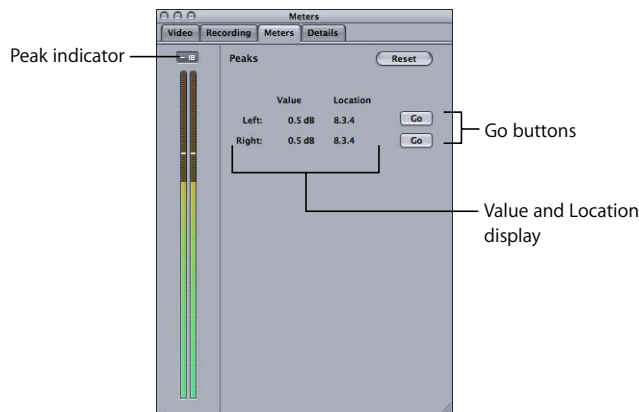

As a project plays back, the levels in each stereo channel change constantly with the rising and falling of the audio signal. The level meters show these changes both as bars rising to varying heights and as changes in color from green to yellow.

In each stereo channel's meter, a white horizontal bar displays the current signal level; colored bars below the white bar display successive levels in a scale that rises from green through yellow to orange as the signal increases. The meters peak at red when the signal clips (rises above 0 dB).

The Meters tab also includes peak indicators, Value and Location displays and Go to Peak buttons for each stereo channel, and a Reset button. You can use these controls to locate and remove clipping from your project.

Using the Peak Indicators

At the top of the level meters is a rectangular peak indicator, which lights red when that channel clips (exceeds 0 dB). The peak indicators are “sticky,” meaning that if clipping occurs in either channel, the peak indicator lights red and stays red until you reset it, or reset all peak indicators.

To reset a peak indicator:

- Click the peak indicator.

To reset all peak indicators, do one of the following:

- Option-click any peak indicator in any of the level meters.
- Click the Reset button in the Meters tab of the Viewer.

Peak Value and Peak Location Display

To the right of the level meters in the Meters tab, the levels of each stereo channel are displayed in decibels (dB). As the project plays back, the Peak Value display shows the highest level reached by each channel since the start of playback. The Peak Location display shows the location in the Timeline where the peak occurs.

Go to Peak Buttons

The Go to Peak buttons move the playhead to the point in the Timeline where the highest level for each channel is reached. This makes it easy to find the point in the project where clipping occurs and should be removed.

Reset Button

The Reset button located in the upper-right corner of the Meters tab display resets the Peak Value to a minimum value (–96 dB) and resets the Peak Location to the beginning of the project.

To reset the Peak Value and Peak Location displays:

- Click the Reset button.

The steps you take to remove clipping depend on the cause of the clipping. You can lower the master volume of a project by the amount the highest point in the project (as shown in the Value display) exceeds 0 dB. You can also use the Go buttons to locate where clipping occurs, and use a different audio clip or lower the volume of individual tracks until clipping no longer occurs. Sometimes removing or adjusting effects can remove occurrences of clipping as well.

Listening to a Temporary Mono Mix

In some situations, even where the final mix is stereo, you may want to listen to the mix in mono as well as stereo. If the final project is likely to be viewed using equipment with mono audio output (for example, many television sets have mono output), you may want to make sure the mix is suitable for mono output. Listening to a mono mix can also help identify phase issues that can occur when a stereo project is played in mono. Soundtrack Pro makes it easy to listen to a temporary mono mix of the project so you can hear how it will sound in mono.

To listen to a temporary mono mix:

- 1 Start the project playing.
- 2 While the project plays, press and hold the Mono Mix button, located to the right of the master volume slider below the Mixer.



The Mono Mix button becomes darker to indicate that it is active. When you are finished listening to the temporary mono mix, release the button to hear the project mix.

Recording Audio in the Mixer

You can record audio while working in the Mixer. When you record audio in the Mixer, recording starts from the current playhead position. Although the playhead is not visible in the Mixer, you can set the playhead position using the transport controls or the Playhead Position value slider located at the bottom of the Project window.

For more information about recording, see Chapter 11, “Recording Audio in Soundtrack Pro,” on page 235.

Recording Automation in the Mixer

You can record automation for volume and pan changes in the Mixer. You record automation in the Mixer by choosing either Touch or Latch automation mode in the project controls, then changing volume or pan settings as the project plays. You can record automation either using the onscreen volume and pan controls, or using a control surface connected to your computer.

For more information about working with automation, see Chapter 10, “Working With Automation,” on page 219.

Creating Multiple Mixes

You might want to create multiple mixes of a project for one of the following reasons:

- To optimize the project for different playback situations
- To try out different settings of the various track and master controls using the same arrangement
- To try out changes to the arrangement using the same basic material

You can easily create multiple mixes by giving the project a slightly different name when you save each mix, or by using different combinations of tracks, busses, and outputs for each mix. If you are saving the project and its media files together, the different versions can be saved to the same location if they all use the same media files. For information about saving projects and their media files together, see “Saving Multitrack Projects” on page 86.

Things to Keep in Mind While Mixing

The following are intended as guidelines or suggestions to follow when mixing your projects, not as “hard-and-fast” instructions.

- Consider the importance of each element in the overall mix.
- Keep related tracks close together (in the Timeline and the Mixer).
- Don’t create a final mix until the picture is locked.
- Listen to the mix with the best possible equipment.
- Listen to the mix as the audience will hear it.
- Don’t change output/monitor levels while mixing.
- Mix by what you hear, not what you see.

You can edit audio files nondestructively in the Waveform Editor, and analyze and fix common audio problems.

The Soundtrack Pro Waveform Editor gives you extensive audio file editing capabilities. You can open an audio file in the Waveform Editor, view it in Waveform or Spectrum view, process the file using actions, analyze it for common audio problems, fix analyzed problems individually or together, then save the edited file as an audio file project or as a standard audio file.

The Waveform Editor includes a set of graphical waveform editing tools, a Time display, a Global Waveform view, an Actions list, and a waveform display.

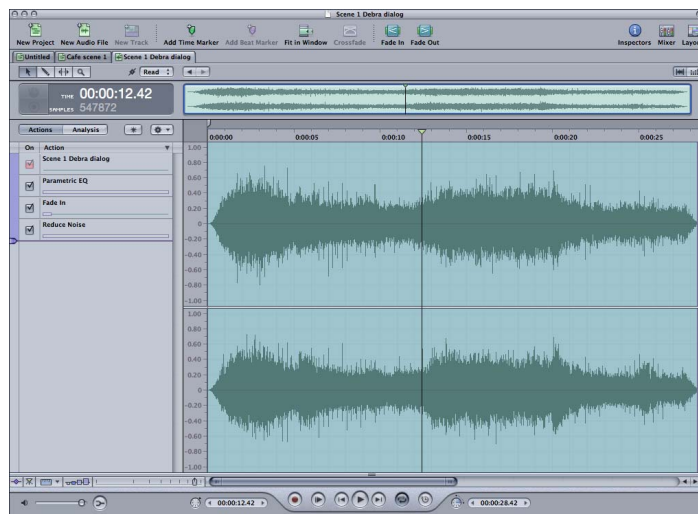

Getting Started With Audio File Projects

You can create audio file projects, open audio files in the Waveform Editor, create a new audio file, and save an audio file as an audio file project.

Supported Audio File Formats

You can open the audio files in the following formats in the Waveform Editor:

- Audio file project
- AIFF
- WAVE
- MP3
- AAC (except protected AAC files)
- Sound Designer II
- NeXT Sound File
- QuickTime Movie

You can open audio files with any combination of the following sample rates and bit depths:

Sample Rates

- Any rate between 8 kHz and 192 kHz

Bit Depths

- 8-bit integer
- 16-bit integer
- 24-bit integer
- 32-bit integer
- 32-bit floating point

You can open audio files up to four hours in length in the Waveform Editor.

Note: You can open audio files with any sample rate between 8 kHz and 192 kHz. When you edit the file in the Waveform Editor, it maintains its sample rate. When you play the file, it plays at the nearest sample rate your hardware can support.

The *audio file project* format is the native format of the Soundtrack Pro Waveform Editor. Audio files saved in this format have some special features, which are described in this chapter.

Creating and Opening Audio File Projects

You start working in the Waveform Editor by creating an audio file project, opening an existing audio file project, or opening an audio file in the Waveform Editor.

To create a new, blank audio file project:

- Choose File > New > Audio File.

To open an audio file project or audio file in the Waveform Editor, do one of the following:

- Choose File > Open (or press Command-O), locate and select the project or file, then click Open.
- Drag the project or file over the Soundtrack Pro icon in the Dock.
- In the Multitrack window or the Media and Effects Manager, Control-click a project or file, then choose Open in Editor from the shortcut menu.

When you open a clip from the Multitrack window, if the clip is part of a larger audio file, the Waveform Editor zooms in to the length of the clip. A marker is added to mark the start and end points of the clip.

When you open a stereo audio file in the Waveform Editor, the left channel appears in the upper part of the waveform display, and the right channel appears in the lower part.

You can have multiple audio file projects open in Soundtrack Pro, and cut and paste between them, but only one project can play back at a time.

Closing Audio File Projects

You can close the project when you no longer want to work on it, or close the Project window and close all open projects (both multitrack and audio file projects).

To close a project:

- Choose File > Close Project.

To close all open projects and close the Project window:

- Choose File > Close Window.

Saving Audio File Projects

You can save a project as an audio file project or as a standard audio file, and can choose other options when you first save the file. Audio file projects are saved with the extension *.stap*. Saving a project as an audio file project lets you make changes to actions and other edits when you reopen the project in the Waveform Editor. You can also save a project as a standard audio file. In this case, the edits you have made are rendered into the audio file, and cannot be changed or undone the next time you open the audio file in the Waveform Editor.

To save a project as an audio file project:

- 1 Choose File > Save.
- 2 In the Save dialog, type a name for the file and browse to the location where you want to save it.
- 3 Choose the file type for the project from the File Type pop-up menu.
The available choices in the Save dialog change depending on whether you choose Audio File Project or an audio file format as the file type.
- 4 Optionally, select the Flatten checkbox to flatten the project. Flattening a project flattens or coalesces the actions in the project, reducing project complexity and file size. Once you flatten a project, you can no longer edit existing action settings.
- 5 Optionally, select the Render checkbox to create a render file in the project. If you are working with a clip sent from Final Cut Pro, be sure this checkbox is selected.
- 6 Click Save.



For audio file projects sent from Final Cut Pro or Motion and for reference movies, the original source media file (whether video or audio) is not saved in the project by default, but instead a reference to the media file is saved. You can save the source media file in the project. Saving the source media file in the project allows you to move the project to another computer or storage device and continue working, but can significantly increase project size.

To collect the original source media in the project:

- In the Save As dialog, select the Collect Source File checkbox.

You can save a project to any of the audio file formats listed in “Supported Audio File Formats” on page 144, except MP3 and AAC.

To save a project as an audio file:

- 1 Choose File > Save.
- 2 In the Save dialog, type a name for the file and browse to the location where you want to save it.
- 3 Choose the file type for the project from the File Type pop-up menu.
The available choices in the Save dialog change depending on whether you choose Audio File Project or an audio file format as the file type.
- 4 Choose the bit depth for the project from the Bit Depth pop-up menu.
- 5 Choose the sample rate for the project from the Sample Rate pop-up menu.
- 6 Optionally, select the Dither checkbox to dither the file. Dithering is useful when saving a project at a lower bit depth or sample rate. In general, you should dither a project only when saving it as an audio file, and only when you have finished all bit depth or sample rate conversions.

7 Click Save.



When you save an audio file with the same name, location, and extension as the original audio file, you overwrite the existing audio file.

Setting the Time Ruler Units in the Waveform Display

You can set the Time Ruler units in the waveform display to any format in the Time Ruler Units submenu.

To set the Time Ruler units in the waveform display:

- Choose View > Time Ruler Units, then choose a format from the submenu.

Choosing the Sample Units in the Waveform Display

Along the left edge of the waveform display is a scale of sample units for the audio file. You can set this scale to any of the following sample units:

- Sample Value
- Normalized
- Percent
- Decibels

To set the sample units in the waveform display, do one of the following:

- Choose View > Time Ruler Units, then choose a format from the submenu.
- Control-click along the left edge of the waveform display where the sample units appear, then choose the sample units you want from the shortcut menu.

Zooming In and Out in the Waveform Editor

You can zoom in on a specific part of an audio file to make precise edits and perform other tasks.

To zoom in or out, do one of the following:

- Drag the Zoom control left to zoom in for a closer view, or drag right to zoom out for a wider view.
- Choose View > Zoom In to zoom in one level.
- Choose View > Zoom Out to zoom out one level.

If you have a mouse with a scrollwheel connected to your computer, you can set Soundtrack Pro to zoom in or out when you move the scrollwheel. You can select part of the audio file and zoom in on the selected area, zoom in to see individual samples in the waveform, or zoom out to peaks.

To set Soundtrack Pro to zoom the waveform display when you move the scrollwheel:

- 1 Choose Soundtrack Pro > Preferences.
- 2 If the General Preferences pane is not visible, click the General button.
- 3 In the Timeline section of the General Preferences pane, choose “Zooms at playhead” from the Scrollwheel pop-up menu.

To zoom in or out using a scrollwheel:

- Move the scrollwheel up to zoom in, or move it down to zoom out.

To zoom in on a selection:

- 1 In the waveform display, select the area you want to zoom in on.
- 2 Choose View > Zoom to Selection.

To zoom in to see individual samples:

- Choose View > Zoom To Samples.

If you have previously zoomed in to a level where individual samples are visible in the waveform display, choosing Zoom To Samples zooms in to the same zoom level.

To zoom out to see the entire waveform:

- Choose View > Zoom To Peaks.

If you have previously zoomed out to a level where waveform peaks are visible in the waveform display, choosing Zoom To Peaks zooms out to the same zoom level.

To return to the original zoom level:

- Choose View > Zoom Normal.

You can also zoom in on a selected area using the Zoom tool. For information about using the Zoom tool, see “Zoom Tool” on page 160.

Using the Global Waveform View

The Waveform Editor includes a Global Waveform view, located directly above the main waveform display. The Global Waveform view displays a miniature view of the entire audio file, and shows the current playhead position. The part of the audio file visible in the waveform display appears inside a blue rectangle. You can quickly move to different parts of the audio file by dragging the visible area rectangle.

To move to a different part of the audio file using the Global Waveform view:

- Drag the blue visible area rectangle to a new position.

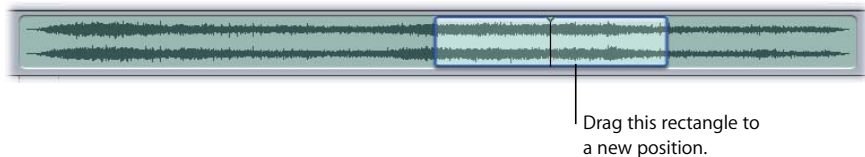

Viewing an Audio File in Spectrum View

When you first open the Waveform Editor, it shows the audio file in Waveform view. You can also view and edit an audio file in Spectrum view. In Spectrum view, the display shows the frequency spectrum of each channel of a stereo audio file on a scale from 0 Hertz (Hz) to half the sample rate of the file. For example, for a 48 kHz audio file, the scale progresses from 0 Hz to 24 kHz.

To view an audio file in Spectrum view:

- Click the Spectrum View button above the right corner of the Global Waveform view.



The display changes to show the audio file's frequency spectrum.

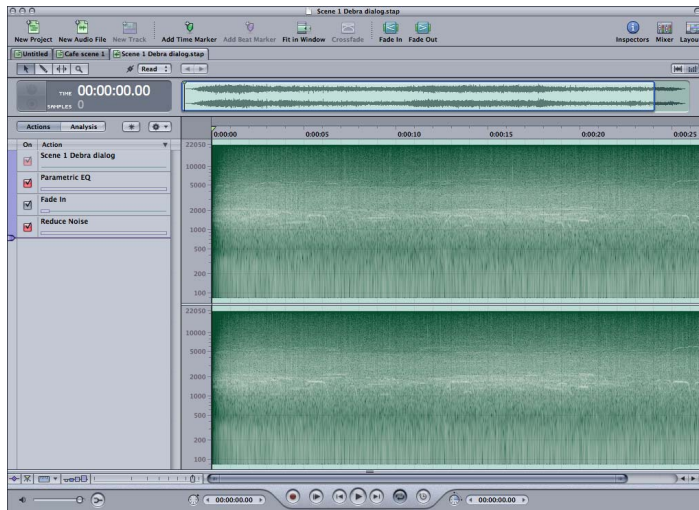

You can select parts of the audio file, apply actions, and edit the audio file in Spectrum view in the same way as in Waveform view. You can also change the Spectrum view display to show the frequency spectrum linearly or logarithmically, use different window functions, and change the number of samples used to calculate the view.

To show the frequency spectrum on a logarithmic scale:

- Control-click the Sample ruler along the left edge of the display, then choose Logarithmic from the shortcut menu.

To show the frequency spectrum on a linear scale:

- Control-click the Sample ruler along the left edge of the display, then choose Linear from the shortcut menu.

To display the audio file in Spectrum view, part of the audio data for each given point in time is analyzed. Each method of analysis represents a slightly different compromise between frequency resolution and spectral leakage. You can choose between several different analysis methods, called *window functions*, used to display the frequency spectrum in Spectrum view.

To choose a window function for Spectrum view:

- Control-click the spectrum display, then choose a window function from the upper part of the shortcut menu.

You can also choose the number of samples used to calculate the spectrum display.

To choose the number of samples used for Spectrum view:

- Control-click the spectrum display, then choose a number from the lower part of the shortcut menu.

To return to Waveform view:

- Click the Waveform View button.

Playing Audio Files in the Waveform Editor

You can play an audio file in the Waveform Editor, so you can hear the file and any changes you make to it.

To play an audio file:

- Click the Play button in the transport controls (or press the Space bar). Click the Play button (or press the Space bar) again to stop playback.

You can set the playhead in the Waveform Editor in the same way as you set it in the Timeline, by clicking in the waveform display or in the Time ruler, using the transport controls, or using the Playhead Position value slider. For more information, see “Setting the Playhead” on page 51.

Scrubbing Audio Files in the Waveform Editor

You can also scrub the audio file in the Waveform Editor. *Scrubbing* the audio file lets you hear the audio at the playhead position as you drag the playhead, so you can find a particular sound or event in the audio file.

To scrub an audio file:

- 1 Press and hold the triangular part of the playhead.
- 2 While holding the playhead, drag left or right at the speed you want to scrub the audio file.

Scrubbing is useful to help identify the part of an audio file that you want to edit. While you are scrubbing an audio file, you can select the part of the file that you want to edit.

To make a selection while scrubbing:

- As you move the playhead, press and hold the Shift key.

Using the Timeline Controls in the Waveform Editor

You can use the Timeline controls, located at the lower-left corner of the Project window, while working in the Waveform Editor. Some of these controls have slightly different functions in the Waveform Editor than they do in the Timeline.

- *Master Envelopes button*: You can show or hide the envelopes for the audio file.
- *Snap button*: You can turn snap on or off in the Waveform Editor.
- *Snap To button*: You can choose the Snap To value that the playhead and other items snap to. In the Waveform Editor, the choices for snap are Ruler Ticks and Zero Crossings.
- *Track Height control*: Sets the height of the envelope rows when you show envelopes in the Waveform Editor.

Editing Audio Files in the Waveform Editor

You can edit audio files in many different ways in the Waveform Editor. You can edit the entire file, or select part of the file to edit.

Selecting Part of an Audio File

When you apply an action to an audio file in the Waveform Editor, the action is applied to the entire file unless you select part of the file. You can select different parts of the audio file and apply different actions to each selection.

To select part of an audio file:

- In the waveform display, drag horizontally across the part of the waveform you want to select.

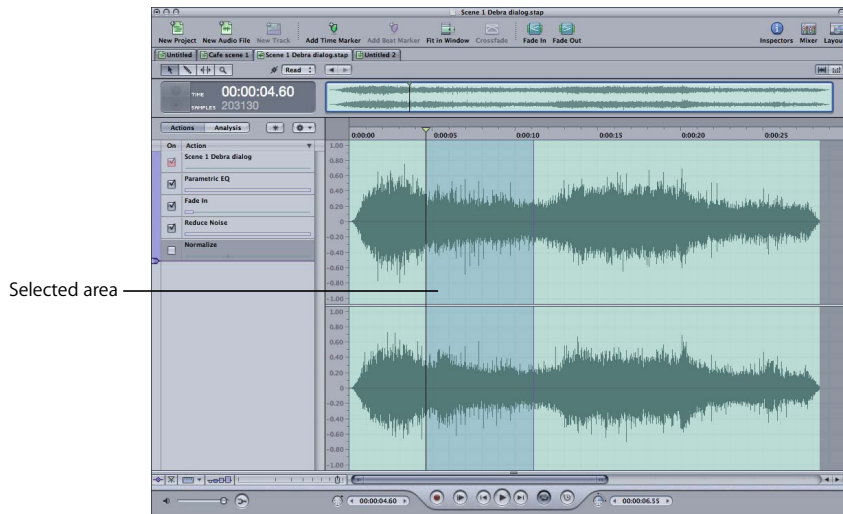

Some actions can only be applied to a selection. The selection can contain the entire audio file.

To select the entire audio file:

- Choose Edit > Select All.

You can select one channel (left or right) of a stereo audio file, and apply actions to only the selected channel. You can also select only part of one channel.

To select the left channel of an audio file:

- 1 Move the pointer near the upper edge of the waveform display.
The pointer changes to the letter “L.”
- 2 Drag the pointer to select the part of the left channel you want to work with.

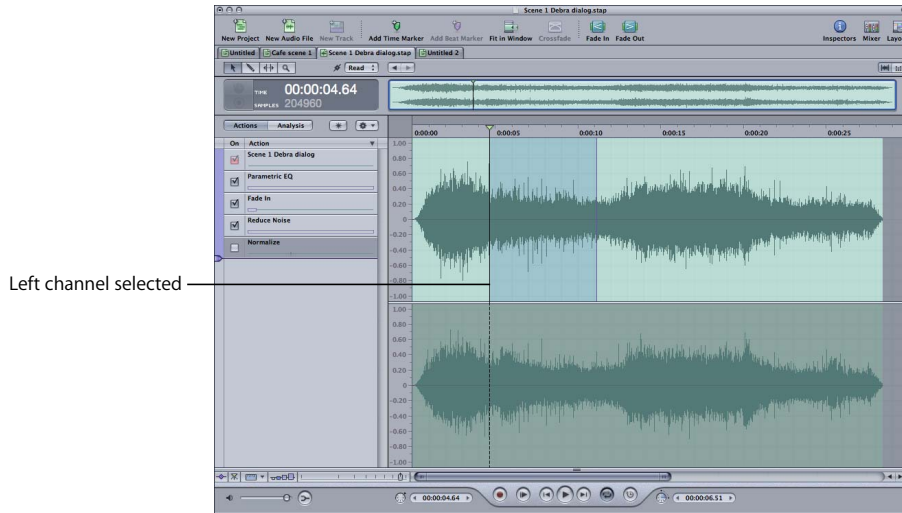

As you drag, the right (lower) channel of the audio file becomes darker in the waveform display. You can also double-click in the upper part of the waveform display to select the entire left channel.

To select the right channel of an audio file:

- 1 Move the pointer near the lower edge of the waveform display.
The pointer changes to the letter "R."
- 2 Drag the pointer to select the part of the right channel you want to work with.

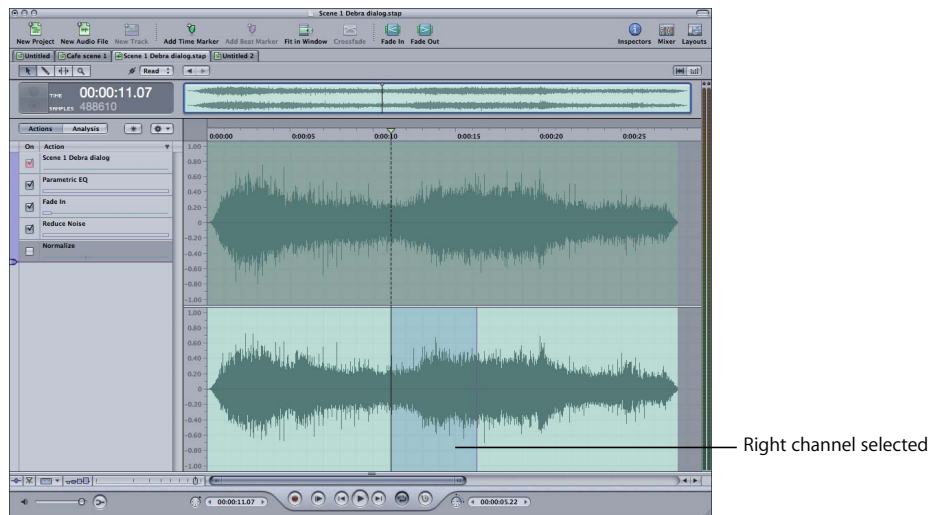

As you drag, the left (upper) channel of the audio file becomes darker in the waveform display. You can also double-click in the lower part of the waveform display to select the entire right channel.

When you play a selected left or right channel, the audio from that channel plays in both the left and right output channels of the output. The other channel is not heard.

If you have added time or beat markers to an audio file project, you can select the area between two markers.

To select the area between two markers:

- Double-click the waveform display in the area between the two markers. If there are additional markers, you can expand the selection by dragging toward them.

Moving Between Selections

You can select different areas of the audio file to apply different actions or to play different areas. Any selection can include the same part of an audio file as another selection. As you work on the audio file, you can move back and forth between selections.



To move to the previous selection:

- Click the Previous Selection button above the waveform display.

The previous selection becomes the current selection. The selection area appears darker than the rest of the waveform.

To move to the next selection:

- Click the Next Selection button above the waveform display.

The next selection becomes the current selection. The selection area appears darker than the rest of the waveform.

Cutting, Copying, and Pasting in the Waveform Editor

You can cut, copy, and paste audio in the Waveform Editor. Cutting, copying, and pasting can change the length of an audio file.

To cut part of an audio file in the Waveform Editor:

- 1 Select the part of the file you want to cut.
- 2 Choose Edit > Cut (or press Command-X).

The selected part of the file is removed, and the file shortens by the cut amount.

To copy audio in the Waveform Editor:

- 1 Select the part of the file you want to copy.
- 2 Choose Edit > Copy (or press Command-C).
- 3 You can paste audio in the Waveform Editor. You can paste at the playhead position, paste mix, or paste repeat.

To paste audio in the Waveform Editor:

- 1 Set the playhead to the point where you want to paste the audio.
- 2 Choose Edit > Paste (or press Command-V).

The cut or copied audio is pasted starting at the playhead position. The audio after the playhead in the file moves to accommodate the pasted audio, and the file lengthens by the pasted amount.

You can also paste mix in the Waveform Editor. When you paste mix, the pasted audio is mixed (or blended) with the existing audio in the audio file. You can control the mix of the pasted audio and existing audio, and can crossfade the pasted audio.

To paste mix audio in the Waveform Editor:

- 1 Set the playhead to the point where you want to paste the audio.
- 2 Choose Edit > Paste Special, then choose Paste Mix from the submenu.
- 3 In the Paste Mix sheet, drag the Original Material Level slider to set the mix level of the existing audio in the pasted area.
- 4 Drag the Clipboard Level slider to set the mix level of the pasted audio.
- 5 Optionally, you can crossfade the pasted audio by selecting the Crossfade In and Out Points checkbox and typing crossfade values (in milliseconds) in the Fade In Length and Fade Out Length fields.
- 6 Click OK.

The cut or copied audio is mixed with the existing audio.

You can also paste repeat in the Waveform Editor. When you paste repeat, the cut or copied audio is pasted the number of times you specify in succession, so that each copy starts at the end of the previous one.

To paste repeat in the Waveform Editor:

- 1 Set the playhead to the point where you want to paste the audio.
- 2 Choose Edit > Paste Special, then choose Paste Repeat from the submenu.
- 3 In the Paste Repeat sheet, type the number of copies you want to paste in the field.
- 4 Click OK.

The copies are pasted starting at the playhead position. The audio after the playhead in the file moves to accommodate the pasted audio, and the file lengthens by the pasted amount.

Graphically Editing Audio Files

The Waveform Editor includes four waveform editing tools you can use to graphically edit the audio file in the waveform display.

Selection Tool

You can use the Selection tool to select part of an audio file, as described in “Selecting Part of an Audio File” on page 154. When you open the Waveform Editor, the pointer is a selection pointer (arrow). When you are done using another waveform editing tool, you can return the pointer to a selection pointer by clicking the Selection Tool button.



Sample Edit Tool

You can graphically edit samples in the audio file using the Sample Edit tool. To use the Sample Edit tool, the waveform display must be zoomed in enough to see individual samples, which appear as small squares connected by a thin line.



To edit samples using the Sample Edit tool:

- 1 Click the Sample Edit Tool button above the time display.

The pointer becomes a Sample Edit pointer.

- 2 Zoom in on the part of the waveform you want to edit.
- 3 To graphically edit samples, do one of the following:

- Drag a sample up or down to a new value.
- Click directly above or below a sample.
- Drag left or right to reshape the waveform.

You can also edit samples numerically in the waveform display.

To edit samples numerically:

- 1 Control-click a sample, then choose Set Value from the shortcut menu.
- 2 In the sheet that appears, type a new value for the sample.
- 3 Click OK.

Stretch Tool

You can *time stretch* all or part of an audio file to change the amount of time it occupies. When you stretch an audio file, the length of time changes but not the pitch (letting you fill dialogue, music, or other audio to a specific amount of time). For audio files with music or other repeating patterns, stretching the file changes the tempo of the music without changing the key.

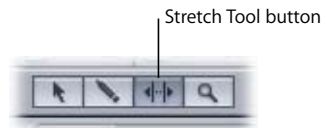

To graphically time stretch an audio file:

- 1 Click the Stretch Tool button above the time display.
- 2 In the waveform display, drag horizontally across the waveform to select the part you want to time stretch.
The pointer becomes a Stretch pointer.
- 3 Drag the right edge of the selection left to shorten the selected area, or drag it right to lengthen the selected area.

Note: Stretching an audio file by a large amount can degrade the sound quality of the audio file.

Zoom Tool

You can zoom in on a specific part of the waveform display to make precise edits.

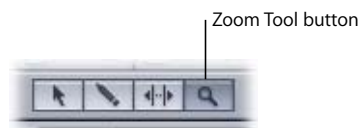

To zoom in using the Zoom tool:

- 1 Click the Zoom Tool button above the time display.
The pointer changes to a Zoom pointer.
- 2 In the waveform display, do one of the following:
 - Click to zoom in.
 - Option-click to zoom out.
 - Drag horizontally to select the part of the waveform you want to zoom in on.
The waveform display zooms in on the selected area.

For information on other ways to zoom in and out in the waveform display, see “Zooming In and Out in the Waveform Editor” on page 149.

Processing Audio Files

You can process audio files in the Waveform Editor in a variety of ways. You can choose processing effects and other operations from the Process menu and apply them to an entire file, or select part of the file and apply the effect to the selection. When you choose an item from the Process menu, the item appears as an action in the Actions list. The Process menu contains the following items:

Effects Submenu

The Effects submenu contains an extensive set of professional audio effects you can apply to an audio file or a selection. The audio effects in the Effects submenu are the same as the realtime effects you can apply to tracks, busses, and outputs in the Timeline. For information about individual effects in the Effects submenu, see “Audio Effects Included With Soundtrack Pro” on page 196.

The effects included with Soundtrack Pro are categorized by type in the Effects submenu. Below these effect categories is a submenu for Mac OS effects. If you have installed third-party Audio Units effects on your computer, additional submenus for the third-party effects appear at the bottom of the Effects submenu.

When you apply a processing effect from the Effects submenu, the floating advanced settings window for the effect appears. The advanced settings window contains controls for previewing the effect in the Waveform Editor, bypassing, applying or canceling the effect, resetting effect parameters, and applying effect presets.

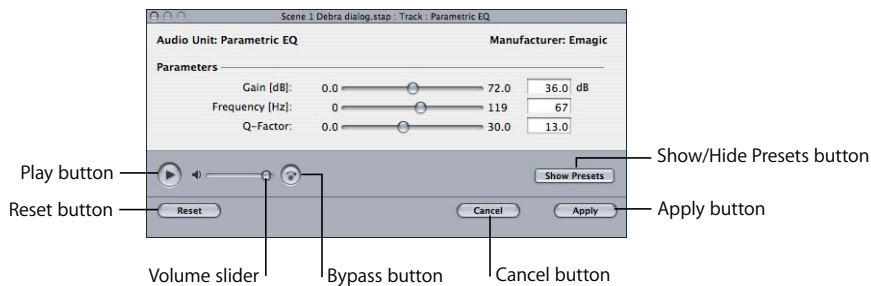

- *Play button*: Plays the audio file or selection with the effect.
- *Volume slider*: Controls the volume of the audio file or selection as you play it.
- *Bypass button*: Bypasses the effect so you can hear the difference in the sound of the audio file or selection with and without the effect.

- *Reset button*: Resets all effect parameters to their default values.
- *Cancel button*: Closes the advanced settings window without applying the effect.
- *Apply button*: Applies the effect to the audio file or selection and closes the advanced settings window.
- *Show/Hide Presets button*: Shows or hides the Presets drawer so you can apply effect presets.

For information about applying effect presets in the Waveform Editor, see “Working With Effect Presets” on page 217.

For information about the effects in the Effects submenu, see Chapter 9, “Working With Audio Effects,” on page 195.

Fade In

Choosing this command fades in the audio file or selection. The fade in progresses in linear fashion from the beginning to the end of the audio file or selection.

Fade Out

Choosing this command fades out the audio file or selection. The fade out progresses in linear fashion from the beginning to the end of the audio file or selection.

Normalize

Choosing this command normalizes (adjusts the gain of) the audio file or selection to the decibel level shown in the Normalization Level field. The highest peak in the file is raised or lowered to the level you set, and the rest of the audio file is raised or lowered by the same amount. When you choose Process > Normalize, the level is set to 0 dB.

To set the normalization level:

- 1 Choose Process > Normalize.
- 2 In the Normalize dialog, drag the Normalization Level slider or select the value in the Normalization Level field and type a new value.
- 3 Click OK.

You can preview the audio file at the normalization level before closing the Normalize dialog. This makes it easy to set the level before normalizing the file.

To preview the file at the normalization level:

- In the Normalize dialog, select the Preview checkbox.

Adjust Amplitude

Choosing this command raises or lowers the gain of the audio file or selection by the amount shown in the Amplitude Level field. When you choose Process > Adjust Amplitude, the level shown in the field is zero (0) dB, or unity gain.

To set the amplitude level:

- 1 Choose Process > Adjust Amplitude.
- 2 In the Adjust Amplitude dialog, drag the Amplitude Level slider or select the value in the Amplitude Level field and type a new value.
- 3 Click OK.

Silence

Choosing this command replaces the audio file or selection with complete silence.

Invert

Choosing this command inverts the phase of each sample in the audio file or selection. Each sample's amplitude is unchanged, but the phase is inverted. In the waveform display, the wave's crests become troughs and vice versa.

Reverse

Choosing this command reverses the order of the samples in the audio file or selection so that the first sample becomes the last and vice versa.

Swap Channels

Choosing this command swaps the left and right channel of a stereo audio file or selection. If the file is mono, Swap Channels is disabled.

Insert

You can insert silence, noise, or a waveform in an audio file or selection. When you choose Process > Insert, then choose one of the three items from the Insert submenu, the silence, noise, or waveform is inserted at the current playhead position. The remainder of the audio file ripples so that it continues after the inserted silence, noise, or waveform.

Inserting Silence

When you choose Process > Insert, then choose Silence from the Insert submenu, the Insert Silence sheet appears. You can set the length of silence to insert, and choose the format for setting the length of the silence (any of the Time Ruler Units formats).

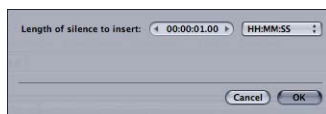

To set the length of the inserted silence:

- 1 In the Insert Silence sheet, choose the format you want to use from the Format pop-up menu.
- 2 In the “Length of silence to insert” value slider, do one of the following:
 - Click the left arrow to shorten the length of the inserted silence, or click the right arrow to increase the length.
 - Click the center of the value slider, then drag the slider that appears left or right to change the length of inserted silence.
 - Click the value in the value slider, then type a new value.
- 3 Click OK.

Inserting Noise

When you choose Process > Insert, then choose Noise from the Insert submenu, the Noise Generator dialog appears. You can set the type of noise to insert, set the length of the inserted noise, choose the format for setting the noise length (any of the Time Ruler Units formats), and set the volume of the inserted noise.

The inserted noise can be white noise (emphasizing higher frequencies) or pink noise (equal distribution of frequencies).

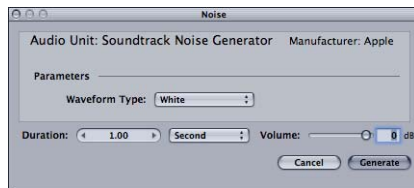

To choose the type of noise to insert:

- In the Noise Generator dialog, choose the type of noise from the Waveform Type pop-up menu.

To set the length of the inserted noise:

- 1 In the Noise Generator dialog, choose the format you want to use from the Duration pop-up menu.
- 2 In the Duration value slider, do one of the following:
 - Click the left arrow to shorten the length of the inserted noise, or click the right arrow to increase the length.
 - Click the center of the value slider, then drag the slider that appears left or right to change the length of inserted noise.
 - Click the value in the value slider, then type a new value.
- 3 Click OK.

To set the volume level of the inserted noise:

- In the Noise Generator dialog, drag the Volume slider left or right to set the noise level. You can also type a level (in decibels) in the Volume field.

Inserting a Waveform

When you choose Process > Insert, then choose Waveform from the Insert submenu, the Wave Generator dialog appears. You can set the type of waveform to insert, set the length of the inserted waveform, choose the format for setting the waveform length (any of the Time Ruler Units formats), and set the volume of the inserted waveform.

The inserted waveform can be a sine, sawtooth, square, or triangle wave.

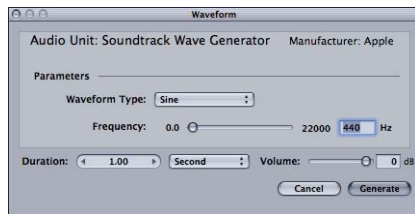

To choose the type of waveform to insert:

- In the Wave Generator dialog, choose the type of waveform from the Waveform Type pop-up menu.

To set the frequency of the inserted waveform:

- In the Wave Generator dialog, drag the Frequency slider left or right to set the frequency. You can also type a frequency (in Hertz) in the Frequency field.

To set the length of the inserted waveform:

- 1 In the Wave Generator dialog, choose the format you want to use from the Duration pop-up menu.
- 2 In the Duration value slider, do one of the following:
 - Click the left arrow to shorten the length of the inserted waveform, or click the right arrow to increase the length.
 - Click the center of the value slider, then drag the slider that appears left or right to change the length of the inserted waveform.
 - Click the value in the value slider, then type a new value.
- 3 Click OK.

Time Stretch

You can time stretch an audio file or selection. When you time stretch an audio file, you change the duration (length) of the file without changing the frequency (pitch) of the file. For example, for a file containing music, the tempo of the music is changed, but not the pitch. When you time stretch an audio file, you can choose the format for time values you enter.

To time stretch an audio file:

- 1 Select the part of the file you want to time stretch (it can be the entire file).
- 2 Choose Process > Time Stretch.

The Time Stretch sheet appears.

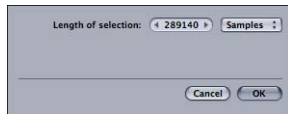

- 3 In the Time Stretch sheet, choose the format for setting the amount to time stretch the file from the Format pop-up menu.
- 4 In the "Length of selection" value slider, do one of the following:
 - Click the left arrow to shorten the length, or click the right arrow to increase the length.
 - Click the center of the value slider, then drag the slider that appears left or right to change the length.
 - Click the value in the value slider, then type a new value.
- 5 Click OK.

Adding Ambient Noise

When editing an audio file, you may want to remove some sounds from the file while preserving the room tone or other ambient background noise in the file.

Soundtrack Pro features two commands, Set Ambient Noise Print and Apply Ambient Noise, that you can use together to add ambience to the file.

Set Ambient Noise Print

The Set Ambient Noise Print command lets you copy part of an audio file containing only ambient noise that you want to add to another part of the file (or another file).

To copy part of an audio file to ambient noise:

- 1 In the waveform display, select the part of the audio file containing only ambient noise.
- 2 Choose Process > Set Ambient Noise Print.

The ambient noise is stored in a special buffer separate from the Clipboard, and is saved to the project.

Apply Ambient Noise

The Apply Ambient Noise command applies the ambient noise stored in the ambient noise buffer to the audio file or selection.

To apply ambient noise to an audio file:

- 1 In the waveform display, select the part of the audio file to which you want to apply the ambient noise.
- 2 Choose Process > Apply Ambient Noise.

The ambient noise replaces the selected part of the file. If the selection is longer than the copied ambient noise, the ambient noise repeats to fill the selection.

Convert to Mono

Choosing this command converts a stereo audio file to mono. You can choose whether to convert the file to mono by using only the left channel, using only the right channel, or combining the two channels. Combining the left and right channels sums them as an equal gain mix.

To select how a stereo file is converted to mono:

- 1 Choose Process > Convert to Mono.
- 2 In the Convert to Mono dialog, select the button corresponding to the method by which you want to convert the file to mono.
- 3 Click OK.

The Convert to Mono action converts the entire stereo file to mono. You cannot convert only a selection of a file to mono. The Convert to Mono action flattens the file, removing existing actions from the Actions list. For information about flattening actions, see “Flattening Actions” on page 174.

Resample

Choosing this command resamples the audio file to a new sample rate.

To choose the new sample rate:

- 1 Choose Process > Resample.
- 2 In the Resample sheet, choose a sample rate from the Sample Rate pop-up menu. You can also type a sample rate (in Hertz) in the Sample Rate field.
- 3 Click OK.

The Resample action flattens the file, removing existing actions from the Actions list. For information about flattening actions, see “Flattening Actions” on page 174.

Reducing Noise

Some audio files contain unwanted noise, making it difficult to hear the voices, music, or other content of the file. Soundtrack Pro features two commands, Set Noise Print and Reduce Noise, that you can use together to reduce noise in an audio file or selection.

Set Noise Print

The Set Noise Print command lets you select part of an audio file containing only the noise that you want to remove as a “noise print.” The noise print provides a signature of the frequencies to reduce or remove from the file.

Setting the noise print before reducing noise is optional. If you do not set a noise print before using the Reduce Noise command, Soundtrack Pro will extract a noise print from the selected part of the audio file.

To set part of an audio file as a noise print:

- 1 In the waveform display, select the part of the audio file containing only the noise you want to reduce.
- 2 Choose Process > Set Noise Print.

The selected noise is stored as a noise print.

Reduce Noise

The Reduce Noise command uses the frequency content of the noise print to reduce noise in the audio file or selection.

To reduce noise using the noise print:

- 1 In the waveform display, select the part of the audio file in which you want to reduce noise.
- 2 Choose Process > Reduce Noise.

The Reduce Noise dialog appears. In the Reduce Noise dialog, you can optionally set the noise threshold and tone for noise reduction. You can also preview the noise reduction with the dialog open.



The noise threshold determines the level below which audio in the noise print is considered to be noise. Lowering the threshold results in only very low signals being reduced, while raising the threshold results in more high level signals being reduced.

To set the threshold of the noise reduction:

- In the Reduce Noise dialog, drag the Noise Threshold slider left to lower the threshold or drag it right to raise the threshold. You can also type a value (in decibels) in the Noise Threshold field.

To change the tone of the noise reduction:

- In the Reduce Noise dialog, drag the Tone Control slider left to preserve more low frequency content (bass) or drag it right to preserve high frequency content (treble) during noise reduction.

You can preview noise reduction with the Reduce Noise dialog open, and adjust the threshold and tone of noise reduction. You can also hear the audio file or selection with and without noise reduction, and hear only the noise to be removed.

To preview the file with noise reduction:

- Click the Play button in the lower part of the Reduce Noise dialog.

To set the preview volume level:

- Drag the Volume slider in the lower part of the Reduce Noise dialog left to lower the volume or right to raise the volume.

To compare the file with and without noise reduction:

- Click the Bypass button to hear the file without noise reduction. Click the button again to hear the file with noise reduction.

To hear only the noise to be removed:

- Select the Noise Only checkbox.

To use a noise reduction preset:

- 1 In the Reduce Noise dialog, click Show Presets.
The Presets drawer appears.
- 2 In the Presets drawer, select a preset from either the Factory Presets or User Presets list.
- 3 Click Apply.

Show Realtime Effects

In addition to processing effects, you can apply realtime effects to an audio file project. The Show Realtime Effects command shows the Effects tab with any realtime effects applied to the current audio file project. You can apply realtime effects to the project in the Effects tab, and can automate realtime effect parameters in the Waveform Editor.

To show realtime effects for the current audio file project:

- Choose Process > Show Realtime Effects.

Bounce Realtime to Action

Choosing this command bounces any realtime effects applied to the audio file project, and the project's envelopes, to an action in the Actions list, letting you turn these effects and envelopes on or off, and reorder them in the list.

To show realtime effects and envelopes to an action:

- Choose Process > Bounce Realtime to Action.

Once you bounce realtime effects and envelopes to an action, the realtime effects are deleted from the project, and the envelopes are reset to their default values.

Some effects, including reverb and delay, add audio that extends past the end of the file. This is called an effect "tail." When you bounce realtime effects to an action, if any of the effects creates an effect tail that extends past the end of the audio file, the file lengthens to include the effect tail.

Working With Actions

Actions give you an extremely flexible and powerful way to edit audio files in the Waveform Editor. You can apply an action to an entire file or a selected part of the file, including applying an action to only one channel of a stereo audio file. You can turn individual actions on or off and reorder actions in the Actions list, changing the sequence in which the actions change the audio file. You can adjust action settings after applying the action, and can flatten actions.

Applying Actions

You start working with actions by applying an action to the audio file or the currently selected part of the file.

To apply an action:

- 1 With the file open in the Waveform Editor, choose an item from the Process menu. The item appears in the Actions list.

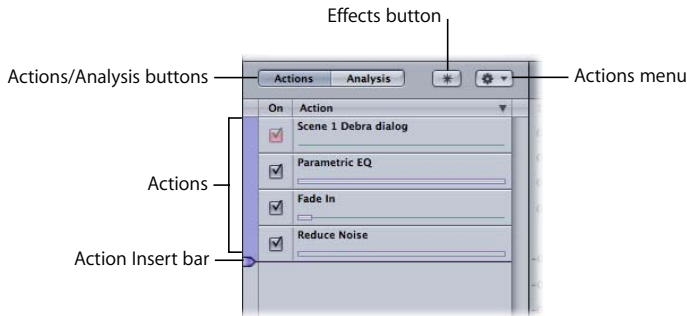

- 2 Some actions have a dialog that appears when you choose the item from the Process menu. Adjust the settings in the dialog, then click Apply.

The action is added to the Actions list, and the waveform display updates to show the change to the audio file. You can hear the change when you play the project. Some actions may take a moment to apply. In this case, a progress bar appears indicating that the action is being applied.

Some effects, including reverb and delay, add audio that extends past the end of the file. This is called an effect “tail.” When you apply a processing effect that produces an effect tail to an audio file in the Waveform Editor, the file is lengthened to include the tail until the point at which the tail falls below -96 dB. If you apply a processing effect that produces a tail to a selection, the tail is mixed with the audio following the selection. If the tail extends past the end of the file, the file is lengthened to include the effect tail until the point at which the tail falls below -96 dB.

Editing Actions

Many actions have settings that you can edit. When you apply an action that has editable settings, a dialog or sheet appears, letting you edit the action's settings. You can edit an action's settings at any time you are working in the Waveform Editor.

To show an action's settings, do one of the following:

- In the Actions list, select the action you want to edit, then choose "Edit Settings For [action name]" from the Actions pop-up menu.
- In the Actions list, Control-click the action you want to edit, then choose "Edit Settings For [action name]" from the shortcut menu.
- Double-click the action in the Actions list.

If the action has no editable settings, the Edit Settings menu item appears dimmed.

Turning Actions On and Off

You can turn individual actions on and off in the Actions list and hear the result when you play the audio file. The waveform display updates to show the change to the audio file. Depending on the length of the file, turning actions on and off can take time.

To turn an action off:

- In the Actions list, deselect the checkbox next to the action name.

To turn an action on:

- In the Actions list, select the checkbox next to the action name.

Reordering Actions

You can reorder actions after applying them to an audio file. The order in which effects and other actions occur can drastically change the resulting sound of the audio file. Depending on the length of the file, reordering actions can take time.

To reorder actions:

- In the Actions list, drag the actions you want to reorder up or down to new positions.

You hear the change when you play the audio file. The waveform display updates to show the change to the audio file.

Using the Action Insert Bar

The Action Insert bar appears as a purple bar along the left side of the Actions list. As you apply actions, the Action Insert bar moves below the last action applied.

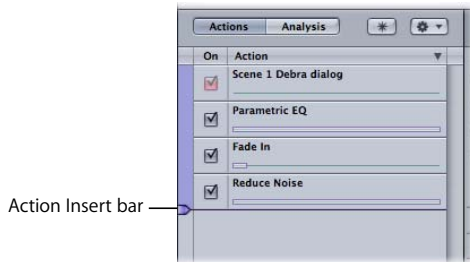

You can move the Action Insert bar up or down to a new position in the Actions list. Only actions before the Action Insert bar are heard when you play the project, so you can control which actions are heard by moving the bar. The purple strip to the left of the checkboxes in the Actions list indicates the actions that are heard when you play the project.

When you choose an item from the Process menu, it is applied directly following the Action Insert bar. By moving the bar, you set where in the list the next action is applied.

To set the position of the next applied action:

- Drag the Action Insert bar up or down in the Actions list to the position you want.

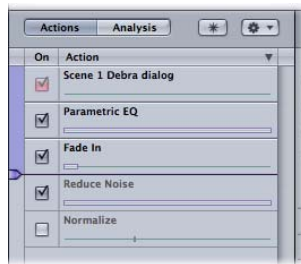

Reversing the Order of the Actions List

You can reverse the order in which actions are shown in the Actions list, so the last action applied appears at the top of the list. This is useful when your project has a large number of actions.

To reverse the order of the Actions list:

- Click the triangle at the upper-right corner of the Actions list. Click the triangle again to return the list to its default order.

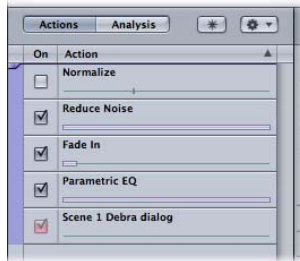

When you reverse the order of the Actions list, the Action Insert bar appears at the top of the list instead of at the bottom. You hear actions below the Action Insert bar in the list, rather than above it. When you choose an item from the Process menu, it is applied directly above the position of the Action Insert bar.

Reversing the order of the Actions list affects only the visual appearance of the list. The order in which actions are applied to the audio file is unchanged.

Flattening Actions

You can flatten the actions in a project to a single action. Flattening actions renders the actions into the file, reducing the complexity of the file and the file size. When you flatten actions, all existing actions are removed from the Actions list, and you can no longer reorder the actions or edit their action settings, unless you undo flattening the actions.

Some items in the Process menu, including Convert to Mono and Resample, flatten all actions in the project.

To flatten all audible actions:

- 1 Move the Action Insert bar directly below the last action you want to flatten.
- 2 Do one of the following:
 - Choose Process > Flatten Audible Actions.
 - Choose "Flatten audible actions" from the Actions pop-up menu.

To flatten all actions, do one of the following:

- Choose Process > Flatten All Actions.
- Choose “Flatten all actions” from the Actions pop-up menu.

Comparing the Project With and Without Actions

When you are adding and adjusting actions, you may want to compare the results of your changes to the original file.

To hear the file without actions:

- 1 Choose “Play without actions” from the Actions pop-up menu.
- 2 Click Play or press the Space bar.

To hear the file with all actions:

- 1 Choose “Play with all actions” from the Actions pop-up menu.
- 2 Click Play or press the Space bar.

To hear the file with only selected actions:

- 1 In the Actions list, deselect the checkboxes for the actions you do not want to hear.
- 2 Click Play or press the Space bar.

When you deselect an action, its settings are saved and are available when you select the action again.

Comparing the Last Two Actions

You can quickly compare the last two actions applied to an audio file or selection. This is helpful when you want to try out two similar actions, and hear which one you like better.

To compare the last two actions:

- 1 Do one of the following:
 - Choose Process > A/B Last Two Actions.
 - Choose A/B from the Actions pop-up menu (or press Command-F1).
- 2 Click Play or press the Space bar.

You hear the first of the two actions. The checkbox of the second action appears deselected in the Actions list.

- 3 Do one of the following:
 - Choose Process > A/B Last Two Actions again.
 - Choose A/B from the Actions pop-up menu (or press Command-F1) again.

You hear the second of the two actions. The checkbox of the first action appears deselected in the Actions list.

Deleting Actions

You can delete an action if you decide you no longer want it in the project.

To delete an action:

- Select the action in the Actions list, then press Delete.

Limitations of Actions That Change the File's Length

Some actions change the overall length of the audio file by inserting or deleting audio. These include inserting silence, noise, or a waveform, time stretching, and deleting part of a file. Recording audio, pasting, and adding an effect with a “tail” can also change the file's length. In the Actions list, the selection checkbox for each action that changes the file's length appears red, making it easy to visually distinguish those actions.

Each selection you make in the Waveform Editor applies to a specific range of time, and each action applies to a range of time defined by the selection at the time the action is applied. Because selections and actions apply to a range of time, changing the file's length can change the audio to which a selection or action applies. In the Waveform Editor, you see the selection remain in the same place (the same range of time as shown in the Time ruler) and see the waveform under the selection change.

When you apply an action that changes the file's length, any existing selections apply to the same range of time, but the audio occupying that range of time may be different than when you applied the action. For example, if you select a range of time beginning five seconds after the start of an audio file, then insert one second of silence at the beginning of the file, the selection still begins five seconds after the start of the file, but the audio at the beginning of the selection corresponds to what was previously four seconds after the start of the file.

If a project includes an action that increases the file's length, and you turn off or reorder that action, any selection that includes audio added by the length-changing action may extend past the end of the shortened file. In this case, the selection applies to the remaining audio in the selected range of time, but has no effect past the end of the file. For example, if you have a five-second project that includes a one-second Insert Silence action at the beginning of the project, and you select the last half-second of the project, then turn off the Insert Silence action, the selection applies to the last half-second of the project. However, the remaining half-second of the selection is empty.

Analyzing an Audio File

Soundtrack Pro includes a set of audio analysis tools. You can analyze an audio file for common problems such as clicks and pops, hum, phase issues, and clipping, and fix them individually or in a single operation. When you analyze an audio file, you can select which types of analysis to perform.

To show the analysis lists and tools:

- In the Waveform Editor, click the Analysis button.

The Analysis Type list, Parameter list, and Analysis Results list replace the Actions list in the window.

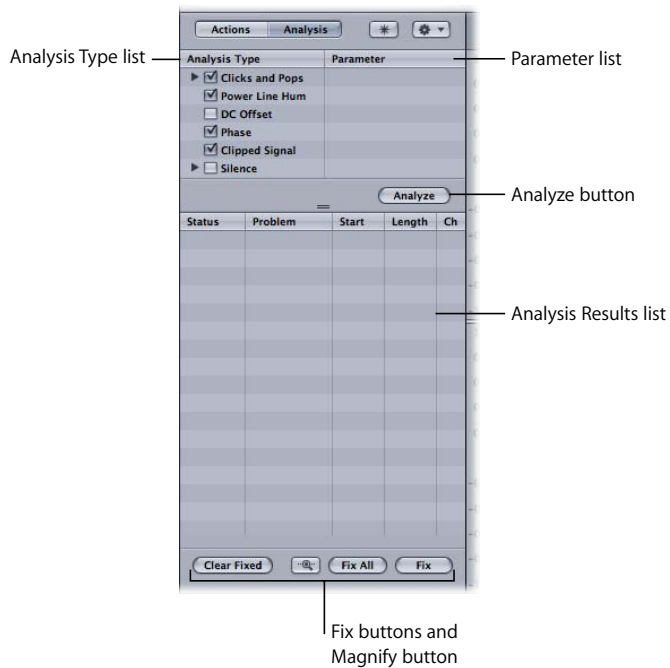

To analyze an audio file:

- Click the Analyze button, located below the Parameter list.

Types of Audio Analysis

The following types of analysis can be performed in the Waveform Editor:

Clicks and Pops

Sudden, short peaks in the audio file can result from a variety of causes, including mechanical defects in analog recordings. You can set the threshold above which Soundtrack Pro considers peaks to be clicks or pops.

(Power Line) Hum

Power lines and other electrical equipment can produce a steady hum, often at 50 or 60 Hz. The hum can also include low-order harmonics of the fundamental frequency.

DC Offset

DC offset is a shift in the audio, causing the positive and negative parts of the signal not to average to zero. DC offset can limit the dynamic range of an audio file.

Phase Issues

Phase issues can result from a distorted or inaccurate stereo image, caused by poor microphone placement or other issues. When converting a stereo file to mono, the presence of phase issues can cause the left and right channels to cancel each other out partially or completely.

Clipped Signal

A clipped or overloaded signal can result from several causes, including poor gain staging in a preamp during recording, bad electrical cables, or surface damage to an analog recording.

Silence

Silence detects parts of the audio file at which the audio signal falls to zero (0). You can set the threshold below which Soundtrack Pro considers the signal to be silence.

To select the types of analysis to perform:

- 1 In the Analysis Type list, select the checkboxes next to the types of analysis you want to perform on the audio file.
- 2 To analyze the file, click Analyze.

Setting Analysis Parameters

The Clicks and Pops and Silence analysis types have parameters you can set. Each type has a Threshold slider you can drag to set the threshold for detecting clicks and pops or detecting silence.

To set analysis parameters:

- 1 In the Analysis Type list, click the disclosure triangle for the analysis types for which you want to set parameters.
- 2 Drag the Threshold slider left to lower the threshold or right to raise the threshold. You can also type a value in the Threshold field.

Reading Analysis Results

When you analyze an audio file, the problems detected through analysis are shown in the Results list. For each item, the following information appears in the Results list.

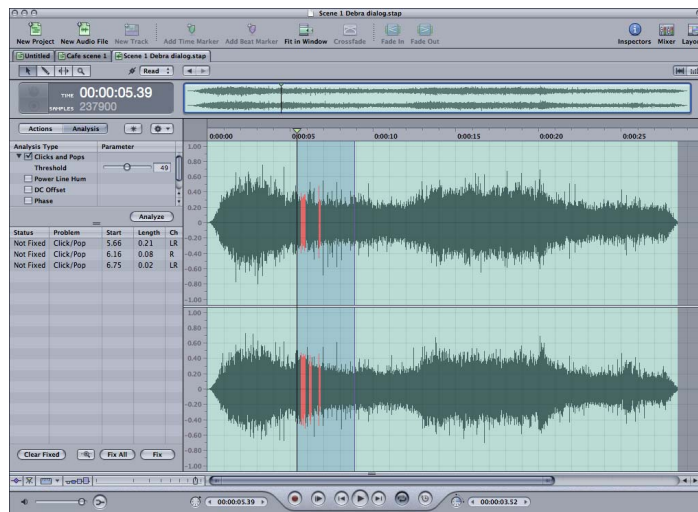

- *Status*: Shows whether the problem is fixed or not fixed.
- *Problem*: Shows the analysis type to which the problem belongs.
- *Start*: Shows the point at which the problem begins.
- *Length*: Shows the duration of the problem.
- *Channels*: Shows whether the problem occurs in the left channel (L), the right channel (R), or both channels (LR) of a stereo audio file.

You can select items in the Results list. When you select an item in the Results list, the part of the audio file to which the problem applies becomes red in the waveform display, making it easy to see where in the audio file the problem occurs. If you select multiple items, the parts of the audio file to which any of the selected problems apply become red.

Zooming In on Analyzed Problems

You can zoom in on an item in the Results list using the Magnify button, so you can see the problem area of the audio file closely.

To zoom in on an item in the Results list:

- 1 In the Results list, select the item.
- 2 Press and hold the Magnify button, located at the bottom of the Results list.



The waveform display zooms in on the problem area for as long as you hold the Magnify button.

To zoom in and stay at the new zoom level:

- 1 In the Results list, select the item.
- 2 Command-click the Magnify button.

Fixing Analyzed Problems

You can select items in the Results list and fix them individually, in groups, or all together. When you select a single item, the part of the waveform where the item occurs becomes red.

To fix an item:

- Select the item in the Results list, then click the Fix button.

You can select multiple items to fix by Shift-clicking or Command-clicking. You can also fix all items in a single operation.

To fix all items in one operation:

- Click the Fix All button.

Once you have fixed a problem, you can remove it from the Results list, so that you can focus on remaining problems.

To clear fixed items from the Results list:

- Click the Clear Fixed button.

Using Markers in the Waveform Editor

You can insert markers in an audio file project in the same way as in a multitrack project. Markers can be useful for indicating where a specific sound, cue, or event begins or ends in the audio file. They can also be useful for indicating an area of an audio file you want to time stretch.

When an audio file project has two or more markers, you can select the area between two markers by double-clicking in the waveform display. For more information, see “Selecting Part of an Audio File” on page 154.

For information about inserting, naming, moving, and deleting markers, see “Working With Markers” on page 119.

Scripting Actions in the Waveform Editor

You can save a series of actions in the Waveform Editor as an AppleScript droplet, and use the droplet to modify other audio files. You can apply the actions in a saved droplet while you are working in Final Cut Pro using the Send To shortcut menu. You can also drag files or folders onto a droplet, making it easy to batch process files.

You can edit the droplet in the AppleScript Script Editor to adjust action settings. This is especially helpful when you want to apply the same series of actions to multiple files, or when you want to apply actions repeatedly, changing one or several settings each time. You can apply a droplet to another audio file, or group of files, by dragging files or folders containing a group of files onto the droplet.

To save a series of actions as a droplet:

- 1 Open an audio file in the Waveform Editor.
- 2 Apply the actions to the audio file.
- 3 Choose File > Save as AppleScript.
- 4 In the Save dialog, type a name for the droplet.

By default, droplets are saved to the location `user/Library/Scripts/Soundtrack Pro Scripts`. Do not change the location or Soundtrack Pro and Final Cut Pro may not be able to find and use your saved droplets.

Applying a Saved Droplet to a Clip in Final Cut Pro

You can apply a series of actions saved as a droplet to a clip in Final Cut Pro.

To apply a saved droplet to a clip in Final Cut Pro:

- In the Final Cut Pro Timeline or Bin, Control-click the clip, choose Send To > Soundtrack Pro Script from the shortcut menu, then choose the droplet you want to apply from the submenu.

Soundtrack Pro opens with the clip visible in the Waveform Editor. The actions are applied to the clip, the clip is saved with the changes, and the Waveform Editor moves to the background, behind the Final Cut Pro windows.

You can import a video into a multitrack or audio file project, view the video as you work on your project, edit the video's audio, and use markers to synchronize audio and video.

When you import a video, the video appears in the Video tab of the Utility window. When you import a video into a multitrack project, a video clip appears in a video track in the Timeline. The video's audio appears as a clip in an audio track in the Timeline, and can be moved and edited like other audio clips. You can mute, solo, and adjust the volume and pan of the video's audio, add effects, and automate changes. You can also open the video's audio in the Waveform Editor and perform actions or analysis on it.

When you import a video from Final Cut Pro, you can set the Time ruler units to match the timecode format of the video. Any Final Cut Pro scoring markers contained in the video appear as markers in the Timeline. You can also add markers in Soundtrack Pro and export them to Final Cut Pro with the video file. You can score markers to the playhead, using them to synchronize your soundtrack to the action in the video.

You can work with video in Soundtrack Pro in several ways. You can add audio clips for dialogue and voiceover, music, ambience, and sound effects to the Timeline. You can make roundtrips between Final Cut Pro and Soundtrack Pro as you work on both the video and the soundtrack, or bring the final video into Soundtrack Pro to finalize the project. When your soundtrack is complete, you can export it as an AIFF file or save it as part of the video.

Supported Video File Formats

Soundtrack Pro supports standard QuickTime-compatible file formats. You can import a QuickTime movie (.mov) video file into a Soundtrack Pro project, and can import an MPEG-2 (.m2v) if you have installed the QuickTime MPEG-2 Playback Component. Video files using NTSC, PAL, HD, and other formats supported by QuickTime can be imported into Soundtrack Pro. Imported video files can be up to four hours in length.

Adding a Video to a Project

You can import a video file by dragging the file from the Media and Effects Manager or from the Finder. You can import only one video file into a project.

To import a video file into a project, do one of the following:

- Drag the video file from the Media and Effects Manager or the Finder to the Video tab of the Utility window.
- Drag the video file from the Media and Effects Manager or the Finder to the video track in the Timeline.

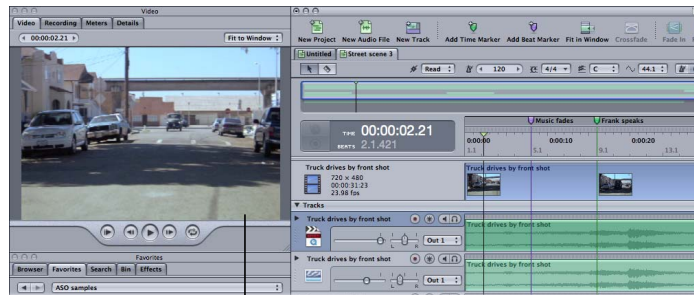
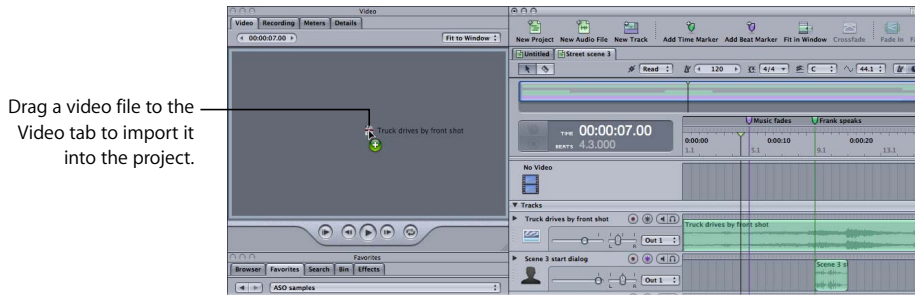

The video appears in the Video tab.

The video is displayed in the Video tab in its correct aspect ratio, and a video clip appears in the video track (the top track in the Timeline), letting you see the duration of the video in the project. The video clip starts at the beginning of the project and cannot be moved to another point in time. Any Final Cut Pro scoring markers included in the video file appear in the Timeline with an orange handle.

If the video contains audio, new audio tracks are added below the video track for each audio track in the movie, and the video's audio tracks appear as audio clips in the new tracks. You can move, resize, and edit these audio clips like any audio clip in the Timeline, and can use the track controls to control volume and pan, mute or solo the track, and add effects or automation.

Playing the Video

When you play the project, the video plays in time with the audio in your project. You can also control playback of the video and the project using the video transport controls in the Video tab, or using keyboard shortcuts.



- *Play from Beginning*: Starts playback from the beginning of the video.
- *Previous Frame*: Moves the video back one frame.
- *Play*: Plays the video from the current playhead position.
- *Next Frame*: Moves the video forward one frame.
- *Cycle*: Cycles playback of the video so that it repeats from the beginning each time the playhead reaches the end of the video.

To view the video, you can make the Video tab active or detach it from the Utility window and move it to another location onscreen. You can also view the video using an external video output device.

Controlling Video Playback Using Keyboard Shortcuts

There are a number of keyboard shortcuts you can use to control playback of the video in the Video tab. To use keyboard shortcuts, the pointer cannot be in a text field.

- *Space bar*: Plays the video from the current playhead position. This is equivalent to clicking the Play button.
- *Return*: Sets the playhead to the beginning of the video. If the playback region is active, pressing Return sets the playhead to the beginning of the playback region. This is equivalent to clicking the Go to Beginning button in the transport controls.
- *Command-Left arrow*: Moves the video back (closer to the beginning) one frame. This is equivalent to clicking the Previous Frame button.
- *Command-Right arrow*: Moves the video forward (closer to the end) one frame. This is equivalent to clicking the Previous Frame button.

For a complete list of Soundtrack Pro keyboard shortcuts, see Appendix B, “Soundtrack Pro Keyboard Shortcuts,” on page 279.

Resizing the Video Tab

You can resize the Video tab (to any size, up to filling your entire screen), and can detach the Video tab.

To resize the Video tab, do one of the following:

- Drag the Resize handle at the lower-right corner of the Video tab until the tab is the size you want.
- Drag the edge of the Video tab to resize it along with the other windows.
- Click the Resize button at the upper left of the Utility window while the Video tab is active. The Video tab resizes to fill the screen.

Using Video Output Devices

You can connect an external video output device to your computer and play your project through the video output device. This can be especially useful in cases where you are using Soundtrack Pro as the final step in producing the overall project, or when you want to show the current version of the project to a client or other party while working on the project in Soundtrack Pro.

When you use an external video output device, the quality of the output is as high as the device can support. If you connect an output device capable of broadcast quality output, the video is displayed with more accurate colors than possible on a computer display, with true interlacing, correct pixel sizes, the correct aspect ratio, and broadcast quality refresh rates.

Broadcast quality video output devices receive both the video and audio from a project, so you can connect high-quality monitors or speakers to hear the audio. However, using a video output device can introduce a greater amount of latency into the audio signal. The amount of latency may be higher than is acceptable for audio editing.

You can also play a project's video externally using Digital Cinema Desktop. Using Digital Cinema Desktop, you can connect an Apple Cinema Display to your computer and play the video full-screen through the Cinema Display while using another monitor for editing.

To play the video through a video output device, you must configure Soundtrack Pro to use the device in Soundtrack Pro Video Out Preferences.

To configure Soundtrack Pro for a video out device:

- 1 Choose Soundtrack Pro > Preferences, then click the Video Out button.
- 2 In the Video Out pane, choose the device you want to use from the Video Output Device pop-up menu.

The menu lists only devices that are connected to your computer.

- 3 Optionally, select the Use Quarter-size Frames checkbox to reduce the frames sent to the video output device. Sending quarter-size frames can result in better performance, especially for devices using FireWire DV output.
- 4 Click the Close button at the upper-left corner of the Preferences window to close the window.

You can switch the output to the video output device on or off when the project is not playing. The video appears in the Video tab whether output to the video output device is switched on or off.

To switch off output to an external video output device:

- Choose View > Show > Show External Video.

If you have added the Video Out button to the Toolbar, you can also click the button to switch off the device.

To switch on output to an external video output device:

- Choose View > Show > Show External Video.

If you have added the Video Out button to the Toolbar, you can also click the button to switch on output to the device.

A video output device can only be controlled by one application at a time. If you hide Soundtrack Pro or bring another application to the foreground while playing video through a video output device, Soundtrack Pro maintains control of the output device and continues playing. If you hide Soundtrack Pro or bring another application to the foreground when video is not playing through a video output device, Soundtrack Pro releases control of the output device.

Viewing Video Details

You can view details of a video file, including the video file's name, dimensions, length, frame rate, and other information. You can view details of a video file that has been added to a project, or a video file in the Media and Effects Manager.

To view details of a video file:

- 1 If the Details tab is not visible, click Details to make it active.
- 2 Select the video file in the Media and Effects Manager, or select the video clip in the Timeline.

The video file's information appears in the Details tab.

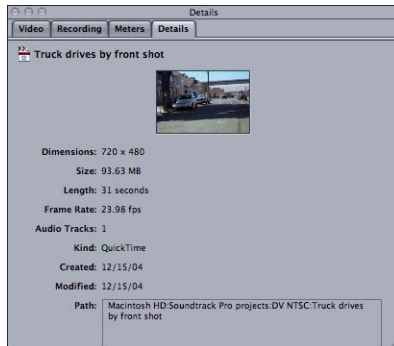

You can preview a video file in the Details tab before you add it to a project.

To preview a video file in the Details tab:

- 1 If the Details tab is not visible, click the Details button to make it active.
- 2 In the Media and Effects Manager, select the video file you want to preview.
- 3 In the Preview controls at the bottom of the window, click Play.

Working With a Video's Audio

You can edit the audio clip of the video's audio as with any audio clip in the project. You can move and resize the video's audio, split and join it, or open it in the Waveform Editor for processing or analysis. You can also change the name or icon of the track containing the video's audio, and use the controls in the track header to adjust volume and pan, mute or solo the track, change the time format, or enable the track for recording.

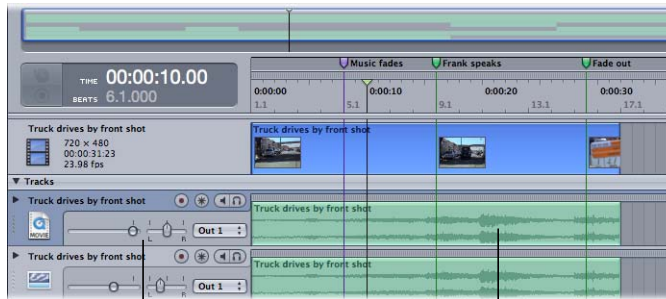

You can adjust the video's audio using the controls in the track's header.

The video's audio track

If you remove the video from the project, the audio clip of the video's audio is not deleted, but remains in the project. You can delete the clip separately if you want to remove it.

Using the Time Display and Time Ruler With Video

When you import a video file into a Soundtrack Pro project, the Time display and Time ruler adjust to show the timecode format of the video. The Time display and Time ruler can display time in seconds, frames, drop frames, or non-drop frames. You can choose the format for timecode display, and can set the video frame rate for projects not containing a video file. You can also set the default frame rate for new projects in the Project Preferences pane.

To choose the units shown in the Time display and Time ruler:

- Choose View > Time Ruler Units, then choose a time format from the submenu.

To choose the video frame rate for projects not containing a video file:

- 1 Choose View > Time Ruler Units > Set Video Frame Rate.
- 2 In the dialog that appears, choose a frame rate from the Frame Rate pop-up menu.

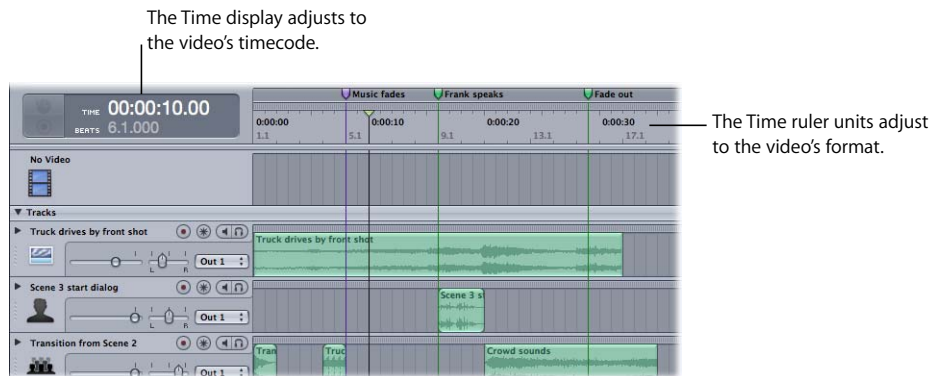

For more information on the Time ruler, see “Using the Time Ruler” on page 98.

Using Markers With Video

Soundtrack Pro displays Final Cut Pro scoring markers included in a video file imported from Final Cut Pro. You can add time markers at points in time corresponding to specific timecode positions in the video clip, and align audio clips with markers using the snap feature. When you add a marker to a project containing a video, the video clip displays the frame of the video that occurs at the marker's position in time.

For more information about adding and moving markers, see “Working With Markers” on page 119.

You can score both Final Cut Pro scoring markers and time markers to the playhead, letting you synchronize the audio with specific points in the video.

Using Final Cut Pro Scoring Markers

When you import a video file from Final Cut Pro or Final Cut Express HD, Soundtrack Pro displays any Final Cut Pro scoring markers included in the video file in the Timeline. Scoring markers have an orange handle in the area above the Time ruler. You cannot move or edit Final Cut Pro scoring markers in Soundtrack Pro.

Using Markers to Align Audio Clips to Timecode

You can add a time marker at a specific timecode position in a video clip, and align audio clips with the time marker or with a Final Cut Pro scoring marker.

To add a time marker at a specific timecode position in a video clip, do one of the following:

- Type the timecode position where you want to add the marker in the Time display, press Return, then choose Mark > Insert Time Marker (or press M).
- Add a time marker, Control-click the marker's handle, then type the timecode position in the Edit dialog.
- Make the Details tab active, add a time marker, select the marker handle, then enter a new position in the Position value slider in the Details tab.

In order to add a marker at a specific timecode position, the Time ruler units must be set to the timecode format of the video in your project.

To align an audio clip with a marker:

- Make sure that snap is turned on and that Markers is selected in the View > Snap to menu, then drag the clip to the position of the marker in the Timeline.

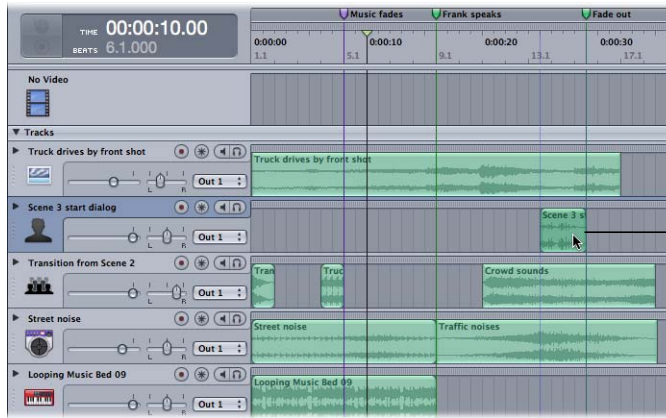

With Markers selected, you can align a clip with a marker.

Scoring a Marker to the Playhead

For tracks set to Beats-based time format, you can score a time marker or Final Cut Pro scoring marker to the playhead, so that you can synchronize the audio with the video. Scoring a marker to the playhead adjusts the tempo so that the required number of beats exactly fills the amount of time between the last tempo change and the marker's position in the Time ruler.

When you score a marker to the playhead, a set of special envelope points is created in the project's tempo envelope, from the previous envelope point (or the beginning of the tempo envelope, if no previous envelope point exists) to the position of the marker. These special envelope points are locked and cannot be moved (but can be deleted). The locked envelope points, and the segment of the tempo envelope between them, appear red.

The tempo change created when you score a marker to the playhead is always instantaneous; that is, the tempo changes from the previous tempo immediately, without ramping. The distance between the two envelope points determines whether the resulting tempo change can be heard easily. If the resulting change in tempo sounds too abrupt, you can edit the tempo envelope to make the tempo change less noticeable.

To score a marker to the playhead:

- 1 Select the marker's handle at the top of the Timeline, above the Time ruler.

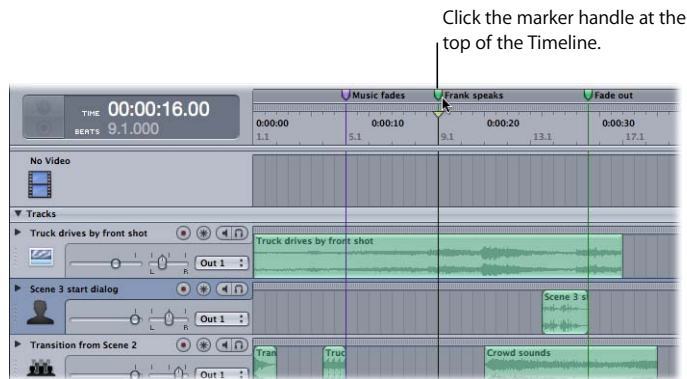

- 2 Choose Mark > Score Marker to Playhead.

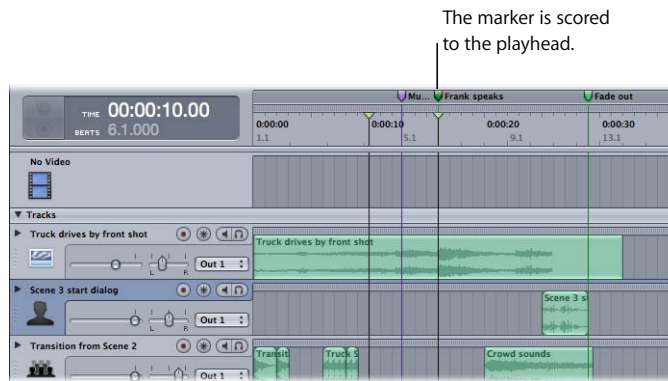

You can also adjust the tempo relative to a marker's position by Option-dragging the marker in the Timeline. As you drag, the red segment of the tempo envelope moves vertically as the tempo changes. By Option-dragging a marker, you can synchronize the marker's position with the Beats-based units.

Note: If you score a marker to the playhead, and the tempo change resulting from the scoring operation sounds too noticeable or extreme, you can undo the scoring operation. After undoing the scoring operation, add an envelope point to the tempo envelope at a point after any audio clips you do not want to be affected by the tempo change, but before the marker to be scored, then repeat the scoring operation.

Removing a Video From a Project

You can remove a video if you decide you no longer want to use it in the project.

To remove a video clip from a project, do one of the following:

- Select the video clip in the Timeline, then choose Edit > Delete (or press the Delete key).
- Control-click the video clip, then choose Remove Video from the shortcut menu.

When you remove the video from a project, the audio clip of the video's audio is not deleted, but remains in the project. You can delete the clip separately if you want to remove it.

For information about using Soundtrack Pro with Final Cut Pro, including transferring a project back and forth between Soundtrack Pro and Final Cut Pro, see Chapter 14, "Using Soundtrack Pro With Apple Professional Applications," on page 253.

You can modify the sound of your project in many ways using audio effects. Soundtrack Pro includes a complete set of professional-quality audio effects you can use in your projects.

You can use audio effects to add both subtle and dramatic changes to audio clips in a multitrack project or to an audio file project. Soundtrack Pro includes effects for equalization, compression, reverb, and other effects you can use to clean up audio, perform sound design, and enhance the sound of your audio. You can also use third-party Audio Units effects plug-ins in both multitrack and audio file projects.

Realtime and Processing Effects

Soundtrack Pro gives you two ways to use audio effects in your projects: realtime effects and processing effects.

Realtime Effects

You can add realtime effects to tracks, busses, and outputs in a multitrack project, or to an audio file project. Realtime effects modify the audio as it passes through them, so you hear any changes you make, or any new audio you add, through the sound of the effect. Each realtime effect has effect parameters you can adjust to control how the effect modifies the audio. You can also automate effect parameters to create changes over time.

You can create *effects chains* on a track, bus, output, or audio file using realtime effects. An effects chain is a series of effects that modify the audio in a set order. Using busses in the Timeline and Mixer, you can create submixes, and apply the effect to all the tracks in a submix with one set of controls.

For information on working with realtime effects in both multitrack and audio file projects, see “Working With Realtime Effects” on page 207.

Processing Effects

You can apply processing effects to an audio file project. The Process menu includes an Effects submenu where you choose processing effects to add to your project. Processing effects are added as actions, which you can turn on or off, reorder, and adjust in the Actions list.

For information about working with processing effects in the Waveform Editor, see “Working With Processing Effects” on page 216. For information on working with actions, see “Working With Actions” on page 170.

Audio Effects Included With Soundtrack Pro

Soundtrack Pro includes the following types of audio effects:

- *Dynamics*: Dynamics effects let you shape the volume of your projects over time. Bundled dynamics effects include Compressor, Multipressor, Adaptive Limiter, and Noise Gate.
- *Distortion*: Distortion effects change the tone of the audio signal to recreate the sound of overdriven tube amplifiers or digital distortion. Bundled distortion effects include Bitcrusher, Clip Distortion, Distortion, Exciter, and Phase Distortion.
- *EQ and Filter*: EQ (short for equalization) effects let you change the level of selected frequencies. EQ provides a powerful way of shaping the sound of your projects. Bundled EQ effects include High Cut and Low Cut, High Pass and Low Pass filters, Channel EQ, Linear Phase EQ, Match EQ, and Parametric EQ.
- *Modulation*: Modulation effects delay an audio signal and shift (*modulate*) when the delayed signal plays back relative to the original signal. Bundled modulation effects include Chorus, Flanger, Modulation Delay, Phaser, Scanner Vibrato, and Tremolo.
- *Reverb and Delay*: Reverb effects can be used to simulate the sound of acoustic spaces, both realistic and unnatural. Delay effects can be used to add echoes and other recurring sounds. Bundled reverb and delay effects include PlatinumVerb, Soundtrack Pro Reverb, Stereo Delay, Tape Delay, and Space Designer, a powerful tool for sound design.
- *Meters and Diagnostic*: You can use realtime diagnostic effects to clean up audio files in a variety of ways, including pitch, intensity, and phase problems. Bundled diagnostic effects include Correlation Meter, MultiMeter, Test Oscillator, and Tuner. These are only available as realtime effects, not processing effects.
- *Miscellaneous*: Miscellaneous effects fall outside the other categories, providing additional ways to modify your audio. Bundled miscellaneous effects include Denoise, PitchShifter, Spectral Gate, Stereo Spread, SubBass, and Vocal Transformer.

Dynamics Effects

Dynamics effects let you adjust the dynamic range (the range between the softest and loudest sounds) of your projects. You can use dynamics effects to make sounds more focused and to optimize the sound for specific playback situations. Dynamics effects include compressors, limiters, and noise gates.

Compressors

Compressors work like an automatic volume control, lowering the volume whenever it rises above a certain level, called the *threshold*. But why would you want to reduce the dynamic level? By cutting the peak levels, the compressor lets you raise the overall volume of the signal. This gives the sound more focus by making the foreground parts stand out while preventing the background parts from becoming lost in the mix. Compression also tends to make sounds tighter or “punchier.” Because the peaks are lower, the maximum volume is reached more quickly.

In addition, a compressor can make a project sound better when played back in different situations. For example, the speakers on a television set or in a car sound system typically reproduce a narrower dynamic range than does the sound system in a theater. Compressing the overall mix can help make the sound reproduce more clearly in lower-fidelity situations.

Compressors have two main parameters. The threshold lets you set the amplitude above which the compressor lowers the volume. The *ratio* lets you control the amount by which sounds above the threshold will be lowered, as a percentage of the original signal.

For example, if you set the threshold to -12 dB, and the ratio to 2:1, a sound at -7 dB (5 dB above the threshold) is reduced by 2.5 dB, and a sound at -2 dB (10 dB above the threshold) is reduced by 5 dB.

Compressors can also include parameters for *attack* and *release*. These parameters let you set how quickly the compressor reacts once the threshold is reached (for attack) or once the signal falls below the threshold again (for release). Use these parameters to make the compressor’s effect more subtle or more pronounced. Another parameter on some compressors is the *knee* (or *soft knee*), which lets you control how gradually the compressor transitions between no compression and the compression ratio at the threshold.

Compressors are typically used on vocal tracks to make the vocals prominent in the overall mix. They can also be used on music and sound effects tracks, but rarely on ambience tracks.

Limiters

Limiters (also called *peak limiters*) prevent the audio signal from exceeding a maximum volume level. A compressor gradually attenuates levels above the threshold, but a limiter puts a hard limit on any signal louder than the threshold. You use a limiter mainly to prevent clipping.

Noise Gates

A noise gate alters the signal in the opposite direction from a compressor. While a compressor lowers the volume of sounds above the threshold, a noise gate lowers the sounds below the threshold. Loud signals pass through unchanged, but softer signals, such as the decay of a loud instrument, are cut off. Noise gates can be used to eliminate low-level noise or hum from an audio signal.

Distortion Effects

Distortion effects simulate the sound of analog and digital distortion. After working to eliminate the digital distortion caused by clipping from a project, why would you add distortion as an effect? The distortion produced by overdriven vacuum tubes (which were used in amplifiers and music recording equipment before the development of digital recording technology) produces an effect which many people find pleasing, and which is integral to many styles of popular music. Analog tube distortion adds a distinctive warmth and bite to the signal.

There are also distortion effects which intentionally cause clipping and digital distortion of the signal. These can be used to modify vocal, music, and other tracks to produce an intense, unnatural effect, or for creating sound effects.

Distortion effects include parameters for *tone*, which let you shape the way in which the distortion alters the signal, and for *gain*, which let you control how much the distortion increases the output level of the signal.

EQ and Filter Effects

EQ is likely the most common audio effect used in postproduction. You can use EQ to shape the sound of a project by adjusting specific frequencies or frequency ranges. Using EQ, you can create both subtle and extreme changes to the sound of your projects.

Most EQ effects make use of filters. As the name suggests, a filter allows certain frequencies to “pass through” to the output while stopping or attenuating other frequencies. EQ effects include highpass, lowpass, and band pass filters.

When the audio signal passes through an EQ filter, the frequencies that pass through can be raised or lowered in volume. Raising and lowering frequencies using EQ is often referred to as *boosting* and *cutting* frequencies. You can create many changes to the sound of your project by boosting and cutting various frequencies.

Frequency Ranges Used With EQ

All musical sounds can be categorized into one of three basic frequency ranges: bass, midrange, or high (also called treble). These can be further divided to include low bass, low and high midrange, and low and high highs. The following table describes some of the sounds affected by each range:

Name	Frequency range	Description
High High	8–20 kHz	Includes cymbal sounds and highest harmonics of instruments. Boosting frequencies in this range slightly can add sparkle and presence.
High	5–8 kHz	This range corresponds roughly to the treble tone control on a stereo. Boosting frequencies in this range can add brightness and shine.
Low High	2.5–5 kHz	Includes the higher harmonics of voices and musical instruments. This range is important for adding presence. Excessive boosting in this range can sound shrill or harsh.
High Midrange	1.2–2.5 kHz	Includes the consonants of voices and the high harmonics of musical instruments, especially brass instruments. Excessive boosting in this range can create a pinched, nasal sound.
Midrange	750 Hz–1.2 kHz	Includes the vowels of voices and the harmonics of musical instruments that create tone color.
Low Midrange	250–750 Hz	Includes the fundamentals and lower harmonics of voices and musical instruments; careful EQing of each can keep them from competing. Excessive boosting in this range can result in muddy and unclear audio; excessive cutting can produce thin-sounding audio.

Name	Frequency range	Description
Bass	50–250 Hz	Corresponds roughly to the bass tone control on a stereo. Includes the fundamental frequencies of voices and of musical instruments. Excessive boosting in this range can sound boomy and thick.
Low Bass	50 Hz and below	Also called <i>sub bass</i> . Very little of the sound of voices or musical instruments falls in this range. Many sound effects used in movies, such as explosions and earthquakes, fall in this range.

Note: The frequencies shown for each range are approximate. Any division of sound into frequency ranges is somewhat arbitrary, and is meant only to give a general indication of each range.

Roll-Off Filters

The simplest types of EQ effects are *roll-off filters*, which include lowpass, highpass, bandpass, and shelf filters. Lowpass filters affect all frequencies above a specific frequency, called the *cutoff frequency*. Frequencies above the cutoff are attenuated or “rolled off” gradually, usually by a fixed number of decibels per octave. Highpass filters, by contrast, affect all frequencies below their cutoff frequency. Bandpass filters exclude all frequencies close to their *center frequency*. You can set the center frequency, and also set the *bandwidth* or *Q*, which specifies how wide a range of frequencies around the center frequency are affected.

These EQs include parameters for setting the cutoff frequency. Shelf filters add parameters to control the *gain* (the amount of boost or cut). You can use roll-off filters as “broad brush” effects to boost or cut a large range of frequencies.

Graphic EQs

Graphic EQs give you a set of filters (often with 10 or 31 filters), each with a set center frequency and bandwidth. Using a graphic EQ, you can shape a wide variety of frequencies throughout the frequency range. Graphic EQs can be used to shape the sound of the overall project mix.

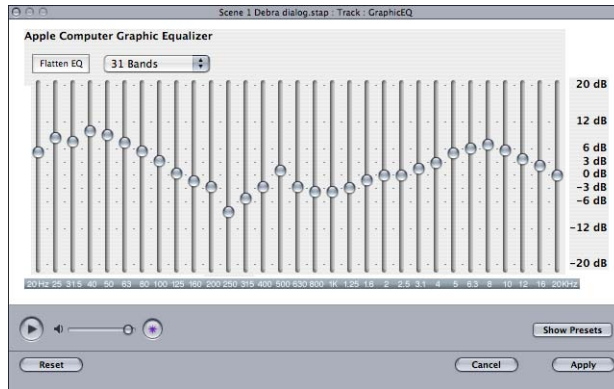

Parametric EQs

Parametric EQs are similar to bandpass EQs, but provide a greater amount of control, and can be used for extremely precise adjustments. With a parametric EQ, you can set the center frequency, the gain, and the bandwidth. Used carefully, a parametric EQ can help a track cut through the mix, or help a track or project sound fuller. Parametric EQs can also be used to remove specific, unwanted frequencies from a mix.

Modulation Effects

Modulation effects begin with a delayed signal, like time-based effects, but vary (or *modulate*) the delay time, typically using an LFO. This can be used to double a sound, making it seem stronger and “fatter,” to simulate a group of voices or instruments playing together, or to add a distinctive character to the sound. Modulation effects include chorus, phase shifters, and flangers.

Chorus

Chorus effects play back multiple repetitions of the delayed signal (like reverbs), but vary the delay time for each one, using an LFO. As the name implies, this effect can strengthen the sound, and create the impression that the sound is being played by many instruments or voices in unison. The slight variations in delay time created by the LFO simulate the subtle differences in timing and pitch heard when several people play together. Using chorus also adds fullness or richness to the signal, and can add movement to low or sustained sounds.

Phase Shifters

Phase shifters produce a characteristic “whooshing” sound by combining the original signal with a copy of the signal that is slightly out of phase with the original. This means that the amplitudes of the two signals’ sound waves reach their highest and lowest points at slightly different times. The time between the two signals is modulated, typically using an LFO. As the two signals go in and out of phase, certain frequencies, called *notch frequencies*, are created, which give phase shifters their distinctive sound.

The main difference between chorus and phase shifting is the amount of delay time. Chorus effects typically use delay times between 20 and 30 milliseconds (ms), while phase shifters (and flangers, discussed next) typically use shorter delay times, between 1 and 10 ms.

Flangers

Flangers work in much the same way as do phase shifters, but additionally change the pitch of the delayed signal slightly. Flanging is typically used to create a more extreme change than phase shifting, sometimes described as adding a “spacey” or “underwater” effect.

All of the modulation effects include parameters for the *delay rate* (also called *speed* or *frequency*), which let you set the minimum delay time; *depth* (also called *width* or *intensity*), which you use to set how much the LFO modulates the delay time; and *mix*, which you use to control the ratio of the effected (wet) signal to the original (dry) signal. They can also include parameters for *feedback* (or *regeneration*), which add part of the output back into the input signal.

Reverb and Delay Effects

Reverbs and delays work by copying a part of the audio signal, delaying it for a brief period of time, and then playing it back with the original signal. The delayed signal can be played back multiple times, and can be modified in a variety of ways.

Delay

A delay effect stores the audio signal, and then plays back each repetition at a regular rate of time after the original signal. Delays can be used for doubling individual sounds (for example, making it sound as if a group of instruments is playing the same melody), to achieve echo effects (making it sound as though the sound was occurring in an immense space), and to enhance the stereo position of tracks in a mix. Delay effects are not commonly used on an overall mix except to achieve special effects (such as to create an “otherworldly” sound).

Delay effects let you set the *delay time*, the time between the original signal and the delayed signal. Delays often provide parameters for *feedback* (also called *regeneration*), which let you set how much of the delayed signal is fed back into the delay's input, creating more repetitions of the delay (like the number of "bounces" in an echo). Specific types of delay have other parameters: Tap tempo delays let you set the delay time by physically tapping a key or controller; stereo delays include parameters for the pan position of the output signal, which can be shifted over time using a low-frequency oscillator (called an *LFO*).

Reverb

Reverberation, usually shortened to *reverb*, simulates the sound of acoustic environments such as rooms, concert halls, caverns, or the sound of infinite space. In any acoustic space, sounds echo off the surfaces of the space (the floor, walls, and ceiling) over and over, gradually dying out until they become inaudible. Reverb effects consist of thousands of delays, of varying lengths and intensities, that simulate these natural echoes. Reverb helps define the sense of space in which sounds take place, and can be used to simulate both realistic and fantastic acoustic environments.

The first form of reverb actually used a room with hard surfaces (called an *echo chamber*) to add echoes to the signal. Mechanical devices, including plates and springs, were also used to add reverberation to the output of instruments and microphones. Digital sound recording has made it possible to use digital reverbs, which use complex algorithms (sets of equations) to simulate various acoustic environments with greater accuracy and flexibility.

Simple reverb effects provide parameters for the *decay time* or *reverb time*, which let you set how long the reverb lasts before dying away, and the *mix* or *level*, which you use to set the ratio of the effected signal (called the *wet* signal) to the original (the *dry* signal). More sophisticated reverbs can include the following parameters:

- *Room type*: Lets you set the type of space the reverb will simulate: a small or large room, a hall, or another type of acoustic space.
- *Predelay time*: In an acoustic space, there is a short period of silence between a sound and the time when the initial echoes of the reverb begin. Different spaces have different amounts of predelay, which helps "tell" our ears how large the space is. Longer predelay settings also help separate the original (dry) signal from the effected (wet) signal, making it sound clearer and sometimes larger.
- *Early reflections*: The first echoes to arrive from the surrounding surfaces in a space are determined by the size and shape of the space, and "tell" our ears what type of space it is.
- *Diffusion*: Lets you set the number of the echoes in the reverb. Hall reverbs typically have low diffusion settings, while plate reverbs typically have high diffusion settings.

- *High-frequency and low-frequency reverb time:* These parameters let you specify the decay of higher and lower frequencies separately. Different surfaces, such as wood floors and concrete walls, absorb high and low frequencies at different rates, and these parameters let you simulate the sound of different environments more closely.
- *Reverb envelope:* Lets you control how much the volume of the reverb changes over time. In natural acoustic situations, the reverb echoes decay gradually over time. You can re-create this gradual decay, or gate the reverb so that it cuts off more abruptly.

Meters and Diagnostic Effects

Diagnostic effects help you analyze and clean up audio in a variety of ways. Each type of diagnostic effect provides a different way to “look at” an audio clip or file, and each has a unique set of parameters. These effects are available only as realtime effects in the Effects tab and the Mixer, not as processing effects.

Correlation Meter

The Correlation meter displays the phase relationship of a stereo signal. A correlation of +1 (plus one, the far right position) means that the left and right channels “correlate” 100% (that is, they are completely in phase). A correlation of 0 (zero, the center position) indicates the widest permissible left/right divergence, often audible as an extremely wide stereo effect. Correlation values less than zero indicate that out-of-phase material is present, which can lead to phase cancellations if the stereo signal is combined into a monaural signal.

MultiMeter

The MultiMeter combines the functions of the Level Meter and Correlation Meter (as described above) with several other analysis tools:

- A Spectrum Analyzer
- A Goniometer for judging the phase coherency in the stereo sound field

The control panel to the left of the display allows you to switch between the Analyzer and Goniometer and contains parameter controls for the MultiMeter. The Stereo Level and Correlation Meter are always visible.

Spectrum Analyzer

The Spectrum Analyzer divides the audio signal into 31 independent frequency bands. Each frequency band represents one third of an octave. The filter curves comply to IEC document 1260.

You turn on the Spectrum Analyzer by clicking the Analyzer button. Turning on the Spectrum Analyzer turns off the Goniometer. The four buttons below determine what portion of the input signal the Analyzer is displaying. You can choose between *Left* or *Right* channel only. *LR max* shows the maximum band levels of either channel, while *Mono* displays the levels of the stereo signal summed to mono.

The *View* options determine the level represented by the top line of the scale in the display (*Top*; range: -40 to +20 dB) and the overall dynamic range of the Spectrum Analyzer (*Range*; range: 20 to 80 dB). These two parameters can also be set directly in the display: By dragging directly on the bar graph, you can shift the top line of the display. Dragging directly on the dB scale allows you to compress or expand the scale's range. The *View* options are useful when analyzing highly compressed material as you can identify smaller level differences more easily by moving and/or reducing the display range.

There are three display respond modes: *RMS Slow*, *RMS Fast*, and *Peak*. RMS Slow and RMS Fast modes show the effective signal average (Root Mean Square) and offer a good representation of the perceived volume levels. Peak mode shows level peaks accurately.

Goniometer

The Goniometer helps you to determine the coherence of the stereo image. Using the Goniometer, you can see phase problems as trace cancellations along the center-line (M=mid/mono). Goniometers developed when early two channel oscilloscopes first appeared. Users would connect the left and right stereo channels to the X and Y inputs while rotating the display by 45 degrees, resulting in a useful visualization of the signal's stereo phase.

The signal trace slowly fades to black, imitating the glow of the tubes found in older Goniometers, and at the same time enhancing readability.

Clicking the Goniometer button turns on the Goniometer and turns off the Spectrum Analyzer. You can use the *Auto Gain* display parameter in order to obtain a higher readout on low-level passages. Auto Gain allows the display to automatically compensate for low input levels. You can set the amount of compensation with the Auto Gain parameter, or set Auto Gain by dragging directly in the display area of the Goniometer.

Note: Auto Gain is a display parameter only and increases the display for better readability. The actual audio levels are not touched by this parameter.

Miscellaneous Effects

Miscellaneous effects don't fall into any of the other categories. They include denoising effects, pitch shifting effects, stereo enhancers, bass enhancers, and effects used to transform the sound of vocals. Each effect gives you a different way to modify the audio, and includes a unique set of parameters.

Denoiser

Using the Denoiser, you can eliminate or reduce many kinds of low-level noise (noise floor) from an audio signal. The main parameters of the Denoiser are *Threshold*, *Reduce*, and *Noise Type*. The Threshold parameter sets how high the noise floor is for the audio signal. The recommended method for setting the Threshold is to find a passage where you hear only noise, then set the Threshold so that signals at this volume level are filtered out.

The Reduce parameter sets the level to which amount the noise floor is reduced. You use the Noise Type parameter to set the type of noise that the Denoiser reduces. There are three choices of noise type:

- Setting the Noise Type to 0 (zero) causes the Denoiser to reduce “white noise” (all frequencies reduced equally).
- Setting the Noise Type to a positive value causes the Denoiser to reduce “pink noise” (harmonic noise; greater bass response).
- Setting the Noise Type to a negative value causes the Denoiser to reduce “blue noise” (hiss, sibilants, tape noise).

The Denoiser recognizes frequency bands with a lower volume and less complex harmonic structure, and then reduces them to the desired dB value. This method is not completely precise, and neighboring frequencies are also reduced. Using the Denoiser at too-high settings can produce the “glass-noise” effect, which is usually less desirable than the existing noise.

There are three smoothing parameters that you can use to minimize the “glass-noise” effect: *Frequency smoothing*, *Time smoothing*, and *Level smoothing*. Raising the Frequency smoothing slider results in a smoother transition of denoising to the neighboring frequencies. When the Denoiser recognizes that only noise is present in a certain frequency band, the higher the Frequency Smoothing parameter is set, the more it will also change the neighboring frequency bands to avoid glass noise.

By adjusting the Time smoothing slider, you can set the amount of time the Denoiser takes to reach maximum noise reduction. By adjusting the Level smoothing slider, you can set a factor for a smoother transition between adjacent volume levels. When the Denoiser recognizes that only noise is present in a certain volume range, the higher the Transition smoothing parameter is set, the more it will also change similar level values to avoid glass noise.

Stereo Spread

The Stereo Spread plug-in is a useful effect for sound design or audio clean-up. It enhances the perception of stereo by extending the stereo base. Some stereo enhancing algorithms function by changing the phase of the signal, which can distort your mix and produce unpredictable results. Instead, the Stereo Spread plug-in extends the stereo base by distributing a selectable number of bands in the middle frequency range alternately left and right. This increases the perception of stereo without causing unnatural-sounding distortion of the mix.

The main parameters of the Stereo Spread plug-in are *Order*, *Upper Intensity* (Upper Int.), and *Lower Intensity* (Lower Int.). The Order parameter determines number of frequency bands into which the signal is divided. The Upper Intensity parameter controls the intensity of the base extension of the upper frequency bands. The Lower Intensity parameter controls the intensity of the base extension of the lower frequency bands.

Human beings perceive stereo placement of sounds mainly in the middle and high frequencies. If very low frequencies are distributed between the left and right speakers, the energy distribution for both speakers will be significantly worse. Therefore, it is always best to select a lower intensity setting for the lower frequency bands, and avoid setting the *Lower Freq.* below 300 Hz.

Working With Realtime Effects

You can add realtime effects to a track, bus, or output in a multitrack project, or to an audio file project, and then adjust the effect parameters to control the way in which the effects alter the sound of the track or project.

Working in the Effects Tab

The Effects tab is where you add realtime effects and adjust realtime effect parameters. When you click the Effects button in the header of a track, bus, output, or in the Waveform Editor, the Effects tab becomes active and displays the current effects settings for the track, bus, output, or project.

The upper part of the Effects tab contains lists of available effect categories. When you click an item in the Category list, the available effects in that category appear in the Effect list, where you can select and add them to the current effects chain.

The lower part of the Effects tab shows the effects and sends in the current effects chain. You can show and edit effect and send parameters in the Effect Parameters area.

Adding Realtime Effects

You can add realtime effects in the Effects tab. You can create *effects chains*, which are a series of effects in a specific order. You can reorder effects in an effects chain at any time, and hear the results immediately.

To add a realtime effect to a track, bus, or output in the Timeline:

- 1 Click the Effects button in the header of the track, bus, or output in the Timeline.
- 2 In the Effect list, select a category in the Category list to display the effects for that category in the Effect list.
- 3 In the Effect list, do one of the following:
 - Double-click the effect you want to add.
 - Select the effect name, then click the Add Effect button.
 - Drag the effect to the Effect Parameters area.

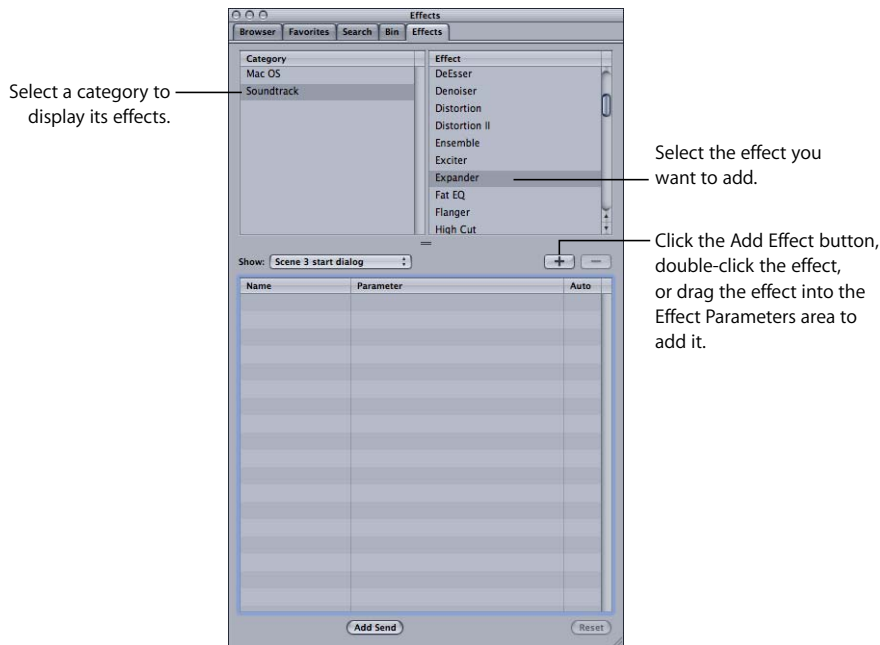

To add a realtime effect to a track, bus, or output in the Mixer:

- Control-click an effects slot in the channel strip of the track, bus, or output, choose Add Effect from the shortcut menu, then choose an effect from one of the submenus.

To add a realtime effect to an audio file project in the Waveform Editor:

- 1 In the Waveform Editor, click the Effects button, located next to the Actions and Analysis buttons.
- 2 In the Effects tab, select a category in the Category list to display the effects for that category in the Effect list.
- 3 In the Effect list, do one of the following:
 - Double-click the effect you want to add to the track.
 - Select the effect name, then click the Add Effect button.
 - Drag the effect to the Effect Parameters area.

Some effects, including reverb and delay, add audio that extends past the end of the file. This is called an effect “tail.” When you export a project mix, or export a track, bus, or output with an effect that produces a tail, the exported file is lengthened to include the effect tail until the point at which the tail falls below -96 dB. Also, when you choose Process > Bounce Realtime to Action for an audio file project with a realtime effect that produces a tail, the rendered project is lengthened to include the effect tail until the point at which the tail falls below -96 dB.

Adjusting Realtime Effect Parameters

Once you’ve added a realtime effect, you can adjust the effect parameters to change the way the effect alters the sound of the track, bus, output, or audio file project. Each type of effect has its own parameters, as discussed earlier. Effect parameters are displayed in the Effect Parameters area of the Effects tab as a set of sliders, checkboxes, and pop-up menus.

To adjust realtime effect parameters:

- 1 Click the disclosure triangle next to the effect in the Effect Parameters area to display its parameters.
- 2 Adjust the effect parameter by dragging the slider, selecting the checkbox, or choosing an item from the pop-up menu. You can also adjust the parameter by entering a valid value in the field to the right of the parameter’s control.

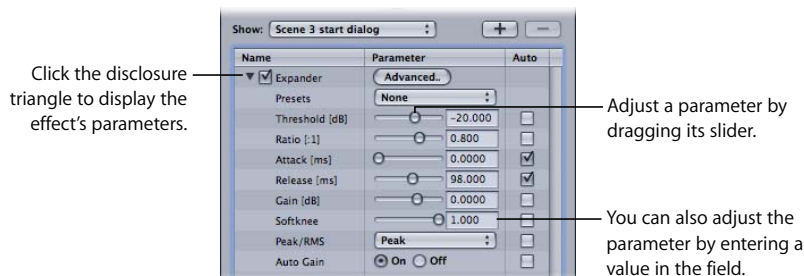

Chaining and Reordering Realtime Effects

You can add more than one realtime effect to a track, bus, output, or audio file project. Adding multiple effects to an effects chain is called *chaining* effects.

When you add multiple effects, the effects are applied in sequence, meaning that the output of the first effect becomes the input for the next effect, and so on, for each effect in the chain. The order in which effects are applied is important, because each alters the input signal, which includes the output of previous effects in the chain. You can reorder effects and hear the difference in the way they alter the sound.

To add multiple effects to an effects chain, do one of the following:

- Double-click the effect you want to add in the Effect list.
- Select the effect in the Effect list, then click the Add Effect button.

The effect appears in the Effect Parameters area below any previously added effects. You can now set the parameters of the added effect.

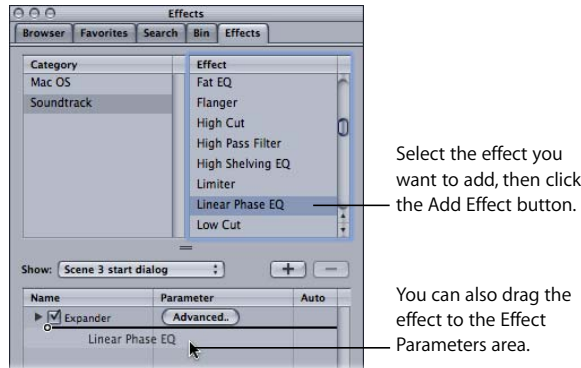

Note: Adding more than a few effects to an effects chain can cause extreme changes to the sound of a project. This may be what you want, but in some cases can produce undesirable results. Listen to the project as you add effects to be sure you are satisfied with the results.

To reorder effects in an effects chain:

- In the Effect Parameters area, drag the effect up or down in the list to change its order.

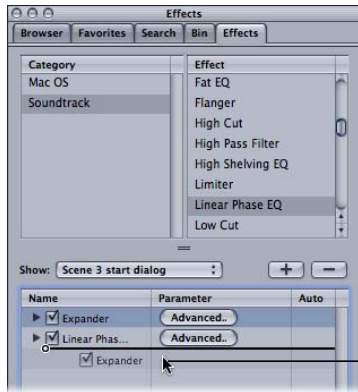

Bypassing Realtime Effects

You can turn off an effect in the Effects tab, which “bypasses” the effect in the effects chain. When you bypass an effect, the effect is not heard, but all effect parameters are retained. To hear the effect again, reselect the effect’s checkbox. This lets you hear how each effect in a chain alters the sound.

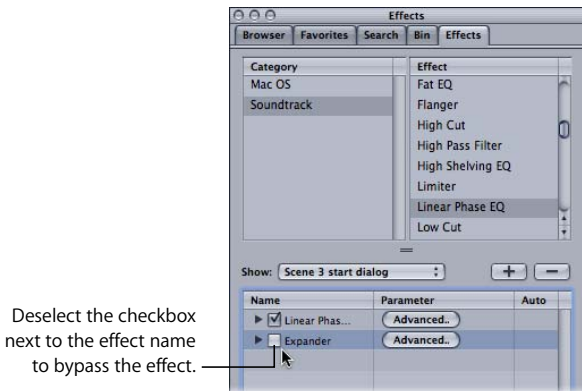

To bypass an effect:

- In the Effects tab, deselect the checkbox next to the effect.

Adding Sends to Tracks

You can add sends to a realtime effects chain. When you add a send, the send is added at the end of the current effects chain. You can move the send to another place in the effects chain, choose the bus for a send, adjust send volume and pan, and bypass a send.

To add a send to a track:

- In the Effects tab, click the Add Send button.

A send appears below the last effect in the track's effects chain. You can assign the send to a bus in the Effects tab or the Mixer.

Reordering Sends

You can reorder sends in the Effects tab or in the Mixer.

To reorder a send:

- In the Effect Parameters area or in the Mixer, drag the send up or down in the list to change its order.

Choosing the Bus to Which a Send Is Routed

When you add a send, the audio is routed from the send to a bus. By default, the first send you add to an effects chain is routed to Bus 1, the second send is routed to Bus 2, and so on, if the default bus exists. Once you add a send, you can choose the bus to which the send is routed.

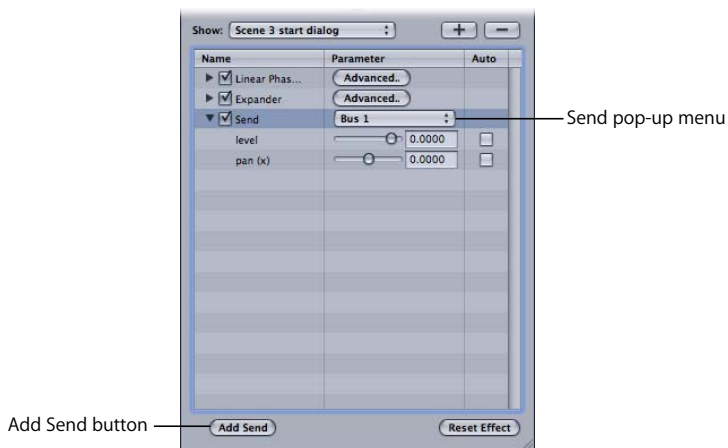

To choose the bus to which a send is routed:

- In the Effect Parameters area of the Effects tab, choose a bus from the Send pop-up menu.

Adjusting Send Volume

You can adjust the volume level for the audio routed through a send.

To adjust send volume:

- 1 If the send volume slider is not visible, click the disclosure triangle for the send.
- 2 Drag the send volume slider left to lower the volume level, or drag it right to raise the volume level.

Adjusting Send Pan Position

You can adjust the pan position for the audio routed through a send.

To adjust send pan position:

- 1 If the send pan slider is not visible, click the disclosure triangle for the send.
- 2 Drag the send pan slider left to pan the send to the left, or drag it right to pan the send to the right.

Bypassing Sends

You can bypass a send. When you bypass a send, the audio is not routed to the bus for the send, and is not heard.

To bypass an effect:

- In the Effects tab, deselect the checkbox next to the send.

Automating Realtime Effect Parameters

You can automate realtime effect parameters using envelopes. When you automate an effect parameter, you can change the value of the parameter over time.

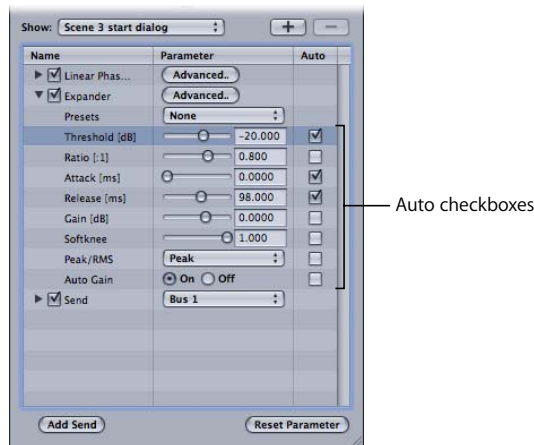

To automate a realtime effect parameter:

- 1 In the Effects tab, select the Auto checkbox next to the parameter's control.
- 2 In the Timeline or in the Waveform Editor, show the envelopes for the track, bus, output, or audio file project.

In the Timeline, you show the envelopes for the track, bus, or output with the effect. In the Waveform Editor, you show the envelopes for the audio file project.

- 3 Add and adjust envelope points in the effect's envelope.

For information on adding and adjusting envelope points, see Chapter 10, "Working With Automation," on page 219.

When you automate an effect parameter with units of time (seconds or milliseconds) or beats per minute (BPM) for values, the parameter is linked to the project tempo. If the tempo changes, the value of the parameter changes to keep the same relationship to the new tempo.

Resetting Realtime Effects to Their Default Settings

Every realtime effect has default parameter settings that are displayed in the Effect Parameters area when you first add the effect. You can reset an effect to its default parameter settings, or reset an individual parameter to its default setting.

To reset a realtime effect to its default settings:

- In the Effects tab, select the effect name in the Effect Parameters area, then click the Reset button.

To reset an individual effect parameter to its default settings:

- Select the parameter in the Effect Parameters area to select the parameter, then click the Reset button.

Removing Realtime Effects

You can remove a realtime effect from an effects chain.

To remove an effect:

- Select the effect name in the Effect Parameters area, then click the Remove Effect button on the right edge of the Effects tab (or press the Delete key).

Advanced Settings for Realtime Effects

Many realtime effects have an advanced settings window. The advanced settings window appears as a floating window with related controls grouped together, and may provide an appearance that simulates a hardware effects device. Effects with an advanced settings window have an Advanced button at the top of the Effect Parameters area in the Effects tab.



Advanced settings windows can contain different kinds of controls.

To show the advanced settings window for a realtime effect, do one of the following:

- In the Effects tab, click the Advanced button for the effect.
- In the Mixer, double-click the effect name.

In the Mixer, Control-click the effect name, then choose Show [effect name] Advanced Settings.

When you show an advanced settings window, you can adjust the effect's parameters by moving the controls in the window. Each advanced settings window may have unique controls in addition to sliders, buttons, and value fields.

To adjust advanced effect controls:

- 1 In the advanced settings window, drag the sliders, type text, and operate the controls.
- 2 Click Apply.

Working With Processing Effects

You can apply processing effects to an audio file or a selected part of a file in the Waveform Editor. In the Waveform Editor, you apply a processing effect by choosing the effect from the Effects submenu of the Process menu, as described in “Applying Actions” on page 171. Processing effects are applied as actions, and appear in the Actions menu of the Waveform Editor. You can reorder processing effects, turn them on or off, and perform all of the operations for actions described in “Working With Actions” on page 170.

Advanced Settings for Processing Effects

You adjust processing effect parameters in the advanced settings window for the processing effect. When you apply a processing effect by choosing the effect from the Process > Effects submenu, the advanced settings window for the effect appears in front of the Project window. You can also show the advanced settings window if you want to adjust processing effect parameters.

To show the advanced settings window for a processing effect:

- Double-click the effect in the Actions list.

When you open an advanced settings window for a processing effect, the window includes controls to play the project with the effect, adjust volume level, apply the effect, reset effect parameters, and cancel applying the effect.

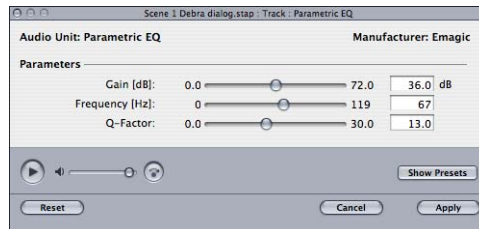

For information on using the preview controls in the advanced settings window, see “Effects Submenu” on page 161.

Automating Processing Effect Parameters

For the effects in the categorized submenus at the top of the Effects submenu of the Process menu (not including Mac OS effects), you can add an envelope for an effect parameter by Control-clicking the parameter in the advanced settings window. You can add envelope points to the envelope to automate changes to the effect parameter.

Working With Effect Presets

Some effects have several combined parameter settings called *presets*. For example, the MatrixReverb effect (in the Mac OS category) has presets for various sizes of room, hall, and chamber settings, as well as Plate reverb and Cathedral settings. If an effect has presets, the presets appear in a Factory Presets pop-up menu in the list of effect parameters.

Realtime Effect Presets

For realtime effects, you can choose effect presets in the Effect Parameters area of the Effects tab.

To apply a preset to an effect:

- In the Effect Parameters area, choose the preset from the Presets pop-up menu.

Processing Effect Presets

For processing effects, you can select presets in the advanced settings window. You can show an effect's presets, add and delete presets, apply a preset, adjust preset parameters, and create your own presets.

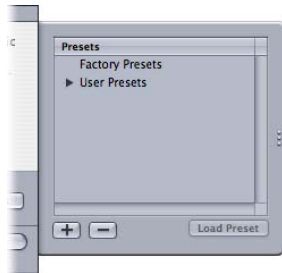

To show effect presets for a realtime effect:

- Click the Show Presets button in the advanced settings window.

To show effect presets for a realtime effect:

- Click the Show Presets button in the advanced settings window.

The Presets drawer appears to the right of the advanced settings window.

To add a preset:

- 1 Click the Add Preset (+) button.
A blank, untitled preset appears in the User Preset list.
- 2 Click the name "Untitled" and type a name for the preset.

To apply an effect preset:

- 1 Select the preset you want to apply from either the Factory Preset or User Preset list in the Presets drawer.
- 2 Click the Load Preset button.

To adjust effect preset parameters:

- Adjust the controls in the advanced settings window for the preset.

To delete a preset:

- 1 Select the preset in the Presets drawer.
- 2 Click the Delete Preset (–) button.

To hide the Presets drawer:

- Click the Hide Presets button in the advanced settings window.

Using automation, you can create changes over time to volume, pan, effects, and other controls.

Automation offers a powerful way to add drama and interest to your projects. You can automate volume and pan changes to tracks, busses, and outputs and automate changes to effect and effect send parameters in multitrack projects. You can also automate volume, pan, and effects changes in audio file projects.

Soundtrack Pro gives you three ways to work with automation:

- You can add and adjust envelope points on envelopes in the Timeline and in the Waveform Editor.
- You can record changes to sliders, faders, and other controls in the Timeline, the Mixer, and the Effects tab.
- You can record movements to controls on a control surface connected to your computer and mapped to Soundtrack Pro commands and functions.

Working With Envelopes

In the Timeline, each track, bus, and output has a set of envelopes. The envelopes appear as horizontal lines stretching across the length of the project directly below the track, bus, or output. You adjust an envelope by adding *envelope points* and moving the envelope points to new values at different points in the Timeline.

The Timeline also includes master envelopes for tempo and transposition. When you show the master envelopes, they appear below the last output in the Timeline.

For video editors accustomed to working in Final Cut Pro, envelopes provide the same type of functionality as keyframes. The difference is that you can edit envelopes at a finer level of precision than you can using keyframes, allowing extremely powerful control over automated changes.

Track, Bus, and Output Envelopes

Each track and bus has envelopes for volume and pan, and each output has a volume envelope. By default, the envelopes are hidden. When you show the envelopes, they appear in rows below the track, bus, or output in the Timeline.

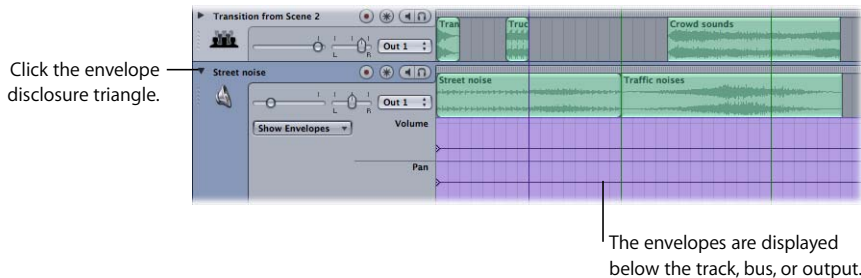

To show the envelopes for a track, bus, or output:

- Click the envelope disclosure triangle in the track header. Click the disclosure triangle again to hide the envelopes.

The ranges of volume and pan envelopes are equivalent to the ranges of the corresponding track controls:

- *Volume envelopes:* The range is from -96 dB to $+6$ dB.
- *Track pan envelope:* The range is from 100% Left to 100% Right pan, with Centered at the midpoint, 0 (zero).

When you add effects to a track, bus, or output, you can automate the effect parameters by adding an envelope for any parameter to the envelopes for the track, bus, or output. The envelopes are different for each type of effect. For information on adjusting effect parameters, see “Working With Audio Effects” on page 195.

Master Envelopes

Each project has master envelopes for transposition and tempo. When you display the master envelopes, they appear below the outputs in the Timeline.

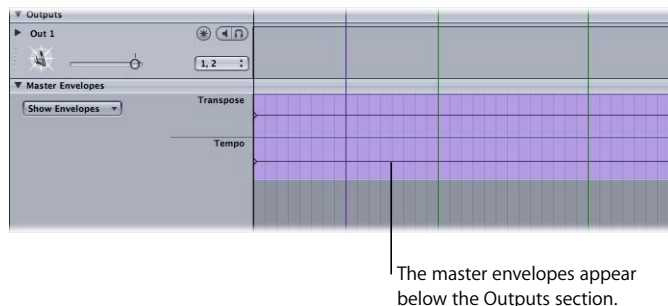

To show or hide the master envelopes, do one of the following:

- Choose View > Show Master Envelopes.
- Click the Master Envelopes button in the lower-left corner of the Project window.
- Click the Master Envelopes disclosure triangle in the Timeline.

Repeat the procedure to hide the master envelopes.

The ranges of the master envelopes are as follows:

- *Master transpose envelope:* Ranges from –12 semitones to +12 semitones.
- *Master tempo envelope:* Ranges from 60 bpm to 200 bpm.

Adding Envelope Points

You create changes to an envelope by adding envelope points to the envelope, and moving the envelope points to different values.

To add an envelope point to an envelope:

- Double-click the envelope at the position where you want to add the envelope point. You may want to zoom in to work more precisely.

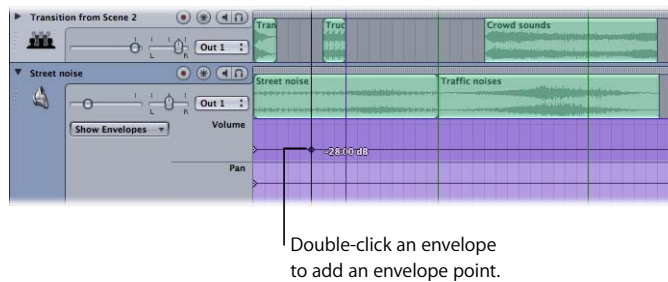

When you add envelope points, they snap to the closest Snap To position if snap is turned on. For information on setting the Snap To value, see “Using Snap” on page 72.

Selecting Envelope Points

You can select a single envelope point or a group of adjacent or nonadjacent envelope points.

To select an envelope point:

- Click the envelope point.

To select multiple envelope points, do one of the following:

- Drag from an area in the automation row before the first envelope point you want to select to an area after the last envelope point you want to select.
- If the envelope points are adjacent, Shift-click the first envelope point, then the last envelope point you want to select. All envelope points in between are also selected.
- Command-click each envelope point you want to select. You can select adjacent or nonadjacent envelope points by Command-clicking.

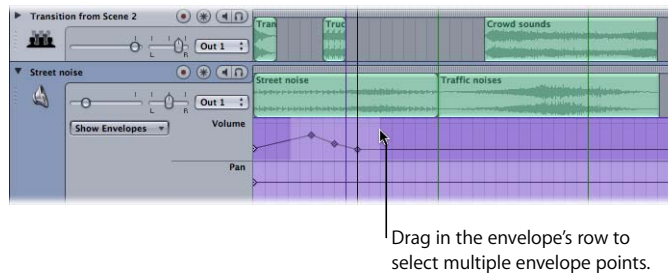

To deselect a selected envelope point, do one of the following:

- Command-click the selected envelope point.
- Click in the automation row or somewhere else in the Timeline to deselect all selected envelope points.

Moving Envelope Points

Once you add an envelope point, you can drag it up or down to change its value. As you drag an envelope point up or down, its value appears to the right of the pointer. You can drag an envelope point left or right to change its position in time. You can also select and move multiple envelope points.

When you move envelope points, the position of the envelope points snaps to the closest Snap To position if snap is turned on. For information on setting the Snap To value, see “Using Snap” on page 72.

To move an envelope point:

- Select the envelope point, then drag it to a new position.

Each envelope has an envelope point at the beginning of the Timeline. You can adjust the envelope by moving this envelope point up or down. If no envelope points have been added, dragging the envelope's handle adjusts the envelope for the entire project.

If you add more than one envelope point to an envelope, you can move envelope points using the corresponding slider. When you move the slider, the envelope points closest to the playhead (the closest before and the closest after) move by the same amount as the slider.

Changing the Values of Envelope Points Numerically

You can also change the value of an envelope point numerically.

To change the value of an envelope point numerically:

- 1 Control-click the envelope point, then choose Set Value from the shortcut menu.
- 2 Type a new value for the envelope point in the dialog that appears.

The envelope point moves to the new value. You can set the envelope point to the same value as the previous or next envelope point on the envelope from the shortcut menu.

Changing the Position of Envelope Points Numerically

You can change the position of an envelope point in the Timeline numerically.

To change the position of an envelope point numerically:

- 1 Control-click the envelope point, then choose Set Position from the shortcut menu.
- 2 In the dialog that appears, click the left or right arrow, click the center of the value slider and drag left or right, or double-click the value slider and type a new position.

The envelope point moves to the new position.

Viewing and Editing Envelope Point Details

You can also view and edit the value, position, and other details for an envelope point in the Details tab.

To view envelope point details:

- 1 In the Utility window, click the Details tab.
- 2 Select the envelope point for which you want to view details.

The details for the envelope point appear in the Details tab, including its value and position. You can edit the value and position in the Details tab, change the format for the position, and copy the value of the previous or next envelope point (if one exists).

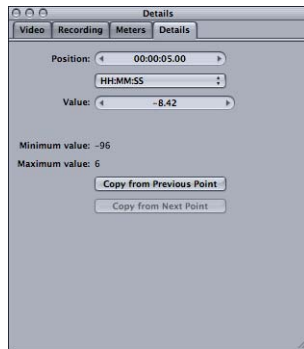

To change the value of an envelope point in the Details tab:

- 1 With the Details tab active, select the envelope point.
- 2 In the Details tab, do one of the following:
 - Click the left arrow in the Value value slider to decrease the value, or click the right arrow to increase the value.
 - Click the center of the value slider, then drag the slider that appears left or right to change the value.
 - Click the text in the value slider to select it, then type a new value.

To change the position of an envelope point in the Details tab:

- 1 With the Details tab active, select the envelope point.
- 2 In the Details tab, do one of the following:
 - In the Position value slider, click the left arrow to move the envelope point back (toward the start of the project) or click the right arrow to move the envelope point forward (toward the end of the project).
 - Click the center of the Position value slider, then drag the slider that appears left or right to change the position.
 - Click the text in the Position value slider, then type a new value.

To change the units shown in the Position value slider:

- Choose the units you want to show from the pop-up menu next to the Position value slider.

To copy the value of the previous envelope point:

- 1 With the Details tab active, select the envelope point to which you want to copy the value.
- 2 In the Details tab, click Copy From Previous Point.

To copy the value of the next envelope point:

- 1 With the Details tab active, select the envelope point to which you want to copy the value.
- 2 In the Details tab, click Copy From Next Point.

Nudging Envelope Points

There are several ways in which you can nudge envelope points using the arrow keys:

- Hold down the Option key and press the Left or Right Arrow key to move the envelope point by one pixel.
- Hold down the Option and Shift keys and press the Left or Right Arrow key to move the envelope point to the previous or next gridline.
- Hold down the Option key and press the Up or Down Arrow key to move the envelope point up or down by one pixel.
- Hold down the Option and Shift keys and press the Up or Down Arrow key to move the envelope point up or down by five pixels.

Cutting, Copying, and Pasting Envelope Points

You can cut and copy selected envelope points and paste them at a different position in the automation row.

To cut envelope points:

- Select the envelope point, then choose Edit > Cut (or press Command-X).

To copy envelope points:

- Select the envelope points, then choose Edit > Copy (or press Command-C).

To paste envelope points:

- Set the playhead to the point where you want to paste the envelope points, then choose Edit > Paste (or press Command-V).

When you paste envelope points into an automation row, the new envelope points replace any existing envelope points, and the automation takes the shape of the cut or copied envelope in the pasted area.

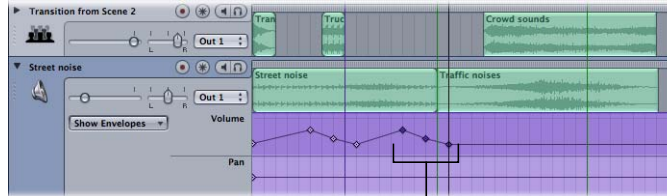

Pasting envelope points into an envelope replaces the existing area of the envelope with the cut or copied area.

When pasting envelope points, the following conditions apply:

- Envelope points can only be pasted into an envelope of the same type as the envelope from which they were cut or copied. For example, envelope points from a volume envelope can only be pasted into a volume envelope, not a pan or tempo envelope.
- Envelope points for an effect parameter can only be pasted into an envelope for exactly the same effect parameter in exactly the same type of effect. You cannot paste envelope points from one effect into another, even if they have parameters with the same name.

Deleting Envelope Points

After listening to the results of your edits, you may decide to delete some envelope points.

To delete envelope points:

- Select the envelope points, then choose Edit > Delete (or press the Delete key).

When you delete envelope points, the envelope adjusts accordingly, moving evenly from the preceding envelope point to the next envelope point. If there are no other envelope points, the envelope becomes horizontal, maintaining its initial value for the entire project.

Automating Effect and Send Parameters

You can automate effect parameters for tracks, busses, and outputs, and for audio file projects by adding envelopes for the effect parameters, then adding and adjusting envelope points. You can also automate send parameters for tracks by adding an envelope for the send parameters, then adding and adjusting envelope points.

To add an envelope for an effect or send parameter:

- 1 Open the Effects tab and select the effect you want to automate.
- 2 In the Effect Parameters area, select the Auto checkbox for the parameter.

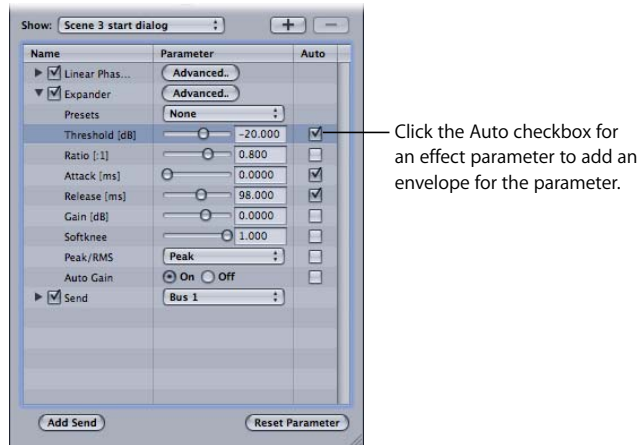

To remove an envelope for an effect parameter:

- Deselect the Auto checkbox for the parameter in the Effect Parameters area of the Effects window.

The range of values for an effect or send parameter envelope is the same as the range for the parameter in the Effects tab.

For detailed information on adjusting effect parameters, see “Adjusting Realtime Effect Parameters” on page 209.

Recording Automation Data

In addition to working with envelopes, you can record automation data in Soundtrack Pro. You can record movements you make to faders, sliders, and other onscreen controls using the pointer. You can also connect a supported control surface to your computer and record movements to controls on the control surface. When you record movements to onscreen controls or control surface controls, the corresponding envelope in the Timeline (or Waveform Editor) changes to display the recorded automation data. You can edit the envelope to fine tune the automation data after recording.

Automation Modes

Soundtrack Pro provides three modes for using and recording automation. The automation modes determine whether automation data is recorded, and what happens when you release the control being recording.

- *Read:* In Read mode, existing automation data is active when you play the project, but no new automation data is recorded.
- *Touch:* In Touch mode, movements to controls are recorded when you play the project, overwriting any existing automation data until you release the control. When you release a control in Touch mode, the control returns to the value it previously had at the point in the Timeline where you release the control. No envelope points after that point are added or changed.
- *Latch:* In Latch mode, movements to controls are recorded when you play the project, overwriting any data from the point you start recording until you stop playing the project. When you release a control in Latch mode, the control maintains the same value at which you released it.

To record automation data for movements to controls:

- 1 Choose either Touch or Latch from the Automation Mode pop-up menu.
- 2 Set the playhead to a position before the point where you want to start recording.
- 3 Click Play (or press the Space bar) to start the project playing.
- 4 While the project plays, move the control you want to record.

Once you have recorded automation data, you can show the envelope for the control and add and adjust envelope points on the envelope to fine tune the automation. For information on working with envelopes, see “Working With Envelopes” on page 219.

For more information on working with control surfaces, see Chapter 12, “Using Control Surfaces With Soundtrack Pro,” on page 243.

Thinning Envelope Points in Recorded Automation Data

Recording automation data can generate a large number of envelope points. The number of envelope points recorded can make editing envelopes difficult, and in some cases affect playback performance.

You can reduce or “thin” the number of envelope points recorded from a control surface in the Project Preferences. You set the amount of thinning using the Automation Recording Sensitivity slider. The automation data is thinned when you finish recording automation.

To set the amount of thinning:

- 1 Choose Soundtrack Pro > Preferences, then click the Project button.
- 2 In the Project pane, drag the Automation Recording Sensitivity slider to adjust the amount of thinning.

When the slider is set to High, no thinning occurs. The envelope contains every movement of the control. Dragging the slider to any position other than High results in some thinning of envelope points. By default, the slider is set to a moderate amount of thinning.

For more information about Soundtrack Pro project preferences, see “Project Preferences” on page 76.

Working With Timeslices

Timeslices let you select the contents of a track, or of multiple tracks, and the track’s envelopes for a section of time. When you select a Timeslice, the Timeslice selection area is highlighted in blue.

Selecting Timeslices

To select a Timeslice from a single track:

- Drag in the selection bar along the top of the track.

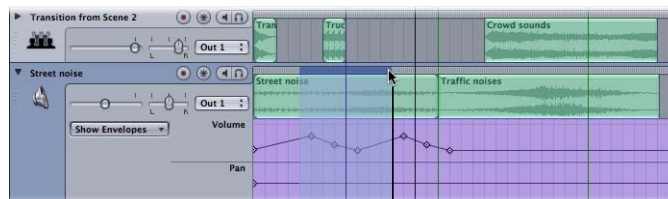

The selection snaps to the nearest Snap To position if snap is turned on. For information about setting the Snap To value, see “Using Snap” on page 72.

To select a Timeslice from multiple tracks:

- 1 Click in the selection bar of the topmost track you want to include in the Timeslice, at one end of the area you want to select.

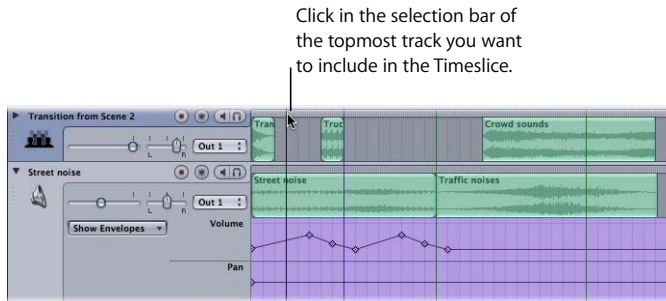

- 2 Shift-click in the selection bar of the bottom track you want to include in the Timeslice at the opposite end of the area you want to select, or Command-click in nonadjacent tracks to add those tracks to the Timeslice.



You can select a master Timeslice that includes the audio content and the envelopes of all tracks, including the video's audio track.

To select a master Timeslice:

- Drag in the selection bar of the video track, located above the Time ruler.



Drag in the selection bar of the video track to create a master Timeslice.

Cutting, Copying, and Pasting Timeslices

You can cut or copy a Timeslice and paste it at a different position in the Timeline.

To cut a Timeslice:

- Select the Timeslice, then choose Edit > Cut (or press Command-X).

To copy a Timeslice:

- Select the Timeslice, then choose Edit > Copy (or press Command-C).

To paste a Timeslice:

- Set the playhead at the position where you want to paste the Timeslice, then choose Edit > Paste (or press Command-V).

If the Timeslice is from a single track, it is pasted in the same track at the current playhead position. If the Timeslice includes multiple tracks, the topmost track of the Timeslice is pasted in the currently selected track, and the remaining tracks are pasted in the tracks below the selected track. If not enough tracks exist for the number of tracks in the Timeslice, a dialog appears asking if you want to create additional tracks.

Deleting Timeslices

To delete a Timeslice:

- Select the Timeslice, then choose Edit > Delete (or press the Delete key).

Changing the Timeslice Selection Area

You can change the length of a Timeslice selection area to include more of the Timeline, either graphically or numerically.

To extend the Timeslice selection area graphically:

- Shift-click in any track included in the Timeslice at the point to which you want to extend it.

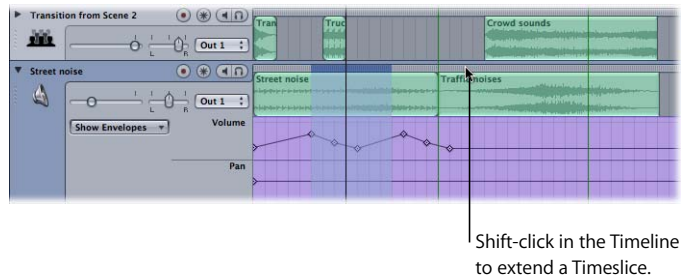

Below and to the right of the transport controls is the Selection Length value slider. When a Timeslice is active, the Selection Length value slider shows the length of the active Timeslice.

The units shown in the Selection Length value slider depend on the project time format. For projects using Time-based format, the value slider shows the current Time ruler units, using the current frame rate. For projects using Beats-based time format, the value slider shows measures, beats, and beat divisions at the current tempo.

To change the length of a Timeslice numerically:

- 1 Click the value slider.
The field becomes a value field, with the current value selected.
- 2 Type a new value into the field, using appropriate punctuation.
- 3 Press Tab or Enter to confirm the new value.

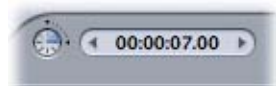

To lengthen the Timeslice in increments:

- Click the left arrow to lengthen the beginning of the Timeslice in increments, or click the right arrow to move the end of the Timeslice in increments.

To lengthen the Timeslice dynamically:

- Click the center area of the field (where the numbers are), then drag left to lengthen the beginning of the Timeslice, or drag right to lengthen the end of the Timeslice.

For projects using Time-based format, the left and right arrows lengthen the Timeslice in seconds. For projects using Beats-based format, the arrows lengthen the Timeslice in beats.

You can record your own audio in a track in the Timeline, as well as recording audio in the Mixer and the Waveform Editor.

You get ready to record by setting recording preferences and checking that your audio equipment is working. For multitrack projects, you enable a track for recording, or record audio in a new track. You can record a single take or record multiple takes. If you record multiple takes, you can review them after recording and choose which one to use in your project, or assemble a composite take using segments of each recorded take.

For audio file projects, you record in the Waveform Editor. When you record in the Waveform Editor, the recording replaces (overwrites) any audio over which you record. If you record for a longer duration than the current length of the file, the file is lengthened to include the recorded audio.

Getting Ready to Record

Before you start recording, also make sure that any audio equipment you plan to use in your recording session (such as microphones, musical equipment, mixers, or external processors) is connected to your computer and is working.

When you record, the recorded audio is saved to disk at the location set in the Recording pane of the Preferences window. Audio files, while smaller than video files of comparable duration, can be quite large (each minute of 16-bit, 44.1 kHz stereo audio requires roughly 10 MB of disk space), so you should make sure you have enough free disk space to store your recordings before you start. You can set the input device and output monitoring device for recording in the Preferences Recording pane, or change them in the Recording tab. For detailed information on Recording preferences, see “Recording Preferences” on page 77.

Recording Audio in the Timeline

You record in the Timeline by enabling a track for recording, setting the playhead, then clicking Record. You can record a single take or record multiple takes by turning on cycling before you start recording. When you finish recording, your recorded audio appears in a track in the Timeline. If you record multiple takes, you can audition each take to choose which one you want to use in your project. You can also assemble composite takes by splitting and combining your recorded takes.

Enabling a Track for Recording

Before you start recording, you enable the track you want to record to. You can record audio only to a track, not to a bus or output. If no track is enabled for recording, a new track is created below the existing tracks, and the take appears on the new track when you click the Record button.

To enable a track for recording:

- Click the Record Enable button (the red circle) in the track's header (or Mixer channel strip).

The Recording tab becomes active, and shows the current recording settings. You can adjust recording settings before you start recording, or between recordings.

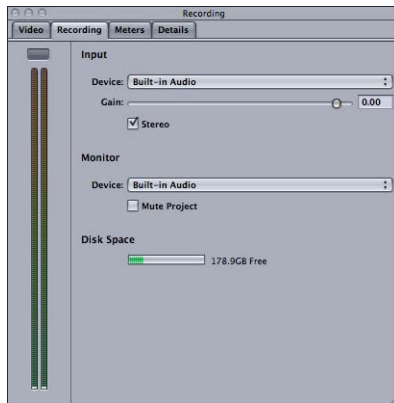

To adjust recording settings:

- 1 In the Recording tab, choose the input device and channel (or pair of channels) from the Input Device pop-up menu.
- 2 Choose the device and channel (or pair of channels) to use for monitoring the recorded audio from the Monitor pop-up menu.
- 3 If you want to record without hearing the existing audio clips in the project, select the Mute Project checkbox.
- 4 If you want to record in mono, deselect the Stereo checkbox.

The level meters in the Recording tab show the level of the audio signal in the input channel. Before recording, you may want to watch the level meters and set the input level, to assure a high enough signal level and to avoid clipping.

Recording a Single Take

You record a single take by setting the playhead to the point where you want recording to start, then clicking the Record button. Recording starts at the playhead position, and ends when you click either the Record or Play button.

To record a single take:

- 1 If you want to record to an existing track, enable the track.
- 2 Set the playhead to the point where you want recording to start.
You can set the playhead using any of the procedures described in “Setting the Playhead” on page 51.
- 3 Click the Record button in the transport controls to start recording.

As you record, the level meters in the Recording tab show the levels of the input signal being recorded. If the input signal clips (rises above 0 dB), the peak indicator lights red.

- 4 To stop recording, do one of the following:
 - Click the Record button again.
 - Click the Play button.

You can punch in and punch out while recording a single take using the Record button. For example, you can start the project playing, then punch in at the point where you want to start recording by clicking the Record button. To punch out, click the Record button again. When you click the Record button while recording, recording stops, but the project continues playing. You can punch in and punch out multiple times while the project is playing.

When you click the Play button, both recording and playback stop.

Recording Multiple Takes

You can record multiple takes in the Timeline. You can record multiple takes using the playback region to define where each take starts and ends, or record for the duration of the project. When you record multiple takes, the takes are “stacked” in a single clip in the Timeline. You can audition each take, and can create composite takes by splitting the clip and choosing the take for each split segment.

To record multiple takes:

- 1 If you want to record to an existing track, enable the track.
- 2 If cycling is turned off, click the Cycle button in the transport controls to turn it on.
- 3 Set the playback region to the part of the Timeline where you want recording to start and end.

For information on setting the playback region, see “Working With the Playback Region” on page 98.

If no playback region is set, recording starts at the beginning of the project and lasts until the end of the last clip in the project. If the project contains no clips, a single take is recorded, starting at the current playhead position.

- 4 Click the Record button in the transport controls to start recording.

As you record, the level meters in the Recording tab show the levels of the input signal being recorded. If the input signal clips (rises above 0 dB), the peak indicator lights red.

The playhead advances to the end of the playback region, then returns to the beginning of the playback region for the next take.

- 5 To stop recording, click the Play button.

When you record multiple takes, the takes are recorded sequentially to an audio file in the recording location set in Recording Preferences. The takes appear in a single clip in the Timeline. The current take number appears in the lower-right corner of the clip. You can choose which take you hear when you play the project. When you finish recording, the current take number corresponds to the number of completed takes.

To choose a take, do one of the following:

- Select the clip, choose Clip > Recording Take, then choose the take number from the submenu.
- Control-click the clip, choose Take from the shortcut menu, then choose the take number from the submenu.

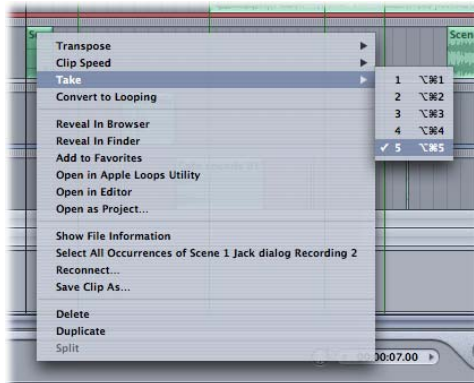

You can split a recorded clip, and choose the take for each segment of the split clip to create a composite take. You can also copy a clip onto several tracks, split the copies, and choose the take for each split copy of the clip.

Saving Recorded Clips

You can save your recordings in the Timeline. When you save a clip, you can name the clip, choose where to save it, and save it as either a looping or non-looping file.

To save a recorded clip:

- 1 Do one of the following:
 - Select the clip in the Timeline, then choose Clip > Save Clip As.
 - Control-click the clip in the Timeline, then choose Save Clip As from the shortcut menu.
- 2 In the Save As dialog, type a name for the clip and browse to the location where you want to save it.
- 3 Select the Looping button to save the clip as a looping file, or click the Non-looping button to save the clip as a non-looping file.
- 4 Click Save.

You can use Apple Loops Utility, a companion application included with Soundtrack Pro, to add tags to your saved recordings to make them easier to find using the Search tab in Soundtrack Pro.

Recording Audio in the Mixer

You can record audio in the Mixer in a similar way to recording audio in the Timeline. You can record a single take or record multiple takes. If you want to record multiple takes using a playback region, you must set the playback region in the Timeline before you start recording in the Mixer.

To record audio in the Mixer, you follow the procedures described in “Recording Audio in the Timeline” on page 236, with the following differences:

- To enable a track for recording in the Mixer, click the Record Enable button (the red circle) in the track’s channel strip.
- In the Mixer, you can set the playhead using the transport controls or the Playhead Position value slider. Because the playhead is not visible in the Mixer, you cannot set it by clicking or dragging.

Recording Audio in the Waveform Editor

You can record audio to an audio file project in the Waveform Editor. When you record audio in the Waveform Editor, you replace (overwrite) any existing audio in the audio file or selection you record to.

You can select part of the file in the Waveform Editor to record to. When you record to a selection, recording starts at the beginning of the selection and ends at the end of the selection. The part of the file after the end of the selection is unchanged.

If no part of the file is selected, recording starts at the playhead position, and lasts until you stop recording. If your recording extends past the end of the audio file, the file is lengthened to include the recording.

To record audio in the Waveform Editor:

- 1 Select the part of the project you want to record to.
If no part of the audio file is selected, recording starts at the current playhead position and proceeds until you stop recording.
- 2 Click the Record button in the transport controls.

As you record, the recorded area appears red in the waveform display. The level meters in the Recording tab show the levels of the input signal being recorded. If the input signal clips (rises above 0 dB), the peak indicator lights red.

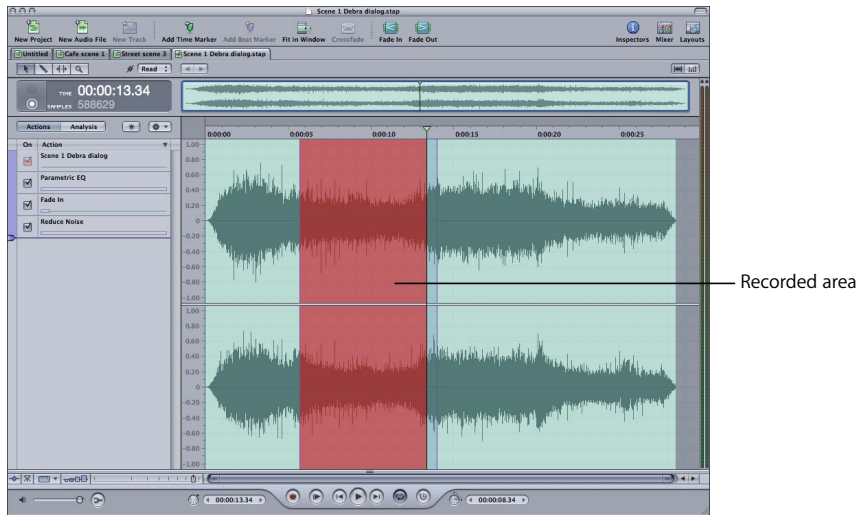

You can connect and use control surfaces to automate recording, mixing, and other tasks in Soundtrack Pro.

Control surfaces provide a set of hardware controls that let you mix and edit your projects with greater flexibility and precision than using a mouse to move onscreen controls. You can also change multiple parameters at once using a control surface.

There are a variety of control surfaces available for use with video and audio production applications. Most control surfaces include faders, knobs, and buttons similar to those found on a hardware mixing console, including channel strip controls for volume, pan, mute, solo, and track selection, and a set of transport controls. Control surfaces also typically provide buttons for selecting parameters to edit and for selecting different tracks or banks of tracks, a jog wheel for moving the playhead precisely, and other controls. When you use a control surface with Soundtrack Pro, some controls are premapped to common functions. You can map other controls to Soundtrack Pro commands and functions in the Control Surfaces Preferences pane.

To use a control surface, you connect it to your computer, add it to Soundtrack Pro, map the controls you want to use to Soundtrack Pro commands, then record control surface automation data in your project. Recorded control surface automation data appears in the corresponding envelope in the Timeline.

Connecting Control Surfaces

Soundtrack Pro supports control surfaces that use the Mackie Control and Logic Control protocols to communicate with your computer. In order to use a control surface, you must first connect the control surface to a MIDI interface, and connect the MIDI interface to your computer, unless the control surface allows direct connection to the computer. Before connecting a MIDI interface, be sure your computer supports the MIDI interface you plan to use. Read the installation instructions included with the MIDI interface, and install the latest version of any appropriate firmware or driver software if needed. For more information, refer to the documentation that came with the control surface and with the MIDI interface.

Adding and Deleting Control Surfaces

When you have connected the MIDI interface to your computer, and connected the control surface to the MIDI interface, you add the control surface in Soundtrack Pro Control Surface Preferences.

To add a connected control surface:

- 1 Choose Soundtrack Pro > Preferences, then click the Control Surfaces button.
- 2 Click the Add (+) button to add the control surface.

The visual representation of the control surface appears in the panel in the upper part of the window.

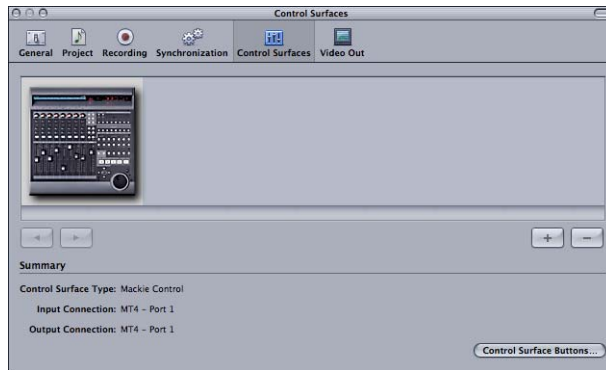

- 3 Choose the type of control surface you are adding from the Control Surface Type pop-up menu.
- 4 Choose the MIDI input port to use for the control surface from the Input Connection pop-up menu.
- 5 Choose the MIDI output port to use for the control surface from the Output Connection pop-up menu.
- 6 Click the Close button to dismiss the Preferences window.

You can delete a control surface, if you decide you don't want to use it any longer.

To delete a control surface:

- 1 Choose Soundtrack Pro > Preferences, then click the Control Surfaces button.
- 2 Select the control surface in the Control Surfaces display area.
- 3 Click the Delete (-) button.

Premapped Controls

When you connect a control surface, many controls are premapped to work with specific Soundtrack Pro buttons and commands. Premapped controls include the following:

Control	Soundtrack Pro button or command
Channel strip volume faders	Track volume slider
Channel strip rotary knobs	Track pan slider
Channel strip record ready buttons	Track Record Enable button
Channel strip select buttons	Select the track.
Channel strip mute buttons	Track mute button
Channel strip solo buttons	Track solo button
Transport controls	Transport controls (Move back, Move forward, Play, Stop, Record)
Jog wheel	Moves playhead back or forward.

Mapping Commands to Control Surface Buttons

Many buttons on control surfaces are not directly assigned to a specific command in Soundtrack Pro. Some buttons, such as the bank and channel buttons, are premapped but can also be mapped to other commands. You can map these buttons in the Control Surface Buttons window and save the mappings or modify them later.

To map a command to a control surface button:

- 1 Choose Soundtrack Pro > Preferences, then click the Control Surfaces button.
- 2 Click the Control Surface Buttons button to show the Control Surface Buttons window.

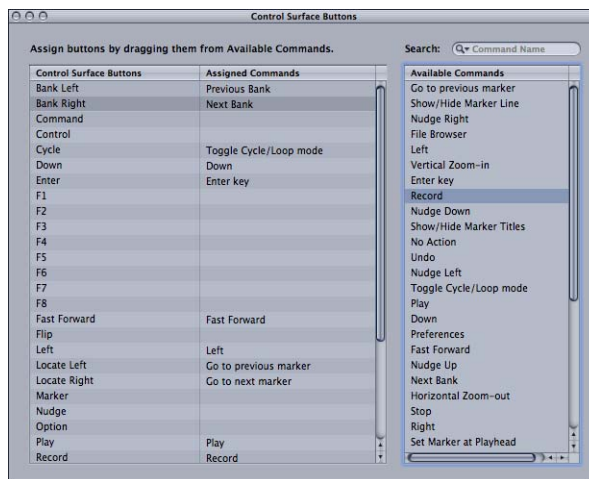

- 3 In the Control Surface Buttons window, drag an action from the Available Commands list (on the right) to a button in the Control Surface Buttons list (on the left) to map the command to the button.
- 4 Optionally, you can search for commands and control surface buttons by typing text in the Search field, located at the upper-right corner of the window.

Recording Control Surface Automation

Once you have connected a control surface and mapped the controls you plan to use, you can use the control surface to control volume, pan, and other functions in your Soundtrack Pro projects. Using the automation modes described in “Automation Modes” on page 228, you can record control surface movements while a project plays.

To record control surface movements, follow the procedures described in “Recording Automation Data” on page 228.

You can thin automation data recorded from a control surface. For information on thinning automation data, see “Thinning Envelope Points in Recorded Automation Data” on page 229.

Once you have created a final mix of a multitrack project, you can export the project mix. You can also export individual tracks, busses, or outputs, and export a multitrack project using Compressor.

You can export a project to a stereo audio file and set the exported file's bit depth and sample rate. You can export selected tracks, busses, or outputs to either a stereo audio file or paired mono files. If your project includes a video, you can also export a project to a variety of formats using the Compressor application.

You can import an exported audio file into Final Cut Pro (or another video application) to add to a video project, or into a digital audio application for further processing. You can also burn it on a CD or DVD, or open it in iTunes and convert it to MP3 or AAC format that you can distribute over the Internet.

Exporting a Project Mix

When you export a mix, all unmuted tracks routed to the first output (Output 1) are included in the exported file. You can exclude any tracks from the exported mix by muting those tracks.

To export a project to a stereo audio file:

- 1 Choose File > Export > Export Mix.

The Export dialog appears.

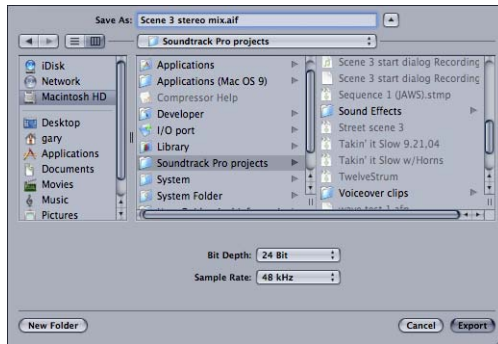

- 2 Choose a bit depth for the exported file from the Bit Depth pop-up menu.
- 3 Choose a sample rate for the exported file from the Sample Rate pop-up menu.
- 4 Type a name for the exported file, and browse to the location where you want to save the file.
- 5 Click Export.

Remember that you can create as many mixes of your project as you like by muting tracks, adjusting controls, effects, and envelopes, and then exporting each version as a separate mix.

Exporting Selected Tracks, Busses, and Outputs

You can export selected tracks, busses, or outputs in a project. When you export selected tracks, busses, or outputs, each is exported to a stereo AIFF file. The output file is given the same name as the track, bus, or output being exported. You can also export a track, bus, or output to a pair of mono files; in this case, the letter *L* is appended to the filename of the left mono file, and the letter *R* is appended to the right mono file.

To export individual tracks, busses, or outputs:

- 1 In the Timeline or the Mixer, select the tracks, busses, or outputs you want to export, then choose File > Export > Export Selected [*item*].

The [*item*] shown in the menu changes depending on whether tracks, busses, or outputs are selected.

If nothing is selected, each unmuted track, bus, and output in the project is exported as an individual AIFF file.

- 2 In the Export dialog, choose the sample rate for the exported files from the Sample Rate pop-up menu.

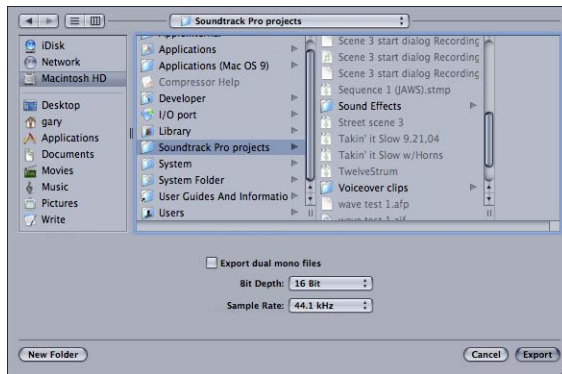

- 3 Choose the bit depth for the exported files from the Bit Depth pop-up menu.
- 4 Optionally, select the “Output dual mono files” checkbox to export the selected tracks, busses, and outputs as dual mono files, then click Save.
- 5 Browse to the location where you want to save the exported files.
- 6 Click Export.

Each selected track, bus, or output is exported as a single stereo AIFF file or as a pair of dual mono AIFF files. Muted and unselected tracks, busses, or outputs are not exported.

When you export a project, track, bus, or output that includes an effect (for example, a reverb or delay) that produces a tail that extends past the end of the project, the exported file lengthens to include the tail.

You can also select part of an audio file and add an effect to a selection. When you add an effect that produces a tail to a selection, the tail is blended with the audio following the selection until the effect level falls below -96 dB. The project lengthens to include the tail if necessary.

Exporting With Compressor

You can export a project using the Apple Compressor application. When you export using Compressor, you can use the presets included with Compressor for your exported file.

When you export a project using Compressor, you can *preserve* or *encode* the video. Preserving the video copies it to the exported file without transcoding. Encoding the video transcodes it to the new export format. Transcoding the video can take longer than copying, and can result in a loss of quality. In most cases, when the video format of the exported file is the same as the source video, you should preserve the video when exporting. If the video format of the exported file is different than the source video, you should encode the video when exporting.

To export a project using Compressor from within Soundtrack Pro:

- 1 Choose File > Export > Export with Compressor.

The Compressor Export Options dialog appears.

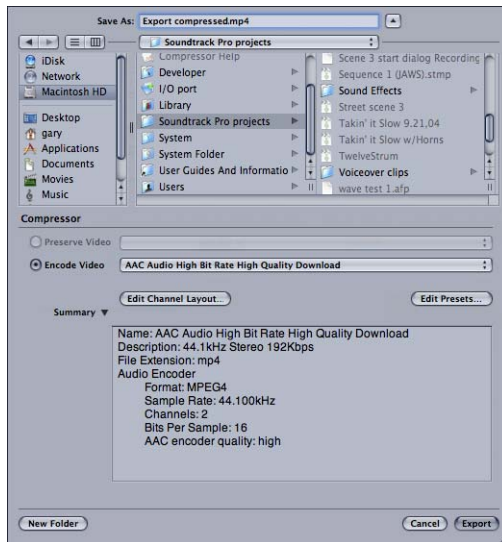

- 2 Type a name for the exported file in the Save As field.
- 3 Browse to the location where you want to save the exported file.

4 Do one of the following:

- To export the video in its original format, select Preserve Video, then choose an export preset from the adjacent preset pop-up menu.
- To export the video in a different format, select Encode Video, then choose an export preset from the adjacent preset pop-up menu.

For information about using Compressor export presets, see “Using Compressor Export Presets” on page 251.

5 Optionally, for multichannel projects, click the Edit Channel Layout button to change the channel layout for the exported file. For information on exporting multichannel projects, see “Exporting Multichannel Projects With Compressor” on page 251.

6 Click Export.

Using Compressor Export Presets

Compressor includes a large number of export presets for a variety of media, including audio, video, and motion graphics. When you export a Soundtrack Pro project using Compressor, you can select an export preset in the Compressor Export Options dialog. Export presets appear in the pop-up menus to the right of the Preserve Video and Encode Video buttons.

For more information on working with Compressor presets, see the Compressor User Manual. The manual is available from the Compressor Help menu, and is included in the Documentation folder installed with Soundtrack Pro.

Exporting Multichannel Projects With Compressor

You can export multichannel projects with up to seven output channels. When you export a multichannel project using Compressor, you can edit the channel layout to assign outputs in the project to physical output channels.

To edit the channel layout:

1 In the Compressor Export Options dialog, click the Edit Channel Layout button.



The Channel Layout dialog appears. The Channel Layout dialog includes pop-up menus for Left, Right, Center, LFE, Left Surround, Right Surround, and Center Surround outputs. You can choose the physical output channel (labeled “Channel 1,” “Channel 2,” and so forth) for each output.

2 Choose the physical output channel for each channel in the exported project.

Distributing a Multitrack Project and its Media Files Together

You can save a multitrack project with all of the media files it uses together in the same folder. Saving the project and its media files together is useful when you want to move the project from one computer to another in order to continue working on it, or to archive the project and media for later use.

To save a project and its audio files together:

- 1 Choose File > Save.
- 2 In the dialog that appears, select the Collect Audio Files checkbox.
- 3 Navigate to the folder in which you want to save the project and its audio files, then click Save.

The project file, and a copy of every audio file the project uses, are saved in the selected location.

- 4 You can optionally create a new folder for the collected project. To create a new folder for the project, click the triangle next to the Where pop-up menu to expand the Save window, then click New Folder. It's a good idea to save each collected project in its own folder.
- 5 If the project includes a video, you can optionally select the Collect Video File checkbox to save the video in the selected folder.

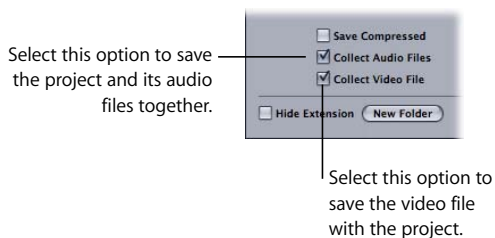

If the folder already contains any of the media files, an alert appears, asking if you want to replace the existing files.

Note: Because video files are typically very large files, saving a copy of the video file may take several minutes, and may require a large amount of disk space.

For information on making roundtrips between Final Cut Pro and Soundtrack Pro, see Chapter 14, “Using Soundtrack Pro With Apple Professional Applications,” on page 253.

You can work with media files from Final Cut Pro, Motion, DVD Studio Pro, and other applications in Soundtrack Pro projects.

Soundtrack Pro gives you several ways to work with media files from Final Cut Pro, Motion, DVD Studio Pro, and other Apple professional applications. You can edit individual audio files (including QuickTime movies) in the Waveform Editor, and you can open a group of clips or a sequence as a multitrack project.

Using Soundtrack Pro With Final Cut Pro

You can edit a Final Cut Pro clip nondestructively in the Waveform Editor by sending the clip from Final Cut Pro to the Waveform Editor as an audio file project. Sending a clip to the Waveform Editor as an audio file project lets you edit the clip nondestructively, then update the clip with your changes in Final Cut Pro without reimporting the clip.

You can edit a Final Cut Pro clip destructively in the Waveform Editor by opening a clip in the Waveform Editor, making your changes, and saving the clip as an audio file, or by sending the clip to a Soundtrack Pro script (either a script included with Soundtrack Pro or one you create). You can also send a select a group of clips or a sequence in Final Cut Pro and send them to Soundtrack Pro as a multitrack project.

Editing a Final Cut Pro Clip Nondestructively in the Waveform Editor

You edit a Final Cut Pro clip nondestructively by sending it to the Waveform Editor as an audio file project. Sending a clip to the Waveform Editor as an audio file project lets you make roundtrips between Final Cut Pro and Soundtrack Pro. When you save your changes in the Waveform Editor, the clip is updated in Final Cut Pro without having to be reimported.

In order to edit a Final Cut Pro clip nondestructively in the Waveform Editor, you send the clip to the Waveform Editor as a new audio file project, edit the clip in the Waveform Editor, then save the audio file project. After following these steps, you can make roundtrips between Final Cut Pro and Soundtrack Pro so you can keep working in both applications.

When you send a clip from the Final Cut Pro Timeline to the Waveform Editor, Soundtrack Pro creates a new audio file project (with the file type .stap) for the clip. The clip can contain video and audio or contain only audio.

To edit a Final Cut Pro clip nondestructively in the Waveform Editor:

- 1 In the Final Cut Pro Timeline, Control-click the clip, then choose “Send To > Soundtrack Pro Audio File Project” from the shortcut menu.

A new audio file project is created for the clip, and a Save As dialog appears.

- 2 In the Save As dialog, type a name for the new project, and browse to a location to save the project.

The new audio file project opens in the Soundtrack Pro Waveform Editor. If the clip includes video, the video appears in the Video tab. You can control playback of the video using the video transport controls in the Video tab or at the bottom of the Project window.

- 3 Edit the audio file project in the Waveform Editor.

You can use the commands and functions described in Chapter 7, “Working in the Waveform Editor,” on page 143. You can graphically edit the file, apply actions, analyze the file, and fix analyzed problems.

- 4 When you are finished editing the clip in the Waveform Editor, choose File > Save.

When you save an audio file project sent from Final Cut Pro, a render file is included in the project, which Final Cut Pro uses to update the clip in the Timeline. By default, saving a project sent from Final Cut Pro includes the render file. If you save the project using the Save As command, be sure to leave the Render checkbox selected each time you save the project, so the clip will be updated in the Final Cut Pro project. If you deselect the Render checkbox, you will not be able to reconnect the audio file project with the clip, and your changes will be lost.

For any audio file project, regardless of whether it originated in Final Cut Pro or another application, you can select the Render checkbox when you save the project to save a render file with the project.

When you have followed the steps described above, the clip is updated in Final Cut Pro. You hear the clip with the changes you made in the Waveform Editor without having to reimport the clip. You can make roundtrips between Final Cut Pro and Soundtrack Pro by Control-clicking the clip in Final Cut Pro and choosing Open in Editor from the shortcut menu, editing the audio file project in Soundtrack Pro, then saving the project. Each time you save the project, the clip is updated in Final Cut Pro.

Editing a Final Cut Pro Clip Destructively in the Waveform Editor

You can edit a Final Cut Pro clip destructively by opening it in the Waveform Editor. When you edit a clip destructively, you hear the clip with the changes you made in the Waveform Editor, without having to reimport the clip. You can save the clip as an audio file project in the Waveform Editor, so you can reopen it later and continue editing.

To edit a clip destructively in the Waveform Editor:

- 1 Control-click the clip in the Final Cut Pro Timeline or Bin, then choose Open in Editor from the shortcut menu.

Soundtrack Pro opens and the clip appears in the Waveform Editor.

- 2 Edit the clip in the Waveform Editor.

You can edit the audio file project in the Waveform Editor using the commands and functions described in Chapter 7, “Working in the Waveform Editor,” on page 143. You can apply actions or analyze the file and fix analyzed problems.

- 3 When you are finished editing the clip, choose File > Save.
- 4 Click Save.

You can also save the clip by choosing File > Save As. If you save the clip using the Save As command, be sure the name, location, and file type in the Save As dialog are the same as for the clip’s source file.

You can also save the clip as an audio file project. If you save the clip as an audio file project, you can reopen the project in the Waveform Editor and make further changes. To use the updated clip in Final Cut Pro you must save it as an audio file and import the audio file, replacing the existing clip.

Editing a Clip Using a Soundtrack Pro Script

You can edit a Final Cut Pro clip destructively using a Soundtrack Pro script while working in Final Cut Pro. When you send a clip to a Soundtrack Pro script, the clip opens in the Waveform Editor, the actions in the script are performed, the clip is saved with the changes, and the Waveform Editor moves to the background so you can continue working in Final Cut Pro.

To edit a clip using a Soundtrack Pro script:

- Control-click the clip in the Final Cut Pro Timeline or Bin, choose Send To > Soundtrack Pro Script from the shortcut menu, then choose the script you want to use from the submenu.

Soundtrack Pro opens and the clip appears in the Waveform Editor. The actions in the script are performed and the clip is saved with the changes. The Soundtrack Pro window moves to the background, and the Final Cut Pro windows return to the foreground.

You can select multiple clips in Final Cut Pro to edit using a script. When you send multiple clips to a Soundtrack Pro script, each clip is opened, edited, saved, and closed in sequence.

You can also repeat the last script you used to edit a clip, making it easy to edit several clips with the same set of actions.

To edit a clip using the last script:

- Control-click the clip in the Final Cut Pro Timeline or Bin, then choose Send To > Last Soundtrack Pro Script from the shortcut menu.

For information about creating and saving AppleScripts in the Waveform Editor, see “Scripting Actions in the Waveform Editor” on page 181.

Creating a Multitrack Project From Final Cut Pro Clips or Sequences

You can create a Soundtrack Pro multitrack project from a group of Final Cut Pro clips or a sequence. When you send a group of clips or a sequence to a Soundtrack Pro multitrack project, the clips open in the Soundtrack Pro Timeline. You can arrange and edit the clips in the Timeline and mix them in the Mixer, then export the multitrack project.

To create a multitrack project from a group of clips or a sequence:

- 1 Do one of the following:
 - Select the clips in the Final Cut Pro Timeline, Control-click one of the clips, then choose Send To > Soundtrack Pro Multitrack Project from the shortcut menu.
 - Control-click a sequence in the Bin, then choose Send To > Soundtrack Pro Multitrack Project from the shortcut menu.

A new multitrack project is created for the clips or sequence, and a Save As dialog appears. If you selected a group of clips, a sequence for the selected clips is created in Final Cut Pro.

- 2 In the Save As dialog, type a name for the multitrack project, and browse to a location to save the project.
- 3 If you want to open the project in the Soundtrack Pro Timeline, select the Open in Multitrack Editor checkbox.
- 4 If you want to include the video from the region of the Final Cut Pro Timeline where you selected the clips, select the Include Background Video checkbox.
- 5 Click Save.

If you selected the Open in Multitrack Editor checkbox, the new multitrack project containing the clips opens in the Soundtrack Pro Timeline. If you selected the Include Background Video checkbox, the video appears in the Video tab, and a video clip appears in the video track.

You can arrange and edit the clips in the Timeline and mix the project in the Mixer. For information about working in the Timeline, see Chapter 5, “Working in the Timeline,” on page 93. For information about working in the Mixer, see Chapter 6, “Working in the Mixer,” on page 123.

- 6 When you are finished working on the project, choose File > Save to save your changes.

When you have followed the steps described above, you can export a project mix of the multitrack project and replace the group of clips or sequence with the exported project mix in Final Cut Pro.

Note: When you send Final Cut Pro clips to the Timeline, the clips’ volume level and any keyframes or crossfades are sent with the clip. For mono clips, the pan position is also sent. Clip-based Final Cut Pro effects such as filters and speed-changing envelopes, and Final Cut Pro generators are not included in the Soundtrack Pro multitrack project.

To update a Soundtrack Pro multitrack project sent from Final Cut Pro:

- 1 In Soundtrack Pro, choose Export > Export Mix.
- 2 Import the exported project mix into the Final Cut Pro Timeline, replacing the original clips or sequence.
- 3 When you want to work on the project in Soundtrack Pro again, Control-click the clip of the exported mix, then choose Open in Editor from the shortcut menu.
A dialog appears asking if you want to open the audio file or the original project.
- 4 In the dialog, click Open Project.

The multitrack project opens in the Soundtrack Pro Timeline so you can continue working. When you are finished working in Soundtrack Pro, be sure to save the multitrack project before exporting a project mix so your changes are retained.

By following the steps described in this procedure, you can make multiple roundtrips between Soundtrack Pro and Final Cut Pro.

Using Soundtrack Pro With Motion

You can edit a Motion audio track nondestructively by sending it to the Waveform Editor as an audio file project. Sending an audio track to the Waveform Editor as an audio file project lets you make roundtrips between Motion and Soundtrack Pro. When you save your changes in the Waveform Editor, the clip is updated in Motion without having to be reimported.

In order to edit a Motion audio track nondestructively in the Waveform Editor, you send the clip to the Waveform Editor as a new audio file project, edit the clip in the Waveform Editor, then save the audio file project. After following these steps, you can make roundtrips between Motion and Soundtrack Pro so you can keep working in both applications.

When you send an audio track from Motion to the Waveform Editor, a new audio file project (with the file type .stap) is created for the track.

To send an audio track from Motion to the Waveform Editor:

- 1 In the Motion Audio tab or Timeline Layer list, select the audio track.
- 2 Choose Edit > Send Audio to Soundtrack.

A new audio file project is created for the audio track, and a Save As dialog appears.

- 3 In the Save As dialog, type a name for the new project, and browse to a location to save the project.

A new audio file project containing the audio track opens in the Soundtrack Pro Waveform Editor.

- 4 Edit the audio file project in the Waveform Editor.

You can use the commands and functions described in Chapter 7, “Working in the Waveform Editor,” on page 143. You can graphically edit the file, apply actions, analyze the file, and fix analyzed problems.

When you are finished editing the audio file project of the audio track, you save the project in Soundtrack Pro.

- 5 In Soundtrack Pro, choose File > Save.

When you save an audio file project sent from Motion, a render file is included in the project, which Motion uses to update the audio track. If you save the project using the Save As command, be sure to leave the Render checkbox selected each time you save the project, so the clip will be updated in the Motion project. If you deselect the Render checkbox, you will not be able to reconnect the audio file project with the audio track, and your changes will be lost.

When you have followed the steps described above, the clip is updated in Motion. You hear the clip with the changes you made in the Waveform Editor, without having to reimport the clip. You can make roundtrips between Motion and Soundtrack Pro by opening the saved audio file project, making changes, then saving the project. Each time you save the project, the clip is updated in Motion.

Using Soundtrack Pro With DVD Studio Pro

You can edit a DVD Studio Pro clip destructively by opening it in the Waveform Editor. When you edit a clip destructively, you hear the clip with the changes you made in the Waveform Editor without having to reimport the clip. You can save the clip as an audio file project in the Waveform Editor, so you can reopen it later and continue editing.

To edit a clip destructively in the Waveform Editor:

- 1 In DVD Studio Pro, Control-click the clip, then choose Open in Editor from the shortcut menu.

Soundtrack Pro opens and the clip appears in the Waveform Editor.

- 2 Edit the clip in the Waveform Editor.

You can edit the audio file project in the Waveform Editor using the commands and functions described in Chapter 7, “Working in the Waveform Editor,” on page 143. You can apply actions or analyze the file and fix analyzed problems.

- 3 When you are finished editing the clip, choose File > Save.

- 4 Click Save.

You can also save the clip by choosing File > Save As. If you save the clip using the Save As command, be sure the name, location, and file type in the Save As dialog are the same as for the clip’s source file.

You can also save the clip as an audio file project. If you save an audio file project as an AIFF file or a QuickTime movie, a link is included in the AIFF file or movie, letting you reopen the project in Soundtrack Pro and make changes to action settings and other edits.

Using Soundtrack Pro With Other Applications

You can open an audio file exported from Soundtrack Pro (a project mix, an exported track, bus, or output, or an audio file project saved as an AIFF file or a QuickTime movie) in any application that supports audio files.

When you save an audio file project using the Save As command, be sure the Render checkbox is selected in the Save As dialog.

If you save an audio file project as an AIFF file or a QuickTime movie, a link is included in the AIFF or movie, letting you reopen the project in Soundtrack Pro and make changes to action settings and other edits.

When you reopen the AIFF or QuickTime movie in Soundtrack Pro, a dialog appears, asking if you want to open the audio file or the original project. In the dialog, click Open Project. The audio file project opens in the Soundtrack Pro Waveform Editor so you can continue working. When you are finished working in Soundtrack Pro, be sure to save the audio file project before saving it as an AIFF or QuickTime movie so your changes are retained.

If you export a saved multitrack project using Export > Export Mix, a link is included in the exported file, letting you reopen the multitrack project in Soundtrack Pro and make changes. The project must have been previously saved at least once before you export the project mix.

When you reopen the exported file, a dialog appears, asking if you want to open the audio file or the original project. In the dialog, click Open Project.

The multitrack project opens in the Soundtrack Pro Timeline so you can continue working. When you are finished working in Soundtrack Pro, be sure to save the multitrack project before exporting a project mix so your changes are retained.

Some audio files you use in Soundtrack Pro can include metadata called *tags*. Tags provide information about the audio recorded in a file. Soundtrack Pro uses tags in one of two ways:

- To help locate files using the Search feature in Soundtrack Pro
- To provide information that Soundtrack Pro uses when matching the file's tempo and key to the project tempo and key, for the best possible playback quality

Both AIFF and WAV file formats can include tags. Libraries of audio files created for use with loop-based music software are usually tagged, and Soundtrack Pro recognizes the tags used in most popular file formats.

What Is Apple Loops Utility?

Apple Loops Utility is a companion application to Soundtrack Pro that you can use to view and manage tags in audio files. You can add and change tags using Apple Loops Utility; you can also tag multiple files, a process known as *batch tagging*.

Apple Loops Utility can read both AIFF and WAV file formats. When you save changes you make to either type of file, the file is saved as an AIFF file, the default file format for Soundtrack Pro. The set of tags you can work with using Apple Loops Utility includes all of the tags in WAV files tagged for use with Sony's ACID music application, as well as additional tags.

Tagged audio files can also contain information about *transients*. Transients indicate where beats occur in the file, and Soundtrack Pro uses transients to play back audio files at the highest level of quality. Apple Loops Utility can detect transients present in an audio file, and you can use Apple Loops Utility to add markers for additional transients and move them to new locations.

The Apple Loops Utility Interface

The Apple Loops Utility interface consists of a window with two tabs: the Tags tab and the Transients tab. The bottom of the window includes a set of playback controls and file management buttons. Apple Loops Utility also includes an Assets drawer, located to the right of the main window, where you manage open files.

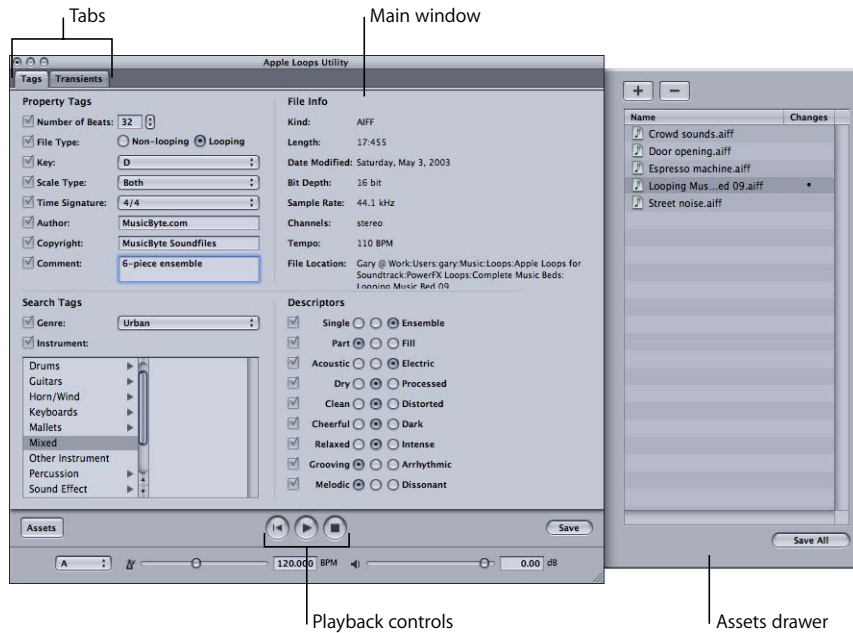

Tags Tab

The Tags tab includes areas for different types of tags, and also includes a set of playback controls you can use to listen to a file open in Apple Loops Utility. Listening to a file can help you decide which tags are appropriate for the file.

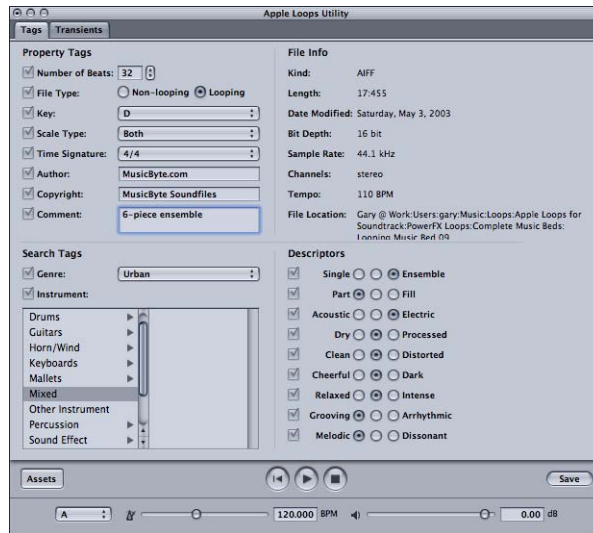

Property Tags

- *Number of Beats field:* Displays the number of beats in the file.
- *File Type buttons:* Set the file type, which can be Non-looping or Looping.
- *Key pop-up menu:* Sets the key of the file.
- *Scale Type pop-up menu:* Sets the file's scale type. The choices are Major, Minor, Good for Both, and Neither.
- *Time Signature pop-up menu:* Sets the file's time signature. The choices are 4/4, 3/4, 5/4, 6/8, and 7/8.
- *Author field:* Displays the name of the file's author. You can enter a new name by typing in the field.
- *Copyright field:* Displays the file's copyright data, if it exists. You can enter new data by typing in the field.
- *Comment field:* Displays any comments about the file. You can enter comments by typing in the field.

Search Tags

These tags are used by the Search feature in Soundtrack Pro when you search for files matching specific criteria.

- *Genre pop-up menu*: Displays choices for the musical genre of the file.
- *Instrumentation list*: Displays choices for the musical instrument or instrument category recorded in the file. Selecting an instrument category in the left column displays the list of instruments in that category in the right column.

File Info

This area of the Tags tab includes rows with Kind, Length, Date Modified, Sample Rate, Channels, Tempo, and File Location information. This information is for viewing only, and cannot be edited in the Tags tab.

Descriptors

Descriptors are complementary pairs of keywords describing the mood or character of the music recorded in the file. Each pair of keywords has a row of buttons, allowing you to choose either one keyword from the pair, or neither keyword.

Transients Tab

The Transients tab contains a large waveform display, with a Beat ruler and a horizontal scroll bar. Markers indicate the position of transients in the file. Typically, transients correspond to the peaks or most pronounced amplitude changes in a sound's waveform. The Transients tab includes controls for the beat division and sensitivity with which Apple Loops Utility detects transients in the file. You can also listen to the file using the playback controls to help determine where transients occur.

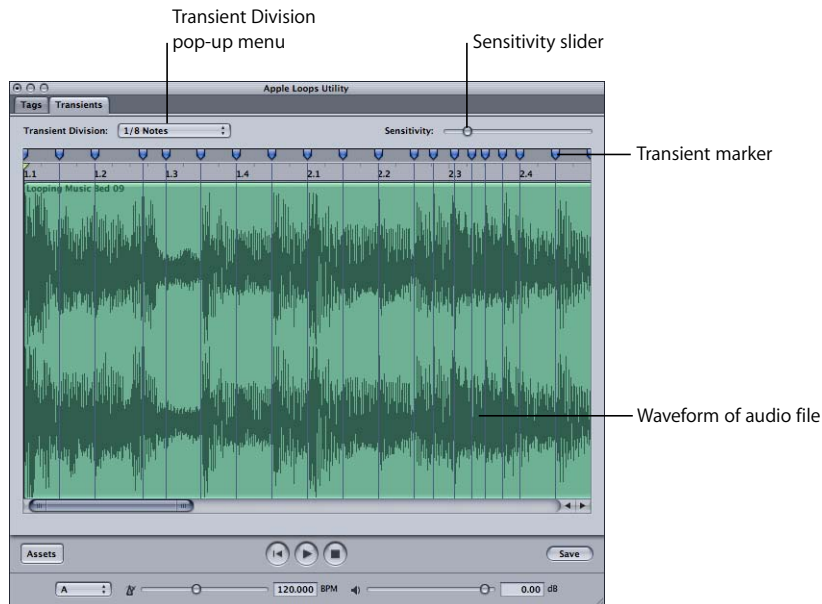

The Transients tab includes the following controls:

- *Transient Division pop-up menu*: Sets the beat value at which Apple Loops Utility detects transients.
- *Sensitivity slider*: Sets the degree of sensitivity at which Apple Loops Utility detects transients.

Assets Drawer

The Assets drawer lists the files open in Apple Loops Utility. The drawer, which is open when you open Apple Loops Utility, contains a Name column with the name of each open file, and a Changes column, which indicates any files to which you have applied changes.

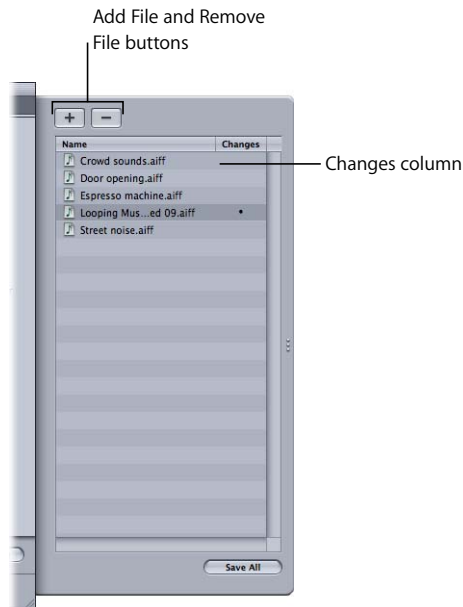

Playback and File Management Controls

The bottom of the Apple Loops Utility window contains a set of playback controls so that you can listen to the file in Apple Loops Utility. The playback controls do not affect the file's tags, only the playback of the selected file.

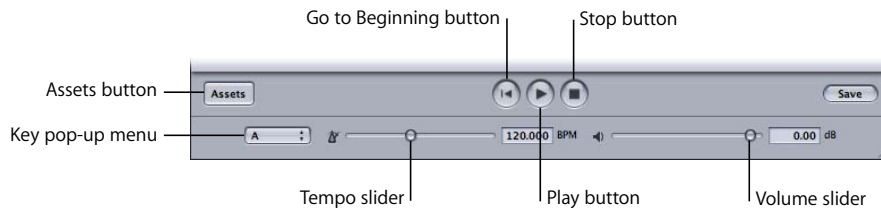

- *Go to Beginning button*: Starts playback from the beginning of the selected file.
- *Play button*: Plays back the selected file.
- *Stop button*: Stops playback of the selected file.
- *Key pop-up menu*: Transposes the selected file to a new key for playback.
- *Tempo slider*: Sets the playback tempo of the selected file. You can also enter a value in the field.
- *Volume slider*: Sets the playback volume of the selected file. You can also enter a value in the field.

When multiple files are selected, the playback controls are not available. You cannot play more than one file at a time.

There are two additional buttons at the bottom of the window, the Assets button and the Save button.

- *Assets button*: Shows and hides the Assets drawer.
- *Save button*: Saves your changes to the currently selected files in the Assets drawer.

Opening Files in Apple Loops Utility

You can open audio files from within Apple Loops Utility, or directly from a Soundtrack Pro project. You can have up to 2000 files open at the same time. When you open files in Apple Loops Utility, the files are displayed in the File list of the Assets drawer.

To open an audio file in Apple Loops Utility, do one of the following:

- Choose File > Open, then select the file in the Open dialog.
- Choose File > Open Recent, then choose a file from the submenu.
- Click the Add File button in the Assets drawer.
- Drag files from the Finder to the Assets drawer.

To open an audio file from Soundtrack Pro into Apple Loops Utility:

- Control-click the file in Soundtrack Pro, then choose Open in Apple Loops Utility from the shortcut menu.

To open multiple files in Apple Loops Utility, do one of the following:

- Choose File > Open, then Shift-click the files in the Open dialog.
- Drag the volume or folder containing the files from the Finder to the Assets drawer.

You can have multiple Apple Loops Utility windows open at the same time so that you can compare different files. Each time you open an Apple Loops Utility window, an Open dialog appears, letting you choose the file or files to open in that window. You can change the open window behavior in the Apple Loops Utility Preferences window. See “Apple Loops Utility Preferences” on page 274 for more information.

Tagging Files in Apple Loops Utility

To tag files, you select the files in the Assets drawer, and then make changes to the selected files' tags in the Tags tab. When you change the settings in the Tags tab, the changes are applied only to the currently selected files.

When you make changes to a file's tags, a dot appears in the Changes column next to the filename to indicate that the file has been changed. You can select a file or group of files and make one or several changes, and then select another file or group of files and make different changes. Apple Loops Utility remembers all the changes you make as you work with different files. When you finish making changes, you can save changes to only the currently selected files, or save changes to all files marked in the Changes column of the Assets drawer.

Note: Changing a file's tags has no effect on the actual audio data recorded in the file. Changing the tag for the number of beats, for example, only changes the information used when Soundtrack Pro searches for files, not the actual number of beats recorded in the audio file. Similarly, changing the tag for key has no effect on the actual musical key of the audio file.

To tag a single audio file:

- 1 Select the file in the Assets drawer. (If the drawer is closed, click the Assets button to open it.)

Note: When a single file is selected, you can use the Up and Down Arrow keys to move up and down the files in the Assets drawer. You can listen to the file using the playback controls.

- 2 Make the changes you want to the file's tags in the Tags tab.
See "Tags Tab" on page 265 for information about the options in the Tags tab.
- 3 Click Save to save changes to the selected file, or click Save All to save all changes.

Tagging Multiple Files

When multiple files are selected, only the tags that apply to all the selected files can be changed. Items in the Tags tab that do not apply to all the currently selected files are dimmed and unavailable.

Each tag has a checkbox. Select the checkbox next to the tags for which you want to save changes.

To tag multiple files:

- 1 Select the files in one of the following ways:
 - Shift-click to select adjacent files in the Assets drawer.
 - Command-click to select nonadjacent files in the Assets drawer.
 - Press Command-Shift-A to select all files in the Assets drawer.
- 2 Make the changes you want to the available tags for the selected files in the Tags tab. See “Tags Tab” on page 265 for information about the options in the Tags tab.
- 3 Select the checkboxes next to the tags for which you want to save changes.
- 4 Click Save to save changes to the selected files, or click Save All to save all changes.

There are many keyboard shortcuts to simplify the task of tagging files. For a complete list of keyboard shortcuts, see “Apple Loops Utility Keyboard Shortcuts” on page 275.

Working With Transients

Transients are the points in an audio file where beats occur. Typically, transients occur at the widest areas of a waveform in the waveform display. During playback, Soundtrack Pro adjusts looping files using a technique called *stretching* to achieve the best audio quality, based on the loop’s transients. Non-looping files are not affected by stretching.

When you open a file in Apple Loops Utility, it looks for transients at every 16th note position, based on the file’s tags for tempo and the number of beats. You can change the beat value at which Apple Loops Utility detects transients using the Transient Division pop-up menu.

To display a file in the Transients tab:

- Select the file in the Assets drawer, then click the Transients tab.

The Transients window can display only one file. If multiple files are selected, no waveform is displayed in the window. The waveform display in the Transients tab displays both the transients detected by Apple Loops Utility and transients you add to the file. You can add transients and move existing transients in the Transients tab.

To add a new transient:

- Click in the darker area above the Beat ruler in the waveform display.

To move a transient marker:

- Drag the marker by its handle in the area above the Beat ruler.

To change the beat value of detected transients:

- Choose a beat value from the Transient Division pop-up menu.

Choosing a larger beat value results in fewer transients being detected. Choosing a smaller beat value results in more transients being detected, if they are present in the audio recorded in the file.

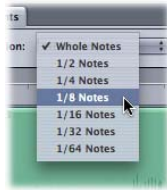

Sometimes transients occur at points in the audio file other than on a beat value. You can have Apple Loops Utility detect additional transients in the file using the Sensitivity slider. When you increase the sensitivity of transient detection, Apple Loops Utility considers points of higher amplitude in the waveform as transients, regardless of whether or not they occur at a beat value.

To change the sensitivity of transient detection:

- Drag the Sensitivity slider to the left to decrease the sensitivity, or to the right to increase the sensitivity of transient detection.

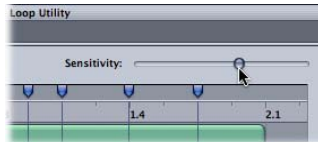

To remove a transient, do one of the following:

- Click the transient's handle in the area above the Beat ruler, then press the Delete key.
- Drag the transient out of the area above the Beat ruler.

Saving Changes to Files

When you save changes in Apple Loops Utility, you can save changes to only the currently selected files, or to all files marked in the Changes column of the Assets drawer. Any other file tags are unchanged. This is especially useful when working with a large group of files.

When saving multiple files, the checkbox next to the tag must be selected if changes to that tag are to be saved. For information about tagging multiple files, see “Tagging Files in Apple Loops Utility” on page 270.

To save changes to the currently selected files:

- Click the Save button.

Saving changes to a large number of files may take several minutes.

To save all changes:

- Click the Save All button in the Assets drawer.

To save multiple files to the same directory:

- 1 Choose File > Save As.
- 2 Navigate to the directory where you want to save the files, then click Save.

When you save multiple files using the Save As dialog, the files are saved to the selected directory, and their names are unchanged.

When you save changes to files in the WAV format, by default they are converted to the AIFF format and saved in the same location as the original WAV files. The new AIFF files have the same name as the WAV files, but with the .aiff file suffix. You can change this default behavior in the Apple Loops Utility Preferences window. See the following section, “Apple Loops Utility Preferences,” for more information.

Removing Files From the Assets Drawer

You can remove files from the Assets drawer.

To remove files:

- Select the file or files in the Assets drawer, then click the Remove File button at the top of the drawer (or press the Delete key).

If you remove files to which you have applied changes, a dialog appears letting you choose whether to save or discard your changes.

Apple Loops Utility Preferences

You can set preferences for the startup behavior and default file saving behavior in the Apple Loops Utility Preferences window.

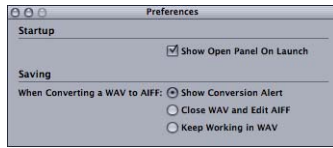

Startup



















- *Show Open Panel On Launch*: When selected, an Open dialog appears each time you open Apple Loops Utility.

Saving

- When Converting a WAV to AIFF:
 - *Show Conversion Alert*: Shows the conversion alert dialog when you try to save a WAV file.
 - *Close WAV and Edit AIFF*: Automatically converts the WAV to an AIFF, closes the WAV file, and opens the AIFF for editing.
 - *Keep Working in WAV*: Leaves the WAV file open.

Apple Loops Utility Keyboard Shortcuts

























General and File

Key command	Function
  + <i>N</i>	Creates a new, blank Apple Loops Utility window and opens the Open dialog.
  + <i>O</i>	Opens the Open dialog, from which you open files in Apple Loops Utility.
  + <i>W</i>	Closes the current window.
  + <i>shift</i> + <i>W</i>	Closes the selected files.
  + <i>S</i>	Saves changes to the currently selected files. If any of the files are WAV files, a dialog appears asking if you want to continue editing the files as WAV files or save them as AIFF files.
  + <i>shift</i> + <i>S</i>	Opens the Save As dialog to save the currently selected file with a new name.
  + <i>option</i> + <i>S</i>	Saves all open files.
	Selects the file above the current file in the Assets drawer.
	Selects the file below the current file in the Assets drawer.
  + <i>shift</i> + <i>A</i>	Selects all files in the Assets drawer.

Navigation

Key command	Function
<i>F1</i>	Makes the Tags tab active.
<i>F2</i>	Makes the Transients tab active.
<i>F3</i>	Makes the Assets drawer active.

Key and Scale Type Tagging













Key command	Function
	Turns on keyboard tagging.
	Sets the key to A.
 + 	Sets the key to A# (A-sharp).
	Sets the key to B.
	Sets the key to C.
 + 	Sets the key to C# (C-sharp).
	Sets the key to D.
 + 	Sets the key to D# (D-sharp).
	Sets the key to E.
	Sets the key to F.
 + 	Sets the key to F# (F-sharp).
	Sets the key to G.
 + 	Sets the key to G# (G-sharp).
	Sets the scale type to Major.
 + 	Sets the scale type to Minor.
 + 	Sets the scale type to Both.
	Sets the scale type to Neither.

Descriptor Tagging

For the following descriptor keyboard shortcuts, pressing the key once selects the first (left) item, pressing the key again selects the second (right) item, and pressing the key a third time selects Neither (the center button).

Key command	Function
1	Single/Ensemble
2	Part/Fill
3	Acoustic/Electric
4	Dry/Processed
5	Clean/Distorted
6	Cheerful/Dark
7	Relaxed/Intense
8	Grooving/Arrhythmic
9	Melodic/Dissonant
F5	Sets Batch Tagging to All.
F6	Sets Batch Tagging to None.



















Transients

Key command	Function
	Increases sensitivity.
	Decreases sensitivity.
 + 	Increases sensitivity five times.
 + 	Decreases sensitivity five times.
	Nudges the selected marker by one pixel to the left.
	Nudges the selected marker by one pixel to the right.
 + 	Selects the previous marker.
 + 	Selects the next marker.







Soundtrack Pro Keyboard Shortcuts



















B

General and File







Key command	Function
  + <i>N</i>	Creates a new, blank multitrack project.
  + <i>shift</i> + <i>N</i>	Creates a new audio file.
  + <i>O</i>	Opens the Open dialog.
  + <i>shift</i> + <i>W</i>	Closes all open projects.
  + <i>S</i>	Saves the current project.
  + <i>shift</i> + <i>S</i>	Opens the Save As dialog to save the project with a new name.
  + <i>control</i> + <i>S</i>	Opens the Save As dialog to save a copy of the project with a different name.
  + <i>B</i>	Adds the selected audio file to the Bin.
  + <i>Q</i>	Closes all projects and quits Soundtrack Pro.

Windows, Tabs, and Layouts



















Key command	Function
  + <i>1</i>	Opens the Mixer for the current multitrack project.
  + <i>2</i>	Opens the Video tab of the Utility window.
  + <i>3</i>	Opens the Project window.

Key command	Function
  + 4	Opens the Browser tab of the Media and Effects Manager.
  + 5	Opens the Effects tab of the Media and Effects Manager.
  + M	Minimizes Soundtrack Pro.
  + H	Hides Soundtrack Pro.
  + <i>option</i> + H	Hides all other windows.
  + .	Shows the Preferences window.
  + <i>shift</i> + ?	Opens the Soundtrack Pro User Manual.
  + <i>option</i> + J	Moves to the previous (left) tab.
  + <i>shift</i> + <i>option</i> + J	Moves to the next (right) tab.
F1	Switches the project layout to the Basic layout.







Project Playback and Setting the Playhead



Key command	Function
<i>space</i>	Starts playing the project.
<i>space</i>	If the project is playing, stops project playback.
<i>return</i>	Moves the playhead to the beginning of the project, or to the beginning of the playback region if it is active.
<i>shift</i> + <i>return</i>	Starts playback from the beginning of the project.
<i>option</i> + M	Moves the playhead to the position of the preceding marker.
<i>shift</i> + M	Moves the playhead to the position of the next marker.
  + 	Moves the playhead to the position of the previous frame in the video clip.
  + 	Moves the playhead to the position of the next frame in the video clip.

General Editing





















Key command	Function
  + Z	Undoes the last command.
  + shift + Z	Redoes the last undone command.
  + X	Cuts the selected item.
  + shift + X	Ripple cuts the selected item.
  + C	Copies the selected item.
  + V	Pastes the cut or copied item.
delete	Ripple deletes the selected item.
  + D	Duplicates the selected item.
  + A	Selects all items in the window.
  + shift + A	Deselects all items in the window.
N	Turns snap on or off.

Editing Audio Clips in the Timeline

















Key command	Function
  + shift + V	Opens the Paste Mix dialog so that you can paste audio and mix it with the existing audio.
  + option + V	Opens the Paste Repeat dialog so that you can paste multiple copies of the cut or copied audio clip.
S	Splits the selected audio clips under the playhead.
J	Joins the selected clips.
  + F	Crossfades the selected clips.













Key command	Function
 +  + 	Trims the selected clips.
Double-click an audio clip.	Opens the selected audio clip in the Waveform Editor as a new audio file project.

Adjusting Audio Clips in the Timeline





























Key command	Function
 + 	Nudges the clip or envelope point to the left by one pixel.
 + 	Nudges the clip or envelope point to the right by one pixel.
 + 	Nudges the envelope point up by one pixel.
 + 	Nudges the envelope point down by one pixel.
 +  + 	Shifts the clip or envelope point to the left by one gridline.
 +  + 	Shifts the clip or envelope point to the right by one gridline.
 +  + 	Shifts the envelope point up by five pixels.
 +  + 	Shifts the envelope point down by five pixels.

Navigating in the Timeline















Key command	Function
 OR  +  + 	Zooms in horizontally to the next zoom level.
 OR  +  + 	Zooms out horizontally to the next zoom level.
 +  + 	Zooms in vertically to the next zoom level.
 +  +  + 	Zooms out vertically to the next zoom level.
 + 	Zooms in on the current selection.

Key command	Function
 + 	Returns to the default zoom level.
 + 	Fits the project in the display size.
 + 	Reduced track height
 + 	Small track height
 + 	Medium track height
 + 	Large track height



Editing Audio Files in the Waveform Editor

Key command	Function
 + 	Normalizes the audio file or selection.
 +  + 	Adjusts the amplitude of the audio file or selection.
 + 	Replaces the audio file or selection with complete silence.
 +  + 	Saves the current actions in the Actions list as an AppleScript droplet.
 + 	Flattens audible actions, as indicated by the position of the Action Insert bar.
 +  + 	Flattens all actions in the project.
 + 	Adjusts selection inward to zero crossing.
 + 	Adjusts selection outward to zero crossing.
 + 	Adjusts in point left to zero crossing.
 + 	Adjusts in point right to zero crossing.
 + 	Adjusts out point left to zero crossing.
 +  + 	Adjusts out point right to zero crossing.

Tracks and Markers

Key command	Function
  + 	Adds a new track to the Timeline below the selected track.
  + <i>control</i> + 	Adds a new bus to the Timeline below the selected bus.
  + <i>option</i> + 	Adds a new output to the Timeline below the selected output.
  + <i>shift</i> + 	Removes the selected track, bus, or output from the Timeline.
	Inserts a beat marker at the current playhead position.
	Inserts a time marker at the current playhead position.
<i>control</i> + 	Adds time markers at the beginning and end of selection.

Video Out

Key command	Function
  + 	Play using external video output device.

Recording

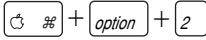
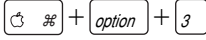
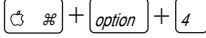
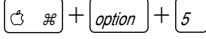
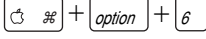
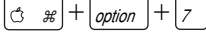
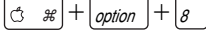
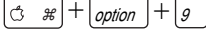
Key command	Function
 $\text{⌘} + \text{⌥} + 1$	Makes Take 1 the active take for the selected clip.
 $\text{⌘} + \text{⌥} + 2$	Makes Take 2 the active take for the selected clip.
 $\text{⌘} + \text{⌥} + 3$	Makes Take 3 the active take for the selected clip.
 $\text{⌘} + \text{⌥} + 4$	Makes Take 4 the active take for the selected clip.
 $\text{⌘} + \text{⌥} + 5$	Makes Take 5 the active take for the selected clip.
 $\text{⌘} + \text{⌥} + 6$	Makes Take 6 the active take for the selected clip.
 $\text{⌘} + \text{⌥} + 7$	Makes Take 7 the active take for the selected clip.
 $\text{⌘} + \text{⌥} + 8$	Makes Take 8 the active take for the selected clip.
 $\text{⌘} + \text{⌥} + 9$	Makes Take 9 the active take for the selected clip.

You can create professional-sounding music projects in Soundtrack Pro without any background or training in music. This chapter describes the basic audio and music concepts you need to know to get started.

Basic Audio Concepts

In order to understand how you can work with audio files and use the controls, effects, and envelopes included in Soundtrack Pro, it's helpful to know some basic terms and concepts about audio.

Sound Waves

What we hear as sounds are vibrations traveling through the air as *sound waves*. Sound waves move through the air like ripples in a pond, radiating outward from the sound's source in a regular pattern of compression and rarefaction.

Frequency and Amplitude

The rate at which a sound wave repeats (the time between two peaks of the wave) is called its *frequency*. Frequency is expressed in cycles per second, or Hertz (Hz). We hear a sound's frequency as being relatively high (like a flute, a child's voice, or a train whistle) or low (like a bass guitar, a man's voice, or the rumble of a train on the tracks). The range of frequencies audible to human beings is roughly 20 Hz–20 kilohertz (kHz).

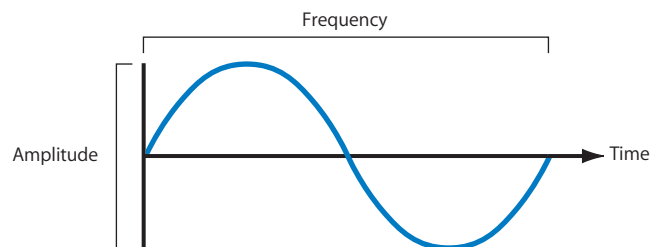

The depth or intensity of a sound is called its *amplitude*, and is expressed in decibels (dB). We hear amplitude as the *volume* or loudness of a sound. The range of audible loudness is roughly 0–130 dB. Higher decibel levels are painful to human hearing.

Musical Sounds

Musical sounds typically have a regular frequency, which we hear as the sound's *pitch*. Pitch is expressed using musical notes, such as C, Eb, and F#. What we hear as the pitch is only the lowest, strongest part of the sound wave, called the *fundamental*. Every musical sound also has higher, softer parts called *overtones* or *harmonics*, which occur at regular multiples of the fundamental frequency. We don't hear the harmonics as distinct pitches, but rather as the tone color (also called the *timbre*) of the sound, which lets us distinguish one instrument or voice from another, even when both are playing the same pitch. When you turn up the treble on your stereo, or adjust an EQ effect, you raise the volume of some of the harmonics in the music, but don't change the fundamental frequencies.

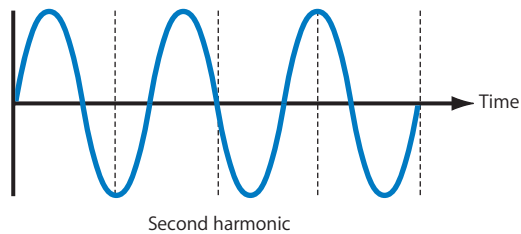
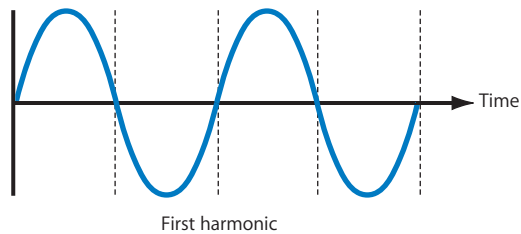
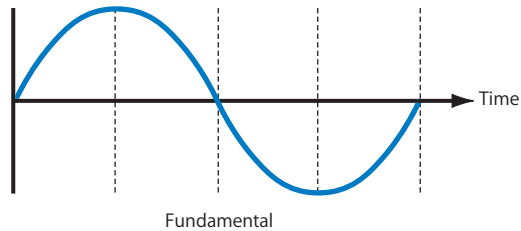

Envelopes

Another aspect of sound that helps us to distinguish between instruments and voices playing the same pitch is a sound's *envelope*. Every note played on a musical instrument has a distinct curve of rising and falling volume over time. Sounds produced by some instruments, particularly drums and other percussion, start at a high volume level but quickly decrease to a much lower level, and die away to silence quickly. Sounds produced by other instruments, for example, a violin or a trumpet, can be sustained at the same volume level, and can be raised or lowered in volume while being sustained. This volume curve is called the sound's envelope, and acts like a signature to help our ears recognize what instrument is producing the sound.

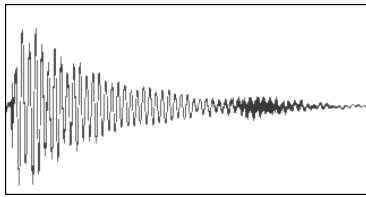

Percussive envelope

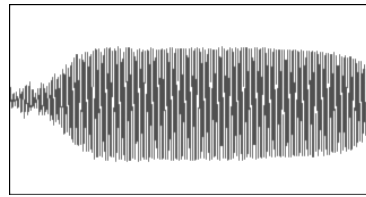

Sustained envelope

Phase Relationships

When two instruments or voices are playing the same pitch, the sound waves may have the exact same frequency and amplitude, but the peaks and troughs of the wave reach our ears, or a microphone recording the sound, at slightly different times. This is referred to as a difference in the *phase* of the sound waves. When two sound waves are completely in phase, the volume of the sound is doubled. When two sound waves are completely out of phase, they cancel each other out and we hear silence. Certain effects, such as phase shifters, make use of these properties of phase relationships to alter the sound of an audio signal.

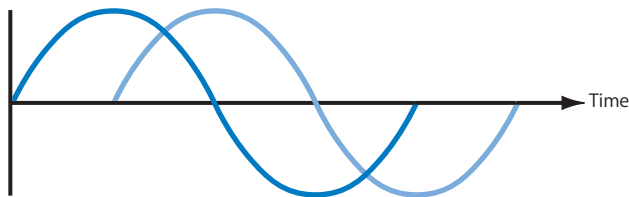

Recording Sound

When a sound is recorded, the sound waves traveling through the air are converted to an electrical signal, using a device called a *transducer*. Sound can be recorded using either *analog* or *digital* recording technology.

Analog Recording

When a sound is recorded using analog technology, the sound waves are recorded as a continuous electrical signal. Typically, the vibrations in the air contact the diaphragm of a microphone, setting the diaphragm in motion. A transducer in the microphone converts the diaphragm's motion into an electric signal. The compressed parts of the sound wave are recorded as positive electrical voltages, and the rarefied parts of the wave are recorded as negative voltages. The voltage of the recorded signal is an *analog* of the wave's frequencies and their relative amplitudes at any point in time.

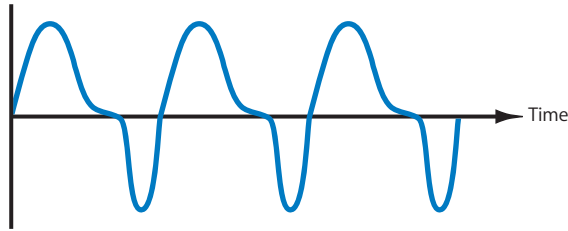

Analog recording technology was originally developed using mechanical means to etch the sound signal directly onto wax cylinders or lacquer disks. Its simplicity, and the rapid development of electronics during the twentieth century, led to its widespread use for recording music and for adding sound to motion pictures.

However, analog audio recording is subject to several problems in achieving high-fidelity reproduction of sound. These include noise, distortion, and loss of quality each time the audio signal is copied or reproduced.

Digital Recording

When a sound is digitally recorded, the sound waves are recorded as a series of *samples* onto a hard disk or other digital storage medium. A sample stores the voltages corresponding to the wave's frequencies and their relative amplitudes as a series of binary numbers, or bits. Each sample is like a snapshot of the sound at a particular instant in time.

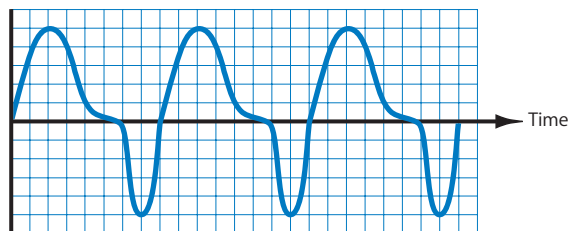

Digital recording technology offers several advantages over analog technology for recording sound, including lower noise, wider frequency response, and less distortion (if the sound is recorded at the proper level). In addition, digital recordings can be reproduced any number of times without any loss of audio quality. These advantages, combined with the popularity of personal computers, have led to the rapid development of digital audio as a leading technology for music production.

Sample Rate and Bit Depth

The audio quality of any digital recording depends on two factors: the sample rate and the bit depth used to record the signal. The *sample rate* is the number of samples recorded per second. The *bit depth* is the number of digital bits each sample contains. Together, these two factors determine the amount of information contained in a digital audio recording. The higher the sample rate and bit depth of a recording, the more accurately the recording reproduces the original sound.

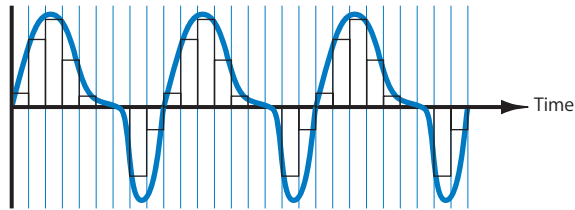

Low sample rate

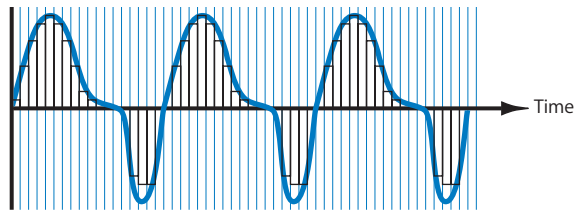

High sample rate

Recording music digitally requires a very high sample rate and bit depth to reproduce the nuances in the music satisfactorily. The Nyquist theorem states that sounds must be recorded at no less than double the rate of the highest frequency being sampled to accurately reproduce the original sound. Audio CDs are recorded at a sample rate of 44.1 kHz and a bit depth of 16 bits (some CDs use a higher 20- or 24-bit depth). Audio for DVDs is often recorded using a slightly higher sample rate of 48 kHz. Soundtrack Pro lets you record and play back digital audio files at sample rates of up to 96 kHz, and at bit depths of up to 24 bits.

Digital Distortion

To record sound with the widest possible dynamic range, the input level must be set high enough to capture the complete audio signal. When the input level of the signal is set too high, however, the signal exceeds the maximum level that can be sampled or reproduced accurately, resulting in *digital distortion*. Digital distortion is defined for most digital audio applications, including Soundtrack Pro, as any time the signal rises above 0 dB. Even a single sample above 0 dB can produce noticeable distortion, which you hear as a sharp crackling sound in the audio output. Digital distortion is nearly always undesirable, and Soundtrack Pro includes level meters and other controls so that you can identify and remove distortion from your projects.

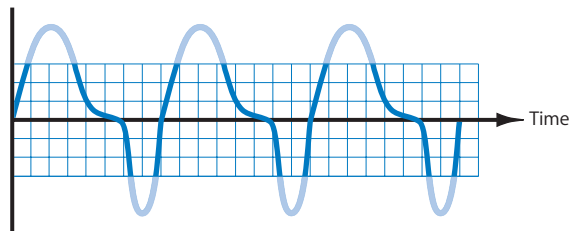

Solutions to Common Problems and Customer Support

D

If you run into problems while working with Soundtrack Pro, there are several resources you can use to find a solution.

- *This appendix*: This appendix includes information about some of the most frequent issues users encounter.
- *Late-Breaking News*: A late-breaking news page in the Soundtrack Pro Help menu provides last-minute information that didn't make it into the manual. Be sure to consult this help page as soon as you install or upgrade Soundtrack Pro.
- *AppleCare Knowledge Base*: AppleCare Support maintains a database of common support issues that is updated and expanded to include new issues as they arise. This is an excellent, free resource for Soundtrack Pro users. To access the AppleCare Knowledge Base, go to the AppleCare support page at <http://www.apple.com/support>.
- *AppleCare Support*: There are a variety of support options available to Soundtrack Pro customers. For more information, see the *Apple Professional Software Service & Support Guide* that comes with your Soundtrack Pro documentation.

Solutions to Common Problems

Audio Files and Audio Interfaces

There are several factors that can affect performance when working with digital audio files. Observing the following guidelines will help you maintain the highest possible performance when working with Soundtrack Pro projects:

- Because digital audio files require intensive processing by the computer's processor, do not perform other processor-intensive tasks while working in Soundtrack Pro.
- External audio interfaces connected to your computer can be susceptible to *latency*, a noticeable delay between the time the audio signal is produced and the time it reaches the computer. Some hardware and software manufacturers offer guidelines for reducing the amount of latency for their equipment. Be sure to read the documentation that came with your audio interface.
- If you are using a USB audio interface, make sure the audio interface is directly connected to your computer. Do not connect a USB audio interface through a USB hub, or chain it through another USB device.
- If you experience unwanted noise or hiss, check the connections between your computer and any external audio devices. Refer to the documentation that came with each device for any additional instructions on dealing with noise.

Eliminating Recording Latency

You can use the Latency Compensation setting in the Preferences Recording pane to eliminate any latency inherent in your recording device. You calculate the latency by playing a loop and recording it at the same time, as described below:

- 1 Use an appropriate cable to connect the audio output port you are using to the input port for the device from which you plan to record.
- 2 Choose a loop with a large number of transients, such as a drum loop.
- 3 Set the tempo to 60 bpm (to simplify the latency calculation).
- 4 Click the Record Enable button in the header of the track to which you want to record.
- 5 In the Recording tab, set the Input device to the recording device.
- 6 Set Monitor to None and ensure that hardware monitoring on your recording device is turned off. You may also need to reduce input or output volumes of your devices in order to avoid feedback.
- 7 Click the Record button and let the loop play for a few seconds. Then click Stop.

- 8 Visually compare the original track and the newly recorded track. Zoom in to identify a place where the tracks have identical waveforms but are not lined up. Set the playhead at the corresponding identical points on the two waveforms and subtract the two Beats field values. This is the latency in milliseconds. If the recorded audio is late (to the right), you enter a positive value; if it's early (to the left), you enter a negative value. For example, if the location in beats of the selected point in the source loop is 1.2.002 and the location in beats of the corresponding point in the recording is 1.2.008, the latency is 6 milliseconds.
- 9 Enter the latency value in the Recording Preferences pane.
- 10 Mute the recorded track and test record the loop again to make sure the latency is eliminated.

Calling AppleCare Support

Included in your Soundtrack Pro package is documentation about the support options available from Apple. Several levels of support are available, depending on your needs.

Whatever your issue, it's a good idea to have the following information immediately available. The more of this information you have ready to give to the support agents, the faster they will be able to address your issue.

- The registration number that came with Soundtrack Pro. This number is different from the software serial number that is used to activate your copy of Soundtrack Pro.
- Which version of Mac OS X you have installed. This information is available by choosing About This Mac from the Apple menu.
- The version of Soundtrack Pro you have installed, including updates if applicable. The version number can be viewed by choosing Soundtrack Pro > About Soundtrack Pro.
- The model of computer you are using
- How much RAM is installed in your computer, and how much is available to Soundtrack Pro. You can find out how much RAM is installed by choosing About This Mac from the Apple menu in the Finder.
- What other third-party hardware is connected to or installed in the computer, and who are the manufacturers. Include hard disks, video cards, and so on.
- Any third-party plug-ins or other software installed along with Soundtrack Pro

AppleCare Support can be reached online at:
<http://www.apple.com/support/soundtrackpro>

1/3 Octave Analyzer 205
4-pin connectors 16
6-pin connectors 16

A

AAC files 56, 144
ACID music application 263
Action Insert bar 32, 173
actions
 applying 171
 bouncing realtime effects 170
 comparing 175
 deleting 176
 described 31, 46, 170
 editing 172
 file length and 176
 flattening 174
 limitations of 176
 reordering 172
 scripting in Waveform Editor 181
 settings 172
 turning on/off 172
 working with in Waveform Editor 170–176
Actions button 32
Actions list 32, 171, 173–174
Actions pop-up menu 32
Add Effect button 39
Add Favorite button 37
adding effects
 to busses 104–105
 to channel strips 134
 to outputs 104–105
 to tracks 104–105
Add Send button 39
Adjust Amplitude command 163
AIFF files 56, 144, 248–249, 263–278
ambient noise, adding 166–167
amplifiers 15, 19
amplitude 288
amplitude level 163
analog recording 290
Analysis button 32–33
analysis parameters 179
analysis results 179
Analysis Results list 32–33
analysis tools 177–180
Analysis Type list 32
analysis types 178
 clicks/pops 178
 clipped signal 178
 DC offset 178
 phase issues 178
 power line hum 178
 silence 178
Analyze button 32
analyzed problems, fixing 180
AppleCare Knowledge Base 293
AppleCare Support 293–295
Apple Cinema Display 187
Apple Loops files 60
Apple Loops Utility 57, 239, 263–278
AppleScript droplets 181, 283
AppleScript Script Editor 181
Apple Store 11
Apple websites 10–11
applications
 distortion in 292
 using Soundtrack Pro with 253–261
Apply Ambient Noise command 166
Apply button 161
ASIO plug-in 14
Assets drawer 264, 267–271, 273
audio
 See also sound
 basic concepts 287–292
 cleaning up 207
 clicks 178
 clipped signal 178
 clipping 138, 139, 198
 copying in Waveform Editor 157
 cutting in Waveform Editor 157
 DC offset 178
 digital 14
 effects. *See* effects
 fading in/out 162
 gain 162, 205

- inserting noise in 164
- inserting waveforms in 165
- normalizing 162
- overloaded signal 178
- pasting in Waveform Editor 158
- phase issues 178
- pops 178
- power line hum 178
- recording. *See* recording audio
- reducing noise in 168–169
- silence in 163–164
- silence threshold 178
- temporary mono mix 140
- in video clips 189
- volume. *See* volume
- audio analysis tools 177–180
- audio cables 17–18
- audio clips
 - aligning with markers 191
 - changing offset of 116–117
 - copying 108
 - crossfades between 111–112
 - cutting 108
 - described 87
 - duration of 110–111
 - editing 107–119
 - joining 114
 - keyboard shortcuts 281–282
 - moving 109–110
 - name of 90
 - overlapped 113
 - pasting 108–109
 - playback mode 117
 - properties 89–90
 - redoing changes 71
 - removing 108, 119
 - replacing source audio in 117–119
 - resizing 110–111
 - saving recorded clips 239
 - selecting 107
 - snapping 72–73, 110
 - splitting 113–114
 - transposing 115–116
 - truncating 113
 - undoing changes 71
 - zooming in/out 95–96
- audio connectors 16, 17–18
- audio effects. *See* effects
- audio equipment, connecting 15–19
- audio file project format 144
- audio file projects
 - See also* projects
 - closing 145
 - creating 145
 - editing in Waveform Editor 154–160
 - exporting. *See* exporting items
 - getting started with 144–152
 - importing video into 183, 184
 - opening in Waveform Editor 144–145
 - overview 8, 46
 - playing 50–56, 152
 - processing in Waveform Editor 161–170
 - recording. *See* recording audio
 - saving 146–148
 - saving projects as 146–147
 - scrubbing 54
- audio files
 - AAC 56
 - adding to multitrack projects 87–89
 - adding to Timeline 87–89
 - AIFF 56
 - ambient noise in 166–167
 - amplitude 163
 - analyzing in Waveform Editor 177–180
 - on CD-ROM discs 14
 - on hard disks 14
 - common problems 294
 - editing in Waveform Editor 154–160
 - exporting projects to 248
 - finding. *See* finding items
 - formats for 56
 - gain of 163
 - graphically editing 159–160
 - information about 43
 - inserting noise in 164
 - length of 176
 - looping 57, 117
 - moving between selections 157
 - MP3 56
 - non-looping 57, 117
 - normalization 162
 - opening in Apple Loops Utility 269
 - opening in Waveform Editor 144–145
 - phase of 163
 - playing in Waveform Editor 152
 - previewing 68–69
 - processing in Waveform Editor 161–170
 - QuickTime 56
 - reconnecting 74
 - reducing noise in 168–169
 - sample rates 83
 - saving 147–148
 - saving with projects 87, 252
 - scrubbing in Waveform Editor 153
 - selecting in Waveform Editor 154–157
 - selecting parts of 154–156, 159
 - silence in 163–164
 - size of 235
 - source 107, 117–119
 - storing in Bin 67–68
 - supported formats 144
 - tagged 60

- tagging with Apple Loops Utility 263–278
- time stretching 160, 166
- unable to find 74
- WAV 56
- audio input 14
- audio interfaces 15
- audio output 14, 18–19
- audio postproduction 7, 198
- audio repair. *See* analysis tools
- audio tracks. *See* tracks
- Audio Units plug-ins 14, 195
- Auto Gain parameter 205
- automation 219–233
 - described 219
 - envelopes 219–227
 - modes for 228
 - processing effects 216
 - realtime effects 213
 - recording automation data 228–229
 - recording in Mixer 140
 - Timeslices 229–233
- Automation Mode pop-up menu 26, 29, 31
- automation modes
 - Latch 228
 - Read 228
 - Touch 228
- automation recording sensitivity 76
- automation sensitivity 229

B

- Back button 34, 35
- bandpass filters 200
- bandwidth 200
- bass frequency range 200
- batch tagging 263
- Beat display 52
- beat divisions 82
- beat markers 120–122
- beats 82, 84, 98
- Beats-based format 82, 83, 98, 104, 233
- Beats-based time 52, 53, 192
- Beginning value slider 44
- Bin tab
 - adding audio files from 89
 - described 38
 - storing files in 67–68
- bit depths 15, 56, 144, 291
- boost 19, 198–200
- Browser tab 34, 58
- bus controls 91, 102–106
- busses
 - adding 100
 - adjusting pan position 102
 - adjusting volume 102
 - changing icon for 101

- copying 101
- described 93
- effects 104–105
- envelopes for 106
- exporting 248–249
- moving 101
- muting 103
- numbered 101
- overview 91
- removing 106
- renaming 101
- selecting 100
- sends routed to 212
- setting height of 97
- soloing 103
- working with 99–106

- buttons
 - control surface 245–246
 - mapping commands to 245–246
 - Toolbar 49
- Button view 36, 37, 60, 63–65
- Button View button 37, 60
- bypass 211, 213
- Bypass button 161

C

- cables, audio 17–18
- camcorders 15
- Can't Find File dialog 74
- Cancel button 161
- Category list 39
- Category pop-up menu 37
- CD-ROM discs 14
- CDs
 - audio 76, 291
 - distributing projects on 247
 - sample rate 76, 291
- center frequency 200
- chaining effects 210–211
- channel layout, editing 251
- channels
 - selecting in Waveform editor 155–156
 - swapping 163
- Channel Strip pop-up menu 29
- channel strips 29–30
 - adding to Mixer 126
 - changing icon for 131
 - copying 127
 - described 125
 - effects 134–136
 - enabling for recording 131
 - muting 130
 - pan position 129
 - removing 134
 - renaming 131

- reordering 127
 - selecting 126
 - sends 137
 - setting outputs for 129–130
 - soloing 130
 - stereo level meters 133
 - volume levels 127–128
 - working with 125–134
 - chorus effects 201
 - Clear Fixed button 33
 - clicks 178
 - Clip display 43
 - clipped signals 178
 - clipping 138, 139, 198
 - clipping indicators 139
 - clips. *See* audio clips; video clips
 - Clip Speed pop-up menu 43
 - Collect Source File checkbox 147
 - Column view 36, 37, 60, 60–62
 - Column View button 37, 60
 - compressed, saving projects 87
 - compression 87, 197
 - Compressor application 46, 250–251
 - compressors 197
 - Computer button 34
 - connectors 17–18
 - controls 125, 245
 - control surfaces 243–246
 - adding 244
 - automation modes 246
 - connecting 243
 - deleting 244
 - described 243
 - FireWire audio interface 21
 - mapping commands to 245–246
 - preferences 79
 - premapped controls 245
 - recording movements 246
 - support of 19
 - types of 243
 - using 243
 - Control Surfaces preferences 79
 - Convert to Mono command 167
 - Copy from Next Point button 44
 - Copy from Previous Point button 44
 - copying items
 - audio clips 108
 - audio in Waveform Editor 157
 - channel strips 127
 - envelope points 225
 - Timeslices 231
 - Correlation meter 204
 - crossfade mode 85, 112
 - crossfades
 - adjusting 112
 - creating 85, 111–112
 - moving 112
 - customer support 293–295
 - Customize sheet 49, 50
 - cutoff frequency 200
 - cuts 204, 281
 - cutting items
 - audio clips 108
 - audio files 157
 - envelope points 225
 - frequencies 198, 199
 - peak levels 197
 - Timeslices 231
 - Cycle button 25, 55, 238
 - cycling playback 98–99
- ## D
- daisy-chaining 15
 - DC offset 178
 - decay time 203
 - delay 196
 - delay effects 196, 202
 - delay rate 202
 - delay time 203
 - deleting items
 - actions 176
 - audio clips 108, 119
 - beat markers 122
 - busses 106
 - channel strips 134
 - control surfaces 244
 - effects 136
 - envelope points 225–226
 - layouts 48
 - markers 122
 - outputs 106
 - realtime effects 214
 - scoring markers and 122
 - time markers 122
 - Timeslices 231, 232
 - tracks 106
 - unable to delete scoring markers 122
 - video clips from projects 193
 - Denoiser effect 206
 - depth 202
 - descriptors 266, 277
 - Details tab 43–44, 188–189
 - diagnostic effects 196, 204–205
 - digital audio 14
 - See also* audio
 - digital audio connectors 18
 - digital audio interfaces 15
 - Digital Cinema Desktop 187
 - digital recording 290–291
 - digital video 83
 - See also* video

- directories 65–67
- disk space 14, 41, 235
- disk space indicator 41
- distortion 196, 198, 292
- distortion effects 196
- distributing projects 247, 252
- dithering 147
- Dock, minimizing windows to 47
- downsampling 83
- drag handles 27, 30, 91, 92
- drop frames 190
- droplets 181, 283
- dry signal 203
- dual mono files 248–249
- Duration value slider 43, 44
- DVDs
 - audio 76, 291
 - distributing projects on 247
 - sample rate 76, 291
 - video for 83
- DVD Studio Pro, editing clips from 260
- dynamic range 18, 178, 197, 205, 292
- dynamics 196
- dynamics effects 196, 197–198

E

- editing items
 - actions 172
 - audio clips 107–119
 - audio files in Waveform Editor 154–160
 - channel layout 251
 - clip properties 89–90
 - destructive edits 253, 255, 260
 - DVD Studio Pro clips in Waveform Editor 260
 - envelope points 224–225
 - Final Cut Pro clips in Waveform Editor 253–255
 - keyboard shortcuts for 281–284
 - Motion audio tracks in Waveform Editor 258–259
 - nondestructive edits 253–255, 258
 - samples 159
 - with Soundtrack Pro scripts 256
- education users 11
- Effect list 39, 105, 207, 208
- effect parameters 39, 207
- Effect Parameters area 39, 105
- effect presets 217–218
- effects 195–214
 - adding 134
 - bus 104–105
 - channel strips 134–136
 - chorus 201
 - delay 196, 202
 - deleting 136
 - Denoiser effect 206
 - described 195

- diagnostic 196, 204–205
- distortion 196, 198
- dynamics 196, 197–198
- envelopes and 220, 227
- EQ 196, 198–201
- filter 196, 198–201
- included with Soundtrack Pro 196–207
- miscellaneous 196, 206–207
- Mixer 134–136
- modulation 196, 201–202
- output 104–105
- processing. *See* processing effects
- realtime. *See* realtime effects
- reordering 135
- replacing 136
- reverb 196, 203–204
- settings 135
- Stereo Spread plug-in 207
- tail 170, 171
- third-party 14
- time-based 202–204
- track 104–105
- turning off 136
- turning on 136, 137
- types of 196–207

- Effects button 27, 32, 104–105
- effects chains 195, 210–211
- effects slots 30
- Effects submenu 161–162
- Effects tab
 - adding effects to channel strips 135
 - adding effects to tracks/busses/outputs 104–105
 - overview 39
 - realtime effects 207–215
- enabling track for recording 131, 236
- end-of-project marker 86
- End value slider 44
- envelope points 221–226
 - adding 221
 - changing position of 223, 224
 - changing values of 223
 - copying 225
 - cutting 225
 - deleting 225–226
 - editing 224–225
 - information about 44
 - moving 219, 222
 - nudging 225
 - pasting 226
 - reducing number of 229
 - scoring markers and 192
 - selecting 222
 - viewing details 224
- envelopes 219–229
 - adding 227
 - bus 106

- described 289
- effects and 220, 227
- hiding 106
- master 219, 220–221
- output 106
- overview 219–220
- percussive 289
- removing 227
- sends and 227
- showing 106, 220
- sustained 289
- Timeslices 229–232
- track 106, 220
- track pan 220
- volume 220

envelopes disclosure triangle 28

EQ (equalization)

- frequency ranges used with 199–200
- graphic 201
- overview 198–201
- parametric 201

EQ effects 196, 198–201

equipment

- connecting audio equipment 15–19
- example hardware setups 19–21
- setting up. *See* system setup

exclusive solo 103

exporting items

- busses 248–249
- multitrack projects to Final Cut Pro 258
- outputs 248–249
- project mixes 248
- projects with Compressor 250–251
- projects to audio files 248
- tracks 248–249

export presets, Compressor 251

external video output device 188

F

Fade In command 162

Fade Out command 162

fading audio in/out 162

Favorites 59

Favorites list 35

Favorites tab 35, 59

feedback 202, 203

File Browser. *See* Browser tab

file formats. *See* formats

File Info area 266

File list 34, 38

files

- audio. *See* audio files
- dual mono 248–249
- finding. *See* finding items
- keyboard shortcuts 279

- looping 57, 114, 117, 239
- media. *See* media files
- mono 167, 248–249
- non-looping 57, 117, 239
- source 107, 117–119
- stereo 167, 248–249
- supported formats 56
- tagged 60, 263–278
- unable to find 74
- video. *See* video files

File Type pop-up menu 37

filter effects 196, 198–201

filters 200

Final Cut Pro

- exporting multitrack projects to 258
- importing video from 183
- saving droplets to clips in 182
- scoring markers 191–193
- Soundtrack Pro and 8
- using Soundtrack Pro with 253–258
- Waveform Editor and 146

Final Cut Pro clips

- creating multitrack projects with 256–258
- editing clips in Waveform Editor 253–255
- editing with Soundtrack Pro scripts 256

Finder, adding audio files from 89

finding items

- with Browser tab 58
- with Favorites tab 59
- keywords 36–37
- with Search tab 60–67

FireWire audio interface 21

FireWire connectors 16

FireWire technology 16

FireWire website 11

Fix All button 33

Fix button 33

flangers 202

formats

- audio 56, 144
- audio file project 144
- time 190
- video 183

Forward button 34, 35

frame rates 190

frequencies 165, 198, 204, 287

frequency bands 205, 206, 207

frequency ranges 199–200

frequency spectrum 151–152

fundamental 288

G

gain 163, 198, 200, 205

Gain field 41

gain slider 41

- General preferences 75
- Global Timeline view 26, 97
- Global Waveform view 32, 150
- Goniometer 205
- Go to Beginning button 25, 55
- Go to End button 25, 55
- Go to Peak buttons 42, 139
- graphic EQs 201
- gridlines 93

H

- hard disk 14
- hardware
 - requirements 13
 - sample rates 83
- harmonics 288
- headers 27–28
- help
 - keyboard shortcuts 280
 - onscreen 10
- high frequency range 199
- highpass filters 200
- hints 43, 61, 70
- hiss 294
- Home button 34
- hubs 15
- hum, power line 178

I

- icons
 - busses 27, 101
 - changing for channel strips 131
 - channel strips 30
 - headers 27
 - outputs 27, 101
 - showing in Toolbar 50
 - tracks 27, 101
- IEEE 1394. *See* FireWire
- importing items
 - QuickTime movies 183
 - video from Final Cut Pro 183
 - video into projects 183, 184
- indexed directories 65–67
- input devices 14
- input signal 238
- Input synchronization settings 78
- Insert command 163–165
- inserting noise 164
- inserting silence 163–164
- inserting waveforms 165
- interface 23–44
- Invert command 163

K

- key (musical) 263, 265, 268, 276

- key, project 85
- keyboard shortcuts
 - Apple Loops Utility 275–278
 - listed 279–285
 - playback 56, 186
- keyword buttons 36, 37, 64–65
- keywords 36–37, 60–65
- Keywords list 36, 37, 60

L

- Latch mode 228
- latency
 - described 15
 - eliminating 294
 - increased 22
- layouts
 - choosing 48
 - deleting 48
 - described 48
 - keyboard shortcuts 279–280
 - saving 48
- Level Meter 204
- level meters
 - channel strips 133, 138
 - Meters tab 42
 - Mixer 30
 - Recording tab 41
 - Timeline 27
 - Waveform Editor 32
- LFO (low-frequency oscillator) 201–202, 203
- limiters 198
- linear scale, showing frequency spectrum on 152
- location buttons 139
- Location display 42
- logarithmic scale, showing frequency spectrum on 152
- Logic Control protocol 19
- .loop extension 81
- Looping button 239
- looping files 57, 114, 117, 239
- looping playback 87, 98–99
- looping playback mode 87
- low-frequency oscillator (LFO) 201–202, 203
- lowpass filters 200

M

- .m2v files 183
- Mackie Control protocol 19
- Mac OS, version of 295
- Magnify button 33
- manual 10
- markers
 - aligning audio clips to Timeline with 191
 - beat 120–122
 - deleting 122

- Final Cut Pro 191–193
- information about 44
- inserting 120
- keyboard shortcuts 284
- naming 121
- scoring 190–193
- time 120–122, 190, 191
- types of 120
- uses for 119
- using in Waveform Editor 181
- using with video 190–193
- working with 119–122
- marker titles, viewing 121
- MAS plug-in 14
- master envelopes 28, 219, 220–221
- Master Envelopes button 28
- mastering process 141
- master Timeslice 230–231
- master volume slider 24
- Matches list 36, 37, 60, 62
- Measure in pop-up menu 43, 44
- measures 82, 84, 98
- Media and Effects Manager 33–39
 - adding audio files from 88
 - described 23
 - locating files in 56–67
 - previewing files in 68–69
 - viewing audio file information in 70–71
- media files
 - reconnecting 74
 - saving with projects 87, 252
 - storing 14
 - unable to find 74
- Media pop-up menu 34, 35, 37, 38, 69
- memory 13
- meters, diagnostic 196
- Meters tab 42, 138–139
- microphones 15, 19
- MIDI Clock signal 25, 55
- MIDI input port 244
- MIDI interface 21, 243
- MIDI output port 244
- MIDI Sync button 25, 55
- MIDI Timecode (MTC) signal 25, 55
- midrange frequency range 199
- mini-plug connectors 18
- miscellaneous effects 206–207
- Mixer 123–141
 - adding channel strips to 126
 - adding realtime effects in 208
 - described 123
 - hiding 132
 - mixing multitrack projects in 7
 - overview 23, 29–31
 - recording audio in 240
 - showing 132
 - working in 123–141
 - working with channel strips 125–134
 - working with effects 134–136
- Mixer pop-up menu 29
- mixers 15, 19
- mixes
 - exporting 248
 - final 141
 - multiple 141
 - temporary mono mix 140
- mixing projects
 - described 123
 - exporting mixes 248
 - guidelines for 141
 - mastering process 141
 - procedure for 124
- modulation 196
- modulation effects 196, 201–202
- Monitor pop-up menu 41
- monitors 15, 18, 19
- mono files 167, 248–249
- mono mix 140
- Mono Mix button 24, 140
- Motion
 - using Soundtrack Pro with 258–259
 - Waveform Editor and 147
- .mov extension 56, 183
- movies
 - QuickTime 144, 183, 260
 - reference 147
- MP3 files 56, 144
- MPEG-2 files 183
- MPEG-2 playback 183
- MTC (MIDI Timecode) signal 25, 55
- MultiMeter 204–205
- multiple solo 103
- multitrack projects 81–92
 - See also* projects
 - adding audio files to 87–89
 - audio clip properties 89–90
 - closing 82
 - compressed version of 87
 - creating 81
 - creating from Final Cut Pro clips/sequences 256–258
 - distributing 252
 - exporting. *See* exporting items
 - importing video into 183, 184
 - length of 86
 - opening 81
 - overlap mode 85
 - overview 7, 45–46
 - playing 50–56
 - properties 82–85
 - recently open 81
 - reconnecting media files 74

- recording. *See* recording audio
- saving 86–87
- saving with media files 87, 252
- scrubbing 54
- unable to find files 74
- music, basic concepts 287–292
- musical instruments 15
- musical intervals 115–116
- musical sounds 288
- Mute button 27, 31, 69, 103
- Mute Project checkbox 41
- muting channel strips 130
- muting tracks/busses/outputs 103

N

- Name field 27, 31, 44
- navigation
 - keyboard shortcuts 280, 282–283
 - playhead 280
 - scroll bars 94
 - Timeline 94–99, 282–283
 - Zoom control 95–96
- Nearby Keys button 37
- Next Selection button 31
- NeXT sound files 144
- noise
 - ambient 166–167
 - Denoiser effect 206
 - eliminating 206, 294
 - glass-noise effect 206
 - inserting in audio 164
 - pink 164
 - reducing 168–169, 206
 - white 164
- noise gates 198
- Noise Generator dialog 164
- non-drop frames 190
- non-looping files 57, 117, 239
- non-looping playback mode 87
- normalization level 162
- Normalize command 162
- notch frequencies 202
- Nyquist theorem 291

O

- offset 116–117
- Offset value slider 43
- onscreen help 10
- optical digital connectors 18
- output controls 92, 102–106
- output devices 14, 187–188
- Output pop-up menu 28, 30
- outputs
 - adding 100
 - adjusting volume 102

- changing icon for 101
- channel strips 129–130
- copying 101
- described 93
- effects 104–105
- envelopes for 106
- exporting 248–249
- moving 101
- muting 103
- numbered 101
- overview 91–92
- removing 106
- renaming 101
- selecting 100
- setting height of 97
- soloing 103
- working with 99–106
- Output synchronization settings 78
- Overlap mode 85, 113
- overloaded signals 178
- overtones 288

P

- pan controls 102, 129
- panning 102, 124
- pan position 213
- pan positions 102, 129
- pan slider 28, 30, 102
- Parameters list 32
- parametric EQs 201
- Paste Mix command 158
- Paste Repeat command 158
- pasting items
 - audio clips 108–109
 - audio in Waveform Editor 158
 - envelope points 226
 - Timeslices 231
- Path pop-up menu 34, 35
- PCI (Peripheral Connect Interface) 17
- PCI interfaces 17
- PCMCIA 17
- peak 287
- peak indicators 30, 41, 42, 139
- peak information 205
- peak levels 197
- peak limiters 198
- Peak Location display 139
- peaks 149–150, 162, 178, 266, 289
- Peak Value display 42, 139
- performance 294
- Peripheral Connect Interface. *See* PCI
- phase 163
- phase issues 178
- Phaser effect 196
- phase relationships 289

- phase shifters 202, 289
- phone plug connectors 17
- physical output channels 28, 30, 91, 92, 129, 251
- pink noise 164
- pitch 288
- Play/Pause button 25
- playback 50–56
 - audio files in Wave Editor 152
 - changing mode 117
 - controlling 25, 50–54, 98–99
 - cycling 98–99
 - keyboard shortcuts 56, 186, 280
 - looping 87, 98–99, 117
 - MPEG-2 183
 - non-looping 87, 117
 - starting 50
 - video 185–188
- Playback buttons 43
- playback mode 117
- playback position 55, 280
- playback region 98–99
- Play button 50, 55, 69, 161, 237, 238
- Play From Beginning button 25, 55
- playhead
 - changing position 54
 - described 32
 - keyboard shortcuts 280
 - positioning with Time ruler 98
 - scoring marker to 192–193
 - setting 51–54
 - splitting audio clips with 113, 114
- Playhead Position value slider 24, 53–54, 84
- playing projects 50–56
- plug-ins
 - Audio Units 14, 195
 - effects 13, 14
 - included with Soundtrack Pro 14
 - Stereo Spread 207
 - unsupported 14
- pops 178
- Position value slider 43, 44
- postproduction 7, 198
- power line hum 178
- preferences
 - Apple Loops Utility 274
 - Recording 235
 - Soundtrack Pro 75–80
- Preferences window 75
- presets, effect 217–218
- Presets drawer 162, 217, 218
- preview controls 34, 35, 37, 38, 69
- previewing items
 - audio files 68–69
 - in Media and Effects Manager 68–69
 - preview file information 70–71
 - video files 68, 189
- Previous Selection button 31
- processing effects
 - See also* effects
 - advanced settings 216
 - applying 216
 - automation 216
 - overview 196
 - presets 217–218
 - working with 216
- processor speed 13
- project controls 26
- project key 85
- project length, setting 86
- Project pop-up menu 29
- Project preferences 76–77
- project properties 82–85
 - key 85
 - overlap mode 85
 - sample rate 83
 - tempo 84
 - time format 82–83
 - time signature 84
- projects
 - audio file. *See* audio file projects
 - collecting original source media in 147
 - controlling playback of 98–99
 - distributing 252
 - exporting mixes 248
 - exporting to audio files 248
 - importing QuickTime movies into 183
 - importing video into 183, 184
 - miniature view of 97
 - multitrack. *See* multitrack projects
 - overall volume of 138–139
 - playing 50–56
 - preferences 76–77
 - removing video clips from 193
 - saving as audio file projects 146–147
 - saving with media files 252
 - scrolling through 94
 - scrubbing 54
 - types of 45–46
 - undo/redo changes to 71
- Project window 23, 24–33, 145
- properties
 - audio clips 89–90
 - multitrack projects 82–85
- property tags 265

Q

- quarter-size frames 80, 187
- QuickTime 11
- QuickTime audio files 56
- QuickTime movie files 144
- QuickTime movies 183, 260

R

RAM 13
 RCA connectors 18
 Read Before You Install document 13
 Read mode 228
 realtime effects 207–215
 See also effects
 adding 208–209
 adjusting parameters 209
 advanced settings 215
 automation 213
 bouncing 170
 bypassing 211
 chaining 210–211
 overview 195
 parameters 213
 presets 217
 removing 214
 reordering 211
 resetting to defaults 214
 sends and 212–213
 showing 170
 working with 207–215
 Record button 25, 55, 237, 238
 Record Enable button 27, 31, 236, 240
 recording audio 235–241
 analog recording 290
 digital recording 290–291
 disk space and 235
 eliminating latency 294
 enabling channel strips for 131
 enabling tracks for recording 236
 keyboard shortcuts 285
 in Mixer 140, 240
 multiple takes 238–239
 preferences 77
 preparing for 235
 procedure for 289–292
 saving recorded clips 239
 sessions location 77
 single takes 237
 in Timeline 236–239
 in Waveform Editor 240–241
 recording automation in Mixer 140
 recording control surface automation 246
 Recording pane 235
 Recording preferences 77, 235
 recording sessions, save location 77
 Recording tab 41, 236, 238
 Redo command 71
 Reduce Noise command 168–169
 reference movies 147
 regeneration 202, 203

Remove Effect button 39
 Render checkbox 146, 254, 255, 259, 260
 render file for Final Cut Pro 254
 rendering 146
 Resample command 167
 Reset button 42, 139, 161
 Reset Effect button 39
 resources 9
 reverb 196
 reverb effects 196, 203–204
 reverberation 203
 reverb time, 203
 Reverse command 163
 ripple cut 281
 ripple delete 281
 roll-off filters 200
 root note 85
 roundtrips 183, 254, 255, 258, 259
 RTAS plug-in 14

S

Sample Edit tool 159
 sample rates
 audio files 83
 choosing 167
 described 83, 291
 digital video 83
 hardware 83
 importing audio files 56
 multiframe projects 83
 Soundtrack Pro and 15
 Waveform Editor 144, 167
 Sample ruler 152
 samples
 described 290
 editing 159
 reversing 163
 sample units 149
 saving items
 actions as AppleScript droplets 181
 audio file projects 146–148
 audio files 147–148
 compressed project versions 87
 multitrack projects 86–87
 project and audio files together 87, 252
 recorded clips 239
 scale type 276
 Scale Type pop-up menu 37
 scoring markers 122, 190–193
 scripting actions 181
 scripts 181, 256
 scroll bars 27, 94
 scrubbing
 audio files in Waveform Editor 153
 described 153

- projects 54
- selections 54
- Search database 65–67
- searches, keyword 36–37
- searching. *See* finding items
- Search Results list 37
- Search tab 36–37, 60–67
- search tags 266
- Search Text field 37, 61
- segments 113–114
- Selection Length value slider 24
- selections
 - audio files in Waveform Editor 154–156
 - moving between 157
 - next 157
 - previous 157
- Selection tool 159
- semitones 115–116
- sends
 - adding to tracks 212
 - busses routed to 212
 - bypassing 213
 - channel strips 137
 - envelopes and 227
 - pan position 213
 - realtime effects and 212–213
 - reordering 137, 212
 - settings 137
 - turning on/off 137
 - volume level 213
- Set Ambient Noise Print command 166
- Set Noise Print command 168
- setting up system. *See* system setup
- Setup button 37
- shelf filters 200
- Show/Hide Presets button 162
- Show pop-up menu 26, 39
- Silence command 163
- silence threshold 178
- SMPTE (Society of Motion Picture and Television Engineers) 78
- Snap button 28
- Snap option 72–73
- snapping
 - clips to adjacent clips 110
 - clips to markers 191
 - envelope points 222
- Snap To Value pop-up menu 28
- Snap To values 28, 72–73
- Society of Motion Picture and Television Engineers (SMPTE) 78
- Solo button 27, 31, 103
- solioing channel strips 130
- solioing tracks/busses/outputs 103
- sound
 - See also* audio
 - musical sounds 288
 - recording. *See* recording audio
 - volume. *See* volume
- sound design 7, 8, 195, 196, 207
- Sound Designer II files 144
- Soundtrack Loop Utility. *See* Apple Loops Utility
- Soundtrack Pro
 - education users and 11
 - features 8–9
 - Final Cut Pro and 8
 - getting started with 45–80
 - interface 23–44
 - keyboard shortcuts 279–285
 - learning about 9, 11
 - onscreen help 10
 - overview 7–9
 - preferences 75–80
 - resources 9
 - setting up. *See* system setup
 - software installation 13
 - specifications 11
 - system considerations 13–14
 - using with DVD Studio Pro 260
 - using with Final Cut Pro 253–258
 - using with Motion 258–259
 - using with other applications 260
 - website for 10
- Soundtrack Pro scripts 181, 256
- Soundtrack Pro User Manual 10
- sound waves 287, 289, 290
- source audio files 107, 117–119
- source media 147
- speakers 15, 18, 19
- specifications 11
- Spectrum Analyzer 205
- Spectrum view 32, 151–152
- Spectrum View button 32
- Split menu item 113, 114
- splitting audio clips 113–114
- Split tool 113
- .stap extension 146, 254
- startup preferences 75
- stereo, enhancing 207
- stereo channels 138
- Stereo checkbox 41
- stereo delays 203
- stereo files, converting to mono 167
- Stereo Spread plug-in 207
- .stmp extension 81, 86
- stretching technique 271
- Stretch tool 160
- submixes 91
- Swap Channels command 163
- synchronization 78
- Synchronization preferences 78
- system requirements 13

- system setup 13–21
 - connecting audio equipment 15–19
 - control interface 21
 - example hardware setups 19–21
 - FireWire audio interface 21
 - overview 13
 - powered speakers 19
 - software installation 13
 - system considerations 13–14
 - USB audio interface 20
 - video output devices 22
- T**
- tabs
 - described 24
 - detaching/reattaching 48
 - keyboard shortcuts 279–280
 - reordering 47
- tagged audio clips 115–116
- tagged audio files 60, 263–278
- tags 263, 265, 266
- Tags tab 264, 265–266
- tail effect 86, 170, 171
- takes. *See* recording audio
- Tap tempo delays 203
- tempo 84, 192–193, 263
- temporary mono mix 140
- text, showing in Toolbar 50
- threshold 197
- timbre 288
- time-based effects 202–204
- Time-based format 52–53, 82, 83, 98, 104, 233
- timecode
 - aligning audio clips to 98, 191
 - MIDI Timecode 25
 - Time-based format 53
 - time markers and 190
 - Time ruler units and 183, 190
- timecode format 190
- Time Code Offset synchronization settings 78
- Time display 26, 32, 52–53, 190
- time format
 - described 190
 - projects 98
 - setting 82–83
 - tracks 104
- Timeline
 - adding audio files to 87–89
 - controls 28
 - editing audio clips in 107–119
 - Global view 97
 - headers 27–28
 - keyboard shortcuts 282–283
 - moving audio clips in 109–110
 - navigating in 94–99
 - overview 26–27
 - preferences 75–76
 - recording audio in 236–239
 - scrubbing projects in 54
 - setting track height in 97
 - track controls 27–28
 - working in 93–122
 - zooming in/out 95–96
- Timeline controls 27, 28, 153
- Timeline editing tools 26
- time markers 120–122, 190, 191
- Time ruler 27, 98, 190
- Time Ruler units 148
- time signature 37, 84
- Time Signature pop-up menu 37
- Timeslices 229–233
- Timeslice selection area, changing 232–233
- Time Stretch command 166
- time stretching audio files 160, 166
- tip-ring (TR) connectors 17
- tip-ring-sleeve (TRS) connectors 17
- tone 198
- tone color 288
- tonic 85
- Toolbar 24, 25, 49
- Touch mode 228
- TR (tip-ring) connectors 17
- Track area 27
- track controls 27–28, 90, 102–106
- track envelopes 220
- Track Height control 28, 97
- track pan envelopes 220
- tracks
 - adding 99
 - adding sends to 212
 - adjusting pan position 102
 - adjusting volume 102
 - changing icon for 101
 - copying 101
 - described 93
 - effects 104–105
 - enabling for recording 236
 - envelopes for 106
 - exporting 248–249
 - keyboard shortcuts 284
 - Motion 258–259
 - moving 101
 - moving audio clips between 110
 - muting 103
 - numbered 101
 - overview 90
 - pan positions 129
 - removing 106
 - renaming 101
 - routing to busses 91
 - selecting 100

- selecting audio clips in 107
- setting height of 97
- showing 220
- soloing 103
- time format 104
- working with 99–106
- transducers 289
- transients 263, 266, 271–272, 278
- Transients tab 264, 266–267, 271
- transport controls 24, 25, 32, 55–56, 185–186
- Transpose pop-up menu 43
- treble 169, 199, 288
- troubleshooting 180, 293–295
- TRS (tip-ring-sleeve) connectors 17
- truncate mode 85
- Type buttons 44

U

- Undo command 71
- Universal Serial Bus. *See* USB
- upsampling 83
- USB (Universal Serial Bus) 15, 16
- USB audio interface 20, 294
- USB cables 16
- USB connectors 16
- USB devices 16, 294
- USB hubs 16, 294
- User Manual 10
- Utility window 23, 40–44

V

- Value display 139
- value slider 30
- Value value slider 44
- video 183–193
 - for DVDs 83
 - encoding 250
 - frame rates 190
 - importing into projects 183, 184
 - playback of 185–188
 - preserving 250
 - removing from projects 193
 - supported formats 183
 - time format 190
 - transport controls 185–186
 - using markers with 190–193
 - using Time display with 190
 - using Time ruler with 190
 - working with 183–193
 - working with audio in 189
- videocassette decks 15
- video clips
 - importing into projects 184
 - reconnecting 74
 - removing from projects 193

- timecode position 190, 191
- viewing details of 188–189
- video files
 - previewing 68, 189
 - reconnecting 74
 - saving with projects 87
 - size of 252
 - viewing details about 43, 188–189
- video frame rate, choosing 76, 190
- video out device 187
- Video Out preferences 80
- video output 80
- video output devices 22, 187–188, 284
- Video Playback value slider 40
- Video Scale pop-up menu 40
- Video tab 40, 184, 186
- video timecode format 190
- video transport controls 40
- video viewing area 40
- viewing area 40
- volume
 - adjusting for busses 102
 - adjusting for outputs 102
 - adjusting for tracks 102
 - channel strips 127–128
 - described 288
 - overall 138–139
 - sends 213
- volume envelopes 220
- volume fader 30
- volume slider 28, 69, 102, 161
- VST plug-in 14

W

- waveform display
 - described 32
 - sample units 149
 - Time Ruler units 148
 - zooming in/out 149, 160
- waveform editing tools 31
- Waveform Editor 143–182
 - adding realtime effects in 209
 - analyzing audio files in 177–180
 - closing projects 145
 - copying audio in 157
 - creating projects 145
 - cutting/pasting in 157–158
 - editing audio files in 8, 154–160
 - editing DVD Studio Pro clips in 260
 - editing Final Cut Pro clips in 253–255
 - editing Motion audio tracks in 258–259
 - moving between selections 157
 - opening projects 144–145
 - overview 31–33
 - playing audio file projects in 152

- processing audio files in 161–170
 - recording audio in 240–241
 - Sample units 149
 - saving projects 146–148
 - scripting actions in 181
 - scrubbing audio files in 153
 - scrubbing projects/selections in 54
 - selecting channels in 155–156
 - selecting parts of audio files 154–156, 159
 - selection details 44
 - supported audio formats 144
 - Time Ruler units 148
 - using markers in 181
 - using Timeline controls in 153
 - views 150–152
 - working with actions 170–176
 - zooming in/out 149–150
 - waveforms
 - clip offset and 117
 - frequency of 165
 - inserting in audio 165
 - length of 165
 - Waveform view button 32
 - WAV files 56, 144, 263–278
 - websites
 - AppleCare Support 295
 - Apple homepage 11
 - Apple Service and Support 10
 - Apple Store 11
 - Apple websites 11
 - FireWire 11
 - QuickTime 11
 - Soundtrack Pro 10
 - wet signal 203
 - white noise 164
 - windows 23–44
 - closing 47
 - keyboard shortcuts 279–280
 - minimizing to Dock 47
 - moving 47
 - resizing 47
 - workspace, setting up 47–50
- X**
- XLR cables 17
 - XLR connectors 17
- Z**
- Zoom control 28, 95–96, 149
 - zooming in/out
 - on analyzed problems 180
 - with scroll wheel 96, 149
 - waveform display 160
 - Waveform Editor 149–150
 - with Zoom control 95–96
 - Zoom tool 160