

SP-606 Sampling Workstation

Owner's Manual

Thank you, and congratulations on your choice of the Roland Sampling Workstation SP-606.

Before using this unit, carefully read the sections entitled: "USING THE UNIT SAFELY" and "IMPORTANT NOTES" (p. 2-3; p. 4-6). These sections provide important information concerning the proper operation of the unit. Additionally, in order to feel assured that you have gained a good grasp of every feature provided by your new unit, Owner's manual should be read in its entirety. The manual should be saved and kept on hand as a convenient reference.



Copyright © 2004 ROLAND CORPORATION

All rights reserved. No part of this publication may be reproduced in any form without the written permission of ROLAND CORPORATION.

USING THE UNIT SAFELY

INSTRUCTIONS FOR THE PREVENTION OF FIRE, ELECTRIC SHOCK, OR INJURY TO PERSONS

About ⚠ WARNING and ⚠ CAUTION Notices

⚠ WARNING	Used for instructions intended to alert the user to the risk of death or severe injury should the unit be used improperly.
⚠ CAUTION	Used for instructions intended to alert the user to the risk of injury or material damage should the unit be used improperly. * Material damage refers to damage or other adverse effects caused with respect to the home and all its furnishings, as well to domestic animals or pets.

About the Symbols

⚠	The ⚠ symbol alerts the user to important instructions or warnings. The specific meaning of the symbol is determined by the design contained within the triangle. In the case of the symbol at left, it is used for general cautions, warnings, or alerts to danger.
⊘	The ⊘ symbol alerts the user to items that must never be carried out (are forbidden). The specific thing that must not be done is indicated by the design contained within the circle. In the case of the symbol at left, it means that the unit must never be disassembled.
⦿	The ⦿ symbol alerts the user to things that must be carried out. The specific thing that must be done is indicated by the design contained within the circle. In the case of the symbol at left, it means that the power-cord plug must be unplugged from the outlet.



ALWAYS OBSERVE THE FOLLOWING

⚠ WARNING

- Before using this unit, make sure to read the instructions below, and the Owner's Manual. 

- Do not open (or modify in any way) the unit or its AC adaptor. 

- Do not attempt to repair the unit, or replace parts within it (except when this manual provides specific instructions directing you to do so). Refer all servicing to your retailer, the nearest Roland Service Center, or an authorized Roland distributor, as listed on the "Information" page. 

- Never use or store the unit in places that are:
 - Subject to temperature extremes (e.g., direct sunlight in an enclosed vehicle, near a heating duct, on top of heat-generating equipment); or are 
 - Damp (e.g., baths, washrooms, on wet floors); or are 
 - Humid; or are
 - Exposed to rain; or are
 - Dusty; or are
 - Subject to high levels of vibration.

- Make sure you always have the unit placed so it is level and sure to remain stable. Never place it on stands that could wobble, or on inclined surfaces. 

⚠ WARNING

- Be sure to use only the AC adaptor supplied with the unit. Also, make sure the line voltage at the installation matches the input voltage specified on the AC adaptor's body. Other AC adaptors may use a different polarity, or be designed for a different voltage, so their use could result in damage, malfunction, or electric shock. 

- Do not excessively twist or bend the power cord, nor place heavy objects on it. Doing so can damage the cord, producing severed elements and short circuits. Damaged cords are fire and shock hazards! 

- This unit, either alone or in combination with an amplifier and headphones or speakers, may be capable of producing sound levels that could cause permanent hearing loss. Do not operate for a long period of time at a high volume level, or at a level that is uncomfortable. If you experience any hearing loss or ringing in the ears, you should immediately stop using the unit, and consult an audiologist. 

- Do not allow any objects (e.g., flammable material, coins, pins); or liquids of any kind (water, soft drinks, etc.) to penetrate the unit. 

⚠ WARNING

- Immediately turn the power off, remove the AC adaptor from the outlet, and request servicing by your retailer, the nearest Roland Service Center, or an authorized Roland distributor, as listed on the “Information” page when:
 - The AC adaptor or the power-supply cord has been damaged; or
 - If smoke or unusual odor occurs
 - Objects have fallen into, or liquid has been spilled onto the unit; or
 - The unit has been exposed to rain (or otherwise has become wet); or
 - The unit does not appear to operate normally or exhibits a marked change in performance.
- In households with small children, an adult should provide supervision until the child is capable of following all the rules essential for the safe operation of the unit.
- Protect the unit from strong impact. (Do not drop it!)
- Do not force the unit’s power-supply cord to share an outlet with an unreasonable number of other devices. Be especially careful when using extension cords—the total power used by all devices you have connected to the extension cord’s outlet must never exceed the power rating (watts/amperes) for the extension cord. Excessive loads can cause the insulation on the cord to heat up and eventually melt through.
- Before using the unit in a foreign country, consult with your retailer, the nearest Roland Service Center, or an authorized Roland distributor, as listed on the “Information” page.
- DO NOT play a CD-ROM disc on a conventional audio CD player. The resulting sound may be of a level that could cause permanent hearing loss. Damage to speakers or other system components may result.

⚠ CAUTION

- The unit and the AC adaptor should be located so their location or position does not interfere with their proper ventilation.
- Always grasp only the output plug or the body of the AC adaptor when plugging into, or unplugging from, this unit or an outlet.
- At regular intervals, you should unplug the AC adaptor and clean it by using a dry cloth to wipe all dust and other accumulations away from its prongs. Also, disconnect the power plug from the power outlet whenever the unit is to remain unused for an extended period of time. Any accumulation of dust between the power plug and the power outlet can result in poor insulation and lead to fire.
- Try to prevent cords and cables from becoming entangled. Also, all cords and cables should be placed so they are out of the reach of children.
- Never climb on top of, nor place heavy objects on the unit.
- Never handle the AC adaptor body, or its output plugs, with wet hands when plugging into, or unplugging from, an outlet or this unit.
- Before moving the unit, disconnect the AC adaptor and all cords coming from external devices.
- Before cleaning the unit, turn off the power and unplug the AC adaptor from the outlet (p. 21).
- Whenever you suspect the possibility of lightning in your area, disconnect the AC adaptor from the outlet.
- Keep any screws you may remove and the included card theft prevention cover in a safe place out of children’s reach, so there is no chance of them being swallowed accidentally.

IMPORTANT NOTES

In addition to the items listed under “USING THE UNIT SAFELY” on page 2–3, please read and observe the following:

Power Supply

- Do not connect this unit to same electrical outlet that is being used by an electrical appliance that is controlled by an inverter (such as a refrigerator, washing machine, microwave oven, or air conditioner), or that contains a motor. Depending on the way in which the electrical appliance is used, power supply noise may cause this unit to malfunction or may produce audible noise. If it is not practical to use a separate electrical outlet, connect a power supply noise filter between this unit and the electrical outlet.
- The AC adaptor will begin to generate heat after long hours of consecutive use. This is normal, and is not a cause for concern.
- Before connecting this unit to other devices, turn off the power to all units. This will help prevent malfunctions and/or damage to speakers or other devices.

Placement

- Using the unit near power amplifiers (or other equipment containing large power transformers) may induce hum. To alleviate the problem, change the orientation of this unit; or move it farther away from the source of interference.
- This device may interfere with radio and television reception. Do not use this device in the vicinity of such receivers.
- Noise may be produced if wireless communications devices, such as cell phones, are operated in the vicinity of this unit. Such noise could occur when receiving or initiating a call, or while conversing. Should you experience such problems, you should relocate such wireless devices so they are at a greater distance from this unit, or switch them off.
- Do not expose the unit to direct sunlight, place it near devices that radiate heat, leave it inside an enclosed vehicle, or otherwise subject it to temperature extremes. Excessive heat can deform or discolor the unit.

- When moved from one location to another where the temperature and/or humidity is very different, water droplets (condensation) may form inside the unit. Damage or malfunction may result if you attempt to use the unit in this condition. Therefore, before using the unit, you must allow it to stand for several hours, until the condensation has completely evaporated.

Maintenance

- For everyday cleaning wipe the unit with a soft, dry cloth or one that has been slightly dampened with water. To remove stubborn dirt, use a cloth impregnated with a mild, non-abrasive detergent. Afterwards, be sure to wipe the unit thoroughly with a soft, dry cloth.
- Never use benzine, thinners, alcohol or solvents of any kind, to avoid the possibility of discoloration and/or deformation.

Repairs and Data

- Please be aware that all data contained in the unit’s memory may be lost when the unit is sent for repairs. Important data should always be backed up on a memory card, or written down on paper (when possible). During repairs, due care is taken to avoid the loss of data. However, in certain cases (such as when circuitry related to memory itself is out of order), we regret that it may not be possible to restore the data, and Roland assumes no liability concerning such loss of data.

Additional Precautions

- Please be aware that the contents of memory can be irretrievably lost as a result of a malfunction, or the improper operation of the unit. To protect yourself against the risk of losing important data, we recommend that you periodically save a backup copy of important data you have stored in the unit’s memory on a memory card.
- Unfortunately, it may be impossible to restore the contents of data that was stored on a memory card once it has been lost. Roland Corporation assumes no liability concerning such loss of data.

- Use a reasonable amount of care when using the unit's buttons, sliders, or other controls; and when using its jacks and connectors. Rough handling can lead to malfunctions.
- Never strike or apply strong pressure to the display.
- A small amount of noise may be heard from the display during normal operation.
- When connecting / disconnecting all cables, grasp the connector itself—never pull on the cable. This way you will avoid causing shorts, or damage to the cable's internal elements.
- To avoid disturbing your neighbors, try to keep the unit's volume at reasonable levels. You may prefer to use headphones, so you do not need to be concerned about those around you (especially when it is late at night).
- When you need to transport the unit, package it in the box (including padding) that it came in, if possible. Otherwise, you will need to use equivalent packaging materials.
- Use a cable from Roland to make the connection. If using some other make of connection cable, please note the following precautions.
 - Some connection cables contain resistors. Do not use cables that incorporate resistors for connecting to this unit. The use of such cables can cause the sound level to be extremely low, or impossible to hear. For information on cable specifications, contact the manufacturer of the cable.
- Unauthorized duplication, reproduction, hiring, and lending prohibited.
- Before you open the included CD-ROM, you must read the "license agreement." Opening the CD-ROM will be taken to mean your acceptance of the license agreement.
- The sensitivity of the D Beam controller will change depending on the amount of light in the vicinity of the unit. If it does not function as you expect, adjust the sensitivity as appropriate for the brightness of your location.
- The explanations in this manual include illustrations that depict what should typically be shown by the display. Note, however, that your unit may incorporate a newer, enhanced version of the system (e.g., includes newer sounds), so what you actually see in the display may not always match what appears in the manual.

Before Using Cards

Using DATA Cards

- Carefully insert the DATA card all the way in—until it is firmly in place.

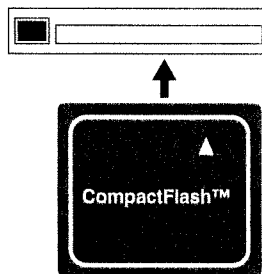



- Never touch the terminals of the DATA card. Also, avoid getting the terminals dirty.
- This unit's memory card slot accepts CompactFlash memory cards. Microdrive storage media are not compatible.
- Memory cards are constructed using precision components; handle the cards carefully, paying particular note to the following.
 - To prevent damage to the cards from static electricity, be sure to discharge any static electricity from your own body before handling the cards.
 - Do not touch or allow metal to come into contact with the contact portion of the cards.
 - Do not bend, drop, or subject cards to strong shock or vibration.
 - Do not keep cards in direct sunlight, in closed vehicles, or other such locations (storage temperature: -25 to 85° C).
 - Do not allow cards to become wet.
 - Do not disassemble or modify the cards.

Handling CD-ROMs

- Avoid touching or scratching the shiny underside (encoded surface) of the disc. Damaged or dirty CD-ROM discs may not be read properly. Keep your discs clean using a commercially available CD cleaner.

Copyright

- Unauthorized recording, distribution, sale, lending, public performance, broadcasting, or the like, in whole or in part, of a work (musical composition, video, broadcast, public performance, or the like) whose copyright is held by a third party is prohibited by law.
 - When exchanging audio signals through a digital connection with an external instrument, this unit can perform recording without being subjected to some of the restrictions of the Serial Copy Management System (SCMS). This is because the unit is intended solely for musical production, and is designed not to be subject to restrictions as long as it is used to record works (such as your own compositions) that do not infringe on the copyrights of others. (SCMS is a feature that prohibits second-generation and later copying through a digital connection. It is built into MD recorders and other consumer digital-audio equipment as a copyright-protection feature.)
 - Do not use this unit for purposes that could infringe on a copyright held by a third party. We assume no responsibility whatsoever with regard to any infringements of third-party copyrights arising through your use of this unit.
- * Microsoft and Windows are registered trademarks of Microsoft Corporation.
 - * Windows® is known officially as: "Microsoft® Windows® operating system."
 - * Apple and Macintosh are registered trademarks of Apple Computer, Inc.
 - * MacOS is a trademark of Apple Computer, Inc.
 - * Pentium is a registered trademark of Intel Corporation.
 - * All product names mentioned in this document are trademarks or registered trademarks of their respective owners.
 - * OMS is a registered trademark of Opcode Systems, Inc.
 - * FreeMIDI is a trademark of Mark of the Unicorn, Inc.
 - * VST is a trademark of Steinberg Media Technologies AG.
 - * CompactFlash and  are trademarks of SanDisk Corporation and licensed by CompactFlash association.
 - * Roland Corporation is an authorized licensee of the CompactFlash™ and CF logo () trademarks.
 - * Fugue © 2004 Kyoto Software Research, Inc. All rights reserved.



Contents

Main Features	10
Conventions Used in This Manual.....	11
An Overview of the SP-606	12
How the Various Sections Are Connected.....	12
Audio Signal Flow Inside the SP-606.....	12
How the SP-606 Is Organized	13
Playing and Performing Sounds	13
Switching the Mode (Internal/External)	15
Top, Front, and Rear Panels	16
Connecting the SP-606 to Your Equipment	20
Turning the Power On/Off	21
Turning the Power On	21
Shutting Down and Turning the Power Off.....	21
Inserting and Removing a Memory Card	22
Inserting a Memory Card	22
Removing a Memory Card after Shutdown	22
Quick Start	23
Playing Samples from the Pads	23
How to Play a Sample.....	23
Switching Pad Banks.....	23
Adjusting the Loudness of the Sound When You Strike the Pads.....	23
Playing Patterns	24
Basic Procedure for Playing a Pattern	24
Selecting and Playing a Pattern from the Pattern List	24
Changing the BPM (Tempo) During Pattern Playback	25
Muting Individual Tracks	25
The Number of Samples That Can Be Played Simultaneously.....	25
Playing an Audio Input Signal	25
Recording Your Own Samples	26
Preparations for Sampling	26
Sampling	27
Editing a Sample.....	28
Looping a Sample.....	28
Changing How the Sample Plays and Stops.....	28
Reversing the Playback.....	29
Chapter 1. Playing the Pads/Making Pad Settings	30
Playing the Pads	30
Playing a Roll	30
Using the Sub Pad Function.....	30
Using the Hold Function	30
Making Pad Settings	31
Pad Bank Protect.....	31
Basic Procedure for Pad Utility Settings	31
Pad Utility Parameters.....	31
Deleting a Sample.....	32
Using the Clipboard to Copy a Sample.....	32
Chapter 2. Using Effects	33
Basic Effect Operation.....	33
Turning Effects On/Off.....	33
Using the Control Knobs.....	33
Choosing the MFX Type from a List	33

Selecting What the Effect Will Apply to (MFX Assign).....	34
Making Mastering Settings.....	34
List of Effects.....	35
Chapter 3. Sampling	42
Available Sampling Time.....	42
Basic Sampling Procedure.....	43
Preparations for Sampling.....	43
Recording the Sample.....	44
Resampling.....	45
Applying an Effect While Resampling.....	45
Resampling (Automatic).....	46
Resampling (Manual).....	47
Using EXT SEQ SAMPLING.....	48
Sampling the Playback of an External Sequencer.....	48
Sampling a Performance from the P606.....	49
Chapter 4. Editing a Sample	50
Basic Procedure for Editing Sample Parameters.....	50
Sample Parameters.....	50
Specifying the Start/End Points of a Sample (Omitting Unwanted Portions).....	51
Changing a Sample's BPM (Tempo).....	52
Dividing a Sample (Chop).....	53
Chapter 5. Creating a Pattern	54
About Pattern Recording.....	54
Realtime Recording.....	54
Erasing Unwanted Performance Data.....	55
Step Recording.....	56
Step Recording Note Procedure.....	56
Step Recording Sample Procedure.....	57
Chapter 6. Pattern Editing.....	58
Preloaded Pattern Protect.....	58
Changing the Pattern BPM (Tempo).....	58
Storing Track Mute Settings in a Pattern.....	59
Microscope Editing.....	59
Basic Procedure for Microscope Editing.....	59
Inserting Performance Data (CREATE).....	60
Erasing Performance Data (ERASE).....	60
Moving Performance Data (MOVE).....	60
Changing the Groove of a Pattern (SWING).....	61
Naming a Pattern.....	61
Deleting a Pattern.....	62
Copying a Pattern.....	62
Chapter 7. Songs	63
Recording a Song.....	63
Basic Procedure for Recording a Song.....	63
Editing a Song.....	64
Basic Procedure for Editing a Song.....	64
Changing the Song BPM (Tempo).....	64
Naming a Song.....	64
Deleting a Song.....	65
Copying a Song.....	65
Playing a Song.....	65
Basic Procedure for Playing a Song.....	65
Selecting and Playing a Song from the Song List.....	66
Changing the Song Playback BPM (Tempo).....	66
Muting Individual Tracks.....	66

Chapter 8. Using a Memory Card	67
Formatting (Initializing) a Memory Card	67
Basic Procedure for Card Utility Operations.....	67
Card Utility Operations	68
FILE IMPORT.....	68
FILE EXPORT.....	69
BACKUP SAVE.....	70
BACKUP LOAD	70
BACKUP DELETE.....	71
Chapter 9. Using the D Beam.....	72
Using the D Beam Controller.....	72
D Beam Controller Settings.....	72
Basic Procedure for Making D Beam Settings.....	72
D Beam Setting Parameters.....	73
D BEAM INFO (D Beam Information) Screen	74
Chapter 10. About V-LINK	75
What Is V-LINK?	75
Connection Example	75
Basic V-LINK Operation.....	75
V-LINK Setup Parameters.....	76
Appendix	76
Controllable V-LINK Functions and MIDI Messages.....	76
Bank Select/Program Change Function List.....	77
Chapter 11. Using the SP-606 with Other MIDI Equipment	78
About MIDI	78
About MIDI Connectors.....	78
About the MIDI Implementation Chart	78
MIDI on the SP-606.....	78
Changing the MIDI Settings	79
Basic Procedure for MIDI Utility Settings	79
MIDI Utility Parameters.....	79
Chapter 12. System Settings	80
About the System Settings	80
Using the Included CD-ROM to Restore the Factory-Set Condition.....	80
Making System Settings	81
Checking System Information.....	82
Adjusting the Master Level.....	82
Chapter 13. About USB	83
Installing the USB Driver.....	83
Making the USB Connection.....	83
USB Audio Signal Flow	84
Making USB Audio and MIDI Settings.....	84
Copying Files or Folders via USB	85
Chapter 14. About P606.....	86
Installing P606.....	86
Controlling P606 from the SP-606	86
Before You Control P606 from the SP-606	86
List of Control Functions.....	86
Troubleshooting.....	87
Message Lists/Recommended Memory Cards.....	90
MIDI Implementation.....	92
MIDI Implementation Chart	96
Specifications.....	98

Main Features

Quick and easy sampling (p. 26, p. 42)

The SP-606 lets you use any of three sampling modes, whichever is most convenient for your situation. **EXT SEQ SAMPLING** makes it easy to capture a loop phrase of the appropriate length from an external MIDI device. With no need for settings or editing, sampling is quick and easy.

Sample from a variety of sources (p. 12, p. 84)

You can sample audio sources from the analog or digital inputs, or even via the USB connection, giving you the flexibility to use any type of source.

Use the Chop function to automatically divide phrases (p. 53)

The SP-606 provides a Chop function, which automatically divides an audio phrase into several one-shot samples. The divided samples can be rearranged randomly, combined, or used to create a virtually infinite number of variations.

Velocity-sensitive pads are ideal for creating grooves (p. 23, p. 30)

The sixteen velocity-sensitive pads are a superb way to program grooves with natural-sounding dynamics, and also offer great potential for realtime performance. In addition, pad 16 can operate as a **Sub Pad**, which remembers and plays the same sound as the previously played pad. This gives you much more freedom for performance expression, such as letting you use both hands to play rolls or repeated notes.

Four-track pattern sequencer (p. 54)

In addition to realtime input, you can use two different step-input methods: the standard **"Step Rec Note,"** in which you specify each note for input; and **"Step Rec Smpl,"** in which the length of the sample you input determines the timing of the next sample. These input methods accommodate a wide range of track-making situations.

BPM (tempo) sync capability (p. 52)

Any phrase sample can be freely made to follow the tempo of the internal sequencer. Since you can adjust the BPM in real time without affecting the pitch, you can use samples in a whole new variety of ways.

Two independent multi-effects processors (p. 33)

Forty-five types of multi-effects range from familiar standards, such as spatial effects and distortion-type effects, and also include unique effects such as **"TAPE ECHO"** and **"LO-FI PROCESSOR."** Any of these effects can be used by either of the two multi-effects modules connected in series, giving you enormous potential for creative sound-making. Intuitive knob-based control makes it easy to create bold and smooth changes in the sound.

Mastering effects for adding the finishing touch (p. 33)

Separately from the two multi-effects modules, a mastering effect module is provided to let you add finishing touches at the final stage of your song, bringing it into a professional level of sound quality.

D Beam controller and V-LINK functionality (p. 72, p. 75)

The SP-606 features a D Beam controller, which lets you control a filter or solo synthesizer simply by moving your hand. New realms of expression are made possible by V-LINK functionality, which lets you connect a compatible video device and control it to create video effects that are linked to the expressive elements of a musical performance.

Use memory cards for easy expansion (p. 67)

A memory card slot is provided on the front panel. By inserting a commercially available 512 MB CompactFlash card, you can perform up to 386 minutes of sampling (LONG mode, mono). There's no need to load the data into internal memory—data on the card can be accessed directly, even for playing from the pads. Even extremely large samples can be handled quickly and freely.

USB connection to your computer (p. 83)

The SP-606 provides not only USB-MIDI functionality, but also file transfer capability for importing and exporting .WAV and AIFF files. Audio drivers for WDM and ASIO are included, letting the SP-606 function as a versatile USB audio interface (on Windows or Macintosh) with a variety of inputs and outputs.

Dedicated "P606" software for unlimited creation of loops (p. 86)

- The dedicated P606 software application developed by Cakewalk Corporation is included. P606 consists of three different sound generator modules, sophisticated multi-effects, and a sixteen-part pattern sequencer and mixer—in other words, it's a virtual groovebox!
- Phrases you create using P606 can be captured into the USB-connected SP-606 easily and quickly via **EXT SEQ SAMPLING**. The SP-606 automatically obtains the BPM (tempo), time signature, and number of measures of the phrase, and makes the appropriate loop settings, meaning that you won't have to perform any bothersome processes after sampling.
- Of course the SP-606 also functions as a control surface for P606.

Conventions Used in This Manual

Operating buttons are enclosed by square brackets []; e.g., [ENTER].

Reference pages are indicated by (p. **).

The following symbols are used.

NOTE This indicates an important note; be sure to read it.

MEMO This indicates a memo regarding the setting or function; read it as desired.

TIP This indicates a useful hint for operation; read it as necessary.

cf. This indicates information for your reference; read it as necessary.

TERM This indicates an explanation of a term; read it as necessary.

An Overview of the SP-606

How the Various Sections Are Connected

Sampler

This records (samples) sounds, such as musical performances or vocals, and plays back these sounds.

Effects

This section applies various effects to the sampled sounds (samples). You can choose from forty-five different types of effect, such as "reverb" which adds reverberation, and "lo-fi processor" which intentionally degrades the audio quality of the sound.

Pads

You can strike these pads to play the samples. You can also vary the loudness of the sound by the strength with which you strike a pad.

Sequencer

This section lets you record the timing at which you want samples to play, and specify how the samples will be played. You can then play back this data to create automatic performances.

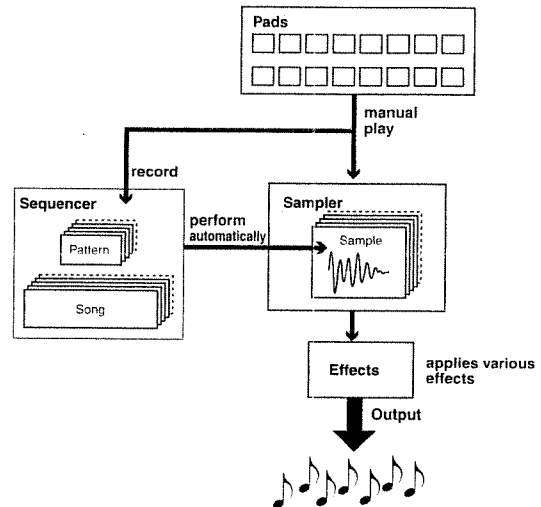

Audio Signal Flow Inside the SP-606

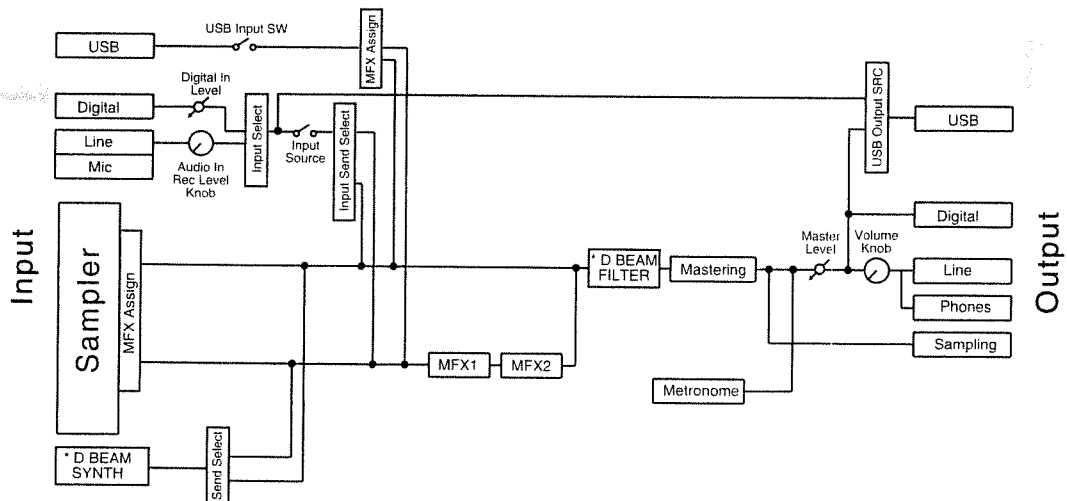

* You can use either D BEAM SYNTH or D BEAM FILTER (not both).

How the SP-606 Is Organized

The SP-606 uses four types of data: “samples” and “pad banks,” which contain sounds; and “patterns” and “songs,” which contain performance data. In addition the SP-606 operates in one of two modes: “internal mode” in which you use the SP-606’s pads and knobs to control the SP-606 itself; and “external mode,” in which the pads and knobs control the included P606 application running on your computer.

Playing and Performing Sounds

What Are Samples?

A sample is the most basic unit of audio material, consisting of a waveform (wave) that was created by sampling a performance, instrumental sound, or voice, together with settings that specify how this waveform will be played back. You can play the samples that are assigned to the pads, or play them from the internal sequencer or an external sequencer.

There are two types of samples, which differ in the way that they are played back: phrase samples and single samples.

Phrase Samples

In general, samples created by sampling a performance are called Phrase samples.

To use a sample as a phrase sample on the SP-606, set the sample’s “Play Type” (p. 50) parameter to **PHRASE**.

This causes the sample BPM (tempo) to automatically match the playback BPM or sequencer BPM.

This setting is appropriate for phrases that are one or several measures long.

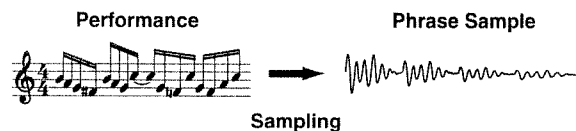

The sample BPM can be varied within the range from 0.5 through 1.3. If the sequencer BPM would cause the sample BPM to exceed this allowable range, the sample BPM will be doubled or halved so that it stays within this range.

Single Samples

On the SP-606, short samples (such as individual notes) are called Single samples. To use a sample as a single sample, set its “Play Type” (p. 50) parameter to **SINGLE**. This causes the sample to always play at its original length.

This setting is suitable for sounds that you use as single notes, such as drum hits or sound effects.



What Are Pad Banks?

A group of sixteen samples assigned to the pads of the top panel are collectively called a Pad Bank. The SP-606 has thirty-two pad banks, letting you use a total of 512 samples.

cf. Refer to "Switching Pad Banks" (p. 23).

About Pad Banks 1–8

When you sample into these banks, the samples will be saved in internal memory.

NOTE When the SP-606 is shipped from the factory, samples are already loaded into pad banks 1–4. Since these samples are protected so that they will not be erased accidentally, you will be unable to edit or delete them. If you want to disable protection for these samples, disable the pad bank protect setting (p. 31).

About Pad Banks 9–32

When you sample into these banks, the samples will be saved on a memory card.

What Are Patterns?

A pattern consists of 1–32 measures of performance (sequence) data that specifies the timing at which samples will be played. Each pattern contain four "parts" (tracks), in which separate performances can be recorded. You can select and play different patterns in succession, or create a song by specifying the order in which you want patterns to play.

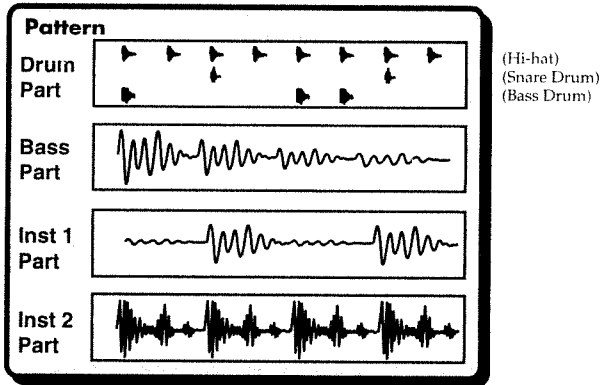

MEMO A pattern can be up to 32 measures long.

NOTE The pattern simply specifies the timing at which the samples play; it does not contain the samples themselves. This means that if you change the sample, the playback result will also change.

What Is a Song?

On the SP-606, an arrangement of multiple patterns in a desired playback order is called a Song.

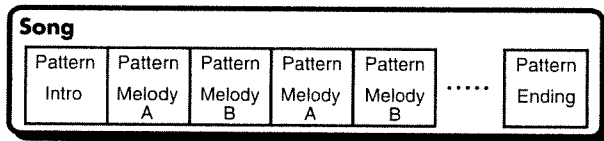

NOTE The song simply specifies the order in which patterns will play; it does not contain the sequence data of the patterns themselves. This means that if you edit a pattern, the song playback will be affected.

Switching the Mode (Internal/External)

Internal

In this mode you can use the SP-606's pads and knobs to control the SP-606 itself.
To select Internal mode, press [INT] so it's lit.

External

In this mode you can use the SP-606's pads and knobs to control the P606 application (an included sequencer for Windows) running on your USB-connected computer.
To select External mode, press [EXT] so it's lit.

TIP If you want to control both the SP-606 itself and the P606 application, press [INT] and [EXT] so both buttons are lighted.

TERM

What Is the Play Screen?

The "play screen" refers to the screen that appears when you perform the following steps.

1. Power up the SP-606 as described in "Turning the Power On/Off" (p. 21).
2. Press [INT] so it's lit.
At this time, [EXT] will be unlit.
3. Press [SONG] or [PTN].
If you press [SONG], the word "Song" will appear vertically at the left edge of the screen.
If you press [PTN], the word "Pattern" will appear vertically at the left edge of the screen.

Canceling the Previous Operation (Undo/Redo)

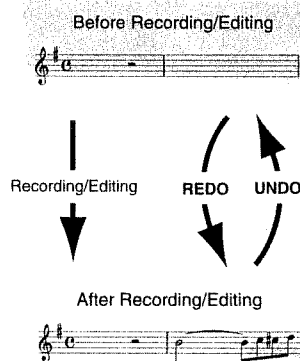

You can cancel the editing or recording operation that you performed most recently on a song or pattern.

Procedure

Hold down [FUNC] and press [⏪] (Top).

- * You can execute Undo for Pattern (microscope edit, realtime recording, step recording) and Song (edit, recording) operations.
- * The Redo function cancels the Undo, returning you to the state before executing Undo. After you've executed Undo, you can once again hold down [FUNC] and press [⏪] (Top) to execute Redo.

Top, Front, and Rear Panels

Top Panel



1

D BEAM controller

By placing your hand above this you can apply various effects to a pattern or sample. (p. 72)

TRIGGER button

This lets you use the D Beam controller to play pads as an alternative to striking the pads. (p. 72)

SYNTH button

This lets you use the D Beam controller to control the pitch of a monophonic synthesizer. (p. 72)

FILTER button

This lets you use the D Beam controller to control a filter that has an extremely steep slope. (p. 72)

2

V-LINK button

This turns V-LINK on/off. (p. 75)

3

AUDIO IN REC LEVEL knob

This adjusts the volume of the audio signal that is input via the rear panel INPUT (p. 19).

Adjust this knob so that the level indicator does not light. (p. 26, p. 44)

VOLUME knob

This adjusts the volume of the audio signal that is output from the rear panel OUTPUT and PHONES jacks (p. 19).

MASTERING button

This switches the mastering effect (used to add final touches) on/off. (p. 33)

4

Screen

Various information is shown here according to the operations you perform.

MENU button

You can press [MENU] to get the Top Menu screen.

F1, F2, F3 buttons

Various functions are assigned to these buttons depending on the currently shown screen.

BPM button

This adjusts the BPM (tempo). (p. 25, p. 58, p. 64, p. 66)

EXIT/ENTER buttons

These are used as Cancel (EXIT) or OK (ENTER) buttons in various screens.

[◀] [▶] [▲] [▼]

These move the cursor left/right/up/down in various screens.

VALUE dial

Use this to adjust the value of a setting.

* You can hold down [FUNC] and turn the VALUE dial to make larger changes in a value other than BPM (tempo).

DEC/INC buttons

These are used to change the value of a parameter (setting) in steps of one.

* You can hold down [FUNC] and use [DEC][INC] to make larger changes in a value other than BPM (tempo).

5

MXF1 button

This switches MFX1 on/off. (p. 33)

MXF2 button

This switches MFX2 on/off. (p. 33)

KNOB ASSIGN button

This selects the MFX module controlled by the CTRL 1-3 knobs. (p. 33)

CTRL 1, CTRL 2, CTRL 3 knobs

These control effect parameters. (p. 33)

6

SONG button

This accesses the Song Play screen (p. 15).

PTN button

This accesses the Pattern Play screen (p. 15).

TRACK 1-4 buttons

These select the tracks for recording/playback. (p. 25, p. 54, p. 59)

[|◀◀] (Top)

Returns to the beginning of the song or pattern.

[◀◀] (Rewind)

Moves backward by one measure or one step.

[▶▶] (Fast-forward)

Moves forward by one measure or one step.

[■] (Stop)

Stops playback.

[▶] (Play)

Starts playback.

[●] (Record)

Records a pattern or song. (p. 54, p. 63)

Top, Front, and Rear Panels

7

INT/EXT buttons

These buttons switch between Internal and External modes. Normally you will leave Internal mode selected. (p. 15)

FUNC button

You can hold down [FUNC] and press another button or pad to access an alternate function for that button or pad.

CLIP BOARD button

This button lets you use the clip board to copy a sample. (p. 32)

SAMPLING button

Use this button to perform sampling. (p. 26, p. 42)

PAD BANK button

Use this button to switch pad banks. (p. 23)

ROLL button

Use this button to play a roll. (p. 30)

HOLD pad

This pad activates the Hold function. (p. 30)

INPUT SOURCE pad

This pad sounds the audio input signal. (p. 25)

Pads [1]-[16]

You can play samples by striking these pads. (p. 23)

Front Panel

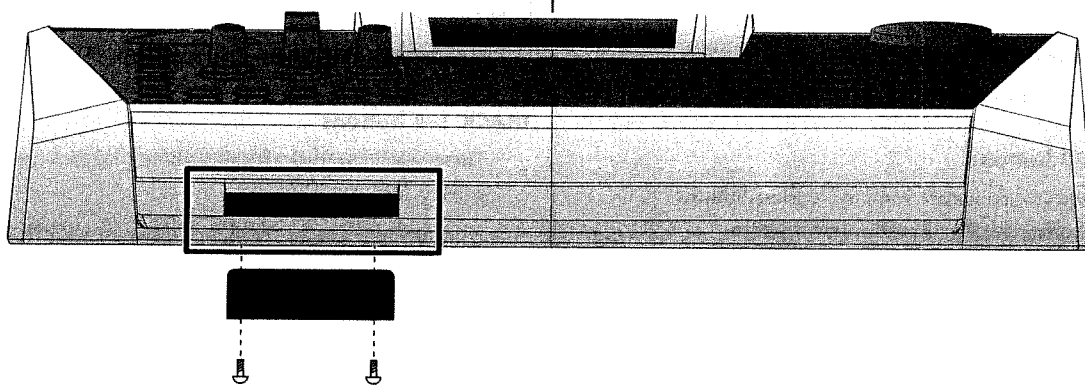

Memory card slot

You can insert a memory card here. (p. 22)

- * You can use a Phillips screwdriver to remove the two screws immediately under each end of the card slot (i.e., on the SP-606's bottom panel edge closest to yourself), and use these same two screws to attach the included card theft prevention cover. This will prevent the memory card from being removed and stolen.
- * When turning the unit upside-down, get a bunch of newspapers or magazines, and place them under the four corners or at both ends to prevent damage to the buttons and controls. Also, you should try to orient the unit so no buttons or controls get damaged.
- * When turning the unit upside-down, handle with care to avoid dropping it, or allowing it to fall or tip over.

Rear Panel

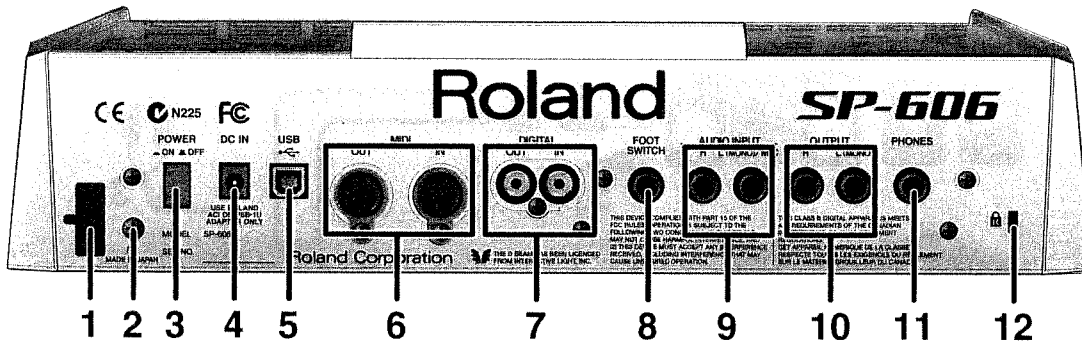

1. Cord hook

Use this to fasten the AC adaptor cable (p. 20)

2. Ground terminal

Depending on the circumstances of a particular setup, you may experience a discomforting sensation, or perceive that the surface feels gritty to the touch when you touch this device, microphones connected to it, or the metal portions of other objects. This is due to an infinitesimal electrical charge, which is absolutely harmless. However, if you are concerned about this, connect the ground terminal (see figure) with an external ground. When the unit is grounded, a slight hum may occur, depending on the particulars of your installation. If you are unsure of the connection method, contact the nearest Roland Service Center, or an authorized Roland distributor, as listed on the "Information" page.

Unsuitable places for connection

- Water pipes (may result in shock or electrocution)
- Gas pipes (may result in fire or explosion)
- Telephone-line ground or lightning rod (may be dangerous in the event of lightning)

3. POWER switch

This turns the power on/off. (p. 21)

4. AC adaptor jack

Connect the included AC adaptor here. (p. 20)

5. USB connector

Use a USB cable to connect the SP-606 to your computer. (p. 83)

6. MIDI connectors (OUT/IN)

Use these to connect MIDI equipment. (p. 78)

7. DIGITAL jacks (OUT/IN)

Connect your audio source to the IN jack if you want to sample via the digital input. Connect to the OUT jack if you want to use digital output. (p. 20)

8. FOOT SWITCH jack

You can connect a foot switch (DP-2, BOSS FS-5U; sold separately) to this jack. (p. 20)

9. INPUT jacks

Connect your audio source or microphone to this jack if you want to sample via the analog input. If you're inputting a monaural source, connect it to the L (MONO) jack. (p. 20)

10. OUTPUT jacks

These are analog output jacks. If you're outputting in monaural, use the L (MONO) jack. (p. 20)

11. PHONES jack

Connect a set of stereo headphones to this jack. Even if headphones are connected, sound will still be output from the DIGITAL OUT and OUTPUT jacks. (p. 20)

12. Security slot (K)

<http://www.kensington.com/>

Connecting the SP-606 to Your Equipment

cf. For details on USB connections, refer to "Chapter 13. About USB" (p. 83).

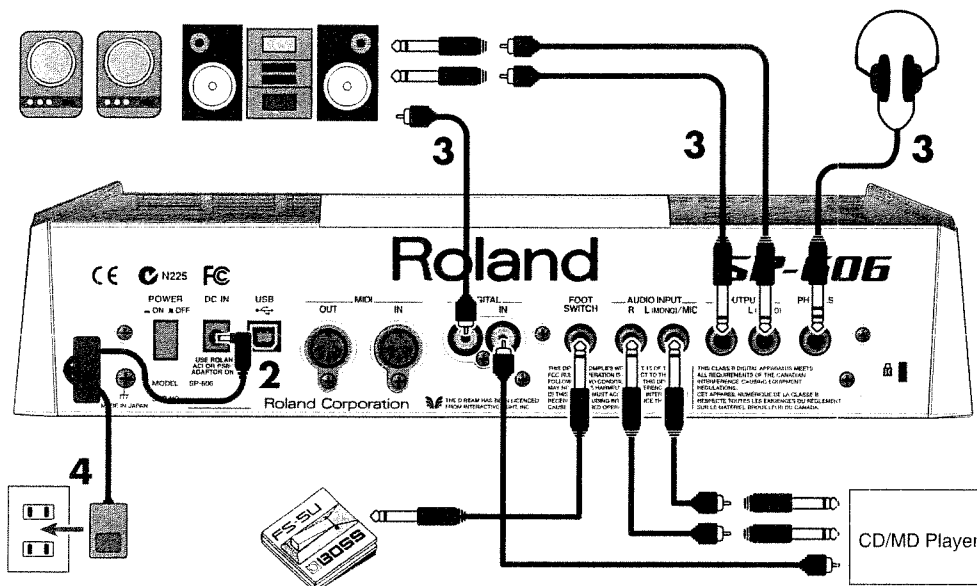

Refer to the diagram, and make connections according to the following procedure.

1. Before you make any connections, switch off the power on all your equipment.

NOTE To prevent malfunction and/or damage to speakers or other devices, always turn down the volume, and turn off the power on all devices before making any connections.

2. Connect the included AC adaptor to the AC adaptor jack.

NOTE To prevent the inadvertent disruption of power to your unit (should the plug be pulled out accidentally), and to avoid applying undue stress to the AC adaptor jack, anchor the power cord using the cord hook, as shown in the illustration.

3. Connect your audio system or amp(s) to the OUTPUT or DIGITAL OUT jacks. If you're using headphones, connect them to the PHONES jack.

If you intend to sample (p. 26, p. 42), connect your audio source device (e.g., CD player or mic) to the INPUT or DIGITAL IN jacks.

4. Plug the AC adaptor into an AC outlet.

NOTE When connection cables with resistors are used, the volume level of equipment connected to the inputs (INPUT, DIGITAL IN) may be low. If this happens, use connection cables that do not contain resistors, such as those from the Roland PCS series.

NOTE Howling could be produced depending on the location of microphones relative to speakers. This can be remedied by:

1. Changing the orientation of the microphone(s).
2. Relocating microphone(s) at a greater distance from speakers.
3. Lowering volume levels.

Turning the Power On/Off

Turning the Power On

NOTE Once the connections have been completed (p. 20), turn on power to your various devices in the order specified. By turning on devices in the wrong order, you risk causing malfunction and/or damage to speakers and other devices.

1. Turn the **VOLUME knob** all the way to the left to set the volume to the minimum position.
2. Turn the volume of the connected amp or audio system to the minimum position.
3. Press **[POWER]** to power up the SP-606.

NOTE This unit is equipped with a protection circuit. A brief interval (a few seconds) after power up is required before the unit will operate normally.

4. Power up the connected amp or audio system.
5. While striking a pad to produce sound, adjust the volume by gradually raising the **VOLUME knob**. Also raise the volume level of the connected amp or audio system to the appropriate level.

Shutting Down and Turning the Power Off

NOTE Before powering off the SP-606, you must first perform the shutdown operation. If you simply turn off the power without shutting down, the data in internal memory or the memory card may be damaged.

1. Go to the Play screen (p. 15).
2. Hold down **[FUNC]** and press **[EXIT]** (SHUTDOWN) to get the SHUTDOWN screen.

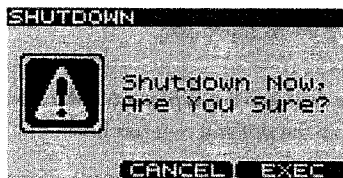

3. Press **[F3]** to shut down.
When you have returned to the Play screen, it is safe to switch off the power.
If you decide not to shut down, press **[F2]** (CANCEL).
4. Lower the volume on the SP-606 and all your external equipment so they're at the lowest possible level.
5. Switch off all your external equipment.
6. Press **[POWER]** to switch off the SP-606's power.

Inserting and Removing a Memory Card

Inserting a Memory Card

1. Insert the memory card into the card slot located on the front panel.

MEMO

You can insert a memory card whether the SP-606 is turned on or off.

NOTE

Carefully insert the Memory card all the way in-until it is firmly in place.

NOTE

When using a memory card for the first time, you must format it on the SP-606. (p. 67)
Memory cards formatted by another device will not be recognized by the SP-606.

Removing a Memory Card after Shutdown

NOTE

If the SP-606 is powered up, you must shut it down before removing the memory card. If you remove the card without shutting down, you risk damaging the internal memory or the contents of the memory card.

1. Go to the Play screen (p. 15).
2. Hold down [FUNC] and press [EXIT] (SHUTDOWN) to get the SHUTDOWN screen.

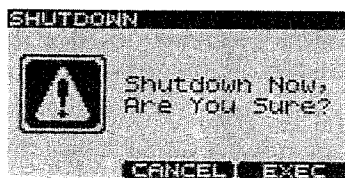

3. Press [F3] to shut down.

When you have returned to the Play screen, it is safe to remove the memory card.

If you decide not to shut down, press [F2] (CANCEL).

NOTE

After shutdown, a memory card will not be detected even if it is present in the card slot. It will be detected when you remove the memory card from the slot and re-insert it.

4. Press the eject button located beside the front panel card slot. A portion of the card will protrude, allowing you to grasp the card and pull it out.

Quick Start

Playing Samples from the Pads

How to Play a Sample

Strike a pad, and you'll hear the sample of that pad.

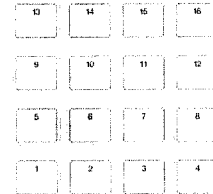

Switching Pad Banks

1. Go to the Play screen (p. 15).
2. Press [PAD BANK].
The list of pad banks will appear.
3. Turn the VALUE dial or use [▼][▲][DEC][INC] to move the cursor.
You can select pad banks 1–16 directly by pressing pads [1]–[16].
Pressing [F1] (INT) will move the cursor to the internal memory banks, and pressing [F2] (CARD) will move to the memory card banks.

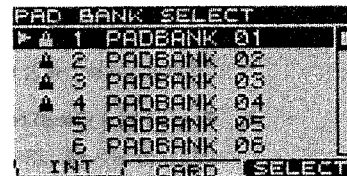

Pad banks 9–32 are for the memory card. They cannot be selected unless a memory card is inserted.

4. Press [F3] (SELECT) or [ENTER].
The selected pad bank will appear in the display.



When the SP-606 is shipped from the factory, pad banks 1–4 contain preloaded data.

Adjusting the Loudness of the Sound When You Strike the Pads

Here's how to adjust the loudness of the sounds produced when you strike the pads. This setting is common to all sixteen pads.

1. Go to the Play screen (p. 15).
2. Hold down [FUNC] and press pad [9] (PAD UTIL) to get the PAD UTILITY screen.
3. Use [▼][▲] to move the cursor to the "Pad Velocity" line.
4. Turn the VALUE dial or use [DEC][INC] to select REAL or 1–127.
REAL: The force with which you strike the pad will determine the loudness.
1–127: The loudness will be fixed at the level you specify (127 steps).
5. If you specified REAL in step 4, press [▼] to move the cursor to the "Pad Sens" line.
If you specified a value of 1–127 in step 4, proceed to step 7.
6. Turn the VALUE dial or use [DEC][INC] to select either LIGHT, MEDIUM, or HEAVY.
LIGHT: Sound will be produced even if you strike a pad lightly.
MEDIUM: This is the standard sensitivity setting.
HEAVY: You will need to strike a pad strongly in order to produce sound.
7. Press [EXIT] to return to the Play screen.

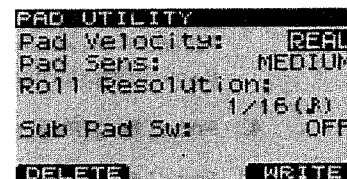

Playing Patterns

Basic Procedure for Playing a Pattern

1. Go to the Pattern Play screen (p. 15).

The upper line of the screen shows the BPM (tempo) and number of measures in the pattern.

The lower line of the screen shows the number of the currently selected pad bank.

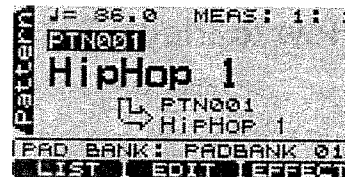

2. Turn the VALUE dial or use [DEC][INC] to select a pattern.

MEMO When the SP-606 is shipped from the factory, patterns 1–40 contain preloaded pattern data.

3. Press [▶] (Play) to begin playback.

If you turn the VALUE dial or use [DEC][INC] to select another pattern while a pattern is playing, the name of that pattern will appear in the lower line, and will be reserved as the next-played pattern. When the currently playing pattern has played to the end, the reserved pattern will automatically begin playing.

NOTE If the pattern number indication shown in the lower line is not highlighted, the SP-606 is already preparing to switch to the next pattern, so you will not be able to reserve the next pattern.

You can press [◀][▶] while a pattern is playing to force the currently playing pattern to switch.

4. Press [■] (Stop) to stop playback.

If you press [■] (Stop) once again or press [◀◀] (Top), you will return to the beginning of the pattern.

Pressing [◀◀] (Backward) moves you one measure back, while pressing [▶▶] (Forward) moves you one measure forward.

Selecting and Playing a Pattern from the Pattern List

1. Go to the Pattern Play screen (p. 15).

2. Press [F1] (LIST) to get the PATTERN LIST screen.

MEMO If the preloaded patterns are protected (p. 58), a lock symbol is shown at the left of the corresponding pattern in the screen.



3. Turn the VALUE dial or use [DEC][INC] to select a pattern, and press [F3] (SELECT) or [ENTER] to confirm your choice.

Patterns 1–16 can be selected directly by pressing pads [1]–[16].

If you decide you don't want to select a pattern, you can press [EXIT] to cancel this procedure.

4. Press [▶] (Play) to start playback.

5. Press [■] (Stop) to stop playback.

Changing the BPM (Tempo) During Pattern Playback

1. Go to the Pattern Play screen (p. 15).
2. Press [BPM] to get the BPM screen.
The current BPM is displayed.
3. Turn the VALUE dial or use [DEC][INC] to adjust the BPM (40.0–200.0).
The BPM can be adjusted in steps of one. You can make adjustments even while the pattern is playing.

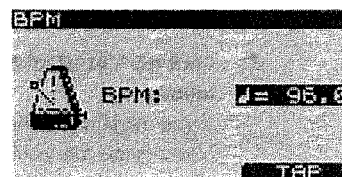

- TIP** To adjust the BPM in 0.1 units, hold down [FUNC] and turn the VALUE dial.
- TIP** You can press the [F3] (TAP) button three times or more in succession to set the BPM to the interval at which you pressed the button (Tap Tempo function).

NOTE You cannot change the BPM if "Sync Mode" (p. 79) is set to SLAVE.

4. Press [EXIT] to return to the Play screen.

Muting Individual Tracks

You can mute (silence) specific tracks while a pattern plays.

1. Go to the Pattern Play screen (p. 15).
2. Press [▶] (Play) to play the pattern.
3. Press TRACK [1]–[4].
Button lit: playing
Button blinking: muted

MEMO If a track button is unlit, that track contains no data.

TIP The mute status of each track can be stored with the pattern. (p. 59)

The Number of Samples That Can Be Played Simultaneously

Including the playback of the song/pattern and the sounds you play from the pads, a maximum of eight notes can be played simultaneously. Each stereo sample uses two notes.

If you attempt to play more than eight notes simultaneously, the samples you most recently played from the pads will take priority, and the sample played by a previously pressed pad will stop sounding. Samples whose "Play Type" (p. 50) is set to PHRASE will take priority over SINGLE samples.

Playing an Audio Input Signal

The SP-606's [INPUT SOURCE] pad lets you start/stop the sound of an external audio input source in the same way as when controlling a sample. You can also apply effects to this sound.

In the explanation below, we will use a connected CD player as an example.

1. Make sure that the SP-606 and your CD player are powered off.
2. On the top panel, turn the AUDIO IN REC LEVEL knob to the minimum position (far left).
3. Connect your CD player to the rear panel INPUT L/R or DIGITAL IN jack (p. 20).

NOTE To prevent malfunction and/or damage to speakers or other devices, always turn down the volume, and turn off the power on all devices before making any connections.

4. Power up your CD player.

5. Power up the SP-606 using the procedure described in "Turning the Power On" (p. 21).
Wait until the Pattern Play screen (p. 15) appears in the display.
6. Hold down [FUNC] and press the [INPUT SOURCE] pad to get the INPUT SETTING screen.
7. Turn the VALUE dial or use [DEC][INC] to set "Input Select" as follows.
If you made connections to INPUT L/R in step 3: LINE
If you made connections to DIGITAL IN in step 3: DIGITAL
8. Play back your CD player.
9. When you press the [INPUT SOURCE] pad so it's lighted, the external input sound will be heard.
When you press the [INPUT SOURCE] pad once again and switch off its illumination, the sound will stop.
10. Use the AUDIO IN REC LEVEL knob to adjust the volume.
Adjust the AUDIO IN REC LEVEL knob until the level is as high as you can get it without causing the knob's level indicator to light.

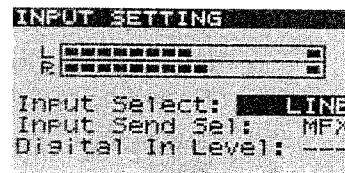

NOTE If you made connections to DIGITAL IN in step 3, the AUDIO IN REC LEVEL knob has no effect.

Recording Your Own Samples

The SP-606 lets you sample up to approximately eleven minutes of sound (monaural).

NOTE Copyright law prohibits you from recording (sampling) copyrighted audio material belonging to a third party without permission for any purpose other than personal enjoyment. Do not use this device to make illegal recordings.

NOTE Roland Corporation accepts no responsibility for any damages or penalties you may be required to pay as a result of making illegal recordings using Roland-manufactured equipment.

As an example, here's how to sample sound from a CD player.

Preparations for Sampling

Connect your CD player to the SP-606

1. Make sure that the SP-606 and your CD player are powered off.
 2. On the top panel, turn the AUDIO IN REC LEVEL knob to the minimum (far left).
 3. Connect your CD player to the rear panel INPUT L/R or DIGITAL IN jack (p. 20).
- NOTE** To prevent malfunction and/or damage to speakers or other devices, always turn down the volume, and turn off the power on all devices before making any connections.
4. Power up your CD player.
 5. Power up the SP-606 using the procedure described in "Turning the Power On" (p. 21).
Wait until the Pattern Play screen (p. 15) appears in the display.

Specify the input jack, and adjust the input level

6. Hold down [FUNC] and press [INPUT SOURCE] to get the INPUT SETTING screen.
7. Turn the VALUE dial or use [DEC][INC] to set "Input Select" as follows.
If you made connections to INPUT L/R in step 3: LINE
If you made connections to DIGITAL IN in step 3: DIGITAL

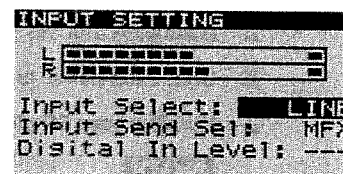

8. Play back your CD player and adjust the input level.

If you selected INPUT in step 3, adjust the AUDIO IN REC LEVEL knob until the level is as high as you can get it without causing the knob's level indicator to light.

NOTE If you made connections to DIGITAL IN, the AUDIO IN REC LEVEL knob has no effect.

Sampling

1. Press [SAMPLING] to get the SAMPLING MENU screen.

2. Press [F1] (SAMPL).

[SAMPLING] will blink, and the **SAMPLING STANDBY** screen will appear.

3. The display will indicate "Select Pad"; turn the VALUE dial or use [DEC][INC] to switch the pad bank. For this example, select pad bank 8. Then press the desired pad to select it as the sampling destination. For this example, press pad [1].

At this time, pads that do not contain samples will blink.

The pad number is displayed at the left of the upper line in the screen (PAD 8-1).

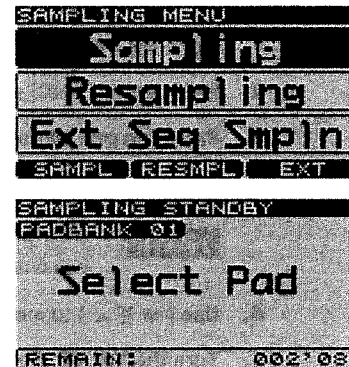

MEMO If the selected pad already contains a sample, you'll be presented with this message: "A Sample Already Exists! Overwrite?" If you are sure you want to overwrite the existing sample, press [F3] (EXEC). To cancel, press [F2] (CANCEL).

NOTE If the Pad Bank Protect setting is turned on for a bank, a lock symbol is displayed at the right of the pad bank number shown in the upper left of the screen. If you press a pad of such a bank, the screen will indicate "Protected Pad Bank!", and the pad cannot be selected. If you want to sample into a pad of this bank, you will have to turn off the Protect setting (p. 31).

4. Use [▼] [▲] to move the cursor to the "Auto Trig" line.

5. Turn the VALUE dial or use [DEC][INC] to select the OFF setting.

If you decide to cancel the sampling operation at this point, press [EXIT].

6. Press the [INPUT SOURCE] pad to hear the audio input signal.

7. At the appropriate moment in the music, press [SAMPLING] or [F3] (START) to start sampling.

[SAMPLING] will change from blinking to lit.

8. At the moment you want to stop sampling, press [SAMPLING] or [F3] (STOP).

If you exceed the available sampling time, sampling will stop automatically.

9. Press the pad to play back the sampled sound.

MEMO You can use the BPM Sync function (p. 52) to change the BPM (tempo) of the sampled sound.

cf. If the beginning or end of the sample contains unwanted sound or silence, you can make settings so that only the desired portion of the sound is actually played. For details, refer to "Specifying the Start/End Points for Playback (Skipping Unwanted Portions)" (p. 51).

cf. If you are not satisfied with the sampled sound, refer to "Deleting a Sample" (p. 32).

Editing a Sample

Looping a Sample

Causing a sample to play repeatedly from its beginning to its end is called “looping.” The SP-606 makes it easy for you create phrases by playing phrases repeatedly in this way.

1. Go to the Play screen (p. 15).
2. Hold down [FUNC] and press pad [13] (SAMPLE PARAM) to get the SAMPLE EDIT screen.
3. Press the pad whose sample you want to edit.

If you want to edit a sample that’s in a different pad bank, switch the pad bank (p. 23) and then choose a sample to edit.

NOTE If the pad bank is protected, a lock symbol is displayed in the upper right of the screen. In this case you will not be able to edit the sample unless you turn off the Protect setting (p. 31).

4. Use [▼][▲] to move the cursor to the “Loop Sw” line.
5. Turn the VALUE dial or use [DEC][INC] to select OFF or ON.

OFF: not looped

ON: looped

If you want to make settings for other samples as well, repeat steps 3–5.

6. Press [EXIT] to return to the Play screen.

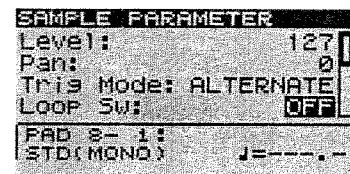

Changing How the Sample Plays and Stops

1. Go to the Play screen (p. 15).
2. Hold down [FUNC] and press pad [13] (SAMPLE PARAM) to get the SAMPLE EDIT screen.
3. Press the pad whose sample you want to edit.

If you want to edit a sample that’s in a different pad bank, switch the pad bank (p. 23) and then choose a sample to edit.

NOTE If the pad bank is protected, a lock symbol is displayed in the upper right of the screen. In this case you will not be able to edit the sample unless you turn off the Protect setting (p. 31).

4. Use [▼][▲] to move the cursor to the “Trig Mode” line.
5. Turn the VALUE dial or use [DEC][INC] to select either SHOT, ALTERNATE, or GATE.

SHOT: The sample will begin playing when you press the pad, and will stop automatically when the end of the sample is reached.

NOTE If you select the SHOT setting, the Loop setting (p. 28) is ignored; the sample will play only once. Note that if you select SHOT, you will not be able to interrupt the sound, so use this setting with caution if the sample is extremely long.

ALTERNATE: The sample will begin playing when you press the pad, and will continue playing even after you release the pad. It will stop when you press the pad once again.

GATE: The sample will begin playing when you press the pad, and will stop playing when you release the pad.

If you want to make settings for other samples as well, repeat steps 3–5.

6. Press [EXIT] to return to the Play screen.

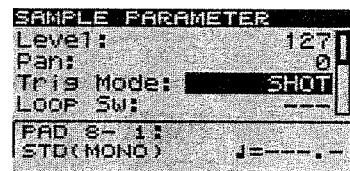

Reversing the Playback

The Reverse setting makes a sample play in the opposite direction, as if a tape were being played backward.

1. Go to the Play screen (p. 15).
2. Hold down [FUNC] and press pad [13] (SAMPLE PARAM) to get the SAMPLE EDIT screen.
3. Press the pad whose sample you want to edit.

If you want to edit a sample that's in a different pad bank, switch the pad bank (p. 23) and then choose a sample to edit.

NOTE If the pad bank is protected, a lock symbol is displayed in the upper right of the screen. In this case you will not be able to edit the sample unless you turn off the Protect setting (p. 31).

4. Use [▼][▲] to move the cursor to the "Reverse Sw" line.
5. Turn the VALUE dial or use [DEC][INC] to select OFF or ON.
OFF: not reversed
ON: reversed

If you want to make settings for other samples as well, repeat steps 3-5.

6. Press [EXIT] to return to the Play screen.

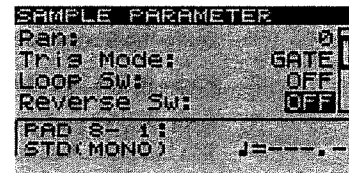

Chapter 1. Playing the Pads/Making Pad Settings

Playing the Pads



For details on basic ways to play the pads, refer to “Playing Samples from the Pads” in the Quick Start (p. 23).

Playing a Roll

Here’s how you can make a sample play repeatedly (i.e., “roll”) as long as you hold down a pad.

1. Go to the Play screen (p. 15).
2. Press [ROLL] so the button is lit; this enables the Roll function.
3. Hold down a pad, and the roll will begin.

You can play a roll by pressing any pad [1]–[16], or by pressing multiple pads simultaneously.



You can specify the resolution of the roll. Refer to “Basic Procedure for Pad Utility Settings” (p. 31) and “Pad Utility Parameters” (p. 31).

4. When you release the pad, the roll will stop.
5. To turn off the Roll function, press [ROLL] so its illumination is turned off.

Using the Sub Pad Function

You can use the Sub Pad to play the sample of the pad you struck most recently. This is a convenient way to play a drum roll manually.

1. Go to the Play screen (p. 15).
2. Hold down [FUNC] and press pad [9] (PAD UTIL) to get the PAD UTILITY screen.
3. Press [▼] to move the cursor to the “Sub Pad Sw” line.
4. Turn the VALUE dial or use [DEC][INC] to turn the setting ON.
Pad [16] will light green, and will now operate as the Sub Pad.

```
PAD UTILITY
Pad Velocity: 127
Pad Sens: MEDIUM
Roll Resolution: 1/16 (f)
Sub Pad Sw: ON
DELETE WRITE
```

NOTE This does not erase the sample of pad [16]; its original sample will reappear when you turn off the Sub Pad setting.

5. When you press pad [16], the sample of the most recently struck pad will sound.
6. If you turn the “Sub Pad Sw” OFF, pad [16] will go dark, and the Sub Pad function will be disabled.

Using the Hold Function

The Hold function makes a sample continue sounding even after you take your finger off the pad. This is convenient when you want a phrase loop sample to continue playing. However, you cannot exceed the maximum polyphony of eight notes even when using the Hold function.



Hold applies only to samples for which GATE playback (p. 50) is specified. Hold does not apply to samples for which ALTERNATE playback or SHOT playback (p. 50) is specified, nor to the Roll function (p. 30).

1. Go to the Play screen (p. 15).
2. Press a pad to play its sample.

- Before you take your finger off the pad, press the [HOLD] pad while the sample is still sounding. The Hold function will be turned on, and the sample will continue sounding even after you take your finger off the pad.
- The sound will stop when you press the currently sounding pad or the [HOLD] pad once again. When you press the [HOLD] pad again, all currently held sounds will stop.

Making Pad Settings

Pad Bank Protect

You can protect a pad bank so that it cannot be edited or erased.



When the SP-606 is shipped from the factory, you will not be able to edit or erase pad banks 1–4 since they are protected to prevent the samples from being deleted accidentally.

- Go to the Play screen (p. 15).
- Hold down [FUNC] and press [PAD BANK] to get the PAD BANK PROTECT screen. A list of the pad banks will appear.
- Turn the VALUE dial or use [▼][▲][DEC][INC] to move the cursor.
- Press [F1] (PRTCT) to turn on the Protect setting. A lock icon will appear at the left edge of the cursor line. To turn off Protect, press [F1] (PRTCT) once again. The lock icon will disappear.
- Press [EXIT] to return to the Play screen.

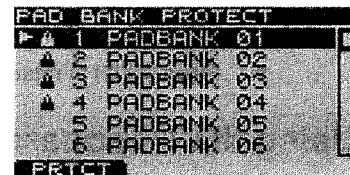

Basic Procedure for Pad Utility Settings

- Go to the Play screen (p. 15).
- Hold down [FUNC] and press pad [9] (PAD UTIL) to get the PAD UTILITY screen.
- Use [▼][▲] to select the setting (parameter) you want to edit.
- Turn the VALUE dial or use [DEC][INC] to edit the parameter value.
- Press [EXIT] to return to the Play screen.

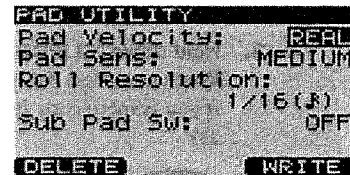

Pad Utility Parameters

Parameter	Value	Explanation
Pad Velocity	REAL, 1–127	Specifies the loudness of the sound when you strike a pad. REAL: You can vary the loudness at which the sample plays by varying the force of your pad strikes. 1–127: The sample will play at the velocity value you specify.
Pad Sens	LIGHT, MEDIUM, HEAVY	Adjusts the sensitivity of the pad. This specifies how the loudness will respond to the force of your strike. LIGHT: Even light strikes will produce loud sounds. MEDIUM: Medium sensitivity. HEAVY: There will be no sound unless you strike the pad strongly. * This setting is used only if "Pad Velocity" is set to REAL.
Roll Resolution	1/4–1/48	Specifies the resolution (interval) for the Roll function (p. 30).
Sub Pad Sw	OFF, ON	Specifies the Sub Pad setting (p. 30).

Deleting a Sample

1. Go to the Play screen (p. 15).
2. Hold down [FUNC] and press pad [9] (PAD UTIL) to get the PAD UTILITY screen.
3. Press [F1] (DELETE) to get the PAD DELETE screen.

4. Press the pad whose sample you want to delete; the pad number will be highlighted (black).

To cancel your selection, press a selected pad once again; the indication will revert to white.

You can select more than one pad simultaneously.

If you want to select samples from another pad bank, turn the VALUE dial or use [DEC][INC] to switch the pad bank, and press a pad to select a sample.

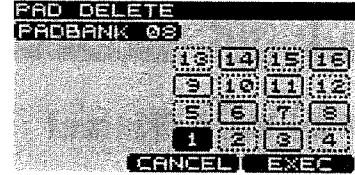

MEMO Pads that don't contain a sample are displayed as a dotted line, and cannot be selected.

5. To delete the sample(s), press [F3] (EXEC).
If you decide to cancel, press [F2] (CANCEL) or [EXIT].

NOTE Never turn off the power while the display indicates "Now Processing..."

6. Press [EXIT] to return to the Play screen.

Using the Clipboard to Copy a Sample

The Clipboard function lets you temporarily save a desired sample, which you can then copy to another location. You can also copy samples between pad banks.

1. Go to the Play screen (p. 15).
2. Hold down the pad whose sample you want to copy, and press [CLIPBOARD].

The sample will be copied to the clipboard, and [CLIPBOARD] will light. The copied sample will sound when you press [CLIPBOARD].

NOTE If you delete the copy-source sample at this time, the sample copied to the clipboard will also be deleted.

3. Hold down [CLIPBOARD] and press the copy-destination pad.
When you press [CLIPBOARD], pads that contain samples will light.
If you want to copy the sample to a different pad bank, press [PAD BANK] and select the desired pad bank (p. 23).

TIP To delete the copied sample from the clipboard, hold down [FUNC] and press [CLIPBOARD].

NOTE You cannot copy to a pad that already contains a sample.

Chapter 2. Using Effects

The SP-606 contains three built-in effect modules, which can be used simultaneously.



"MFX" stands for Multi-Effects.



Refer to "Audio Signal Flow Inside the SP-606" (p. 12).

Basic Effect Operation

Turning Effects On/Off

1. Go to the Play screen (p. 15).
2. Press [MFX1], [MFX2], or [MASTERING] to turn each effect on/off.

Lit: ON
Unlit: OFF



When you turn [MFX1] or [MFX2] on, the MFX module that you turned on will automatically become the module controlled by the CTRL 1-3 knobs.

Using the Control Knobs

Switching the MFX Module Controlled by the Control Knobs

Here's how to select whether the control knobs will control MFX1 or MFX2.

1. Go to the Play screen (p. 15).
2. Hold down [KNOB ASSIGN] to see which MFX module the knobs are controlling.
Of the [MFX1] and [MFX2] buttons, the MFX button that blinks indicates the MFX module currently controlled by the knobs.
3. Continue to hold down [KNOB ASSIGN], and press the button that is not blinking; this switches the MFX module that is controlled by the knobs.

Controlling the Effect

1. Go to the Play screen (p. 15).
2. Turn the CTRL 1-3 knobs to adjust the MFX.
3. If you want to check the currently used type of effect and its settings, press [F3] (EFFECT) to get the EFFECT INFO (Effect Information) screen.
4. Press [EXIT] to return to the Play screen.

Choosing the MFX Type from a List

1. Go to the Play screen (p. 15).
2. Press [F3] (EFFECT) to get the EFFECT INFO (Effect Information) screen.
The screen will show the MFX settings controlled by the CTRL 1-3 knobs.



You can get the same screen by holding down [FUNC] and pressing [MFX1] or [MFX2].

3. Press [F2] (MFX1/2) to switch between MFX1 and MFX2.
The upper right of the screen indicates whether MFX1 or MFX2 settings are shown.





You can exchange MFX1 and MFX2 by holding down [FUNC] and pressing [F1] (EXCHG). A message of “Exchange MFX1&2, Are You Sure?” will appear. Press [F3] (EXEC) to perform the exchange, or press [F2] (CANCEL) if you decide to cancel the operation.

- Press [F1] (LIST) to get the MFX1 TYPE LIST or MFX2 TYPE LIST screen.
- Turn the VALUE dial or use [▼][▲][DEC][INC] to select the effect type.

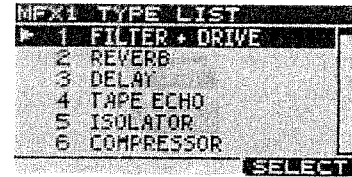

Effect types 1–16 can be selected directly by pressing pads [1]–[16].

- Press [F3] (SELECT) or [ENTER] to confirm your choice. You will return to the EFFECT INFO (Effect Information) screen. If you decide to cancel, press [EXIT].

Selecting What the Effect Will Apply to (MFX Assign)

You can select whether effects will be applied to multiple pads, to individual pads, or to the audio input via USB.

- Go to the Play screen (p. 15).
- Hold down [FUNC] and press pad [12] (MFX ASGN) to get the MFX ASSIGN screen.
- Turn the VALUE dial or use [DEC][INC] to select the pad bank for which you want to make settings.
- Press the appropriate pads to turn MFX assign on/off. The setting will alternate on/off each time you press the pad.

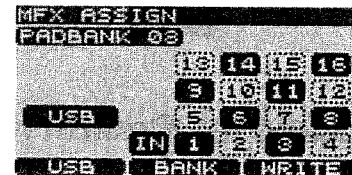

MFX is turned on for pads that are displayed in black on the screen.



You can press [F2] (BANK) to switch all sixteen pads of the pad bank on/off.

- Pressing [F1] (USB) will switch MFX assign on/off for the audio input received via USB. MFX is enabled for USB audio if the USB indication in the screen is highlighted in black.
- Press [F3] (WRITE) to save the settings. A message of “MFX Assign Write, Are You Sure?” will appear. Press [F3] (EXEC) to save the settings, or press [F2] (CANCEL) if you decide to cancel the operation.
- Press [EXIT] to return to the Play screen.

Making Mastering Settings

- Go to the Play screen (p. 15).
- Press [F3] (EFFECT) to get the EFFECT INFO (Effect Information) screen. The screen shows the settings for the MFX module being controlled by the CTRL 1–3 knobs.
- Press [F3] (MASTER) to get the MASTERING screen.

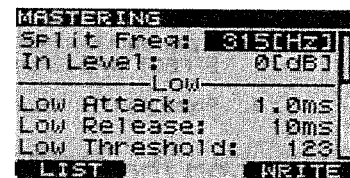

You can also get this screen by holding down [FUNC] and pressing [MASTERING].

Selecting a Mastering Setup

- Press [F1] (LIST) to get the MASTERING SETUP LIST screen.
- Turn the VALUE dial or use [▼][▲][DEC][INC] to select the mastering setup you want to use.



“1 USER SET” is selected when you turn on the power. If you want to use a certain preset setting as the power-on default, write those preset settings to “1 USER SET.”

6. Press [F3] (SELECT) or [ENTER] to confirm your choice.

You will return to the **MASTERING** screen.
If you decide to cancel, press [EXIT].

Editing the Mastering Setup**7. Use [▼] [▲] to select the parameter you want to edit.**

Turn the **VALUE** dial or use [DEC][INC] to edit the parameter value.

Parameter	Value	Explanation
Spilt Freq	200–8000Hz	Frequency at which the High and Low ranges are divided
In Level	-24–0dB	Mastering input volume
Low Attack	0.05–50ms	Time over which compression is applied to the volume after the input exceeds the Low Threshold
Low Release	0.05–2000ms	Time over which compression is released after the input falls below the Low Threshold
Low Threshold	0–127	Volume level at which compression begins to be applied to the low frequency range
Low Ratio	1:1–inf:1	Compression ratio for the low frequency range (inf: infinite)
Low Level	0–127	Output volume of the low frequency compressor
High Attack	0.05–50ms	Time over which compression is applied to the volume after the input exceeds the High Threshold
High Release	0.05–2000ms	Time over which compression is released after the input falls below the High Threshold
High Threshold	0–127	Volume level at which compression begins to be applied to the high frequency range
High Ratio	1:1–inf:1	Compression ratio for the high frequency range (inf: infinite)
High Level	0–127	Output volume of the high frequency compressor

8. If you want to save your settings, press [F3] (WRITE) to save them to “1 USER SET.”**9. The display will ask “System Write, Are You Sure?” To save your settings, press [F3] (EXEC) or [ENTER].**

If you decide not to save your settings, press [F2] (CANCEL) or [EXIT].

List of Effects

MFX	CTRL 1	CTRL 2	CTRL 3
1 FILTER + DRIVE	CUTOFF	RESO	DRIVE
This is a low pass filter with overdrive. It cuts the high-frequency range and adds distortion.	Adjusts the frequency at which the sound will be cut.	Adjusts the amount of peak (boost) applied to the region of the cutoff frequency.	Adds distortion.
2 REVERB	REV TIME	HF DAMP	E.LEVEL
This is a reverb that cuts the reverb sound midway through its decay.	Adjusts the length of the reverberation.	Adjusts the frequency at which the high-frequency portion of the reverb is cut.	Adjusts the volume of the reverb sound.
3 DELAY	DLY TIME	FEEDBACK	E.LEVEL
This is a stereo delay	Adjusts the delay length (*2)	Adjusts the proportion of the delayed sound that will be returned to the input.	Adjusts the volume of the delay sound.
4 TAPE ECHO	REPEAT	INTENS	E.LEVEL
This simulates a classic tape-type echo unit.	Adjusts the tape speed.	Adjusts the number of echo repeats.	Adjusts the volume of the echo sound.
5 ISOLATOR	LOW	MIDDLE	HIGH
Isolates or eliminates the low, mid, or high-frequency regions.	Isolates/eliminates the low-frequency range.	Isolates/eliminates the mid-frequency range.	Isolates/eliminates the high-frequency range.

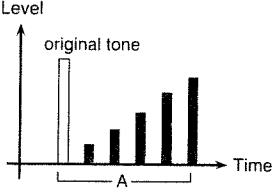
AFX	CTRL 1	CTRL 2	CTRL 3
6 COMPRESSOR Makes the sound levels more consistent.	SUSTAIN Adjusts the amount of compression.	ATTACK Adjusts the sense of attack.	LEVEL Adjusts the volume.
7 LO-FI PROCESSOR Produces a "lo-fi" sound.	SMPL RATE Adjusts the sampling rate. (*3)	BIT Adjusts the bit depth (2-14 BIT, OFF)	FILTER Adjusts the filter depth.
8 GUITAR AMP SIM Simulates a guitar amp	AMP TYPE Selects the type of guitar amp. OFF, JC-120, Clean Twin, Match Drive, BG Lead, MS1959 I, MS1959 II, MS1959 I+II, SLDN Lead, Metal 5150, Metal Lead, OD-1, OD-2 Turbo, Distortion, Fuzz	AMP VOL Adjusts the output volume.	SPEAKER Selects the speaker type. (*4)
9 OVERDRIVE Mildly distorts the sound.	DRIVE Adjusts the amount of distortion.	STONE Adjusts the tone.	LEVEL Adjusts the volume.
10 PITCH SHIFTER Changes the pitch.	PITCH Changes the pitch over a +/-2 octave range.	FEEDBACK Adjusts the amount of feedback for the pitch-shifted sound.	BALANCE Adjusts the balance between the effect sound and the direct sound.
11 FEEDBACK RIPPER This effect periodically cuts the sound and sends the cut portion to a delay. You can create new phrases by applying this effect to a phrase (e.g., drum phrase).	RATE Adjusts the interval (*2) at which the effect is applied.	DLY TIME Adjusts the delay time (*2) from when the original sound is heard until the delay sound is heard.	FEEDBACK Adjusts the proportion of delayed sound that is returned to the input.
12 REVERSE Adds a reversed copy to the original sound.	THRESHOLD Adjusts the volume level at which the reverse begins.	TIME Adjusts the delay time (*2) from when the original sound is heard until the reverse sound is heard.	BALANCE Adjusts the volume balance between the direct sound (D) and effect sound (E).
13 TUMBLING Adds a "rotating" delay sound. Particularly effective when applied to drum sounds.	TIME Adjusts Time "A" in the diagram. Level  Time	PAN Adjusts the left/right panning.	BALANCE Adjusts the volume balance between the direct sound (D) and effect sound (E).
14 FLANGER Produces a twisting modulation effect reminiscent of a jet aircraft taking off and landing.	DEPTH Adjusts the depth of modulation.	RATE Adjusts the speed of modulation.	RESO Adjusts the character of the modulation.
15 STEP FLANGER Varies the pitch of the flanger sound in stepwise fashion. The interval of the pitch change can also be specified as a note value relative to the specified tempo.	RATE Adjusts the rate of modulation.	STEP RATE Adjusts the rate (*2) of pitch change.	RESO Adjusts the character of the modulation.

MFX	CTRL 1	CTRL 2	CTRL 3
16 BPM AUTO PAN	DEPTH	RATE	WAVE
Cyclically varies the pan position of the sound in synchronization with the BPM (tempo).	Adjusts the depth of the effect.	Adjusts the rate (*2) at which the effect is applied.	Specifies how the panning will change. TRI: Triangle wave SQU: Square wave SIN: Sine wave SAW1: Sawtooth wave (ascending) SAW2: Sawtooth wave (descending)
17 AUTO PAN	DEPTH	RATE	WAVE
Cyclically varies the pan position of the sound.	Adjusts the depth of the effect.	Adjusts the rate at which the effect is applied.	Specifies how the panning will change. TRI: Triangle wave SQU: Square wave SIN: Sine wave SAW1: Sawtooth wave (ascending) SAW2: Sawtooth wave (descending)
18 BPM TREMOLO	DEPTH	RATE	WAVE
Cyclically varies the volume in synchronization with the BPM (tempo).	Adjusts the depth of the effect.	Adjusts the rate at which the effect is applied.	Specifies how the volume will change. TRI: Triangle wave SQU: Square wave SIN: Sine wave SAW1: Sawtooth wave (ascending) SAW2: Sawtooth wave (descending)
19 TREMOLO	DEPTH	RATE	WAVE
Cyclically varies the volume.	Adjusts the depth of the effect.	Adjusts the rate at which the effect is applied.	Specifies how the volume will change. TRI: Triangle wave SQU: Square wave SIN: Sine wave SAW1: Sawtooth wave (ascending) SAW2: Sawtooth wave (descending)
20 BPM SLICE+FLANG	PTN	RATE	FLANGER
Periodically cuts the sound in synchronization with the BPM (tempo). A flanger is also applied.	Specifies the timing at which the sound is cut. (*5)	Adjusts the length of the PTN (*2).	Adjusts the depth of the flanger.
21 SLICER + FLANGER	PTN	RATE	FLANGER
Periodically cuts the sound. A flanger is also applied.	Specifies the timing at which the sound is cut. (*5)	Adjusts the length of the PTN.	Adjusts the depth of the flanger.
22 ROTARY	HI RATE	LOW RATE	LEVEL
Simulates the sound of a classic rotary speaker unit. Since the operation of the high-frequency and low-frequency rotors can be specified independently, the distinctive modulation is simulated realistically.	Adjusts the rate of the high-frequency rotor.	Adjusts the rate of the low-frequency rotor.	Adjusts the output volume.
23 CHORUS	DEPTH	RATE	E.LEVEL
Adds spaciousness and depth to the sound.	Adjusts the depth of modulation.	Adjusts the rate of modulation.	Adjusts the volume of the effect sound.

MFX	CTRL 1	CTRL 2	CTRL 3
24 PHASER	DEPTH	RATE	RESO
Adds modulation to the sound.	Adjusts the depth of modulation.	Adjusts the speed of modulation.	Adjusts the character of modulation.
25 STEP PHASER	RATE	STEP RATE	RESO
Varies the pitch of the phaser sound in stepwise fashion.	Adjusts the rate of modulation.	Adjusts the rate of pitch change (*2).	Adjusts the character of modulation.
26 RING MODULATOR	FREQ	E.LEVEL	D.LEVEL
Gives the sound a metallic character.	Adjusts the pitch of the metallic sound.	Adjusts the volume of the effect sound.	Adjusts the volume of the direct sound.
27 STEREOIZER	SHIFT	BALANCE	LEVEL
Creates a pseudo-stereo effect by delaying either the left or right side of the sound. Particularly effective when applied to a monaural sound.	Adjusts the amount of delay between left and right. Negative (-) settings delay the left, and positive (+) settings delay the right side. At the center position, there is no delay.	Adjusts the volume balance between the direct sound (D) and effect sound (E).	Adjusts the output volume.
28 SPACE-D	DEPTH	RATE	BALANCE
A multi-stage chorus that applies two phases of modulation in stereo. This does not create a sense of movement, but rather a clear and transparent chorus effect.	Adjusts the depth of modulation.	Adjusts the rate of modulation.	Adjusts the volume balance between the direct sound (D) and the effect sound (E).
29 LOW BOOST	BST FREQ	BST GAIN	LEVEL
Boosts the volume of the low-frequency range to create a deeper sound.	Adjusts the frequency (50–125 Hz) at which the low-frequency range will be boosted.	Adjusts the amount of boost applied to the low-frequency range.	Adjusts the output volume.
30 EQUALIZER	LOW	MIDDLE	HIGH
Adjusts the volume of each frequency range.	Adjusts the volume of the low-frequency range.	Adjusts the volume of the mid-frequency range.	Adjusts the volume of the high-frequency range.
31 RADIO TUNING	TUNING	NOISE LV	FREQ RNG
Simulates the sound heard from a radio.	Adjusts the amount of tuning inaccuracy.	Adjusts the volume of the noise.	Adjusts the tonal character.
32 VINYL SIMULATOR	COMP	NOISE LV	WOW/F
Simulates the sound of a vinyl record.	Adjusts the sense of compression typical of an analog record.	Adjusts the volume of the noise typical of an analog record.	Adjusts the rotational instability typical of an analog record.
33 GATE	THRESHOLD	MODE	RELEASE
Uses the volume of the input source coming into the effect to cut the release portion of the reverberant sound. Use this when you want to forcibly shorten the decay of a sound.	Adjusts the volume level at which the gate begins to close.	Selects the type of gate. GATE: When the volume of the input source falls, the gate will close, cutting the input source. DUCK: When the volume of the input source rises, the gate will close, cutting the input source.	Adjusts the time from when the gate begins to close after the hold time has elapsed until it finishes closing.
34 NOISE GENERATOR	COLOR	QUALITY	LEVEL
Produces noise.	Adjusts the color (tonal character) of the “rushing” or “hissing” noise.	Adjusts how often scratch noise (as produced by scratches on a record) will appear.	Adjusts the volume of the “rushing” or “hissing” noise.
35 ENHANCER	SENS	MIX	LEVEL
Controls the overtone structure of the high-frequency range to add sparkle to the sound and improve the definition.	Adjusts the depth of the enhancer effect.	Adjusts the volume of the generated overtones.	Adjusts the output volume.

AFX	CTRL 1	CTRL 2	CTRL 3
36 DISTORTION Severely distorts the sound.	DIST Adjusts the amount of distortion.	TONE Adjusts the tone.	LEVEL Adjusts the volume.
37 FUZZ Adds new overtones to the sound, distorting it severely.	DRIVE Adjusts the amount of distortion.	TONE Adjusts the tone.	LEVEL Adjusts the volume.
38 WAH Produces a wah effect.	SENS Adjusts the sensitivity of the wah effect.	FREQ Adjusts the frequency of the effect sound.	PEAK Adjusts the peak level of the wah.
39 CENTER CANCELER Cancels sounds that are localized at the center of the sound field, such as vocals.	L-R BAL Finds the point at which the sound is cancelled most effectively.	LO BOOST Boosts the low-frequency sounds localized at the center of the sound field, such as bass.	HI BOOST Boosts the high-frequency range.
40 CHROMATIC P.S. This is a two-voice pitch shifter that lets you adjust the pitch in semitone steps.	PITCH1 Adjusts pitch 1 in semitone steps over a range of +/-1 octave.	PITCH2 Adjusts pitch 2 in semitone steps over a range of +/-1 octave.	BALANCE Adjusts the balance between the effect sound and direct sound.
41 VOICE TRANSFORMER Processes a human voice to create a variety of vocal characters.	FORMANT Adjusts the vocal formant (character).	E.LEVEL Adjusts the volume of the effect sound.	D.LEVEL Adjusts the volume of the direct sound.
42 OCTAVE Adds lower octaves to the sound.	-2OCT Adds the sound two octaves below.	-1OCT Adds the sound one octave below.	D.LEVEL Adjusts the volume of the direct sound.
43 SUBSONIC Adds a sine wave of approximately 30 Hz according to the volume of the input source coming into the effect. By adding a small amount of this to (for example) a kick drum, you can create a fatter kick sound. (*1)	THRESHOLD Adjusts the volume level at which the sine wave begins to sound.	RELEASE Adjusts the time over which the sine wave disappears when the input source falls below the threshold.	BALANCE Adjusts the volume balance between the direct sound (D) and effect sound (E).
44 OSCILLATOR(PAD) Uses DSP to simulate a synthesizer oscillator. You can use the pads to change the pitch of the oscillator. (*1) * You can create a simple DSP synthesizer by selecting "OSCILLATOR" for MFX1 and "ENVELOPER" for MFX2.	TUNE Adjusts the pitch of the oscillator sound.	OSC WAVE Selects the waveform of the oscillator. <p>TRI (Triangle wave) SAW (Sawtooth wave) PLS1 PLS2 PLS3 PLS4 PLS5 PLS6 PLS7 PLS8 PLS9 PWM = 0 : PLS1, PLS2, PLS3 PWM = light : PLS4, PLS5, PLS6 PWM = deep : PLS7, PLS8, PLS9</p>	BALANCE Adjusts the volume balance between the direct sound (D) and effect sound (E).
45 ENVELOPER(PAD) Uses DSP to simulate an envelope follower. You can use the pads to vary the envelope. (*1) * You can create a simple DSP synthesizer by selecting "OSCILLATOR" for MFX1 and "ENVELOPER" for MFX2.	CUTOFF Adjusts the cutoff frequency.	RESO Adjusts the amount of boost applied at the region of the cutoff frequency.	RELEASE Adjusts the time from when you press a pad until the maximum volume is reached.

*1: For effect types 43–45, you can hold down [FUNC] and press [F2] (SUB) to access a sub-parameter screen. The tables shown below list the parameters that appear in these screens. Press [F3] (EXIT) to return to the previous screen.

43 SUBSONIC	Value	Explanation
E.LEVEL	0–127	Adjusts the volume of the effect sound.
PITCH	0–127	Adjusts the frequency of the sine wave.
ATTACK	0–127	Adjusts the time from when the source exceeds the threshold until the sine wave is heard.

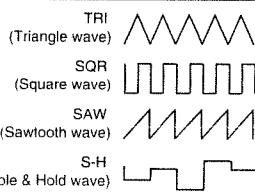
44 OSCILLATOR(PAD)	Value	Explanation
EFFECT LEVEL	0–127	Adjusts the volume of the effect sound.
PAD1 KEY	C- –G9	Adjusts the key sounded by the oscillator when you press PAD 1.
LFO RATE	0–127	An LFO is an oscillator used to apply modulation; by increasing the vibrato or PWM you can modulate the pitch or tone in a variety of ways.
LFO WAVE	SAW, TRI, SQR, S-H	 <p>TRI (Triangle wave)</p> <p>SQR (Square wave)</p> <p>SAW (Sawtooth wave)</p> <p>S-H (Sample & Hold wave)</p>
OSC TUNE	-24+24	Specifies the coarse tuning (semitone steps) of the oscillator pitch.
OSC VIB DEPTH	0–127	Adjusts the depth of vibrato (using the LFO to cyclically modulate the pitch) for the oscillator.
OSC XMOD	0–127	Adjusts the depth of cross modulation (using the SUB OSC to modulate the pitch of the oscillator).
OSC LEVEL	0–127	Adjusts the volume of OSC.
SUB OSC WAVE	SAW, TRI, PLS1–9	Selects the SUB OSC waveform. (The choices are the same as for OSC WAVE on p. 39)
SUB OSC TUNE	-24+24	Adjusts the coarse tuning (semitone steps) of the SUB OSC pitch.
SUB OSC VIB DEPT	0–127	Adjusts the depth of vibrato (using the LFO to cyclically modulate the pitch) for the SUB OSC.
SUB OSC LEVEL	0–127	Adjusts the SUB OSC volume.
RING SRC1	OSC, SUB OSC, NOISE, MFX IN	Selects the two inputs for the ring modulator. (MFX IN : MFX input source)
RING SRC2		
RING LEVEL	0–127	Adjusts the volume of the ring modulator.
NOISE LEVEL	0–127	Adjusts the volume of the noise generator.
PORTA TIME	0–100	Adjusts the time over which pitch change will occur for the portamento effect (which creates smooth transitions between pitches).

45 ENVELOPER(PAD)	Value	Explanation
ATTACK	0–127	Adjusts the time from when you release the pad until the volume falls to the minimum.
FILTER TYPE	LP (-12), BP (-12), HP (-12), LP (-24), BP (-24), HP (-24)	Low pass filter with a -12 dB slope Band pass filter with a -12 dB slope High pass filter with a -12 dB slope Low pass filter with a -24 dB slope Band pass filter with a -24 dB slope High pass filter with a -24dB slope

*2: Available note values for synchronization (In the case of delay time, the result cannot exceed approximately three seconds.)
 32nd note(♯), 16th note(♯), 8th note triplet(♯), dotted 16th note(♯), 8th note(♯), quarter note triplet(♯), dotted 8th note(♯), quarter note(♯), half note triplet(♯), dotted quarter note(♯), half note(♯), dotted half note(♯), whole note(♯)

*3: As you turn the knob toward the right, the sampling rate will change continuously over a range of 1-1/16th of 44.1 kHz.

*4: Speaker type specifications

"Speakers" indicates the diameter (in inches) and number of the speakers.

Type	Cabinet	Speakers	Mic
Off	—	—	—
Small1	Small open back	10	Dynamic
Small2	Small open back	10	Dynamic
Middle	Open back	12 x 1	Dynamic
JC-120	Open back	12 x 2	Dynamic
Built In 1	Open back	12 x 2	Dynamic
Built In 2	Open back	12 x 2	Condenser
Built In 3	Open back	12 x 2	Condenser
Built In 4	Open back	12 x 2	Condenser
Built In 5	Open back	12 x 2	Condenser
BG Stack 1	Sealed	12 x 2	Condenser
BG Stack 2	Large sealed	12 x 2	Condenser
MS Stack1	Large sealed	12 x 4	Condenser
MS Stack 2	Large sealed	12 x 4	Condenser
Metal Stack	Large double stack	12 x 4	Condenser
2 Stack	Large double stack	12 x 4	Condenser
3 Stack	Large triple stack	12 x 4	Condenser

*5: When "20 BPM SLICE+FLANG" or "21 SLICER+FLANGER" are selected, the PTN settings selected by the CTRL 1 knob are as follows.

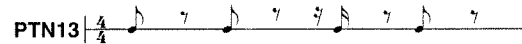
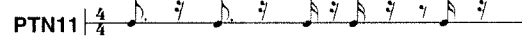
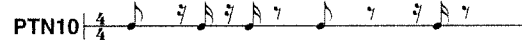
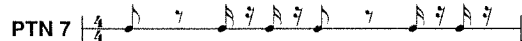
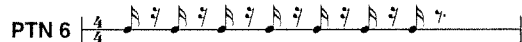
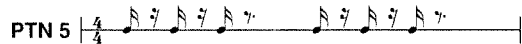
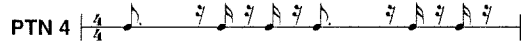
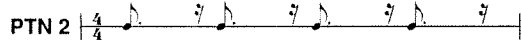
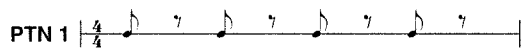

Chapter 3. Sampling

NOTE Copyright law prohibits you from recording (sampling) copyrighted audio material belonging to a third party without permission for any purpose other than personal enjoyment. Do not use this device to make illegal recordings.

NOTE Roland Corporation accepts no responsibility for any damages or penalties you may be required to pay as a result of making illegal recordings using Roland-manufactured equipment.

Available Sampling Time

The following tables show the sampling time available with internal memory and with a memory card. In the table, LONG and STANDARD indicate the Grade (p. 43) used when sampling.

The times shown below are for monaural sampling. If you sample in stereo, the available sampling time will be half as long.

Internal memory

LONG	STANDARD
Approx. 11 min.	Approx. 5 min.

Memory card

Card capacity	LONG	STANDARD
16 Mbyte	Approx. 11 min.	Approx. 5 min.
32 MByte	Approx. 24 min.	Approx. 12 min.
64 MByte	Approx. 48 min.	Approx. 24 min.
128 MByte	Approx. 1 hour, 36 min.	Approx. 48 min.
256 MByte	Approx. 3 hours, 13 min.	Approx. 1 hour, 36 min.
512 MByte	Approx. 6 hours, 26 min.	Approx. 3 hours, 13 min.

NOTE If backup data (p. 70) is saved on the memory card, the sampling time available on the memory card will be less.

Basic Sampling Procedure

Preparations for Sampling

You must perform the following steps before sampling.

Connecting your audio source device to the SP-606

1. Make sure that the SP-606 and your audio source device are powered-off.
2. Turn the top panel AUDIO IN REC LEVEL knob to the minimum (far left) setting.
3. Connect your audio source device to the rear panel INPUT or DIGITAL IN jacks (p. 20).

NOTE To prevent malfunction and/or damage to speakers or other devices, always turn down the volume, and turn off the power on all devices before making any connections.

4. Turn on the power of the device you connected in step 3.
5. Turn on the power of the SP-606, using the procedure described in “Turning the Power On” (p. 21).
Wait until the Pattern Play screen (p. 15) appears in the display.

Selecting the sampling grade

6. Press [MENU] to select “System,” and press [ENTER].
7. Use [▼] [▲] to move the cursor to the “Sampling Grade” line.
Turn the VALUE dial or use [DEC][INC] to change the setting.

```

SYSTEM
LCD Contrast: 7
Sampling Grade: STANDARD
Metro. Mode: OFF
Metronome Level: 0
Preload Ptn: WRITABLE
[CONFIG] [CTRL] [INIT]
  
```

Parameter	Value	Explanation
Sampling Grade	STANDARD, LONG	Specifies the sampling grade. STANDARD: Standard audio quality. LONG: Somewhat lower audio quality than STANDARD, but uses only half as much memory. * This setting is remembered even when the SP-606 is powered-off.

8. Press [EXIT].

Specifying the input jacks and adjusting the input level

9. Hold down [FUNC] and press [INPUT SOURCE] to get the INPUT SETTING screen.
10. Use [▼] [▲] to move the cursor to the “Input Select” line.
Turn the VALUE dial or use [DEC][INC] to change the setting.
Select one of the following according to the device you connected in step 3.

```

INPUT SETTING
L [-----]
R [-----]
Input Select: LINE
Input Send Sel: MFX
Digital In Level: ---
  
```

Connected jack	Setting
INPUT L/R (stereo)	LINE
DIGITAL IN (digital)	DIGITAL
INPUT MIC (mic)	MIC



You can also sample via USB (p. 83).

11. Use [▼] [▲] to move the cursor to the “Input Send Sel” line.
Turn the VALUE dial or use [DEC][INC] to change the setting.

Parameter	Value	Explanation
Input Send Sel	DRY	The audio input signal will not be sent to the effect.
	MFX	The audio input signal will be sent to the effect.

12. Produce sound on the device you connected in step 3, and adjust the input level.

If you connected your device to **INPUT** in step 3:

Adjust the AUDIO IN REC LEVEL knob until the level is as high as you can get it without causing the knob's level indicator to light.

If you connected your device to **DIGITAL IN** in step 3:

Adjust the "Digital In Level" within the 0–127 range as necessary.

MEMO If you connected your device to DIGITAL IN, the AUDIO IN REC LEVEL knob does nothing.

Recording the Sample



You can sample the synth sound controlled by the D Beam (p. 72).

1. Go to the Play screen (p. 15).
2. Press [SAMPLING] to get the SAMPLING MENU screen.



If P606 is running in Windows and is connected to the SP-606, and the SP-606 is in External mode (p. 15), the EXT SEQ SAMPLING STANDBY screen (p. 49) will appear.

3. Press [F1] (SAMPL). Alternatively, press [ENTER] or [SAMPLING] from the screen of step 2. [SAMPLING] will blink, and the SAMPLING STANDBY screen will appear.



In the lower line of the screen, REMAIN indicates the length (remaining time) available for new sampling. This time will change depending on the Stereo Sw (p. 44) and Sampling Grade (p. 43) setting. It is shown in minutes and seconds.

4. The display will indicate "Select Pad"; press the desired pad to select it as the sampling destination.

Turn the VALUE dial or use [DEC][INC] to switch pad banks.

At this time, pads that do not contain samples will blink.

The pad number is shown in the upper left of the screen.

(Example) PAD 8-1: pad bank 8, pad number 1



If the selected pad already contains samples, the message "A Sample Already Exists! Overwrite?" will appear. If you are sure you want to overwrite the existing sample, press [F3] (EXEC). If you decide to cancel, press [F2] (CANCEL).



If the Pad Bank Protect setting is turned on for a bank, a lock symbol is displayed at the right of the pad bank number shown in the upper left of the screen. If you press a pad of such a bank, the screen will indicate "Protected Pad Bank!", and the pad cannot be selected. If you want to sample into a pad of this bank, you will have to turn off the Protect setting (p. 31).

5. Use [▼][▲] to select the parameter you want to edit. Turn the VALUE dial or use [DEC][INC] to change the value. If you decide not to sample, press [EXIT]

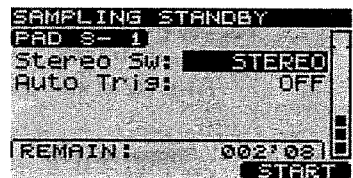
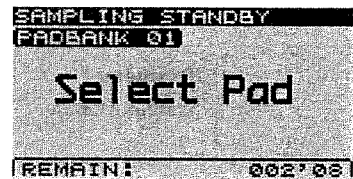

Parameter	Value	Explanation
Stereo Sw	STEREO, MONO(L+R), MONO(L)	Selects stereo or monaural recording. STEREO: Stereo recording. MONO(L+R): The left and right channels of the stereo sample will be mixed, and recorded in monaural. MONO(L): Monaural recording.
Auto Trig	OFF, 1–14	This setting causes sampling to start automatically when the audio input signal exceeds the level you specify. OFF: You will need to start sampling manually. 1–14: Sampling will start automatically when the audio input signal exceeds the specified level. Level 1 is the lowest.

6. Press [SAMPLING] or [F3] (START) to begin sampling.

[SAMPLING] will change from blinking to lit.

7. At the point where you want to stop sampling, press [SAMPLING] or [F3] (STOP).

Sampling will stop automatically if you exceed the available sampling time.

8. Press the pad to play the sampled sound.

MEMO When sampling ends, the BPM (tempo) is automatically calculated from the length of the sample. You can use the BPM Sync function (p. 52) to change this BPM setting.

cf. If the beginning or end of the sample contains unwanted sound or silence, you can make settings so that only the desired portion is played. For details, refer to “Specifying the Start/End Points of a Sample (Omitting Unwanted Portions)” (p. 51).

cf. If you want to delete a sampled sound, refer to “Deleting a Sample” (p. 32).

Resampling

TERM “Resampling” is the process of playing back one or more existing samples and re-recording (re-sampling) the result.

NOTE On the SP-606, you can resample only samples within the same pad bank.

NOTE You cannot resample using the Roll function (p. 30).

NOTE You cannot use the D Beam during resampling.

NOTE Note messages from an external MIDI device are not received during resampling.

When resampling on the SP-606, resampling can be started and stopped either automatically or manually.

Applying an Effect While Resampling

If you want to apply an effect while resampling, press [MFX1], [MFX2], or [MASTERING] so the button is lit.

cf. For details on effects, refer to “Chapter 2. Using Effects” (p. 33).

Resampling (Automatic)

Here's how up to four existing samples can be layered and recorded (resampled) as a single sample.

- Go to the Play screen (p. 15).
- Press [SAMPLING] to get the SAMPLING MENU screen.
[SAMPLING] will blink.
- Press [F2] (RESMPL) to get the RESAMPLING STANDBY screen.
 - MEMO** In the lower line of the screen, REMAIN indicates the length (remaining time) available for resampling. This time will change depending on the Stereo Sw (p. 46) and Sampling Grade (p. 43) setting. It is shown in minutes and seconds.
 - MEMO** From the screen of step 3, you can press [▼] to move the cursor to "Resampling" and then press [ENTER] or [SAMPLING] to obtain the same result.
- The display will indicate "Select Pad"; press the desired pad to select it as the resampling destination.
Turn the VALUE dial or use [DEC][INC] to switch pad banks.
At this time, pads that do not contain samples will blink.
 - MEMO** If the selected pad already contains a sample, the message "A Sample Already Exists! Overwrite?" will appear. If you are sure you want to resample into that pad, press [F3] (EXEC). If you decide to cancel, press [F2] (CANCEL).
 - NOTE** Resampling can be performed only within the same pad bank. You cannot resample within a pad bank that contains no samples. If you press a pad in an empty pad bank, the screen will indicate "Empty Pad Bank," and the pad cannot be selected.
 - NOTE** If the Pad Bank Protect setting is turned on for a bank, a lock symbol is displayed at the right of the pad bank number shown in the upper left of the screen. If you press a pad of such a bank, the screen will indicate "Protected Pad Bank!", and the pad cannot be selected. If you want to sample into a pad of this bank, you will have to turn off the Protect setting (p. 31).
- Select the resampling source pad(s).
You can select up to four pads, except for the pad you selected in step 4.
Each time you press a pad, you will alternately select or de-select it.
 - TIP** You can press [F1] (PREVU) to preview the sound that will be resampled.
 - TIP** Press [F2] (FromTo) to toggle between selection of the resampling source and destination pads. This changes the item to which the [PAD SELECT] arrow in the screen is pointing. The upper line is the resampling-destination pad, and the lower line is the resampling-source pad.
- Use [▼][▲][▶][◀] to select the parameter you want to edit.
Turn the VALUE dial or use [DEC][INC] to edit the value of the parameter.

Parameter	Value	Explanation
Velo	1-127	Specifies the volume of the sample in the resampling-source pad.
Stereo Sw	STEREO, MONO(L+R), MONO(L)	Selects stereo or monaural recording. STEREO: Stereo recording. MONO(L+R): The left and right channels of the stereo sample will be mixed, and recorded in monaural. MONO(L): Monaural recording.
Auto Trig	OFF, 1-14	This setting causes resampling to start automatically when the audio signal from the source sample(s) exceeds the level you specify. OFF: The level is not specified. 1-14: Resampling will start automatically when the source signal exceeds the specified level. Level 1 is the lowest.
- Press [F3] (START) or [SAMPLING] to begin resampling automatically.
If you decide to cancel the resampling procedure, press [EXIT].

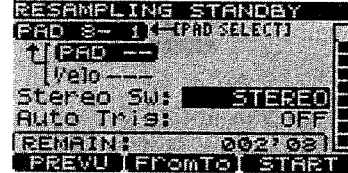

8. Resampling will end automatically, and you will return to the Play screen.

Resampling (Manual)

Here's how you can manually start and stop resampling.

1. Go to the Play screen (p. 15).
2. Press [SAMPLING] to get the SAMPLING MENU screen.
[SAMPLING] will blink.
3. Press [F2] (RESMPL) to get the RESAMPLING STANDBY screen.

MEMO In the lower line of the screen, REMAIN indicates the length (remaining time) available for resampling. This time will change depending on the Stereo Sw (p. 47) and Sampling Grade (p. 43) setting. It is shown in minutes and seconds.

MEMO From the screen of step 3, you can press [▼] to move the cursor to "Resampling" and then press [ENTER] or [SAMPLING] to obtain the same result.

4. The display will indicate "Select Pad"; press the desired pad to select it as the resampling destination.

Turn the VALUE dial or use [DEC][INC] to switch pad banks.

At this time, pads that do not contain samples will blink.

MEMO If the selected pad already contains a sample, the message "A Sample Already Exists! Overwrite?" will appear. If you are sure you want to resample into that pad, press [F3] (EXEC). If you decide to cancel, press [F2] (CANCEL).

NOTE Resampling can be performed only within the same pad bank. You cannot resample within a pad bank that contains no samples. If you press a pad in an empty pad bank, the screen will indicate "Empty Pad Bank," and the pad cannot be selected.

NOTE You cannot select the resampling-source pad(s) when resampling manually.

NOTE If the Pad Bank Protect setting is turned on for a bank, a lock symbol is displayed at the right of the pad bank number shown in the upper left of the screen. If you press a pad of such a bank, the screen will indicate "Protected Pad Bank!", and the pad cannot be selected. If you want to sample into a pad of this bank, you will have to turn off the Protect setting (p. 31).

5. Use [▼][▲] to select the parameter you want to edit.

Turn the VALUE dial or use [DEC][INC] to edit the value of the parameter.

Parameter	Value	Explanation
Stereo Sw	STEREO, MONO(L+R), MONO(L)	Selects stereo or monaural recording. STEREO: Stereo recording. MONO(L+R): The left and right channels of the stereo sample will be mixed, and recorded in monaural. MONO(L): Monaural recording.
Auto Trig	OFF, 1-14	This setting causes resampling to start automatically when the audio signal from the source sample(s) exceeds the level you specify. OFF: The level is not specified. 1-14: Resampling will start automatically when the source signal exceeds the specified level. Level 1 is the lowest.

6. Press [F3] (START) or [SAMPLING] to begin resampling.
Pads that contain samples will light.
If you decide to cancel the resampling procedure, press [EXIT].
7. Strike the pads (except the pad you selected in step 4) as desired.
8. Press [F3] (STOP) or [EXIT] to stop resampling.
You will return to the Play screen.

Using EXT SEQ SAMPLING

Sampling the Playback of an External Sequencer

1. Set your external sequencer to operate as a “MIDI slave,” and connect MIDI cables as shown below. For details, refer to the owner’s manual for your external sequencer.

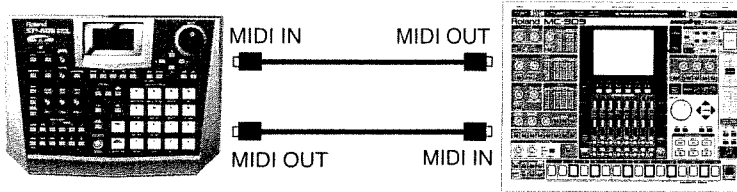

2. Perform all of the steps in “Preparations for Sampling” (p. 43), and make audio connections from your external sound source to the SP-606.
3. Go to the Play screen (p. 15).
4. Press [SAMPLING] to get the SAMPLING MENU screen. [SAMPLING] will blink.

5. Press [F3] (EXT) to get the EXT SEQ SMPL STANDBY (External Sequence Sampling Standby) screen.

MEMO In the lower line of the screen, REMAIN indicates the length (remaining time) available for further sampling. This time will change depending on the Stereo Sw (p. 48) and Sampling Grade (p. 43) setting. It is shown in minutes and seconds.

MEMO From the screen of step 3, you can press [▼] to move the cursor to “Ext Seq SmpIn” and then press [ENTER] or [SAMPLING] to obtain the same result.

6. The display will indicate “Select Pad”; press the desired pad to select it as the sampling destination.

Turn the VALUE dial or use [DEC][INC] to switch pad banks.

At this time, pads that do not contain samples will blink.

The upper line of the screen indicates the “pad bank number - pad number.”

MEMO If the selected pad already contains a sample, the message “A Sample Already Exists! Overwrite?” will appear. If you are sure you want to sample into that pad, press [F3] (EXEC). If you decide to cancel, press [F2] (CANCEL).

NOTE If the Pad Bank Protect setting is turned on for a bank, a lock symbol is displayed at the right of the pad bank number shown in the upper left of the screen. If you press a pad of such a bank, the screen will indicate “Protected Pad Bank!”, and the pad cannot be selected. If you want to sample into a pad of this bank, you will have to turn off the Protect setting (p. 31).

7. Use [▼][▲] to select the parameter that you want to edit.

Turn the VALUE dial or use [DEC][INC] to edit the parameter value.

Parameter	Value	Explanation
Stereo Sw	STEREO, MONO(L+R), MONO(L)	Selects stereo or monaural recording. STEREO: Stereo recording. MONO(L+R): The left and right channels of the stereo sample will be mixed, and recorded in monaural. MONO(L): Monaural recording.
Auto Trig	OFF, 1–14	This setting causes resampling to start automatically when the audio signal from the source sample(s) exceeds the level you specify. OFF: The level is not specified. 1–14: Resampling will start automatically when the source signal exceeds the specified level. Level 1 is the lowest.
BPM	40.0–200.0	Specifies the BPM (tempo).
Beat	1–999	Specifies the number of beats

Parameter	Value	Explanation
Meter	1/2-19/2, 1/4-19/4, 1/8-19/8, 1/16-19/16	Specifies the time signature.

8. Press [F3] (START) or [SAMPLING]; sampling will begin automatically.
If you decide to cancel sampling, press [EXIT].
9. Sampling will end automatically, and you will return to the Play screen.

Sampling a Performance from the P606

1. Connect the SP-606 via USB to the P606 running in Windows (p. 83).
2. Press [EXT] so it's lit, and External mode (p. 15) is selected.
3. Press [SAMPLING]. The EXT SEQ SMPL STANDBY (External Sequence Sampling Standby) screen will appear.
[SAMPLING] will blink.

MEMO In the lower line of the screen, REMAIN indicates the length (remaining time) available for further sampling. This time will change depending on the Stereo Sw (p. 49) and Sampling Grade (p. 43) setting. It is shown in minutes and seconds.

4. The display will indicate "Select Pad"; press the desired pad to select it as the sampling destination.
Turn the VALUE dial or use [DEC][INC] to switch pad banks.
At this time, pads that do not contain samples will blink.
The upper line of the screen indicates the "pad bank number - pad number."

MEMO If the selected pad already contains a sample, the message "A Sample Already Exists! Overwrite?" will appear. If you are sure you want to sample into that pad, press [F3] (EXEC). If you decide to cancel, press [F2] (CANCEL).

NOTE If the Pad Bank Protect setting is turned on for a bank, a lock symbol is displayed at the right of the pad bank number shown in the upper left of the screen. If you press a pad of such a bank, the screen will indicate "Protected Pad Bank!", and the pad cannot be selected. If you want to sample into a pad of this bank, you will have to turn off the Protect setting (p. 31).

5. Use [▼][▲] to select the parameter that you want to edit.
Turn the VALUE dial or use [DEC][INC] to edit the parameter value.

Parameter	Value	Explanation
Stereo Sw	STEREO, MONO(L+R), MONO(L)	Selects stereo or monaural recording. STEREO: Stereo recording. MONO(L+R): The left and right channels of the stereo sample will be mixed, and recorded in monaural. MONO(L): Monaural recording.
Auto Trig	OFF, 1-14	This setting causes resampling to start automatically when the audio signal from the source sample(s) exceeds the level you specify. OFF: The level is not specified. 1-14: Resampling will start automatically when the source signal exceeds the specified level. Level 1 is the lowest.

MEMO BPM, Beat, and Meter values are obtained automatically from the P606, so you don't need to edit these values.

6. Press [F3] (START) or [SAMPLING]; sampling will begin automatically.
If you decide to cancel sampling, press [EXIT].
7. Sampling will end automatically, and you will return to the Play screen.

Chapter 4. Editing a Sample

Basic Procedure for Editing Sample Parameters

1. Go to the Play screen (p. 15).
2. Hold down [FUNC] and press pad [13] (SAMPLE PARAM) to get the SAMPLE EDIT screen.

The number of the pad you press in step 3 is shown at the lower left of the screen.

(Example) PAD 8-1: pad bank 8, pad number 1

The name, grade (STD/LNG, p. 43), monaural/stereo (MONO/STEREO), and BPM (tempo) of the sample are shown in the bottom line of the screen.

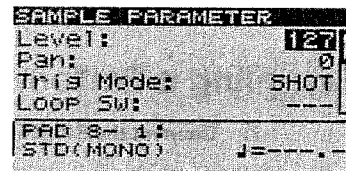

3. Press the pad containing the sample whose settings you want to edit.

If you want to select a sample from a different pad bank, switch the pad bank (p. 23) and then press a pad to select a sample.

NOTE You can't edit samples of a pad bank that is protected (p. 31).

4. Use [▼] [▲] to select the parameter you want to edit.
5. Turn the VALUE dial or use [DEC][INC] to edit the value of the parameter.
If you want to edit the parameters of other samples, repeat steps 3–5.
6. Press [EXIT] to return to the Play screen.

Sample Parameters

Parameter	Value	Explanation
Level	0–127	Adjusts the volume of the sample.
Pan	L15– 0 –15R, RND	Adjusts the pan (left/right) balance of the sample. L15: Far left. 0: Center R15: Far right. RND: The panning will change randomly each time the sound is played. * This cannot be specified for samples recorded in stereo.
Trig Mode	SHOT, ALTERNATE, GATE	Specifies how the sample will start and stop sounding. SHOT: The sample will sound each time you strike the pad. ALTERNATE: The sample will alternately sound or stop each time you strike the pad. GATE: The sample will sound only while you hold down the pad.
Loop Sw	OFF, ON	Specifies whether sample playback will loop (repeat).
Reverse Sw	OFF, ON	Specifies whether sample playback will be reversed (backward playback).
Mute Group	OFF, 1–8	Pads assigned to the same number are placed in a "mute group." Within the identically numbered mute group, only the last-struck sound will play; the previous sound will be turned off.
Assign	MONO, POLY	Specifies whether the sample will be played monophonically or polyphonically. MONO: A repeated strike will silence the preceding note before the new note is sounded. POLY: A repeated strike will sound a new note while the preceding note continues to be heard.
Play Type	SINGLE, PHRASE	Specifies whether the sample will be played as a single sample or a phrase sample. SINGLE: The sample will be played as a single sample (one note); it will always play at its own BPM (tempo). PHRASE: The sample will be played as a phrase. During playback, the BPM of the sample will automatically match the BPM setting or the BPM of the sequencer. -> "Changing a Sample's BPM (Tempo)" (p. 52)

Parameter	Value	Explanation
Beat	1/4–8/4	Specifies the time signature of the sample. * When you change the time signature, the BPM of the sample is automatically recalculated. For example, if you double the time signature value, the BPM will also double. * You cannot change this in a way that would cause the sample's BPM to exceed the range of 40.0–200.0. * This cannot be set if "Play Type" is SINGLE.
Measure	1/128–1/2, 1–99998	Specifies the number of measures in the sample. * When you change the number of measures, the BPM of the sample is automatically recalculated. For example, if you double the number of measures, the BPM will also double. * You cannot change this in a way that would cause the sample's BPM to exceed the range of 40.0–200.0. * This cannot be set if "Play Type" is SINGLE.

Specifying the Start/End Points of a Sample (Omitting Unwanted Portions)

1. Go to the Play screen (p. 15).
2. Hold down [FUNC] and press pad [14] (SAMPLE LOOP EDIT) to get the SAMPLE LOOP EDIT screen.



In the case of a stereo sample, only one of the L/R channels is displayed.



You can switch between L and R channels by holding down [FUNC] and pressing [▼] or [▲].

The number of the pad you press in step 3 is shown in the upper left of the screen.

(Example) PAD 8-1: pad bank 8, pad number 1

The lower right of the screen indicates the location of the wave pointer in terms of a number of samples.

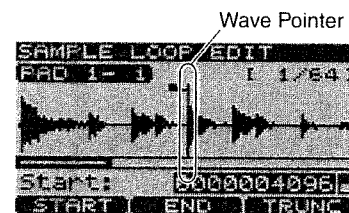

3. Press the pad whose sample you want to edit.
If you want to select a sample from a different pad bank, switch the pad bank (p. 23) and then press a pad to select a sample.
4. Press [F1] (START) and then turn the VALUE dial or use [DEC][INC] to move the wave pointer to the point where you want the sound to start.



You can't edit samples in a pad bank that is protected (p. 31).

Press [▼] or [▲] to magnify/reduce the display vertically (amplitude axis).
Press [◀] or [▶] to magnify/reduce the display horizontally (time axis).
Hold down [FUNC] and press [◀] or [▶] to scroll left or right.

5. Press [F2] (END) and then turn the VALUE dial or use [DEC][INC] to move the wave pointer to the point where you want the sound to end.

Press [▼] or [▲] to magnify/reduce the display vertically (amplitude axis).
Press [◀] or [▶] to magnify/reduce the display horizontally (time axis).
Hold down [FUNC] and press [◀] or [▶] to scroll left or right.



You cannot set the Start and End points in a way that would cause the start/end duration to be shorter than approximately 70 ms.

6. Press the pad to play the sample and check the Start and End points you specified.
If you want to edit the Start or End point again, repeat steps 4 or 5.

- Press [F3] (TRUNC). A message “Truncate, Are You Sure?” will ask you whether you are sure you want to truncate (delete) the portions of the sample that are outside the specified Start and End points. To truncate the sample, press [F3] (EXEC). If you decide to cancel, press [F2] (CANCEL).

MEMO Executing the Truncate operation will conserve sample memory, increasing the sampling time that remains.

NOTE Once you execute Truncate, you cannot return to the Start and End points prior to execution.

- Press [EXIT] to return to the Play screen.

Changing a Sample's BPM (Tempo)

- Go to the Play screen (p. 15).
- Hold down [FUNC] and press pad [15] (BPM SYNC) to get the BPM SYNC screen.

The number of the pad you press in step 3 is shown in the upper left of the screen.

(Example) PAD 8-1: pad bank 8, pad number 1

The lower left of the screen shows the “Play Type” (p. 50) and BPM.

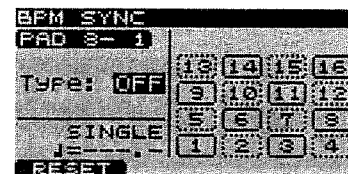

- Press the pad whose sample settings you want to edit.

If you want to select a sample from a different pad bank, switch the pad bank (p. 23) and then press a pad to select a sample.

NOTE You can't edit samples of a pad bank that is protected (p. 31).

- Turn the VALUE dial or use [DEC][INC] to change the “Type” setting.

Parameter	Value	Explanation
Type	OFF	The sample will play at its own BPM.
	SEQ	The sample will synchronize to the BPM of the song or pattern. Press [▼] to move to the line below, and turn the VALUE dial or use [DEC][INC] to select ALWAYS or PLAY ONLY. ALWAYS: The sample will synchronize whether during playback or while stopped. PLAY ONLY: The sample will synchronize only during playback.
	FIX	Specify an individual BPM for the sample. Press [▼] to move to the line below, and turn the VALUE dial or use [DEC][INC] to change the BPM value (40.0–200.0).

- If you want to change the BPM for a sample of a different pad, repeat steps 3 and 4.

Pads set to a setting of other than OFF in step 4 will be highlighted.

TIP By pressing [F1] (RESET) you can set “Type” to OFF for all pads in the currently selected pad bank.

MEMO The BPM of a sample can be adjusted in a range of 0.5–1.3 times. If synchronization would cause the sample BPM to exceed this range, the sample BPM will be doubled or halved to stay within the range.

NOTE Changing the BPM may cause noise to be more noticeable.

NOTE The BPM cannot be changed if the sample is shorter than approximately 200 ms.

NOTE The BPM cannot be changed if the “Play Type” (p. 50) is SINGLE.

NOTE The BPM cannot be changed for samples set to Reverse playback (p. 50).

- Press [EXIT] to return to the Play screen.

Dividing a Sample (Chop)

The Chop function automatically divides the sample of the currently selected pad into several samples, according to the Level (threshold value) you specify. The sample can be chopped into a maximum of sixteen samples.

NOTE For some phrases, such as those that contain many notes or simultaneously played notes, it may not be possible to divide the sample appropriately.

1. Go to the Play screen (p. 15).
2. Hold down [FUNC] and press pad [16] (CHOP) to get the CHOP screen.

The sample waveform is displayed.

MEMO For a stereo sample, only the L or R channel is shown.

TIP To switch between L and R channels, hold down [FUNC] and press [▼] or [▲].

Hold down [FUNC] and press [◀] or [▶] to scroll left or right.

Press [▼] or [▲] to magnify/reduce the display vertically (amplitude axis).

Press [◀] or [▶] to magnify/reduce the display horizontally (time axis).

The number of the pad you press in step 3 is shown in the upper left of the screen.

(Example) PAD 8-1: pad bank 8, pad number 1

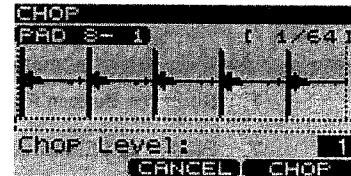

3. Press the pad whose sample you want to chop.
If you want to select a sample from a different pad bank, switch the pad bank (p. 23) and then press a pad to select a sample.
4. Turn the VALUE dial or use [DEC][INC] to change the "Level" setting (1–10).
This specifies the level (threshold) at which the sample will be chopped. Lower settings will cause the sample to be chopped more finely.
5. Press [F3] (CHOP) to chop the sample.
Press the pads to hear the result. The samples resulting from the Chop operation are assigned to consecutive pads starting with pad [1].
If you decide to cancel, press [F2] (CANCEL).
6. To save the results, press [F3] (EXEC). The CHOP SAMPLE WRITE screen will appear.
Use [▼] || [▲] to select the pad bank in which the chopped samples will be saved, and press [F3] (WRITE) or [ENTER].
If you want to try the Chop operation over again, press [F2] (UNDO).

MEMO If the pad bank you selected as the save destination already contains samples, the message "The Pad Bank Contains Samples! Overwrite?" will appear. If you are sure you want to overwrite the existing samples, press [F3] (EXEC) or [ENTER]. If you decide to cancel, press [F2] (CANCEL) or [EXIT].

NOTE Never turn off the power while the display indicates "Now Processing..."

Chapter 5. Creating a Pattern

About Pattern Recording

You can create original patterns by recording your performance on the pads.

A pattern can be recorded in either of the following two ways.

Realtime Recording

In this method you strike the pads to record them while the pattern plays. The pattern will continue repeating, and the data you input (i.e., your pad strikes) will be added to the pattern.

Even if your timing is not perfect, you can use the Quantize function to tighten up the timing. You can also input from an external MIDI device as well as from the pads.

Step Recording

In this method you input notes one by one, in “non-realtime.”

Realtime Recording

1. Go to the Pattern Play screen (p. 15).
2. Press [●] (Record) to get the RECORDING MENU screen.
[●] (Record) will blink.
3. Press [F1] (REALTM) to get the REALTIME REC STANDBY (Realtime Recording Standby) screen.

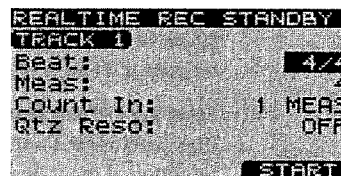

MEMO Alternatively, you can get the same result from the screen of step 2 by moving the cursor to “Realtime Rec” and pressing [ENTER] or [▶] (Play).

4. Press TRACK [1]–[4] to select the track on which you intend to record.
The button you press will blink, and the track number will appear in the upper left of the screen.

TIP You can also change tracks while recording.

5. Use [▼] [▲] to select the parameter you want to set.
Turn the VALUE dial or use [DEC][INC] to set the parameter value.

Parameter	Value	Explanation
Beat	1/4–32/4	Specifies the time signature. * This cannot be changed for patterns that already contain data.
Meas	1–32	Specifies the number of measures. * This cannot be shortened for patterns that already contain data.
Count In	OFF, 1 MEAS, 2 MEAS, WAIT NOTE	Specifies a count-in (unrecorded region). OFF : No count-in. 1 MEAS : One-measure count-in. 2 MEAS : Two-measure count-in. WAIT NOTE : Recording will begin when you press [▶] (Play) or strike a pad.
Qtz Reso	OFF, 1/32, 1/24, 1/16, 1/12, 1/8, 1/6, 1/4	Specifies the quantize resolution (p. 54). * You can also change this while recording.

TIP You can use a slower tempo for easy input, and then revert to the desired tempo after you’ve recorded the data.

If you decide to discontinue, press [EXIT].

6. Press [F3] (START) or [▶] (Play) to begin REALTIME RECORDING.

If you specified a “Count In” (p. 54) of 1 MEAS or 2 MEAS, a count-in (unrecorded region) will be inserted. Realtime recording will begin after the count-in. The screen will show the current measure and beat.



If you press [F2] (REHRSL), the screen will indicate “Rehearsal,” and you will be in Rehearsal mode; you will hear sound when you press a pad, but nothing will be recorded. Press [F2] (REHRSL) once again to exit Rehearsal mode.



If you want to select pads from a different pad bank, press [PAD BANK] and change the pad bank (p. 23).



A Start message from an external MIDI device can also be used to initiate recording.



If a Start message from an external MIDI device is used to initiate recording, a count-in will not be inserted.



If you send note messages from an external MIDI device to play samples, those note messages will also be recorded.

7. Press [■] (Stop) to stop recording.

You will return to the Play screen.



You can execute Undo/Redo by holding down [FUNC] and pressing [◀◀] (Top) (p. 15).

Erasing Unwanted Performance Data

1. During realtime recording (i.e., in step 6 of “Realtime Recording,” p. 55), press [F1] (ERASE) to get the REALTIME ERASE screen.**2. Press [F2] (ERASE) or a pad to erase the unwanted performance data.**

If you press [ERASE], all performance data during the time you hold down [ERASE] will be erased.

If you press a pad [1]–[16], the performance data of that pad will be erased during the time you hold down that pad.

3. Press [EXIT] to return to the REALTIME RECORDING screen.

Step Recording

There are two types of step recording; “step recording note,” where you specify the length of the notes to input, and “step recording sample,” where input will proceed in steps equal to the actual length of the samples.

Step Recording Note Procedure

1. Go to the Pattern Play screen (p. 15).
2. Press [●] (Record) to get the RECORDING MENU screen.
[●] (Record) will blink.
3. Press [F2] (NOTE) to get the STEP REC NOTE STANDBY (Step Recording Note Standby) screen.

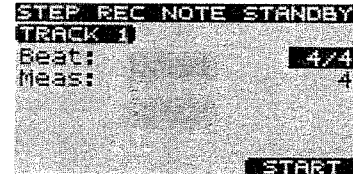

MEMO Alternatively, you can get the same result from the screen of step 2 by pressing [▼] to move the cursor to “Step Rec Note” and pressing [ENTER].

4. Press TRACK [1]–[4] to select the track on which you intend to record.
The button you press will blink, and the track number will appear in the upper left of the screen.
5. Use [▼] [▲] to select the parameter you want to set.
Turn the VALUE dial or use [DEC][INC] to set the parameter value.

Parameter	Value	Explanation
Beat	1/4–32/4	Specifies the time signature. * This cannot be changed for patterns that already contain data.
Meas	1–32	Specifies the number of measures. * This cannot be shortened for patterns that already contain data.

6. Press [F3] (START) to get the STEP RECORDING NOTE screen.
The upper line of the screen shows the “measure-beat-tick” at which the note will be input.
7. Use [▼] [▲] to select the parameter you want to set.
Turn the VALUE dial or use [DEC][INC] to set the parameter value.

Parameter	Value	Explanation
Step Time	1/32–1/1	Specifies the note length (note value).
Velocity	REAL, 1–127	Specifies the volume. With the REAL setting, this will be the actual force with which you strike the pad.
Gate Time	1–200%	Specifies the note duration as a proportion of the Step Time.

8. Strike the pad that contains the sample you want to input.
If you want to use a sample from a different pad bank, press [PAD BANK] and switch the pad bank (p. 23).
Press [F1] (TIE) to create a tie from the previously input note.
Press [F2] (REST) to input a rest.
Press [F3] (BACK) to delete the previously input note.
9. Repeat steps 7–8 to input more notes as desired.
10. Press [■] (Stop) to return to the Play screen.

TIP You can execute Undo/Redo by holding down [FUNC] and pressing [⏪] (Top) (p. 15).

Step Recording Sample Procedure

1. Go to the Pattern Play screen (p. 15).
2. Press [●] (Record) to get the RECORDING MENU screen.
[●] (Record) will blink.
3. Press [F3] (SMPL) to get the STEP REC SAMPLE STANDBY (Step Recording Sample Standby) screen.

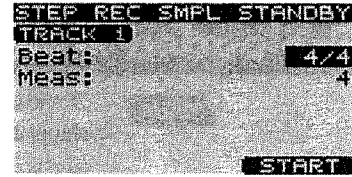

MEMO Alternatively, you can get the same result from the screen of step 2 by pressing [▼] to move the cursor to “Step Rec Smpl” and pressing [ENTER].

4. Press TRACK [1]–[4] to select the track on which you intend to record.
The button you press will blink, and the track number will appear in the upper left of the screen.
5. Use [▼] [▲] to select the parameter you want to set.
Turn the VALUE dial or use [DEC][INC] to set the parameter value.

Parameter	Value	Explanation
Beat	1/4–32/4	Specifies the time signature. * This cannot be changed for patterns that already contain data.
Meas	1–32	Specifies the number of measures. * This cannot be shortened for patterns that already contain data.

6. Press [F3] (START) to get the STEP RECORDING screen.
The upper line of the screen shows the “measure-beat-tick” at which the sample will be input.
Available pads (i.e., that contain samples) will light.
7. Turn the VALUE dial or use [DEC][INC] to edit the “Velocity” value.

Parameter	Value	Explanation
Velocity	REAL, 1–127	Specifies the volume. With the REAL setting, this will be the actual force with which you strike the pad.

8. Strike the pad that contains the sample you want to input.
The pad operation will be recorded.
If you want to use samples from a different pad bank, press [PAD BANK] and switch the pad bank (p. 23).
You can press [F3] (BACK) to delete the previously input sample.
9. Repeat steps 7–8 to input more samples as desired.
10. Press [■] (Stop) to return to the Play screen.

TIP You can execute Undo/Redo by holding down [FUNC] and pressing [◀◀] (Top) (p. 15).

Chapter 6. Pattern Editing

Preloaded Pattern Protect

TERM

“Preloaded patterns” are the patterns that are loaded into internal memory when the SP-606 is shipped from the factory. Patterns 1–40 are preloaded. If the preloaded patterns are protected, a lock icon is displayed at the left of the screen for the corresponding patterns in the pattern list (p. 24).

NOTE

When the SP-606 is shipped, the Protect setting is turned on for the preloaded patterns. If you attempt to edit or delete a preloaded pattern in this state, the message “Protected!” will appear, and you will be unable to edit or delete the pattern unless you turn off the Protect setting.

1. Go to the Pattern Play screen (p. 15).
2. Press [MENU] to get the Top Menu screen.
3. Move the cursor to the “1:SYSTEM” line, and press [ENTER].
The SYSTEM screen will appear.
4. Press [F1] (CONFIG).
5. Press [▼] to move the cursor to the “Preload Ptn” line.
6. Turn the VALUE dial or use [DEC][INC] to change the setting to WRITABLE.
Preloaded pattern protection will be turned off.
If you don’t want to edit or delete the preloaded patterns, leave this setting at PROTECT.
7. Press [EXIT] to return to the Play screen.

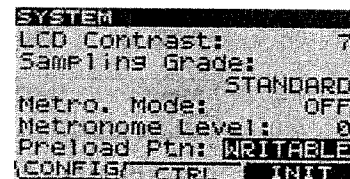

Changing the Pattern BPM (Tempo)

1. Go to the Pattern Play screen (p. 15).
 2. Turn the VALUE dial or use [DEC][INC] to select the pattern you want to edit.
You can also choose a pattern from the pattern list (p. 24).
 3. Press [F2] (EDIT) to get the PATTERN EDIT screen.
 4. Press [BPM] to get the PATTERN BPM screen.
The BPM specified for that pattern is displayed.
 5. Turn the VALUE dial or use [DEC][INC] to change the BPM (40.0–200.0).
The BPM will change in steps of one.
- TIP** You can change the BPM in steps of 0.1 by holding down [FUNC] and turning the VALUE dial.
6. Press [EXIT] to return to the Play screen.

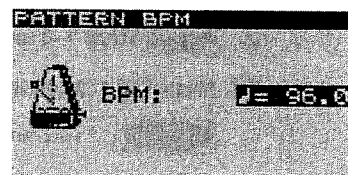
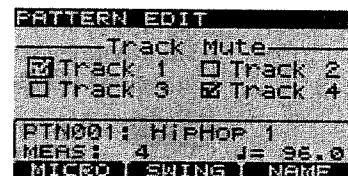

Storing Track Mute Settings in a Pattern

1. Go to the Pattern Play screen (p. 15).
2. Turn the VALUE dial or use [DEC][INC] to select the pattern you want to edit.
You can also select a pattern from the pattern list (p. 24).
3. Press [F2] (EDIT) to get the PATTERN EDIT screen.
The upper line of the screen will indicate "Track Mute."
4. Use [◀][▶][▲][▼] to move the cursor to Track 1–4, and turn the VALUE dial or use [DEC][INC] to add or remove a check mark.
Tracks with a check mark are muted. The mute status for each track is stored in the pattern.

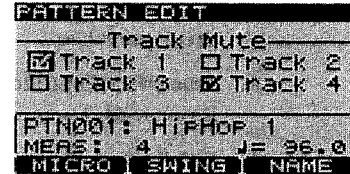

You can also use TRACK [1]–[4] to add or remove check marks in the "Track Mute" screen.

5. Press [EXIT] to return to the Play screen.

Microscope Editing

You can use Microscope editing to make detailed changes in the performance data of a pattern.

Basic Procedure for Microscope Editing

1. Go to the Pattern Play screen (p. 15).
2. Turn the VALUE dial or use [DEC][INC] to select the pattern you want to edit.
You can also choose a pattern from the pattern list (p. 24).
3. Press [F2] (EDIT) to get the PATTERN EDIT screen.
4. Press [F1] (MICRO) to get the MICROSCOPE EDIT screen.
5. Press TRACK [1]–[4] to select the track you want to edit.
6. Use [▼][▲] to move the cursor to the location of the performance data you want to edit.
7. Use [◀][▶] to select the parameter you want to edit.
From the left, the parameters are Pad (pad bank number - pad number; 1-1-32-16), Velocity (the force with which you strike the pad; 1-127), and Gate (note duration; 1-65535).
8. Turn the VALUE dial or use [DEC][INC] to edit the parameter value.
9. Repeat steps 5–8 to continue editing.
10. When you are finished, press [EXIT].

MICROSCOPE (TRK 1)

Position	Pad	Vel	Gate
1-1-00	1- 5	127	30
00	2- 5	74	29
48	1- 5	127	40
72	2- 5	66	35
2-24	1- 5	127	15

CREATE ERASE MOVE



You can execute Undo/Redo by holding down [FUNC] and pressing [◀◀] (Top) (p. 15).

Inserting Performance Data (CREATE)

Here's how to insert new performance data at the desired location in a pattern.

1. Press [F1] (CREATE) to get the CREATE EVENT screen.
2. Specify the location at which you want to insert data.
(Example) 01-1-00: measure 1, beat 1, tick 00
Use [◀] [▶] to move the cursor to "measure," "beat," and "tick," and turn the VALUE dial or use [DEC][INC] to edit the values.
3. Press [F3] (EXEC) to insert the performance data.
If you decide to cancel, press [F2] (CANCEL).
4. Edit the parameters of the performance data you inserted.



Refer to "Basic Procedure for Microscope Editing" (p. 59).

Erasing Performance Data (ERASE)

Here's how to erase performance data from a specific location.

1. Use [▼] [▲] to move the cursor to the location of the performance data you want to erase.
2. Press [F2] (ERASE) to erase that performance data.

Moving Performance Data (MOVE)

Here's how to move performance data to another location.

1. Use [▼] [▲] to move the cursor to the location of the performance data you want to move.
2. Press [F3] (MOVE) to get the MOVE EVENT screen.
3. Specify the location to which you want to move the data.
(Example) 01-1-00: measure 1, beat 1, tick 00
Use [◀] [▶] to move the cursor to "measure," "beat," and "tick," and turn the VALUE dial or use [DEC][INC] to edit the values.
4. Press [F3] (EXEC) to move the performance data.
If you decide to cancel, press [F2] (CANCEL).

Changing the Groove of a Pattern (SWING)

1. Go to the Pattern Play screen (p. 15).
2. Turn the VALUE dial or use [DEC][INC] to select the pattern you want to edit.

You can also choose a pattern from the pattern list (p. 24).

3. Press [F2] (EDIT) to get the PATTERN EDIT screen.
4. Press [F2] (SWING) to get the SWING screen.

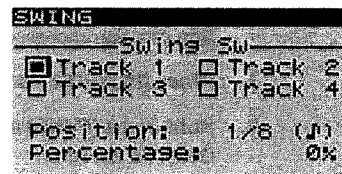

5. Use [▼][▲] to select the parameter you want to edit.

Turn the VALUE dial or use [DEC][INC] to edit the parameter value.

Parameter	Value	Explanation
Position	8th notes, 16th notes	Specifies the swing timing as a note value.
Percentage	0%–100%	Specifies how far the backbeats (relative to the notes specified by Position) will be shifted away from the downbeats. Shifting the timing of the backbeats will produce a sense of “swing.” 0%: The backbeats will be at the same timing as the downbeats. 50%: The backbeats will be exactly between the adjacent downbeats. 100%: The backbeats will be at the same timing as the preceding downbeat.
Track 1	OFF, ON	Specifies whether swing will be applied to each track. * The check mark means that swing will be applied.
Track 2	OFF, ON	
Track 3	OFF, ON	
Track 4	OFF, ON	

6. Press [EXIT] to return to the PATTERN EDIT screen.

Naming a Pattern

1. Go to the Pattern Play screen (p. 15).
 2. Turn the VALUE dial or use [DEC][INC] to select the pattern you want to edit.
- You can also choose a pattern from the pattern list (p. 24).

3. Press [F2] (EDIT) to get the PATTERN EDIT screen.
4. Press [F3] (NAME) to get the PATTERN NAME screen.

5. Use [◀][▶] to move the cursor to the character you want to change, and turn the VALUE dial or use [DEC][INC] to change the character.

Press [F1] (TYPE) to switch between uppercase/lowercase/numerals.

Press [F2] (DELETE) to delete the character at the cursor location.

Press [F3] (INSERT) to insert a space at the cursor location.



6. Press [ENTER] to update the name of the pattern.

If you decide to cancel, press [EXIT].

Deleting a Pattern

1. Go to the Pattern Play screen (p. 15).
2. Turn the VALUE dial or use [DEC][INC] to select the pattern you want to delete.
You can also choose a pattern from the pattern list (p. 24).
3. Press [F2] (EDIT) to get the PATTERN EDIT screen.
4. Hold down [FUNC] and press [F1] (DELETE) to get the PATTERN DELETE screen.
5. Press [F3] (EXEC) to delete the pattern.
If you decide to cancel, press [F2] (CANCEL).



Copying a Pattern

1. Go to the Pattern Play screen (p. 15).
2. Press [F2] (EDIT) to get the PATTERN EDIT screen.
3. Hold down [FUNC] and press [F2] (COPY) to get the PATTERN COPY screen.
4. Use [▼][▲] to move the cursor, and turn the VALUE dial or use [DEC][INC] to select a pattern.
Upper line: copy source
Lower line: copy destination
5. Press [F3] (EXEC) to copy the pattern.
If you decide to cancel, press [F2] (CANCEL).

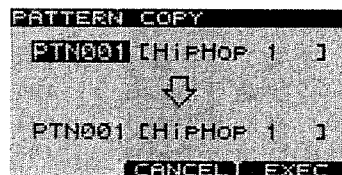

Chapter 7. Songs

Recording a Song

Basic Procedure for Recording a Song

You create a song by connecting patterns in the desired order.

1. Go to the Song Play screen (p. 15).
2. While the song is stopped, turn the VALUE dial or use [DEC][INC] to select the song you want to record. You can also choose a song from the song list (p. 66).

3. Press [●] (Record) to get the SONG RECORDING screen.

In the upper line of the screen, the song number and name ("Empty Song" if the song is empty) are shown at the left, and the current step/total number of steps ("EMPTY" if the song is empty) are shown at the right.

The lower line of the screen shows the pattern number and name of each step. (If the song is empty, this will indicate "EMPTY.")

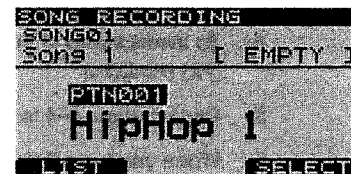

4. Move to the step at which you want to insert a pattern.

Pressing [◀◀] (Rewind) will move to the previous step, and pressing [▶▶] (Fast-forward) will move to the next step.

5. Turn the VALUE dial or use [DEC][INC] to select a pattern, and press [F3] (SELECT) or [ENTER] to confirm the pattern for the current step.

You can also press [F1] (LIST) and choose a pattern from the pattern list (p. 24).

To stop, press [■] (Stop).

6. Repeat steps 4–5 to continue recording.
7. When you are finished, press [■] (Stop).

TIP You can execute Undo/Redo by holding down [FUNC] and pressing [◀◀] (Top) (p. 15).

Editing a Song

Basic Procedure for Editing a Song

1. Go to the Song Play screen (p. 15).
2. Press [F2] (EDIT) to get the SONG EDIT screen.
In the upper line of the screen, the song name is shown at the left, and the current step/total number of steps are shown at the right.
The lower line of the screen shows the pattern number and name of each step. (If the song is empty, this will indicate "EMPTY.")
3. Turn the VALUE dial or use [▼][▲][DEC][INC] to move the cursor to the location you want to edit.
4. To insert a step at the current location, press [F1] (PtnINS). To delete the step at the current location, press [F2] (PtnDEL).
5. Repeat steps 3–4 to continue editing.
6. When you have finished editing, press [EXIT].

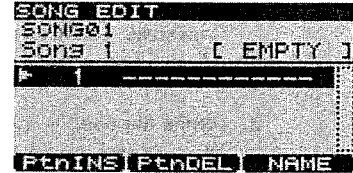

You can execute Undo/Redo by holding down [FUNC] and pressing [◀◀] (Top) (p. 15).

Changing the Song BPM (Tempo)

1. Go to the Song Play screen (p. 15).
2. Turn the VALUE dial or use [DEC][INC] to select the song you want to edit.
You can also choose a song from the song list (p. 66).
3. Press [F2] (EDIT) to get the SONG EDIT screen.
4. Press [BPM] to get the SONG BPM screen.
The BPM specified for that song is displayed.
5. Turn the VALUE dial or use [DEC][INC] to change the BPM (40.0–200.0).
The BPM will change in steps of one.
If you press [F1] (PTN), the BPM specified for the pattern will become the BPM for the song.
6. Press [EXIT] to return to the Play screen.

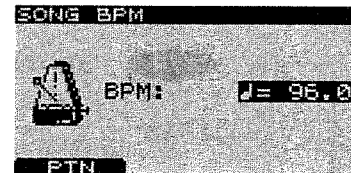

You can adjust the BPM in steps of 0.1 by holding down [FUNC] and turning the VALUE dial.

Naming a Song

1. Go to the Song Play screen (p. 15).
2. Turn the VALUE dial or use [DEC][INC] to select the song you want to edit.
You can also choose a song from the song list (p. 66).
3. Press [F2] (EDIT) to get the SONG EDIT screen.
4. Press [F3] (NAME) to get the SONG NAME screen.
5. Use [◀][▶] to move the cursor to the character you want to edit, and turn the VALUE dial or use [DEC][INC] to change the character.

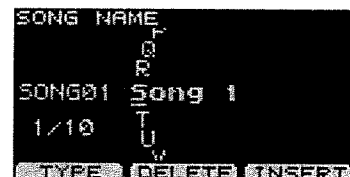

Press [F1] (TYPE) to switch between uppercase/lowercase/numerals.

Press [F2] (DELETE) to delete the character at the cursor location.

Press [F3] (INSERT) to insert a space at the cursor location.

6. Press [ENTER] to update the name of the song.

If you decide to cancel, press [EXIT].

Deleting a Song

1. Go to the Song Play screen (p. 15).
2. Turn the VALUE dial or use [DEC][INC] to select the song you want to edit.
You can also choose a song from the song list (p. 66).
3. Press [F2] (EDIT) to get the SONG EDIT screen.
4. Hold down [FUNC] and press [F1] (DELETE) to get the SONG DELETE screen.
5. Press [F3] (EXEC) to delete the song.
If you decide to cancel, press [F2] (CANCEL).

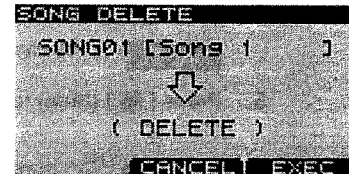

Copying a Song

1. Go to the Song Play screen (p. 15).
2. Press [F2] (EDIT) to get the SONG EDIT screen.
3. Hold down [FUNC] and press [F2] (COPY) to get the SONG COPY screen.
4. Use [▼][▲] to move the cursor, and turn the VALUE dial or use [DEC][INC] to select the copy-source and copy-destination songs.
Upper line of the screen: copy source
Lower line of the screen: copy destination
5. Press [F3] (EXEC) to copy the song.
If you decide to cancel, press [F2] (CANCEL).

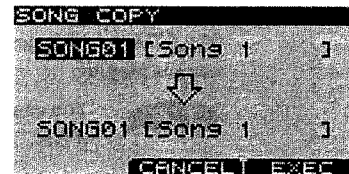

Playing a Song

Basic Procedure for Playing a Song

1. Go to the Song Play screen (p. 15).
2. While the song is not playing, turn the VALUE dial or use [DEC][INC] to select a song.
3. Press [▶] (Play) to start playback.
The upper line of the screen shows the current tempo, and measure/beat.
The lower line shows the pattern number and name (if the song is empty, this will indicate "EMPTY").

NOTE You can't switch songs while a song is playing.

4. Press [■] (Stop) to stop playback.
Press [◀◀] (Top) to return to the beginning of the song.
Press [◀◀] (Rewind) to move one step back, or [▶▶] (Fast-forward) to move one step forward.

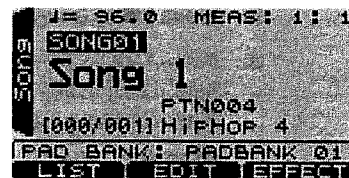

Selecting and Playing a Song from the Song List

1. Go to the Song Play screen (p. 15).
2. Press [F1] (LIST) to get the SONG LIST screen.
3. Turn the VALUE dial or use [▼][▲][DEC][INC] to select a song, and press [F3] (SELECT) or [ENTER] to confirm your choice.
If you decide to cancel, press [EXIT].

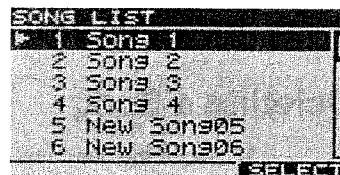

TIP Songs 1–16 can be selected directly by pressing pads [1]–[16].

4. Press [▶] (Play) to start playback.

NOTE You can't switch songs while a song is playing.

5. Press [■] (Stop) to stop playback.

Changing the Song Playback BPM (Tempo)

1. Go to the Song Play screen (p. 15).
2. Press [BPM] to get the BPM screen.
The current BPM is displayed.
3. Turn the VALUE dial or use [DEC][INC] to change the BPM (40.0–200.0).
The BPM will change in steps of one. You can also adjust this while the song is playing.

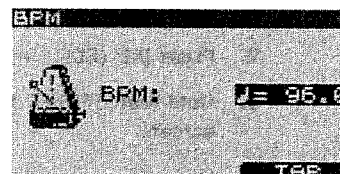

TIP You can adjust the BPM in steps of 0.1 by holding down [FUNC] and turning the VALUE dial.

TIP You can also set the BPM by pressing [F3] (TAP) three times or more at the desired interval (Tap Tempo function).

NOTE You can't change the BPM if "Sync Mode" (p. 79) is set to SLAVE.

4. Press [EXIT] to return to the Play screen.

Muting Individual Tracks

You can mute (silence) individual tracks while the song plays.

1. Go to the Song Play screen (p. 15).
2. Press [▶] (play) to play back the song.
3. Press TRACK [1]–[4].
Button lit: playing
Button blinking: muted

MEMO If a track button is unlit, that track contains no data.

Chapter 8. Using a Memory Card

NOTE If the SP-606 is powered up, do not remove the memory card from the SP-606's card slot before shutting down (p. 22). Doing so may damage the SP-606 or the data in the memory card.

NOTE Make sure that the memory card is oriented correctly, and insert it all the way into the slot. Do not use excessive force.

NOTE When using a memory card for the first time, you must format it on the SP-606. Memory cards formatted by another device will not be recognized by the SP-606.

cf. For more about inserting and removing memory cards, refer to "Inserting/Removing Memory Cards" (p. 22).

cf. For details on the recommended memory cards, refer to "Recommended Memory Cards" (p. 91) in the Appendix.

Formatting (Initializing) a Memory Card

NOTE Formatting a memory card will erase all data from that card.

1. Insert the memory card into the front panel card slot.
2. Go to the Play screen (p. 15).
3. Hold down [FUNC] and press pad [10] (CARD UTIL) to get the CARD UTILITY screen.
4. Use [▼] to move the cursor to the "Card Format" line.
5. Press [ENTER] to get the CARD FORMAT screen.

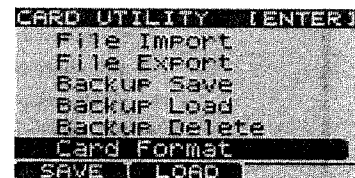

```
CARD UTILITY [ENTER]
File Import
File Export
Backup Save
Backup Load
Backup Delete
Card Format
SAVE LOAD
```

NOTE If a memory card is not inserted, the display will indicate "Card Not Ready!"

6. Press [F3] (EXEC). The display will indicate "All the data on the card will be lost, are you sure?"
7. Press [F3] (EXEC) to begin formatting.
If you decide to cancel, press [F2] (CANCEL).
While formatting is being carried out, the display will indicate "Executing ..."
8. When the display indicates "Complete," press [F3] (EXIT) or [EXIT] to return to the Play screen.

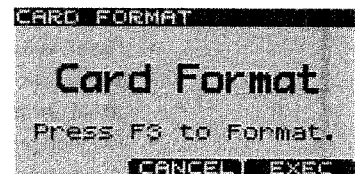

```
CARD FORMAT
Card Format
Press F3 to Format.
CANCEL EXEC
```

NOTE Do not modify or delete the files or folders that are created when a memory card is formatted. If you do so, the SP-606 will not recognize the card correctly.

Basic Procedure for Card Utility Operations

1. Insert the memory card into the front panel card slot.
2. Go to the Play screen (p. 15).
3. Hold down [FUNC] and press pad [10] (CARD UTIL) to get the CARD UTILITY screen.

4. The rest of the procedure will depend on the utility operation. Refer to the following pages for details on each operation.
 - FILE IMPORT -> p. 68
 - FILE EXPORT -> p. 69
 - BACKUP SAVE -> p. 70
 - BACKUP LOAD -> p. 70
 - BACKUP DELETE -> p. 71
 - CARD FORMAT -> p. 67

Card Utility Operations

FILE IMPORT

This operation loads an audio file from a memory card.

NOTE If “memory full” is indicated for the memory card (p. 90), you may not be able to perform file operations from your computer. In this case, reduce the amount of data on the memory card.

Caution When Importing Audio Files (WAV/AIFF)

- When using your computer or other device to copy or save an audio file (WAV/AIFF) onto a memory card, place the file in the root directory (the top level) of the card. If you place the file anywhere else on the card, the SP-606 will be unable to import it.
- When importing, the SP-606 can recognize a maximum of 200 audio files.
- File names that are longer than eight characters or that contain double-byte (e.g., Japanese) characters will not be displayed correctly.
- WAV files must have a filename extension of WAV, and AIFF files must have a filename extension of AIF. Files will not be recognized if they have any other extension.
- The SP-606 can only import 8-bit or 16-bit samples.
- Sample rate conversion is not performed. The audio file will be imported as 44.1 kHz data. If the actual sample rate of the imported file is other than 44.1 kHz, it will play at an incorrect pitch.
- The loop point settings within an AIFF file are ignored.
- If you attempt to import WAV/AIFF data in a format not supported by the SP-606, the error message “unsupported!” will appear, and the data will not be imported.
- Compressed audio files (WAV/AIFF) cannot be imported.
- In some cases, it may not be possible to import extremely short audio files (WAV/AIFF).
- The following table shows the time required to import large audio files.

** Once the Import operation has begun, it cannot be canceled.*

File size	Audio playback time	Time required for import
1 MB	Approx. 10 seconds of stereo	Approx. 30 seconds
10 MB	Approx. 2 minutes of stereo	Approx. 5 minutes
50 MB	Approx. 10 minutes of stereo	Approx. 25 minutes
100 MB	Approx. 20 minutes of stereo	Approx. 50 minutes

1. In the CARD UTILITY screen, use [▼] [▲] to move the cursor to the “File Import” line.
2. Press [ENTER] to get the FILE IMPORT screen.

NOTE If a memory card is not inserted, the message “Card Not Ready!” will appear.

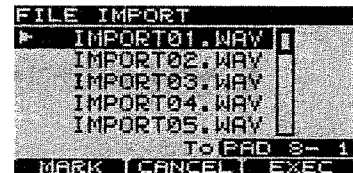

3. Turn the VALUE dial or use [DEC][INC] to select the file you want to import.
If you want to select multiple files, press [F1] (MARK) to assign a check mark to each file you want to select.
MEMO If the memory card contains no files, the display will indicate "Empty."
4. Press a pad to select the import-destination pad.
If you want to change pad banks, press [PAD BANK] and switch the pad bank (p. 23).
If check marks were assigned to files in step 3, these files will be imported consecutively starting at pad [1] of the current pad bank.
The pad number is displayed in the lower line of the screen.
(example) PAD 8-1: pad bank 8, pad number 1
5. Press [F3] (EXEC) to import the file.
If you decide to cancel, press [F2] (CANCEL).

FILE EXPORT

This operation exports (saves) a sample to a memory card as an audio file.

1. In the CARD UTILITY screen, use [▼][▲] to move the cursor to the "File Export" line.
2. Press [ENTER] to get the FILE EXPORT screen.

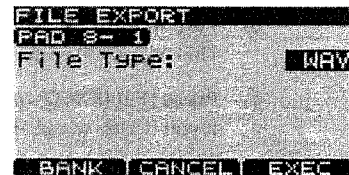

- NOTE** If a memory card is not inserted, the message "Card Not Ready!" will appear.
3. Press a pad to select the pad containing the sample you want to export.
If you want to change pad banks, press [PAD BANK] and switch the pad bank (p. 23).
If you want to export all samples of the current pad bank, press [F1] (BANK).
The pad number is displayed in the upper line of the screen.
(example) PAD 8-1: pad bank 8, pad number 1
 4. Turn the VALUE dial or use [DEC][INC] to select WAV or AIFF as the "File Type."
This specifies the type of file that will be exported.
 5. Press [F3] (EXEC) to export the file.
If you decide to cancel, press [F2] (CANCEL).

About the Exported Audio Files (WAV/AIFF)

Audio files (WAV/AIFF) exported to a memory card will be located in the root directory (highest level) of the memory card.

When you use a computer or other device to view the root directory of the memory card, the exported audio files (WAV/AIFF) will appear with the following names.

Samples exported from pad banks 1–8 (internal memory):

WAV: i01_01.WAV–i08_16.WAV

AIFF: i01_01.AIF–i08_16.AIF

Samples exported from pad banks 9–32 (memory card):

WAV: c09_01.WAV–c32_16.WAV

AIFF: c09_01.AIF–c32_16.AIF

BACKUP SAVE

This operation saves backup data (all settings of the SP-606, including the samples, pad banks, patterns, and songs) to a memory card. Up to four sets of backup data can be saved on one memory card.

NOTE Fewer sets of backup data can be saved if numerous samples have been saved on the card, reducing its remaining free capacity.

1. In the **CARD UTILITY** screen, use [▼][▲] to move the cursor to the “Backup Save” line.
2. Press [ENTER] to get the **BACKUP SAVE** screen.
Empty backup data sets are displayed as dotted lines.



You can also get to the same screen by pressing [F1] (SAVE) from the **CARD UTILITY** screen.

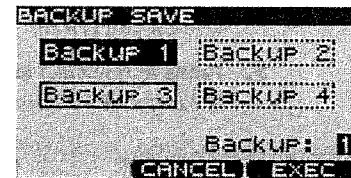

If a memory card is not inserted, the message “Card Not Ready!” will appear.

3. Turn the **VALUE** dial or use [▼][▲][◀][▶][DEC][INC] to select 1–4 as the “Backup” setting.
This selects the backup set in which the data is to be saved.
4. Press [F3] (**EXEC**) to save the backup data.
If you decide to cancel, press [F2] (**CANCEL**).



If the save destination you selected already contains backup data, the message “A Backup Data Already Exists! Overwrite?” will appear. If you want to overwrite the existing data, press [F3] (**EXEC**) or [ENTER]. If you decide to cancel, press [F2] (**CANCEL**) or [EXIT].

BACKUP LOAD

This operation loads backup data (all settings of the SP-606, including the samples, pad banks, patterns, and songs) from a memory card.

NOTE Be aware that when you execute the Backup Load operation, the internal settings will be replaced (overwritten) by the backup data that is loaded.

1. In the **CARD UTILITY** screen, use [▼][▲] to move the cursor to the “Backup Load” line.
2. Press [ENTER] to get the **BACKUP LOAD** screen.
Empty backup data sets are displayed as dotted lines.



You can also get to the same screen by pressing [F2] (**LOAD**) from the **CARD UTILITY** screen.

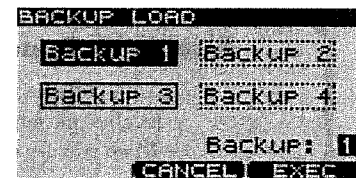

If a memory card is not inserted, the message “Card Not Ready!” will appear.

3. Turn the **VALUE** dial or use [▼][▲][◀][▶][DEC][INC] to select 1–4 as the “Backup” setting.
This selects the backup set from which the data will be loaded.
4. Press [F3] (**EXEC**) to load the backup data.
If you decide to cancel, press [F2] (**CANCEL**).

BACKUP DELETE

This operation deletes the specified set of backup data (all settings of the SP-606, including the samples, pad banks, patterns, and songs) from a memory card.

1. In the **CARD UTILITY** screen, use [▼] [▲] to move the cursor to the "Backup Delete" line.
2. Press [ENTER] to get the **BACKUP DELETE** screen.
Empty backup data sets are displayed as dotted lines.

NOTE If a memory card is not inserted, the message "Card Not Ready!" will appear.

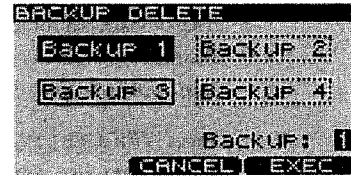

3. Turn the **VALUE** dial or use [▼] [▲] [◀] [▶] [DEC] [INC] to select 1–4 as the "Backup" setting.
This selects the backup set that will be deleted.
4. Press [F3] (EXEC) to delete the selected backup set.
If you decide to cancel, press [F2] (CANCEL).

Chapter 9. Using the D Beam

Using the D Beam Controller

The D Beam is a controller that you use simply by moving your hand above it. Three different ways of using the D Beam are already set up for immediate use; trigger, synth, and filter. By adjusting the D Beam settings you can use it to apply a wide range of other effects.

Press [TRIGGER], [SYNTH], or [FILTER] to turn on one of the D Beam settings; the button will light. The button will go out when you turn it off.

NOTE You cannot simultaneously turn on more than one of these three buttons.

The Range of the D Beam Controller

The effective range of the D Beam controller is shown in the diagram below. No effect will occur if you move your hand outside this range.

NOTE The effective range of the D Beam controller will be severely reduced if used in strong, direct sunlight. Be aware of this when using the D Beam controller outside.

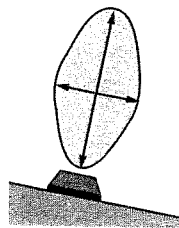

D Beam Controller Settings

Basic Procedure for Making D Beam Settings

1. Go to the Play screen (p. 15).
2. Press [MENU] to get the Top Menu screen.
3. Press [▼] to move the cursor to "2:D Beam Setting" and press [ENTER].
The D BEAM SETTING screen will appear.
4. Use [▼][▲] to select the parameter you want to edit.
Press [F1] (TRIG) to edit trigger-related parameters.
Press [F2] (SYNTH) to edit synth-related parameters.
Press [F3] (FILTER) to edit filter-related parameters.
Hold down [FUNC] and press [F1] (INFO) to get the D BEAM INFO (D Beam Information) screen.
5. Turn the VALUE dial or use [DEC][INC] to edit the parameter value.
6. If you want to save the changes you made, hold down [FUNC] and press [F3] (WRITE) to save the parameter values.
7. Press [EXIT] to return to the Play screen.

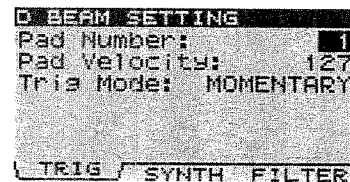

D Beam Setting Parameters

TRIGGER

As an alternative to striking the pad itself, you can use the D Beam controller to play a specified pad.

Parameter	Value	Explanation
Pad Number	1–16	Specifies the pad number that will be played by the D Beam controller.
Pad Velocity	1–127	Specifies the loudness of the pad sound played by the D Beam controller.
Trig Mode	MOMENTARY, LATCH	Specifies what will happen when you place your hand above the D Beam. MOMENTARY: The pad sound will be on only while your hand stays above the D Beam; it will turn off when you take your hand away. LATCH: The pad sound will alternately turn on/off each time you place your hand above the D Beam.

SYNTH

This lets you use the D Beam to control the pitch of a built-in monophonic synthesizer.

Parameter	Value	Explanation
Send Select	DRY, MFX	Specifies whether an effect will be applied. DRY: The synth sound will not be sent to the effect. MFX: The synth sound will be sent to the effect.
Pitch Low	0–127	Specifies the lower pitch limit for the D Beam controller.
Pitch High	0–127	Specifies the upper pitch limit for the D Beam controller.
Scale	CHROMATIC, TCHERPINS, SPANISH, BLUES MIXO, COMB DIM, MAJOR, MINOR, HARMONIC MAJ, HARMONIC MIN, DBL HARMONIC, MELO MIN, GYPSY, DOMINANT, HEX, HEX BLUE, AUGMENT, RYUKYU, INSEN DEC, INSEN ASC, PENTA, PENTA MIN	Specifies the scale that will be used. Moving your hand closer to the D Beam controller will produce higher pitches. Choose one of the following 21 scales. CHROMATIC: Chromatic Scale TCHERPINS: Tcherepnin's Scale SPANISH: Spanish Scale BLUES MIXO: Blues Mixolydian Scale COMB DIM: Combination of Diminished Scale MAJOR: Diatonic Major Scale MINOR: Natural Minor Scale HARMONIC MAJ: Harmonic Major Scale HARMONIC MIN: Harmonic Minor Scale DBL HARMONIC: Double Harmonic Scale MELO MIN: Melodic Minor Scale GYPSY: Gypsy Scale DOMINANT: Dominant Scale HEX: Whole Tone Scale HEX BLUE: Hexatonic Blue Scale AUGMENT: Augmented Scale RYUKYU: Ryukyu Scale INSEN DEC: In Sen Scale, Decending INSEN ASC: In Sen Scale, Ascending PENTA: Major Pentatonic Scale PENTA MIN: Minor Pentatonic Scale
Level	0–127	Specifies the volume of the synth sound.
Osc Wave	SAW, TRI, PLS, NOISE	Selects the waveform of the oscillator that generates the sound. SAW (sawtooth wave): A thick sound rich in overtones. TRI (triangle wave): A mild sound with fewer overtones. PLS (pulse wave): The sound will be affected by the following two settings ("PWM Depth" and "PWM Duty"). NOISE: Noise.
PWM Depth	0–127	Depth specifies the depth to which the LFO will modulate the pulse width of the pulse wave. This creates a distinctive cyclic tonal change. Higher settings produce a deeper effect.
PWM Duty	0–127	Specifies the width of the pulse. Higher settings produce a narrower pulse width.

Parameter	Value	Explanation
Vibrato Depth	0-127	Specifies the depth of vibrato (an effect that uses an LFO to cyclically vary the pitch of the oscillator).
LFO Wave	0-127	An LFO (Low Frequency Oscillator) is used to apply various types of modulation (cyclic change) to the tone or pitch. You can select one of the following LFO waveforms. SAW: sawtooth wave TRI: triangle wave SQR: square wave RND: randomly changing waveform
LFO Rate	0-127	Specifies the speed of modulation.
PORTAMENT TIME	0-100	Specifies the time over which Portamento (a function that creates smooth pitch transitions between synthesizer notes) will vary the pitch. With higher settings, the pitch change will take longer.

FILTER

This lets you use the D Beam to control a built-in filter that features an extremely steep slope

Parameter	Value	Explanation
Cutoff Low	0-127	Specifies the lower frequency limit for the D Beam controller.
Cutoff High	0-127	Specifies the upper frequency limit for the D Beam controller.
Resonance	0-127	Specifies the resonance level of the filter. Raising this value will boost the sound in the region of the cutoff frequency.
Type	LPF, BPF, HPF, NOTCH	Specifies the type of filter. Each type of filter will pass the following frequencies. LPF: frequencies below the Cutoff BPF: frequencies near the Cutoff HPF: frequencies above the cutoff NOTCH: frequencies other than at the Cutoff
Slope	-12dB, -24dB, -36dB	Specifies the steepness of the filter (expressed as the amount of attenuation per octave).
Gain	0-+12dB	Adjusts the amount of boost for the filter output.

D BEAM INFO (D Beam Information) Screen

In this screen you can view the D Beam value in graphical form. (Vertical axis: D Beam value; Horizontal axis: time)

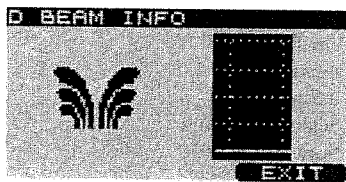

Press [F3] (EXIT) or [EXIT] to return to the **D BEAM SETTING** screen.

Chapter 10. About V-LINK

What Is V-LINK?

V-LINK (**V-LINK**) is functionality promoted by Roland that allows linked performance of music and visual material. By using V-LINK-compatible video equipment (such as the Edirol DV-7PR or P-1), visual effects can be easily linked to, and made part of the expressive elements of a performance.

For example, when the SP-606 is used in conjunction with the Edirol P-1, applications such as the following are made possible:

- Use the SP-606's sequencer to play music and show images in synchronization.
- Use the SP-606's pads or sequencer playback (song or pattern) to switch photos or pages on the Edirol P-1.

MEMO In order to use V-LINK between the SP-606 and the Edirol P-1, you will need to connect the two units using a MIDI cable (sold separately).

Connection Example

Use a MIDI cable to connect the SP-606's MIDI OUT connector to the MIDI IN connector of the Edirol P-1.

NOTE To prevent malfunction and/or speaker damage, you must turn down the volume on all devices and turn off their power before making connections.

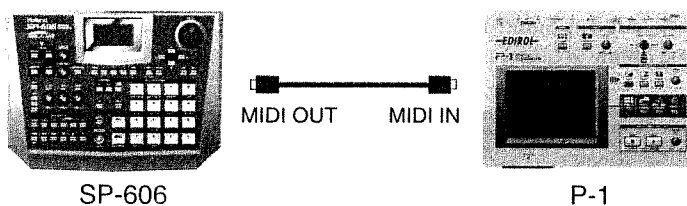

Basic V-LINK Operation

1. Go to the Play screen (p. 15).

2. Press [V-LINK] so it's lit.

The V-LINK screen will appear.

In this state, you can operate the SP-606's pads or knobs to control images in conjunction with the SP-606's performance.

When you press [F1] (RESET), the display will indicate "Send All Reset"; the effects being applied to the image will be reset, and settings such as brightness and hue will all return to their default settings.

When you press [F2] (MODE), you can select whether the pads will switch **PALETTES** or **CLIPS**.

When you press [F3] (SETUP), the V-LINK SETUP screen will appear (p. 76).

3. Press [EXIT].

The V-LINK function will remain on, and you will return to the Play screen.

4. When you are ready to turn off the V-LINK function, press [V-LINK] so its illumination is turned off.

If you returned to the Play screen in step 3, press [V-LINK] to return to the V-LINK screen and then press [V-LINK] once again so its illumination is turned off.

MEMO The V-LINK function will always be off when you turn on the power.

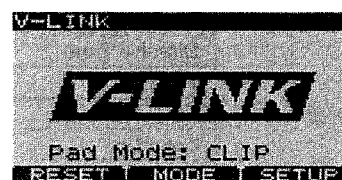

V-LINK Setup Parameters

1. Use [▼] [▲] to choose the setting (parameter) you want to edit.
2. Turn the VALUE dial or use [DEC][INC] to edit the value of the parameter.

Parameter	Value	Explanation
V-LINK Ctrl Ch	1-16	Specifies the MIDI channel used to control V-LINK functions.
CTRL1 CTRL2 CTRL3 D Beam	OFF, PLAY SPEED, DISSOLVE TM, T BAR, COLOR Cb, COLOR Cr, BRIGHTNESS, VFX1, VFX2, VFX3, VFX4, OUT FADER	Assign V-LINK functions to the control knobs and D Beam controller. OFF: No V-LINK function is assigned. PLAY SPEED: Playback speed DISSOLVE TM: Dissolve time (the time over which images will change) T BAR: T bar COLOR Cb: Color Cb (color difference signal) COLOR Cr: Color Cr (color difference signal) BRIGHTNESS: Brightness VFX1: Visual effect 1 VFX2: Visual effect 2 VFX3: Visual effect 3 VFX4: Visual effect 4 OUT FADER: Output fader
Seq Ctrl Bank	OFF, 1-32	Of the pad settings included in the pattern data, only the pads of the specified pad bank will be assigned to V-LINK functions.

3. When you have finished setting the parameters, press [F3] (WRITE) to store the settings.
A message of "System Write, Are You Sure?" will appear. Press [F3] (EXEC) if you want to store the settings, or press [F2] (CANCEL) if you decide to cancel.

Appendix

Controllable V-LINK Functions and MIDI Messages

V-LINK function	Transmitted MIDI message	Controller
Clip/Photo 1-16	PC	Pad
Palette/Page 1-32	CC#0 (Bank Select)	
Playback Speed	CC#8 (Balance)	CTRL1 CTRL2 CTRL3 D Beam
Dissolve Time	CC#73 (Attack)	
T Bar	CC#11 (Expression)	
Color Cb	CC#1 (Modulation)	
Color Cr	CC#71 (Resonance)	
Brightness	CC#74 (Cutoff)	
VFX1	CC#72 (Release)	
VFX2	CC#91 (Reverb)	
VFX3	CC#92 (Tremolo)	
VFX4	CC#93 (Chorus)	
Output Fade	CC#10 (Panpot)	

Bank Select/Program Change Function List

	DV-7PR	P-1	V-4
Bank Select	Palette 1-20 (00H 00H-13H 00H)	Page 1-20 (00H 00H-13H 00H)	Ch A/B (00H 00H/01H 00H)
Program Change	Clip 1-32 (00H-1FH)	Photo 1-12 (00H-0BH)	Input 1-4 (00H-03H)

Chapter 11. Using the SP-606 with Other MIDI Equipment

NOTE Do not use a MIDI cable to connect the SP-606's MIDI IN connector directly to its MIDI OUT connector (i.e., in a loop). Also, if you make connections with other MIDI equipment in a way that forms a loop, do not set your other MIDI device to "thru" ("software thru") the incoming data. The SP-606 may not operate correctly if you fail to observe these points.

About MIDI

MIDI stands for Musical Instrument Digital Interface. It is a universal standard that allows electronic musical instruments, computers, and similar devices to exchange performance data and other musical information. The SP-606 is MIDI-compatible, and provides two MIDI connectors; MIDI IN and MIDI OUT. By using these connectors to connect the SP-606 to other devices, you can take advantage of a wide range of possibilities.

About MIDI Connectors

The SP-606 has two types of MIDI connector.

MIDI IN: Receives MIDI messages from another MIDI device.

MIDI OUT: Transmits MIDI messages from the SP-606.

About the MIDI Implementation Chart

The MIDI implementation chart (p. 96) provides an easy way to see just what MIDI messages the SP-606 is able to transmit and receive. By placing this chart beside the MIDI implementation chart of another MIDI device, you can see at a glance which MIDI messages can be sent and received between the two devices.

MIDI on the SP-606

The MIDI note numbers corresponding to each of the SP-606's pads are shown below.

MIDI ch NOTE #	Base MIDI ch	Base MIDI ch+1	Base MIDI ch+2	Base MIDI ch+3	Base MIDI ch+4	Base MIDI ch+5	Base MIDI ch+6	Base MIDI ch+7
35(0x23) ⋮ 50(0x32)	PAD 1 ⋮ PAD16 [PadBank 1]	PAD 1 ⋮ PAD16 [PadBank 5]	PAD 1 ⋮ PAD16 [PadBank 9]	PAD 1 ⋮ PAD16 [PadBank13]	PAD 1 ⋮ PAD16 [PadBank17]	PAD 1 ⋮ PAD16 [PadBank21]	PAD 1 ⋮ PAD16 [PadBank25]	PAD 1 ⋮ PAD16 [PadBank29]
51(0x33) ⋮ 66(0x42)	PAD 1 ⋮ PAD16 [PadBank 2]	PAD 1 ⋮ PAD16 [PadBank 6]	PAD 1 ⋮ PAD16 [PadBank10]	PAD 1 ⋮ PAD16 [PadBank14]	PAD 1 ⋮ PAD16 [PadBank18]	PAD 1 ⋮ PAD16 [PadBank22]	PAD 1 ⋮ PAD16 [PadBank26]	PAD 1 ⋮ PAD16 [PadBank30]
67(0x43) ⋮ 82(0x52)	PAD 1 ⋮ PAD16 [PadBank 3]	PAD 1 ⋮ PAD16 [PadBank 7]	PAD 1 ⋮ PAD16 [PadBank11]	PAD 1 ⋮ PAD16 [PadBank15]	PAD 1 ⋮ PAD16 [PadBank19]	PAD 1 ⋮ PAD16 [PadBank23]	PAD 1 ⋮ PAD16 [PadBank27]	PAD 1 ⋮ PAD16 [PadBank31]
83(0x53) ⋮ 98(0x62)	PAD 1 ⋮ PAD16 [PadBank 4]	PAD 1 ⋮ PAD16 [PadBank 8]	PAD 1 ⋮ PAD16 [PadBank12]	PAD 1 ⋮ PAD16 [PadBank16]	PAD 1 ⋮ PAD16 [PadBank20]	PAD 1 ⋮ PAD16 [PadBank24]	PAD 1 ⋮ PAD16 [PadBank28]	PAD 1 ⋮ PAD16 [PadBank32]

cf. For details on "Pad Base Ch" refer to "MIDI Utility Parameters" (p. 79).

Changing the MIDI Settings

Basic Procedure for MIDI Utility Settings

1. Go to the Play screen (p. 15).
2. Hold down [FUNC] and press pad [11] (MIDI UTIL) to get the MIDI UTILITY screen.
3. Use [▼] [▲] to select the parameter you want to change.
4. Turn the VALUE dial or use [DEC][INC] to change the setting.
5. Press [EXIT] to return to the Play screen.

```

MIDI UTILITY
Pad Base Ch: 1
Pad Tx Mode: TYPE1
Effect Ctrl Ch: OMNI
Sync Source: USB
Sync Mode: INT
Tx MIDI Sync: OFF
Soft Thru: OFF
  
```

MIDI Utility Parameters

Parameter	Value	Explanation
Pad Base Ch	OFF, 1-9	Specifies the basic MIDI channel used to receive pad performance data. * See "MIDI on the SP-606" (p. 78).
Pad Tx Mode	TYPE1, TYPE2	When the Note Trigger function (p. 86) is selected, this specifies whether the note numbers transmitted to an external MIDI device will be different for each pad bank. TYPE1: Note numbers will be fixed as follows. Channel: 1 Note numbers: Pad 1 -> 35 Pad 2 -> 36 : Pad 16 -> 50 TYPE2: Note numbers will be different for each pad bank. For the note numbers transmitted by each bank, refer to "MIDI Functionality on the SP-606" (p. 78).
Effect Ctrl Ch	OFF, 1-16, OMNI	Specifies the MIDI channel used to control effects. OFF: Not used. 1-16: The channel you specify will be used. OMNI: Any channel can be used.
Sync Source	MIDI, USB	Specifies the synchronization source used when the "Sync Mode" is SLAVE. The SP-606 will synchronize to an external device (e.g., sequencer) connected via a MIDI cable if this is set to MIDI , or to an external device connected via USB if this is set to USB .
Sync Mode	INT, REMOTE, SLAVE	Specifies how the SP-606 will synchronize with an external MIDI device. INT: The SP-606's internal sequencer will operate according to its own internal BPM (tempo) setting. REMOTE: Basic operation is the same as for the INT setting, but the external MIDI device will be able to remotely start/stop playback of the SP-606's internal sequencer. SLAVE: The internal sequencer will synchronize to incoming MIDI Clock messages.
Tx MIDI Sync	OFF, ON	Specifies whether the SP-606 will transmit synchronization-related MIDI messages. If this is ON, the SP-606 will transmit the following MIDI messages from MIDI OUT. • Timing Clock: F8 • Start: FA • Continue: FB • Stop: FC • Song Position Pointer: F2
Soft Thru	OFF, ON	Specifies whether data (except for system realtime messages) received at the SP-606's MIDI IN connector will be retransmitted from its MIDI OUT connector along with the performance data generated and sent by the SP-606 itself. * To make the pads more responsive to your playing, leave this setting OFF unless you require it.

Chapter 12. System Settings

About the System Settings

Using the Included CD-ROM to Restore the Factory-Set Condition

The included "DRIVER/FACTORY DATA" CD-ROM contains data you can use to restore the SP-606 to the state it was in when it left the factory.

NOTE All internal memory data will be lost if you perform this procedure. If you want to keep your data, make a backup before you proceed. (Backup Save -> p. 70)

You will need the following items.

- A computer with a CD-ROM drive
- An appropriate card reader for the memory card
- The included "DRIVER/FACTORY DATA" CD-ROM
- A memory card (formatted on the SP-606)

cf. Refer to "Formatting (Initializing) a Memory Card" (p. 67).

1. Connect the card reader to your computer, and make it ready for use.

NOTE For details on how to connect and use your computer and card reader, refer to their owner's manuals.

2. Insert the included "DRIVER/FACTORY DATA" CD-ROM into your CD-ROM drive.
3. Insert the memory card into the card reader.
4. Copy the "FCTRY" folder from the included "DRIVER/FACTORY DATA" CD-ROM into the "ROLAND" folder of the memory card.

NOTE If the "ROLAND" folder of the memory card already contains a "FCTRY" folder, delete this "FCTRY" folder from the card before copying from the CD-ROM.

5. Remove the memory card from the card reader, and insert it into the SP-606's card slot.
6. Go to the SP-606's Play screen (p. 15).
7. Press [MENU] to get the Top Menu screen.
8. Move the cursor to the "1:SYSTEM" line, and press [ENTER].
The SYSTEM screen will appear.
9. Press [F3] (INT) to get the SYSTEM INITIALIZE screen.
10. Press [F1] (PRESET) to add a check mark to "Load Factory Data"

NOTE If a memory card is not inserted, the display will indicate "Card Not Ready!"

NOTE If you initialize without adding a check mark, all the data in internal memory will be erased, and the system settings will be initialized. However, if the Protect setting is turned on for pad banks or preloaded patterns (p. 31, p. 58), the message "Protected" will appear, and the Initialize operation cannot be executed.

11. Press [F3] (EXEC).
If you decide to cancel, press [F2] (CANCEL).

```
SYSTEM
LCD Contrast: 7
Sampling Rate: STANDARD
Metro. Mode: REC ONLY
Metronome Level: 70
Preload Ptn: WRITABLE
CONFIG CTRL INIT
```

```
SYSTEM INITIALIZE
[ ] Load Factory Data
LOAD CANCEL EXEC
```



12. The message "This will clear all the internal contents. Are you sure?" will appear. Press [F3] (EXEC).
If you decide to cancel, press [F2] (CANCEL).
The display will indicate "Executing..."
13. The message "Please Power Off." will blink. Turn off the power of the SP-606, and then turn it back on again.

Making System Settings

- Go to the Play screen (p. 15).
- Press [MENU] to get the Top Menu screen.
- Move the cursor to the "1:SYSTEM" line and press [ENTER].
The **SYSTEM** screen will appear.

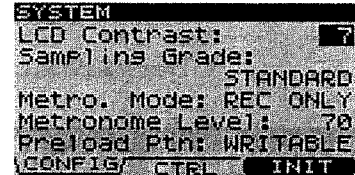

You can access the **SYSTEM INFO** screen by holding down [FUNC] and pressing [F1] (INFO). (p. 82)



- Press [F1] (CONFIG).
- Use [▼][▲] to select the parameter you want to set.
Turn the VALUE dial or use [DEC][INC] to set the value.

Parameter	Value	Explanation
LCD Contrast	1-16	Adjusts the contrast of the display.
Sampling Grade	STANDARD, LONG	Specifies the sampling grade. STANDARD: Standard audio quality. LONG: Somewhat lower audio quality than STANDARD, but uses only half the amount of memory.
Metro. Mode	OFF, ON, REC ONLY, PLAY&REC	Specifies the metronome setting. OFF: The metronome will not sound. ON: The metronome will always sound. REC ONLY: The metronome will sound only while recording. PLAY&REC: The metronome will sound during playback and recording.
Metronome Level	0-127	Specifies the metronome volume.
Preload Ptn	WRITABLE, PROTECT	Specifies whether the preloaded patterns (the patterns loaded in internal memory when the SP-606 is shipped) are protected. WRITABLE: The preloaded patterns can be edited or erased. PROTECT: The preloaded patterns are protected; they cannot be edited or erased.

- Press [F2] (CTRL).
- Use [▼][▲] to select the parameter you want to set.
Turn the VALUE dial or use [DEC][INC] to set the value.

Parameter	Value	Explanation
Foot Sw Assign	OFF, START/STOP, TAP TEMPO, MFX1 SW, MFX2 SW	Specifies the function of the foot switch. OFF: Not used. START/STOP: Song or pattern playback will start/stop each time you press the foot switch. TAP TEMPO: The tempo will be set by the interval at which you press the foot switch (Tap Tempo function -> p. 25, p. 66). MFX1 SW: MFX1 will turn on/off each time you press the foot switch. MFX2 SW: MFX2 will turn on/off each time you press the foot switch.
D Beam Sens	0-127	Adjusts the sensitivity of the D Beam controller.

- Press [EXIT] to return to the Play screen.

Checking System Information

If you hold down [FUNC] and press [F1] (INFO) in steps 3–7 of “Making System settings,” the **SYSTEM INFO** (System Information) screen will appear.

- You can press [F1] (MEMORY) to see the following items of memory-related information.

Item	Explanation
Internal	Internal memory: remaining available capacity (MB) / total capacity (16.0 MB)
Card	Card memory: remaining available capacity (MB) / total capacity (MB) * If a memory card is not inserted, the display will indicate “No Card.”
Pattern	Number of notes that can be saved in patterns
Song	Number of songs that can be saved

- Press [F2] (VER) to check the system program version.

Adjusting the Master Level

This setting simultaneously adjusts the **OUTPUT L/R** (analog) and **DIGITAL OUT** (digital) volume. If a USB connection is being used, this also adjusts the USB audio volume.

1. Go to the Play screen (p. 15).
2. Press [MENU] to get the Top Menu screen.
3. Press [▼] to move the cursor to the “6:Master Level” line, and press [ENTER].
The **MASTER LEVEL** screen will appear.
4. Turn the **VALUE** dial or use [DEC][INC] to adjust the “Master Level” value (0–127).

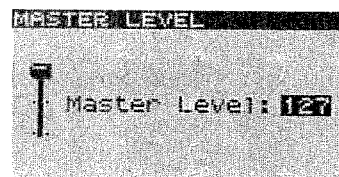

NOTE The OUTPUT L/R volume can also be adjusted by the top panel VOLUME knob; however, the VOLUME knob does not affect the DIGITAL OUT or USB audio volume.

5. Press [EXIT] to return to the Play screen.

NOTE This setting is not remembered when you turn off the power.

Chapter 13. About USB

When the SP-606 is connected to your computer via USB, it can send and receive MIDI messages, audio signals, files, and folders. The operating systems that can be used will depend on your setup, as shown in the table below.

Functionality	Operating System
Using the P606 application	Windows XP/2000
Transmitting/receiving audio and MIDI	Windows 98 or later, Mac OS 9.0 or later, Mac OS X 10.2 or later
Reading/writing memory card data	Windows Me/2000/XP, Mac OS 9.0.4 or later

NOTE The SP-606's power must be off when you connect or disconnect the USB cable. Never connect or disconnect the USB cable or turn off the power while data is being transferred or while P606 is running.

Installing the USB Driver

In order to take full advantage of the SP-606's capabilities, you will need to install the included USB driver in your computer.

Windows XP/2000 users:

From the "DRIVER/FACTORY DATA CD-ROM" (included), open "DRIVER\USB_XP2K\README_E.HTM," and install the USB driver as directed in the "Installation" procedure.

Windows Me/98 users:

From the "DRIVER/FACTORY DATA CD-ROM" (included), open "DRIVER\USB_ME98\README_E.HTM," and install the USB driver as directed in the "Installation" procedure.

Mac OS X users:

From the "DRIVER/FACTORY DATA CD-ROM" (included), open "DRIVER\OSX\Readme_E.htm," and install the USB driver as directed in the "Installation" procedure.

Mac OS 9 users:

From the "DRIVER/FACTORY DATA CD-ROM" (included), open "DRIVER\OS9\Driver E (Mac OS 9)\Readme_E.htm," and install the USB driver as directed in the "Installation" procedure.

NOTE The P606 application runs only on Windows XP/2000.

Making the USB Connection

NOTE In order to use the included P606 sequencer application for Windows, and to take full advantage of the SP-606's capabilities, you will need to install the included USB driver before you continue with the procedure below (p. 83).

1. Use a USB cable to connect the SP-606 to your computer.
2. Turn on the power of the SP-606 (p. 21).

NOTE To change the type of USB driver you are using, you will need to change the "Vendor Driver" setting (p. 84) before starting up your computer.

3. Start up your computer.

USB Audio Signal Flow

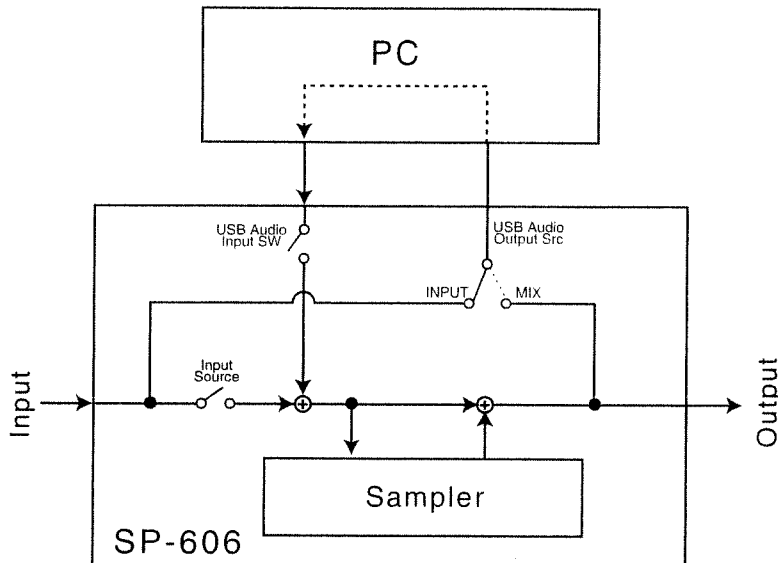

Making USB Audio and MIDI Settings

1. Make the USB connection (p. 83).
2. Press [MENU] to get the Top Menu screen.
3. Use [▼] [▲] to move the cursor to the "4:USB Audio/MIDI" line, and press [ENTER].
The **USB AUDIO/MIDI** screen will appear.
4. Use [▼] [▲] to select the **setting (parameter)** you want to edit.
Turn the **VALUE** dial or use [DEC][INC] to change the parameter value.

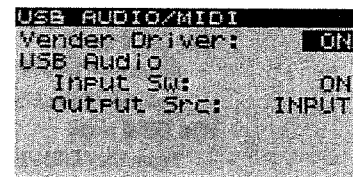

Parameter	Value	Explanation
Vender Driver	OFF, ON	Specifies the type of USB driver that will be used. OFF: Use the driver provided by Windows or Mac OS. * After you change this setting, you need to cycle the power to the SP-606. ON: Use the Roland driver. Choose this setting when using P606 or in order to take full advantage of the SP-606's capabilities.
USB Audio Input Sw	OFF, ON	Turns USB audio input on/off. * This setting is not remembered when you turn off the power.
USB Audio Output Src	OFF, INPUT, MIX	Selects the source that will be output to USB audio. (p. 84) OFF: Not used. INPUT: The audio signal selected for "Input Select" in the INPUT SETTING screen (p. 43) will be output directly to USB. MIX: The same audio signal as the OUTPUT and PHONES output will be sent to USB. * If you turn "USB Audio Input Sw" ON and make settings so that the audio signals coming into your USB-connected computer are being "thru-ed" (re-transmitted), be aware that the audio signals may loop and cause oscillation. Please use caution. * This setting is not remembered when you turn off the power.

5. Press [EXIT] to return to the Play screen.

Copying Files or Folders via USB

Here's how you can copy files or folders between a drive on your computer and a memory card inserted in the SP-606.

1. **Make the USB connection (p. 83).**
2. **Insert a memory card into the card slot (p. 22).**

NOTE Before using a memory card for the first time, you must format it on the SP-606 (p. 67). The SP-606 will not recognize a memory card that was formatted by another device.

3. **Press [MENU] to get the Top Menu screen.**
4. **Use [▼] [▲] to move the cursor to the "5:USB Mass Storage" line, and press [ENTER].**

The **USB MASS STORAGE** screen will appear.



5. **Press [ENTER] to enable the USB connection.**

If you decide to cancel, press [F3] (EXIT).

NOTE If a memory card is not inserted, a message of "Card Not Ready!" will appear.

Windows users:

The SP-606's memory card will appear on Windows as a drive named "Removable Disk" inside My Computer.

Macintosh users:

The SP-606's memory card will appear on the desktop as a drive icon showing the volume name of the memory card.

6. **To copy the desired files or folders, drag and drop them between a drive on your computer and the memory card drive shown in step 5.**

NOTE Do not modify, move, or delete any files or folders in the **ROLAND** folder of the memory card drive. The SP-606 will become unable to recognize the memory card if you do so.

7. **Terminate the USB connection.**

Windows users:

Use the "Safely Remove Hardware" button shown in the taskbar at the bottom right of the screen to terminate the connection with the SP-606. Then press [F3] (EXIT) or [EXIT] on the SP-606.

Macintosh users:

Drag the SP-606 drive icon into the trash. Then press [F3] (EXIT) or [EXIT] on the SP-606.

Chapter 14. About P606

* In order to use P606 you will need to install the included USB driver in your computer. Refer to "Installing the USB Driver" (p. 83).

* For details on how to use P606, refer to **P606 Help**.

* P606 will not start up unless the SP-606 is connected to your computer using USB.

Installing P606

Run the program setup.exe from the included "P606" CD-ROM. Install P606 as directed by the instructions that appear on your screen.

Controlling P606 from the SP-606

When using the SP-606 together with P606, you can set the SP-606 to External mode so the P606 can be controlled from the SP-606 (p. 15).

Before You Control P606 from the SP-606

1. Using USB, connect the SP-606 to your computer (p. 83).
2. Start up P606.
3. On the SP-606, press [EXT] so it's lit.

The screen will indicate "EXT Control."



List of Control Functions

Pads [1]-[16]

By holding down [FUNC] and pressing pads [1], [2], [3], [5], or [6], you can select the function that the pads will subsequently perform.

- Hold down [FUNC] and press pad [1] (PART SEL)
Pads [1]-[16] will directly select the identically numbered part within P606.

- Hold down [FUNC] and press pad [2] (MUTE)
Pads [1]-[16] will directly switch Mute on/off for the identically numbered part within P606.
- Hold down [FUNC] and press pad [3] (SOLO)
Pads [1]-[16] will directly switch Solo on/off for the identically numbered part within P606.
- Hold down [FUNC] and press pad [5] (NOTE TRIG)
Pads [1]-[16] will transmit note messages to P606; you can use the pads to play the current part within P606.
- Hold down [FUNC] and press pad [6] (SEQ TRIG)
Pads [1]-[16] will switch to the identically numbered current sequence within P606.

Cursor [▲][▼][◀][▶]

These buttons move the cursor within the "PART MIXER" of P606.

- [◀] (Left) / [▶] (Right)
Press these buttons to move the cursor between parts.
- [▲] (Up) / [▼] (Down)
Press these buttons to move the cursor between **SELECT**, **MUTE**, **SOLO**, **PAN**, and **LEVEL**.

VALUE dial, [DEC][INC]

These edit the value (**MUTE**, **SOLO**, **PAN**, **LEVEL**) at the cursor location.

[ENTER]

When the cursor is located at **MUTE** or **SOLO**, this button switches the setting on/off.

SEQUENCER [◀◀][▶▶][■][●]

These buttons correspond to the "TRANSPORT" buttons in P606.

CTRL 1-3 knobs, D Beam controller

These correspond to P606's "ASSIGNABLE CONTROLS" settings for the CTRL 1-3 knobs and D BEAM.

Troubleshooting

This section provides points to check and actions to take when the SP-606 does not function as you expect. Refer to the appropriate section for the problem you are experiencing.

The Screen Display Is Not Visible, or Is Difficult to Read

If you find the screen display difficult or impossible to read, hold down [KNOB ASSIGN] and turn the VALUE dial to adjust the contrast.

Problems When Playing Sounds

No Sound/Insufficient Volume

Is the SP-606 correctly connected to your external equipment?

Check the connections. (p. 20)

Could your audio cables be broken?

Could you be using a cable with a built-in resistor?

Use connection cables that do not have built-in resistors (such as the Roland PCS series).

Could the volume be lowered on the connected amp or mixer?

Adjust the volume to an appropriate level.

Could the volume of the SP-606 be too low?

Adjust the volume to an appropriate level.

Is there sound from the headphones?

If you hear sound from the headphones, the problem lies in a broken cable or in the amp or mixer that is connected. Check the connections and the connected devices. (p. 20)

In the MASTER screen, could "In Level," "Low Gain," or "High Gain" be lowered?

Adjust the various levels in the MASTERING screen appropriately. (p. 34)

Is the SP-606 in External mode?

Samples will not sound in External mode. (p. 15)

Specific Pads Do Not Sound

Could the level of the sample be lowered?

Adjust the level of the sample. (p. 50)

Try turning off the MFX1 and MFX2 switches.

If you now hear sound, it may be that the level was being constrained by the MFX parameters, or that the MFX type was set to "ENVELOPER (PAD)." Adjust the parameters to appropriate settings. If the MFX type is "ENVELOPER (PAD)," striking a pad will apply an envelope so that the sound will be heard.

The Sound Stops Unexpectedly

Could a Mute Group be specified?

Turn off the Mute Group. (p. 50)

Could "Trig Mode" be set to ALTERNATE?

If "Trig Mode" is set to ALTERNATE, the sample will alternately play or stop each time you strike the pad. If you want the sample to sound each time you strike the pad, set "Trig Mode" to GATE or SHOT. (p. 50)

The Sound Does Not Stop

Could "Trig Mode" be set to SHOT?

If "Trig Mode" is set to SHOT, the sample will play all the way to its end, so that for a long sample it may seem that the sound does not stop. If you set "Trig Mode" to ALTERNATE, the sample will alternately play or stop each time you strike the pad. Or, if you set "Trig Mode" to GATE, the sample will continue playing only as long as you hold down the pad. (p. 50)

Could the Loop setting of the sample be turned on?

Turn looping off. (p. 50)

Can't Control the Volume by Varying Your Striking Force on the Pads

Could "Pad Velocity" be set to a fixed setting?

If you want to control the volume by varying your striking force on the pads, you must set "Pad Velocity" to REAL. (p. 31)

No Sound from a Device Connected to LINE IN

Is the [INPUT SOURCE] pad lit?

If you want to output sound from an external input source, press the [INPUT SOURCE] pad so it is lit. (p. 25)

Is "Input Select" set to LINE?

In the INPUT SETTING screen, set "Input Select" to LINE. (p. 43)

Could the AUDIO IN REC LEVEL be lowered?

Adjust the AUDIO IN REC LEVEL knob until the level is appropriate. (p. 44)

Could the level of the connected device be lowered?

Adjust the volume appropriately.

Could you be using a cable with a built-in resistor?

Use connection cables that do not have built-in resistors (such as the Roland PCS series).

No Sound from a Device Connected to DIGITAL IN

Is the [INPUT SOURCE] pad lit?

If you want to output sound from an external input source, press the [INPUT SOURCE] pad so it is lit. (p. 25)

Has the correct setting been made in the INPUT SETTING screen?

In the INPUT SETTING screen, set "Input Select" to DIGITAL, and adjust the "Digital In Level" appropriately. (p. 43)

Could the level of the connected device be lowered?

Adjust the volume appropriately.

No Sound from Your Computer

Make the correct "USB Audio/MIDI" settings. (p. 84)

No Sound from the Mic/Insufficient Volume

Is the [INPUT SOURCE] pad lit?

If you want to output sound from an external input source, press the [INPUT SOURCE] pad so it is lit. (p. 25)

Is "Input Select" set to MIC?

In the INPUT SETTING screen, set "Input Select" to MIC. (p. 43)

Could the AUDIO IN REC LEVEL be lowered?

Adjust the AUDIO IN REC LEVEL knob until the level is appropriate. (p. 44)

Can't Sample

If you're sampling to a memory card, has the memory card been formatted by the SP-606?

Format the memory card on the SP-606. (p. 67)

Sampled Sound Contains Noise or Distortion

Is the input level appropriate?

If the input level is too high, the sampled sound will be distorted. If the input level is too low, the sampled sound will contain obtrusive noise. Watch the level meter displayed in the screen, and adjust the AUDIO IN REC LEVEL knob appropriately. (p. 44)

Memory-Related Problems

Data Was Not Saved Correctly

It is possible that you didn't turn off the power correctly.

In particular, if you turn off the power while the display still indicates "Processing ...," not only will the data not be saved correctly, but other data may also be damaged. The damaged data cannot be recovered. Always be sure to turn off the power using the correct procedure. (p. 21)

Can't Select Data from a Memory Card

Is the memory card inserted correctly?

Shut down the SP-606, remove the memory card, and reinsert it all the way into the slot. (p. 22)

Is the memory card of the correct type?

The SP-606 can use CompactFlash cards with a capacity of from 16 MB through 512 MB (3.3V). No other types of cards can be used.

Was the memory card formatted correctly?

Only memory cards that were formatted by the SP-606 can be used. Format the memory card on the SP-606. (p. 67)

Sequencer-Related Problems

After Recording, There's No Sound When You Play Back the Song or Pattern

Could the tracks be muted?

Un-mute the tracks. (p. 25, p. 59, p. 66)

Playback Lags or Is Interrupted

This can occur if a heavy processing load is being placed on the sequence playback or sample playback. The most likely reasons and the appropriate actions to take are as follows.

Could more than eight notes be playing simultaneously?

Try decreasing the number of notes.

Could a large amount of data be concentrated at the beginning of the beats in a pattern?

If you used step-recording to input data, or if you applied quantization to realtime recording, it is easy for data to become concentrated at the beginning of the beats in a pattern. Using **MICROSCOPE**, try shifting data located at the same time so that the data is separated by one or two clocks.

Problems When Playing Samples from an External MIDI Device or Computer

Samples Don't Sound

Is the cable connected correctly?

Check the MIDI or USB cable connection.

Are you transmitting the correct note for the sample?

In order to play a sample from an external device, you must transmit the appropriate note number on the appropriate channel.

For the correspondence between samples and note numbers, refer to "MIDI on the SP-606." (p. 78)

Message Lists/ Recommended Memory Cards

Message Lists

Memory (Card)

Message	Explanation	Action
SYSTEM DAMAGED	A serious problem has occurred in the memory because the power was not turned off correctly. The memory has been initialized in order to recover the contents; please turn the power off and then on again.	You must use the correct procedure to turn off the power. (p. 21)
MEMORY INITIALIZE	Memory was lost because the power was not turned off correctly. The memory is being initialized.	
MEMORY RESTORE	Part of the memory was damaged because the power was not turned off correctly. The memory contents are being recovered.	
Memory Full!	The operation cannot be executed because there is not enough remaining memory.	Delete unneeded data (samples, patterns, songs). (p. 32, p. 62, p. 65)
Memory Damaged!	The contents of internal memory were damaged.	Execute the System Initialize operation (p. 80). If this does not resolve the problem, contact your dealer or a Roland service center.
Not Supported Format!	You inserted a card of a capacity that the SP-606 cannot use.	The SP-606 can use CompactFlash cards with a capacity of from 16 MB through 512 MB (3.3V). Check the card you are using.
	You are attempting to import an audio file that the SP-606 cannot import.	Check the points of caution regarding the import of audio files (p. 68).
Unformatted!	You inserted a memory card of a format that the SP-606 cannot use.	Format the memory card. (p. 67)
Card Damaged!	The contents of the memory card were damaged.	
Card Ejected!	You removed the card without performing the Shutdown procedure. The contents of internal memory or the memory card may have been damaged.	—

NOTE Roland Corporation accepts no responsibility for the recovery of data lost from internal memory or memory card, nor any damages resulting from such loss.

MIDI

Message	Explanation	Action
MIDI RxError!	The received MIDI message was invalid.	Make sure that the MIDI device connected to the SP-606 is operating correctly.
MIDI Buffer Full!	Too many MIDI messages were received at the same time and could not be successfully processed.	Reduce the amount of MIDI messages being sent to the SP-606.
MIDI Offline!	There is a problem with the MIDI cable or USB cable connection.	Check whether the MIDI cable or USB cable has been disconnected or broken.

Protect

Message	Explanation	Action
Protected Pad Bank!	The operation cannot be executed because Bank Protect is turned on.	Either use a bank that is not protected, or defeat the Bank Protect setting. (p. 31)
Protected Pattern!	The operation cannot be executed because the preloaded pattern protect setting is turned on.	Either use a pattern that is not protected, or defeat the Protect setting. (p. 58)

Other

Message	Explanation	Action
No Backup Data!	You selected a backup file that contains no data.	Select a backup file that contains data, and execute the operation again. (p. 70, p. 71)
Empty Pad!	You selected a pad that contains no sample.	Select a pad that contains a sample, and execute the operation again.

Recommended Memory Cards

As of the date of writing, the following memory cards have been tested by Roland and found to operate correctly with the SP-606.

Maker	Model number
DELKIN DEVICES	DDCFLLS-064 (eFilm) (64 MByte)
LEXAR	CF*** 8X USB (***: card capacity)
Memorex	THNCF064MMA (64 MByte), THNCF128MBA (128 MByte)
PNY TECHNOLOGIES	THNCF064MBA (P-CF064-RF) (64 MByte), THNCF128MBA (P-CF128-RF) (128 MByte)
PQI (Power Quotient International)	FC128 (Hi-Speed) (128 MByte)
SanDisk	ultra series
SST (Silicon Storage Technology, Inc.)	SST48CF032 (32 MByte)
vivanco	FC032 (CFC F32) (32 MByte)
hama	THNCF128MMA (128 MByte), FC128 (Hi-Speed) (128 MByte)
HAGIWARA SYS-COM	V series, Z series
HITACHI	C6 series

MIDI Implementation

Model: SP-606
Date: Mar. 30, 2004
Version: 1.00

1. Receive data

■ Channel Voice Messages

* For the correspondence between note numbers and pad banks, refer to "MIDI on the SP-606" (p. 78).

● Note Off

Status	2nd byte	3rd byte
8nH	kkH	vvH
9nH	kkH	00H

n = MIDI channel number: 0H - FH (ch.1 - ch.16)
kk = note number: 23H - 62H (35 - 98)
vv = note off velocity: 00H - 7FH (0 - 127)

● Note On

Status	2nd byte	3rd byte
9nH	kkH	vvH

n = MIDI channel number: 0H - FH (ch.1 - ch.16)
kk = note number: 23H - 62H (35 - 98)
vv = note on velocity: 01H - 7FH (1 - 127)

● Control Change

○ MFX1 Type (Controller number 12)

Status	2nd byte	3rd byte
BnH	0CH	vvH

n = MIDI channel number: 0H - FH (ch.1 - ch.16)
vv = Control value: 00H - 7FH (0 - 127)

○ MFX1 CTRL1 (Controller number 13)

Status	2nd byte	3rd byte
BnH	0DH	vvH

n = MIDI channel number: 0H - FH (ch.1 - ch.16)
vv = Control value: 00H - 7FH (0 - 127)

○ MFX1 CTRL2 (Controller number 14)

Status	2nd byte	3rd byte
BnH	0EH	vvH

n = MIDI channel number: 0H - FH (ch.1 - ch.16)
vv = Control value: 00H - 7FH (0 - 127)

○ MFX1 CTRL3 (Controller number 15)

Status	2nd byte	3rd byte
BnH	0FH	vvH

n = MIDI channel number: 0H - FH (ch.1 - ch.16)
vv = Control value: 00H - 7FH (0 - 127)

○ MFX2 Type (Controller number 20)

Status	2nd byte	3rd byte
BnH	14H	vvH

n = MIDI channel number: 0H - FH (ch.1 - ch.16)
vv = Control value: 00H - 7FH (0 - 127)

○ MFX2 CTRL1 (Controller number 21)

Status	2nd byte	3rd byte
BnH	15H	vvH

n = MIDI channel number: 0H - FH (ch.1 - ch.16)
vv = Control value: 00H - 7FH (0 - 127)

○ MFX2 CTRL2 (Controller number 22)

Status	2nd byte	3rd byte
BnH	16H	vvH

n = MIDI channel number: 0H - FH (ch.1 - ch.16)
vv = Control value: 00H - 7FH (0 - 127)

○ MFX2 CTRL3 (Controller number 23)

Status	2nd byte	3rd byte
BnH	17H	vvH

n = MIDI channel number: 0H - FH (ch.1 - ch.16)
vv = Control value: 00H - 7FH (0 - 127)

○ MFX1 Switch (Controller number 24)

Status	2nd byte	3rd byte
BnH	18H	vvH

n = MIDI channel number: 0H - FH (ch.1 - ch.16)
vv = Control value: 00H - 7FH (0 - 127) (0 - 63 = OFF, 64 - 127 = ON)

○ MFX2 Switch (Controller number 25)

Status	2nd byte	3rd byte
BnH	19H	vvH

n = MIDI channel number: 0H - FH (ch.1 - ch.16)
vv = Control value: 00H - 7FH (0 - 127) (0 - 63 = OFF, 64 - 127 = ON)

■ Channel Mode Messages

* If the following channel mode message is received during realtime recording, note-off messages will be generated for all notes on the corresponding channel that are currently on, and those note-off messages will be recorded.

● All Sounds Off (Controller number 120)

Status	2nd byte	3rd byte
BnH	78H	00H

n = MIDI channel number: 0H - FH (ch.1 - ch.16)

* If the All Sound Off message is received, all notes will be silenced regardless of their channel.

● All Notes Off (Controller number 123)

Status	2nd byte	3rd byte
BnH	7BH	00H

n = MIDI channel number: 0H - FH (ch.1 - ch.16)

■ System Common Message

● Song Position Pointer

Status	2nd byte	3rd byte
F2H	mmH	llH
(mm ll: 00 00H - 7F 7FH (0 - 16383))		

* This message is received if Sync Mode is SLAVE.

■ System Realtime Message

● Timing Clock

Status
F8H

* This message is received if Sync Mode is SLAVE.

● Start

Status
FAH

* This message is received if Sync Mode is SLAVE or REMOTE.

● Continue

Status
FBH

* This message is received if Sync Mode is SLAVE or REMOTE.

● Stop

Status
FCH

* This message is received if Sync Mode is SLAVE or REMOTE.

● Active Sensing

Status
FEH

■ System Exclusive Message

Status	Data byte	Status
F0H	iiH, ddH,, eeH	F7H

F0H: System Exclusive Message status
 ii = ID number: an ID number (manufacturer ID) to indicate the manufacturer whose Exclusive message this is. Roland's manufacturer ID is 41H.
 ID numbers 7EH and 7FH are extensions of the MIDI standard; Universal Non-realtime Messages (7EH) and Universal Realtime Messages (7FH).
 dd....., ee = data: 00H - 7FH (0 - 127)
 F7H: EOX (End Of Exclusive)

● Universal Non-realtime System Exclusive Messages

○ Identity Request

Status	Data byte	Status
F0H	7EH, dev, 06H, 01H	F7H

Byte	Explanation
F0H	Exclusive status
7EH	ID number (universal non-realtime message)
dev	Device ID (00H - 1FH (1 - 32))
06H, 01H	Identity Request

F7H EOX (End Of Exclusive)

* Even if the Device ID is 7FH (Broadcast), Identity reply message will be transmitted.

○ Data set 1 (DT1)

Status	Data byte	Status
F0H	41H, dev, 00H, 6EH, 12H, F7H aaH, bbH, ccH, ddH, eeH.... ffH, sum	

Byte	Explanation
F0H	Exclusive status
41H	ID number (Roland)
dev	Device ID (00H - 1FH (1 - 32))
00H 6EH	Model ID (SP-606)
12H	Command ID (DT1)
aaH	Address MSB
bbH	Address
ccH	Address
ddH	Address LSB
eeH	Data: the actual data to be transmitted. Multiple bytes of data are transmitted starting from the address.
:	:
ffH	Data
sum	Checksum
F7H	EOX (End Of Exclusive)

2. Transmit data

* For details on the messages that are transmitted during V-LINK operation, refer to "Chapter 10. About V-LINK" (p. 75).

■ Channel Voice Messages

* Channel voice messages are transmitted in NOTE TRIG mode.
 * For the correspondence between note numbers and pad banks, refer to "MIDI on the SP-606" (p. 78).

● Note Off

Status	2nd byte	3rd byte
8nH	kkH	40H

n = MIDI channel number: 0H - 7H (ch.1 - ch.8)
 kk = note number: 23H - 62H (35 - 98)

● Note On

Status	2nd byte	3rd byte
9nH	kkH	vvH

n = MIDI channel number: 0H - 7H (ch.1 - ch.8)
 kk = note number: 23H - 62H (35 - 98)
 vv = note on velocity: 01H - 7FH (1 - 127)

■ System Common Message

● Song Position Pointer

Status	2nd byte	3rd byte
F2H	mmH	llH
(mm ll: 00 00H - 7F 7FH (0 - 16383))		

* This message is transmitted only if Tx MIDI Sync is ON.

System Realtime Message

Timing Clock

Status
F8H

* This message is transmitted only if Tx MIDI Sync is ON.

Start

Status
FAH

* This message is transmitted only if Tx MIDI Sync is ON or during EXT SEQ SAMPLING.

Continue

Status
FBH

* This message is transmitted only if Tx MIDI Sync is ON or during EXT SEQ SAMPLING.

Stop

Status
FCH

* This message is transmitted only if Tx MIDI Sync is ON or during EXT SEQ SAMPLING.

Active Sensing

Status
FEH

System Exclusive Message

Universal Non-realtime System Exclusive Messages

Identity Reply

Status	Data byte	Status
F0H	7EH, 10H, 06H, 02H, 41H, F7H	
	6EH, 01H, 00H, 00H,	
	00H, 02H, 00H, 00H	

Byte	Explanation
F0H	Exclusive status
7EH	ID number (universal non-realtime message)
10H	Device ID
06H 02H	Identity Reply
41H	ID number (Roland)
6EH 01H	Device family code
00H 00H	Device family number code
00H 02H 00H 00H	software revision level
F7H	EOX (End Of Exclusive)

Data set 1 (DT1)

Status	Data byte	Status
F0H	41H, 10H, 00H, 6EH, 12H, F7H	
	aaH, bbH, ccH, ddH, eeH,...	
	ffH, sum	

Byte	Explanation
F0H	Exclusive status
41H	ID number (Roland)
10H	Device ID
00H 6EH	Model ID (SP-606)

12H	Command ID (DT1)
aaH	Address MSB
bbH	Address
ccH	Address
ddH	Address LSB
eeH	Data: the actual data to be sent. Multiple bytes of data are transmitted in order starting from the address.
:	:
ffH	Data
sum	Checksum
F7H	EOX (End Of Exclusive)

3. Parameter address map

Addresses Transmitted and Received When Switching to EXT Mode

The following address is transmitted and received when switching to EXT mode.

Address	Description	Data (Value)
00 00 00 00	EXT Control mode	0 (OFF), 1 (ON/PART SELECT), 2 (ON/MUTE), 3 (ON/SOLE), 4 (ON/SEQ TRIGGER), 5 (ON/NOTE TRIGGER)

■Addresses Transmitted by Panel Operations

The following addresses are transmitted when you operate the panel in EXT mode.

Address	Description	Data (Value)
01 00 00 00	TRIGGER (D BEAM)	0 (OFF),
01 00 00 01	SYNTH (D BEAM)	1 (ON)
01 00 00 02	V-LINK	
01 00 00 03	FILTER (D BEAM)	
01 00 00 04	MENU	
01 00 00 05	F1	
01 00 00 06	F2	
01 00 00 07	F3	
01 00 00 08	BPM	
01 00 00 09	▲ (CURSOR)	
01 00 00 0a	◀ (CURSOR)	
01 00 00 0b	▼ (CURSOR)	
01 00 00 0c	▶ (CURSOR)	
01 00 00 0d	EXIT	
01 00 00 0e	ENTER	
01 00 00 0f	DEC	
01 00 00 10	INC	
01 00 00 11	MASTERING	
01 00 00 12	MFX1	
01 00 00 13	MFX2	
01 00 00 14	KNOB ASSIGN	
01 00 00 15	SONG	
01 00 00 16	PTN	
01 00 00 17	1 (TRACK)	
01 00 00 18	2 (TRACK)	
01 00 00 19	3 (TRACK)	
01 00 00 1a	4 (TRACK)	
01 00 00 1b	◀◀ (TOP)	
01 00 00 1c	◀◀ (BWD)	
01 00 00 1d	▶▶ (FWD)	
01 00 00 1e	■ (STOP)	
01 00 00 1f	▶ (PLAY)	
01 00 00 20	● (REC)	
01 00 00 21	(reserved)	
01 00 00 22	(reserved)	
01 00 00 23	PAD BANK	
01 00 00 24	FUNC	
01 00 00 25	ROLL	
01 00 00 26	CLIP BOARD	
01 00 00 27	SAMPLING	
01 00 00 28	HOLD	
01 00 00 29	INPUT SOURCE	
02 00 00 00	CTRL1	0-127
02 00 00 01	CTRL2	
02 00 00 02	CTRL3	
02 00 00 03	D BEAM	
03 00 00 00	VALUE Increment	1-127
03 00 00 01	VALUE Decrement	
04 00 00 00	PAD 1	0 (MUTE),
04 00 00 01	PAD 2	1 (reserved),
04 00 00 02	PAD 3	2 (PART SELECT),
04 00 00 03	PAD 4	3 (SOLO),
04 00 00 04	PAD 5	4 (SEQ TRIGGER)
04 00 00 05	PAD 6	(*1)
04 00 00 06	PAD 7	
04 00 00 07	PAD 8	
04 00 00 08	PAD 9	
04 00 00 09	PAD 10	
04 00 00 0a	PAD 11	
04 00 00 0b	PAD 12	
04 00 00 0c	PAD 13	
04 00 00 0d	PAD 14	
04 00 00 0e	PAD 15	
04 00 00 0f	PAD 16	

(*1): This is transmitted when you press a pad (it is not transmitted when you release the pad). It is not transmitted for NOTE TRIG.

■Other Addresses Received

For addresses marked by #, the data is divided into multiple pieces for reception.

Example: for Beat = 32

32 is expressed in hexadecimal as 020H. 020H is divided as [00H 02H 00H].

Address	Description	Data (Value)
10 00 00 00	PAD 1 LED	0 (OFF),
10 00 00 01	PAD 2 LED	1 (ON),
10 00 00 02	PAD 3 LED	2 (BLINK)
10 00 00 03	PAD 4 LED	
10 00 00 04	PAD 5 LED	
10 00 00 05	PAD 6 LED	
10 00 00 06	PAD 7 LED	
10 00 00 07	PAD 8 LED	
10 00 00 08	PAD 9 LED	
10 00 00 09	PAD 10 LED	
10 00 00 0a	PAD 11 LED	
10 00 00 0b	PAD 12 LED	
10 00 00 0c	PAD 13 LED	
10 00 00 0d	PAD 14 LED	
10 00 00 0e	PAD 15 LED	
10 00 00 0f	PAD 16 LED	

Address	Description	Data (Value)
# 11 00 00 00	0000 aaaa 0000 bbbb 0000 cccc	EXT SEQ SAMPLING BPM 400 (40.0)– 2000 (200.0)
# 11 00 00 03	0000 aaaa 0000 bbbb 0000 cccc	EXT SEQ SAMPLING Beat 1–999
11 00 00 06	00aa aaaa	EXT SEQ SAMPLING Meter num 1–32
11 00 00 07	0000 0aaaa	EXT SEQ SAMPLING Meter den 1 (2BEAT), 2 (4BEAT), 3 (8BEAT), 4 (16BEAT)

4. Supplementary material

■Calculation of the Checksum of Exclusive Messages

Roland Exclusive messages (RQ1, DT1) are transmitted with a checksum at the end (before F7) to make sure that the message was correctly received.

The value of the checksum is determined by the address and data (or size) of the transmitted exclusive message.

○How to calculate the checksum (hexadecimal numbers are indicated by "H")

The checksum is a value derived by adding the address, size and checksum itself and inverting the lower 7 bits.

Here's an example of how the checksum is calculated.

We will assume that in the exclusive message we are transmitting, the address is aa bb cc ddH and the data or size is ee ff gg hhH.

$$aa + bb + cc + dd + ee + ff + gg + hh = \text{sum}$$

$$\text{sum} / 128 = \text{quotient} \dots \text{remainder}$$

$$128 - \text{remainder} = \text{checksum}$$

(However, the checksum will be 0 if the remainder is 0.)

The SP-606 will process the data even if the received checksum is incorrect.

MIDI Implementation Chart (INT MODE)

Model SP-606 (INT MODE)

Date : Mar. 30,2004

MIDI Implementation Chart

Version : 1.00

Function...	Transmitted	Recognized	Remarks
Basic Default Channel Changed	X X	1-16 1-16	
Mode Default Messages Altered	X X *****	Mode 3 X	
Note Number : True Voice	X *****	35-98 35-98	
Velocity Note On Note Off	X X	O X	
After Key's Touch Channel's	X X	X X	
Pitch Bend	X	X	
Control Change	12 X 13 X 14 X 15 X 20 X 21 X 22 X 23 X 24 X 25 X	O O O O O O O O O O	MFx1 TYPE MFx1 CTRL 1 MFx1 CTRL 2 MFx1 CTRL 3 MFx2 TYPE MFx2 CTRL 1 MFx2 CTRL 2 MFx2 CTRL 3 MFx1 SWITCH MFx2 SWITCH
Program Change : True Number	X *****	X	
System Exclusive	O	O	
System : Song Position Common : Song Select : Tune Request	O X X	*0 X X	*2
System : Clock Real Time : Commands	O O	*0 *1	*2 *3
Aux Messages : All Sound Off : Reset All Controllers : Local On/Off : All Notes Off : Active Sensing : System Reset	X X X X O X	O X X X O X	
Notes	*0 Transmitted if Tx MIDI Sync is ON. *1 Transmitted if Tx MIDI Sync is ON, or while EXT SEQ SAMPLING is being executed. *2 Received if Sync Mode is SLAVE. *3 Received if Sync Mode is SLAVE or REMOTE.		

Mode 1 : OMNI ON, POLY
Mode 3 : OMNI OFF, POLY

Mode 2 : OMNI ON, MONO
Mode 4 : OMNI OFF, MONO

O : Yes
X : No

Model SP-606 (EXT MODE)

Date : Mar. 30,2004

MIDI Implementation Chart

Version : 1.00

Function...	Transmitted	Recognized	Remarks
Basic Channel Default Changed	1-8 1-8	1-16 1-16	
Mode Default Messages Altered	Mode 3 X *****	Mode 3 X	
Note Number : True Voice	35-98 *****	35-98 35-98	
Velocity Note On Note Off	O X	O X	
After Touch Key's Channel's	X X	X X	
Pitch Bend	X	X	
Control Change	12 X 13 X 14 X 15 X 20 X 21 X 22 X 23 X 24 X 25 X	O O O O O O O O O O	MFX1 TYPE MFX1 CTRL 1 MFX1 CTRL 2 MFX1 CTRL 3 MFX2 TYPE MFX2 CTRL 1 MFX2 CTRL 2 MFX2 CTRL 3 MFX1 SWITCH MFX2 SWITCH
Program Change : True Number	X *****	X	
System Exclusive	O	O	
System Common : Song Position : Song Select : Tune Request	O X X	*0 X X	*2
System Real Time : Clock : Commands	O O	*0 *1 O	*2 *3
Aux Messages : All Sound Off : Reset All Controllers : Local On/Off : All Notes Off : Active Sensing : System Reset	X X X X O X	O X X X X X	
Notes	*0 Transmitted if Tx MIDI Sync is ON. *1 Transmitted if Tx MIDI Sync is ON, or while EXT SEQ SAMPLING is being executed. *2 Received if Sync Mode is SLAVE. *3 Received if Sync Mode is SLAVE or REMOTE.		

Mode 1 : OMNI ON, POLY
Mode 3 : OMNI OFF, POLY

Mode 2 : OMNI ON, MONO
Mode 4 : OMNI OFF, MONO

O : Yes
X : No

Specifications

SP-606: Sampling Workstation

Maximum Polyphony

8 voices

Maximum Sampling Time (mono, approx.)

Internal Memory

STANDARD LONG

5 min. 11 min.

* Including Pre-loaded Sample Banks

Card Memory (CompactFlash)

Card capacity STANDARD LONG

16 MB 5 min. 11 min.

32 MB 12 min. 24 min.

64 MB 24 min. 48 min.

128 MB 48 min. 96 min.

256 MB 96 min. 193 min.

512 MB 193 min. 386 min.

Sampling Mode

STANDARD/LONG

Sampling Frequency

44.1 kHz

Data Format

SP-606 original format

(.WAV / AIFF import/export possible)

Internal Memory

Samples: 128 (8 Banks)

* Including Pre-loaded Sample Banks

Card Memory

Sample: 384 (24 Banks)

Effects Section

Multi-Effects: 2 systems, 45 types

Mastering Effect: 2-bands Compressor

Sequencer Section

Mode: PATTERN, SONG

Tracks: 4

Resolution: 96 ticks per quarter note

Song Steps: 999

Songs: 25

Patterns: 140

* Including Pre-loaded Patterns

Maximum measures per Pattern: 32

Beats: 2/4-32/4

Tempo: 40.0-200.0

Pattern recording method: Realtime, Step Recording (Note/Sample)

Maximum recordable notes: Approximately 18,000 notes
(Approx. 8,000 per Pattern)

Others

Display: 128 x 64 dots (Backlit graphic LCD)

Controllers: Control Knobs x 3, D Beam

Pads: 16 with velocity sensitivity

Connectors

Headphones Jack

Output Jacks (L (MONO), R)

Input Jacks (L (MONO)/MIC, R)

Foot Switch Jack

Digital Audio Interfaces (COAXIAL, IN/OUT)

MIDI Connectors (IN, OUT)

USB Connector (compatible with MIDI, audio and mass storage class)

AC Adaptor Jack

Power Supply

DC 9 V (AC Adaptor)

Current Draw

1,000 mA

Dimensions

358.3 (W) x 271.2 (D) x 84.0 (H) mm

14-1/8 (W) x 10-11/16 (D) x 3-5/16 (H) inches

Weight

2.3 kg

5 lbs 2 oz

* *Excluding AC Adaptor*

Accessories

Owner's Manual

AC Adaptor (ACI Series or PSB-1U)

USB Cable

CD-ROM (USB MIDI/AUDIO driver, P606)

Card theft prevention cover

Options

Pedal Switch (DP-2)

Foot Switch (BOSS FS-5U)

P606 System Requirements**Operating System**

Microsoft® Windows® 2000/XP

CPU/Clock

Pentium®-class

Pentium® 4 1.7 GHz or higher recommended

Memory (RAM)

256 MB or more

(512 MB or more recommended)

Display

1024 x 768 pixels or higher

Hard Disk

500 MB or more

USB Port**CD-ROM Drive (required for installation)**

- While under most conditions, a computer similar to the above will permit normal operation of the P606, Roland cannot guarantee compatibility solely on these factors. This is due to numerous variables that may influence the processing environment, such as differences in motherboard design and the particular combination of other devices involved.

- * In the interest of product improvement, the specifications and/or appearance of this unit/package are subject to change without prior notice.

Index

A

AC adaptor 19–20
Assign 50
AUDIO IN REC LEVEL 17, 25–26, 43–44
Auto Trig 27, 44, 46–49

B

Backup 70–71
BACKUP DELETE 71
BACKUP LOAD 70
BACKUP SAVE 70
Bank Select 77
Beat 48, 51, 54, 56–57
BPM 17, 25, 48, 66
BPM SYNC 52

C

CARD FORMAT 67
Card Slot 18, 22
CARD UTILITY 67–71
CHOP 53
CHOP SAMPLE WRITE 53
CLIP BOARD 18, 32
Control Knob 33
Copy 32
Cord Hook 19–20
Count In 54
CREATE EVENT 60
CTRL 1 17, 33
CTRL 2 17
CTRL 3 17
Cutoff High 74
Cutoff Low 74

D

D BEAM 16
D BEAM INFO 72, 74
D Beam Information 74
D Beam Sens 81
D BEAM SETTING 72
DEC 17
DIGITAL 19–20, 25–26, 43
Digital In Level 44

E

Effect 12, 35, 45
Effect Ctrl Ch 79
EFFECT INFO 33–34
End 51
ENTER 17
ERASE 60
EXIT 17
EXT 18, 49
EXT Control 86
EXT SEQ SMPL STANDBY 48–49
External 15
External Sequence Sampling Standby 48–49

F

F1 17
F2 17
F3 17
Fast-forward 17
FILE EXPORT 69
FILE IMPORT 68
File Type 69
FILTER 16, 72, 74
Foot Sw Assign 81
FOOT SWITCH 19
FUNC 18

G

Gain 74
Gate Time 56
Ground Terminal 19

H

HOLD 18, 31

I

INC 17
INPUT 19–20, 25–26, 43
Input Select 26, 43
Input Send Sel 43
INPUT SETTING 26, 43
INPUT SOURCE 18, 26–27
INT 18
Internal 15

K

KNOB ASSIGN 17, 33

L

LCD Contrast	81
Level	50, 53, 73
LFO Rate	74
LFO Wave	74
Load Factory Data	80
Loop	28
Loop Sw	28, 50

M

MASTER LEVEL	82
MASTERING	17, 33–34, 45
MASTERING SETUP LIST	34
Meas	54, 56–57
Measure	51
Memory Card	22, 67
MENU	17
Meter	49
Metro. Mode	81
Metronome Level	81
MFX ASSIGN	34
MFX1	17, 33, 45
MFX1 TYPE LIST	34
MFX2	17, 33, 45
MFX2 TYPE LIST	34
MICROSCOPE EDIT	59, 60
MIDI	19, 76, 78
MIDI UTILITY	79
MOVE EVENT	60
Mute	25, 66
Mute Group	50

N

Note Number	78
-------------------	----

O

Osc Wave	73
OUTPUT	19–20

P

P606	11, 49, 86
Pad	12, 18, 23, 78
PAD BANK	14, 18, 23
PAD BANK PROTECT	31
Pad Base Ch	79
PAD DELETE	32
Pad Number	73
Pad Sens	23, 31
Pad Tx Mode	79
PAD UTILITY	23, 30–32
Pad Velocity	23, 31, 73

Pan	50
Pattern	14, 24–25, 54, 56–57
PATTERN BPM	58
PATTERN COPY	62
PATTERN DELETE	62
PATTERN EDIT	58–59, 61–62
PATTERN LIST	24
PATTERN NAME	61
Percentage	61
PHONES	19–20
Phrase Sample	13
Pitch High	73
Pitch Low	73
Play	17
Play Screen	15
Play Type	50
PORTAMENT TIME	74
Position	61
POWER	19–21
Preload Ptn	58, 81
Preloaded Pattern	24
Preloaded Pattern Protect	58
Program Change	77
PTN	17
PWM Depth	73
PWM Duty	73

Q

Qtz Reso	54
----------------	----

R

REALTIME ERASE	55
REALTIME REC STANDBY	54
REALTIME RECORDING	55
Realtime Recording Standby	54
Record	17
RECORDING MENU	54, 56–57
Redo	15
Rehearsal	55
REMAIN	44, 46–49
RESAMPLING STANDBY	46–47
Resonance	74
Reverse	29
Reverse Sw	29, 50
Rewind	17
ROLL	18, 30
Roll Resolution	31

S

Sample	13, 23
SAMPLE EDIT	28–29, 50
SAMPLE LOOP EDIT	51
Sampler	12
SAMPLING	18, 26–27, 42, 49
Sampling Grade	43, 81
SAMPLING MENU	27, 44, 46–48
SAMPLING STANDBY	27, 44
Scale	73
Screen	17
Security Slot	19
Send Select	73
Sequencer	12
SHUTDOWN	21–22
Silence	25, 66
Single Sample	13
Slope	74
Soft Thru	79
SONG	17
Song	14, 66
SONG BPM	64
SONG COPY	65
SONG DELETE	65
SONG EDIT	64–65
SONG LIST	66
SONG NAME	64
SONG RECORDING	63
Start	51
STEP REC NOTE STANDBY	56
STEP REC SAMPLE STANDBY	57
STEP RECORDING	57
STEP RECORDING NOTE	56
Step Recording Note Standby	56
Step Recording Sample Standby	57
Step Time	56
Stereo Sw	44, 46–49
Stop	17
Sub Pad Sw	30–31
SWING	61
Sync Mode	79
Sync Source	79
SYNTH	16, 72–73
SYSTEM	58, 81
SYSTEM INFO	82
System Information	82
SYSTEM INITIALIZE	80

T

Tap Tempo	25, 66
Tempo	25, 52, 58, 64, 66
Top	17
TRACK	17
Track	25, 66
Track 1	61
Track 2	61
Track 3	61
Track 4	61
Track Mute	59
Trig Mode	28, 50, 73
TRIGGER	16, 72–73
Tx MIDI Sync	79
Type	52, 74

U

Undo	15
USB	19, 83
USB Audio Input Sw	84
USB Audio Output Src	84
USB AUDIO/MIDI	84
USB MASS STORAGE	85

V

VALUE	17
Velo	46
Velocity	56–57
Vender Driver	84
Vibrato Depth	74
V-LINK	16, 75
V-LINK Setup	76
VOLUME	17, 21

W

Wave Pointer	51
--------------------	----

For the U.K.

IMPORTANT: THE WIRES IN THIS MAINS LEAD ARE COLOURED IN ACCORDANCE WITH THE FOLLOWING CODE.

BLUE: NEUTRAL
BROWN: LIVE

As the colours of the wires in the mains lead of this apparatus may not correspond with the coloured markings identifying the terminals in your plug, proceed as follows:

The wire which is coloured BLUE must be connected to the terminal which is marked with the letter N or coloured BLACK.
The wire which is coloured BROWN must be connected to the terminal which is marked with the letter L or coloured RED.
Under no circumstances must either of the above wires be connected to the earth terminal of a three pin plug.

For EU Countries



This product complies with the requirements of European Directive 89/336/EEC.

For the USA

FEDERAL COMMUNICATIONS COMMISSION RADIO FREQUENCY INTERFERENCE STATEMENT

This equipment has been tested and found to comply with the limits for a Class B digital device, pursuant to Part 15 of the FCC Rules. These limits are designed to provide reasonable protection against harmful interference in a residential installation. This equipment generates, uses, and can radiate radio frequency energy and, if not installed and used in accordance with the instructions, may cause harmful interference to radio communications. However, there is no guarantee that interference will not occur in a particular installation. If this equipment does cause harmful interference to radio or television reception, which can be determined by turning the equipment off and on, the user is encouraged to try to correct the interference by one or more of the following measures:

- Reorient or relocate the receiving antenna.
- Increase the separation between the equipment and receiver.
- Connect the equipment into an outlet on a circuit different from that to which the receiver is connected.
- Consult the dealer or an experienced radio/TV technician for help.

This device complies with Part 15 of the FCC Rules. Operation is subject to the following two conditions:

- (1) This device may not cause harmful interference, and
- (2) This device must accept any interference received, including interference that may cause undesired operation.

Unauthorized changes or modification to this system can void the users authority to operate this equipment.
This equipment requires shielded interface cables in order to meet FCC class B Limit.

For Canada

NOTICE

This Class B digital apparatus meets all requirements of the Canadian Interference-Causing Equipment Regulations.

AVIS

Cet appareil numérique de la classe B respecte toutes les exigences du Règlement sur le matériel brouilleur du Canada.

For the USA

DECLARATION OF CONFORMITY Compliance Information Statement

Model Name : SP-606
Type of Equipment : Sampling Workstation
Responsible Party : Roland Corporation U.S.
Address : 5100 S. Eastern Avenue, Los Angeles, CA 90040-2938
Telephone : (323) 890-3700

Information

When you need repair service, call your nearest Roland Service Center or authorized Roland distributor in your country as shown below.

AFRICA

EGYPT

AI Fanny Trading Office
9, EBN Hagar Al Askalani Street,
ARD El Golf, Heliopolis,
Cairo 11341, EGYPT
TEL: 20-2-417-1828

REUNION

Maison FO - YAM Marcel
25 Rue Jules Hermann,
Chaudron - BP79 97 491
Ste Clotilde Cedex,
REUNION ISLAND
TEL: (0262) 218-429

SOUTH AFRICA

**That Other Music Shop
(PTY) Ltd.**

11 Melle St., Braamfontein,
Johannesburg, SOUTH AFRICA
P.O. Box 32918, Braamfontein 2017
Johannesburg, SOUTH AFRICA
TEL: (011) 403 4105

Paul Bothner (PTY) Ltd.

17 Werdmuller Centre,
Main Road, Claremont 7708
SOUTH AFRICA

P.O. BOX 23032, Claremont 7735,
SOUTH AFRICA
TEL: (021) 674 4030

ASIA

CHINA

**Roland Shanghai Electronics
Co., Ltd.**
5F, No.1500 Pingliang Road
Shanghai 200090, CHINA
TEL: (021) 5580-0800

**Roland Shanghai Electronics
Co., Ltd.**

(BEIJING OFFICE)
JIE No.18 Anhuasili
Chaoyang District, Beijing 100011
CHINA
TEL: (010) 6426-5050

**Roland Shanghai Electronics
Co., Ltd.**

(GUANGZHOU OFFICE)
2/F, No.30 Si You Nan Er Jie Yi
Xiang, Wu Yang Xin Cheng,
Guangzhou 510600, CHINA
Tel: (020) 8736-0428

HONG KONG

**Tom Lee Music Co., Ltd.
Service Division**
22-32 Pun Shan Street, Tsuen
Wan, New Territories,
HONG KONG
TEL: 2415 0911

Parsons Music Ltd.

8th Floor, Railway Plaza, 39
Chatham Road South, T.S.T.,
Kowloon, HONG KONG
TEL: 2333 1863

INDIA

Rivera Digitec (India) Pvt. Ltd.
409, Nirman Kendra Mahalaxmi
Flats Compound Off. Dr. Edwin
Moses Road, Mumbai-400011,
INDIA
TEL: (022) 2493 9051

INDONESIA

PT Citra IntiRama
Jl. Cideng Timur No. 15J-150
Jakarta Pusat
INDONESIA
TEL: (021) 6324170

KOREA

Cosmos Corporation
1401-9, Seocho-Dong,
Seocho Ku, Seoul, KOREA
TEL: (02) 3486-8855

MALAYSIA

BENTLEY MUSIC SDN BHD
140 & 142, Jalan Bukit Bintang
55100 Kuala Lumpur, MALAYSIA
TEL: (03) 2144-3333

PHILIPPINES

G.A. Yupangco & Co. Inc.
339 Gil J. Puyat Avenue
Makati, Metro Manila 1200,
PHILIPPINES
TEL: (02) 899 9801

SINGAPORE

Sweet Lee Company
150 Sims Drive,
SINGAPORE 387381
TEL: 6846-3676

CRISTOFORI MUSIC PTE

LTD
Blk 3014, Bedok Industrial Park E,
#02-2148, SINGAPORE 489980
TEL: 6243-9555

TAIWAN

**ROLAND TAIWAN
ENTERPRISE CO., LTD.**
Room 5, 9th. No. 112 Chung Shan
N.Road Sec.2, Taipei, TAIWAN,
R.O.C.
TEL: (02) 2561 3339

THAILAND

Theera Music Co., Ltd.
330 Vereng NakornKasem, Soi 2,
Bangkok 10100, THAILAND
TEL: (02) 2248821

VIETNAM

Saigon Music
Suite DP-8
40 Ba Huyen Thanh Quan Street
Hochiminh City, VIETNAM
Tel: (08) 930-1969

AUSTRALIA/ NEW ZEALAND

AUSTRALIA

**Roland Corporation
Australia Pty., Ltd.**
38 Campbell Avenue
Dee Why West, NSW 2099
AUSTRALIA
TEL: (02) 9982 8266

NEW ZEALAND

Roland Corporation Ltd.
32 Shaddock Street, Mount Eden,
Auckland, NEW ZEALAND
TEL: (09) 3098 715

CENTRAL/LATIN AMERICA

ARGENTINA

Instrumentos Musicales S.A.
Av. Santa Fe 2055
(1123) Buenos Aires
ARGENTINA
TEL: (011) 4508-2700

BRAZIL

Roland Brasil Ltda
Rua San Jose, 780 Sala B
Parque Industrial San Jose
Cotia - Sao Paulo - SP, BRAZIL
TEL: (011) 4615 5666

COSTA RICA

**JUAN Bansbach
Instrumentos Musicales**
Ave. 1, Calle 11, Apartado 10237,
San Jose, COSTA RICA
TEL: 258-0211

CHILE

Commercial Fancy II S.A.
Rut: 96.919.420-1
Nataliel Cox #739, 4th Floor
Santiago - Centro, CHILE
TEL: (02) 688-9540

EL SALVADOR

OMNI MUSIC
75 Avenida Norte y Final
Alameda Juan Pablo II,
Edificio No.4010 San Salvador,
EL SALVADOR
TEL: 262-0788

MEXICO

Casa Veerkamp, s.a. de c.v.
Av. Toluca No. 323, Col. Olivar
de los Padres 01780 Mexico D.F.
MEXICO
TEL: (55) 5608-6699

PANAMA

SUPRO MUNDIAL, S.A.
Boulevard Andrews, Albrook,
Panama City, REP. DE PANAMA
TEL: 315-0101

PARAGUAY

**Distribuidora De
Instrumentos Musicales**
J.E. Olear y ESQ. Manduvira
Asuncion PARAGUAY
TEL: (021) 492-124

URUGUAY

Todo Musica S.A.
Francisco Acuna de Figueroa 1771
C.P.: 11.800
Montevideo, URUGUAY
TEL: (02) 924-2335

VENEZUELA

Musiland Digital C.A.
Av. Francisco de Miranda,
Centro Parque de Cristal, Nivel
C2 Local 20 Caracas
VENEZUELA
TEL: (212) 285-8586

EUROPE

AUSTRIA

**Roland Elektronische
Musikinstrumente HmbH.
Austrian Office**
Eduard-Bodem-Gasse 8,
A-6020 Innsbruck, AUSTRIA
TEL: (0512) 26 44 260

BELGIUM/HOLLAND/ LUXEMBOURG

Roland Benelux N. V.
Houtstraat 3, B-2260, Oevel
(Westerlo) BELGIUM
TEL: (014) 575811

CZECH REP.

K-AUDIO
Kardasovska 62b,
CZ-198 00 Praha 9,
CZECH REP.
TEL: (2) 666 10529

DENMARK

Roland Scandinavia A/S
Nordhavnevej 7, Postbox 880,
DK-2100 Copenhagen
DENMARK
TEL: 3916 6200

FRANCE

Roland France SA
4, Rue Paul Henri SPAAK,
Parc de l'Esplanade, F 77 462 St.
Thibault, Lagny Cedex FRANCE
TEL: 01 600 73 500

FINLAND

**Roland Scandinavia As,
Filial Finland**
Elannontie 5
FIN-01510 Vantaa, FINLAND
TEL: (09) 68 24 020

GERMANY

**Roland Elektronische
Musikinstrumente HmbH.**
Oststrasse 96, 22844 Norderstedt,
GERMANY
TEL: (040) 52 60090

GREECE

STOLAS S.A.
Music Sound Light
155, New National Road
Patras 2642, GREECE
TEL: 2610 435400

HUNGARY

Roland East Europe Ltd.
Warehouse Area 'DEPO' Pf.83
H-2046 Torokbalint, HUNGARY
TEL: (23) 511011

IRELAND

Roland Ireland
C2 Calmount Park, Calmount
Avenue, Dublin 12
Republic of IRELAND
TEL: (01) 4294444

ITALY

Roland Italy S. p. A.
Viale delle Industrie 8,
20020 Arese, Milano, ITALY
TEL: (02) 937-78300

NORWAY

**Roland Scandinavia Avd.
Kontor Norge**
Lilleakerveien 2 Postboks 95
Lilleaker N-0216 Oslo
NORWAY
TEL: 2273 0074

POLAND

MX MUSIC SP.Z.O.O.
Ul. Gibraltarska 4,
Pl.-03664 Warszawa POLAND
TEL: (022) 679 44 19

PORTUGAL

**Tecnologias Musica e Audio,
Roland Portugal, S.A.**
Cais Das Pedras, 8/9-1 Dto
4050-465 PORTO
PORTUGAL
TEL: (022) 608 00 60

ROMANIA

FBS LINES
Piata Libertatii 1,
535500 Gheorgheni, ROMANIA
TEL: (266) 364 609

RUSSIA

MuTek
3-Bogatyrskaya Str. 1.k.1
107 564 Moscow, RUSSIA
TEL: (095) 169 5043

SPAIN

**Roland Electronics
de España, S. A.**
Calle Bolivia 239, 08020
Barcelona, SPAIN
TEL: (93) 308 1000

SWEDEN

**Roland Scandinavia A/S
SWEDISH SALES OFFICE**
Danvik Center 28, 2 tr.
S-131 30 Nacka SWEDEN
TEL: (08) 702 00 20

SWITZERLAND

Roland (Switzerland) AG
Landstrasse 5, Postfach,
CH-4452 Itingen,
SWITZERLAND
TEL: (061) 927-8383

UKRAINE

TIC-TAC
Mira Str. 19/108
P.O. Box 180
295400 Munkachevo, UKRAINE
TEL: (03131) 414-40

UNITED KINGDOM

Roland (U.K.) Ltd.
Atlantic Close, Swansea
Enterprise Park, SWANSEA
SA7 9EJ,
UNITED KINGDOM
TEL: (01792) 702701

MIDDLE EAST

BAHRAIN

Moon Stores
No.16, Bab Al Bahrain Avenue,
P.O.Box 247, Manama 304,
State of BAHRAIN
TEL: 211 005

CYPRUS

Radex Sound Equipment Ltd.
17, Diagorou Street, Nicosia,
CYPRUS
TEL: (022) 66-9426

IRAN

MOCO, INC.
No.41 Nike St., Dr.Shariyati Ave.,
Roberoye Cerabe Mirdamad
Tehran, IRAN
TEL: (021) 285-4169

ISRAEL

**Halilit P. Greenspoon &
Sons Ltd.**
8 Retzif Ha'aliya Hashnya St.
Tel-Aviv-Yafo ISRAEL
TEL: (03) 6823660

JORDAN

AMMAN Trading Agency
245 Prince Mohammad St.,
Amman 1118, JORDAN
TEL: (06) 464-1200

KUWAIT

Easa Husain Al Yousifi Est.
Abdullah Salem Street,
Safat, KUWAIT
TEL: 243-6399

LEBANON

Chahine S.A.L.
Gerge Zeidan St., Chahine Bldg.,
Achrafieh, P.O.Box: 16-5857
Beirut, LEBANON
TEL: (01) 20-1441

QATAR

**Al Emadi Co. (Badie Studio
& Stores)**
P.O. Box 62, Doha, QATAR
TEL: 4423-554

SAUDI ARABIA

**aDawlah Universal
Electronics APL**
Corniche Road, Aldossary Bldg.,
1st Floor, AlKhobar,
SAUDI ARABIA

P.O.Box 2154, Alkhobar 31952

SAUDI ARABIA
TEL: (03) 898 2081

SYRIA

**Technical Light & Sound
Center**
Rawda, Abdul Qader Jazairi St.
Bldg. No. 21, P.O.BOX 13520,
Damascus, SYRIA
TEL: (011) 223-5384

TURKEY

**Ant Muzik Aletleri Ithalat
Ve Ithracat Ltd Sti**
Siraselviler Caddesi Siraselviler
Pasaji No:74/20
Taksim - Istanbul, TURKEY
TEL: (0212) 2449624

U.A.E.

**Zak Electronics & Musical
Instruments Co. L.L.C.**
Zabed Road, Al Sherouq Bldg.,
No. 14, Grand Floor, Dubai, U.A.E.
TEL: (04) 3360715

NORTH AMERICA

CANADA

**Roland Canada Music Ltd.
(Head Office)**
5480 Parkwood Way Richmond
B. C., V6V 2M4 CANADA
TEL: (604) 270 6626

**Roland Canada Music Ltd.
(Toronto Office)**

170 Admiral Boulevard
Mississauga On L5T 2N6
CANADA
TEL: (905) 362 9707

U. S. A.

Roland Corporation U.S.
1500 S. Eastern Avenue
Los Angeles, CA 90040-2938,
U. S. A.
TEL: (323) 890 3700

As of May 1, 2004 (Roland)

Roland Corporation

03678923

'04-5-1N

 Roland®

72670412

UPC

72670412



14981

Roland