

SP-555

Owner's Manual

Roland®

Main Features

Quick, Easy, and Unique Sampling!

Sample easily to the pads, or use LOOP CAPTURE for creative sound-on-sound sampling.

Sample Almost Anything!

Sample through its Line, or Mic Input with Phantom power. Also sample via USB audio streaming.

Perform with Killer Realtime Effects!

37 powerful effects such as Voice Transformer, Delay, and the unique Super Filter and DJFX Looper, now with Effect Memory for instant recall of your effect settings.

Audio I/F and SONAR LE

SP-555 is also an audio interface for the bundled Cakewalk SONAR LE, or any other audio application on your computer. The perfect computer interface for live use!

* The SONAR LE is only for Windows.

Large Sample Memory via CompactFlash!

Supports up to 2 GB CompactFlash, for over 12 hours of recording in Standard Mode. Use the bundled Wave Converter software to import and export WAV/AIFF files.

D Beam and V-LINK!

Tweak the filter, trigger samples, or play synth solos with the invisible infrared D Beam controller. Connect a V-LINK compatible video equipment and sync the music to the visuals.

Thank you, and congratulations on your choice of the Roland SP-555.

Before using this unit, carefully read the sections entitled: "USING THE UNIT SAFELY" and "IMPORTANT NOTES" (p. 4; p. 6). These sections provide important information concerning the proper operation of the unit. Additionally, in order to feel assured that you have gained a good grasp of every feature provided by your new unit, Owner's manual should be read in its entirety. The manual should be saved and kept on hand as a convenient reference.

USING THE UNIT SAFELY

INSTRUCTIONS FOR THE PREVENTION OF FIRE, ELECTRIC SHOCK, OR INJURY TO PERSONS

About WARNING and CAUTION Notices

WARNING	Used for instructions intended to alert the user to the risk of death or severe injury should the unit be used improperly.
CAUTION	Used for instructions intended to alert the user to the risk of injury or material damage should the unit be used improperly. * Material damage refers to damage or other adverse effects caused with respect to the home and all its furnishings, as well to domestic animals or pets.

About the Symbols

	The symbol alerts the user to important instructions or warnings. The specific meaning of the symbol is determined by the design contained within the triangle. In the case of the symbol at left, it is used for general cautions, warnings, or alerts to danger.
	The symbol alerts the user to items that must never be carried out (are forbidden). The specific thing that must not be done is indicated by the design contained within the circle. In the case of the symbol at left, it means that the unit must never be disassembled.
	The symbol alerts the user to things that must be carried out. The specific thing that must be done is indicated by the design contained within the circle. In the case of the symbol at left, it means that the power-cord plug must be unplugged from the outlet.

----- ALWAYS OBSERVE THE FOLLOWING -----

WARNING

- Before using this unit, make sure to read the instructions below, and the Owner's Manual.

- Do not open (or modify in any way) the unit or its AC adaptor.

- Do not attempt to repair the unit, or replace parts within it (except when this manual provides specific instructions directing you to do so). Refer all servicing to your retailer, the nearest Roland Service Center, or an authorized Roland distributor, as listed on the "Information" page.

- Never use or store the unit in places that are:
 - Subject to temperature extremes (e.g., direct sunlight in an enclosed vehicle, near a heating duct, on top of heat-generating equipment); or are
 - Damp (e.g., baths, washrooms, on wet floors); or are
 - Humid; or are
 - Exposed to rain; or are
 - Dusty; or are
 - Subject to high levels of vibration.

- This unit should be used only with a stand that is recommended by Roland.

WARNING

- When using the unit a stand recommended by Roland, the stand must be carefully placed so it is level and sure to remain stable. If not using a stand, you still need to make sure that any location you choose for placing the unit provides a level surface that will properly support the unit, and keep it from wobbling.



- Be sure to use only the AC adaptor supplied with the unit. Also, make sure the line voltage at the installation matches the input voltage specified on the AC adaptor's body. Other AC adaptors may use a different polarity, or be designed for a different voltage, so their use could result in damage, malfunction, or electric shock.

- Use only the attached power-supply cord. Also, the supplied power cord must not be used with any other device.

- Do not excessively twist or bend the power cord, nor place heavy objects on it. Doing so can damage the cord, producing severed elements and short circuits. Damaged cords are fire and shock hazards!

- This unit, either alone or in combination with an amplifier and headphones or speakers, may be capable of producing sound levels that could cause permanent hearing loss. Do not operate for a long period of time at a high volume level, or at a level that is uncomfortable. If you experience any hearing loss or ringing in the ears, you should immediately stop using the unit, and consult an audiologist.

⚠ WARNING

- Do not allow any objects (e.g., flammable material, coins, pins); or liquids of any kind (water, soft drinks, etc.) to penetrate the unit. 

- In households with small children, an adult should provide supervision until the child is capable of following all the rules essential for the safe operation of the unit. 

- Protect the unit from strong impact. (Do not drop it!) 

- Do not force the unit's power-supply cord to share an outlet with an unreasonable number of other devices. Be especially careful when using extension cords—the total power used by all devices you have connected to the extension cord's outlet must never exceed the power rating (watts/amperes) for the extension cord. Excessive loads can cause the insulation on the cord to heat up and eventually melt through. 

- Before using the unit in a foreign country, consult with your retailer, the nearest Roland Service Center, or an authorized Roland distributor, as listed on the "Information" page. 

- DO NOT play a CD-ROM disc on a conventional audio CD player. The resulting sound may be of a level that could cause permanent hearing loss. Damage to speakers or other system components may result. 

⚠ CAUTION

- The unit and the AC adaptor should be located so their location or position does not interfere with their proper ventilation. 

- This (SP-555) for use only with Roland stand PDS-10. Use with other stands is capable of resulting in instability causing possible injury. 

- This stand for use only with specific Roland musical instruments. See apparatus instructions. Use with other models is capable of resulting in instability causing possible injury. 

- Always grasp only the plug on the AC adaptor cord when plugging into, or unplugging from, an outlet or this unit. 

- At regular intervals, you should unplug the AC adaptor and clean it by using a dry cloth to wipe all dust and other accumulations away from its prongs. Also, disconnect the power plug from the power outlet whenever the unit is to remain unused for an extended period of time. Any accumulation of dust between the power plug and the power outlet can result in poor insulation and lead to fire. 

⚠ CAUTION

- Try to prevent cords and cables from becoming entangled. Also, all cords and cables should be placed so they are out of the reach of children. 

- Never climb on top of, nor place heavy objects on the unit. 

- Never handle the AC adaptor or its plugs with wet hands when plugging into, or unplugging from, an outlet or this unit. 

- Before moving the unit, disconnect the AC adaptor and all cords coming from external devices. 

- Before cleaning the unit, turn off the power and unplug the AC adaptor from the outlet (Quick Start Guide). 

- Whenever you suspect the possibility of lightning in your area, disconnect the AC adaptor from the outlet. 

- Should you remove screws for CARD LOCK, keep them in a safe place out of children's reach, so there is no chance of them being swallowed accidentally. 

- Always turn the phantom power off when connecting any device other than condenser microphones that require phantom power. You risk causing damage if you mistakenly supply phantom power to dynamic microphones, audio playback devices, or other devices that don't require such power. Be sure to check the specifications of any microphone you intend to use by referring to the manual that came with it. 

(This instrument's phantom power: 48 V DC, 10 mA Max)

IMPORTANT NOTES

In addition to the items listed under “USING THE UNIT SAFELY” on p. 4, please read and observe the following:

Power Supply

- Do not connect this unit to same electrical outlet that is being used by an electrical appliance that is controlled by an inverter (such as a refrigerator, washing machine, microwave oven, or air conditioner), or that contains a motor. Depending on the way in which the electrical appliance is used, power supply noise may cause this unit to malfunction or may produce audible noise. If it is not practical to use a separate electrical outlet, connect a power supply noise filter between this unit and the electrical outlet.
- The AC adaptor will begin to generate heat after long hours of consecutive use. This is normal, and is not a cause for concern.
- Before connecting this unit to other devices, turn off the power to all units. This will help prevent malfunctions and/or damage to speakers or other devices.

Placement

- Using the unit near power amplifiers (or other equipment containing large power transformers) may induce hum. To alleviate the problem, change the orientation of this unit; or move it farther away from the source of interference.
- This device may interfere with radio and television reception. Do not use this device in the vicinity of such receivers.
- Noise may be produced if wireless communications devices, such as cell phones, are operated in the vicinity of this unit. Such noise could occur when receiving or initiating a call, or while conversing. Should you experience such problems, you should relocate such wireless devices so they are at a greater distance from this unit, or switch them off.
- Do not expose the unit to direct sunlight, place it near devices that radiate heat, leave it inside an enclosed vehicle, or otherwise subject it to temperature extremes. Excessive heat can deform or discolor the unit.
- When moved from one location to another where the temperature and/or humidity is very different, water droplets (condensation) may form inside the unit. Damage or malfunction may result if you attempt to use the unit in this condition. Therefore, before using the unit, you must allow it to stand for several hours, until the condensation has completely evaporated.
- Depending on the material and temperature of the surface on which you place the unit, its rubber feet may discolor or mar the surface. You can place a piece of felt or cloth under the rubber feet to prevent this from happening. If you do so, please make sure that the unit will not slip or move accidentally.

Maintenance

- For everyday cleaning wipe the unit with a soft, dry cloth or one that has been slightly dampened with water. To remove stubborn dirt, use a cloth impregnated with a mild, non-abrasive detergent. Afterwards, be sure to wipe the unit thoroughly with a soft, dry cloth.
- Never use benzine, thinners, alcohol or solvents of any kind, to avoid the possibility of discoloration and/or deformation.

Repairs and Data

- Please be aware that all data contained in the unit's memory may be lost when the unit is sent for repairs. Important data should always be backed up on a CompactFlash card, or written down on paper (when possible). During repairs, due care is taken to avoid the loss of data. However, in certain cases (such as when circuitry related to memory itself is out of order), we regret that it may not be possible to restore the data, and Roland assumes no liability concerning such loss of data.

Additional Precautions

- Please be aware that the contents of memory can be irretrievably lost as a result of a malfunction, or the improper operation of the unit. To protect yourself against the risk of losing important data, we recommend that you periodically save a backup copy of important data you have stored in the unit's memory on a CompactFlash card.
- Unfortunately, it may be impossible to restore the contents of data that was stored in the unit's memory or CompactFlash card once it has been lost. Roland Corporation assumes no liability concerning such loss of data.
- Use a reasonable amount of care when using the unit's buttons, sliders, or other controls; and when using its jacks and connectors. Rough handling can lead to malfunctions.
- When connecting / disconnecting all cables, grasp the connector itself—never pull on the cable. This way you will avoid causing shorts, or damage to the cable's internal elements.
- To avoid disturbing your neighbors, try to keep the unit's volume at reasonable levels. You may prefer to use headphones, so you do not need to be concerned about those around you (especially when it is late at night).
- When you need to transport the unit, package it in the box (including padding) that it came in, if possible. Otherwise, you will need to use equivalent packaging materials.
- Some connection cables contain resistors. Do not use cables that incorporate resistors for connecting to this unit. The use of such cables can cause the sound level to be extremely low, or impossible to hear. For information on cable specifications, contact the manufacturer of the cable.
- The sensitivity of the D Beam controller will change depending on the amount of light in the vicinity of the unit. If it does not function as you expect, adjust the sensitivity as appropriate for the brightness of your location.
- The explanations in this manual include illustrations that depict what should typically be shown by the display. Note, however, that your unit may incorporate a newer, enhanced version of the system (e.g., includes newer sounds), so what you actually see in the display may not always match what appears in the manual.

Before Using Cards

- Carefully insert the CompactFlash card all the way in—until it is firmly in place.
- Never touch the terminals of the CompactFlash card. Also, avoid getting the terminals dirty.
- This unit's memory card slot accepts CompactFlash memory cards. Microdrive storage media are not compatible.
- CompactFlash cards are constructed using precision components; handle the cards carefully, paying particular note to the following.
 - To prevent damage to the cards from static electricity, be sure to discharge any static electricity from your own body before handling the cards.
 - Do not touch or allow metal to come into contact with the contact portion of the cards.
 - Do not bend, drop, or subject cards to strong shock or vibration.
 - Do not keep cards in direct sunlight, in closed vehicles, or other such locations (storage temperature: -25 to 85° C).
 - Do not allow cards to become wet.
 - Do not disassemble or modify the cards.

Handling CD-ROMs

- Avoid touching or scratching the shiny underside (encoded surface) of the disc. Damaged or dirty CD-ROM discs may not be read properly. Keep your discs clean using a commercially available CD cleaner.

Copyright

- Recording, duplication, distribution, sale, lease, performance, or broadcast of copyrighted material (musical works, visual works, broadcasts, live performances, etc.) belonging to a third party in part or in whole without the permission of the copyright owner is forbidden by law.
- Do not use this unit for purposes that could infringe on a copyright held by a third party. We assume no responsibility whatsoever with regard to any infringements of third-party copyrights arising through your use of this unit.
- The sounds, phrases and patterns contained in this product are sound recordings protected by copyright. Roland hereby grants to purchasers of this product the permission to utilize the sound recordings contained in this product for the creation and recording of original musical works; provided however, the sound recordings contained in this product may not be sampled, downloaded or otherwise re-recorded, in whole or in part, for any other purpose, including but not limited to the transmission of all or any part of the sound recordings via the internet or other digital or analog means of transmission, and/or the manufacture, for sale or otherwise, of any collection of sampled sounds, phrases or patterns, on CD-ROM or equivalent means.
The sound recordings contained in this product are the original works of Roland Corporation. Roland is not responsible for the use of the sound recordings contained in this product, and assumes no liability for any infringement of any copyright of any third party arising out of use of the sounds, phrases and patterns in this product.

SAMPLE PAD BANK A PAD13-16: Created by Tim Hüfken

- * Microsoft and Windows are registered trademarks of Microsoft Corporation.
- * Windows Vista is a trademark of Microsoft Corporation.
- * Windows® is known officially as: "Microsoft® Windows® operating system."
- * The screen shots in this document are used in compliance with the guidelines of the Microsoft Corporation.
- * Mac OS is a trademark of Apple Computer, Inc.
- * Pentium is a registered trademark of Intel Corporation.
- * All product names mentioned in this document are trademarks or registered trademarks of their respective owners.
- * VST is a trademark of Steinberg Media Technologies AG.

* CompactFlash and  are trademarks of SanDisk Corporation and licensed by CompactFlash association.

* Roland Corporation is an authorized licensee of the CompactFlash™ and CF logo () trademarks.

* Fugue © 1999-2007 Kyoto Software Research, Inc. All rights reserved.



Contents

Main Features	2	Editing a sample	28
USING THE UNIT SAFELY	4	Setting a sample's volume	28
IMPORTANT NOTES	6	Adjusting the playback region of a sample.....	28
Contents	8	Exchanging samples between two pads	30
Introducing the SP-555	10	Copying a sample to another pad.....	31
Panel Descriptions	10	Converting to a sample that has a modified playback region.....	31
Signal flow (block diagram)	14	Changing a sample's BPM	32
Playing samples	15	Changing the length of a sample without changing the pitch (Time Modify)	32
Using effects	18	Playing samples and recording your performance (Pattern Sequencer)	33
Applying an effect to a sample.....	18	How patterns are organized.....	33
Applying an effect to the mic/line input	18	Specifying the pattern tempo	33
Storing effect settings (EFFECT MEMORY)	18	Playing and stopping a pattern	33
Effect knob control	19	Switching patterns during playback.....	33
Tips for using effects.....	19	Recording a pattern	34
Sampling (recording)	21	Deleting a pattern.....	36
About the available sampling times.....	21	Deleting all patterns.....	36
Standby mode.....	22	Exchanging the patterns of two pads.....	37
Sampling	22	Copying a pattern to another pad.....	37
Starting sampling automatically (Auto Sampling)	22	D Beam controller	38
Sampling with a specified tempo	23	Monophonic synthesizer (SYNTH)	38
Using a count-in	23	Filter	39
Deleting a sample.....	23	Trigger.....	39
Deleting all samples	24	Connecting the SP-555 to your computer	40
Resampling	24	Installing the driver and software.....	40
Loop Capture	25	Changing the signal flow when using USB audio	42
Using Loop Capture to record from an external device.....	25	About SONAR LE (Windows only).....	43
Deleting the phrase recorded by Loop Capture	26	About SP-555 Wave Converter	43
Adjusting the playback level of the phrase.....	26		
Recording with a specified tempo	26		
Layering sound onto a previously recorded phrase (Overdubbing)	26		
Saving a recorded phrase to a pad	27		

About CompactFlash	44	Appendix.....	54
Recommended types of CompactFlash..	44	Effect list.....	54
CompactFlash theft prevention.....	44	Quick reference of operations.....	59
Inserting and removing		Parameters that can change	
CompactFlash cards.....	45	the start-up state	63
Formatting a CompactFlash card		Error message list	64
(initializing).....	45	Troubleshooting	65
Importing audio files	46	About the pedal	68
Exporting audio files	47	Attaching the stand (sold separately)....	68
Saving backup data (backup save)	48	Using the SP-555 with other MIDI equipment..	69
Loading backup data (backup load).....	48	About MIDI.....	69
Deleting backup data (backup delete) ..	49	Synchronizing the SP-555	
Other settings	50	with another MIDI device	69
Restoring the factory settings	50	Synchronizing the pattern	
Clearing the data (initialization)	50	tempo and playback start/stop	
Protecting the memory	51	with an external MIDI sequencer	70
Adjusting the blinking speed		Transmitting MIDI clock at	
of the display illumination	51	the pattern tempo	70
Checking the version number	51	MIDI channel (Pad Base Ch.)	
Setting the SP-555's		and note numbers	71
internal processing level	51	MIDI Thru setting	71
About V-LINK	52	MIDI Implementation	72
What is V-LINK?	52	Specifications	75
		Index.....	76

Introducing the SP-555

Panel Descriptions

Top panel

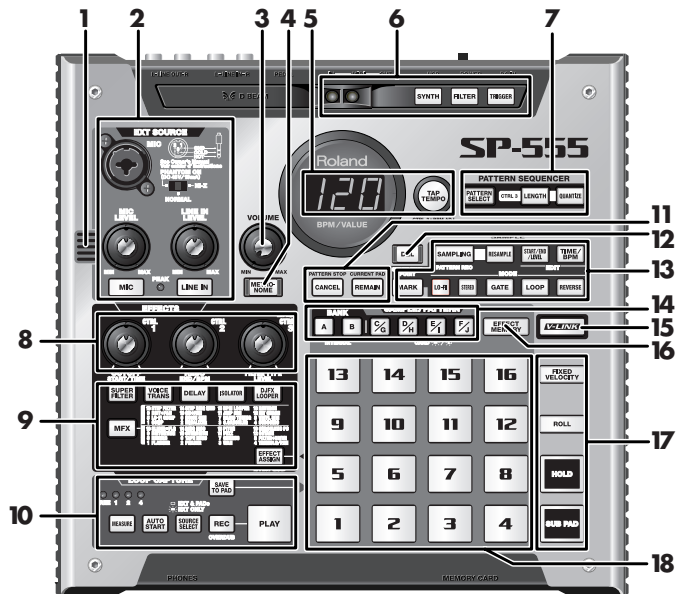

1. Internal Mic

This is the SP-555's built-in mic. If you connect your own mic (sold separately) to the MIC jack of the top panel, this internal mic will not function.

2. External Input

MIC Jack

This is a microphone jack for analog audio signals. It supports both XLR and 1/4" phone type plugs. The XLR type jack can provide 48 V phantom power, allowing you to connect phantom-powered condenser microphones. In this case, turn the **input select switch** to the **PHANTOM ON** position.

- * Turn the MIC button OFF before you operate the input select switch.
- * In order to protect the circuitry, there will be no sound for a short time after you operate the input select switch. The phone type jack also accommodates high-impedance inputs, allowing you to directly connect a guitar or bass. In this case, set the **input select switch** to the **Hi-Z** position.

* This instrument is equipped with balanced (XLR/TRS) type jacks. Wiring diagrams for these jacks are shown below. Make connections after first checking the wiring diagrams of other equipment you intend to connect.



1:GND
2:HOT
3:COLD

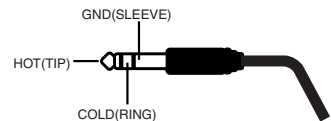

MIC LEVEL Knob, MIC Button

This adjusts the volume of the SP-555's internal mic or a mic connected to the MIC jack. If you're inputting audio from a mic, turn the **MIC button** on.

- * Even if you turn the MIC LEVEL knob all the way down, the sound will not be muted completely. If you're not using the mic, turn the MIC button off.

LINE IN LEVEL Knob, LINE IN Button

This adjusts the volume of the device connected to the rear panel LINE IN jacks. Turn on the **LINE IN button** if you're sampling audio from the LINE IN jacks.

PEAK Indicator

This indicator helps you adjust the MIC or LINE IN level. Adjust the level so that this indicator lights occasionally.

3. VOLUME Knob

This adjusts the volume of the LINE OUT and PHONES output.

4. METRONOME Button

When you press this button so it's lit, the metronome will sound at the BPM of the pattern sequencer. To adjust the volume of the metronome, hold down this button and turn the CTRL 3 knob.

MEMO

You can't sound the metronome while sampling.

5.

Display Illumination

This will blink according to the audio signal level while sampling, or in sync with the pattern tempo while using the pattern sequencer.

→ "Adjusting the blinking speed of the display illumination" (p. 51)

Display

This shows the BPM (tempo) of the sample or pattern, the values of various settings, and error messages. You can also view the remaining sampling time here (→ p. 21).

TAP TEMPO Button

By pressing this button several times at the desired tempo, you can set the tempo to the corresponding interval.

6. D BEAM (D Beam controller)

You can apply a variety of effects to the sound by moving your hand over this (→ p. 38). The following buttons will blink when the D Beam controller responds.

SYNTH Button

Use the D Beam controller to play internal synthesizer sounds.

FILTER Button

Use the D Beam controller to control the cutoff frequency of the internal filter.

TRIGGER Button

Use the D Beam controller to trigger the desired pad. If you hold down the TRIGGER button and press a pad, the D Beam controller will trigger that pad.

7. PATTERN SEQUENCER (→ p. 33)

PATTERN SELECT Button

Press this when you want to play or record a pattern. While this button is lit, you can select a pattern by pressing a pad.

LENGTH Button

When recording a pattern, this specifies the length of the pattern.

QUANTIZE Button

This specifies automatic timing adjustments (quantization) when recording a pattern.

8. EFFECTS Knobs (CTRL 1-3)

These control the parameters that are assigned to each knob by the selected effect. You will also use these knobs for the following purposes.

→ "Using effects" (p. 18)

→ "Effect list" (p. 54)

CTRL 1 Knob

Use this to adjust the starting location of a sample, or to change the playback time of a sample.

CTRL 2 Knob

Use this to adjust the BPM (tempo) of the pattern, or to change the ending location of a sample.

MFX/CTRL 3 Knob

Use this to select the type of MFX, or to adjust the sampling level or the volume of the sample.

9. Effect Buttons

Use these to select the effect you want to use. A button is lit when on, and extinguished when off.

* You can't turn on more than one effect at the same time.

* By holding down the **EFFECT ASSIGN button** and pressing one or more pads, you can turn on the effect for one or more pads.

10. LOOP CAPTURE

Here you can record the currently playing sample or pattern, or a phrase from an external input source (up to approximately 15 seconds).

→ "Loop Capture" (p. 25)

MEASURE Button

This specifies the number of measures to be recorded. If you specify FREE, you'll be able to record up to approximately 15 seconds.

AUTO START Button

If you turn this button on, recording will begin automatically when sound is input.

SOURCE SELECT Button

This selects what will be recorded. **EXT ONLY** will record only the signal from the mic, line input, or built-in sequencer controlled by the D Beam. **EXT & PADS** will record this sound mixed with the currently playing sample/pattern.

REC Button

Pressed to start recording. During recording, press this button to stop recording. You can also use this to layer an additional sample during LOOP CAPTURE playback.

PLAY Button

This plays the recorded phrase.

SAVE TO PAD Button

This saves a phrase recorded using LOOP CAPTURE to a pad.

11.

CANCEL Button

By pressing this button you can cancel an operation such as sampling or sample deletion. This button will also stop pattern playback or recording.

By rapidly pressing this button four times, you can stop all currently playing sounds.

REMAIN Button

When you press this button, the display will indicate the remaining time available for sampling. By holding down this button and pressing a pad, you can select the pad to which the effect will apply, or the pad whose settings you want to edit (i.e., the current pad).

12. DEL Button

Use this to delete a sample or pattern.

13. SAMPLE

SAMPLING Button

Use this to start/stop sampling, or to record a pattern (→ p. 21).

RESAMPLE Button

Use this to resample the sound of a sample processed by an effect.

START/END/LEVEL Button

Use this to change the playback start/end point of a sample, or to change its volume.

TIME/BPM Button

Use this to specify the playback time or BPM (tempo) of a sample.

MARK Button

Use this when you want only a portion of the sampled sound to be heard. While this button is lit, only the specified portion will be heard.

LO-FI Button (→ p. 22)

This switches the grade (standard/lo-fi) at which sampling is performed. Lo-fi sampling will occur if this button is lit, and standard sampling will occur if this button is extinguished.

STEREO Button (→ p. 22)

This specifies whether you will be sampling in monaural or in stereo. Stereo sampling will occur if this button is lit, and monaural sampling will occur if this button is extinguished.

GATE Button (→ p. 16)

This switches you between “gate playback,” in which the sample will sound only while you continue holding down the pad, and “trigger playback,” in which the sound will

alternately start or stop playing each time you press the pad. Gate playback will occur if this button is lit, and trigger playback will occur if this button is extinguished.

LOOP Button (→ p. 17)

This switches you between “loop playback” in which the sample will play repeatedly when you press the pad, and “one-shot playback” in which the sound will play only once. Loop playback will occur if this button is lit, and one-shot playback will occur if this button is extinguished.

REVERSE Button (→ p. 15)

This selects “reverse playback” in which the sample will play backward. Reverse playback will occur if this button is lit, and normal playback will occur if it is extinguished.

14. BANK Buttons (A, B, C/G, D/H, E/I, F/J)

When [PATTERN SELECT] is extinguished or when you are recording a pattern, these buttons select the sample bank. When [PATTERN SELECT] is lit, these buttons select the pattern bank. Internal memory bank A or B will be selected if you press BANK [A] or [B] so one of the buttons is lit. CompactFlash banks C–F will be selected if you press BANK [C/G]–[F/J] and light one of the buttons, and CompactFlash banks G–J will be selected if you press BANK [C/G]–[F/J] and get a button to start blinking.

15. V-LINK Button

V-LINK (**V-LINK**) is a function that lets you perform music and video in synchronization.

By using MIDI to connect two or more V-LINK compatible devices, you can easily enjoy a wide range of visual effects that are linked to the expressive elements of a musical performance.

→ “About V-LINK” (p. 52)

16. EFFECT MEMORY Button

This lets you store effect settings (effect type, CTRL 1/2/3 knob values) and call them up instantly by operating a pad.

→ “Storing effect settings (EFFECT MEMORY)”

17.

FIXED VELOCITY Button (→ p. 15)

If this is off, samples will play at a fixed volume regardless of how strongly you strike the pads.

ROLL Button (→ p. 15)

Use this when you want to play sounds as a “drum roll.”

HOLD (→ p. 15)

If you press a pad while holding down the HOLD pad, the sample will continue sounding even after you release your finger.

SUB PAD (→ p. 15)

You can use the SUB PAD to play the sample of the pad you pressed most recently.

18. Pads 1–16

When you press a pad that is lit red, the sample assigned to that pad will sound. The pad will blink while the sample is playing.

When [PATTERN SELECT] is lit, you can use the pads to select the pattern that will be played or recorded.

Front panel**1. PHONES Jack**

You can connect stereo headphones here to listen to the same sound as from LINE OUT.

2. MEMORY CARD Slot

You can insert a separately sold CompactFlash card here. By using banks C–J of the CompactFlash you can sample for a longer time than is possible using the SP-555's internal memory.

When the SP-555 is shipped from the factory, a card cover is attached to the MEMORY CARD slot. To detach the cover, pinch the left and right edges of the cover toward the middle, and pull it toward yourself.

→ “About CompactFlash” (p. 44)

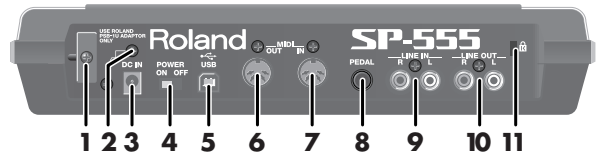
Rear panel**1. Cord Hook**

Wrap the AC adaptor cord around this to prevent the AC adaptor's plug from being accidentally unplugged.

2. Grounding Terminal

- * Depending on the circumstances of a particular setup, you may experience a discomforting sensation, or perceive that the surface feels gritty to the touch when you touch this device, microphones connected to it, or the metal portions of other objects, such as guitars. This is due to an infinitesimal electrical charge, which is absolutely harmless. However, if you are concerned about this, connect the ground terminal (see figure) with an external ground. When the unit is grounded, a slight hum may occur, depending on the particulars of your installation. If you are unsure of the connection method, contact the nearest Roland Service Center, or an authorized Roland distributor, as listed on the “Information” page.

Unsuitable places for connection

- Water pipes (may result in shock or electrocution)
- Gas pipes (may result in fire or explosion)
- Telephone-line ground or lightning rod (may be dangerous in the event of lightning)

3. DC IN Jack

Connect the included AC adaptor here.

4. POWER Switch

This turns the power on/off.

5. USB Connector

If you use a USB cable (sold separately) to connect the SP-555 to your computer, the SP-555 will function as a USB audio interface. You can also record the SP-555's sound to your computer, or sample sounds from your computer to the SP-555.

→ “Connecting the SP-555 to your computer” (p. 40)

6. MIDI OUT Connector

You can connect this connector to a MIDI device.

→ “Using the SP-555 with other MIDI equipment” (p. 69)

7. MIDI IN Connector

You can connect a MIDI device to this connector.

→ “Using the SP-555 with other MIDI equipment” (p. 69)

8. PEDAL Jack

You can connect a pedal switch (DP series; sold separately) here and use it to perform loop capture or pattern play/stop operations (p. 68).

9. LINE IN Jacks (L/R)

Connect these jacks to the audio source device from which you want to sample, such as a CD player or portable

audio player.

10. LINE OUT Jacks (L/R)

Connect these jacks to your audio system, amp, or mixer.

11. Security Slot ()

<http://www.kensington.com/>

Signal flow (block diagram)

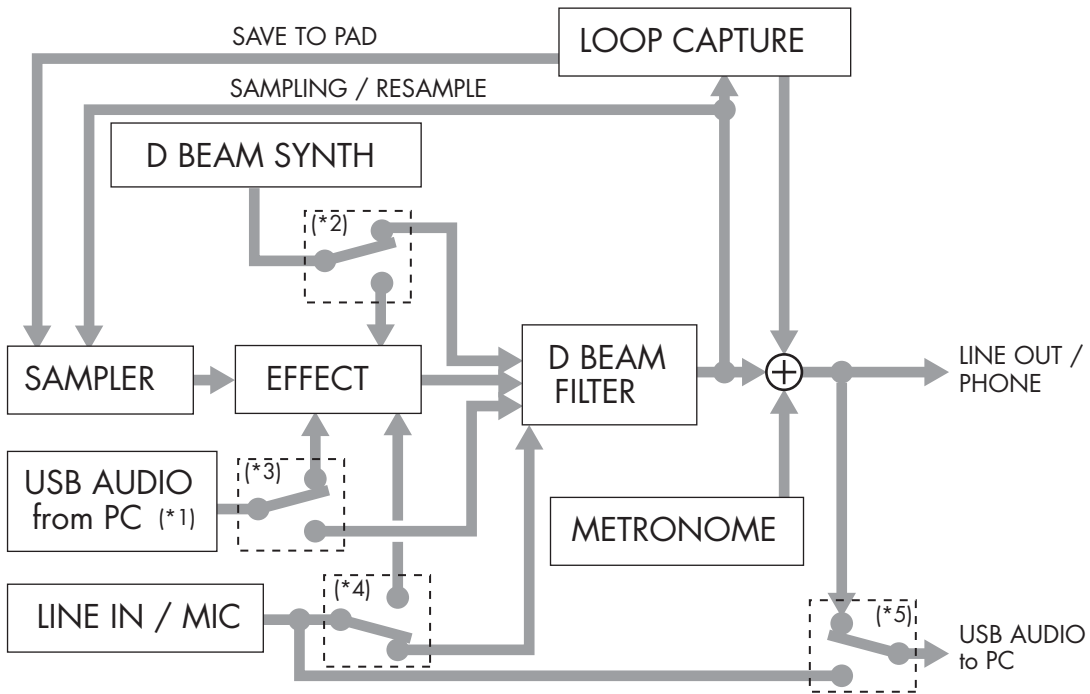

- *1: USB Audio Input. To mute this, hold down [CANCEL], press [MIC], and operate the CTRL 3 knob.
- *2: D Beam Synth send to Effect. To turn this on, hold down [EFFECT ASSIGN] and press [SYNTH].
- *3: USB Audio send to Effect. To turn this off, hold down [EFFECT ASSIGN] and [CANCEL], and press [MIC]/[LINE IN].
- *4: Mic/Line In send to Effect. To turn this off, hold down [EFFECT ASSIGN] and press [MIC]/[LINE IN].
- *5: USB Audio output source SW. To change this setting, hold down [CANCEL], press [LINE IN], and operate the CTRL 3 knob.

Playing samples

The SP-555 provides sixteen velocity-sensitive pads, which let you vary the volume according to the force with which you strike the pads. Striking a pad strongly will produce a louder sound, and striking it softly will produce a softer sound.

BANK A–BANK J

Banks A/B are in internal memory, and the remaining banks are on the CompactFlash card. Press a button to switch to the corresponding bank. Sixteen samples can be assigned to each bank. Select banks C–F by pressing a bank C–J button, causing it to light; select banks G–J by pressing a button twice so it's blinking.

CANCEL

By pressing this four times in rapid succession, you can stop playback of all samples.

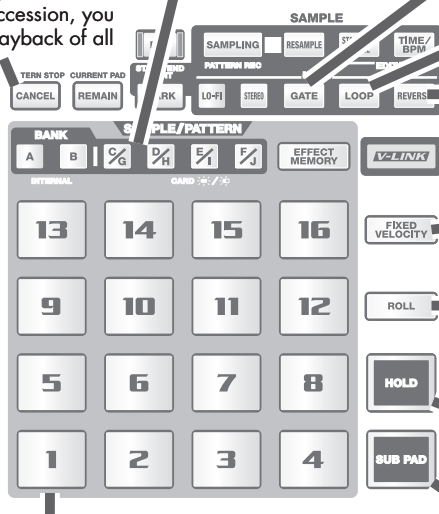

PAD 1–PAD 16

Press a pad to play the sample assigned to that pad.
 Lit red: A sample is assigned.
 Unlit: No sample is assigned.
 Blinking: Currently playing.

GATE

If this is unlit, the sample will play to the end when you press a pad once. If you press this button so it's lit after pressing the desired pad, the sound will continue playing only while you continue pressing the pad.

LOOP

If this is unlit, the sample will play to the end and then stop. If you press this button so it's lit after pressing the desired pad, the sound will play repeatedly as a loop.

REVERSE

If you press this button so it's lit after pressing the desired pad, the sample will play backward.

FIXED VELOCITY

If you press this button so it's lit, the sample will play at the same volume regardless of how strongly you strike the pad.

ROLL

If you hold down this button and press a pad, the sample will play as a "roll" as long as you continue holding down the pad. This produces a "drum roll" effect. By holding down this button and pressing HOLD, you can maintain the state of the pad being held down.

HOLD

If you press this button while holding down a pad, the playback will continue even if you release the pad. (This is valid only for pads for which GATE is turned on.) The sound will stop when you press the pad once again.

SUB PAD

When you press this pad, the sample assigned to the previously struck pad will be heard. You can use this to play repeated strikes using both hands.

About the banks

The SP-555 has ten sample banks: A–J.

Banks A and B use the SP-555's internal memory. With the factory settings, bank A contains preloaded samples. If you're using the SP-555's internal memory, you can record a maximum of 32 samples with a total maximum of approximately five minutes.

Banks C–J are located on the memory card (CompactFlash). You can record up to 128 samples on a memory card.

About the polyphony

The SP-555 can play up to twelve samples simultaneously. However, the polyphony is reduced as shown in the table below if you're using stereo samples or if you're resampling.

	Monaural samples	Stereo samples
Normally	12	6
While resampling	4	2

Pad sensitivity

You can adjust the relationship between the force used when striking pads and the volume of sample playback.

1. Hold down [CANCEL] and press [FIXED VELOCITY].
2. While viewing the display, use the CTRL 3 knob to adjust the sensitivity.
 - “L-”: A loud volume will be produced even if you strike the pads softly.
 - “M-”: Medium sensitivity.
 - “H-”: There will be no sound unless you strike the pads strongly.
3. Press [SAMPLING] to save the setting.
4. When you’ve finished making the adjustment, press [CANCEL] to return to normal operation.

Playing samples at a fixed loudness

If you turn [FIXED VELOCITY] on, the samples will play at a fixed volume regardless of how strongly you strike the pads. Here’s how to specify the volume that will be produced when [FIXED VELOCITY] is on.

1. Hold down [FIXED VELOCITY] and use the CTRL 3 knob to adjust the fixed velocity. Any value from 16 through 127 can be specified.
2. While still holding down [FIXED VELOCITY], press [SAMPLING] to save the setting.

Adjusting the roll speed (ROLL)

By holding down [ROLL] and turning the CTRL 3 knob you can adjust the speed of the roll. While viewing the display, hold down [ROLL] and press [SAMPLING] to save the setting as follows.

- 4: Quarter notes
- 4.3: Quarter note triplets
- 8: Eighth note
- 8.3: Eighth note triplets
- 16: Sixteenth notes
- 16.3: Sixteenth note triplets
- 32: Thirty-second notes
- 32.3: Thirty-second note triplets

Gate playback (GATE) and trigger playback

Pads for which GATE is turned on will start playing when you press the pad, and will stop playing when you release the pad (Gate playback).

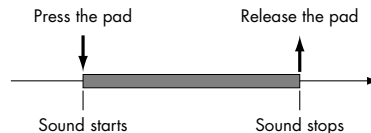

In contrast, pads for which GATE is turned off will start playing when you press the pad, and will continue playing even when you release the pad (Trigger playback). Playback will stop when you reach the end (End Point) of the sample (only if Loop is turned off).

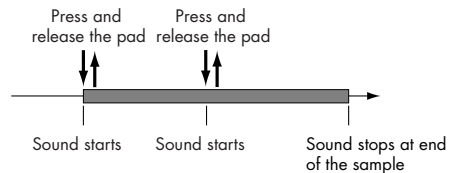

TIP

If you want a long phrase to continue playing, you should use Trigger playback + Loop playback. If you are playing drum-type samples, you should use Trigger playback + One-shot playback. The sample will play to its end even if you press the pad for only an instant.

MEMO

After sampling, the following settings are made automatically.
 If the length resulting from automatic BPM calculation (p. 32) is less than one measure: Trigger Playback
 If the length resulting from automatic BPM calculation (p. 32) is one measure or greater: Gate Playback

TIP

If you have specified Trigger playback + One-shot playback for a long sample, the sound may continue playing for longer than you would like. In this case, you can stop the playback by pressing [CANCEL] four times in rapid succession. Gate on/off can be specified independently for each pad.

1. Make sure that [PATTERN SELECT] is extinguished. If it is lit, press [PATTERN SELECT] so its light is turned off.
2. Press the pad whose Gate on/off setting you want to change, making it the current pad. The sample will play, and the pad will blink.

MEMO

If you press [REMAIN], the current pad will blink, allowing you to check which pad is the current pad.

MEMO

You can also change the current pad by holding down [REMAIN] and pressing a pad.

3. Press [GATE] to switch on or off the button's light.
[GATE] lit: Gate playback
[GATE] unlit: Trigger playback
4. Make sure that [LOOP] is extinguished.
If it is lit, press [LOOP] so its light is turned off.

Loop playback

You can use Loop playback if you want a sampled phrase of several measures to play repeatedly.

1. Make sure that [PATTERN SELECT] is extinguished.
If it is lit, press [PATTERN SELECT] so its light is turned off.
2. Press the pad for which you want to specify Loop playback, making it the current pad.
The sample will play, and the pad will blink.

MEMO

If you press [REMAIN], the current pad will blink, allowing you to check which pad is the current pad.

MEMO

You can also change the current pad by holding down [REMAIN] and pressing a pad.

3. Press [LOOP] so the button is lit.

Combining LOOP and GATE

You can make Gate playback/Trigger playback settings even if Loop playback is on.

When both LOOP and GATE are on

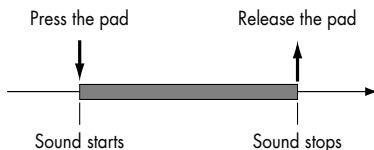

When LOOP is on and GATE is off

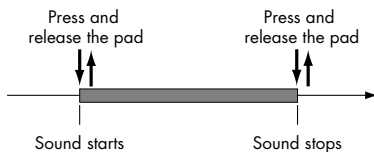

Making the sample continue playing even after you release your finger from the pad (HOLD)

If you turn HOLD on, the sample will continue playing even after you release your finger from the pad. This function is convenient when you want to temporarily turn Gate off for a pad whose Gate is on.

1. Make sure that [PATTERN SELECT] is extinguished.
If it is lit, press [PATTERN SELECT] so its light is turned off.
2. While pressing a pad to play the sample, press [HOLD].
[HOLD] will light, and the sound will be held. In this state, the sample will continue playing even after you take your finger off of the pad.
3. When you press [HOLD] once again, the sound will stop.

MEMO

Hold is valid only for a pad whose Gate is turned on. You cannot turn Hold on for pads whose Gate is off

Using effects

The SP-555 contains 37 types of effects. However, you can use only one type of effect at a time. You can't use a multiple number of effects at the same time.

By default, the effect will be applied only to the pad you pressed most recently (the "current pad").

You can directly select the five effects **SUPER FILTER**, **VOICE TRANS** (voice transformer), **DELAY**, **ISOLATOR**, and **DJFX LOOPER** by pressing a button. To choose one of the other effects, press the **MXF** button, then press a bank (A or B), and finally press a pad 1–16 to select the desired effect.

The SP-555 has an effect memory function, which lets you use [EFFECT MEMORY] to store and instantly switch among up to sixteen effect settings.

Applying an effect to a sample

1. Press the pads to find the sample to which you want to apply an effect. The effect will be applied to the pad you pressed last (the "current pad").
2. Press the appropriate button for the effect you want to apply.
To select SUPER FILTER, VOICE TRANS, DELAY, ISOLATOR, or DJFX LOOPER, simply press the corresponding button. For MXF, hold down [MXF] and turn the CTRL 3 knob to select an effect while viewing the display.
3. Turn the CTRL 1–CTRL 3 knobs to adjust the effect.
The parameters that are controlled by the CTRL 1–CTRL 3 knobs will depend on the effect type. Refer to "Effect list" (p. 54).

Applying an effect to the mic/line input

If you want to apply an effect to the mic/line input as well, hold down [EFFECT ASSIGN] and press [MIC] or [LINE IN].

- * The effect will be applied to both the line input and mic. You can't apply the effect to just one or the other.

Storing effect settings (EFFECT MEMORY)

You can use [EFFECT MEMORY] to store and instantly call up EFFECT settings (effect type and CTRL 1/2/3 knob values).

Storing settings

1. Make the necessary settings for the effect, so it's in the state you want to store.
2. Press [EFFECT MEMORY].
3. Press [SAMPLING]. Pads 1–16 will blink.
4. Press the pad to which you want to store the effect settings. The pad you pressed will light, and [SAMPLING] will blink.
5. Press [SAMPLING] to store the current effect settings.

Calling up settings

1. Press [EFFECT MEMORY] so the button is lit.
2. Press a pad 1–16 to call up the stored settings.
The effect type and the values for the CTRL 1/2/3 knobs will be called up.

MEMO

Since the values for the CTRL 1/2/3 knobs that existed at the time you stored the effect are given priority, the current physical position of the CTRL 1/2/3 knobs will not match the effect that is applied.

Checking the settings

1. Press [EFFECT MEMORY] so the button is lit.
2. Hold down [REMAIN], and press the pad that you want to check.
While you hold down [REMAIN], the LED for the effect type stored at that pad will blink (if the effect is one of the five types that can be selected directly by a button), or the 7-segment LED will indicate the bank and number (A.1–B.16).

Effect knob control

The SP-555 lets you choose either of the following two methods of operation to specify what will happen to the knob settings when you switch from one type of effect to another.

1. While holding down [CANCEL], press [SUPER FILTER].

Each time you press [SUPER FILTER], the display's indication will alternate between "C.nL" and "C.JP."

"C.JP" (Jump):

The setting of the parameter will match the knob position the instant you turn the knob.

"C.nL" (Null):

When you start turning the knob, the setting will not actually change until the knob position passes through the current value of the setting.

When you turn on the power, this is always set to "C.JP" (Jump).

In the "C.nL" (Null) state, the display will indicate the relation between the knob position and the value of the setting. This will help you match the knob position with the value.

When the value is lower than the knob position



When the knob position is lower than the value



Tips for using effects

Applying the same effect to more than one pad (EFFECT ASSIGN)

To apply the same effect to one or more pads in addition to the current pad, hold down [EFFECT ASSIGN] and press the desired pad.

The same effect is applied to each pad that lights when you press [EFFECT ASSIGN].

MEMO

If you hold down [EFFECT ASSIGN] while together pressing both [PAD 1] and [PAD 16], you can simultaneously turn the effect on/off for all pads in that bank.

	Effect
Pad lit	on
Pad unlit	off
Current pad: blinking, lit longer	on
Current pad: blinking, lit briefly	off

By default, if you select as the current pad a pad to which the effect is not applied, and then turn the effect on/off or change the effect settings, the effect assign settings will be cancelled, so that the effect is applied only to the current pad.

Effect assign mode

If you hold down [EFFECT ASSIGN] and press [REMAIN], the [EFFECT ASSIGN] button will light. In this state, the EFFECT ASSIGN setting for each pad will not be cancelled even if you change the current pad.

If you once again hold down [EFFECT ASSIGN] and press [REMAIN], the [EFFECT ASSIGN] button will go out, and the EFFECT ASSIGN setting will change when you change the current pad.

MEMO

You can also change the power-on default state. (→ "Effect Assign Mode" (p. 63) in "Parameters whose power-on default setting can be changed.")

Applying an effect to all pads

Here's how to apply the effect to all pads of banks A–J.

1. **Make sure that [PATTERN SELECT] is extinguished. If it is lit, press [PATTERN SELECT] to turn it off.**
2. **While holding down [EFFECT ASSIGN], press [SUB PAD]. All bank buttons and all pads will light (the current pad will blink).**

If you want to return to the state in which the effect is applied only to the current pad, once again hold down [EFFECT ASSIGN] and press [SUB PAD] so that only the current pad blinks.

Turning on the effect only while you hold down the button (EFFECT GRAB)

Normally, the effect will turn on when you press the button, and turn off when you press the button again.

If you hold down [EFFECT ASSIGN] and press an effect button (or [MFX]), the effect will be on only while you continue pressing it, and turn off when you release it. This is convenient when you want to rapidly turn an effect on and off.

About the effect tempo

Effect tempo mode

The parameters of some effects, such as the delay time of a delay-type effect or BPM LOOPER, will synchronize to the BPM of the sample.

By default, these are set to synchronize with the BPM of the current pad. However, if you hold down [EFFECT ASSIGN] and press [PATTERN SELECT], the effect will synchronize to the tempo of the pattern sequencer, regardless of the BPM of the current pad.

MEMO

You can also change the power-on default state. (→ “**Effect Tempo Mode**” (p. 63) in “**Parameters whose power-on default setting can be changed.**”)

If you hold down [EFFECT ASSIGN] and press [TAP TEMPO], the effect will temporarily synchronize to the tempo of the pattern sequencer, and the pattern of effects that have a pattern (*1) will be reset.

*1 SLICER+FLG (A-13), STEP FILTER (B-13), STEP RING MOD (B-14), BPM LOOPER (B-15)

About the lit, extinguished, and blinking effect buttons

- When the effect of the current pad is on, the button of the effect being used will light. (In the case of MFX, the [MFX] button will light.)
- If the current pad's effect is off, and the effect is turned on for a source other than the current pad (i.e., for another pad, EXT SOURCE, USB AUDIO, D BEAM), the effect button will blink.
- If the effect is turned on for all sources, the effect buttons will be extinguished.

Checking the previously used effect

If you press [EFFECT ASSIGN], the button of the previously used effect will blink.

Presetting the parameters of the effect you'll be using next

While holding down [REMAIN], turn the CTRL 1–CTRL 3 knobs to adjust the parameters. Next, press an effect button, and the effect will be applied with the parameter values you set in advance.

Effect Limit mode

By using Effect Limit mode, you can prevent unintentionally loud sounds from being produced by an effect that uses feedback or resonance. Hold down [CANCEL] and press [MFX]. Limit mode is on if the display indicates “L.on,” and off if the Display indicates “L.oF.”

Some effects do not have a limit mode.

This will be off when you turn on the power.

Sampling (recording)

About the available sampling times

When using internal memory

If you sample to bank A or B, the sample is stored in internal memory. Internal memory can hold up to 32 samples. If you reach 32 samples, you won't be able to record further samples.

	STANDARD stereo (mono)	LO-FI stereo (mono)
Using internal memory	Approx. 5 minutes (11 minutes)	Approx. 11 minutes (22 minutes)

- * This includes the PRELOADED SAMPLES THAT ARE ASSIGNED to bank A when the SP-555 is shipped from the factory.
- * LO-FI: This mode provides the distinctive low-fidelity sound that is typical of early digital devices. It allows longer sampling times, but the sound quality is not as good as STANDARD. Once you record a sample using LO-FI, you can't regain the original sound quality, even if you resample it using STANDARD.

When using CompactFlash

If you sample to banks C–J, the sample is stored on CompactFlash. A CompactFlash card can hold up to 128 samples, regardless of the capacity of the card. If you reach 128 samples, you won't be able to record further samples.

Card capacity	STANDARD stereo (mono)	LO-FI stereo (mono)
128 MB	Approx. 24 minutes (48 minutes)	Approx. 48 minutes (96 minutes)
256 MB	Approx. 48 minutes (96 minutes)	Approx. 96 minutes (193 minutes)
512 MB	Approx. 96 minutes (193 minutes)	Approx. 193 minutes (386 minutes)
1 GB	Approx. 193 minutes (386 minutes)	Approx. 386 minutes (772 minutes)
2 GB	Approx. 386 minutes (772 minutes)	Approx. 772 minutes (1544 minutes)

Remaining sampling time

When you press [REMAIN], the display will indicate the remaining time.



Minutes Seconds



Minutes (x10 seconds)



Minutes

The remaining time in internal memory is shown if an internal memory bank is selected, and the remaining time on the CompactFlash is shown if a CompactFlash bank is selected.

MEMO

The indication shows the time available for sampling in monaural/standard mode.

MEMO

The remaining time indication is an estimate.

Standby mode

* During this procedure, you can cancel the preceding steps by pressing [CANCEL].

1. Make sure that [PATTERN SELECT] is off (extinguished).
 2. Press [SAMPLING].
 3. Press a bank button to specify the bank into which you want to sample. When you press a bank button, the pads within that bank to which you can sample (i.e., pads that do not contain a sample) will blink.
 4. Press one of the blinking pads to specify the sampling-destination pad.
 5. Only the specified pad will be lit, and [SAMPLING] will blink.
 6. Press [LO-FI] to select the sampling
[LO-FI] unlit: STANDARD (high quality)
[LO-FI] lit: LO-FI (low fidelity)
- TIP**
LO-FI provides the distinctive low-fidelity sound that is typical of early digital devices. If you select LO-FI, you won't be able to monitor the sampled result during sampling. When sampling is finished, you can press the pad to play back the sample for auditioning. Once you record a sample using LO-FI, you can't regain the original sound quality, even if you resample it using STANDARD.
7. Press [STEREO] to select either stereo or monaural sampling.
[STEREO] lit: Stereo sampling
[STEREO] unlit: Monaural sampling

Now you're ready to sample.

Sampling

1. From standby mode, press [SAMPLING] to begin sampling.
If you're sampling from a CD or MP3 player, put your CD or MP3 player in playback mode, and press [SAMPLING] at the appropriate moment. During sampling, the display will indicate "rEC."
2. Press [SAMPLING] once again to stop sampling.
To hear the result, press the pad to which you sampled. Even if there is unwanted sound or silence at the beginning or end of the sample, you can adjust the start or end point so that these unwanted portions are not heard.

NOTE

Since the BPM value that is displayed after sampling is an estimated value that is calculated from the sampled time, it may not be accurate. This means that even if two samples have the same BPM value, they may drift apart in timing if they are played as continuous loops for an extended time.

Starting sampling automatically (Auto Sampling)

The Auto Sampling function will cause sampling to begin automatically when the input signal (sound) exceeds a specified level. This is convenient when you want to begin sampling from the introduction of a song. Before you enter sampling standby mode, adjust the sampling trigger level as described below.

1. Hold down [CANCEL] and press [SAMPLING].
[SAMPLING] will blink, and the display will indicate "-0-."
 2. Turn the CTRL 3 (LEVEL) knob to set the level.
The sampling trigger level will be the level at which the PEAK indicator lights. Turning the knob toward the right will raise the level. The display will indicate the level you specified (ten stages, 0-9).
- MEMO**
When "-0-" is indicated, conventional sampling will occur (i.e., auto sampling will not be used). Choose the "-0-" setting if you don't want to use auto sampling.
3. To check the sampling trigger level, press [SAMPLING] once again.
When you start sampling with auto sampling specified, the display will indicate "rdY" until a signal exceeding the sampling trigger level is received.

Sampling with a specified tempo

If you specify the BPM (tempo) while you're still in sampling standby mode, the end point (the timing at which the sound stops playing) will be automatically set after sampling to a beat of the BPM value you specified.

1. Enter sampling standby mode.
2. Press [TIME/BPM] so the button is lit.
3. Set the BPM, either by pressing [TAP TEMPO] in time with the beat, or by holding down [TAP TEMPO] and turning the CTRL 2 knob.

MEMO

Permissible values for the BPM range from 40 up to 200. However, if the BPM is within the 40–60 or 160–180 ranges, it can be set only in even-numbered values. If the BPM is above 180, you can set it to either 180, 183, 186, 190, 193, 196, or 200.

4. Press [TIME/BPM] to turn off the button's light.
5. Press [SAMPLING] to start sampling.
6. Press [SAMPLING] once again to stop sampling.
To hear the result, press the pad to which you sampled.

MEMO

If you specify the BPM (tempo) while in sampling standby mode, the timing at which the sound stops playing (the end point) will automatically be set to a beat of the BPM value you assigned before pressing the button. This means that [MARK] will light automatically to indicate that the end point has been set. For more about the end point, refer to "Adjusting the playback region of a sample" (p. 28).

MEMO

If the sampled time is multiple measures or less than one measure, the BPM indication may be double or half. In this case, press [TIME/BPM] so the button is lit, then turn the CTRL 2 (BPM) knob to set the desired value. Refer to "Changing a sample's BPM" (p. 32).

MEMO

The displayed BPM value is an approximation derived from the sampled time, and may not be accurate.

MEMO

Depending on the BPM value, the time corresponding to the BPM may not precisely match the time from the start point to the end point. For this reason if you use "Loop playback" (p. 17) to continuously play a sample for an extended time, the timing will gradually drift.

Using a count-in

You can add a count-in (1, 2, 3, 4) when you start sampling. This is convenient when you are sampling with a specific tempo or time signature in mind.

1. Specify the tempo as described in steps 1–4 of "Sampling with a specified tempo" (p. 23)
2. Press [START/END/LEVEL] so the button is lit.
3. When you press [SAMPLING], the metronome will sound, and the display will successively indicate "-1-" → "-2-" → "-3-" → "-4-" → "rEC."
Sampling will begin when the "rEC" indication appears.

Deleting a sample

1. Before you continue, make sure of the sample you want to delete.
2. Press [DEL].
3. The display will indicate "dEL," and pads to which samples are assigned will blink.
4. Press the pad of the sample that you want to delete. When you press a pad, the pad will change from blinking to lit.
5. If you want to delete the samples from several pads, press the appropriate pads at this point. You can select multiple pads simultaneously if they are in the same bank.
6. When you press [DEL], the samples will start being deleted. When the deletion is complete, the "dEL" indication in the display will disappear.

* If you decide to cancel the operations you've performed up to this point, press [CANCEL].

* Never turn off the power before the deletion is complete. Doing so may destroy not only the samples being deleted, but also other samples, or damage the CompactFlash card itself.

* Once you press [DEL] to begin deleting the samples, you won't be able to cancel the operation by pressing [CANCEL].

* If you specify a bank that is protected (p. 51), the display will indicate "Prt" (Protected), and you won't be able to delete anything.

Deleting all samples

Here's how to delete all samples from internal memory or the CompactFlash card.

- 1. Make sure that [PATTERN SELECT] is extinguished.**
If it is lit, press [PATTERN SELECT] to turn it off.
- 2. While holding down [CANCEL], press [DEL].**
The display will indicate "dAL," and [DEL] will light. BANK [A]–[F/J] will blink.
MEMO
If no CompactFlash card is inserted, BANK [C/G]–[F/J] will not blink.
- 3. Press one of the bank buttons to specify the memory that you want to delete.**
BANK [A] or [B]: Internal memory
BANK [C/G]–[F/J]: CompactFlash
* If you decide to cancel the operation at this point, press [CANCEL].
- 4. When you press [DEL], the samples will start being deleted. When the deletion is complete, the "dAL" indication in the display will disappear.**
* Never turn off the power before the deletion is complete. Doing so may destroy not only the samples being deleted, but also other samples, or damage the CompactFlash card itself.
* Once you press [DEL] to begin deleting the samples, you won't be able to cancel the operation by pressing [CANCEL].
* If you specify a bank that is protected (p. 51), the display will indicate "Pr" (Protected), and you won't be able to delete anything.

Resampling

You can play back a sample with an effect applied, and then newly sample the result. This is called "resampling."

- 1. Make sure that [PATTERN SELECT] is extinguished.**
If it is lit, press [PATTERN SELECT] to turn it off.
- 2. Apply an effect to the original sample, and adjust the effect parameters.**
- 3. Press [RESAMPLE] so the button is lit. The display will indicate "LEV."**
- 4. Play back the original sample.**

- 5. Adjust the CTRL 3 (LEVEL) knob so that the display illumination does not light red.**

MEMO

While [RESAMPLE] is lit, you can't use the CTRL 3 knob to adjust the effect depth. If you want to use the CTRL 3 knob to adjust the effect depth, press [CANCEL] to make [RESAMPLE] go out.

- 6. Press [SAMPLING] so the button is blinking. The bank buttons and pads to which resampling is possible will start blinking.**
- 7. Press the pad to which you want to resample, so the pad is lit.**
You can also resample to a different bank.

MEMO

You can't resample to a pad to which a sample is already assigned.

- 8. Press [LO-FI] to select standard grade.**
[LO-FI] unlit: STANDARD (high quality)
[LO-FI] lit: LO-FI (low fidelity)

NOTE

If you've recorded a sample at LO-FI, resampling it at STANDARD quality will not return it to its original quality.

- 9. Press [STEREO] to choose stereo or monaural sampling.**
[STEREO] lit: Stereo sampling
[STEREO] unlit: Monaural sampling
- 10. Press [SAMPLING] so the button is lit. Resampling will not yet begin at this point.**

- 11. Press the pad to which you want to resample. The sample will begin playing, and resampling will start.**

MEMO

Never turn off the power during resampling. Turning off the power at this time may destroy not only the sample being resampled, but also other samples as well.

- 12. When resampling is finished, press [SAMPLING].**
- 13. To hear the resampled sound, press the pad to which you resampled.**

Loop Capture

The SP-555's Loop capture function lets you capture the currently playing sound as a loop phrase.

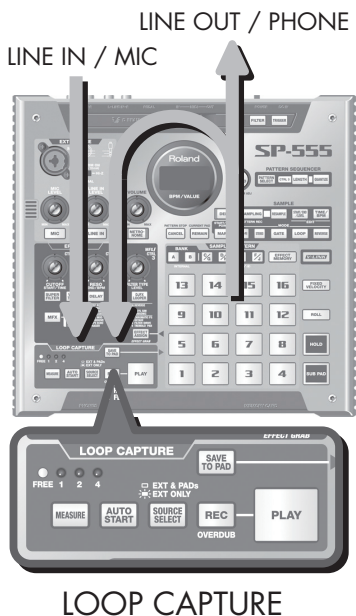

SAVE TO PAD

Saves the phrase recorded by Loop Capture to a pad as a sample.

MEASURE

Specifies the length of the phrase that will be recorded.

PLAY

Plays the phrase that was recorded by Loop Capture.

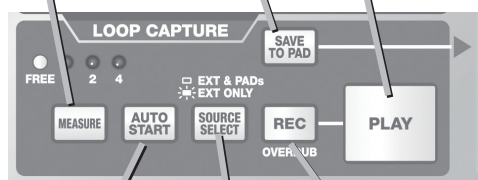

AUTO START

Automatically starts recording when input occurs.

REC

Starts recording.

SOURCE SELECT

EXT ONLY will record the signals from MIC/LINE IN, USB AUDIO, and the internal synthesizer controlled by the D Beam. EXT & PADS will record these signals mixed with the performance of the pads.

Using Loop Capture to record from an external device

* Here we explain how you can use Loop Capture to record from a playback device connected to LINE IN, such as a CD player or portable audio player. If you want to record from a mic, replace references to LINE IN with MIC in the explanation that follows.

MEMO

You can record for a maximum of approximately 15 seconds.

1. **Connect your playback device to LINE IN.**
2. **Press [LINE IN]** so it lights in red.
3. **Adjust the LINE IN LEVEL** so that the **PEAK indicator lights occasionally.**
Get your playback device to produce sound while you adjust the recording level.
4. **If desired, turn on the effect.**
You can record the sound processed by the effect.
→“Applying an effect to the mic/line input” (p. 18)
5. **Press [MEASURE]** enough times to get **FREE** to light.
6. **Play back your external device.**
7. **When you want to start recording, press [REC].**
8. **When you want to stop recording, press [PLAY].**
Recording will stop, and the recorded phrase will be played as a loop.

NOTE

If you record with MEASURE set to FREE, and there is an extremely brief interval (less than 0.3 seconds) from when you press [REC] to start recording until you press [PLAY] (or [REC]) to stop recording, nothing will be recorded.

9. **Press [PLAY] once again to stop the loop playback.**

If you want to re-record, you'll need to delete the sample that was captured by Loop Capture.

MEMO

You can quickly delete the recorded phrase by holding down [EFFECT ASSIGN] and pressing [REC].

NOTE

The BPM value displayed after recording is an approximation derived from the recorded time, and will not be precisely accurate.

Deleting the phrase recorded by Loop Capture

1. Press [DEL].
2. The display will indicate “dEL” and [PLAY] will blink.
3. In the LOOP CAPTURE section, press [PLAY].
4. If you press [DEL], the phrase will be deleted. When the deletion is complete, [PLAY] will go out.

MEMO

If you've selected a protected bank, the display will indicate “Prt,” but you'll still be able to delete the phrase.

* Never turn off the power before the deletion is complete.

MEMO

Alternatively, you can quickly delete the recorded phrase by holding down [EFFECT ASSIGN] and pressing [REC].

Adjusting the playback level of the phrase

1. Make sure that [PATTERN SELECT] is extinguished. If it is lit, press [PATTERN SELECT] to turn it off.
2. Press [PLAY] to play back the phrase.
3. Press [START/END/LEVEL] so the button is lit.
4. Turn the CTRL 3 (LEVEL) knob to adjust the phrase's volume.
5. When you've finished making adjustments, press [START/END/LEVEL] to turn off its light.

Turning the CTRL 3 (LEVEL) knob toward the left will decrease the volume, and turning it toward the right will increase the volume. A setting of 127 is the maximum volume. The default value immediately after recording is 127.

Recording with a specified tempo

If you know the BPM of the phrase you're going to record, or if you're going to record the playback of the pattern sequencer, you can record a specified length of measures.

1. Set the BPM, either by pressing [TAP TEMPO] in rhythm with the tempo, or by holding down [TAP TEMPO] and using the CTRL 2 knob.

MEMO

If you want to record while looping a pad, hold down [TAP TEMPO] and press a pad; the recording tempo will be set to the tempo of that pad.

MEMO

The BPM can be set to any value from 40 to 200. However, if the BPM is a value within the 40–60 or 160–180 ranges, it can be set only in even-numbered values. If the BPM is above 180, you can set it to either 180, 183, 186, 190, 193, 196, or 200.

MEMO

Below 64 BPM, four measures would exceed 15 seconds, so you won't be able to record four entire measures.

2. Press [MEASURE] several times to select either 1, 2, or 4.
3. Press [REC] to start recording.
4. When the specified number of measures has elapsed, recording will end and the newly recorded phrase will play.

NOTE

The BPM value displayed after recording is an approximation derived from the recorded time, and will not be exact.

Layering sound onto a previously recorded phrase (Overdubbing)

1. Press [PLAY] to play a previously recorded phrase. [PLAY] will blink.
2. Press [REC] to begin recording (overdubbing). [REC] will light, and [PLAY] will blink in orange.
3. Press [REC] to stop recording (overdubbing). [REC] will go out and [PLAY] will light in green, and the phrase will continue playing.
4. Press [PLAY] to stop the phrase playback.

Saving a recorded phrase to a pad

By using [SAVE TO PAD], a phrase recorded by Loop Capture can easily be sampled to a pad.

* If you want to cancel the preceding steps during the following procedure, press [CANCEL].

1. Press [SAVE TO PAD].
2. Press a bank button to specify the bank of the save-destination pad. When you press a bank button, the pads in that bank to which sampling is possible (i.e., pads in which nothing has been recorded) will blink.
3. Press one of the blinking pads to specify the save-destination pad.
4. Only the specified pad will be lit, and [SAVE TO PAD] will blink.
5. Press [PLAY] to play back the phrase.
6. Use the CTRL 3 (LEVEL) knob to adjust the level. Adjust the level so that the display indicator does not light red.
7. Press [LO-FI] to select the sampling grade.
[LO-FI] unlit: STANDARD (high quality)
[LO-FI] lit: LO-FI (low fidelity)
8. Press [STEREO] to select stereo or monaural sampling.
[STEREO] lit: Stereo sampling
[STEREO] unlit: Monaural sampling
9. When you've adjusted the level, press [SAVE TO PAD] to begin saving the phrase.

The indication in the display will change from "rdY" to "rEC." When "rEC" disappears, saving is complete.

MEMO

Never turn off the power while saving is in progress. Turning off the power may destroy not only the sample that's being saved, but also other samples as well.

MEMO

Since Loop Capture and Sampling use different internal processing, the length of a phrase recorded by Loop Capture will not precisely match the length of the sample saved in the pad. For this reason, the sample's BPM may be slightly different, or even if the BPM values are the same, timing drift may occur if you loop the sound for an extended time.

MEMO

The sample will be saved in the pad with the GATE setting turned on. Its end point (p. 28) will be set at an appropriate location according to the BPM. If necessary, you can execute Truncate (p. 31) to delete any unwanted portion of the sample.

Tips for using Loop Capture

Selecting the source for Loop Capture

If [SOURCE SELECT] is set to EXT ONLY, you'll be recording only the sound from the external input (MIC/LINE IN) and the sound from the monophonic synthesizer controlled by the D Beam controller. This is useful when you want to play an instrument along with the pad performance or pattern sequencer.

* If you use this setting, the effect will not be applied to the pad performance during recording.

Effects for Loop Capture

You can't apply an effect to the phrase recorded by Loop Capture. If you want to apply an effect to the Loop Capture sound, use [SAVE TO PAD] to save the phrase to a pad.

Loop Capture will record the sound processed by all effects.

Automatically starting sampling (Auto Start)

The Auto Start function lets you automatically start recording when a signal (sound) greater than a specified level is received.

If you've pressed [AUTO START], pressing [REC] will put the SP-555 in standby mode, and recording will begin when a signal is input.

MEMO

This function is independent of the sampling function Auto Sampling.

Editing a sample

Setting a sample's volume

Here's how to adjust the volume of each pad.

1. Make sure that [PATTERN SELECT] is extinguished. If it is lit, press [PATTERN SELECT] to turn it off.
2. Press the pad to which the sample whose volume you want to adjust is assigned. The pad will light, and that sample will play.
3. Press [START/END/LEVEL] so the button is lit.
4. Turn the CTRL 3 (LEVEL) knob to adjust the sample's volume.
5. When you've finished making adjustments, press [START/END/LEVEL] to turn off its light.

Turning the CTRL 3 (LEVEL) knob toward the left will reduce the volume, and turning it toward the right will increase the volume. A setting of 127 is the maximum volume. The default value immediately after sampling is 127.

MEMO

While [START/END/LEVEL] is lit, you can adjust not only the volume but also the start point and end point (p. 29) by using the CTRL 1 and 2 knobs. If you've moved the CTRL 1 or 2 knobs by accident, set them back to the center position. The settings will return to their previous values. If you press [START/END/LEVEL] to turn off the button's light without returning the knobs to the center, the modified start point and end point settings will be set.

Adjusting the playback region of a sample

For each sample, the SP-555 lets you specify the region within the sample's waveform data that will actually play. The point within the waveform data at which playback will begin is called the Start Point, and the point at which playback will end is the End Point.

If there is unwanted sound or silence at the beginning of a sampled sound, you can omit this by adjusting the Start Point. If the unwanted material is at the end, you can adjust the End Point.

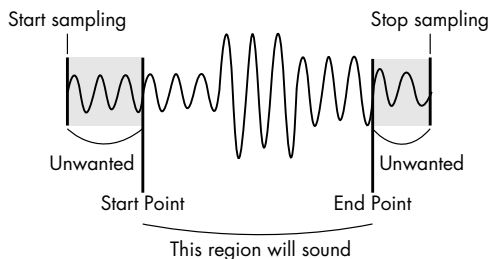

MEMO

When you specify the start point or end point, the BPM (tempo) will be automatically calculated according to the newly specified duration, and displayed. If the duration is multiple measures or less than one measure, the displayed BPM value may be half or double the actual value. To set the BPM to the desired value, refer to "Changing a sample's BPM" (p. 32).

MEMO

In some cases, such as if the length of the region is three beats, it may not be possible to calculate or adjust the BPM value correctly.

Canceling the adjusted playback region (deleting a marker)

[MARK] will light if you've specified either the start point or end point. If you want to cancel these settings, press the lit [MARK] button during playback to turn off the button's light.

MEMO

By carrying out the procedure explained in "Converting to a sample that has a modified playback region" (p. 31), you can delete the portions other than the specified playback region, so that the start point and end point are the beginning and end of the sample.

Adjusting both the start point and end point

1. Make sure that [PATTERN SELECT] is extinguished. If it is lit, press [PATTERN SELECT] to turn it off.
2. Press the pad whose playback region you want to adjust, making it sound.

MEMO

If [MARK] is lit, the start point or end point has already been adjusted. In this case, cancel the start point/end point setting (p. 28) before you proceed with the steps below.

3. While listening to the sound, press [MARK] at the timing of the desired start point.
4. Press [MARK] again at the timing of the desired end point.

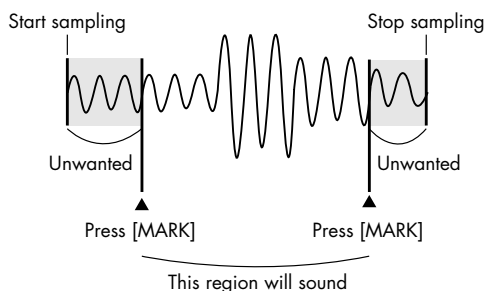

MEMO

If you specify the BPM (tempo) between steps 3 and 4, the end point will automatically be set to the location of the beat that is closest to the timing at which you press [MARK] in step 4 (in units of beats of the BPM value, beginning at the start point). To specify the BPM, you can either press [TIME/BPM] so the button is lit and then turn the CTRL 2 knob, or press [TAP TEMPO] several times.

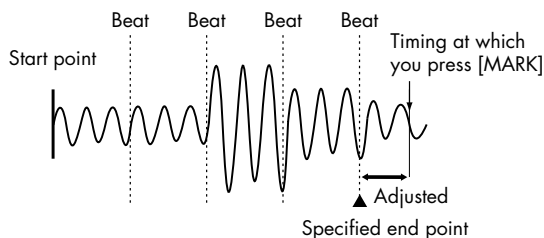

Adjusting only the end point

1. Make sure that [PATTERN SELECT] is extinguished. If it is lit, press [PATTERN SELECT] to turn it off.
2. Hold down [MARK], and press the pad whose playback region you want to adjust, making it sound.
3. When the sound begins to play, release [MARK].
4. While the sound plays, press [MARK] at the timing of the desired end point.

MEMO

If you press [MARK] to turn off its light while the sound is playing, the change in the start point and end point will be cancelled.

Adjusting only the start point

1. Make sure that [PATTERN SELECT] is extinguished. If it is lit, press [PATTERN SELECT] to turn it off.
2. Press the pad whose playback region you want to adjust, making it sound.

MEMO

If [MARK] is lit, the start point or end point has already been adjusted. In this case, cancel the start point/end point setting (p. 28) before you proceed with the steps below.

3. While listening to the sound, press [MARK] at the timing of the desired start point.
4. Stop the pad playback.

Making fine adjustments to the start point and end point

1. Make sure that [PATTERN SELECT] is extinguished. If it is lit, press [PATTERN SELECT] to turn it off.
2. Play the pad whose playback region you want to adjust, making it the current pad.
3. Press [START/END/LEVEL] so the button is lit.
4. Use the CTRL 1 knob to adjust the start point, and the CTRL 2 knob to adjust the end point.
5. When you've finished making adjustments, press [START/END/LEVEL] to turn off its light.

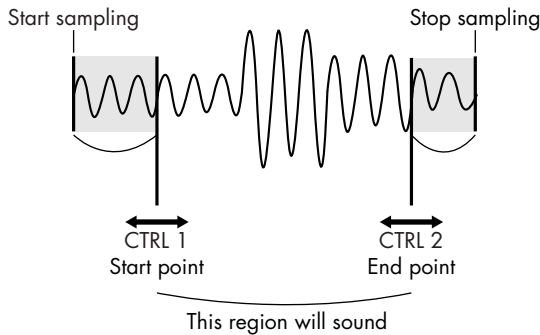

MEMO

- You can press the pad to produce sound even while making adjustments.
- For both the CTRL 1 and 2 knobs, turning the knob toward the left will move the start point/end point toward the beginning of the sound, and turning the knob toward the right will move the point toward the end of the sound.
- You can't adjust the playback region beyond the beginning or end of the sample.
- If you decide to cancel the adjustment, return the CTRL 1 and 2 knobs to the center position so that the indication is "0."
- The range of movement for a single operation is approximately 130 milliseconds before or after the current start point or end point. If you want to adjust the point by a greater amount, repeat the same procedure.
- You can't set the start point and end point closer than approximately 100 milliseconds.
- If your adjustment results in the start point and end point being respectively at the beginning and end of the sample, [MARK] will go out.
- If [MARK] is extinguished (i.e., if the playback region has not been adjusted), adjusting the sample's start point or end point will cause [MARK] to light.
- When you move the start point or end point, the sample's BPM (tempo) will automatically change accordingly. However, there will be a small discrepancy in the BPM.

Exchanging samples between two pads

You can exchange samples between two pads. This lets you bring together the desired samples into a single bank, or move samples from internal memory to a CompactFlash card.

MEMO

If you decide to cancel this operation during the procedure, press [CANCEL].

1. While holding down [DEL], press [SAMPLING].
2. The display will indicate "CHG," and [DEL] and [SAMPLING] will light.
3. Press the pad for one of the samples you want to exchange.
4. Press the other pad.
5. When the two pads have been pressed, [SAMPLING] will blink.
6. When you press [SAMPLING], the exchange will begin. When the "CHG" indication in the display has disappeared, the exchange is complete.

MEMO

If there is not enough free memory to perform the exchange, the display will indicate "Ful" and the exchange cannot be performed.

MEMO

Never turn off the power before the exchange has been completed. Doing so will destroy not only the samples being exchanged, but may also destroy other samples or the CompactFlash card.

Copying a sample to another pad

You can copy a sample from one pad to another pad. This lets you create another sample based on an existing sample.

MEMO

If you decide to cancel this operation during the procedure, press [CANCEL].

1. While holding down [DEL], press [RESAMPLE].
2. The display will indicate "CPY."
3. Press the pad for the copy-source sample.
4. Press the copy-destination pad.
When the two pads have been pressed, [SAMPLING] will blink.
5. When you press [SAMPLING], the copy will begin.
6. When the indication of "CPY" in the display has disappeared, the copy is complete.

MEMO

If there is not enough free memory to perform the copy, the display will indicate "Ful" and the copy cannot be performed.

MEMO

Never turn off the power before the copy has been completed. Doing so will destroy not only the samples being copied, but may also destroy other samples or the CompactFlash card.

Converting to a sample that has a modified playback region

When you adjust the start point or end point, the unused portions of the sample will be unnecessarily occupying memory. By deleting (truncating) these unused portions, you can make efficient use of memory.

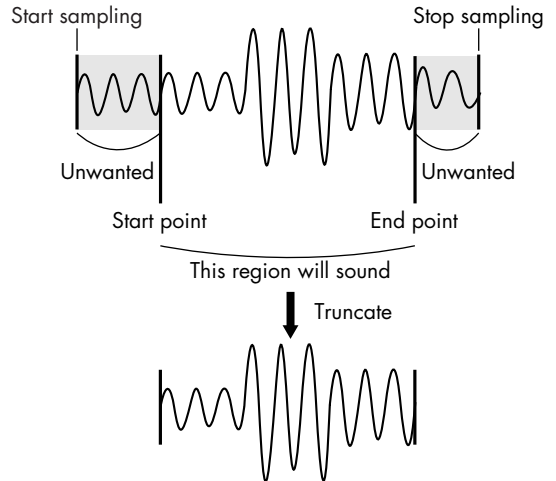

NOTE

This operation cannot be undone.

1. Play the pad that you want to convert, making it the current pad.
2. Make sure that [MARK] is lit (indicating that the playback region has been adjusted).
3. Press [DEL].
4. Press [MARK]. The display indication will change to "trC."
5. Press [DEL] to begin the conversion. When "trC" disappears from the display, the operation is complete.

MEMO

Never turn off the power before this operation has been completed. Doing so will destroy not only the sample being truncated, but may also destroy other samples or the CompactFlash card.

Changing a sample's BPM

A sample's BPM (tempo) is automatically determined by the length between the sample's start point and end point. However, depending on this length, the calculated BPM value may be half or double the actual BPM. In this case, you can correct the BPM as follows.

1. Play the pad that you want to change, making it the current pad.
2. Press [TIME/BPM] so the button is lit.
3. Turn the CTRL 2 (BPM) knob to change the BPM value. Turn the knob toward the left if you want to halve the displayed value, or toward the right if you want to double it.
4. When you've made the change, press [TIME/BPM] once again to turn off the button's light.

MEMO

While you're performing this operation, the CTRL 1 knob will perform the Time Modify function. Be careful not to change it inadvertently.

Changing the length of a sample without changing the pitch (Time Modify)

If you want to consecutively play samples of differing tempo, you can use the Time Modify function to create natural-sounding transitions so that the tempo is not interrupted.

If you've specified Reverse Playback (p. 15), the Time Modify setting is disabled, and the effect won't be obtained. If you want to use Time Modify, you must turn off Reverse Playback.

1. Play the pad that you want to change, making it the current pad.
2. Press [TIME/MODIFY] so the button is lit.
3. Turn the CTRL 1 (TIME) knob to change the length. The display will indicate the sample length in terms of the BPM.
4. When you've finished making the change, press [TIME/BPM] once again to turn off the button's light.

MEMO

Turning the CTRL 1 (TIME) knob all the way to the left will turn Time Modify off, so that the sample will play at its original length. (The display will indicate "oFF.")

MEMO

Turning the CTRL 1 (TIME) knob all the way to the right will cause the sample to play at the tempo of the pattern. (The display will indicate "Ptn.")

MEMO

The BPM can be adjusted to any value from half to approximately 1.3 times the original BPM. However, the BPM must fall within the 40–200 range.

MEMO

If Time Modify is set to "Ptn," the tempo of the sample will change according to the pattern's tempo within a range of between half and approximately 1.3 times the sample's original BPM. If the pattern's tempo is set outside this range, the sample's tempo is limited to the maximum value (200) or minimum value (40).

MEMO

Please be aware that a sample for which you've specified Time Modify may sound quavery or noisy.

Playing samples and recording your performance (Pattern Sequencer)

The SP-555 provides a Pattern Sequencer, which lets you play samples and record your performance. You can play samples, record your performance as a “pattern,” and then play back the recorded pattern. You can create a song by putting together various phrase samples, or create a rhythm pattern by putting together rhythm samples.

How patterns are organized

When [PATTERN SELECT] is lit, one pattern each can be assigned to the sixteen pads (1–16) of the panel. After a pattern has been assigned to each pad, such a collection of sixteen patterns is called a “pattern bank.” The SP-555 lets you use ten pattern banks, A–J. Pattern banks A and B are located in the SP-555’s internal memory, and pattern banks C–J are on the CompactFlash card.

MEMO

When the power is turned on, pattern bank A is selected.

When [PATTERN SELECT] is lit, you can use BANK [A]–[F/J] to specify the pattern bank, and pads 1–16 to specify the pattern.

Specifying the pattern tempo

The pattern tempo setting is shared by all patterns. You can’t specify a different tempo for each pattern.

1. **Set the BPM either by pressing [TAP TEMPO] at the desired tempo or by holding down [TAP TEMPO] and turning the CTRL 2 knob.**

MEMO

[TAP TEMPO] will light when the display shows the pattern tempo.

MEMO

If the pattern tempo is synchronized to the tempo of your MIDI sequencer (p. 69), the display will indicate “Mid” and you won’t be able to perform the operations described below.

MEMO

The BPM can be set to any value from 40 to 200. However, if the BPM is a value within the 40–60 or 160–180 ranges, it can be set only in even-numbered values. If the BPM is above 180, you can set it to either 180, 183, 186, 190, 193, 196, or 200.

Playing and stopping a pattern

When [PATTERN SELECT] is lit, playback will start when you press a pad to which a pattern is assigned. Once playback starts, the pattern will continue playing even after you take your finger off the pad.

To stop the currently playing pattern, press [CANCEL] (PATTERN STOP).

You can also stop pattern playback by pressing the pad of the currently playing pattern (i.e., the pad that is lit).

Switching patterns during playback

1. **Press [PATTERN SELECT] so the button is lit.**

The display will indicate the currently playing measure and beat, and pads to which patterns are assigned will light.

2. **Press one of the BANK [A]–[F/J] buttons to select the bank containing the pattern you want to play next.**

To select a bank G–J, press BANK [C/G]–[F/J] once again so the button is blinking. If no CompactFlash card is inserted, you won’t be able to select pattern banks C–J.

3. **Press the pad for the pattern that you want to play next.**

If you press another pad while a pattern is playing, it will be reserved as the pattern to be played next. When the currently playing pattern has played to the end, the reserved pattern will automatically begin playing.

MEMO

If you hold down [SUB PAD] while you press a pad, playback will switch immediately to the pattern of that pad.

MEMO

If you press a pad to which no pattern is assigned (i.e., a pad that is not lit), nothing will happen.

Recording a pattern

When you play samples and record your performance as a pattern, recording will occur repeatedly for the number of measures you specify (i.e., “loop recording”), allowing you to continue layering (overdubbing) additional samples onto the pattern.

1. Press [PATTERN SELECT] so the button is lit.
The display will indicate “Ptn” and the pads to which a pattern is assigned will blink.
2. Press [SAMPLING] so the button is lit.
All pads to which no pattern is assigned will blink.
3. Press one of the BANK [A]–[F/J] buttons to select the pattern bank into which you want to record.

MEMO

If no CompactFlash card is installed, you won't be able to select pattern banks C–J.

4. Press the pad to which you want to assign the pattern you're going to record.
The pad you pressed will light, and the remaining pads will go out. [SAMPLING] will blink, and the metronome will begin sounding.
5. Press [START/END/LEVEL] so the button is lit.
6. Turn the CTRL 3 (LEVEL) knob to adjust the metronome volume.
7. Press [TIME/BPM] so the button is lit.
The display will indicate the pattern tempo (BPM).
8. Specify the pattern tempo, either by holding down [TAP TEMPO] and turning the CTRL 2 (BPM) knob, or by pressing [TAP TEMPO] several times at the desired tempo.

MEMO

BPM range: 40–200. If the BPM is in the 40–60 or 160–180 ranges, it can be set only in even-numbered values. If the BPM is above 180, you can set it to either 180, 183, 186, 190, 193, 196, or 200.

9. Press [LENGTH] so the button is lit.
The display will indicate the length (number of measures) of the pattern that will be recorded.
10. Turn the CTRL 3 knob to specify the length of the pattern.
The display will indicate the pattern length you specify. Range: 1–99
If the pattern already contains data, you can't make it shorter than its current length.
You can specify the pattern length in one-measure units

for the range of 1–20 measures, and in four-measure units for longer patterns.

11. Press [QUANTIZE] so the button is lit.

[LENGTH] will go out, and the display will indicate the quantize setting.

MEMO

What is quantization?

Quantization is a function that automatically corrects the slight inaccuracies in timing that can sometimes occur when you are pressing pads and playing samples to produce a recording. Once you've specified a quantize setting, your performance will be recorded at accurate intervals of quarter notes, eighth notes, or sixteenth notes. This function is particularly useful when you're creating groove-based music and need the timing to be tight. This is also useful when you're creating rhythm patterns.

12. Turn the CTRL 3 knob to specify the desired quantize setting.

The display will indicate the quantize setting you specify.

The indication has the following significance.

- S.8: Quantize to 8th notes using shuffle quantize.
- S.16: Quantize to 16th notes using shuffle quantize.
- 4: Quantize to quarter notes.
- 4.3: Quantize to quarter-note triplets.
- 8: Quantize to eighth notes.
- 8.3: Quantize to eighth-note triplets.
- 16: Quantize to sixteenth notes.
- 16.3: Quantize to sixteenth-note triplets.
- 32: Quantize to thirty-second notes.
- oFF: Quantize will not be used. The actual timing at which you pressed the pad will be recorded.

MEMO

If you use shuffle quantize, use the CTRL 2 knob to specify the rate. The rate specifies the proportion by which the backbeats will be separated from the downbeats of the quantization you've specified. If this is set to “50,” each backbeat will be exactly between two adjacent downbeats. If this is set to “0,” each backbeat will be at the same timing as the preceding downbeat. If this is “100,” each backbeat will be at the same timing as the following downbeat.

13. Press [QUANTIZE] to extinguish the button.

14. Press [SAMPLING].

[SAMPLING] will change from blinking to lit, and recording will begin.

There will be a one-measure count before recording actually begins, so wait for one measure while listening to the metronome. During this time, the display will indicate a count of -4, -3, -2, -1.

When the count ends, recording will begin, and the display will indicate the measure and beat.

MEMO

Pads you play during the count will not be recorded.

15. Press the pads at the desired timing.

During recording, you can use the pads to play samples. You can also press a bank button to switch sample banks. The samples of the pads you pressed will play, and will be recorded at the timing specified by the selected quantize setting. When the measure number shown in the display reaches the pattern length you specified, you will automatically return to measure one, and recording will continue ("loop recording"). The previously recorded performance will play back during this time. If you press [SAMPLING] once again so the button is blinking, the display will indicate "rEH" and you'll be in Rehearsal mode. In this state, pressing the pads will play the corresponding samples, but they won't be recorded. When you press [SAMPLING] once again so the button is lit, you'll exit Rehearsal mode and return to the conventional recording mode. This gives you a convenient way to find the next sample that you want to play.

16. Press the pads of samples that you want to overdub.

The pad performance that you recorded on the previous pass will be recorded along with your newly added pad performance (overdubbed). You can use this method to gradually build up complex rhythms that would be impossible to play all at once.

During this recording process, you can change the quantization as follows.

1. Press [QUANTIZE] so the button is lit.
2. Turn the CTRL 3 knob to change the quantize setting.
3. When you've made the desired setting, press [QUANTIZE] to extinguish the button. The new quantize setting will be applied immediately.

17. When you want to stop recording, press [CANCEL].

The dot in the display will blink. When the blinking stops, recording is complete.

NOTE

Never turn off the power while the dot is blinking. Doing so may destroy not only the pattern you recorded, but also other patterns or the CompactFlash card.

Erasing a mistake from your performance

If you've played a sample by mistake while recording, you can use the corresponding pad to erase it from the recorded pattern.

1. **Press [PATTERN SELECT] so the button is lit.**
The display will indicate "Ptn" and pads to which a pattern is assigned will blink.
2. **Press [SAMPLING] so the button is lit.**
3. **Press the pad for the pattern containing the performance from which you want to delete the mistake.**
The pad you pressed will light, and the other pads will go out. [SAMPLING] will blink, and the metronome will begin sounding.
4. **Press [SAMPLING].**
[SAMPLING] will change from blinking to lit, and recording will begin. The recorded performance will play back. If you press the pad of a sample at this time, it will be recorded.
5. **Press [DEL] so the button is lit.**
The display will indicate "ErS."
6. **Press the pad for the sample that you want to erase, throughout the period where you want the erasure to take place.**
The dot in the display will blink, and any occurrences of that sample will be erased from the pattern during the duration that you hold down the pad.

MEMO

By holding down [HOLD] you can erase the performances of all pads.

7. **Repeat step 6 as desired.**
8. **When you've finished erasing mistakes, press [DEL].**
[DEL] will go out, and the pattern will return to normal recording.

NOTE

If you press the pad of a sample at this time, it will be recorded.

9. **Press [CANCEL] to carry out the erasure.**
The dot in the display will blink while the erasure is being carried out. When the blinking stops, the erasure is complete.

NOTE

Never turn off the power while the dot is blinking. Doing so may destroy not only the pattern you recorded, but also other patterns or the CompactFlash card.

Deleting a pattern

- 1. Press [PATTERN SELECT] so the button is lit.**
The display will indicate "Ptn" and the pads that have been recorded will blink.
- 2. Press [DEL] so the button is lit.**
The display will indicate "dEL."
If the display indicates "EMP," that bank does not contain any pads to which a pattern is assigned.
- 3. Press a bank button and a pad to specify the bank and pad of the pattern you want to delete.**
The selected pad will light, and [DEL] will blink.
MEMO
Nothing will happen if you press a pad to which no pattern is assigned (i.e., a pad that is not lit).
MEMO
You can simultaneously select more than one pad if they are in the same bank.
MEMO
If you specify a bank that's protected (p. 51), the display will indicate "Prt" (Protected) and you won't be able to delete a pattern.
MEMO
If you decide not to delete a pattern, press [CANCEL].
- 4. Press [DEL] to carry out the deletion.**
During this process, [DEL] will change from blinking to lit, and the dot in the display will blink. When the dot stops blinking, deletion has been completed.

NOTE

Never turn off the power while the dot is blinking. Doing so may destroy not only the pattern you're deleting, but also other patterns or the CompactFlash card.

Deleting all patterns

Here's how to delete all patterns from internal memory or CompactFlash.

- 1. Press [PATTERN SELECT] so the button is lit.**
The display will indicate "Ptn," and pads that are recorded will blink.
- 2. While holding down [CANCEL], press [DEL].**
The display will indicate "dAL," and [DEL] will light.
BANK [A]-[F/J] will blink.
MEMO
If no CompactFlash card is inserted, BANK [C/G]-[F/J] will not blink.
- 3. Press one of the bank buttons to specify the memory that you want to erase.**
BANK [A] or [B]: Internal memory
BANK [C/G]-[F/J]: CompactFlash
MEMO
If you specify a protected bank (p. 51), the display will indicate "Prt" (Protected), and you won't be able to delete the patterns.
MEMO
If you decide not to delete the patterns, press [CANCEL].
- 4. Press [DEL] to carry out the deletion.**
During this process, [DEL] will change from blinking to lit, and the dot in the display will blink. When the dot stops blinking, the deletion has been completed.

NOTE

Never turn off the power while the dot is blinking. Doing so may destroy not only the patterns you're deleting, but also other patterns or the CompactFlash card.

Exchanging the patterns of two pads

You can change the patterns assigned to each pad by exchanging patterns between two pads.

You can also exchange patterns between a pad to which an already-recorded pattern is assigned and a pad to which no pattern is assigned.

- 1. Press [PATTERN SELECT] so the button is lit.**
The display will indicate "Ptn."
- 2. While holding down [DEL], press [SAMPLING].**
[DEL] and [SAMPLING] will light, the display will indicate "CHG," and pads to which a pattern is assigned will blink.
- 3. Press a bank button and pad to select one of the patterns that you want to exchange.**
The pad will light.
- 4. Press a bank button and pad to select the other pattern that you want to exchange.**
The pad will light, and [SAMPLING] will blink.
- 5. Press [SAMPLING] to carry out the exchange.**
[DEL] and [SAMPLING] will light, and the dot in the display will blink. When the dot stops blinking, the exchange has been completed.

MEMO

If you're exchanging patterns between internal memory and the CompactFlash card, and there is insufficient internal memory or insufficient space on the CompactFlash card, the display will indicate "FuL" and you won't be able to carry out the exchange.

NOTE

Never turn off the power while the dot is blinking. Doing so may destroy not only the patterns you're exchanging, but also other patterns or the CompactFlash card.

Copying a pattern to another pad

You can copy a pattern from one pad to another pad. This lets you create a new pattern based on an existing pattern.

MEMO

If you decide to cancel this operation midway through the procedure, press [CANCEL].

- 1. Press [PATTERN SELECT] so the button is lit.**
The display will indicate "Ptn."
- 2. While holding down [DEL], press [RESAMPLE].**
- 3. The display will indicate "CPY."**
- 4. Press the copy-source pad.**
- 5. Press the copy-destination pad.**
The pads to which you can copy will blink.
- 6. When you've pressed the two pads, [SAMPLING] will blink.**
- 7. Press [SAMPLING] to start the copy. When the "CPY" indication disappears from the display, the copy has been completed.**

MEMO

If there's not enough memory to perform the copy, the display will indicate "FuL" and the copy will not be performed.

NOTE

Never turn off the power before the copy operation has been completed. Doing so may destroy not only the patterns you're copying, but also other patterns or the CompactFlash card.

D Beam controller



The SP-555 provides a D Beam controller, which lets you modify the sound in various ways by moving your hand above it. You can choose one of three modes: [SYNTH] (monophonic synthesizer), which lets you control the pitch by your hand position; [FILTER], which lets you control the cutoff frequency; and [TRIGGER], which lets you trigger the desired pad.

The effective range of the D Beam controller

The illustration below shows the effective range of the D Beam controller. Moving your hand beyond this range will not produce any effect.

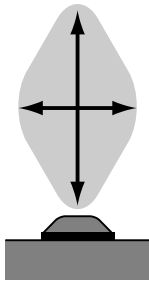

NOTE

The effective range of the D Beam controller will be greatly reduced under strong, direct sunlight. Please be aware of this when using the D Beam controller outdoors.

NOTE

The sensitivity of the D Beam controller will change depending on the brightness of the environment. If it does not operate as you expect, please readjust the sensitivity (D Beam Sens) as follows.

While holding down [CANCEL], press either [SYNTH], [FILTER], or [TRIGGER], and then use the CTRL 3 knob to adjust the sensitivity. Turning the knob toward the right will increase the sensitivity. When you've finished adjusting the sensitivity, you can press [SAMPLING] to save the setting.

Monophonic synthesizer (SYNTH)

If you press [SYNTH] so the button is lit, you'll be able to use the SP-555 as a monophonic synthesizer whose pitch is controlled by the position of your hand above the D Beam controller. Moving your hand closer to the controller will raise the pitch in steps of the scale you select. Use [SYNTH] + CTRL 2 to change the scale.

There's also a built-in delay that can be used to produce a variety of effects.

[SYNTH] will blink when you're within the effective range of the D Beam controller.

Synth settings

Purpose	Operation
Tone setting	[SYNTH] + pads 1–8
Delay setting	[SYNTH] + pads 9–16
Key shift setting	[SYNTH] + CTRL 1
Scale setting (* 1)	[SYNTH] + CTRL 2
Volume setting	[SYNTH] + CTRL 3
Apply an effect	[EFFECT ASSIGN] + [SYNTH]

* 1: Select one of the following effects

- Chr: Chromatic Scale
- tCH: Tcherepnin's Scale
- SPn: Spanish Scale
- bLS: Blues Mixolydian Scale
- Cd: Combination of Diminished Scale
- MAJ: Diatonic Major Scale
- Min: Natural Minor Scale
- HMJ: Harmonic Major Scale
- HMi: Harmonic minor Scale
- dH: Double Harmonic Scale
- MMi: Melodic Minor Scale
- GPS: Gypsy Scale
- doM: Dominant Scale
- Wt: Whole Tone Scale
- Hbl: Hexatonic Blue Scale
- AUG: Augmented Scale
- rkY: Ryukyu Scale
- iSd: In Sen Scale, Descending
- iSA: In Sen Scale, Ascending
- PMJ: Major Pentatonic Scale
- PMi: Minor Pentatonic Scale

Filter

If you press [FILTER] so the button is lit, you'll be able to control the cutoff frequency of a filter by moving your hand above the controller.

[FILTER] will blink when you're within the effective range of the D Beam controller.

Filter settings

Press [FILTER] + a pad to select the desired combination of filter type and resonance.

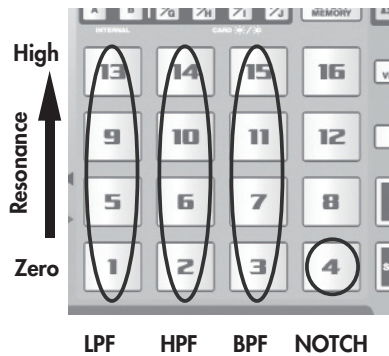

- Pad 1: Low-pass filter
- Pad 2: High-pass filter
- Pad 3: Band-pass filter
- Pad 4: Notch filter

Higher pads select a filter with stronger resonance.

Trigger

If you press [TRIGGER] so the button is lit, you'll be able to play the desired pad by moving your hand above the controller.

To specify the pad, hold down [TRIGGER] and press the desired pad 1–16.

NOTE

Be aware that if you select Trigger and then switch the pad bank, the pad that will be triggered will not change, but the sample that will be played will be different.

You can use [TRIGGER] + CTRL 3 knob to specify the velocity at which the pad will play.

MEMO

If you're using Roll to play the pad, and you turn the D Beam controller [TRIGGER] on, you'll be able to use the D Beam controller to control the volume of the roll.

NOTE

If the SP-555 is in a state in which pressing a pad does not play a sample (e.g., if [PATTERN SELECT] is lit or if [EFFECT ASSIGN] is lit), you won't be able to use the D Beam controller to trigger pads.

Connecting the SP-555 to your computer

The SP-555 provides USB audio/MIDI interface functionality.

If you install a dedicated driver in your computer and use a USB cable (sold separately) to connect the SP-555 to your computer, you'll be able to output sound from your computer via the SP-555. By using the included SONAR LE software, you can use your computer to record sound from a guitar or mic connected to the SP-555.

You can also use SP-555 Wave Converter to convert WAV/AIFF format files that you created on your computer into SP-555 samples, or to convert SP-555 samples to WAV/AIFF format files.

NOTE

You must install the driver before you connect the SP-555 to your computer.

Installing the driver and software

Windows XP users

* In order to install the driver and the software, you'll need to log on as a user who has administrative privileges.

Installing the driver

1. Start up your computer with all USB cables disconnected (except for a USB keyboard and/or mouse, if used).
2. Navigate to the SP-555 UTILITY CD-ROM "Driver" folder → "XP" folder, and double-click Setup.exe.
3. When the display indicates "Roland SP-555 Driver will be installed on your computer..." click [Next].
4. Follow the on-screen directions to proceed with the driver installation.

* The SP-555 UTILITY CD-ROM Driver folder → XP folder contains a Readme file that describes how to install the driver, and provides troubleshooting information. Be sure to read this before you use the system.

Installing SP-555 Wave Converter

1. Navigate to the SP-555 UTILITY CD-ROM "Wave Converter" folder, and double-click Setup.exe.
2. The "Welcome" screen will appear. Click [Next].
3. Follow the on-screen directions to proceed with installing SP-555 Wave Converter.

Installing SONAR LE

1. Place the installation CD-ROM into your computer's CD-ROM drive.
 - * If the auto-play dialog box appears, choose "Run Setup.exe" and proceed to step 4.
2. From the Windows Start menu, choose "My Computer."
3. The drives detected by your computer will appear; double-click the CD-ROM drive.
4. The installer will start up. Proceed with the installation as directed by the on-screen instructions.
 - * If SONAR LE automatically starts up after installation is completed, refer to "Starting SONAR LE and making settings" (p. 43).

Windows Vista users

- * In order to install the driver and the software, you'll need to log on as a user who has administrative privileges.

Installing the driver

1. Start up your computer with all USB cables disconnected (except for a USB keyboard and/or mouse, if used).
2. Navigate to the SP-555 UTILITY CD-ROM "Driver" folder → "Vista" folder, and double-click Setup.exe.
3. A user account control screen will appear; click [Continue].
4. When the display indicates "Roland SP-555 Driver will be installed on your computer...." click [Next].
5. Follow the on-screen directions to proceed with the driver installation.

- * The SP-555 UTILITY CD-ROM Driver folder → Vista folder contains a Readme file that describes how to install the driver, and provides troubleshooting information. Be sure to read this before you use the system.

Installing SP-555 Wave Converter

1. Navigate to the SP-555 UTILITY CD-ROM "Wave Converter" folder, and double-click Setup.exe.
2. The screen will indicate "An unidentified program is trying to access your computer." Click [Allow].
3. The installer will start up. Follow the on-screen directions to proceed with installing SP-555 Wave Converter.

Installing SONAR LE

1. Place the installation CD-ROM into your computer's CD-ROM drive.
 - * If the auto-play dialog box appears, choose "Run Setup.exe" and proceed to step 5.
2. From the Windows Start menu, choose "Computer."
3. The drives detected by your computer will appear; double-click the CD-ROM drive.
4. The screen will indicate "An unidentified program is trying to access your computer." Click [Allow].

5. The installer will start up. Proceed with the installation as directed by the on-screen instructions.

- * When the "Finished with setup" dialog box appears, clear the "Start up SONAR LE" check box, and click "Finish." If you fail to clear this check box and the program starts up, exit SONAR LE.

6. When installation is completed, right-click the "SONAR LE" icon on your desktop, and choose "Properties" from the menu that appears.

7. Click the "Compatibility" tab to access the Compatibility page.

8. In "Privilege level," select "Run this program as administrator."

9. Click "OK" to close the Properties.

- * When you start up SONAR LE, the display will indicate "An unidentified program is trying to access your computer." Click [Allow].

Mac OS X users

Installing the driver

* If the "Authentication" dialog box appears during the installation, enter the password and click [OK].

1. Start up your computer with all USB cables disconnected (except for a USB keyboard and/or mouse, if used).
2. Navigate to the "Driver" folder on the CD-ROM, and double-click SP555USBDriver.pkg.
3. In some cases you may see the message "A program must be executed by this installer package to determine whether installation is possible. Continue?" If so, click [Continue].
4. The screen will indicate "Welcome to the Roland SP-555 Driver installer." Click [Continue].
5. The screen will indicate "Select the installation destination," so click the drive in which the system is installed, and then click [Continue].
6. The screen will indicate "Easy installation," so click either [Install] or [Upgrade].
7. The screen will indicate "When you install this software, you'll need to restart your computer when the installation is completed." Click [Continue with installation].
8. The screen will indicate "The software was installed successfully," so click [Restart] to restart your computer.

This completes installation of the SP-555 Driver.

Installing SP-555 Wave Converter

1. Navigate to the "Wave Converter" folder on the SP-555 UTILITY CD-ROM, and double-click "SP-555 Wave Converter Installer.pkg."
2. The installer will start up. Follow the on-screen instructions to proceed with installing SP-555 Wave Converter.

This completes installation of SP-555 Wave Converter.

Changing the signal flow when using USB audio

MEMO

For the default state and the overall signal flow, refer to "Signal flow (block diagram)" (p. 14).

To do this	Operation	Remarks
Turn the USB audio input on/off from your computer	Hold down [CANCEL] and use the CTRL 3 knob ("OFF" / "on")	Default setting is on. This setting will return to the default when you turn off the power.
Apply or bypass the effect for the USB audio input from the computer	While holding down [EFFECT ASSIGN] and [CANCEL], press [MIC (or [LINE IN])]	The effect is applied by default. This setting will return to the default when you turn off the power.
Switch the source that is output to USB audio from the SP-555	While holding down [CANCEL], press [LINE IN] and use the CTRL 3 knob ("OFF" / "InP" / "out")	The default setting is out (output the same signal as LINE OUT). InP will output only the LINE IN signal and MIC IN signal. This setting will return to the default when you turn off the power.

NOTE

If you're using software that has a recording monitor or input monitor function, and select "InP" as the source being output from the SP-555 to USB, it is possible that the audio signal will create a feedback loop. Either turn off the recording monitor or input monitor function in your software, or select "OFF" or "out" for the source being output from the SP-555 to USB audio.

About SONAR LE (Windows only)

SONAR LE is a DAW application for Windows. It allows you to perform a variety of operations ranging from music production using MIDI and audio, all the way to creating master data.

Starting SONAR LE and making settings

1. Double-click the SONAR LE icon on your desktop.
2. When the audio device confirmation dialog box appears, click Yes. When it completes successfully, click Close.
3. When the online activation dialog box appears, select "Activate later" and click [OK].
4. The hint of the day will appear. Click close.
5. A dialog box indicating that you have not selected MIDI outputs will appear. Click Choose MIDI Output, and the MIDI Devices dialog box will appear.
6. In the MIDI Devices dialog box, select the device containing the characters "SP-555" for both input and output, and click OK to close the dialog box.
7. When the quick start dialog box appears, click Close.

SONAR will now start up. Next, you'll make audio device settings.

1. With SONAR running, select the Option menu item Audio to open the Audio Device dialog box.
2. Open the Devices tab, and for both the input device and the output device, select only the device containing the characters "SP-555." Then click OK to close the dialog box. When the screen suggests that you restart SONAR LE, restart SONAR LE.

This completes settings for SONAR LE.

For details on using SONAR LE, refer to the online help. While SONAR LE is running, you can press the F1 key to access the online help.

About SP-555 Wave Converter

SP-555 Wave Converter is a tool that converts samples on a **CompactFlash** card formatted for the SP-555 to WAV/AIFF files on your computer, and vice versa.

NOTE

In order for you to use SP-555 Wave Converter, you'll need a CompactFlash card, and a CompactFlash card reader for your computer.

Starting up SP-555 Wave Converter

1. Before you continue, format a CompactFlash card on the SP-555.
 - * A CompactFlash card formatted by your computer can't be used with the SP-555.
2. Connect the CompactFlash card reader to your computer, and insert the CompactFlash card into the reader.
3. Start up SP-555 Wave Converter.
 - On Windows, Start → All Programs → SP-555 Wave Converter → SP-555 Wave Converter
 - On Mac OS, Finder → Applications → Roland → SP-555 Wave Converter
 SP-555 Wave Converter will start up.

For details on using SP-555 Wave Converter, refer to the online manual. The online manual is located in the Manual folder inside the folder in which SP-555 Wave Converter is installed.

About CompactFlash

Recommended types of CompactFlash

The SP-555 supports CompactFlash cards (type I) having a capacity of from 32 MB up to 2 GB.

- * You can't use Type II cards such as Microdrives.

CompactFlash theft prevention

When the SP-555 is shipped from the factory, special screws are attached to the bottom panel at the locations marked by ★. With the memory card cover attached, you can use a Phillips screwdriver to remove these screws and reinstall them in the CARD LOCK screw holes, making it impossible to remove the memory card cover, and helping to prevent theft of the CompactFlash card.

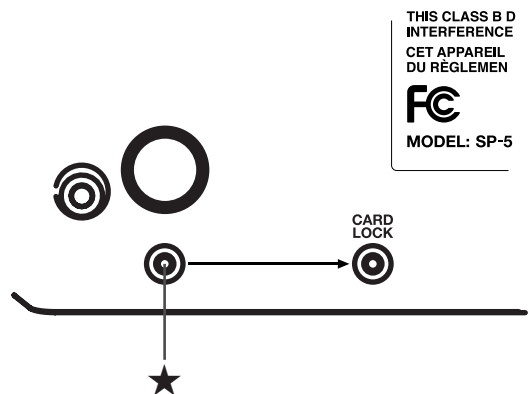

NOTE

When turning the unit upside-down, get a bunch of newspapers or magazines, and place them under the four corners or at both ends to prevent damage to the buttons and controls. Also, you should try to orient the unit so no buttons or controls get damaged.

NOTE

When turning the unit upside-down, handle with care to avoid dropping it, or allowing it to fall or tip over.

- * You must use only these screws. Using any other screws will cause malfunctions.

Inserting and removing CompactFlash cards

NOTE

Never insert or remove a CompactFlash card while this unit's power is on. Doing so may corrupt the unit's data or the data on the CompactFlash card.

Inserting a CompactFlash card

1. Switch off the SP-555's power.
2. Remove the memory card cover.
3. Insert the CompactFlash card in the front panel card slot.
4. Attach the memory card cover.

NOTE

Carefully insert the CompactFlash card all the way in—until it is firmly in place.

NOTE

If you're using a CompactFlash card for the first time, you must format it using the SP-555. The SP-555 will not recognize a CompactFlash card that was formatted by another device.

Removing a CompactFlash card

1. Switch off the SP-555's power.
2. Remove the memory card cover.
3. Push the eject button located beside the front panel card slot. The CompactFlash card will pop out partially. Grasp the CompactFlash card and pull it out toward yourself.
4. Attach the memory card cover.

Formatting a CompactFlash card (initializing)

NOTE

When you format a CompactFlash card, all data on that card will be erased.

1. While holding down [CANCEL], press [REMAIN]. BANK [C/G]–[F/J] will blink, and the display will indicate "FMt."
2. Press any one of the BANK [C/F]–[F/J] buttons. BANK [C/F]–[F/J] will change from blinking to lit, and [DEL] will blink.

MEMO

If you decide not to format the card, press [CANCEL].

3. Press [DEL]. [DEL] will light, and formatting will begin. During the formatting process, the dot in the display will blink. When the blinking stops, formatting is complete.

NOTE

Never turn off the power while the dot is blinking. Doing so may damage the CompactFlash card, rendering it unusable.

NOTE

Don't modify or delete the files or folders that are created when a CompactFlash card is formatted. The SP-555 will not recognize the card correctly if you do so.

Importing audio files

You can import audio files via CompactFlash card and assign them to pads.

Caution when importing audio files (WAV/AIFF)

- Use a CompactFlash card that was formatted by the SP-555.
- When you use your computer or other device to copy or save audio files (WAV/AIFF) on a CompactFlash card, place the files in the root directory (top level) of the CompactFlash card. You won't be able to import the files into the SP-555 if they're anywhere other than the root directory.
- A maximum of 160 audio files can be handled when importing. If more than this number of audio files are on the CompactFlash card, unexpected operation may occur.
- You can't use the "." (period) character at the beginning of a file name. Nor can certain other characters (\ / : , * ? " < > |) be used in a file name.
- The extension of a WAV file must be WAV, and the extension of an AIFF file must be AIF. The file will not be recognized if its name has any other extension.
- The audio files will be imported in the ASCII code order of their file names.
- 8-bit and 16-bit are the only sample depths supported.
- Sample rate conversion will not be performed. The data will be imported as if it had a sample rate of 44.1 kHz. If you import a file whose actual sample rate is other than 44.1 kHz, the playback pitch will be incorrect.
- Loop point settings in an AIFF file will be ignored.
- If you attempt to import a WAV/AIFF file whose format is not supported by the SP-555, the error message "UnS" (Unsupported) will appear, and you won't be able to import the file.
- Compressed audio files cannot be imported.
- In some cases, it may not be possible to import audio files of an extremely short duration.
- Importing will take approximately half as long as the playback time of the audio file.
- Once you start the import process, you cannot cancel it before completion.

1. Make sure that [PATTERN SELECT] is extinguished.

If it is lit, press [PATTERN SELECT] to turn it off.

2. While holding down [CANCEL], press [RESAMPLE].

The display will indicate "FIL" (File Import/Export), and [SAMPLING] and [RESAMPLE] will blink.

3. Press [SAMPLING].

The display will indicate "iMP" (File Import), [SAMPLING] will light, and [RESAMPLE] will go out. Pads [1]–[16] will blink.

MEMO

If there is no audio file in the CompactFlash card, the display will indicate "EMP" (Empty), and the Import operation cannot be performed.

4. Select the import-destination sample bank.

Press one of the BANK [A]–[F/J] buttons. The button you pressed will light, and that bank (A–F) will be selected. If you press BANK [C/G]–[F/J] once again, that button will change from lit to blinking, and the corresponding bank G–J will be selected.

5. Select the import-destination pad.

The pad you pressed will light, and the other pads will stop blinking. [SAMPLING] will also blink. If a sample is assigned to the selected pad (or subsequent pads if you selected more than one pad), it will be overwritten. If you specify a pad that is protected (p. 51), the display will indicate "Prt" (Protected), and you won't be able to import the file.

6. Press [SAMPLING] so the button is lit.

If there are two or more files, they will be imported in order of their file name, starting at the pad you selected in step 5.

During the import process, the dot in the display will blink. When the blinking dot has disappeared, the import process has been completed.

Exporting audio files

A sample assigned to a pad can be exported to a CompactFlash card as an audio file.

1. While holding down [RESAMPLE], turn on the power.
2. Turn the CTRL 3 knob to select the format in which you want to export the files.

WAV: WAV format
AiF: AIFF format

3. Press [SAMPLING] to confirm your choice of file type.

MEMO

This selection is maintained even when you turn off the power.

4. Make sure that [PATTERN SELECT] is extinguished. If it is lit, press [PATTERN SELECT] to turn it off.

5. While holding down [CANCEL], press [RESAMPLE].

The display will indicate "FiL" (File Import/Export), and [SAMPLING] and [RESAMPLE] will blink.

6. Press [RESAMPLE].

The display will indicate "EXP" (File Export), [SAMPLING] will light, and [RESAMPLE] will go out.

7. Select the export-source sample bank.

Press one of the BANK [A]–[F/J] buttons. The button you pressed will light, and that bank (A–F) will be selected. If you press BANK [C/G]–[F/J] once again, that button will change from lit to blinking, and the corresponding bank G–J will be selected.

Pads to which a sample is assigned will blink.

MEMO

If the selected bank contains no samples, the display will indicate "EMP" (Empty).

8. Select the export-source pad.

The pad you pressed will light, and the other pads will stop blinking.

[SAMPLING] will also blink.

MEMO

You can select two or more pads if they are within the same sample bank. To select a pad, press a pad that was blinking in step 7, so it lights steadily.

9. Press [SAMPLING] so the button is lit.

During the export, the dot in the display will blink. When the blinking dot has disappeared, the export process is complete.

NOTE

If there are identically named audio files in the root folder of the CompactFlash card, they will be overwritten.

Naming of exported audio files (WAV/AIFF)

Audio files (WAV/AIFF) that have been exported to a CompactFlash card will be located in the root folder (top level) of the CompactFlash card.

When you use a computer or similar device to look at the root folder of the CompactFlash card, the exported audio files (WAV/AIFF) will be named as follows.

- If you've exported the sample of sample bank A pad 1:
WAV: A_01.WAV
AIFF: A_01.AIF
- If you've exported the samples of sample bank E pads 6–16:
WAV: E_06.WAV–E_16.WAV
AIFF: E_06.AIF–E_16.AIF

Saving backup data (backup save)

Here's how to save a set of backup data (containing all of the SP-555's internal data including sample banks and pattern banks) to a CompactFlash card. Up to sixteen sets of backup data can be saved on a card.

NOTE

If you've saved numerous samples and patterns on a card, and it doesn't have much space remaining, you'll only be able to save a small number of backup sets.

1. While holding down [CANCEL], press one of the BANK [C/G]–[F/J] buttons.

The display will indicate "SAV," and the pads to which backup data has not been saved will blink.

2. Select the desired save-destination pad.

The selected pad will light, the other pads will go out, and [SAMPLING] will light.

MEMO

You can't select a pad that is unlit in step 1 (i.e., a pad in which no data has been saved).

MEMO

If you decide to cancel, press [CANCEL].

3. Press [SAMPLING].

[SAMPLING] will light, and the backup save operation will be executed. During execution, the dot in the display will blink. When the blinking stops, the backup save operation has been completed.

NOTE

Never turn off the power while the dot is blinking. Doing so may destroy the backup data or the CompactFlash card.

Loading backup data (backup load)

Here's how to load a set of backup data (containing all the SP-555's settings including sample banks and pattern banks) from a CompactFlash card.

When you execute the backup load operation, the SP-555's settings will be erased and overwritten by the newly loaded backup data.

1. While holding down [CANCEL], press the BANK [A] or [B] button.

The display will indicate "Lod," and the pads to which backup data has been saved will blink.

MEMO

If the memory is protected (p. 51), the display will indicate "Prt" (Protected) and the backup load operation cannot be executed.

MEMO

If there is no backup data on the CompactFlash card, the display will indicate "EnP" and the backup load operation cannot be executed.

2. Press a pad to select the backup data that you want to load.

The selected pad will light, and the other pads will go out. [SAMPLING] will blink.

MEMO

You can't select a pad that was unlit in step 1 (i.e., a pad in which no data was saved).

MEMO

If you decide to cancel, press [CANCEL].

3. Press [SAMPLING].

[SAMPLING] will light, and the backup load operation will be executed. During execution, the dot in the display will blink. When the blinking stops, the backup load operation has been completed.

NOTE

Never turn off the power while the dot is blinking. Doing so may destroy the SP-555's internal memory data or the CompactFlash card.

Deleting backup data (backup delete)

Here's how to delete a set of backup data (containing all the SP-555's settings including sample banks and pattern banks) from the CompactFlash card.

1. While holding down [DEL], press one of the BANK [C/G]-[F/J] buttons.

The display will indicate "bdL," and the pads to which backup data has been saved will blink.

2. Press a pad to specify the backup data you want to delete.

The selected pad will light, and the other pads will go out.

[DEL] will blink.

MEMO

You can't select a pad that is unlit in step 1 (i.e., a pad in which no data has been saved).

MEMO

If you decide to cancel, press [CANCEL].

3. Press [DEL].

[DEL] will light, and the backup delete operation will be executed. During execution, the dot in the display will blink. When the blinking stops, the backup delete operation has been completed.

NOTE

Never turn off the power while the dot is blinking. Doing so may destroy the backup data or the CompactFlash card.

Other settings

Restoring the factory settings

Here's how to restore all settings of the SP-555, including the sample and pattern data (banks A and B) and effect memory settings to the factory-set state.

NOTE

This operation will cause all internal memory data to be lost. If necessary, you should make a backup before you proceed. ("Saving backup data (backup save)" (p. 48))

1. Switch off the SP-555's power.
2. Copy the "FCTRY" folder from the SP-555 UTILITY CD-ROM into the "ROLAND" folder of a CompactFlash card that was formatted by the SP-555.

MEMO

The FCTRY folder of the SP-555 UTILITY CD-ROM contains the factory preset data.

3. Insert the CompactFlash card into the SP-555, and while holding down [CANCEL], [REMAIN], and [DEL], turn on the power.

The display will indicate "ini," and [SAMPLING] will blink.

MEMO

If you decide to cancel the operation, simply turn off the power.

4. If you are sure you want to restore the SP-555 to the factory settings, press [SAMPLING].
[SAMPLING] will light, and the dot in the display will blink. When the blinking dot disappears, the operation has been completed.

NOTE

Never turn off the power while the dot is blinking. Doing so may destroy the data.

Clearing the data (initialization)

Here's how to erase all of the internal memory (bank A and B) sample and pattern data, as well as the effect memory settings, and initialize other internal settings to the default state.

NOTE

This operation will cause all internal memory data to be lost. If necessary, you should make a backup before you proceed. ("Saving backup data (backup save)" (p. 48))

1. While holding down [CANCEL], turn on the power of the SP-555; this will turn off the internal memory protect setting.

The display will indicate "P.oF," indicating that protection has been disabled for the samples and pads of banks A-J.

2. Switch off the SP-555's power.

3. While holding down [CANCEL], [REMAIN], and [DEL], turn on the power.

The display will indicate "ini," and [SAMPLING] will blink.

MEMO

If you decide to cancel the operation, simply turn off the power.

4. If you are sure you want to initialize the SP-555, press [SAMPLING].

[SAMPLING] will light, and the dot in the display will blink. When the blinking dot disappears, the operation has been completed.

NOTE

Never turn off the power while the dot is blinking. Doing so may destroy the data.

Protecting the memory

You can protect the memory so that samples and patterns cannot be deleted accidentally.

Protecting all samples and patterns

1. **While holding down [REMAIN], turn on the power.**
The display will indicate "P.on," and the samples and patterns of banks A–J will be protected.

NOTE

If you use a CompactFlash card with the same SP-555, the card banks will also be protected, but the card will not be protected when used with another device or computer.

MEMO

This setting is retained even while the power is turned off.

Protecting the preset samples and patterns (sample bank A and pattern bank A)

1. **While holding down BANK [A] and [REMAIN], turn on the power.**
The display will indicate "A.on," and the samples and patterns of bank A will be protected.

MEMO

This setting is retained even while the power is turned off.

MEMO

With the factory settings, sample bank A and pattern bank A are protected.

Canceling protection

1. **While holding down [CANCEL], turn on the power.**
The display will indicate "P.oF," and protection will be cancelled for the samples and patterns of banks A–J.

MEMO

Protection will be cancelled for the factory-set samples and patterns.

MEMO

This setting is retained even while the power is turned off.

Adjusting the blinking speed of the display illumination

Here's how to adjust the speed of the illumination around the display.

1. **While holding down [TAP TEMPO], turn on the power.**
The display will indicate "LEd."
2. **Turn the CTRL 3 knob to adjust the speed.**
[SAMPLING] will blink when you turn the knob.

Setting	Explanation
"oFF"	The illumination will not blink. * It will not blink even during pattern playback.
"1–9"	The illumination will blink at a fixed speed. Higher settings produce faster blinking. * While a pattern is playing, the blinking will be synchronized to the tempo of the pattern.
"Ptn"	The illumination will blink in synchronization with the pattern tempo.

3. **Press [SAMPLING] to confirm the speed of blinking.**

MEMO

If you decide to cancel, press [CANCEL].

MEMO

This setting is retained even while the power is turned off.

Checking the version number

1. **While holding down [MARK], turn on the power.**
The display will indicate the version number.

MEMO

Press [CANCEL] to return to the normal state.

Setting the SP-555's internal processing level

Here's how to adjust the overall volume of the SP-555 for internal processing.

1. **While holding down [CANCEL] and [START/END/LEVEL], turn the CTRL 3 (LEVEL) knob.**

Range: -3 dB, 0 dB, 3 dB, 6 dB, 9 dB, 12 dB

MEMO

The SP-555 has a maximum polyphony of twelve notes. There will be a major difference in the volume depending on whether one note or twelve notes are being produced. If you are playing only a few pads at a time, or if you have connected the SP-555 to a DJ mixer or other device, and are using it as an effects processor, raising this internal processing level will allow you to output a higher level. If you are playing a larger number of pads simultaneously and the sound is distorting, you should lower this internal processing level. When the power is turned on, this will always be set to 0 dB.

About V-LINK

What is V-LINK?

V-LINK (**V-LINK**) is functionality promoted by Roland that makes it easy to synchronize visual effects with music. By using video equipment that supports the use of V-LINK (such as Edirol motion dive .tokyo Performance Package), you can easily produce a variety of visual effects that are linked to the expressive elements of your performance.

For example, if you use the SP-555 in conjunction with the motion dive .tokyo Performance Package, you'll be able to do the following.

- Use the SP-555's synthesizer to produce synchronized music and video performances.
- Play the SP-555's pads or sequencer (songs or patterns) to switch images on the motion dive .tokyo Performance Package.
- Use the SP-555's CTRL 1–3 knobs and D Beam controller to control the brightness or hue of an image.

MEMO

In order to use V-LINK between the SP-555 and the motion dive .tokyo Performance Package, you'll need to make connections using a MIDI cable (sold separately).

Connection example

As an example, we will use a setup in which the SP-555 is connected to the motion dive .tokyo Performance Package. Use a MIDI cable to connect the SP-555's MIDI OUT connector to the MIDI IN connector of the Edirol MD-P1.

NOTE

To prevent malfunction or speaker damage, minimize the volume on all your equipment and turn off the power before you make connections.

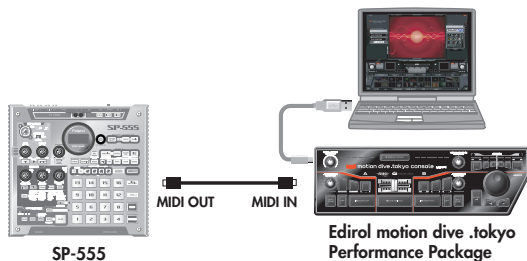

Turning V-LINK on/off

1. Press the SP-555's [V-LINK] button so it's lit; V-LINK will be on.

When [V-LINK] is lit, you can operate the SP-555 to control images in synchronization with the SP-555's performance.

2. To turn off V-LINK, press [V-LINK] once again so its light goes out.

Functions that you can control using CTRL 1–3 and D Beam

Display indication	Value	Response by motion dive .tokyo
oFF	Off	
1	ColorEQ Fore	✓
2	ColorEQ Back	✓
3	Scratch SW	✓
4	Speed Knob	✓
5	Total Fader	✓
6	Cross Fader	✓
7	BPM Sync SW	✓
8	Clip Loop SW	✓
9	Assign Knob	✓
10	Fade Time SW	✓
11	Visual Knob	✓
12	AB SW	✓
13	Tap SW	✓
14	Total Select	✓
15	FX Select	✓
16	Play Pos	✓
17	Loop Start Pos	✓
18	Loop End Pos	✓
19	Layer Mode Sel	✓
20	Playback Speed	
21	Dissolve Time	
22	T Bar	
23	Color Cb	
24	Color Cr	
25	Brightness	
26	VFX1	
27	VFX2	
28	VFX3	
29	VFX4	
30	Output Fade	

* For details on how to change these functions, refer to "V-LINK settings" (p. 53).

V-LINK settings

You can set or edit the following functions that are related to V-LINK. With the exception of the pad mode, make the setting and then press [SAMPLING] to save the setting.

Function	Value (display indication)	Operation	Remarks
Pad mode	Clip/Palette ("CLP", "PLT")	[V-LINK] + [EFFECT MEMORY]	Fixed at Clip at power-on.
V-LINK Ctrl Ach	1 – 16 ("C. 1"–"C.16")	[CANCEL] + [V-LINK] → Bank[A] → CTRL 3 knob (can also change using pad [1]–[16])	Specifies the MIDI channel that will control section A of motion dive .tokyo. The factory setting is channel 4.
V-LINK Ctrl Bch	1 – 16 ("C. 1"–"C.16")	[CANCEL] + [V-LINK] → Bank[B] → CTRL 3 knob (can also change using pad [1]–[16])	Specifies the MIDI channel that will control section B of motion dive .tokyo. The factory setting is channel 10.
V-LINK Ctrl Cch	1 – 16 ("C. 1"–"C.16")	[CANCEL] + [V-LINK] → Bank[C/G] → CTRL 3 knob (can also change using pad [1]–[16])	Specifies the MIDI channel that will control the MIDI Note plug-in of motion dive .tokyo. The factory setting is channel 9.
CTRL 1 Assign (*1)	Off, 1 – 30 ("oFF", " 1"–"30")	[CANCEL] + [V-LINK] → Sw below CTRL 1 → CTRL 3 knob	Assigns a V-LINK function to CTRL 1. The factory setting is 4 (Speed Knob).
CTRL 2 Assign (*1)	Off, 1 – 30 ("oFF", " 1"–"30")	[CANCEL] + [V-LINK] → Sw below CTRL 2 → CTRL 3 knob	Assigns a V-LINK function to CTRL 2. The factory setting is 2 (ColorEQ Back).
CTRL 3 Assign (*1)	Off, 1 – 30 ("oFF", " 1"–"30")	[CANCEL] + [V-LINK] → Sw below CTRL 3 → CTRL 3 knob	Assigns a V-LINK function to CTRL 3. The factory setting is 6 (Cross Fader).
D Beam Assign (*1)	Off, 1 – 30 ("oFF", " 1"–"30")	[CANCEL] + [V-LINK] → [SYNTH]/[FILTER]/[TRIGGER] → CTRL 3 knob	Assigns a V-LINK function to D Beam. The factory setting is 1 (ColorEQ Fore).
Seq Ach Ctrl Pad Bank	Off, Bank A – J ("off", "b. A"–"b. J")	[CANCEL] + [V-LINK] → Bank[D/H] → CTRL 3 knob	Of the pad information included in the pattern data, the information of the specified bank will be used to control section A of motion dive .tokyo. The factory setting is bank A.
Seq Bch Ctrl Pad Bank	Off, Bank A – J ("off", "b. A"–"b. J")	[CANCEL] + [V-LINK] → Bank[E/I] → CTRL 3 knob	Of the pad information included in the pattern data, the information of the specified bank will be used to control section B of motion dive .tokyo. The factory setting is bank B.
Seq Cch Ctrl Pad Bank	Off, Bank A – J ("off", "b. A"–"b. J")	[CANCEL] + [V-LINK] → Bank[F/J] → CTRL 3 knob	Of the pad information included in the pattern data, the information of the specified bank will be used to control the MIDI Note plug-in of motion dive .tokyo. The factory setting is bank C.
V-LINK Sw Mode	Standerd, MD-P1 ("Std", "Mdp")	[CANCEL] + [V-LINK] → [FIXED-LOCITY] → CTRL 3 knob	Specifies what will happen when V-LINK is turned on/off. With the "Standard" setting, only a V-LINK On/Off message will be transmitted. With the "MD-P1" setting, a Reset Ctrl Parameters message will be transmitted when V-LINK is turned on, and a message that sets Total Fader to 0 will be transmitted when V-LINK is turned off. The factory setting is MD-P1.

MEMO

Devices such as the Edirol PR-50/80 use only V-LINK Ctrl Ach.

*1 For details on the functions that can be controlled, refer to "Functions that you can control using CTRL 1–3 and D Beam" (p. 52).

Appendix

Effect list

Effects that you can select by directly pressing a button

Type	CTRL 1 function (display)	CTRL 2 function (display)	CTRL 3 function (display)
SUPER FILTER A filter with an extremely steep slope (sharp attenuation). (-36 dB/octave)	CUTOFF (CoF) Adjusts the cutoff frequency.	RESONANCE (rES) ☆ Adjusts the amount of peak at the cutoff frequency.	FILTER TYPE (LPF/HPF/bPF/nfF) Selects the type of filter. LPF: Passes the frequency region below the cutoff. HPF: Passes the frequency region above the cutoff. BPF: Passes the frequency region around the cutoff. NTF: Passes the frequency regions other than the region near the cutoff.
VOICE TRANS Processes a human voice to create a variety of characters.	FORMANT (FrM) Adjusts the character (formant) of the voice.	EFFECT LEVEL (EFF) Adjusts the volume of the effect sound.	DIRECT LEVEL (dir) Adjusts the volume of the direct sound.
DELAY Repeats the sound.	DELAY TIME (t32→t1) *1 Adjusts the interval of the repeats.	FEEDBACK (Fdb) ☆ Adjusts the number of the repeats.	BALANCE (bal) Adjusts the volume balance between the direct sound and effect sound.
ISOLATOR Isolates or removes the low, mid, or high frequency ranges.	LOW (Lo) ☆ Isolates/removes the low-frequency range.	MID (Mid) ☆ Isolates/removes the mid-frequency range.	HIGH (Hi) ☆ Isolates/removes the high-frequency range.
DJFX LOOPER Loops a short portion of the input sound. You can vary the playback direction and playback speed of the input sound to add turntable-type effects.	LENGTH (LEn) ☆ Specifies the length of the loop.	SPEED (-1.0-1.0) Specifies the playback direction and playback speed. Turning the knob to the left of 12 o'clock produces backward playback, and turning the knob to the right of 12 o'clock produces forward playback. At 12 o'clock, the playback is stopped.	LOOP SW (oFF/on) If you turn this on while sound is playing, the sound at that point will be looped. Turn this off to cancel the loop.

☆: The depth of these parameters will be limited if you turn on “**Effect Limit mode**” (p. 20).

*1: Delay time is specified as a note value relative to the tempo of the longest sample of the samples to which the effect is being applied.

Note values that you can specify:

32nd note (t32) / 16th note (t16) / 8th note triplet (t8t) / dotted 16th note (t16.) / 8th note (t8) / quarter note triplet (t4t) / dotted 8th note (t8.) / quarter note (t4) / half note triplet (t2t) / dotted quarter note (t4.) / half note (t2) / dotted half note (t2.) / whole note (t1)

However, you can't select a setting that would cause the delay time to exceed approximately 2000 milliseconds. If a pattern is playing, the tempo of the pattern is used as the reference.

MFX bank A

Number	Type	CTRL 1 function (display)	CTRL 2 function (display)	CTRL 3 function (display)
1	FLANGER	DEPTH (dPt)	RATE (rAt)	FEEDBACK (Fdb)☆
	Creates modulation reminiscent of a jet airplane taking off and landing.	Adjusts the depth of modulation.	Adjusts the speed of modulation.	Adjusts the proportion of effect sound that is returned to the input.
2	PHASER	DEPTH (dPt)☆	RATE (rAt)	MANUAL (MAn)
	Creates modulation by adding a phase-shifted sound.	Adjusts the depth of modulation.	Adjusts the speed of modulation.	Adjusts the pitch of the effect sound.
3	WAH	PEAK (PEk)	RATE (rAt)	MANUAL (MAn)
	Produces a wah effect.	Adjusts the width of frequencies to which effect is applied.	Adjust the speed of modulation.	Adjusts the pitch of the effect sound.
4	TREMOLO/PAN	DEPTH (dPt)	RATE (rAt)	WAVEFORM (trM/PAn)
	Cyclically varies the volume or panning.	Adjusts the amount of change in volume/panning.	Adjusts the speed of volume/panning change.	Specifies the volume/panning modulation curve. Turn knob to left to vary the volume, or to the right to vary the panning.
5	REVERB	REVERB TIME (tiM)	REVERB TYPE (rM1-HL2)	3 BALANCE (bAL)
	Adds reverberation to the sound.	Adjusts the reverb time.	Selects the type of reverb. ROOM 1 (rM1): Short, high-density reverberation. ROOM2 (rM2): Short, low-density reverberation. STAGE1 (St1): More late reverberation. STAGE2 (St2): More early reflections. HALL1 (HL1): Clear reverberation. HALL2 (HL2): Rich reverberation.	Adjusts the volume balance between the direct sound and effect sound.
6	TAPE ECHO	RATE (rAt)	INTENSITY (int)☆	BALANCE (bAL)
	Simulates a tape-type echo unit of the past.	Specifies the tape speed.	Specifies the amount of echo repeat.	Adjusts the volume balance between the direct sound and effect sound.
7	CHORUS	DEPTH (dPt)	RATE (rAt)	BALANCE (bAL)
	Adds spaciousness and richness to the sound.	Adjusts the depth of modulation.	Adjusts the rate of modulation.	Adjusts the volume balance between the direct sound and effect sound.
8	FILTER+DRIVE	CUTOFF (CoF)	RESONANCE (rES)☆	DRIVE (drV)☆
	A low-pass filter with overdrive. It cuts the high frequencies and adds distortion.	Adjusts the frequency that will be cut.	Adjusts peak frequency response at the cutoff frequency.	Adds distortion.
9	DISTORTION	DRIVE (drV)☆	TONE (ton)☆	LEVEL (LEV)☆
	Intensely distorts the sound.	Adjusts the degree of distortion.	Adjusts the tone.	Adjusts the volume.
10	OVERDRIVE	DRIVE (drV)☆	TONE (ton)☆	LEVEL (LEV)☆
	Mildly distorts the sound.	Adjusts the degree of distortion.	Adjusts the tone.	Adjusts the volume.
11	FUZZ	DRIVE (drV)☆	TONE (ton)☆	LEVEL (LEV)☆
	Adds overtones and intensely distorts the sound.	Adjusts the degree of distortion.	Adjusts the tone.	Adjusts the volume.
12	OCTAVE	-2OCT LEVEL (oC2)	-1OCT LEVEL (oC1)	DIRECT LEVEL (dir)
	Adds a pitch at lower octaves.	Adds a pitch two octaves below.	Adds a pitch one octave below.	Adjusts the volume of the direct sound.

Appendix

Number	Type	CTRL 1 function (display)	CTRL 2 function (display)	CTRL 3 function (display)
13	SLICER+FLG	TIMING PTN (P01–P16) (*1)	RATE (t32–t1) (*2)	FEEDBACK (Fdb)☆
	Repeatedly cuts the sound. A flanger is added.	The timing at which the sound is cut.	Adjusts the length of TIMING PTN.	Adjusts the flanger depth.
14	RING MOD	FREQUENCY (Frg)☆	SENS (SEn)☆	BALANCE (bal)
	Gives the sound a metallic character.	Adjusts the pitch of the metallic sound.	Adjusts the depth to which the frequency is modulated.	Adjusts the volume balance between the direct sound and effect sound.
15	PITCH	PITCH (Pit)	FEEDBACK (Fdb)☆	BALANCE (bal)
	Changes the pitch.	Adjusts the amount of pitch change.	Adjusts the amount of pitch-shifted sound that is fed back.	Adjusts the volume balance between the direct sound and effect sound.
16	CHROMATIC PS	PITCH1 (- C– CC)	PITCH2 (- C– CC)	BALANCE (bal)
	A two-voice pitch shifter that changes the pitch in semitone steps.	Changes pitch 1 in semitone steps over a +/-1 octave range.	Changes pitch 2 in semitone steps over a +/-1 octave range.	Adjusts the volume balance between the direct sound and effect sound.

☆: The depth of these parameters will be limited if you turn on “**Effect Limit mode**” (p. 20).

* For FLANGER and PHASER, you can use [MFX] + CTRL 1 knob to adjust the volume balance between the direct sound and effect sound.

*1: You can select the following patterns by turning the CTRL knob.

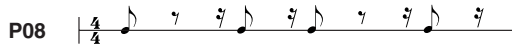
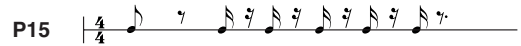
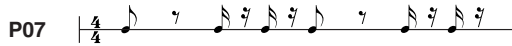
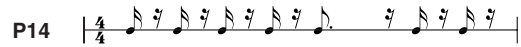
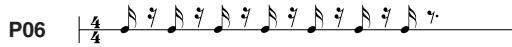
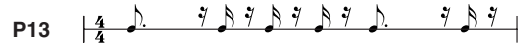
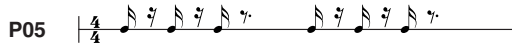
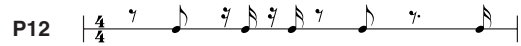
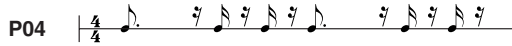
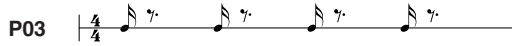
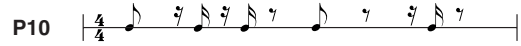
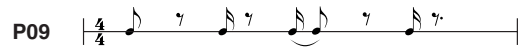
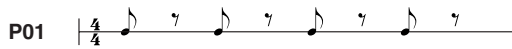

The TIMING PTN interval will synchronize to the tempo of the longest sample of the samples to which the effect is being applied. However, if a pattern is playing, the interval will synchronize to the tempo of the pattern.

You can use RATE to adjust the synchronization speed as follows.

RATE maximum (turn the CTRL 2 knob all the way to the right): One cycle of TIMING PTN corresponds to one measure.

RATE minimum (turn the CTRL 2 knob all the way to the left): One cycle of TIMING PTN corresponds to a 32nd note.

By turning the CTRL 2 knob you can change this to any value from a 32nd note up to one measure.

*2: RATE is specified as a note value relative to the tempo of the longest sample of the samples to which the effect is being applied.

Note values that you can specify:

32nd note (t32) / 16th note (t16) / 8th note triplet (t8t) / dotted 16th note (t16.) / 8th note (t8) / quarter note triplet (t4t) / dotted 8th note (t8.) / quarter note (t4) / half note triplet (t2t) / dotted quarter note (t4.) / half note (t2) / dotted half note (t2.) / whole note (t1)

If a pattern is playing, the tempo of the pattern is used as the reference. If a pattern is playing, or if “**Effect tempo mode**” (p. 20) is set to synchronize to the tempo of the pattern sequencer, the tempo of the pattern is used as the reference.

MFX bank B

Number	Type	CTRL 1 function (display)	CTRL 2 function (display)	CTRL 3 function (display)
1	COMP	SUSTAIN (SUS)	ATTACK (Atk/rEL)☆	LEVEL (LEV)☆
	Makes the sound more consistent.	Adjusts the depth of the compressor.	Adjusts the attack. If Limit mode is on (rEL), this adjusts the release.	Adjusts the volume.
2	EQUALIZER	LOW (Lo)☆	MID (Mid)☆	HIGH (Hi)☆
	Adjusts the volume of each frequency region.	Adjusts the low-frequency volume.	Adjusts the mid-frequency volume.	Adjusts the high-frequency volume.
3	C.CANCELER	LR BALANCE (L-r)	LOW BOOST (Lo)	HIGH BOOST (Hi)
	Cancels the vocal or other sound located in the center.	Adjusts the point at which maximum cancellation occurs.	Boosts the low-frequency sounds located in the center, such as the bass.	Boosts the high-frequency sounds.
4	SUBSONIC	PITCH (Pit)	THRESHOLD (tHr)	BALANCE (bAL)
	Adds a low-frequency sine wave based on the volume being input to the effect (*2).	Adjusts the frequency of the sine wave.	Adjusts the volume at which the sine wave will begin sounding.	Adjusts the volume balance between the direct sound and effect sound.
5	LO-FI COMP	LO-FI TYPE (tyP)	PRE FILTER TYPE (FLt)☆	BALANCE (bAL)
	Degrades the audio quality. A compressor is also provided.	Adjusts the audio degradation.	Selects the type of filter located before the input to the Lo-Fi effect.	Adjusts the volume balance between the direct sound and effect sound.
6	NOISE GEN	WHITE NOISE (WHt)	DISC NOISE (diS)	HUM NOISE (HUM)
	Applies a lo-fi effect, and also adds noises such as white noise and record noise.	Adjusts the volume of the "hiss" noise.	Adjusts the volume of the "pop" noise.	Adjusts the volume of the "hum" noise.
7	RADIO TUNING	DETUNE (tUn)	NOISE LEVEL (noS)	BALANCE (bAL)
	Simulates sound heard from a radio.	Adjusts the tuning drift of the radio.	Adjusts the volume of noise.	Adjusts the volume balance between the direct sound and effect sound.
8	VINYL SIM	FREQUENCY RANGE (rnG)	NOISE LEVEL (noS)	WOW/FLUTTER (FLU)
	Simulates sound heard from an analog record.	Adjusts the frequency response of the playback system.	Adjusts the volume of noise.	Adjusts the rotational instability of the analog record.
9	DIST+PAN	DRIVE (drV)	TONE (ton)	PAN (PAn)
	Monaural distortion, with adjustable panning.	Adjusts the degree of distortion.	Adjusts the panning.	Adjusts the panning.
10	OD+PAN	DRIVE (drV)	TONE (ton)	PAN (PAn)
	Monaural overdrive, with adjustable panning.	Adjusts the degree of distortion.	Adjusts the tonal character.	Adjusts the panning.
11	AMP SIM	AMP TYPE (JC -FUZ)	VOLUME (VoL)	SPEAKER TYPE (SL1-3St)
	Simulates a guitar amp.	Selects the type of amp (*3).	Adjusts the amp volume and degree of distortion.	Selects the type of speaker (*4).
12	BIT CRASH	SAMPLE RATE (rAt)	BIT (bit)☆	FILTER (FLt)
	Produces an extreme lo-fi effect.	Adjusts the sample rate.	Adjusts the bit depth.	Adjusts the filter depth.
13	STEP FILTER	STEP PTN (P01-P16)	RATE (t32-t1)*1	RESONANCE (rES)☆
	A filter that varies the cutoff frequency in a stepwise manner.	Selects the pattern in which the cutoff frequency will change.*6	Adjusts the length of the STEP PTN.	Adjusts peak frequency response at the cutoff frequency.
14	STEP RING MOD	STEP PTN (P01-P16)☆	RATE (t32-t1)*1	BALANCE (bAL)
	A ring modulator that varies the modulated frequency in a stepwise manner.	Selects the pattern in which the modulated frequency will change.*6	Adjusts the length of the STEP PTN.	Adjusts the volume balance between the direct sound and effect sound.

Appendix

Number	Type	CTRL 1 function (display)	CTRL 2 function (display)	CTRL 3 function (display)
15	BPM LOOPER	LENGTH (LEn)☆	TIMING (oFF, 1–8)	LOOP SW (oFF/on)
	Loops the input sound over a short period.	Adjusts the length of the loop.	Specifies the timing at which the looped sound will automatically start sounding (in 8th note intervals) (*5). Set this to “oFF” if you don’t want the loop to play automatically.	If you turn this on while the sound is heard, the sound at that point will be looped. Turn this off to defeat looping.
16	REVERSE	DELAY TIME (t32–t1)*1	FEEDBACK (Fdb)☆	BALANCE (bAL)
	Adds a delayed and reversed version of the input sound.	Adjusts the length of time that the reversed sound will be repeated.	Adjusts the number of times that the reversed sound will be repeated.	Adjusts the volume balance between the direct sound and effect sound.

☆ : The depth of these parameters will be limited if you turn on “**Effect Limit mode**” (p. 20).

*1: RATE is specified as a note value relative to the tempo of the longest sample of the samples to which the effect is being applied.

Note values that you can specify:

32nd note (t32) / 16th note (t16) / 8th note triplet (t8t) / dotted 16th note (t16.) / 8th note (t8) / quarter note triplet (t4t) / dotted 8th note (t8.) / quarter note (t4) / half note triplet (t2t) / dotted quarter note (t4.) / half note (t2) / dotted half note (t2.) / whole note (t1)
If a pattern is playing, the tempo of the pattern is used as the reference. If a pattern is playing or if “**Effect tempo mode**” (p. 20) has been set to synchronize to the tempo of the pattern sequencer, the tempo of the pattern is also used as the reference.

*2: Turn the CTRL 3 balance toward 12 o’clock, turn the CTRL 1 pitch all the way to the right, and use CTRL 2 to adjust the threshold so that the sine wave is sounded appropriately according to the input source. When you’ve finished setting the threshold, adjust the pitch and balance. This is a convenient way to supplement the kick drum.

*3: JC-120(JC)/ CLEAN TWIN(CLn)/ MATCH DRIVE(Mdr)/ BG LEAD(bG)/ MS1959(I MS1)/ MS1959II(MS2)/ MS1959I+II(MS3)/ SLDN LEAD(Sld)/ METAL 5150(Mt1)/ METAL LEAD(Mt2)/ OD-1(od1)/ OD2 TURBO(od2)/ DISTORTION(dSt)/ FUZZ(FUZ)

*4: SMALL1(SL1)/ SMALL2(SL2)/ MIDDLE(MID)/ JC-120(JC)/ BUILT IN1(bl1)/ BUILT IN2(bl2)/ BUILT IN3(bl3)/ BUILT IN4(bl4)/ BUILT IN5(bl5)/ BG STACK1(bG1)/ BG STACK2(bG2)/ MS STACK1(MS1)/ MS STACK2(MS2)/ METAL STACK(MtL)/ 2STACK(2St)/ 3STACK(3St)

*5: The TIMING cycle will synchronize to the tempo of the longest sample to which the effect is being applied. However, if a pattern is playing, it will synchronize to the tempo of the pattern.

*6: The pattern cycle will synchronize to the tempo of the longest sample to which the effect is being applied. However, if a pattern is playing, it will synchronize to the tempo of the pattern.

You can use RATE to adjust the synchronization speed as follows.

RATE maximum (turn the CTRL 2 knob all the way to the right): One cycle of TIMING PTN corresponds to one measure.

RATE minimum (turn the CTRL 2 knob all the way to the left): One cycle of TIMING PTN corresponds to a 32nd note.

By turning the CTRL 2 knob you can change this to any value from a 32nd note up to one measure.

Quick reference of operations

Sampling operations

To accomplish this	Do this
Play a sample	Pad [1]–[16]
Play the external input sound	[MIC] / [LINE IN]
Set the volume of the external input	MIC LEVEL knob / LINE IN LEVEL knob
Record a sample	[SAMPLING] → Pad [1]–[16] → [SAMPLING] (press [SAMPLING] to stop sampling)
Make auto sampling settings	[CANCEL] + [SAMPLING] → CTRL3 knob → [SAMPLING]
Cancel auto sampling	[CANCEL] + [SAMPLING] → set CTRL3 knob to Min → [SAMPLING]
Set the BPM for sampling	In sampling standby mode, [TIME/BPM] → CTRL2 knob → [TIME/BPM] → Sampling standby
Sample with a count-in	In sampling standby mode [START/END/LEVEL] → [SAMPLING]
Resampling	[RESAMPLE] → CTRL3 knob → [SAMPLING] → Pad [1]–[16] → [SAMPLING] → Pad [1]–[16] (press [SAMPLING] to stop resampling)
Set the volume of a sample	Pad [1]–[16] → [START/END/LEVEL] → CTRL3 knob (press [START/END/LEVEL] to end the setting)
Set the start/end points	Pad [1]–[16] → [MARK] → [MARK]
Set only the start point	Pad [1]–[16] → [MARK] → Pad [1]–[16] (same pad as initial one)
Set only the end point	[MARK] + Pad [1]–[16] → [MARK]
Adjust the start/end point	Pad [1]–[16] → [START/END/LEVEL] → CTRL1 knob (Start) / CTRL2 knob (End)
Cancel the specified start/end points	(with [MARK] lit) Pad [1]–[16] → (during playback) [MARK]
Truncate	Pad [1]–[16] → [DEL] → [MARK] → [DEL]
Specify a sample's BPM	Pad [1]–[16] → [TIME/BPM] → CTRL2 knob ([TIME/BPM] ends the setting)
Time Modify setting	Pad [1]–[16] → [TIME/BPM] → CTRL1 knob ([TIME/BPM] ends the setting)
Exchange samples between pads	[DEL] + [SAMPLING] → Specify the exchange-source pad → Specify the exchange-destination pad → [SAMPLING]
Copy samples between pads	[DEL] + [RESAMPLE] → specify the copy-source pad → specify the copy-destination pad → [SAMPLING]
Delete an individual sample	[DEL] → Pad [1]–[16] → [DEL]
Delete all samples	[CANCEL] + [DEL] → Bank [A]–[B] (internal)/[C/G]–[F/J] (card) → [DEL]
View remaining sampling time	[REMAIN]
View current pad	[REMAIN]
Stop all sounding samples	Rapidly press [CANCEL] four times

Effect operations

To accomplish this	Do this
Select MFX type (1)	[MFX] + CTRL3 knob
Select MFX type (2)	While holding down [MFX], Bank [A]/[B] → Pad [1]–[16]
Effect grab	[EFFECT ASSIGN] + effect button
Specify effect send for a sample	[EFFECT ASSIGN] + Pad [1]–[16]
Effect send for Mic or Line In	[EFFECT ASSIGN] + [MIC]/[LINE IN]

Appendix

To accomplish this	Do this
Specify effect send for USB	[EFFECT ASSIGN] + [CANCEL] + [MIC]/[LINE IN]
Specify effect send for D Beam Synth	[EFFECT ASSIGN] + [SYNTH]
Effect send for current bank	[EFFECT ASSIGN] + Pad [1] + [16]/ Pad [4] + [13]
Effect send for all samples	[EFFECT ASSIGN] + [SUB PAD]
Effect assign mode	[EFFECT ASSIGN] + [REMAIN]
Check the previous effect	[EFFECT ASSIGN]
Set the parameters of the effect to use next	[REMAIN] + CTRL1 knob / CTRL2 knob / CTRL3 knob
Effect limit mode	[CANCEL] + [MFX]
Effect knob control	[CANCEL] + [SUPER FILTER]
Reset an effect's tempo synchronization to the tempo of the synthesizer	[EFFECT ASSIGN] + [TAP TEMPO]
Effect tempo mode	[EFFECT ASSIGN] + [PATTERN SELECT]
Call up an Effect Memory	[EFFECT MEMORY] → Pad [1]–[16]
Store an Effect Memory	[EFFECT MEMORY] → [SAMPLING] → Pad [1]–[16] → [SAMPLING]
Check the content of an Effect Memory	[EFFECT MEMORY] → [REMAIN] + Pad [1]–[16]

Loop Capture operations

To accomplish this	Do this
Record Loop Capture	[REC] ([REC] to stop recording, and [PLAY] to move to playback)
Play back Loop Capture	(with a loop recorded) [PLAY] ([PLAY] to stop)
Overdub Loop Capture	(with a loop recorded) [REC] ([REC] to play back, [PLAY] to stop)
Specify the Loop Capture volume	[PLAY] → [START/END/LEVEL] → CTRL3 knob ([START/END/LEVEL] to end settings)
Delete a Loop Capture recording (1)	[DEL] → [PLAY] → [DEL]
Delete a Loop Capture recording (2)	[EFFECT ASSIGN] + [REC]
Sample a Loop Capture to a pad	[SAVE TO PAD] → Pad [1]–[16] → [SAVE TO PAD]

Pattern operations

To accomplish this	Do this
Play a pattern	[PATTERN SELECT] → Pad [1]–[16]
During playback, select the pattern to play next	During pattern playback Pad [1]–[16]
During playback, switch the pattern immediately	During pattern playback [SUB PAD] + Pad [1]–[16]
Stop the pattern (1)	[CANCEL]
Stop the pattern (2)	[PATTERN SELECT] → Pad [1]–[16] (the pad of the currently playing pattern)
Sequencer tempo setting (1)	[PATTERN SELECT] → [TIME/BPM] → CTRL2 knob ([TIME/BPM] ends the setting)
Sequencer tempo setting (2)	[TAP TEMPO] + CTRL2 knob
Sequencer tempo setting (tap tempo)	Press [TAP TEMPO] four or more times (display will temporarily show the pattern tempo)
Sequencer tempo setting (copy tempo from pad)	[TAP TEMPO] + Pad [1]–[16] (BPM of that pad's sample is assigned)
Record a pattern	[PATTERN SELECT] → [SAMPLING] → Pad [1]–[16] → [SAMPLING] ([CANCEL] to stop recording)
Quantize setting	During pattern recording standby / during recording [QUANTIZE] → CTRL3 knob ([QUANTIZE] ends the setting)
Specify the length of the pattern	During pattern recording standby [LENGTH] → CTRL3 knob ([LENGTH] ends the setting)
Metronome on/off	[METRONOME]
Specify metronome volume	[METRONOME] + CTRL3 knob

To accomplish this	Do this
Rehearse pattern recording	While recording a pattern [SAMPLING]
Delete playback data	While recording a pattern [DEL] → Pad [1]–[16]/[HOLD] (delete performances of all pads)
Exchange patterns between pads	[PATTERN SELECT] → [DEL] + [SAMPLING] → specify exchange-source pad → specify exchange-destination pad → [SAMPLING]
Copy patterns between pads	[PATTERN SELECT] → [DEL] + [RESAMPLE] → specify copy-source pad → specify copy-destination pad → [SAMPLING]
Delete an individual pattern	[PATTERN SELECT] → [DEL] → Pad [1]–[16] → [DEL]
Delete all patterns	[PATTERN SELECT] → [CANCEL] + [DEL] → Bank [A]–[B] (internal) / [C/G]–[F/J] (card) → [DEL]
Play/stop patterns in sync with external sequencer (when MIDI synchronization mode is Auto Sync)	[PATTERN SELECT] → [HOLD] + Pad [1]–[16] → (start/stop the external sequencer)

D-Beam controller operations

To accomplish this	Do this
D Beam Synth settings	[SYNTH] + Pad [1]–[8] (select a sound) [SYNTH] + Pad [9]–[16] (select the Delay) [SYNTH] + CTRL1 knob (specify the Key Shift) [SYNTH] + CTRL2 knob (specify the Scale) [SYNTH] + CTRL3 knob (specify the Level)
D Beam Filter settings	[FILTER] + Pad [1]/[5]/[7]/[13] (LPF) [FILTER] + Pad [2]/[6]/[10]/[14] (HPF) [FILTER] + Pad [3]/[7]/[11]/[15] (BPF) [FILTER] + Pad [4] (NOTCH)
D Beam Trigger settings	[TRIGGER] + Pad [1]–[16] (select a pad) [TRIGGER] + CTRL3 knob (specify the Velocity)
D Beam Sens setting	[CANCEL] + [SYNTH]/[FILTER]/[TRIGGER] → CTRL3 knob → [SAMPLING]

System settings

To accomplish this	Do this
Specify the blinking speed of the display illumination	[TAP TEMPO] + Power On → CTRL3 knob → [SAMPLING]
Specify the MIDI channel	[PATTERN SELECT] + Power On → Bank [A] → CTRL3 knob → [SAMPLING]
MIDI Thru setting	[PATTERN SELECT] + Power On → Bank [B] → CTRL3 knob → [SAMPLING]
MIDI synchronization mode setting	[TIME/BPM] + Power On → Bank [A] → CTRL3 knob → [SAMPLING]
MIDI synchronization source setting	[TIME/BPM] + Power On → Bank [B] → CTRL3 knob → [SAMPLING]
Tx MIDI Sync setting	[TIME/BPM] + Power On → Bank [C] → CTRL3 knob → [SAMPLING]
Initialize internal memory	[CANCEL] + [DEL] + [REMAIN] + Power On → [SAMPLING]
Disable protect	[CANCEL] + Power On
Bank A–J protect	[REMAIN] + Power On
Bank A protect	[REMAIN] + Bank [A] + Power On
Check the version number	[MARK] + Power On
Set the internal processing level	[CANCEL] + [START/END/LEVEL] + CTRL3 knob
Roll Resolution setting	[ROLL] + CTRL3 knob
Pad Velocity setting	[FIXED VELOCITY] + CTRL3 knob
Pad Sens setting	[CANCEL] + [FIXED VELOCITY] → CTRL3 knob → [SAMPLING]
Pedal Assign setting	[CANCEL] + Pedal → CTRL3 knob → [SAMPLING] (for details on each setting, refer to “About the pedal” (p. 68))

CompactFlash card operations

To accomplish this	Do this
Format a CompactFlash card	[CANCEL] + [REMAIN] → Bank [C/G]–[F/J] → [DEL]
Import an audio file	[CANCEL] + [RESAMPLE] → [SAMPLING] → Pad [1]–[16] → [SAMPLING]
Export an audio file	[CANCEL] + [RESAMPLE] → [RESAMPLE] → Pad [1]–[16] → [SAMPLING]
Settings for exported audio files	[RESAMPLE] + Power On → CTRL3 knob → [SAMPLING]
Backup save	[CANCEL] + Bank [C/G]–[F/J] → Pad [1]–[16] (specify the area) → [SAMPLING]
Backup load	[CANCEL] + Bank [A]–[B] → Pad [1]–[16] (specify the area) → [SAMPLING]
Backup delete	[DEL] + Bank [C/G]–[F/J] → Pad [1]–[16] (specify the area) → [DEL]

USB MIDI/audio interface operations

To accomplish this	Do this
USB Audio Input Sw setting	Hold down [CANCEL], and [MIC] → CTRL3 knob
USB Audio Output Source setting	Hold down [CANCEL], and [LINE IN] → CTRL3 knob

V-LINK operations

To accomplish this	Do this
Turn V-LINK On/Off	[V-LINK]
Switch clips or palettes	Pad [1]–[16]
Switch the pad mode (Clip/Palette)	[V-LINK] + [EFFECT MEMORY]
Switch between V-LINK Ctrl Ach/Bch/Cch	[V-LINK] + Bank [A]–[C/G]
Reset the image	[V-LINK] + [FIXED VELOCITY]
V-LINK settings	[CANCEL] + [V-LINK] (→for details on settings, refer to “ About V-LINK ” (p. 52))







Parameters that can change the start-up state

Parameter	Range (display indication)	Panel operation	Remarks
Fixed Velocity	16–127 ("16"–"127")	[FIXED VELOCITY] + CTRL 3 knob	Specifies the velocity value when FIXED VELOCITY (p. 16) is on. After making the setting, press [FIXED VELOCITY] + [SAMPLING] to save it.
Pad Sens	Light, Medium, Heavy ("L", "M", "H")	[CANCEL] + [FIXED VELOCITY] → CTRL 3 knob	Specifies the pad sensitivity (p. 16). After making the setting, press [SAMPLING] to save it.
Roll Resolution	quarter note, quarter note triplet, 8th note, eighth note triplet, 16th note, 16th note triplet, 32nd note, 32nd note triplet ("4", "4.3", "8", "8.3", "16", "16.3", "32", "32.3")	[ROLL] + CTRL 3 knob	Specifies the roll speed when ROLL (p. 16) is on. After making the setting, press [ROLL] + [SAMPLING] to save it.
Effect Tempo Mode	Standard, Sequencer ("Std", "SEq")	[CANCEL] + [TAP TEMPO] → CTRL 3 knob	Specifies whether the tempo of the effect will follow the pad or pattern sequencer (Standard) or will always follow the pattern sequencer (Sequencer) (p. 20). After making the setting, press [SAMPLING] to save it.
Effect Assign Mode	Auto, Manual ("AUt", "MAn")	[CANCEL] + [EFFECT ASSIGN] → CTRL 3 knob	Specifies whether a pad's EFFECT ASSIGN will automatically switch to follow the current pad (Auto), or is changed only by [EFFECT ASSIGN] + Pad (Manual). After making the setting, press [SAMPLING] to save it.
MIDI ch	1–15 ("C. 1"–"C.15")	[PATTERN SELECT] + Power On → Bank [A] → CTRL 3 knob	Specifies the MIDI transmit/receive channel (p. 71). After making the setting, press [SAMPLING] to save it.
MIDI Through	Off/On ("oFF"/"on")	[PATTERN SELECT] + Power On → Bank [B] → CTRL 3 knob	After making the setting, press [SAMPLING] to save it.
Sync Mode	Auto Sync, Tempo Sync, Off ("AUt", "tmP", "oFF")	[TIME/BPM] + Power On → Bank [A] → CTRL 3 knob	Specifies the MIDI synchronization mode (p. 69). After making the setting, press [SAMPLING] to save it.
Sync Source	MIDI, USB ("Mid", "USB")	[TIME/BPM] + Power On → Bank [B] → CTRL 3 knob	Specifies whether the SP-555 will synchronize to the MIDI clock from the MIDI connector (MIDI), or the MIDI clock from USB MIDI (USB). After making the setting, press [SAMPLING] to save it.
Tx MIDI Sync	Off/On ("oFF", "on")	[TIME/BPM] + Power On → Bank [C] → CTRL 3 knob	Turns MIDI clock transmission on/off. After making the setting, press [SAMPLING] to save it.
D Beam Sens	0–127 ("0"–"127")	[CANCEL] + [SYNTH]/[FILETR]/ [TRIGGER] → CTRL 3 knob	Adjusts the sensitivity of the D Beam controller. After making the setting, press [SAMPLING] to save it.
V-LINK Ctrl Ach	1–16 ("C. 1"–"C.16")	[CANCEL] + [V-LINK] → Bank [A] → CTRL 3 knob	This can also be changed by Pad [1]–[16]. After making the setting, press [SAMPLING] to save it.
V-LINK Ctrl Bch	1–16 ("C. 1"–"C.16")	[CANCEL] + [V-LINK] → Bank [B] → CTRL 3 knob	This can also be changed by Pad [1]–[16]. After making the setting, press [SAMPLING] to save it.
V-LINK Ctrl Cch	1–16 ("C. 1"–"C.16")	[CANCEL] + [V-LINK] → Bank [C/G] → CTRL 3 knob	This can also be changed by Pad [1]–[16]. After making the setting, press [SAMPLING] to save it.
V-LINK Sw Mode	Standard, MD-P1 ("Std", "MdP")	[CANCEL] + [V-LINK] → [FIXED VELOCITY] → CTRL 3 knob	Specifies what will happen when V-LINK is switched on/off. With the Standard setting, only the V-LINK On/Off message is sent. Set this to MD-P1 when using the "MD-P1." After making the setting, press [SAMPLING] to save it.
CTRL 1 Assign	Off, 1–30 ("oFF", "1"–"30")	[CANCEL] + [V-LINK] → Sw below CTRL 1 → CTRL 3 knob	After making the setting, press [SAMPLING] to save it.
CTRL 2 Assign	Off, 1–30 ("oFF", "1"–"30")	[CANCEL] + [V-LINK] → Sw below CTRL 2 → CTRL 3 knob	After making the setting, press [SAMPLING] to save it.
CTRL 3 Assign	Off, 1–30 ("oFF", "1"–"30")	[CANCEL] + [V-LINK] → Sw below CTRL 3 → CTRL 3 knob	After making the setting, press [SAMPLING] to save it.

Appendix

Parameter	Range (display indication)	Panel operation	Remarks
D Beam Assign	Off, 1–30 ("off", " 1"–" 30")	[CANCEL] + [V-LINK] → [SYNTH]/[FILTER]/[TRIGGER] → CTRL 3 knob	After making the setting, press [SAMPLING] to save it.
Seq Ach Ctrl Pad Bank	Off, Bank A–J ("off", "b. A"–"b. J")	[CANCEL] + [V-LINK] → Bank [D/H] → CTRL 3 knob	After making the setting, press [SAMPLING] to save it.
Seq Bch Ctrl Pad Bank	Off, Bank A–J ("off", "b. A"–"b. J")	[CANCEL] + [V-LINK] → Bank [E/I] → CTRL 3 knob	After making the setting, press [SAMPLING] to save it.
Seq Cch Ctrl Pad Bank	Off, Bank A–J ("off", "b. A"–"b. J")	[CANCEL] + [V-LINK] → Bank [F/J] → CTRL 3 knob	After making the setting, press [SAMPLING] to save it.
Blinking speed of the display illumination	Off, 1–9, Pattern ("off", " 1"–" 9", "Ptn")	[TAP TEMPO] + Power On → CTRL 3 knob	After making the setting, press [SAMPLING] to save it.
Sample Export Type	WAV, AIFF ("WAV", "AIFF")	[RESAMPLING] + Power On → CTRL 3 knob	Select the format for sample export. After making the setting, press [SAMPLING] to save it.
Pedal Assign	Loop Capture Play/Overdub, Loop Capture Play/Stop, Seq Start/Stop, Fixed Velocity, Effect On/Off ("LC.1", "LC.2", "Seq", "VEL", "EF.S")	[CANCEL] + press the pedal → CTRL 3 knob	After making the setting, press [SAMPLING] to save it. For details on each setting, refer to "About the pedal" (p. 68).

Error message list

Message	Explanation
EJC(Eject) 	Processing is not possible because the memory card was removed. * Don't remove the card while the power is on.
EMP(Empty) 	There is no sample, pattern, or backup data to delete. There is no backup data to load. There is no WAV or AIFF to import. There is no data to export as WAV or AIFF.
Err(Error) 	Invalid data was found in internal memory, and it was repaired or deleted.
FUL(Memory Full) 	Processing could not be performed because of insufficient memory.
Prt(Protected) 	Processing could not be performed because Protect is enabled.
UnS(Unsupported format) 	Processing was halted because the WAV or AIFF was in a format not supported by the SP-555.

Troubleshooting

This section lists some items to check and actions to take if you experience problems. Refer to the section appropriate for your situation.

No sound / Insufficient volume

Has the power to the SP-555 and your connected equipment been turned on?

Are the SP-555 and your external equipment connected correctly?

Check the connections.

Could an audio cable be broken?

Could you be using an audio cable that contains a built-in resistor?

Use a connection cable that does not contain a built-in resistor (such as one from the Roland PCS series).

Could the volume of the connected amp or mixer be turned down?

Adjust the volume to an appropriate level.

Could the SP-555's volume be lowered?

Adjust the volume to an appropriate level.

Check whether you hear sound in your headphones.

If you hear sound in your headphones, the connection cable may be broken, or there may be a problem with the connected amp or mixer. Check the connections and the connected equipment.

If you're using a CompactFlash card, is the card inserted correctly?

Check the CompactFlash card.

If you're attempting to play a sample, is its pad lit?

The sample will play when you press a lit pad. No sample is assigned to a pad that is unlit.

Could the sample level be lowered?

Adjust the level of the sample. (p. 28)

Could the effect level be lowered?

For some effect types, the level can be adjusted by a control knob. For details on effect types and the control knob assignments, refer to "Effect list" (p. 54).

No sound or insufficient volume from equipment connected to LINE IN

Is [LINE IN] lit?

To play sounds from the line input, press [LINE IN] so it's lit.

Could the external input level be lowered?

Turn the LINE IN LEVEL knob to adjust the level appropriately. (p. 22)

Could the volume of the device connected to LINE IN be lowered?

Adjust the level appropriately.

Is the audio cable connected correctly?

Check the connection.

Could the audio cable be broken?

Could you be using an audio cable that contains a built-in resistor?

Use a connection cable that does not contain a built-in resistor (such as the Roland PCS series).

No sound or insufficient volume from a mic

Is [MIC] lit?

To play sound from the mic input, press [MIC] to make the pad light.

Could the external input level be lowered?

Turn the MIC knob to adjust the level appropriately.

Is the mic cable connected correctly?

Check the connections.

Could the mic cable be broken?

The mic picks up noise

The MIC volume can't be turned down to zero

If you're not using the mic, turn [MIC] off.

Can't sample

Could there be insufficient memory?

If there is insufficient memory, the display will indicate "FUL" (Memory Full) when you attempt to sample. Delete unneeded samples to increase the amount of free memory. (p. 23)

Is the CompactFlash card inserted correctly?

If you're sampling to sample banks C–J, make sure that the CompactFlash card is inserted correctly. (p. 45)

Is the CompactFlash card formatted correctly?

Format the CompactFlash card using the SP-555. (p. 45)

Are samples assigned to all pads?

You can't sample if there are no vacant pads. Delete unwanted samples to free up some pads. (p. 23)

Could [PATTERN SELECT] be lit?

If [PATTERN SELECT] is lit, you're recording patterns, and will not be able to sample. Press [PATTERN SELECT] so its light is turned off.

Could [DEL] be lit or blinking?

If [DEL] is lit or blinking, you are deleting samples, and will not be able to sample.

Excessive noise or distortion in the sampled sound

Is the input level appropriate?

The sampled sound will be distorted if the input level is too high, and if the level is too low there will be excessive noise. Adjust the level so that the PEAK indicator lights occasionally.

Are the effect settings appropriate?

Some types of effect will make the level higher than the original sample, or may distort the sound itself. Some effects also emphasize the noise. Try turning the effect off, and check whether the noise or distortion is present in the original sample itself. Then adjust the effect settings appropriately.

Could you be playing more than one sample simultaneously?

Even if the level of each sample is appropriate, playing multiple samples simultaneously will raise the overall level excessively, possibly causing distortion. Lower the level of each sample to avoid distortion.

Sound is distorted when you save a Loop Capture phrase

Did you save at an appropriate level?

When you overdub repeatedly, the phrase level may increase, causing distortion when you save it to a pad. Adjust the level when saving the sound to a pad. (p. 27)

An inserted CompactFlash card is not recognized, or its data cannot be selected

Is the CompactFlash card inserted correctly?

Check the CompactFlash card. (p. 45)

Is the CompactFlash card an appropriate type?

You can use CompactFlash cards with a capacity between 32 MB and 2 GB. Other cards cannot be used. (p. 44)

Is the CompactFlash card formatted correctly?

CompactFlash cards formatted by a device other than the SP-555 cannot be used. Please format the CompactFlash card. (p. 45)

Data is not saved correctly in the SP-555's internal memory

It is possible that the power was turned off while data was being written into internal memory (i.e., while the dot was blinking in the display). The lost data cannot be recovered.

In this case, it is possible that all data in internal memory has been destroyed. Additional malfunctions may occur if you attempt to continue using the SP-555. Please initialize the internal memory. (p. 50).

* When you initialize the memory, all data in internal memory will be lost.

Data is not saved correctly in the CompactFlash card

It is possible that the power was turned off while data was being written into the CompactFlash card (i.e., while the dot was blinking in the display). The lost data cannot be recovered.

In this case, it is possible that all data in the CompactFlash card has been destroyed. Additional malfunctions may occur if you attempt to continue using the card. Please format the CompactFlash card. (p. 45).

* When you format the CompactFlash card, all data in the card will be lost.

Pattern sequencer does not synchronize to an external MIDI device

Have you made the correct settings so that the pattern sequencer can synchronize?

Check the settings. (p. 69)

Is the external MIDI device set to transmit MIDI clock messages?

Some devices have a setting that turns MIDI clock transmission on/off. Also, some external devices, such as sequencers, transmit MIDI clock only during playback.

Does the tempo of the external MIDI device exceed the tempo range to which the SP-555 is able to synchronize?

The SP-555 can synchronize to a tempo in the 40–200 range. It may be unable to synchronize to a tempo that is outside this range.

About the pedal

If you connect a pedal switch (DP series; sold separately) to the rear panel PEDAL jack, you'll be able to perform the following operations by pressing the pedal.

Function	Action	Operation
REC/OVERDUB/PLAY loop capture	Press the pedal to cycle through the choices, which are: record→play→overdub→play. Rapidly press the pedal twice to stop.	While holding down [CANCEL], press the pedal→turn the CTRL 3 knob to get the display to indicate "LC.1." Press [SAMPLING] to confirm.
PLAY/STOP loop capture	Press the pedal to cycle through the choices, which are: play→stop→play.	While holding down [CANCEL], press the pedal→turn the CTRL 3 knob to get the display to indicate "LC.2." Press [SAMPLING] to confirm.
PLAY/STOP pattern sequencer	Press the pedal to cycle through the choices, which are: play→stop→play.	While holding down [CANCEL], press the pedal→turn the CTRL 3 knob to get the display to indicate "SEQ." Press [SAMPLING] to confirm.
Turn FIXED VELOCITY on/off	Press the pedal to toggle between on/off for FIXED VELOCITY.	While holding down [CANCEL], press the pedal→turn the CTRL 3 knob to get the display to indicate "VEL." Press [SAMPLING] to confirm.
Turn the effect on/off	Press the pedal to turn the effect on/off.	While holding down [CANCEL], press the pedal→turn the CTRL 3 knob to get the display to indicate "EF.S." Press [SAMPLING] to confirm.

Attaching the stand (sold separately)

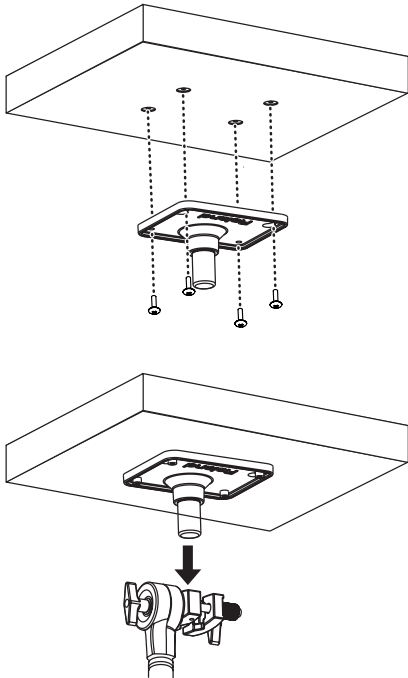

1. Using the screws located on the bottom of the SP-555, attach the stand holder of the PDS-10 pad stand (sold separately) as shown in the illustration.

* You must use these screws. Using any other screws will cause malfunctions.

NOTE

When turning the unit upside-down, get a bunch of newspapers or magazines, and place them under the four corners or at both ends to prevent damage to the buttons and controls. Also, you should try to orient the unit so no buttons or controls get damaged.

NOTE

When turning the unit upside-down, handle with care to avoid dropping it, or allowing it to fall or tip over.

2. Attach the SP-555 to the PDS-10 pad stand.

For details on assembling the pad stand or attaching the stand holder, refer to the owner's manual of the pad stand.

NOTE

If you attach the SP-555 to the PDS-10, you must spread the legs of the PDS-10 to their full extent. You must set up the stand so that the total height including the SP-555 itself does not exceed one meter.

This stand for use only with specific Roland musical instruments. See apparatus instructions. Use with other models is capable of resulting in instability causing possible injury.



Using the SP-555 with other MIDI equipment

About MIDI

MIDI stands for Musical Instrument Digital Interface, and is a global standard that allows electronic musical instruments and computers to exchange performance data. The SP-555 is compatible with MIDI, and provides two MIDI connectors, MIDI IN and MIDI OUT. By connecting these connectors to other MIDI devices you can create a wide range of setups.

MEMO

“MIDI Implementation” (p. 72) is a chart that provides an easy way of checking which MIDI messages the SP-555 is able to receive. By comparing the MIDI implementation charts of the SP-555 and some other MIDI device, you can see which messages are compatible between the two devices.

Synchronizing the SP-555 with another MIDI device

1. While holding down [TIME/BPM], turn on the power.

2. Press bank [A].

The display will indicate “Mod,” and then the MIDI synchronization mode will be displayed.

Synchronization will operate according to the MIDI synchronization mode.

MIDI synchronization mode	Explanation
“Aut” (Auto Sync)	When MIDI clock is received, the SP-555 will automatically synchronize its own tempo to it. If MIDI start/stop/continue messages are received, the pattern will start/stop playing. * MIDI start/stop/continue will not be received during pattern recording.
“tMp” (Tempo Sync)	When MIDI clock is received, the SP-555 will automatically synchronize its own tempo to it. MIDI start/stop/continue messages will not be received. * Select this mode of operation if you want to play the SP-555’s patterns later at the desired timing in synchronization with the performance of your external MIDI sequencer, so that the two performances do not begin at the same time.
“oFF” (Sync OFF)	MIDI clock and start/stop/continue messages will not be received. * Select this mode of operation if you only want to play the SP-555’s samples using note messages sent by your external MIDI sequencer.

3. Turn the CTRL 3 knob to select the MIDI synchronization mode.

MEMO

With the factory settings this is set to “Aut.”

4. Press [SAMPLING] so its light is turned off.

This completes the MIDI synchronization mode setting.

MEMO

This setting will not change when you turn off the power.

Synchronizing to a USB-connected MIDI device

If the SP-555 is connected via USB to your computer, and you want to synchronize it with your MIDI sequencer software or DAW software, you must make the following settings in addition to the MIDI synchronization mode setting described above.

- Install the driver (p. 40.)
- Change the Sync Source (the source for MIDI clock reception) to “USB” (p. 63.)

Synchronizing the pattern tempo and playback start/stop with an external MIDI sequencer

With the factory settings, the SP-555 (whose MIDI synchronization mode will be set to "Aut") can be connected to your external MIDI sequencer, and the external MIDI sequencer can control the start/stop and tempo of the pattern playback.

1. Use a MIDI cable to connect your external MIDI sequencer's MIDI OUT connector to the SP-555's MIDI IN connector.
2. Press [PATTERN SELECT] so the button is lit.
3. Press a BANK [A]–[F/J] button to select the bank of the pattern you want to play.
To select a pattern bank G–J, press BANK [C/G]–[F/J] once again so the button is blinking.

MEMO

If no CompactFlash card is inserted, you won't be able to select pattern banks C–J.

4. While holding down [HOLD], press the pad of the pattern you want to play.
The pad of the specified pattern will light.

MEMO

If you simply press the pad without pressing [HOLD], the pattern will begin playing immediately.

5. Start your external MIDI sequencer.
The specified pattern will begin playing in synchronization with your external MIDI sequencer. The pattern tempo will synchronize to the tempo of your external MIDI sequencer.
6. When you stop your external MIDI sequencer, the pattern will stop playing.

MEMO

If the pattern playback does not start when you start your external MIDI sequencer, or if the tempo does not synchronize to your external MIDI sequencer, it is possible that your external MIDI sequencer is not transmitting MIDI clock or start/continue/stop messages.

Refer to the owner's manual of your external MIDI sequencer and check its settings.

Transmitting MIDI clock at the pattern tempo

If you make this setting, the SP-555's MIDI IN connector will transmit timing clock in synchronization with the pattern tempo, as well as synchronization-related MIDI messages (start, stop, continue).

NOTE

If the SP-555 is synchronized to an external MIDI device, it will not transmit timing clock or synchronization-related MIDI messages.

1. While holding down [TIME/BPM], switch on the SP-555's power.
2. Press BANK [C].
The display will indicate "tH."
3. Turn the CTRL 3 knob to turn MIDI clock transmission on/off.
If you turn this "on," synchronization messages will be transmitted from the MIDI OUT connector and from the USB's MIDI OUT.
4. Press [SAMPLING] to save the setting.

MEMO

In order to synchronize an external MIDI device to the SP-555, the MIDI device must be set to follow these synchronization messages. For details on these settings and how to make them, refer to the owner's manual for your MIDI device.

MIDI channel (Pad Base Ch.) and note numbers

Use the following MIDI channels and note numbers when playing the SP-555's samples from an external MIDI device, or when using the SP-555's pads to play an external MIDI device.

Note	Note #	MIDI Ch	
		Pad Base Ch	Pad Base Ch+1
B1 : D3	35(23h) : 50(32h)	[A] Pad1 : Pad16	[F] Pad1 : Pad16
Eb3 : F#4	51(33h) : 66(42h)	[B] Pad1 : Pad16	[G] Pad1 : Pad16
G4 : Bb5	67(43h) : 82(52h)	[C] Pad1 : Pad16	[H] Pad1 : Pad16
B5 : D7	83(53h) : 98(62h)	[D] Pad1 : Pad16	[I] Pad1 : Pad16
Eb7 : F#8	99(63h) : 114(72h)	[E] Pad1 : Pad16	[J] Pad1 : Pad16

Changing the MIDI channel (Pad Base Ch.)

1. While holding down [PATTERN SELECT], switch on the SP-555's power.
2. Press BANK [A].
The display will indicate "C.1."
3. Turn the CTRL 3 knob to specify the MIDI channel.
4. Press [SAMPLING] to save the setting.

MEMO

You can't change the MIDI channel used for transmission by the pattern sequencer. The pattern sequencer always operates under the assumption that Pad Base Ch. = 1.

MIDI Thru setting

1. While holding down [PATTERN SELECT], switch on the SP-555's power.
2. Press BANK [B].
The display will indicate "trU."
3. Turn the CTRL 3 knob to turn MIDI Thru on/off.
If this is "on," MIDI messages received at the MIDI IN connector or the USB MIDI input will be retransmitted ("thru-ed") from the MIDI OUT connector. MIDI messages from the MIDI IN connector will be "thru-ed" to the USB MIDI output. The "thru-ed" MIDI messages will be merged with the pad performance and pattern sequencer performance, and sent to each MIDI output.
4. Press [SAMPLING] to save the setting.

MIDI Implementation

Model: SP-555
Date: May 01, 2007
Version: 1.00

1. Receive data

■ Channel Voice Messages

* For the correspondence between note numbers and pad banks, refer to “MIDI channel (Pad Base Ch.) and note numbers” (p. 71).

● Note Off

Status	2nd byte	3rd byte
8nH	kkH	vvH
9nH	kkH	00H

n = MIDI channel number: 0H - FH (ch.1 - ch.16)
kk = note number: 23H - 72H (35 - 114)
vv = note off velocity: 00H - 7FH (0 - 127)

● Note On

Status	2nd byte	3rd byte
9nH	kkH	vvH

n = MIDI channel number: 0H - FH (ch.1 - ch.16)
kk = note number: 23H - 72H (35 - 114)
vv = note on velocity: 01H - 7FH (1 - 127)

■ Channel Mode Messages

* If the following channel mode message is received during realtime recording, note-off messages will be generated for all notes on the corresponding channel that are currently on, and those note-off messages will be recorded.

● All Sounds Off (Controller number 120)

Status	2nd byte	3rd byte
BnH	78H	00H

n = MIDI channel number: 0H - FH (ch.1 - ch.16)

* If the All Sound Off message is received, all notes will be silenced regardless of their channel.

■ System Common Message

● Song Position Pointer

Status	2nd byte	3rd byte
F2H	mmH	llH

(mm ll: 00 00H - 7F 7FH (0 - 16383))

* This message is received if Sync Mode is AUTO.

■ System Realtime Message

● Timing Clock

Status
F8H

* This message is received if Sync Mode is AUTO or TEMPO.

● Start

Status
FAH

* This message is received if Sync Mode is AUTO.

● Continue

Status
FBH

* This message is received if Sync Mode is AUTO.

● Stop

Status
FCH

* This message is received if Sync Mode is AUTO.

● Active Sensing

Status
FEH

2. Transmit data

* For details on the messages that are transmitted during V-LINK operation, refer to “About V-LINK” (p. 52).

■ Channel Voice Messages

* For the correspondence between note numbers and pad banks, refer to “MIDI channel (Pad Base Ch.) and note numbers” (p. 71).

● Note Off

Status	2nd byte	3rd byte
8nH	kkH	40H

n = MIDI channel number: 0H - FH (ch.1 - ch.16)
kk = note number: 23H - 72H (35 - 114)

●Note On

<u>Status</u>	<u>2nd byte</u>	<u>3rd byte</u>
9nH	kkH	vvH

n = MIDI channel number: 0H - FH (ch.1 - ch.16)

kk = note number: 23H - 72H (35 - 114)

vv = note on velocity: 01H - 7FH (1 - 127)

●Control Change**○CTRL1 (Controller number 13)**

<u>Status</u>	<u>2nd byte</u>	<u>3rd byte</u>
BnH	0DH	vvH

n = MIDI channel number: 0H - EH (ch.1 - ch.15)

vv = Control value: 00H - 7FH (0 - 127)

○CTRL2 (Controller number 14)

<u>Status</u>	<u>2nd byte</u>	<u>3rd byte</u>
BnH	0EH	vvH

n = MIDI channel number: 0H - EH (ch.1 - ch.15)

vv = Control value: 00H - 7FH (0 - 127)

○CTRL3 (Controller number 15)

<u>Status</u>	<u>2nd byte</u>	<u>3rd byte</u>
BnH	0FH	vvH

n = MIDI channel number: 0H - EH (ch.1 - ch.15)

vv = Control value: 00H - 7FH (0 - 127)

■System Realtime Message**●Timing Clock**

<u>Status</u>
F8H

* This message is transmitted only if Tx MIDI Sync is ON.

●Start

<u>Status</u>
FAH

* This message is transmitted only if Tx MIDI Sync is ON.

●Continue

<u>Status</u>
FBH

* This message is transmitted only if Tx MIDI Sync is ON.

●Stop

<u>Status</u>
FCH

* This message is transmitted only if Tx MIDI Sync is ON.

MIDI Implementation Chart

Function...	Transmitted	Recognized	Remarks
Basic Default Channel Changed	1-16 1-16	1-16 1-16	
Mode Default Messages Altered	X X *****	Mode 3 X	
Note Number : True Voice	35-114 *****	35-114 35-114	
Velocity Note On Note Off	O X	O X	
After Key's Touch Channel's	X X	X X	
Pitch Bend	X	X	
Control Change 13 14 15	O O O	X X X	CTRL 1 CTRL 2 CTRL 3
Program Change : True Number	X *****	X	
System Exclusive	X	X	
System Common : Song Position : Song Select : Tune Request	X X X	O X X	*2
System Real Time : Clock : Commands	O O	O O	*3 *2
Aux Messages : All Sound Off : Reset All Controllers : Local On/Off : All Notes Off : Active Sensing : System Reset	X X X X O X	O X X X O X	
Notes	*1 Transmitted if Tx MIDI Sync is ON. *2 Received if Sync Mode is AUTO. *3 Received if Sync Mode is AUTO or TEMPO.		

Mode 1 : OMNI ON, POLY
Mode 3 : OMNI OFF, POLY

Mode 2 : OMNI ON, MONO
Mode 4 : OMNI OFF, MONO

O : Yes
X : No

Specifications

SP-555: Sampler

Maximum Polyphony

12 voices

Sampling Frequency

44.1 kHz

Data Format

SP-555 original format
(WAV/AIFF import/export possible)

Sampling Mode

STANDARD, LO-FI

Maximum Sampling Time (mono, approx.)

Internal Memory * Including Pre-loaded Samples

STANDARD	LO-FI
11 min.	22 min.

Memory Card (CompactFlash)

Card capacity	STANDARD	LO-FI
128 MB	48 min.	96 min.
256 MB	96 min.	193 min.
512 MB	193 min.	386 min.
1 GB	386 min.	772 min.
2 GB	772 min.	1544 min.

Internal Memory

Samples: 32 (16 samples x 2 banks) * Including Pre-loaded Samples
Patterns: 32 (16 patterns x 2 banks) * Including Pre-loaded Patterns

Memory Card (CompactFlash)

Samples: 128 (16 samples x 8 banks)
Patterns: 128 (16 patterns x 8 banks)

Loop Capture

Maximum recording time: approx. 15 sec.

Pattern Sequencer

Maximum recordable notes	Internal Memory: Approx. 8,000 notes * Including Pre-loaded Patterns
	Memory Card (CompactFlash): Approx. 8,000 notes
Resolution	96 ticks per quarter note
Pattern Length	1-99 measures
Recording method	Realtime Loop Recording (with quantize function)

Effects

37 types

Signal Processing

AD Conversion: 24 bits
DA Conversion: 24 bits

Pads

16 with velocity sensitivity

Controllers

Control Knobs x 3, D Beam Controller

Display

7 segments, 3 characters (LED)

Onboard Mic

Mono x 1

Connectors

LINE INPUT Jacks (L, R) (RCA phono type)
LINE OUTPUT Jacks (L, R) (RCA phono type)
Headphones (PHONES) Jack (Stereo 1/4 inch phone type)
MIC Jack (1/4 inch phone type / XLR type, Hi-Z, phantom power)
Pedal Jack (1/4 inch phone type)
MIDI Connector (IN, OUT)
USB Connector (supports USB MIDI and USB Audio)
AC Adaptor Jack
Memory Card Slot (CompactFlash)

Power Supply

DC 9 V (AC Adaptor)

Current Draw

800 mA

Dimensions

280.0 (W) x 263.7 (D) x 73.7 (H) mm
11-1/16 (W) x 10-7/16 (D) x 2-15/16 (H) inches

Weight

1.8 kg
4 lbs
(excluding AC Adaptor)

Accessories

CD-ROM x2 (SONAR LE, WAVE CONVERTER/USB DRIVER)
AC Adaptor
Owner's Manual
Quick Start Guide

Options

Pedal Switch (DP-2)
Foot Switch (BOSS FS-5U)
Pad Stand (PDS-10)

* In the interest of product improvement, the specifications and/or appearance of this unit are subject to change without prior notice.

Index

A

AC adaptor	13
AiF	64
AiF	47
Assign	
Effect	19
Preloaded samples	21
AUt	63
Aut	69
Auto	
Sampling	22
Start	11, 27

B

Bank	12, 15, 18
------------	------------

C

C.JP	19
C.nL	19
CANCEL	12
Card Slot	13
CHG	30
CLP	53
CompactFlash	12
Bank	15
Slot	13
Count	23
CPY	31, 37
Current	
Pad	16

D

dAL	24
dEL	23, 26
Delete	
backup data	49
pattern	35
Phrase	25–26
playback region	28
Sample	23

E

Effect	18
Button	11
D BEAM	11
Knob	11
Limit mode	20
EFFECT GRAB	20
EFFECT MEMORY	12
EMP	46

Erase

backup data	48
pattern	36
EXP	47

F

FiL	46
FILTER	11
FIXED VELOCITY	12, 16
FuL	30–31, 37

G

GATE	12
------------	----

H

HOLD	12, 17
------------	--------

I

iMP	46
InP	42

L

LoF	20
L.on	20
LC.1	64
LC.2	64
LENGTH	11
LEV	24
LINE IN	10
LO-FI	12
LOOP	12

M

MA _n	63
MARK	12
MdP	53, 63
MEASURE	11
Metronome	
button	11
count-in	23
on/off	60
pattern	34
MIC	10
Mid	33, 63
MIDI	13
Mod	69

O

oFF	63
out	42

- P**
- Pad
 - effect 18
 - sampling 22
 - sensitivity 16
 - Pad stand 68
 - Pattern
 - backup delete 49
 - backup load 48
 - backup save 48
 - clear 50
 - copy 37
 - delete 36
 - exchange 37
 - factory setting 50
 - play 33
 - protect 51
 - recording 34
 - Sequencer 11
 - switch 33
 - tempo 33
 - PEAK Indicator 11
 - PEDAL 14
 - PHONES 13
 - PLAY 12
 - PLT 53
 - Prt 23–24, 36, 46
 - Ptn 34–36, 51, 64
- Q**
- QUANTIZE 11
- R**
- rdY 22, 27
 - REC 11
 - rEC 22–23, 27
 - rEH 35
 - REMAIN 12
 - RESAMPLE 12
 - REVERSE 12
 - ROLL 12, 16
 - runcate 31
- S**
- Sample
 - Auto Sampling 22
 - BPM 32
 - Copy 31
 - Delete 23
 - Exchange 30
 - Loop 17
 - Playback region 28
 - Polyphony 15
 - Resampling 24
 - Tempo 20
 - Volume 28
 - SAMPLING 12
 - SAVE TO PAD 12
 - SEq 63–64
- SOURCE SELECT 11
 - Stand 68
 - START/END/LEVEL 12
 - Std 53, 63
 - STEREO 12
 - Stereo 15, 22, 27
 - SUB PAD 12, 33
 - synchronize
 - another MIDI device 69
 - MIDI clock 70
 - mode 69
 - V-LINK 52
 - SYNTH 11
- T**
- TAP TEMPO 11, 20, 23, 26, 29
 - Tempo
 - Effect 20
 - Loop Capture 26
 - Sampling 23
 - tH 70
 - TIME/BPM 12
 - tMp 69
 - tmP 63
 - trC 31
 - Trigger
 - Auto Sampling 22
 - D BEAM 11
 - Playback 16
 - trU 71
 - Truncate 31
- U**
- UnS 46
 - USB 13
 - USb 63
- V**
- VEL 64
 - Volume
 - Line In 10
 - Line Out 11
 - Mic 10
 - Phrase 26
 - Sample 28
- W**
- WAV 47, 64

For EU Countries



- UK** This symbol indicates that in EU countries, this product must be collected separately from household waste, as defined in each region. Products bearing this symbol must not be discarded together with household waste.
- DE** Dieses Symbol bedeutet, dass dieses Produkt in EU-Ländern getrennt vom Hausmüll gesammelt werden muss gemäß den regionalen Bestimmungen. Mit diesem Symbol gekennzeichnete Produkte dürfen nicht zusammen mit den Hausmüll entsorgt werden.
- FR** Ce symbole indique que dans les pays de l'Union européenne, ce produit doit être collecté séparément des ordures ménagères selon les directives en vigueur dans chacun de ces pays. Les produits portant ce symbole ne doivent pas être mis au rebut avec les ordures ménagères.
- IT** Questo simbolo indica che nei paesi della Comunità europea questo prodotto deve essere smaltito separatamente dai normali rifiuti domestici, secondo la legislazione in vigore in ciascun paese. I prodotti che riportano questo simbolo non devono essere smaltiti insieme ai rifiuti domestici. Ai sensi dell'art. 13 del D.Lgs. 25 luglio 2005 n. 151.
- ES** Este símbolo indica que en los países de la Unión Europea este producto debe recogerse aparte de los residuos domésticos, tal como está regulado en cada zona. Los productos con este símbolo no se deben depositar con los residuos domésticos.
- PT** Este símbolo indica que nos países da UE, a recolha deste produto deverá ser feita separadamente do lixo doméstico, de acordo com os regulamentos de cada região. Os produtos que apresentem este símbolo não deverão ser eliminados juntamente com o lixo doméstico.
- NL** Dit symbool geeft aan dat in landen van de EU dit product gescheiden van huishoudelijk afval moet worden aangeboden, zoals bepaald per gemeente of regio. Producten die van dit symbool zijn voorzien, mogen niet samen met huishoudelijk afval worden verwijderd.
- DK** Dette symbol angiver, at i EU-lande skal dette produkt opsamlles adskilt fra husholdningsaffald, som defineret i hver enkelt region. Produkter med dette symbol må ikke smides ud sammen med husholdningsaffald.
- NO** Dette symbolet indikerer at produktet må behandles som spesialavfall i EU-land, iht. til retningslinjer for den enkelte regionen, og ikke kastes sammen med vanlig husholdningsavfall. Produkter som er merket med dette symbolet, må ikke kastes sammen med vanlig husholdningsavfall.

- SE** Symbolen anger att i EU-länder måste den här produkten kasseras separat från hushållsavfall, i enlighet med varje regions bestämmelser. Produkter med den här symbolen får inte kasseras tillsammans med hushållsavfall.
- FI** Tämä merkintä ilmaisee, että tuote on EU-maissa kerättävä erillään kotitalousjätteistä kunkin alueen voimassa olevien määräysten mukaisesti. Tällä merkinnällä varustettuja tuotteita ei saa hävittää kotitalousjätteiden mukana.
- HU** Ez a szimbólum azt jelenti, hogy az Európai Unióban ezt a terméket a háztartási hulladéktól elkülönítve, az adott régióban érvényes szabályozás szerint kell gyűjteni. Az ezzel a szimbóllummal ellátott termékeket nem szabad a háztartási hulladék közé dobni.
- PL** Symbol oznacza, że zgodnie z regulacjami w odpowiednim regionie, w krajach UE produktu tym należy wyrzucić z odpadami domowymi. Produktów opatrzonych tym symbolem nie można utylizować razem z odpadami domowymi.
- CZ** Tento symbol udává, že v zemích EU musí být tento výrobek sbírán odděleně od domácího odpadu, jak je určeno pro každý region. Výrobky nesoucí tento symbol se nesmí vyhazovat spolu s domácím odpadem.
- SK** Tento symbol vyjadruje, že v krajinách EÚ sa musí zber tohto produktu vykonávať oddelene od domového odpadu, podľa nariadení platných v konkrétnej krajine. Produkty s týmto symbolom sa nesmú vyhazovať spolu s domovým odpadom.
- EE** See sümbol näitab, et EL-i maades tuleb see toode olemprügist eraldi koguda, nii nagu on igas piirkonnas määratletud. Selle sümboliga märgitud tooteid ei tohi ära visata koos olmeprügiga.
- LT** Šis simbolis rodo, kad ES šalyse šis produktas turi būti surenkamas atskirai nuo buitinių atliekų, kaip nustatyta kiekviename regione. Šiuo simboliu paženklinėti produktai neturi būti išmetami kartu su buitiniems atliekomis.
- LV** Šis simbols norāda, ka ES valstīs šo produktu jāievāc atsevišķi no mājsaimniecības atkritumiem, kā noteikts katrā reģionā. Produkts ar šo simbolu nedrīkst izmest kopā ar mājsaimniecības atkritumiem.
- SI** Ta simbol označuje, da je treba proizvod v državah EU zbirati ločeno od gospodinskih odpadkov, tako kot je določeno v vsaki regiji. Proizvoda s tem znakom ni dovoljeno odlagati skupaj z gospodinskimi odpadki.
- GR** Το σύμβολο αυτό υποδηλώνει ότι στις χώρες της Ε.Ε. το συγκεκριμένο προϊόν πρέπει να συλλέγεται χωριστά από τα υπόλοιπα οικιακά απορρίμματα, σύμφωνα με όσα προβλέπονται σε κάθε περιοχή. Τα προϊόντα που φέρουν το συγκεκριμένο σύμβολο δεν πρέπει να απορρίπτονται μαζί με τα οικιακά απορρίμματα.

For China

有关产品中所含有害物质的说明

本资料就本公司产品中所含的特定有害物质及其安全性予以说明。

本资料适用于 2007 年 3 月 1 日以后本公司所制造的产品。

环保使用期限



此标志适用于在中国国内销售的电子信息产品，表示环保使用期限的年数。所谓环保使用期限是指在自制造日起的规定的期限内，产品中所含的有害物质不致引起环境污染，不会对人身、财产造成严重的不良影响。环保使用期限仅在遵照产品使用说明书，正确使用产品的条件下才有效。不当的使用，将会导致有害物质泄漏的危险。

产品中有毒有害物质或元素的名称及含量

部件名称	有毒有害物质或元素					
	铅(Pb)	汞(Hg)	镉(Cd)	六价铬(Cr(VI))	多溴联苯(PBB)	多溴二苯醚(PBDE)
外壳(壳体)	×	○	○	○	○	○
电子部件(印刷电路板等)	×	○	×	○	○	○
附件(电源线、交流适配器等)	×	○	○	○	○	○

○：表示该有毒有害物质在该部件所有均质材料中的含量均在 SJ/T11363-2006 标准规定的限量要求以下。
 ×：表示该有毒有害物质至少在该部件的某一均质材料中的含量超出 SJ/T11363-2006 标准规定的限量要求。
 因根据现有的技术水平，还没有什么物质能够代替它。

For the U.K.

IMPORTANT: THE WIRES IN THIS MAINS LEAD ARE COLOURED IN ACCORDANCE WITH THE FOLLOWING CODE.

BLUE: NEUTRAL
BROWN: LIVE

As the colours of the wires in the mains lead of this apparatus may not correspond with the coloured markings identifying the terminals in your plug, proceed as follows:

The wire which is coloured BLUE must be connected to the terminal which is marked with the letter N or coloured BLACK.
The wire which is coloured BROWN must be connected to the terminal which is marked with the letter L or coloured RED.
Under no circumstances must either of the above wires be connected to the earth terminal of a three pin plug.

For EU Countries



This product complies with the requirements of European Directive 89/336/EEC.

For the USA

FEDERAL COMMUNICATIONS COMMISSION RADIO FREQUENCY INTERFERENCE STATEMENT

This equipment has been tested and found to comply with the limits for a Class B digital device, pursuant to Part 15 of the FCC Rules. These limits are designed to provide reasonable protection against harmful interference in a residential installation. This equipment generates, uses, and can radiate radio frequency energy and, if not installed and used in accordance with the instructions, may cause harmful interference to radio communications. However, there is no guarantee that interference will not occur in a particular installation. If this equipment does cause harmful interference to radio or television reception, which can be determined by turning the equipment off and on, the user is encouraged to try to correct the interference by one or more of the following measures:

- Reorient or relocate the receiving antenna.
- Increase the separation between the equipment and receiver.
- Connect the equipment into an outlet on a circuit different from that to which the receiver is connected.
- Consult the dealer or an experienced radio/TV technician for help.

This device complies with Part 15 of the FCC Rules. Operation is subject to the following two conditions:

- (1) this device may not cause harmful interference, and
- (2) this device must accept any interference received, including interference that may cause undesired operation.

Unauthorized changes or modification to this system can void the users authority to operate this equipment.
This equipment requires shielded interface cables in order to meet FCC class B Limit.

For Canada

NOTICE

This Class B digital apparatus meets all requirements of the Canadian Interference-Causing Equipment Regulations.

AVIS

Cet appareil numérique de la classe B respecte toutes les exigences du Règlement sur le matériel brouilleur du Canada.

For the USA

DECLARATION OF CONFORMITY Compliance Information Statement

Model Name : SP-555
Type of Equipment : Sampler
Responsible Party : Roland Corporation U.S.
Address : 5100 S. Eastern Avenue, Los Angeles, CA 90040-2938
Telephone : (323) 890-3700

