

SL MKII

USER GUIDE - FIRMWARE VERSION 1.0



novation[®]
www.novationmusic.com

CONTENTS

INTRODUCTION	5
HARDWARE OVERVIEW	6
ASSIGNABLE CONTROLS	6
NON-ASSIGNABLE CONTROLS	7
REAR PANEL CONNECTIONS	8
MOD JOYSTICK SPRING SELECTOR	8
POWER-UP CALIBRATION	8
SL MKII SETUP EXAMPLES	9
SOFTWARE CONTROL.....	9
HARDWARE CONTROL.....	9
SL MKII AS MIDI INTERFACE	9
AUTOMAP MODE VS ADVANCED MODE	10
AUTOMAP MODE.....	11
SELECTING AUTOMAP MODE.....	11
AUTOMAP MODE - SYSTEM BUTTONS	11
AUTOMAP TEMPLATE OVERVIEW	12
SPEED DIAL	12
PORTS.....	13
SOFTWARE SET-UP EXAMPLES	14
AUTOMAP FOR HARDWARE CONTROL	15
ADVANCED MODE	16
SELECTING TEMPLATES.....	16
ADVANCED MODE TEMPLATE OVERVIEW.....	17
SPEED DIAL	17
HARDWARE CONTROL.....	18
SOFTWARE & HARDWARE CONTROL.....	18
SPECIAL TEMPLATES FOR ABLETON LIVE & REASON	19
MENU OVERVIEW	20
NAVIGATING THE MENUS	20
SAVING/WRITING CHANGES	20
SELECTING	20
HIERARCHY OF SETTINGS.....	20
QUICK MENU	21
BANK & PROGRAM CHANGE OUTPUT	21
KEYBOARD TRANSPOSE	21
KEYBOARD MIDI CHANNEL	21
DRUM PADS TRANSPOSE.....	21
TEMPO SETTINGS	21
EDIT MENU BUTTON.....	22
TEMPLATE EDIT MENU.....	22
VELOCITY CURVE	22
AFTER TOUCH.....	22

POT PICK-UP	22
TEMPLATE KEYBOARD ZONES	22
TEMPLATE ROUTING SUB MENU	24
KEYBOARD CHANNEL & PORT	24
COMMON CHANNEL & PORT	24
TEMPLATE GROUPING SUB MENU	24
CONTROL EDIT OVERVIEW	24
GLOBAL MENU BUTTON	25
OPTIONS SUB MENU	25
MEMORY PROTECT	25
POT PICK-UP	25
DISPLAY TIME	25
KEEP VALUES.....	25
TOUCH SELECT	25
TRANSPORT	26
SUSTAIN PEDAL	26
START-UP SUB MENU	26
START UP MODE.....	26
AUTOMATIC DEMONSTRATION.....	26
ROUTING SUB MENU	26
USB1 TO.....	26
MIDI IN TO.....	26
MIDI CLOCK SETTINGS.....	26
PROGRAM CHANGE INPUT CHANNEL & PORT.....	27
GLOBAL ZONES SUB MENU	27
SEND & RECEIVE SUB MENU	27
TEMPLATE DUMP	27
SEND GLOBALS	28
OS RECEIVE & SEND.....	28
DRUMPADS CALIBRATION.....	28
JOYSTICK CALIBRATION	28
AFTERTOUCHE CALIBRATION.....	29
KEYBOARD SIZE CALIBRATION.....	29
POWER SOURCE	29
WRITING GLOBAL SETTINGS	29
TRANSPORT.....	29
CREATING & EDITING ADVANCED MODE TEMPLATES	30
MIDI MESSAGE ASSIGNMENT TABLE	30
CONTROL CHANGE (CC)	30
DISPLAY TYPE.....	30
ADDITIONAL OPTIONS FOR ENCODERS ONLY.....	31
REL 1 & 2	31
14-BIT 0-16K	31
APOT.....	31

CONTROL LABEL.....	31
VALUE RANGE.....	31
ADDITIONAL OPTIONS FOR BUTTONS ONLY.....	32
DISPLAY TYPE.....	32
BUTTON TYPE:.....	32
NORMAL.....	32
MOMENTARY	32
TOGGLE.....	32
STEP	32
GENERAL CONTROL EDIT SETTINGS	32
CONTROL EDIT PORT & CHANNEL SETTINGS.....	33
CC NUM.....	33
CONTROL EDIT POT PICK-UP MODE	33
XY PAD CONTROL EDIT	33
AXIS CONTROL	33
SELECTING THE AXIS FOR EDIT	33
NON-REGISTERED PARAMETER NUMBER (NRPN)	34
REGISTERED PARAMETER NUMBER (RPN)	34
SYSTEM EXCLUSIVE (SYSEX)	35
MIDI MACHINE CONTROL (MMC)	35
NOTE ON / OFF	36
BANK CHANGE.....	36
PROGRAM CHANGE.....	36
DRUM PAD NOTE	37
SYSTEM REAL TIME	37
PITCH BEND.....	37
TEMPLATE CHANGE MESSAGE	37

INTRODUCTION

Welcome to the SL MK II Guide.

This guide will introduce you to the SL MkII hardware and give you information on choosing how best to use the SL MkII for your software and / or hardware studio set-up, take you through the SL MkIIs Menu system and give detailed information on creating your own templates.

There is a separate User Guide for the Automap Software which is included on installation CD or can be downloaded from our website: www.novationmusic.com/support

Automap software is a new and exciting way to control your favourite music software applications. It operates the same way for all Novation Automap hardware (Products) so if you are using the SL MkII for Automap control of software then you should only need to read the first few chapters of this guide to familiarise yourself with the hardware.

Detailed information on installing, setting up, and operating Automap software can be found in the Automap User Guide.

Instructions on setting up your DAW software for use with Automap is found in the Automap software itself by clicking the DAW set-up guide button for detailed instructions.

For additional information, up to date support articles and a form to contact our Technical Support Team please visit the Novation Answerbase at: www.novationmusic.com/answerbase

HARDWARE OVERVIEW

The SL MkII 25, 49 and 61 note versions all have the same front panel controls and rear panel connections.

ASSIGNABLE CONTROLS



These are controls that can be assigned to parameters of the software or hardware you are controlling:

- 1) 8 touch sensitive endless rotary encoders with LED rings: These controls have no end points, so offer full 360° of movement. These controls offer speed dependent variable resolution, so moving the encoder slowly gives finer resolution than moving the encoder quickly.
- 2) 8 touch sensitive pots: These controls have fixed end points and offer 300° of movement.
- 3) 8 touch sensitive 35mm sliders.

All touch sensitive controls are responsive to contact with skin, so simply touching any of the above controls will highlight the parameter name and value on the LCD screen.

- 4) 32 buttons: All buttons are back-lit with LEDs.
- 5) 6 Transport buttons: 6 of the 32 assignable buttons can be switched to function as dedicated transport buttons.
- 6) 8 velocity-sensitive drum trigger pads.
- 7) Pitch/mod joystick.
- 8) X-Y Touchpad.

NON-ASSIGNABLE SYSTEM CONTROLS

They have fixed functions, as follows:

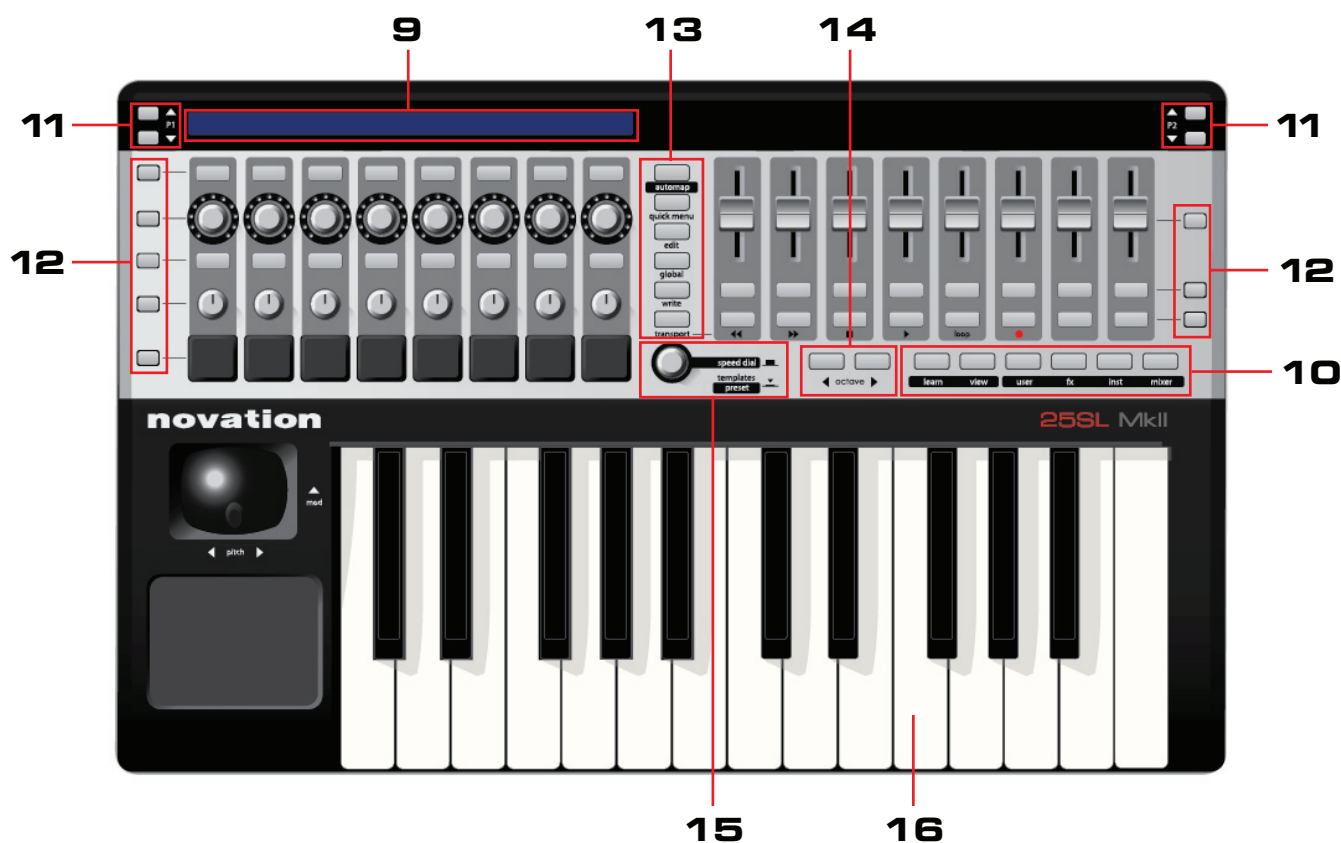

- 9) 144 character LCD display: Displays the names and values of each row of assignable controls from both the left and right side of the SL MkII
- 10) Automap Buttons: These 6 buttons are used for Automap Software navigation and control.
- 11) P1 / P2 Page Buttons: Use these to scroll through pages of options when in a menu or through pages of additional control information when in an Advanced template. These buttons have different specific functions when in certain Advanced templates and when using Automap.
- 12) Row-Select Buttons: Use these to select which row of controls has information shown on the display. These buttons can have other functions when using certain Advanced Mode templates and when using Automap.
- 13) Mode and System Buttons (Automap, Quick, Edit, Global, Write, Transport): Use these to access the different modes and menus of the SL MkII.
- 14) Octave Up / Down Buttons: Use these to transpose the keyboard up/down in octave steps.
- 15) Speed Dial /Template/Presets knob: The Speed Dial function acts as a way of controlling the computers mouse using the SL MkII hardware. When this button is pressed down it acts as a template selector (when in Advanced mode) and as a preset selector (Automap mode).
- 16) Keyboard: The SL MkII range is available in 25, 49 or 61 note keyboard versions. All are semi-weighted keyboards with aftertouch.

REAR PANEL CONNECTIONS

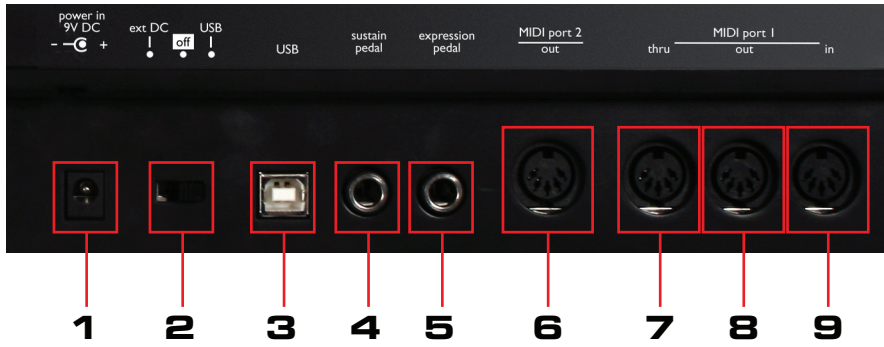

- 1) Power in socket: Use to connect a 9volt DC 600-1000mA Centre Pin positive PSU. The power supply is available from the online store: <http://www.focusrite-estore.com/>
- 2) Power switch: Use to switch the SL MkII to external power, USB power, or off.
- 3) USB in socket: Use to connect the SL MkII to your computer with the included USB cable.
- 4) Sustain pedal socket: Use to connect a sustain pedal. Any polarity pedal can be used.
- 5) Expression pedal Socket: Use to connect an expression pedal. Note that a 3 pin jack connector must be used.
- 6) MIDI port 2 out socket: Use to connect the SL MkII to the MIDI input of an external device using a 5pin DIN MIDI cable.
- 7) MIDI port 1 Through socket: Use to connect the SL MkII to the MIDI input of an external device using a 5pin DIN MIDI cable. MIDI Through is a copy of MIDI received from the MIDI In socket. Note: No MIDI from the SL MkII or computer can ever be sent to the MIDI Through socket. It is simply a way to forward MIDI from another device through the SL MkII to elsewhere.
- 8) MIDI port 1 Out socket: Use to connect the SL MkII to the MIDI input of an external device using a 5pin DIN MIDI cable.
- 9) MIDI port 1 In socket: Use to connect the SL MkII to the MIDI output of an external device using a 5pin DIN MIDI cable.

MOD JOYSTICK SPRING SELECTOR



Found on the bottom of the SL MkII, this slider selects whether the pitch/mod joystick springs to the bottom or moves freely in the vertical (mod) direction. Push it in gently and slide it towards the back of the SL MkII to enable the spring, or towards the front for free movement.

POWER UP CALIBRATION

The SL MkII self calibrates all touch sensitive controls when it powers up. Therefore you should not touch any control during the boot up process.

SL MKII SETUP EXAMPLES

The SL MkII can be used for controlling both computer music software and external hardware:

SOFTWARE CONTROL

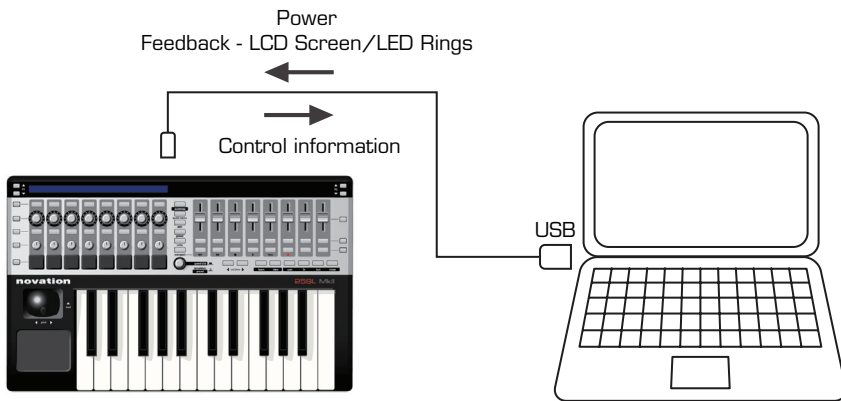

To use the SL MkII to control your music software, connect the SL MkII to your computer with the supplied USB cable.

HARDWARE CONTROL

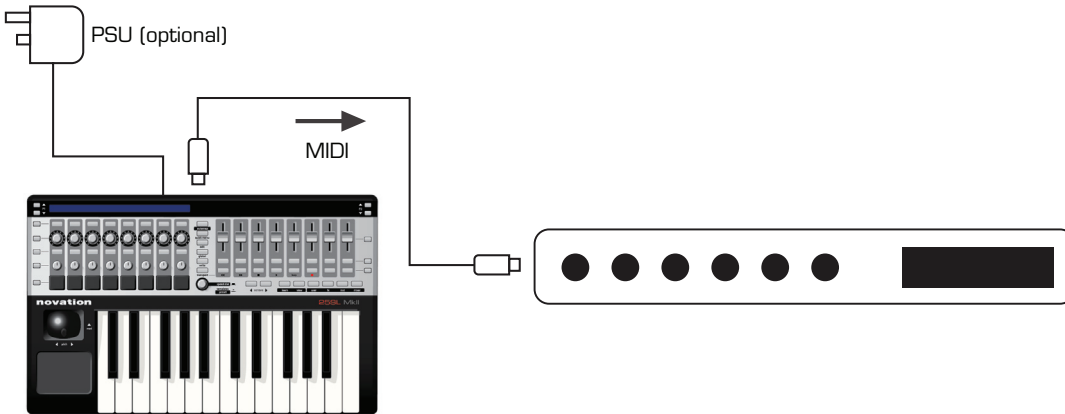

To use the SL MkII with your MIDI hardware, you will need to power the SL MkII with a 9 volt 1000mAmp DC PSU - center pin positive (not supplied).

Connect a MIDI Cable (5pin DIN) from the SL MkII MIDI Out 1 port to the MIDI In port on your hardware.

SL MKII AS A MIDI INTERFACE WITH SOFTWARE AND HARDWARE CONTROL

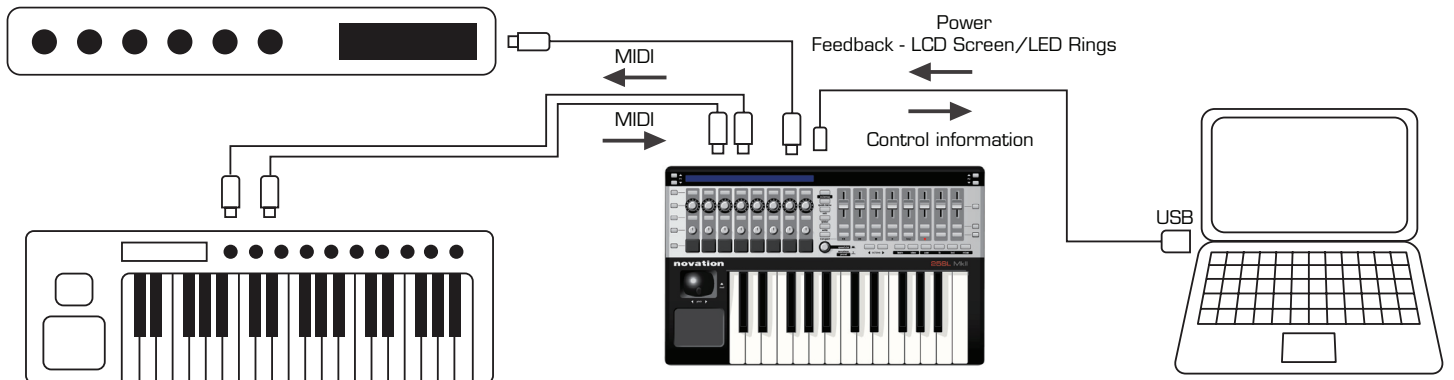

Using the SL MkII with External Hardware AND a Host Computer

You can also combine the two above set-ups so that the SL MkII is used as a software controller and hardware controller - transmitting MIDI data to and from computer and MIDI hardware. This will allow you to record MIDI data to your software DAW or Sequencer, and the SL MkII will then transmit this data to your hardware. For detailed information on using the SL MkII as a MIDI interface please see the routing section in the global menu.

AUTOMAP MODE VS ADVANCED MODE



Automap Mode

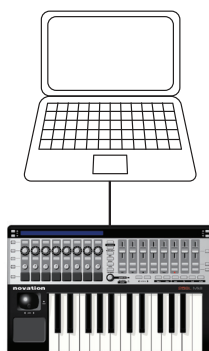

Advanced Mode

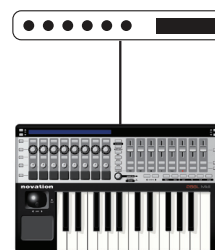

The SLMkII has two main Modes of operation: 'Automap Mode' and 'Advanced Mode'. These are both accessed via the main 'Automap' button.

Advanced Mode (Led off)

If you are going to use your SL MkII without a computer then you must use 'Advanced mode'. In fact, if you will only ever use your SLMkII in this way you can go straight to the Advanced Mode chapter of this user guide.

Automap Mode (Led On)

If you are going to use your SL MkII with a computer, then you will most likely be using 'Automap Mode'. To use Automap mode you will need to connect the SL MkII to a computer via USB and install Automap from the CD contained within the product Box or by downloading the installer from the website. The Automap Server Application must also be running for Automap to work.

The Automap Server is a unique software program written by Novation that allows dynamic communication between the SL MkII and any computer running music software and plug-ins (AU, VST, RTAS and TDM).

Easy Switching between the two modes

It is very quick and easy to switch between Advance mode and Automap Mode. This way, both modes can actually be used at the same time once you become more familiar with the product.

Advantages and Disadvantages to both modes

Both Advanced Mode and Automap Mode can be used for controlling hardware and software via standard MIDI messages.

Automap MIDI:

MIDI message types available are: MIDI CC, NOTE.

MIDI messages are limited to 1 MIDI channel per map.

MIDI message are limited to 1 port

Simpler Editing and assignment

Elegant Graphic display (HUD) and dynamic feedback

Advanced Mode:

MIDI message types available are: CC, 14bit CC, SYSEX, RPN, NRPN, MMC NOTE.

MIDI messages can be output to different MIDI channels from the same template.

MIDI messages can be output to different ports from the same template.

Does not require Automap Server to be running.

Does not require and connection to computer.

Limited to the number of template slots on the SL MkII.

Does not include any 'Learn' functionality.

More complex editing must be done using the SL MkII hardware.

AUTOMAP MODE

Full instructions on how to use Automap Software have been omitted from this user guide. The Automap software is the same for all Automap Hardware, so please refer to the Automap User Guide, This guide can be found on this CD or downloaded from the website.

Both the latest software and user guides can be downloaded at the following link: www.novationmusic.com/support

SELECTING AUTOMAP MODE

To use the SL Mk II in Automap Mode, press the **automap** button so that it is lit.



AUTOMAP MODE - SYSTEM BUTTONS



The Automap system buttons are important when in Automap mode and are used for navigation, assigning and browsing the Automap HUD (heads up display)

- **View** – opens or hides the Automap HUD window
- **Learn** - used for assigning and mapping parameters to SL MkII controls.
- Group buttons - **User**, **fx**, **inst** and **mixer** allow the user to browse and load up the corresponding mappings.



AUTOMAP TEMPLATE OVERVIEW

When in Automap Mode (Led On), a unique template is used. This template is separate from the built in 32 templates in advanced mode. All highlighted hardware controls displayed in the image below are available for controlling software parameters via Automap.

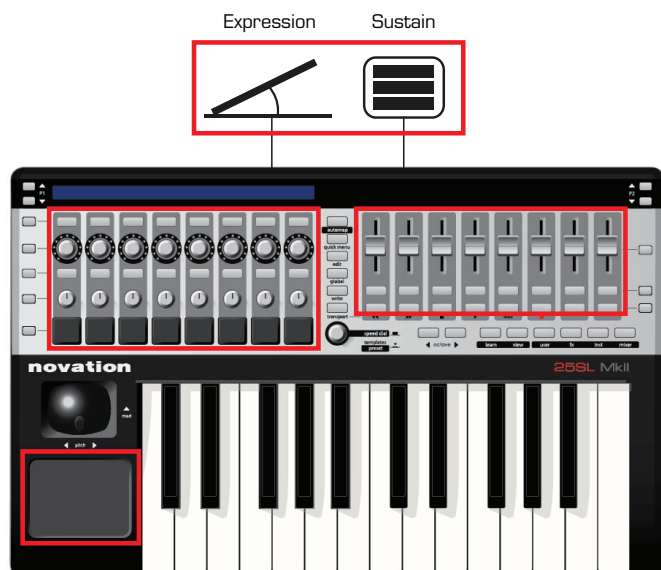

The following controls can be assigned to either the Automap Port or to the keyboard port and are thus are special controls when using Automap Mode.

- XY pad
- Sustain pedal
- Expression pedal
- Drum pads

When switched out, they are routed to the same destination as the SL MkII's keyboard. When switched in, they are routed to the Automap client and therefore omitted from the keyboard destination.

P1 Up / Down buttons - scroll through pages of an Automap mapping.

P2 Up / Down buttons - scroll through presets of an Automap plug-in. Preset navigation will only work where a plug-in uses the host preset navigation system, rather than it's own built-in one.

Row Select buttons are used to display the adjacent rows' controls on the SL's LCD screen. For example, pressing the upper right Row Select button, the parameter names and values assigned to the upper right row of buttons is displayed on the LCD.

SPEED DIAL

The **speed dial** knob has 2 functions in Automap Mode.

Speed Dial mode: The **speed dial** can be used to control any on-screen parameter that can be altered using the mouse. Simply move the mouse cursor over the parameter you want to change then rotate the knob to control it.

This process can be used for e.g. altering parameters on a soft-synth, controlling mixer parameters in your sequencer, selecting an option from a drop-down menu or resizing a window. The Automap Server software must be running for this function to work.

Preset mode: Press and rotate the knob whilst held down to select different plug-in presets. Preset navigation will only work where a plug-in uses the host preset navigation system, rather than it's own built-in one.

PORTS

What is a Port and how does it work?

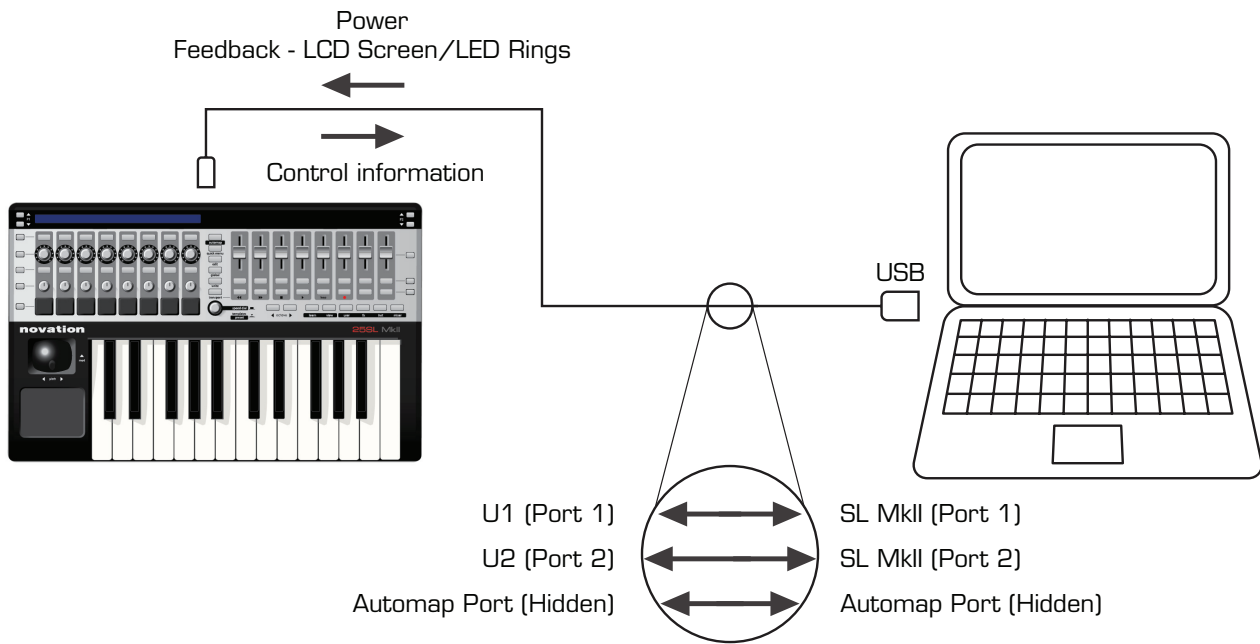

The SL MkII connects to the computer via a single USB cable, however this USB connection actually consists of 3 sub-connections called 'ports'.

Port 1

This port will be used a lot as it sends messages from the SL MkII Keyboard, Pitch / Modulation Stick and Sustain and Expression Pedals.

Port 2

Is generally reserved for special templates in advanced mode, but can be also used in more complex Advanced mode set-ups.

Automap Port (Hidden)

This is a hidden port (i.e. your computer does not display this port anywhere) and is used for all Automap Server messages. The Automap Server application then acts as a bridge between the SL MkII Hardware and your DAW software and plug-ins.

SOFTWARE SET-UP EXAMPLES

Automap for Cubase, Nuendo, Sonar, Tracktion

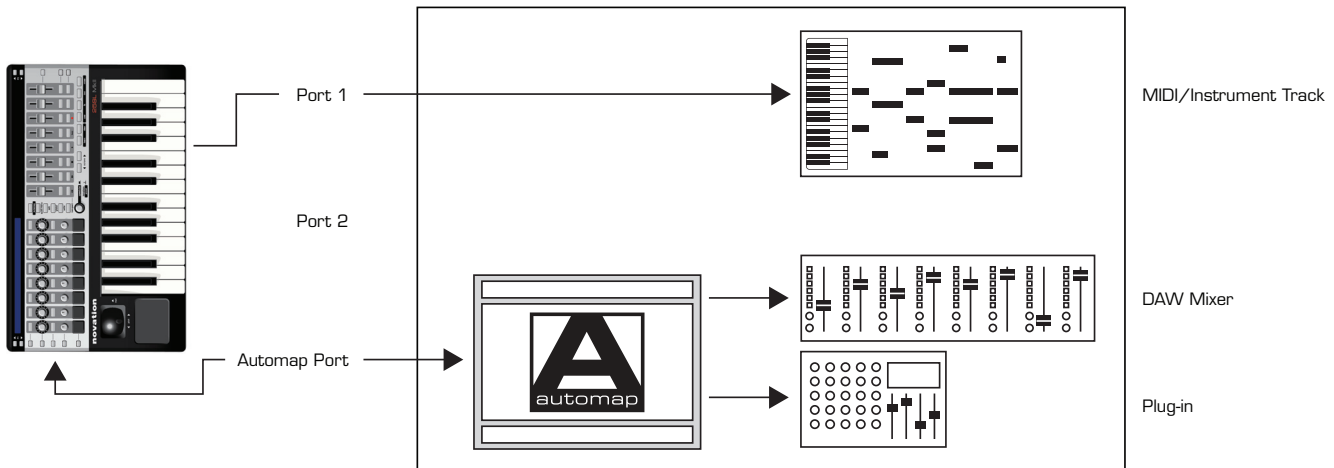

MIDI notes from the keyboard are sent on Port 1 to a MIDI / Instrument track. Automap Server controls the DAW Mixer and hosted plug-ins directly *Note other DAWs are being constantly added to this set-up configuration

Automap for Pro Tools, Digital Performer, Logic Pro, Reaper

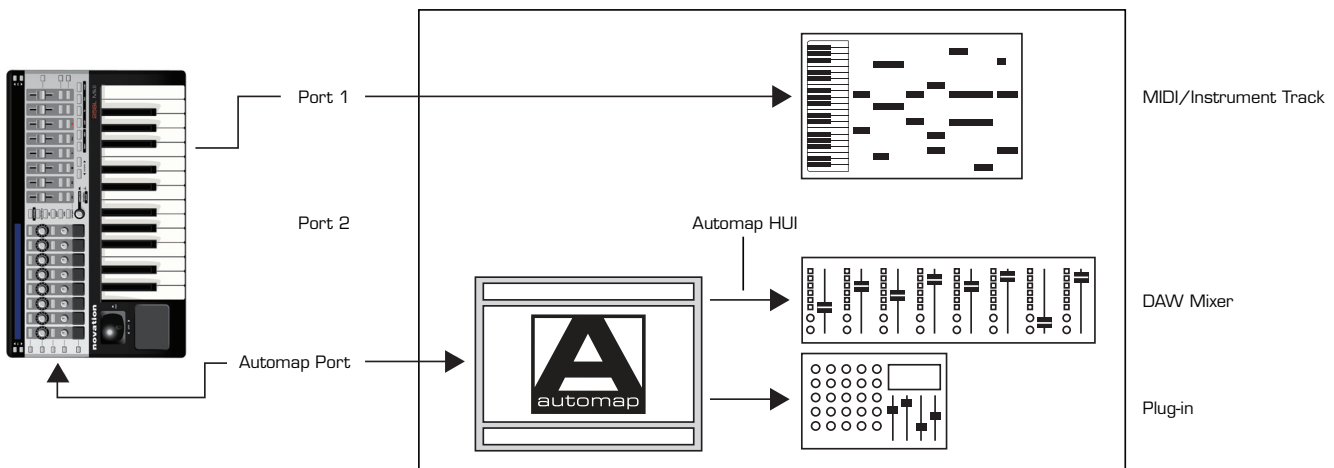

MIDI notes from the keyboard are sent on Port 1 to a MIDI / Instrument track. Automap Server controls the DAW Mixer using Automap HUI, and hosted plug-ins directly.

Automap for all other software

For software that responds to, or learns MIDI CC messages e.g. DJ software, stand-alone synthesiser software, certain plug-ins (with no host automation parameters).

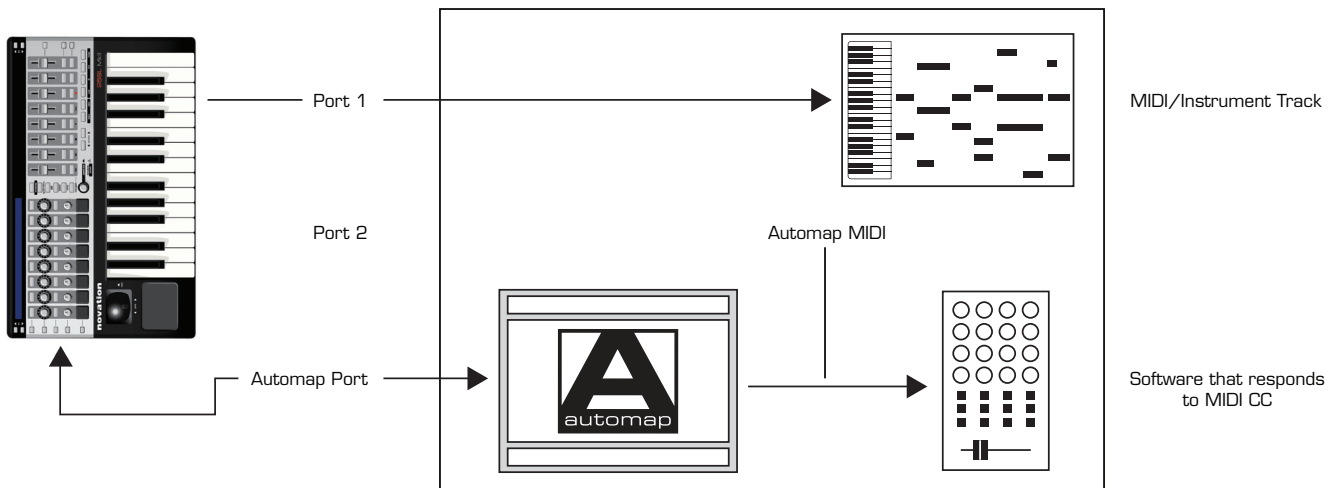

MIDI notes from the keyboard are sent on Port 1 to a MIDI / Instrument track (when applicable). Automap Server sends MIDI CC data to software using Automap MIDI - a virtual MIDI port.

AUTOMAP FOR HARDWARE CONTROL

Before you move on to the Advanced Mode section of this guide, you should know that Automap MIDI can also be used to hardware MIDI devices by routing MIDI CC data to the SL MkII MIDI Ports (or any other MIDI interface connected to your computer). Please refer to the Automap User guide for more info.

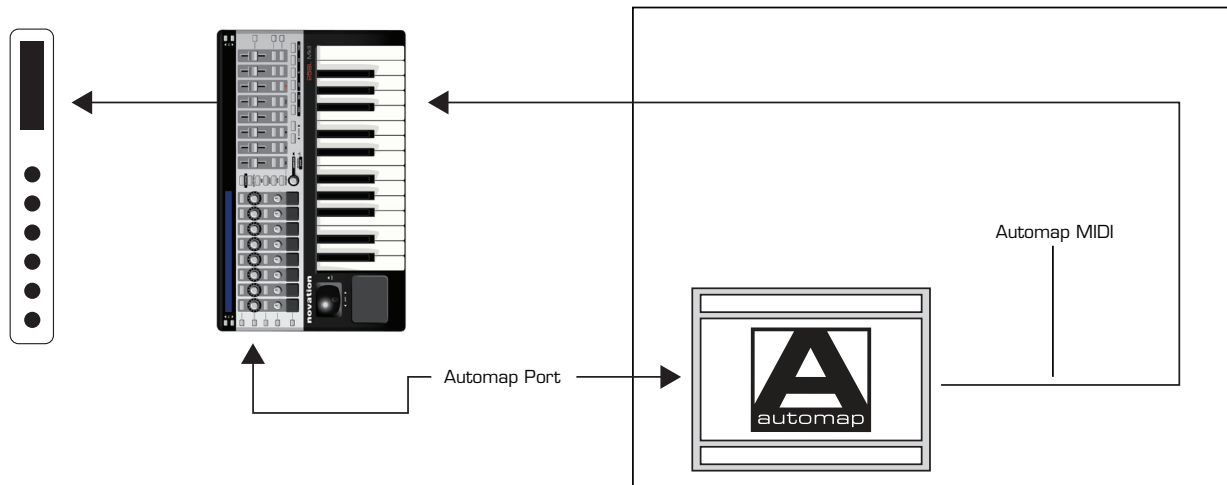

Ableton/Reason Special Templates

Please see advanced mode for more information on the Special Ableton/Reason templates.

ADVANCED MODE

Advanced Mode is primarily used to control external MIDI hardware, however it can also be used to control software when Automap is not supported or suitable for that software.



To switch to Advanced mode, press the Automap button so the LED is off.

Advanced mode includes 32 pre-built templates for controlling both hardware units and some software. All templates have been laid out intuitively with all controls labelled, but for full information on advanced mode templates, please check the Novation Answerbase: www.novationmusic.com/answerbase

SELECTING TEMPLATES

To switch between the 32 Advanced mode templates, press the **speed dial** knob.



Once pressed, the first 16 of the 32 templates will be displayed on the LCD.

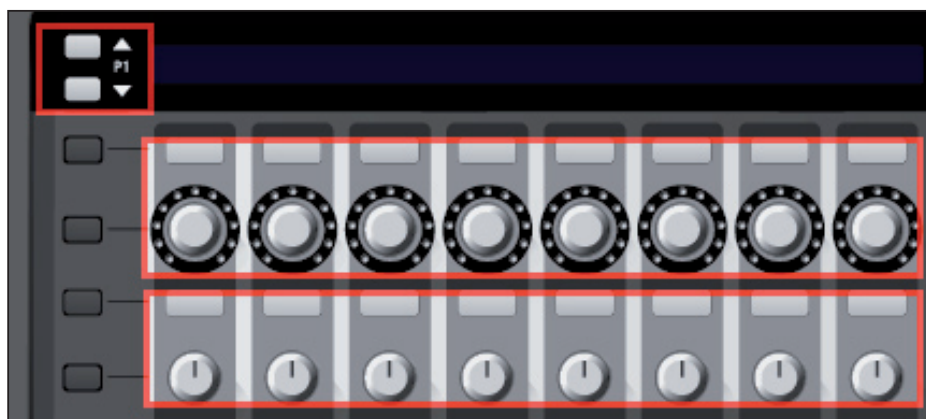

The flashing name on the LCD indicates the currently loaded template.

Press the button or knob on the top row to select the corresponding template from the top row on the LCD.

Press the button or knob on the bottom row to select the corresponding template from the bottom row on the LCD.

Press the **P1** up/down buttons to list the other 16 templates.

ADVANCED MODE TEMPLATE OVERVIEW

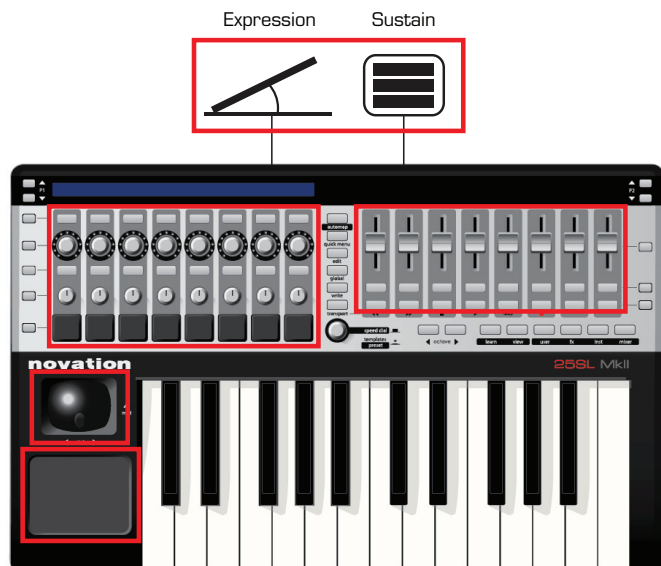

A 'Template' in the SL MkII is a layout of controls stored inside of the SL MkII memory. They are remembered even when you turn the unit on and off. All of the hardware controls are used to send out MIDI data of some kind with the exception of the following:

Automap System Buttons – These are reserved for the Automap Template only so are unavailable for the Advanced mode templates.

Row Select buttons – press to display the corresponding rows parameter names on the LCD

Page buttons - the **P1** and **P2** up/down arrows – press up once to display the type of MIDI message e.g CC or Sysex. Press up again to display the output port settings e.g. M1 (MIDI out 1) or U1 (USB port 1)

SPEED DIAL

The **speed dial / template** knob has two functions.

Speed Dial mode: The speed dial can be used to control any on-screen parameter that can be altered using the mouse. Simply move the mouse cursor over the parameter you want to change then rotate the knob to control it.

Note: The Automap Server software must be running for this function to work.

Template mode: Press down on the knob to display the list of templates.

HARDWARE CONTROL

In Advanced mode, MIDI data can be sent to either one of the 2 MIDI output ports

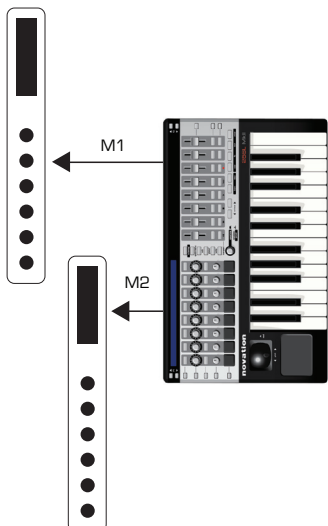

You can set up the templates so that all controls in the template are sent to only one or both of the MIDI output ports.

SOFTWARE AND HARDWARE CONTROL

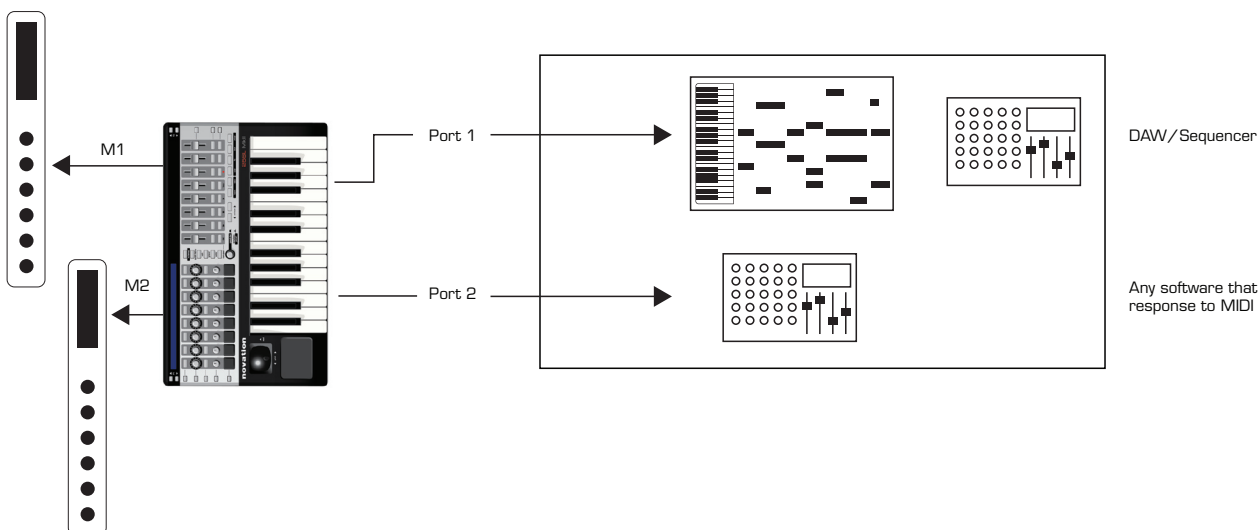

Advanced mode templates can be used in complex systems so that controls are sent to hardware via the MIDI ports and to software via the USB ports 1 + 2. You can even set different controls from within the same template to be sent to different output ports.

SPECIAL TEMPLATES FOR CONTROLLING ABLETON LIVE AND REASON

There are 2 special Advanced mode templates (templates 31 and 32).

These are templates for controlling DAW software that cannot be controlled using Automap, however the software developers have worked with Novation to create a control experience that offers more than a standard template.

Whereas with most of the Advanced mode templates, are set up to just send out control information to control software or hardware, these special templates include feedback, so if a parameter is changed from the software, then the SL MkII will update it's LCDs and LED rings.

Additional level of control includes the Row select buttons and P1 and P2 scroll buttons offering more functionality – whereas these buttons have fixed functionality in all the other standard templates.

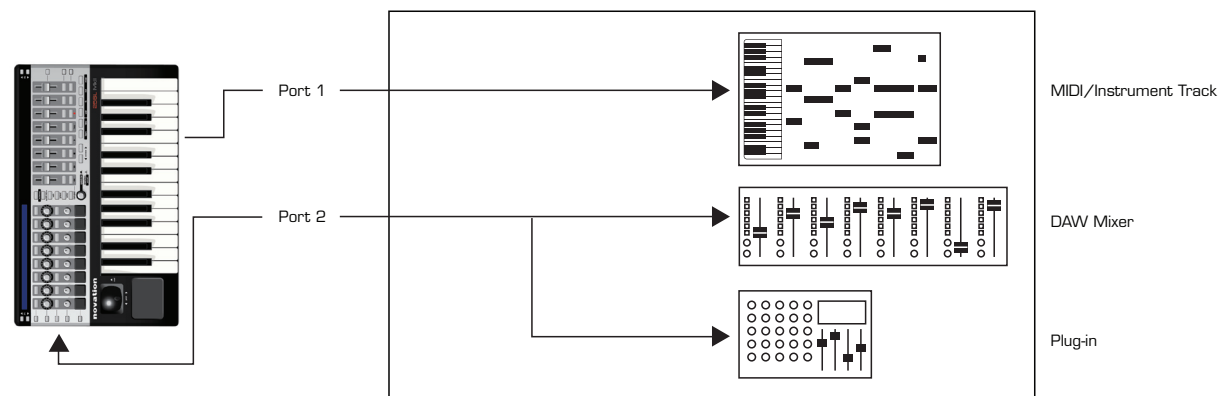

The 2 Special templates are for controlling Reason and Ableton.

Ableton Users Note: VST and AU plug-ins can be controlled using the Ableton template (as shown in the above diagram), but can also be controlled using Automap. Press the Automap Button on the SL MkII to switch between the Automap and Ableton (advanced) Template.

Reason Users Note: The only port that is used in the Reason template is Port 2 (i.e. both the keyboard and controls are sent on Port 2). The template offers control of Reason Mixer(s) and all Instruments and FX. Using Reason in Rewire mode with another DAW requires additional port set-up. Please refer to the DAW set-up guide in the Automap Server.

For more information please refer to the DAW set-up guide which is accessible from the Automap HUD, or visit the Novation Answerbase at: www.novationmusic.com/answerbase

MENU OVERVIEW

The SL MkII system menus are accessed by pressing their corresponding button in centre section of the SL MkII. Once a menu is selected, all available options and sub-menus are displayed on the LCD screen.



The main Menus are: Global, Edit and Write

NAVIGATING MENUS

Navigating menus and selecting menu items is done using a variety of controls on your SL MkII. To enter a menu, press the corresponding menu button. To exit a menu, press the same button again.

SAVING/WRITING SETTINGS

To be able to save/write your settings, you need to ensure that Memory Protect is OFF. This option is available in the **Global > Options** menu. If you have made changes to any of the **Global** menu options, press **Write** whilst in the **Global** menu to save your changes.

If you have made edits to your current Template, press **Write** to save your changes to the SL MkII memory.

SELECTING

To select an option, simply touch or press a knob, encoder or button directly below the option's position on the LCD. If a button is lit, then this denotes that there are selectable parameters, if the button is not lit, then the option cannot be changed.

To scroll through the options either rotate the encoder or the knob directly below the option. To step through the options either hit the top row of buttons to step up, or the bottom row of buttons to step down.

Some of the menu options contain sub menus.

---> denotes enter sub menu.

<--- denotes return to previous menu.

Some menu options contain multiple pages. If the **P1** or **P2** up / down buttons are lit, then this denotes additional pages. Press the lit button to navigate up/down through the pages.

HIERARCHY OF SETTINGS

There are three levels of settings that can be made on the SL MkII.

- Settings for individual controls within a template (Control **edit** menu)
- Settings for all controls within a single template (Template **edit** menu / **quick menu**)
- Settings for all controls within all templates (**Global** menu)

QUICK MENU

The Quick menu contains mainly commonly used functions:



Press the **quick menu** button and the following options will be displayed on the SL MkII LCD screen.

Bank	Program	Trnspose	KeybChan	DrmTrans	TempoBPM	Tempo
1	34	+0	1	+0	120	--->

Bank

Use to output a bank change message from the template Keyboard Port

Program

Use to output a program change message from the template Keyboard Port

Transpose - Trnspose

Use to transpose the keyboard up and down (each step is 1 semitone).

Keyboard Channel - KeybChan

Adjusts the MIDI channel assigned to the Keyboard Port.

Drum Pad Transpose - DrmTrans

Use to easily transpose the drum pads up and down (each step is 1 semitone).

Tempo BPM

Use to change the current Tempo. Entering the Tempo sub menu gives additional tempo options:

Tempo Submenu

Internal:	120 BPM	Source	Status	TapTempo	BACK
Current:	120 BPM	INTERNAL	RECEIVING	TAP	<---

Internal Tempo

Displays the tempo value as set in TempoBPM on previous page

Current Tempo

Displays the tempo as received from the computer (via USB) or an external MIDI device (via MIDI in). See MClk-In in the Global > Routing menu for details on setting the input source for MIDI Clock. You can also use this to set the current tempo.

Source

Displays the MIDI Clock In settings as specified in MClk-In

Status

Will either display:

RECEIVING – MIDI clock is being received

FLYWHEEL no external clock – no MIDI Clock is being received.

Tap Tempo

Tap the flashing button to set the tempo. You must tap 4 beats and the average tempo of the 4 beats is taken.

The button will flash in time with the tempo. Note that this will only work when the MIDI Clock settings: MClk-In is set to Internal (for more info on MIDI clock settings, see the **global** > Routing menu).

EDIT MENU

The **edit** button allows access to two main functions, depending on how the button is pressed.



Template Edit Mode

Press and RELEASE the **edit** button to enter 'Template Edit' Mode. This mode allows you to edit settings that affect the whole template (e.g. Velocity curves)

Control Edit Mode

Press and HOLD the **edit** button to enter 'Control Edit' Mode. This mode allows you to change the settings for each individual control within the current template (e.g. CC messages)

TEMPLATE EDIT MENU

The following settings affect all the controls within the currently loaded template. Note: All settings must be manually saved by pressing the **write** button.

Velocity Curve - VelCurve

Sets how the SL MkII responds to Keyboard velocity messages (how hard the keys are pressed). The options are:

LOUD1, 2, MEDIUM 1, 2, 3, QUIET 1, 2, (FIXED) 8-127.

Loud to Quiet settings define the output velocity i.e. loud settings give higher velocity output for a softer playing style, Quiet settings give lower velocity output for a harder playing style. 8-127 settings define a fixed output velocity of corresponding value. The default is MEDIUM 2.

AfterTouch - AfterTch

Aftertouch is an additional expressive control that allows data to be sent from the SL MkII when you apply additional pressure on the black or white keys on the keyboard. Aftertouch for the template can be set to either ON or OFF. Please note that this is channel aftertouch, not polyphonic aftertouch.

Pot Pick-up - Pick-Up

This sets how the rotary pots and sliders behave when switching template and can be set to ON or OFF.

ON: After selecting a template, if the current position of a control does not match the value of the control stored with the template, the control will not have any effect when operated until its position matches the value stored with the template.

OFF: After selecting a template, if the current position of a control does not match the value of the control stored with the template, the control value will jump from the stored value to match the position of the control as soon as the control is operated.

Note: Individual controls can have their own Pick-Up settings. The Template setting will be ignored unless the individual control is set to TEMPLATE.

TEMPLATE KEYBOARD ZONES

Normally the SL MkII is set so that the entire keyboard outputs on a single MIDI channel. Using Zones, the keyboard can be split in to 4 separate or overlapping regions. Each Zone can have its own MIDI channel, port, and keyboard range.

OFF – There are no zones for the current template; therefore all Zone Edit settings are ignored.

TEMPLATE – Zones are active for the current template. The Zone settings are defined in the Template Zone Edit sub menu.

GLOBAL - The Zone settings are defined in the Global Zone Edit sub menu.

Zone Edit Sub Menu

Zone	LowNote	HighNote	Trnspose	VelCurve	MidiChan	Ports	BACK
1	C-2	G8	0	MEDIUM 1	KeybCHAN	KeybPORT	<---

Zone

There are 4 Keyboard zones available. Choose 1-4 to edit the corresponding keyboard zone.

Low Note / High Note

These set the Low and High note settings for each keyboard zone. These can be set using the standard way of moving any control below the entry on the LCD, or by pressing the desired note on the keyboard.

To use the keyboard to set the high and low note values, first touch a control below the corresponding entry on the LCD so that a square flashes next to the note value on the LCD. Now press the desired keyboard note.

Note that Zones can be set with the high and low notes overlapping, or set so that high note is adjacent to the low note of the next zone, or with a gap in between thus disabling an area of the keyboard.

Transpose - Trnspose

Sets the transpose amount in semitones for the keyboard zone (range -64 to +63 semitones).

Velocity Curve - VelCurve

Sets how the keyboard zone responds to incoming velocity (see previous page for more info)

MIDI Channel - MidiChan

Sets the output MIDI Channel for the selected zone.

Ports

Sets the output Ports for the selected zone.

Additional Zone Options

Pressing the illuminated page up button accesses additional zone options:

Zone	AfterTch	ExpPedal	SusPedal	PitchBnd	ModWheel	ChanPort	BACK
1	OFF	OFF	OFF	OFF	OFF	TEMPLATE	<---

Zone

This is a duplicate of the Zone setting on the first page of the Keyboard Zones Menu and selects the keyboard zone whose settings you are currently editing.

AfterTch ExpPedal SusPedal PitchBnd ModWheel

These options set whether or not aftertouch, expression pedal, sustain pedal, pitch bend and modulation wheel messages will be sent from the currently selected zone.

Each option can be set to ON or OFF.

For example, you may want to set the Sustain pedal to ON for all Zones, however, the Mod Wheel to be set to ON for just one zone.

Note that the SL MkII has a channel aftertouch mechanism (not polyphonic aftertouch) meaning that any keyboard key you press, whether it is within the zone range or not, will cause aftertouch messages to be sent using the MIDI channel and ports settings for the that zone.

Channel Port - ChanPort

This sets whether these control messages are included in the keyboard zones or not as follows:

Template

The above controls follow the individual settings as set in Edit mode. The settings in the Keyboard Zones menu are ignored.

Zone

The above controls follow the individual settings as set in Keyboard Zones menu. The settings in the Edit menu are ignored.

Template Routing Sub Menu

KeybChan	KeybPort	ComnChan	ComnPort	BACK
1	U1	16	U3 M1	<---

Although it is possible for the user to edit the Automap Template from the SL MkII, editing the following settings for the Automap Template should NOT be done.

Keyboard Channel, Keyboard Port - KeybChan, KeybPort

These settings define which MIDI Channel and Port the Keyboard, Mod / Pitch Joystick, Sustain and Expression pedals are sent to.

Note that these settings do not take effect if Zones are active.

Common Channel, Common Port - ComnChan, ComnPort

These settings define which MIDI Channel and Port the all Pots, Encoder, Sliders, Buttons and XY pad are sent to.

Both Keyboard and Common settings (above) provide a way of changing the routing of multiple controls from one knob. For example, in control **edit** options (see final chapter) setting each individual control to Common Channel and Common Port, rather than a specific Channel and Port, means that to change the Channel and Port of all controls is done via the routing sub menu (above) rather than editing each individual controls routing.

Template Grouping Sub Menu

Template	Position	Size	BACK
---			<---

Template

This displays the template that is currently being edited.

Position, Size

Multiple templates can be grouped together. The Position and Size values show how multiple templates are grouped. These values can be changed (i.e. to group and un-group) templates.

Note:

Grouped templates must first be saved in adjacent positions.

Position and size values must be correct for changes to be saved.

E.g. for a group of 3 templates there must be 3 adjacent templates, each set to a size of 3, and with positions of 1, 2, 3 respectively.

Remember, for changes to be saved, the **write** button needs to be pressed for all templates in the group.

To step through templates within a group press any of the row select buttons multiple times.

Control Edit Overview

Creating and Editing Advanced Mode Templates from the SL MkII.

Please note that we strongly advise you not to edit the Automap template.

To enter Control Edit Mode, Press and HOLD the **edit** button. Now touch or press any control on the SL. The name of the control you have just touched will be displayed on-screen.

Note that Control Edit will also work for the last-moved control. i.e. move a control, then press and hold edit and you will see that control on-screen.

When the **edit** button is released you will be able to set which MIDI messages are sent from each control, and how the control behaves – for example setting a button to toggle between settings or to step through a range.

The control edit menu options are dependant on the type of control and the type of the MIDI message – for example, options for buttons offer different options than options for encoders.

Full details on how to edit a template on the SL MkII are found in the final chapter of this user guide.

GLOBAL MENU BUTTON

The Global Menu is a set of options that affect the operation of the whole unit.



Options	Startup	Routing	GblZones	SendRcv	DrumPads	Calibrte
--->	--->	--->	--->	--->	--->	--->

Options Sub Menu

MemProt	Pick-up	DispTime	KeepVals	TouchSel	Transport	SusPedal	BACK
OFF	OFF	640 ms	ON	ON	TEMPLATE	AUTO	<---

Memory Protect - MemProt

Ensure this is set to 'OFF' if you want to overwrite your Templates. To prevent accidental overwriting of templates, set this to ON. Global settings can be saved regardless of whether this is set to 'ON' or 'OFF'.

Pot Pick-Up - Pick-Up

This sets the pot and slider response for all controls in all templates: The settings are ON or OFF, they work in the same way as described on page 22.

Note: Individual controls can have their own Pick-Up settings. The Global setting will be ignored unless the individual control is set to GLOBAL.

Display Timeout - DispTime

This sets the length of time that temporarily displayed information e.g. keyboard octave setting, remains on the SL MkII displays. Set the value between 0 and 1260ms, or to 'PERM' (permanent).

Keep Values - KeepVals

This applies to Advanced Mode (non-Automap) templates.

If this is set to 'ON' then the SL MkII will automatically store the value of each control when you switch away from the currently selected template and restore those values when you select that template again. If this is set to 'OFF' then the SL MkII will only store control values when you manually **write** the template.

Touch Select - Touch Sel

When set to on, the SL MkII's touch sensitivity is active for Automap and all Advanced Templates. Setting this to OFF means that touching a control no longer displays that control's row on the LCD screen.

Transport - Transprt

When the transport button is active, the transport buttons (re-wind, fast-forward, stop, play, loop, and record) can be set to have independent settings for each template. For example, some MIDI hardware may respond to MMC (which is the default for most Advanced Templates), but other hardware may respond to different MIDI messages for transport control.

When set to TEMPLATE, each template can have independent transport settings.

When set to GLOBAL, no matter what template you are using, the transport settings will be the same.

As default, the Global Transport settings are set to communicate with the Automap Server (which then sends Rewire transport messages to software), however Global Transport settings can be edited. When this option is set to GLOBAL, editing the transport control parameters from any template will affect the transport controls globally.

Sustain Pedal Polarity - SusPedal

The sustain pedal polarity can be changed here. The options are NormCLSD, NormOPN and Auto. If your sustain pedal is behaving the wrong way (i.e. a press on the pedal results in 'open' rather than 'closed') then set the option to NormCLSD. If your pedal works correctly then set the option to NormOPN. Setting the option to AUTO means that the SL scans the sustain pedal port on boot up. It will presume that the pedal is in the Open position, and set the sustain pedal polarity accordingly.

Start-up Sub Menu

Startup	StartTmp	AutoDemo	BACK
Automap	1	OFF	<---

Start-up - Startup

Select whether the SL MkII will boot up in Automap mode or in Advanced mode

Start Template - StartTmp

If Template is selected in the startup option, then select the template number that will load on bootup.

Automatic Demonstration - AutoDemo

When set to ON, the SL MkII will run through a demo routine when booting up. Set AutoDemo to OFF to disable this feature.

Routing Sub Menu

USB1To	MIDITo	MClick-Out	MClick-In	BPMPort	PRCGChan	PRCGPort	BACK
M1 M2	U1 M1 M2	U1 M1	AUTO	ON	Chan 1	OFF	<---

The following abbreviations are used in the Routing menu:

U1: USB Port 1

U2: USB Port 2

M1: MIDI OUT Port 1

M2: MIDI OUT Port 2

USB Port 1 To - USB1To

MIDI data sent from the computer on USB port 1 can be routed to MIDI output port 1 and / or 2.

USB port1 will be displayed as 'SL Mk II (port1)' when selecting the output port from your DAW software.

MIDI To - MIDITo

MIDI data received at the MIDI In port on the back of the SL MkII can be routed to either USB ports and / or either MIDI Out ports.

MIDI Clock Output - MClick-Out

MIDI Clock output destination can be set to any, or a combination of the following:

M1, M2, U1, U2.

MIDI Clock Input - MClk-In

MIDI Clock input source can be set to any of the following:

AUTO – automatically selects the input port if there is MIDI Clock detected on that port. If there is not external MIDI Clock detected the SL will revert to the Internal Clock.

INTERNAL - the SL will use the Internal Clock

EXT-AUTO - automatically selects the input port if there is MIDI Clock detected on that port. If there is not external MIDI Clock detected the SL will revert to it's internal Clock.

Or any of the following options:

MIDI-IN

USB1

USB2

BPMPort

This sets whether or not ReWire BPM messages are sent to your computer when you use the TAP TEMPO button or manually set the tempo from the Quick Menu.

These messages are used for tempo control over your sequencer from the SL MkII but they will only have an effect when the Automap server software is running. This should be set to 'OFF' if you do not want to control the tempo in your sequencer from the SL MkII using ReWire.

Program Change Channel and Port Input - PRCGChan and PRCGPort

The SL can be set up so that Program change messages from an external device (or your computer) are used to change the template on the SL. This can be useful in both Live and studio situations when switching between various set-ups. The SL will respond to Program change messages 1-32 for Advanced Mode templates 1-32 and a Program change message of 33 for Automap Mode.

PRCGChan and PRCGPort define which MIDI channel and input port are to be used to receive these program change messages.

Global Zones Sub Menu - GlbZones

GlbZone	ZoneEdit	BACK
OFF	--->	<---

Zone	LowNote	HighNote	Trnspose	VelCurve	MidiChan	Ports	BACK
1	C-2	G8	0	MEDIUM 1	KeybCHAN	KeybPORT	<---

This menu has the same options as the Zones settings in the Template edit menu, but is used to set zones globally rather than for a specific template. Please refer to page 22 for more details.

Send and Receive Sub Menu - SendRcv

Template	Dump	Send	Ports	MIDI	O/S	USB1 OS	BACK
1	ALL	Globals	U1	Send	Receive	Receive	<---

Template, Dump

The first two options on this page allow you to dump templates in sysex format from the SL MkII to your computer or another MIDI device for backing up. The first option allows you to dump a single template. Rotate the encoder to select which template you want to dump (range is Current, 1-33), then press the button above the encoder to send the template. If you edit a template but do not save it, the edited version can be dumped by selecting 'Current' instead of the template number. Selecting the template number will dump the version stored in the SL MkII's flash memory (i.e. whether the template has been saved or not). Press the button below 'All' to send all templates.

Send Globals

Press the button to dump the global settings in sysex format.

Ports

This option sets where template and global sysex dumps are sent to.

MIDI O/S Send, Receive

Press the buttons below 'Send' or 'Receive' on the left-hand display to transmit or listen for an operating system (OS) dump on the MIDI IN and OUT connectors on the back of the SL MkII. You will be asked to confirm that you want to dump or update the OS before it will transmit or accept an OS dump.

USB1 OS Receive

Press the button below 'USB1 O/S Receive' on the left-hand display to prepare the SL MkII to receive an OS sysex dump from a computer on USB port 1. You will be asked to confirm that you want to update the OS before it will accept an OS dump.

Drum Pad Calibration Sub Menu - DrumPads

DrumPad Calibration	BACK
use the PAGE buttons to scroll through calibration set-up	<---

To begin the drum pad calibration press the **P1** up button.

---	---	---	---	---	---	---	---
64	64	64	64	64	64	64	64

The eight values across the left-hand display correspond to drum pads 1-8. The pad hit velocity value is shown on the top line ('---' if the pad has not yet been hit) and the calibration value is shown on the bottom line. This first page is for full velocity (maximum strength hit) calibration:

Hit a pad at full strength to check the current calibration. If the hit velocity value above the pad goes to 127 too easily, decrease the pad calibration value using the encoder or buttons underneath. This will reduce the sensitivity of the pad, meaning you need to hit it harder to reach maximum velocity.

Once all 8 drum pads have been set for maximum velocity calibration, press the **P1** up button again for soft hit calibration:

---	---	---	---	---	---	---	---
20	20	20	20	20	20	20	20

Hit a pad softly and view the hit velocity value. If the value does not update when you hit the pad then the threshold is too high. Use the encoders to adjust the threshold values. Lowering the threshold will increase the sensitivity of the pad meaning that it will respond to a softer hit.

Calibration Sub Menu - Calibrate

Pitch Joy Mod	Read	Atch	Set	Power	BACK
---	---	---	---	USB	<---

Joystick Calibration

To calibrate the pitch/mod joystick slowly move it from the centre to fully left, then to fully right and back to the centre again. Do not force the wheel at the end of its travel. Repeat this and look at the value under 'Pitch' on the SL MkII display. It should now reach 0 when the stick is fully left, 255 when it is fully right and 128 when it is at rest in the centre.

Next slowly move the joystick from the bottom, up to the top and then back to the bottom again. Do not force it at the end of its travel. Repeat this and look at the value under 'Mod' on the SL MkII display. It should now reach 127 when the joystick reaches the top of its travel and 0 when it reaches the bottom.

Aftertouch Calibration

To calibrate the aftertouch press a keyboard key down with enough pressure to fully engage the aftertouch mechanism and hold the key in that position. Whilst holding the key down, use encoder 4 to increase the 'Set' value from 0. Whilst increasing the 'Set' value watch the 'Read' value, which will automatically start increasing from 0. As soon as the 'Read' value reaches 127 stop increasing the 'Set' value and release the key. Try fully pressing some other keys to make sure that the 'Read' value reaches 127 when the aftertouch mechanism is fully engaged. If it does not reach 127 then increase the 'Set' value so that it does (it may only require an increase of 1 or 2).

Keyboard Size Calibration

This option is not displayed on the LCD, but a further calibration available on this page is setting the keyboard size of your unit. Press the bottom and top keyboard keys at the same time. 'Octaves' and the number of octaves on the keyboard (2, 3 or 5) will appear on the display to show that the SL MkII has recognised the correct keyboard size. This should only need to be done if the LCD shows the incorrect number of octaves when the SL MkII is powering up.

Power

The power source is displayed underneath 'Power'; 'USB', 'PSU' will be shown. The power source cannot be set from the Global menu. Use the power select switch on the back of the SL MkII to set the power source.

WRITING GLOBAL SETTINGS



To save all global settings, press the WRITE button whilst in the Global menu. It is important to do this after calibrating the joystick, aftertouch, keyboard size or drum pads. Remember that global settings can be saved regardless of whether memory protect is set to 'ON' or 'OFF'.

TRANSPORT



The second row of buttons below the sliders can either be used as transport control, or for use within the current template (either as Automap or Advanced mode MIDI buttons).

When lit, the buttons will be available as transport controls. This will also be indicated in the Automap HUD when in Automap Mode.

In Advanced Mode you can edit the MIDI message the Transport Buttons send in the same way as any other control.

CREATING AND EDITING ADVANCED MODE TEMPLATES FROM THE SL: DETAILED INFORMATION

PLEASE REMEMBER THAT ALL TEMPLATE EDITING MUST BE SAVED BEFORE YOU CHANGE TEMPLATE OR TURN OFF YOUR SL MKII OTHERWISE ANY CHANGES MAYBE LOST.

When you have finished editing you should remember to press the **write** button. The LCD displays the option to rename the template and choose the template position. Then press **write** again to finish saving.

MIDI message Assignment Table

The following table shows which MIDI messages can be assigned to the various physical controls on the SL.

	Encoders	Pots	Sliders	Buttons (inc. transport)	Drum Pads	Joystick – horizontal (pitch) axis	Joystick – vertical (mod) axis	X-Y touchpad	Sustain Pedal	Expression Pedal
CC (Control Change)	0	0	0	0	0	0	0	0	0	0
14 bit CC	0									
NRPN	0	0	0	0	0	0	0	0	0	0
RPN	0	0	0	0	0	0	0	0	0	0
Sysex	0	0	0	0	0	0	0	0	0	0
MMC				0	0				0	
Note On/Off				0					0	
Program Change				0	0				0	
Bank Change				0	0				0	
Drum Note					0					
System Real Time				0	0				0	
Pitch Bend						0		0		
Template Select				0	0				0	

Once you have chosen the type of MIDI message you want a control to send, you can adjust the rest of the settings for that control. The available settings will depend on what Control is set to. The following is a guide to each of settings available for the different Control options.

Follow through the section for Control Change (CC) first of all as these are the most commonly used MIDI messages for parameter control and also many of the settings for 'CC' apply to the other Control options too:

CONTROL CHANGE (CC)

DispType (Display Type): This setting allows you to select how the value for the control is displayed on the SL. For encoders it can also be used to change the mode of operation. The options are:

0-127: Control value displayed with range 0 to 127. This is best suited to a parameter with a single direction increase/decrease e.g. track volume.

-64/+63: Control value displayed with range -64 to +63. This is best suited to a parameter with a bi-directional increase/decrease (zero position in the middle) e.g. track pan.

ADDITIONAL OPTIONS FOR ENCODERS ONLY

REL1 (Relative 1): A message with value 65 is sent out for every clockwise step (increment) and a message with value 63 is sent out for every anti-clockwise step (decrement). With this option the encoder functions as a true endless control rather than emulates an analogue pot as with the 0-127 and -64/+63 settings.

REL2 (Relative 2): This is similar to the 'REL1' setting however it includes encoder acceleration. A message with value $64+n$ is sent out for every clockwise step (increment) and a message with value $64-n$ is sent out for every anti-clockwise step (decrement). The value n depends on how fast you rotate the encoder. It will be 1 when you rotate it slowly and get larger the faster you rotate it, meaning that you can scale the full range of a parameter with a small quick turn of an encoder.

0-16K (14-bit mode): MIDI data values are transmitted as a 7-bit binary number, allowing a maximum value range of 0-127. The MIDI Specification allows for two MIDI control messages to be sent together where the data values form an MSB (most significant byte) and LSB (least significant byte) pair, making a 14-bit binary number and allowing a maximum value range of 0-16383. This is useful where fine control over a parameter is required, however the parameter you are controlling must be able to receive 14-bit MIDI values. If you want to send 14-bit values for fine control over a parameter then set DispType to '0-16K'. For CC controls, the MIDI Specification only allows for CC numbers 0 to 31 to be used in this way. Two CC messages are sent when the value of a parameter is changed – the first with the MSB value and the second with the LSB value. To enable the receiving device to distinguish between which CC message has the MSB value and which has the LSB value, the LSB value message is sent using a different CC number, calculated by adding 32 to the original CC number. Consequently CC numbers 32 to 63 are used for sending the LSB value in 0-16K (14-bit) mode. As an example, if a CC encoder has DispType set to '0-16K' and CC Num set to 0 then, for each encoder step, two messages will be sent – a CC0 message with the MSB value and a CC32 message with the LSB value. The important point to note is that if an encoder has Control set to 'CC' and DispType set to '0-16K' then CC Num should only be set from 0 through 31 and not higher.

APOT: This is a variation of 'REL2' and is the same system that is used by some other existing popular control surfaces. A message with value $0+n$ is sent out for every clockwise step (increment) and a message with value $64+n$ is sent out for every anti-clockwise step (decrement). The value n will equal 1 when you rotate the encoder slowly and increases as you rotate the encoder faster.

Additional option for when Control is set to 'NoContrl':

LABEL: If a control is not assigned to send a MIDI message then there will be a blank space above it on the display. You can however use that blank space to display up to 8 characters (on the top line of the display) by setting DispType to 'LABEL'. If this is set, the control name will be displayed, even though the control is not assigned to anything. You can edit the control name by scrolling up to the second page of options in Edit mode (see below for further info on editing control names).

Value Range: These options allow you to set the upper and lower limits of the control value. By default the Low Value will be set to the lowest possible value and the High Value will be set to the highest possible value. In this case the control will affect a parameter throughout its whole range. Adjust these settings if you want the control on the SL MkII to affect a parameter though only part of its range.

The range of values allowed for both of these settings will depend on the DispType setting as follows:

DispType	Range for LowVal and HighVal settings
0-127	0 to 127
-64/+63	-64 to +63
REL1	Not applicable
REL2	Not applicable
0-16K	0 to 16383
APOT	Not applicable
ON/OFF	0 to 127
LED	0 to 127

With an encoder or pot, the control value will scale from the Low Value to the High Value as you rotate it clockwise. Consequently if you want the control value to increase as you rotate the encoder clockwise, make sure the High Value is larger than the Low Value. If you want the control value to decrease as you rotate the encoder clockwise (inverted action), make the Low Value larger than the High Value. It is possible to invert the action of the sliders, joystick, X-Y touchpad and the expression pedal in this way.

ADDITIONAL OPTIONS FOR BUTTONS ONLY

DispType (Display Type): Control value displayed as either ON or OFF. The low value setting determines the ON value and the high value setting determines the OFF value. This is best suited to a bi-state parameter where you want to see whether it is in an on or off state e.g. phase reverse on a mixer channel.

LED: This is like ON/OFF except that nothing is displayed when the control is in an OFF state.

ON/OFF & LED display types should be used with control type Momentary or Toggle.

For buttons, drum pads and the sustain pedal, the Press Value and Release Value should be set in conjunction with the BtnType (Button Type) setting (see below).

BtnType (Button Type): This setting is only available for buttons, drum pads and the sustain pedal. Where available, it can be found on the second page of control settings so scroll up to access it.

It should be set in conjunction with the Press and Release values for the control to determine how the button works. The options are as follows:

NORMAL: The Press Value is sent when the button is pressed, nothing is sent on release.

MOMENTRY: The Press Value is sent when the button is pressed and the Release Value is sent when the button is released.

TOGGLE: The Press1 Value is sent when the button is first pressed, nothing is sent on release. The Press2 Value is sent on the next button press, nothing is sent on release. The Low and High Values will be sent alternately on further button presses. This setting is useful when you want to control a bi-state parameter such as Track Solo On/Off.

STEP: If this option is selected then an extra setting, StepVal (Step Value), will appear next to BtnType. With the 'STEP' option, the value sent each time the button is pressed will step from the From Value to the To Value in steps whose size are determined by the StepVal setting. When the To Val is reached the next button press will cause the From Val to be sent and the value will step up again on subsequent presses. Note that the To Value is always sent before returning to the From Value, even if it takes a jump less than the step size to reach the To Value. For example if a button had the settings From Value 0, To Value 16 and Step Value 5 then on alternate button presses the value sent would be 0, 5, 10, 15, 16, 0, 5.... If you want a button to step down instead of up then make the From Value larger than the To.

The 'MOMENTRY' option is not available for the drum pads because they only respond to a hit and do not have a mechanism to detect when you release your finger from them. Instead of 'MOMENTRY' they have a special 'VELOCITY' option. When this is set, the value sent out when you hit the pad will depend on how hard you hit it. The control value is still constrained within the Low Value and High Value settings. As an example if Low Value is 0 and High Value is 127 then a soft hit will give a value near 0, a medium hit will give a value near 64 and a hard hit will give a value near 127. If Low Value is 2 and High Value is 0 then a soft hit will give value 2, a medium hit will give value 1 and a hard hit will give 0.

GENERAL CONTROL EDIT SETTINGS

Ports: This sets the port routing for the control i.e. where the MIDI messages generated by the control are routed to when it is operated. The settings can be a combination of: M1, M2, U1, U2

or

KeybPORT: Sent to the Keyboard Port – as set in the Template **edit** menu.

ComnPORT: Sent to the Common Port – as set in the Template **edit** menu.

'KeybPORT' and 'ComnPORT' are special options that allow the port routing for the control to follow one of two common routing settings that can be accessed from the Template **edit** menu (Keyboard Port and Common Port). The advantage presented by these options is that if a number of controls are set to either 'KeybPORT' or 'ComnPORT' then you can change the port routing for all of those controls by editing a single parameter, rather than editing the individual setting for each control. More information on the Keyboard Port and Common Port routing settings can be found in the page 24.

MidiChan (MIDI Channel): This option sets the MIDI Channel on which the data will be transmitted. This can be set to a value between 1 and 16, or to 'KeybCHAN' or 'ComnCHAN'. Like the 'KeybPORT' and 'ComnPORT' options for the Ports setting, 'KeybCHAN' and 'ComnCHAN' are special options which allow the MIDI Channel setting for the control to follow one of two common MIDI Channel settings which can be accessed from the template **edit** menu (Keyboard Channel and Common Channel). More information on the Keyboard Channel and Common Channel routing settings can be found in page 24.

CC Num (Control Change Number): This allows you to set the Control Change (CC) number for the control to a value from 0 through 127. You can toggle the display format of the CC Num setting between decimal and hexadecimal by pressing the ROW-SELECT button for the upper left-hand row of buttons.

Pick-Up: This setting is only available for pots, sliders, the pitch/mod joystick and the expression pedal. Where available, it can be found on the second page of control settings so scroll up to access it. It allows you to set the response of the control to one of the following:

ON: After selecting a template, if the current position of a control does not match the value of the control stored with the template, the control will not have any effect when operated until its position matches the value stored with the template.

OFF: After selecting a template, if the current position of a control does not match the value of the control stored with the template, the control value will "jump" from the stored value to match the position of the control as soon as the control is operated.

GLOBAL: The control will follow the Pick-Up setting in the Global menu, which can be set to 'ON' or 'OFF'. The advantage presented by this option is that the response of some or all controls in multiple templates can be changed by editing a single parameter, rather than editing the individual setting for each control.

TEMPLATE: The control will follow the Pick-Up setting in the Template menu, which can be set to 'ON' or 'OFF'. The advantage presented by this option is that the response of some or all controls in a template can be changed by editing a single parameter, rather than editing the individual setting for each control.

XY PAD

AXIS CONTROL



This picture show how the XY pad operates. Two MIDI messages can be sent on each axis.

SELECTING THE AXIS FOR EDITING



This picture shows how to access the regions of the XY pad for EDITING ONLY. Note: When using the XY pad, then X1 and X2 both work along the X axis, and Y2 and Y2 on the Y axis.

TchMode (Touch Pad Mode): This setting is only available for the X-Y touchpad.

Where available, it can be found on the second page of control settings so scroll up to access it. It allows you to set how the value for the selected axis behaved when you remove your finger from the touchpad as follows:

X1 and X2 axes:

HOLD: Value remains the same

HomeLeft: Value returns to the Low Value

HomeCntr (Home Centre): Value returns to the centre of the control value range

HomeRight (Home Right): Value returns to the High Value

Y1 and Y2 axes:

HOLD: Value remains the same

HomeDown: Value returns to the Low Value

HomeCntr (Home Centre): Value returns to the centre of the control value range

HomeUp: Value returns to the High Value

Name: This setting can be found on the second page of control settings so scroll up to access it. Here you can set the name for the control that appears on the SL MkII displays. The control name can be a maximum of 8 characters long. To enter a character first use the encoders or buttons in line with the '<' and '>' symbols on the display to move the cursor to where you want to enter the character. Then use the buttons in line with 'Upper', 'Lower' and 'Punctu'/'Number' to select the type of character you want to enter (upper case, lower case, punctuation or number). Note that repeated presses of the button below 'Punctu'/'Number' will switch between 'Punctu' and 'Number'. Finally use the encoder, pot or buttons in line with 'CHAR' to select the character you want to enter. If you want to enter a space then select 'Punctu', as the first punctuation character is a blank space.

NON-REGISTERED PARAMETER NUMBER (NRPN)

The DispType, LowVal, HighVal, Ports, MidiChan, Response, BtnType, TchMode and Name settings are the same as for Control Change (CC) so see the previous section for information on these settings.

NRPN lsb (Non-Registered Parameter Number Least Significant Byte): This allows you to set the NRPN lsb value for the control to a value from 0 through 127.

NRPN msb (Non-Registered Parameter Number Most Significant Byte): This allows you to set the NRPN msb value for the control to a value from 0 through 127.

You can toggle the display format of the NRPN lsb and NRPN msb settings between decimal and hexadecimal by pressing the row select button for the upper left-hand row of buttons.

REGISTERED PARAMETER NUMBER (RPN)

The DispType, LowVal, HighVal, Ports, MidiChan, Response, BtnType, TchMode and Name settings are the same as for Control Change (CC) so see that section for information on these settings.

RPN lsb (Registered Parameter Number Least Significant Byte): This allows you to set the RPN lsb value for the control to a value from 0 through 127.

RPN msb (Registered Parameter Number Most Significant Byte): This allows you to set the RPN msb value for the control to a value from 0 through 127.

You can toggle the display format of the RPN lsb and RPN msb settings between decimal and hexadecimal by pressing the row select button for the upper left-hand row of buttons.

SYSTEM EXCLUSIVE (SYSEX)

The LowVal, HighVal, Ports, MidiChan, Response, BtnType, TchMode and Name settings are the same as for Control Change (CC) so see that section for information on these settings.

DispType (DisplayType): The options for this setting are the same as for CC however the 'REL1', 'REL2' and 'APOT' display types are not available for encoders.

Length: This determines the length of the sysex message sent when the control is operated. The value sets the number of bytes and is variable between 0 and 12, or 9 and 12 for ROLAND type sysex messages.

DataType: This allows you to set the format of the sysex message as follows:

NONE: Sysex message does not contain a variable byte and a fixed message is sent every time the control is operated.

SINGLE: Sysex message contains one variable byte. The value of this byte is determined by the current control value and limited by the Low Value and High Value settings. The position of the variable byte in the sysex message can be edited.

ROLAND: Sysex message contains one variable byte and one checksum byte. The value of the variable byte is determined by the current control value and limited by the Low Value and High Value settings. The format of the sysex message is fixed such that the second-to-last byte is always the variable byte and the last byte is always the checksum byte (excluding the F7 byte).

If an encoder has DispType set to 'O-16K' then the options for DataType are as follows:

NONE: Sysex message does not contain a variable byte and a fixed message is sent every time the control is operated.

LSB-MSB: Sysex message contains two variable bytes which form an MSB and LSB pair, allowing a 14-bit value to be transmitted. The LSB precedes the MSB in the sysex message. The two bytes cannot be separated by non-variable bytes but the position of the pair of bytes in the message can be edited.

MSB-LSB: This is the same as LSB-MSB except the MSB precedes the LSB in the sysex string.

ROLAND: Sysex message contains two variable bytes and one checksum byte. The format of the message is fixed such that the last three bytes of the string are always MSB, then LSB and then checksum (excluding the F7 byte).

DataPsn (Data Position): This allows you to set the position of the variable data byte(s) in the sysex message. This value will automatically be constrained by the Length setting. Note that if DataType is set to ROLAND then this value will be fixed, as the format of ROLAND sysex messages cannot be edited.

To edit the value of each of the non-variable bytes in the sysex message scroll up to the sysex message page. All bytes are displayed in hexadecimal format. By default the SL MkII will place an FOh at the start and F7h at the end of the message and set all other non-variable bytes to 00h. Variable bytes appear as 'DV' and a checksum byte will appear as 'CS' - these cannot be edited.

To edit a byte use the buttons or encoders in line with the '<<' and '>>' symbols to navigate the cursor to the desired byte and then use the buttons, encoder or pot in line with 'VALUE' to set the value (range 00 to 7F). Scroll down after editing the sysex message to return to the control settings.

MIDI MACHINE CONTROL (MMC)

MMC messages are primarily used for transport control.

The Ports setting is the same as for Control Change (CC) so see that section for information on these settings.

Command: This sets the type of MMC command that the control will transmit from the following options: STOP, PLAY, DEF PLAY (deferred play), FORWARD, REWIND, RECORD, REC EXIT (record exit), REC PSE (record pause), PAUSE, EJECT, CHASE, ERRRESET (error reset), MMCRESET.

DeviceID: This sets the Device ID number transmitted in the MMC command message (range 0-127).

NOTE ON/OFF (NOTE)

The Ports, MidiChan, and Name settings are the same as for Control Change (CC) so see that section for information on these settings.

Note: This sets the MIDI note value that the control will transmit (range C-2 to G8). The Note setting will be displayed as a MIDI note value by default but you can toggle the display format between note value, decimal and hexadecimal by pressing the ENCODER ROW-SELECT button. The note value can be set using the buttons, encoder and pot in line with the Note setting or by pressing a key on the keyboard. To enable keyboard entry of the note value either press the ROW-SELECT BUTTON for the lower left-hand row of buttons or edit the note value using one of the buttons or encoder in line with the setting. A flashing cursor will then appear by the note value to indicate that you can edit it using the keyboard.

Velocity: This sets the velocity value sent with the note on message (range 0-127).

BtnType (Button Type): This is exactly as described for Control Change (CC) however the 'STEP' option is not available. If this is set to 'MOMENTRY' then the button will send a note on message when pressed and a note off message when released. If this is set to 'TOGGLE' then alternate presses of the button will send note on and off messages.

BANK CHANGE (BANK CHG)

The Ports, MidiChan and Name settings are the same as for Control Change (CC) so see that section for information on these settings.

BankMode: This determines the format of the bank change message that is sent. CC numbers 0 and 32 are reserved for bank selection in the MIDI Specification. CCO messages are used for coarse bank selection (Bank MSB) and CC32 for fine bank selection (Bank LSB). As an example, a synth may accept CCO messages to select different categories of sounds e.g. keyboard instruments and then CC32 to select different sub-categories e.g. acoustic piano. Some synths however do not respond to CCO messages and some do not respond to CC32 messages. You should check the manual for the synth to which you are sending the bank change message to find out what the required format for bank change messages is and then set BankMode accordingly to one of the following options:

LSB: A single CC32 message is sent whose value is determined by the Banklsb setting (see below).

MSB: A single CCO message is sent whose value is determined by the Bankmsb setting (see below).

MSB-LSB: A CCO message followed by a CC32 message is sent. The values are determined by the Bankmsb and Banklsb settings (see below).

Banklsb: This determines the bank least significant byte value i.e. the value of the CC32 message.

Bankmsb: This determines the bank most significant byte value i.e. the value of the CCO message.

PROGRAM CHANGE (PROG CHG)

The Ports, MidiChan, BtnType and Name settings are the same as for Control Change (CC) so see that section for information on these settings. Also, Bank messages have now been included also (see above).

LowProg and HighProg: These are like the Low Value and High Value settings but instead they define the Low and High Program Change number. They should be set in conjunction with the BtnType setting as described in the Control Change (CC) section. This way you can use a button to select a single program/patch, toggle between two different programs/patches or step through a whole bank of programs/patches on repeated presses. Note that the 'VELOCITY' option for drum pads is not available if Control is set to 'PROG CHG'.

DRUM PAD NOTE (DRUMNOTE)

This option only applies to the drum pads and allows you to set them up to send MIDI note data when hit. The velocity value sent is always dependent on how hard you hit the drum pads and cannot be set to a fixed value. The Ports, MidiChan and Name settings are the same as for Control Change (CC) so see that section for information on these settings.

Note: This is the same as for 'NOTE ON/OFF' so see that section for information on this setting.

Auto-Off: This sets the amount of time (in milliseconds) that a note off message is sent after the drum pad has been hit. It can be set to 'NONE', in which case a note off message is not sent at all, or from 10ms to 16383ms.

Off Sync: This sets the timing reference for the note off message that is sent after the drum pad has been hit. It can be set to 'TIMER', in which case the note off message will be transmitted after the number of milliseconds Auto-Off is set to (or if Auto-Off is set to 'NONE' no note off message will be sent at all). The other options allow you to set a note length, in which case the SL MkII will ignore the Auto-Off setting. Instead it uses MIDI clock as a timing reference and sends a note off message after the selected note length has passed. If you are recording notes into a sequencer then you will need to make sure that you are sending MIDI clock from the sequencer to the SL MkII and that the SL MkII is set to sync to incoming MIDI clock. The range of the note length setting ranges from 32nd triplet to 12 bars. When selecting a note length, 'T' indicates a triplet note length and 'D' indicates a dotted note length.

SYSTEM REAL TIME (REALTIME)

The Ports and Name settings are the same as for Control Change (CC) so see that section for information on these settings.

The available options for this setting are standard MIDI system real time messages: start (RT-Start), continue (RT-Contu), stop (RT-Stop), active sensing (RT-Actvs) and system reset (RT-Reset).

PITCH BEND (PITCHBND)

This option only applies to the X-Y touchpad and horizontal (pitch) axis of the joystick. No other controls on the SL MkII can be assigned to send pitch bend messages. There are no options for limiting the control value as this can be done on the instrument you are controlling by altering the pitch bend up/down range (if the option is available). The Ports, MidiChan and Name settings are the same as for Control Change (CC) so see that section for information on these settings.

TEMPLATE

This option is different to the others describe above in that it is not a type of MIDI message. Instead this option allows you to set any control button, drum pad or the sustain pedal to switch to another template on the SL MkII. No MIDI message is sent when you operate a Template control.