

SON
RESOLV **A Series**

ACTIVE STUDIO MONITOR

A5

A6

A8

A8
MONITOR

Owner's Manual

SAMSON®

Safety Instructions/Consignes de sécurité/Sicherheitsvorkehrungen/Instrucciones de seguridad



WARNING: To reduce the risk of fire or electric shock, do not expose this unit to rain or moisture. To reduce the hazard of electrical shock, do not remove cover or back. No user serviceable parts inside. Please refer all servicing to qualified personnel. The lightning flash with an arrowhead symbol within an equilateral triangle, is intended to alert the user to the presence of uninsulated "dangerous voltage" within the products enclosure that may be of sufficient magnitude to constitute a risk of electric shock to persons. The exclamation point within an equilateral triangle is intended to alert the user to the presence of important operating and maintenance (servicing) instructions in the literature accompanying the product.

Important Safety Instructions

1. Please read all instructions before operating the unit.
2. Keep these instructions for future reference.
3. Please heed all safety warnings.
4. Follow manufacturers instructions.
5. Do not use this unit near water or moisture.
6. Clean only with a damp cloth.
7. Do not block any of the ventilation openings. Install in accordance with the manufacturers instructions.
8. Do not install near any heat sources such as radiators, heat registers, stoves, or other apparatus (including amplifiers) that produce heat.
9. Do not defeat the safety purpose of the polarized or grounding-type plug. A polarized plug has two blades with one wider than the other. A grounding type plug has two blades and a third grounding prong. The wide blade or third prong is provided for your safety. When the provided plug does not fit your outlet, consult an electrician for replacement of the obsolete outlet.
10. Protect the power cord from being walked on and pinched particularly at plugs, convenience receptacles and at the point at which they exit from the unit.
11. Unplug this unit during lightning storms or when unused for long periods of time.
12. Refer all servicing to qualified personnel. Servicing is required when the unit has been damaged in any way, such as power supply cord or plug damage, or if liquid has been spilled or objects have fallen into the unit, the unit has been exposed to rain or moisture, does not operate normally, or has been dropped.

ACHTUNG: Um die Gefahr eines Brandes oder Stromschlags zu verringern, sollten Sie dieses Gerät weder Regen noch Feuchtigkeit aussetzen. Um die Gefahr eines Stromschlags zu verringern, sollten Sie weder Deckel noch Rückwand des Geräts entfernen. Im Innern befinden sich keine Teile, die vom Anwender gewartet werden können. Überlassen Sie die Wartung qualifiziertem Fachpersonal. Der Blitz mit Pfeilspitze im gleichseitigen Dreieck soll den Anwender vor nichtisolierter "gefährlicher Spannung" im Geräteinnern warnen. Diese Spannung kann so hoch sein, dass die Gefahr eines Stromschlags besteht. Das Ausrufezeichen im gleichseitigen Dreieck soll den Anwender auf wichtige Bedienungs- und Wartungsanleitungen aufmerksam machen, die im mitgelieferten Informationsmaterial näher beschrieben werden.

Wichtige Sicherheitsvorkehrungen

1. Lesen Sie alle Anleitungen, bevor Sie das Gerät in Betrieb nehmen.
2. Bewahren Sie diese Anleitungen für den späteren Gebrauch gut auf.
3. Bitte treffen Sie alle beschriebenen Sicherheitsvorkehrungen.
4. Befolgen Sie die Anleitungen des Herstellers.
5. Benutzen Sie das Gerät nicht in der Nähe von Wasser oder Feuchtigkeit.
6. Verwenden Sie zur Reinigung des Geräts nur ein feuchtes Tuch.
7. Blockieren Sie keine Belüftungsöffnungen. Nehmen Sie den Einbau des Geräts nur entsprechend den Anweisungen des Herstellers vor.
8. Bauen Sie das Gerät nicht in der Nähe von Wärmequellen wie Heizkörpern, Wärmeklappen, Öfen oder anderen Geräten (inklusive Verstärkern) ein, die Hitze erzeugen.
9. Setzen Sie die Sicherheitsfunktion des polarisierten oder geerdeten Steckers nicht außer Kraft. Ein polarisierter Stecker hat zwei flache, unterschiedlich breite Pole. Ein geerdeter Stecker hat zwei flache Pole und einen dritten Erdungsstift. Der breitere Pol oder der dritte Stift dient Ihrer Sicherheit. Wenn der vorhandene Stecker nicht in Ihre Steckdose passt, lassen Sie die veraltete Steckdose von einem Elektriker ersetzen.
10. Schützen Sie das Netzkabel dahingehend, dass niemand darüber laufen und es nicht geknickt werden kann. Achten Sie hierbei besonders auf Netzstecker, Mehrfachsteckdosen und den Kabelanschluss am Gerät.
11. Ziehen Sie den Netzstecker des Geräts bei Gewittern oder längeren Betriebspausen aus der Steckdose.
12. Überlassen Sie die Wartung qualifiziertem Fachpersonal. Eine Wartung ist notwendig, wenn das Gerät auf irgendeine Weise, beispielsweise am Kabel oder Netzstecker beschädigt wurde, oder wenn Flüssigkeiten oder Objekte in das Gerät gelangt sind, es Regen oder Feuchtigkeit ausgesetzt war, nicht mehr wie gewohnt betrieben werden kann oder fallen gelassen wurde.

ATTENTION: Pour éviter tout risque d'électrocution ou d'incendie, ne pas exposer cet appareil à la pluie ou à l'humidité. Pour éviter tout risque d'électrocution, ne pas ôter le couvercle ou le dos du boîtier. Cet appareil ne contient aucune pièce remplaçable par l'utilisateur. Confiez toutes les réparations à un personnel qualifié. Le signe avec un éclair dans un triangle prévient l'utilisateur de la présence d'une tension dangereuse et non isolée dans l'appareil. Cette tension constitue un risque d'électrocution. Le signe avec un point d'exclamation dans un triangle prévient l'utilisateur d'instructions importantes relatives à l'utilisation et à la maintenance du produit.

Consignes de sécurité importantes

1. Veuillez lire toutes les instructions avant d'utiliser l'appareil.
2. Conserver ces instructions pour toute lecture ultérieure.
3. Lisez avec attention toutes les consignes de sécurité.
4. Suivez les instructions du fabricant.
5. Ne pas utiliser cet appareil près d'une source liquide ou dans un lieu humide.
6. Nettoyez l'appareil uniquement avec un tissu humide.
7. Veillez à ne pas obstruer les fentes prévues pour la ventilation de l'appareil. Installez l'appareil selon les instructions du fabricant.
8. Ne pas installer près d'une source de chaleur (radiateurs, etc.) ou de tout équipement susceptible de générer de la chaleur (amplificateurs de puissance par exemple).
9. Ne pas retirer la terre du cordon secteur ou de la prise murale. Les fiches canadiennes avec polarisation (avec une lame plus large) ne doivent pas être modifiées. Si votre prise murale ne correspond pas au modèle fourni, consultez votre électricien.
10. Protégez le cordon secteur contre tous les dommages possibles (pincement, tension, torsion, etc.). Veillez à ce que le cordon secteur soit libre, en particulier à sa sortie du boîtier.
11. Déconnectez l'appareil du secteur en présence d'orage ou lors de périodes d'inutilisation prolongées.
12. Consultez un service de réparation qualifié pour tout dysfonctionnement (dommage sur le cordon secteur, baisse de performances, exposition à la pluie, projection liquide dans l'appareil, introduction d'un objet dans le boîtier, etc.).

PRECAUCION: Para reducir el riesgo de incendios o descargas, no permita que este aparato quede expuesto a la lluvia o la humedad. Para reducir el riesgo de descarga eléctrica, nunca quite la tapa ni el chasis. Dentro del aparato no hay piezas susceptibles de ser reparadas por el usuario. Dirija cualquier reparación al servicio técnico oficial. El símbolo del relámpago dentro del triángulo equilátero pretende advertir al usuario de la presencia de "voltajes peligrosos" no aislados dentro de la carcasa del producto, que pueden ser de la magnitud suficiente como para constituir un riesgo de descarga eléctrica a las personas. El símbolo de exclamación dentro del triángulo equilátero quiere advertirle de la existencia de importantes instrucciones de manejo y mantenimiento (reparaciones) en los documentos que se adjuntan con este aparato.

Instrucciones importantes de seguridad

1. Lea todo este manual de instrucciones antes de comenzar a usar la unidad.
2. Conserve estas instrucciones para cualquier consulta en el futuro.
3. Cumpla con todo lo indicado en las precauciones de seguridad.
4. Observe y siga todas las instrucciones del fabricante.
5. Nunca utilice este aparato cerca del agua o en lugares húmedos.
6. Limpie este aparato solo con un trapo suave y ligeramente humedecido.
7. No bloquee ninguna de las aberturas de ventilación. Instale este aparato de acuerdo a las instrucciones del fabricante.
8. No instale este aparato cerca de fuentes de calor como radiadores, calentadores, hornos u otros aparatos (incluyendo amplificadores) que produzcan calor.
9. No anule el sistema de seguridad del enchufe de tipo polarizado o con toma de tierra. Un enchufe polarizado tiene dos bornes, uno más ancho que el otro. Uno con toma de tierra tiene dos bornes normales y un tercero para la conexión a tierra. El borne ancho o el tercero se incluyen como medida de seguridad. Cuando el enchufe no encaje en su salida de corriente, llame a un electricista para que le cambie su salida anticuada.
10. Evite que el cable de corriente quede en una posición en la que pueda ser pisado o aplastado, especialmente en los enchufes, receptáculos y en el punto en el que salen de la unidad.
11. Desconecte de la corriente este aparato durante las tormentas eléctricas o cuando no lo vaya a usar durante un periodo de tiempo largo.
12. Dirija cualquier posible reparación solo al servicio técnico oficial. Deberá hacer que su aparato sea reparado cuando esté dañado de alguna forma, como si el cable de corriente o el enchufe están dañados, o si se han derramado líquidos o se ha introducido algún objeto dentro de la unidad, si esta ha quedado expuesta a la lluvia o la humedad, si no funciona normalmente o si ha caído al suelo.

Table of Contents

Introduction.	2
Resolv A Series Features	3
Resolv A Series Layout	4
Front View Layout	4
Rear Panel Layout - R8a.	5
Setting up the Resolv A Series	6
Background on the Resolv A Series Studio Reference Monitor	6
Positioning the Resolv A Series.	6
Connecting the Resolv A Series	8
Operating the Resolv A Series	9
Connecting to the Rubicon R10s Subwoofer	11
Resolv A Series Connections	12

Copyright 2008, Samson Technologies Corp.

Printed February, 2008 v1

Samson Technologies Corp.
45 Gilpin Avenue
Hauppauge, New York 11788-8816
Phone: 1-800-3-SAMSON (1-800-372-6766)
Fax: 631-784-2201
www.samsontech.com

Introduction

Thank you for purchasing the Resolv A Series Studio Reference Monitors from Samson Technologies! This manual covers the A5, A6 and A8 models. The Samson Resolv A Series are self-powered, near-field monitors featuring bi-amp power, superior electronics, robust woofers and advanced designed silk-dome tweeters. The careful engineering and proper implementation of these elements has resulted in a series of monitors with a linear response from bottom to top with tight lows and articulate highs. The A series features Samson's proprietary 1.25-inch silk-dome tweeter, with external heat sink and Ferrofluid cooling, produces accurate highs that are clear and precise. Plus, the top end is sweet, so the Resolv A series are easy to listen to, even during long mixing sessions. For low frequency response that's tight and controlled, the A series monitors feature woven carbon fiber woofers with butyl surrounds. The A5 features a 5-inch woofer, a 6.5-inch woofer is installed in the A6 and an 8-inch woofer in the A8. Each woofer employs a heavy-duty motor structure with large voice coils and magnets set on a sturdy metal frame. All Resolv A series monitors have on-board active electronics with bi-amped power, electronic crossovers and increased power supply with external heat sinks. With 50 watts of low frequency power and 20 watts for the high for the A5, and 75 watts of low frequency power and 25 watts for the highs on the A6 and A8, the Resolv series produce clean sound with low distortion even during loud monitoring. For expanded control, there is a rear panel High Frequency Level control allowing you to custom tailor the high frequency response for your installation or listening taste. The Resolv A series monitors are as easy to look at as they are to listen to. With their gloss black finished baffle, titanium finished waveguide and trim rings, the monitors complement most any studio décor. The Resolv A Series monitors provide an ideal near-field monitor system for studios, video post-production suites, fixed installations or where great sound is desired.

In these pages, you'll find a detailed description of the features of the Resolv A Series monitors, as well as a guided tour through its control panel, step-by-step instructions for its setup and use, and full specifications. You'll also find a warranty card enclosed—please don't forget to fill it out and mail it in so that you can receive online technical support and so we can send you updated information about these and other Samson products in the future. Also, be sure to check out our website (www.samsontech.com) for complete information about our full product line.

With proper care and adequate air circulation, your Resolv A Series will operate trouble free for many years. We recommend you record your serial number in the space provided below for future reference.

Serial number: _____

Date of purchase: _____

Should your unit ever require servicing, a Return Authorization number (RA) must be obtained before shipping your unit to Samson. Without this number, the unit will not be accepted. Please call Samson at 1-800-3SAMSON (1-800-372-6766) for a Return Authorization number prior to shipping your unit. Please retain the original packing materials and if possible, return the unit in the original carton and packing materials. If you purchased your Samson product outside the United States, please contact your local distributor for warranty information and service.

Resolv A Series Features

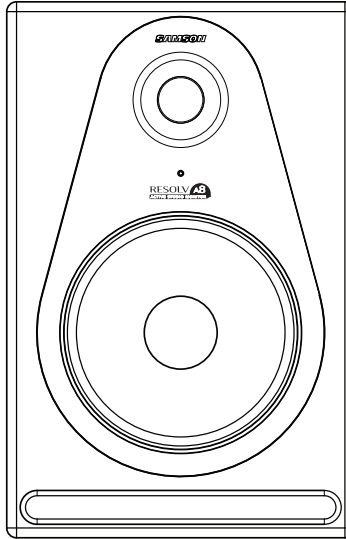

The Samson Resolv A Series reference monitors provide a smooth response that is accurate, and at the same time, pleasant to listen to. Here are some of their main features:

- Two-way, active studio monitor with ported, tuned enclosure, providing extremely accurate monitoring for recording studio, post-production and multi-media applications.
- The Resolv A Series employs woven carbon fiber, butyl surround woofers, and as a result, each monitor produces a tight and controlled low frequency response.
- 1.25-inch silk-dome tweeter with Ferrofluid cooled neodymium magnet, provides sweet and accurate high frequency response for the Resolv A series with low distortion.
- The Resolv A Series features active electronics including a Bi-Amp power amplifier with 50 watts of low frequency power and 20 watts for the high for the A5, and 75 watts of low frequency power and 25 watts for the highs on the A6 and A8.
- Four-position High Frequency Level control allows the listener to contour the response curve to custom tailor the response that works best in their mix environment.
- Active crossover utilizing a multi-pole design for linear response from bottom to top.
- Interfacing the monitors to most any -10 or +4db signal source is quick and easy thanks to the Resolv A series assortment of input connectors. The A5 has a balanced input on a TRS 1/4-inch jack and unbalanced input on an RCA jack and the A6 and A8 have balanced inputs on a TRS 1/4-inch jack and male XLR plus an unbalanced input on an RCA jack.
- A/V shielded for multimedia applications providing clean operation near computer monitors.
- MDF (Medium Density Fiberboard) construction, extremely rigid, delivering maximum SPL.
- The Resolv A series monitors fit in any décor and thanks to their black lacquer finished baffle and titanium appointments they provide an attractive enhancement to any control room.
- Three-year extended warranty.

Resolv A Series Layout

Front View Layout

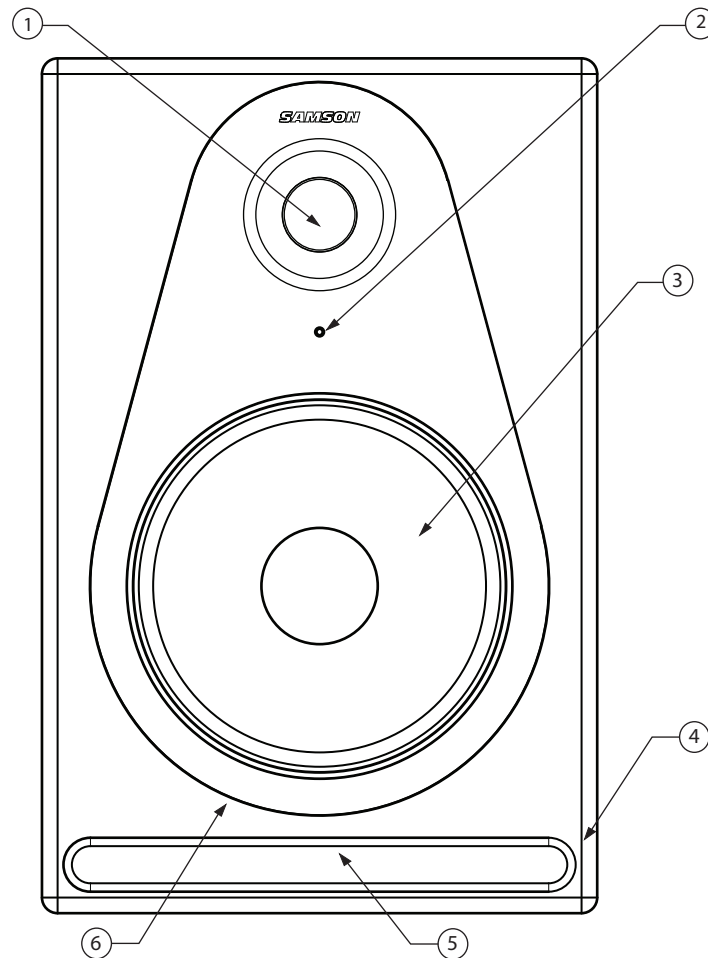

- 1. 1.25-INCH SILK-DOME TWEETER** – Silk-dome tweeter with Ferro fluid cooled neodymium magnet provides low distortion with a linear high frequency response resulting in a clear, precise and sweet top end.
- 2. POWER LED** - Red LED illuminates indicating the unit is powered on, ready for operation.
- 3. LOW FREQUENCY DRIVER** - Custom designed woven carbon fiber, copolymer butyl surround woofers providing each monitor with a tight and controlled low frequency response.
- 4. ENCLOSURE** - Rigid MDF construction.
- 5. TUNED PORT** - Quiet port design offering linear extended low frequency response.
- 6. FINISH** - Sleek black textured finish with gloss black baffle and titanium finished waveguide and trim ring.

Resolv A Series Layout

Rear Panel Layout - A8a

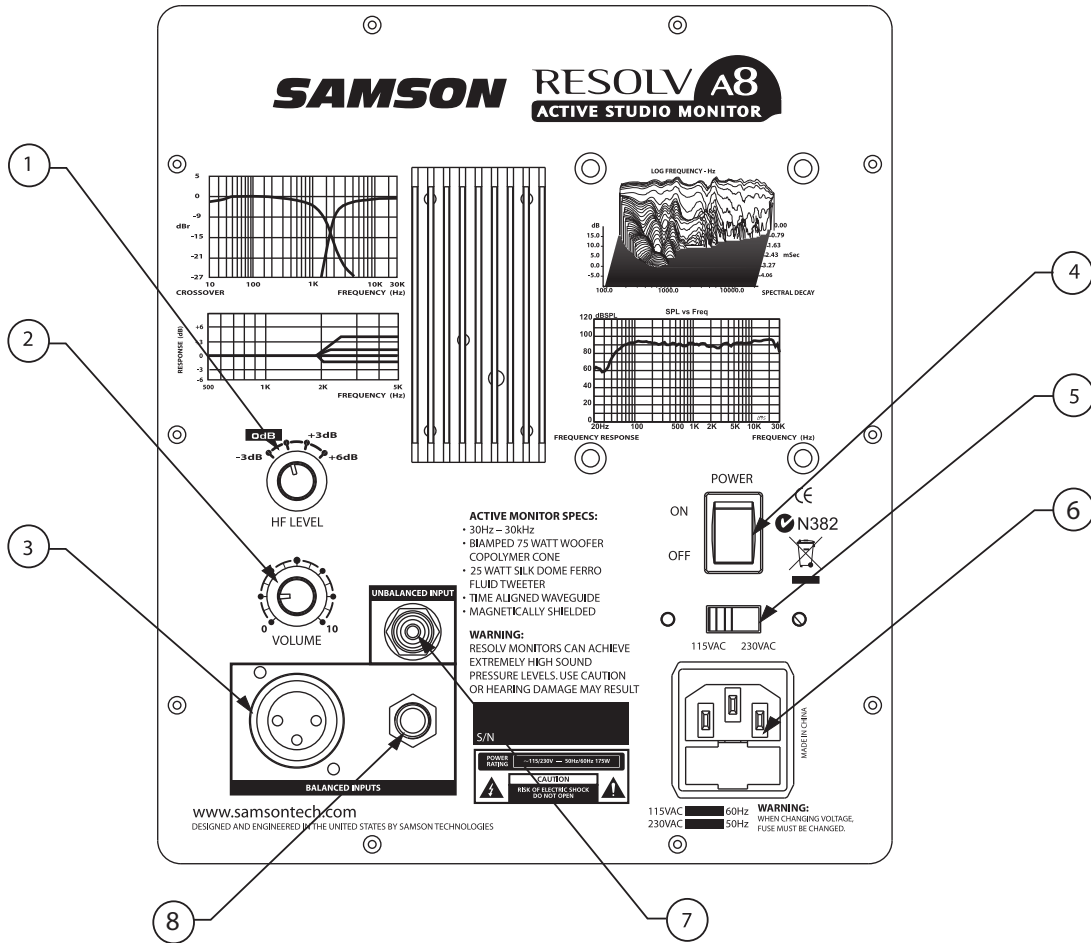

- 1. HIGH FREQUENCY LEVEL** – Four-position switch used to adjust the high frequency response (in 3dB increments).
- 2. VOLUME** - Controls the amount of output level.
- 3. XLR INPUT (A6 AND A8 ONLY)** - Balanced, +4dBu line level input is connected here via standard XLR (microphone) cable.
- 4. POWER SWITCH** – Main power switch.
- 5. VOLTAGE SWITCH** – Used to select the operating voltage.
NOTE: Be sure to check the voltage setting is correct for your country. Also, be sure to use the correct fuse type when changing the voltage.
- 6. AC INLET** - Connect the supplied IEC power cable here.
- 7. RCA** – Used to connect signals from unbalanced, –10dBV devices.
- 8. 1/4-INCH PHONE** – Balance TRS (Tip, Ring, Sleeve) 1/4-inch phone plug used to connect balanced or unbalanced +4dBu line level signals.

Setting up the Resolv A Series

Background on the Resolv A Series Studio Reference Monitor

The Resolv A Series are self-powered, 2-way, near-field reference monitors, featuring robust power, advanced electronics and custom designed drive units. For pristine highs, the Resolv A Series boasts a 1.25-inch silk dome tweeter, set upon a custom designed waveguide. The tweeter's voice coil is cooled with Ferrofluid and the use of an external heat sink adds to its increased power handling. The result is a wide, linear response producing high frequencies that are sweet, while clear and accurate. For the low frequency response, the Resolv A Series employs proprietary low frequency woofers with woven carbon fiber cones, butyl surrounds and heavy duty motors. The woofers are well matched to the tuned enclosures and provide punchy and focused bass frequency response. The monitors' crossovers have been carefully designed with high quality components insuring a linear frequency and phase response. The Resolv A Series enclosures are constructed from MDF (Medium Density Fiberboard) and are finished in scuff resistant, vinyl covering with painted gloss black baffles. The monitor's enclosures also include a tuned vent port that provides extended low-end response, and with a low turbulence design, the low frequency driver can move freely with minimal effect on the overall impedance. On the rear of the enclosure, you'll find the Resolv A Series control panel, which features a variety of input connections including both XLR balanced input, and a 1/4-inch TRS balanced input plus an RCA unbalanced input on the A6 and A8 and a 1/4-inch TRS balanced input plus an RCA unbalanced input on the A5. These inputs are connected to Resolv A Series internal active crossover and bi-amp power module providing 75 watts of power for the low frequency woofer and 25 watts of power to the high frequency tweeter on the A 6 and A8. The A5 bi-amp power module provides 50 watts of power for the low frequency woofer and 20 watts of power to the high frequency tweeter. You will also find the pre-amp controls, including Volume knob, used to adjust the overall level of the internal power amplifier, as well as the innovative High Frequency Level control. This four-position switch allows the mix engineer to contour the high frequency response of the monitor thus allowing you to adjust for room acoustics or listening preference. The Resolv A Series has been designed to provide flat, accurate monitoring, and at the same time, to provide an adjustable response curve so that the sound of other popular near-field monitors can be easily emulated.

Positioning the Resolv A Series

Near field monitoring has become the choice of many engineers in large and small studios because it minimizes the effect of room acoustics. This is especially important in today's project studios since the budget for room acoustics is often close to nothing. By positioning the reference monitors in the near field (close to the listeners), you can greatly reduce the effects of room acoustics. The most important considerations when evaluating the effects of room acoustics are reflective surfaces that are around the monitoring area. These can include flat tabletops, glass mirrors or framed pictures, large open walls and even the surface of your mixing console. Mostly all reflecting sound will eventually reach the listening position, but since it is slightly delayed from the direct source, the result is random cancellation of some frequencies, or comb filtering. If possible, remove any and all reflective surfaces. You may also want to hang some acoustic foam on walls that are close to the monitors. When positioning the monitors, you'll want to set up what is commonly referred to as the "mix triangle". In this ideal configuration, the space between the left and right monitor is equal to the distance from the listener to each monitor, forming an equilateral triangle. (Figure 1.)

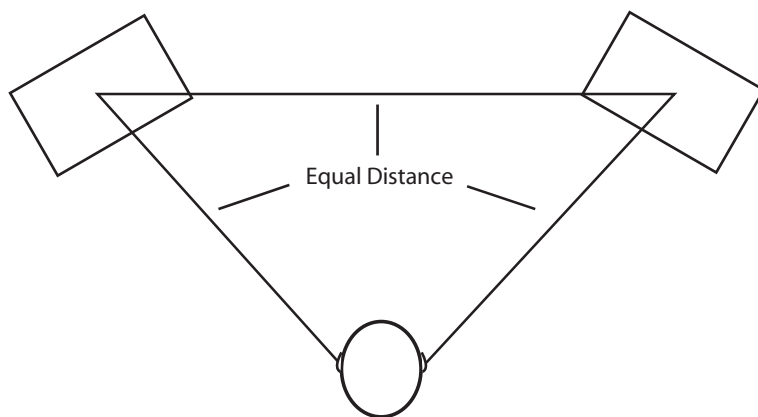

Figure 1. Prime Listening Spot

Setting up the Resolv A Series

Positioning the Resolv A Series - continued

Speaker Orientation

The Resolv A Series can be used in either the vertical or horizontal position, however for best results they should be set up in the vertical position. When using the monitors in the horizontal position, be certain to place the left and right side tweeters on the outer most sides. (Figure 2) This will improve the stereo imaging and bass response by increasing the coupling of the low-end drivers.

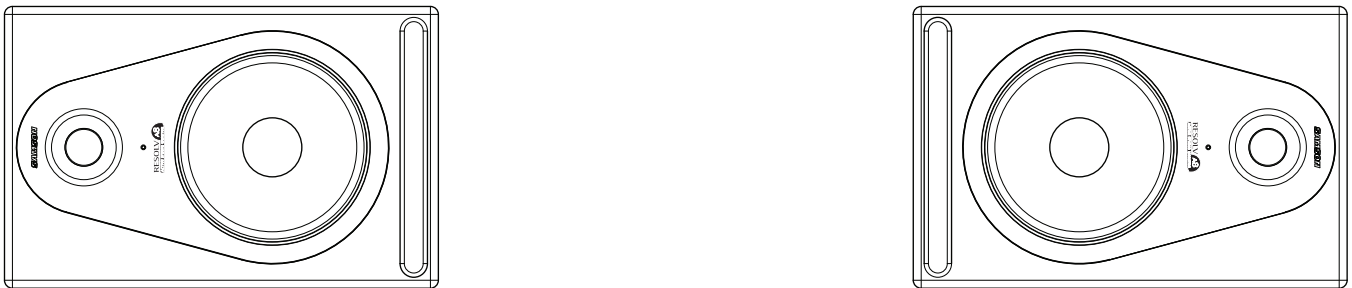

Figure 2.

When choosing the height of your monitor system, be careful to avoid reflections off the surface of the mixing console. (Figure 3.) These reflections arrive at the listening position slightly delayed from the original sound resulting in strange cancellations and overall unpredictable response. Visualize straight lines representing the beams of sound radiating from the monitors and choose a height that reduces the occurrence of reflections that will end up in the prime listening spot. (Figure 4.) In most cases, the ideal position is slightly behind and above the mixing console's meter bridge.

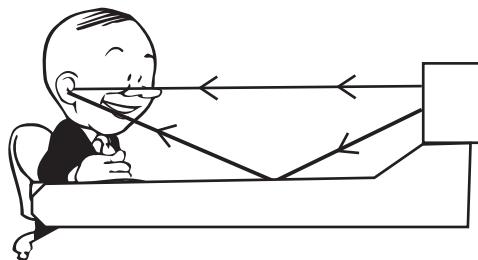

Figure 3.

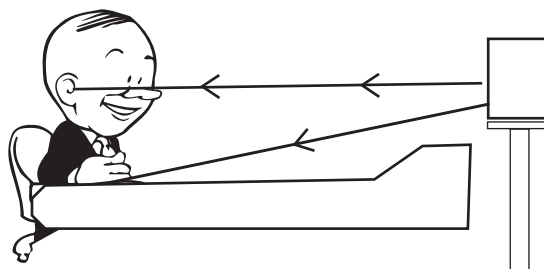

Figure 4.

Connecting the Resolv A Series

Resolv A Series Quick Connections

Note: Before plugging in and turning on, remember the “last on, first off” rule of power amplifiers (and powered monitors). When powering up your system, be sure that all the wires are connected, turn your mixer and any other outboard gear on, and then last turn your Resolv A Series on. When powering down, turn your Resolv A Series off first and then your mixer and outboard gear.

The Resolv A Series connections can be made via one of the three rear panel Audio Inputs. You can use RCA inputs for unbalanced -10dBV level signals, or either the 1/4-inch or XLR inputs for balanced, +4dBu level signals. Follow the simple steps and diagram below for a quick connection using a standard recording console’s control room outputs.

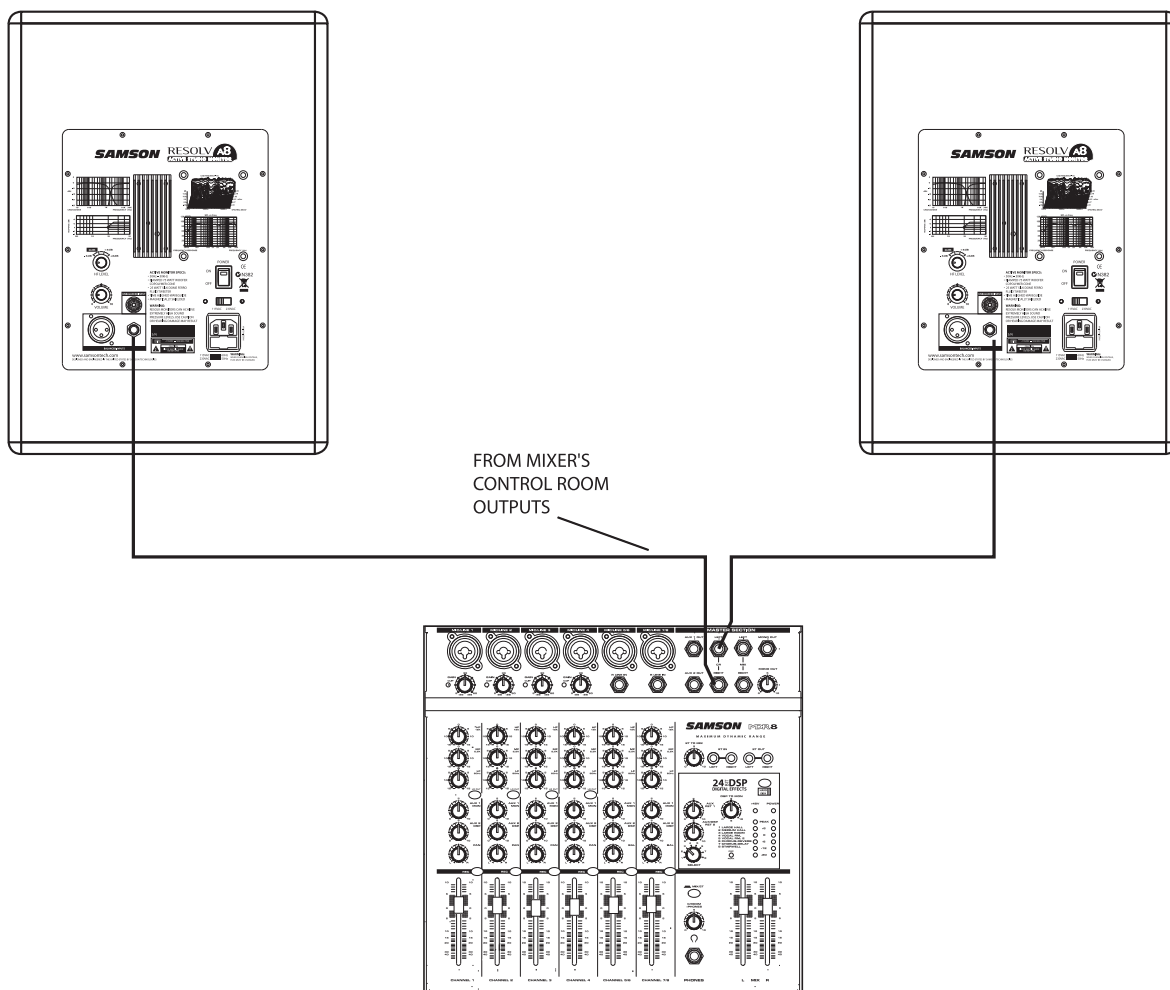

- Lower your mixer’s master outputs to all the way off.
- Connect the mixer’s Left Control Room output to the left-side Resolv A Series LINE INPUT and the mixer’s Right Control Room output to the right-side Resolv A Series LINE INPUT.
- Set the Resolv A Series input Volume control to the 2 o’clock position.
- Run an audio signal (like some music from a CD) through your mixer and raise the Control Room level to a comfortable listening level.

Operating the Resolv A Series

Resolv A Series Control Panel

The Resolv A Series rear control panels are where you will make your connections for both AC power and audio signals. The rear panel also contains the controls to make adjustments to the overall volume and frequency response curve. The following section details the rear panel controls and connections.

Powering the Resolv A Series

Since the Resolv A Series are active studio monitors with an on-board power amplifier and electronic crossover, it is necessary to connect the unit to an AC power supply. Make sure that the main Power switch is set to the OFF position and connect the supplied IEC power cable into the AC inlet.

Things that go Hum!

When running power cables, be careful not to run the AC power cords or AC extension cords in parallel to your input cables. This will help reduce any AC hum that can be picked up. If you have to cross an AC line with an audio line, try to cross them at a 90 degree angle for the least amount of induced hum. Using the Resolv A Series balanced input connectors will greatly protect against the induced hum thanks to the common mode rejection (the induced hum is phase canceled) that it's balanced input circuit provides.

1 POWER SWITCH – The POWER switch is used to turn on the Resolv A Series active electronics. When set to the ON position, the front panel LED will illuminate red, indicating the Resolv A Series is powered up and ready for operation.

2 AC INLET - Connect the supplied IEC power cable here.

The Resolv A Series's rear panel provides two important controls for adjusting the overall sound of the monitor, High Frequency Level and Volume. Eventually, you will adjust these controls to your preferable position and "set it and forget it".

That's assuming that the monitors remain in the same spot, in the same studio. If you take your monitors to other studios you may find the controls extremely useful in adjusting the sound for the new room.

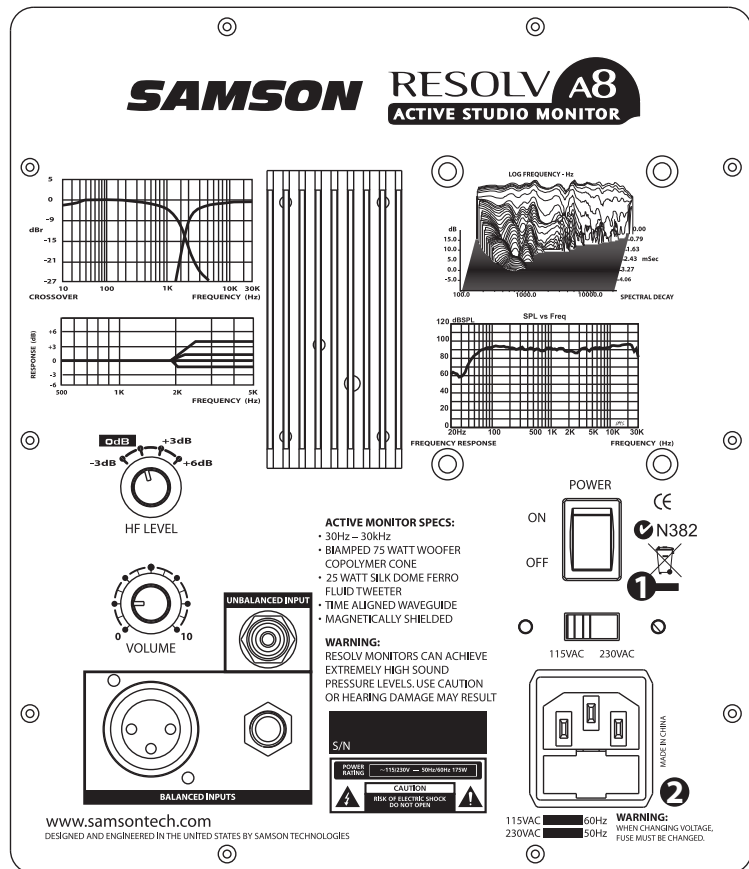

Operating the Resolv A Series

Resolv A Series Control Panel - continued

3 HIGH FREQUENCY LEVEL CONTROL

The four-position High Frequency Level control switch is used to adjust the monitor's high-frequency response, providing four equalization curves to select from. By using the High Frequency Level control, the Resolv A Series' high frequency response is adjusted with the application of a high-end tilt (equalization circuit) centered at 12kHz, with selectable levels of -3dB, 0dB (flat), +3dB and +6dB. You'll find that the change is very subtle. Many mix engineers prefer the sound of near field monitors with a little lift in the high frequency response, some like more focus on the midrange, and therefore, desire a flatter or rolled off high frequency response. The best way to set the controls is what sounds good to you. Therefore, you should experiment with the various settings to find the combination of the High Frequency Level and Volume controls you like. To do this, play several CD's of music that you are familiar with. Remember, if you think you're getting lost, the Resolv A Series is flat when the High Frequency Level control is set to the "0" position.

4 VOLUME CONTROL

The volume control is used to adjust the overall output level of the Resolv A Series. When operating the unit for the first time, start with the volume control set all the way off. Slowly raise the Volume control to reach a comfortable listening level.

The Ins and The Outs

The Resolv A Series features a full complement of input connectors providing easy installation with a variety of audio devices like recording consoles, hard disk recorders, CD players and computer sound cards, to name a few. The following section details the Resolv A Series's input connectors. In addition, there is a detailed cable-wiring diagram on page 12.

5 BALANCED XLR AUDIO INPUT (A6 and A8 only)

The Resolv A Series features a female XLR connector that will accept balanced or unbalanced +4dBu line level signal. If you are using a mixer that has balanced outputs on XLR connectors, you can make the connections via standard XLR (microphone) cable.

6 1/4-INCH PHONE AUDIO INPUT – A balanced TRS (Tip, Ring, Sleeve) 1/4-inch phone plug is used to connect balanced or unbalanced line level signals. The 1/4-inch input is a switching jack, so when a 1/4-inch connector is inserted into the jack, the RCA and/or XLR inputs are switched off and the 1/4-inch input is switched on. This provides a convenient patch-point for quick insertion of a secondary input signal source for testing or expanded operation.

7 RCA AUDIO INPUT – The RCA input accepts unbalanced signals used to connect signals from unbalanced -10dBV devices.

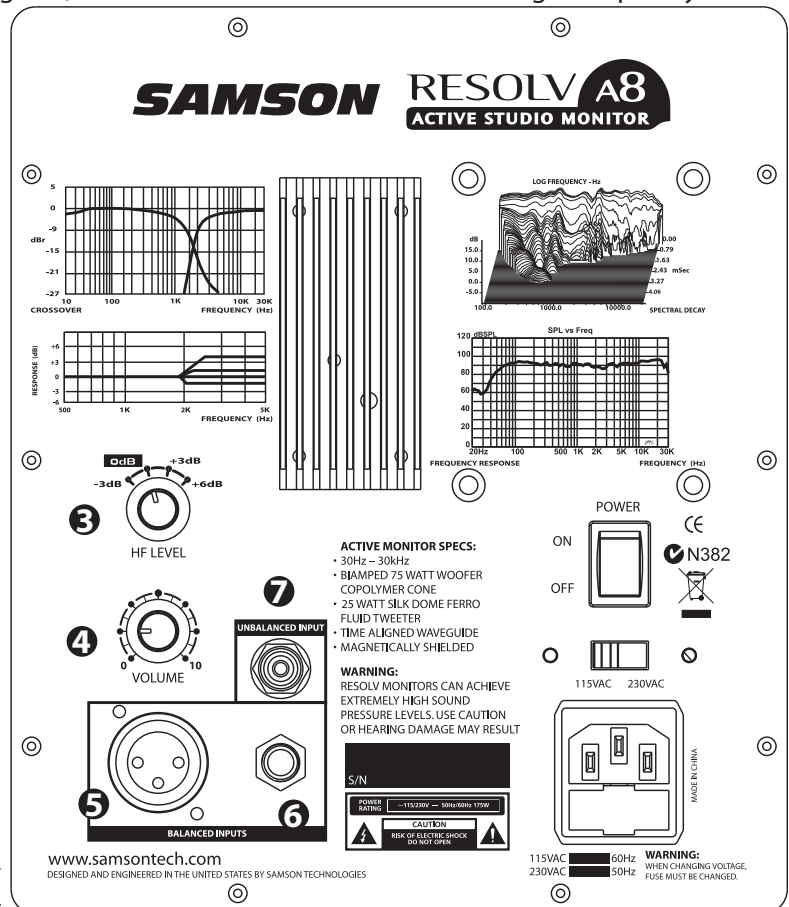

Connecting to the Rubicon R10s Subwoofer

Resolv A Series with Mono Sub

Adding a subwoofer and extended low frequency response to your Resolv A Series's system is easy using the Resolv A Series LINE LEVEL inputs. Below is a typical system set-up using the Samson Rubicon R10s with a mixer and a pair of Resolv A Series satellite speakers. The Resolv A Series inputs utilize industry standard RCA and XLR connectors. For a detailed wiring diagram, see the section "Resolv A Series Connections" on page 12. Follow the steps in the diagram below to set up your system.

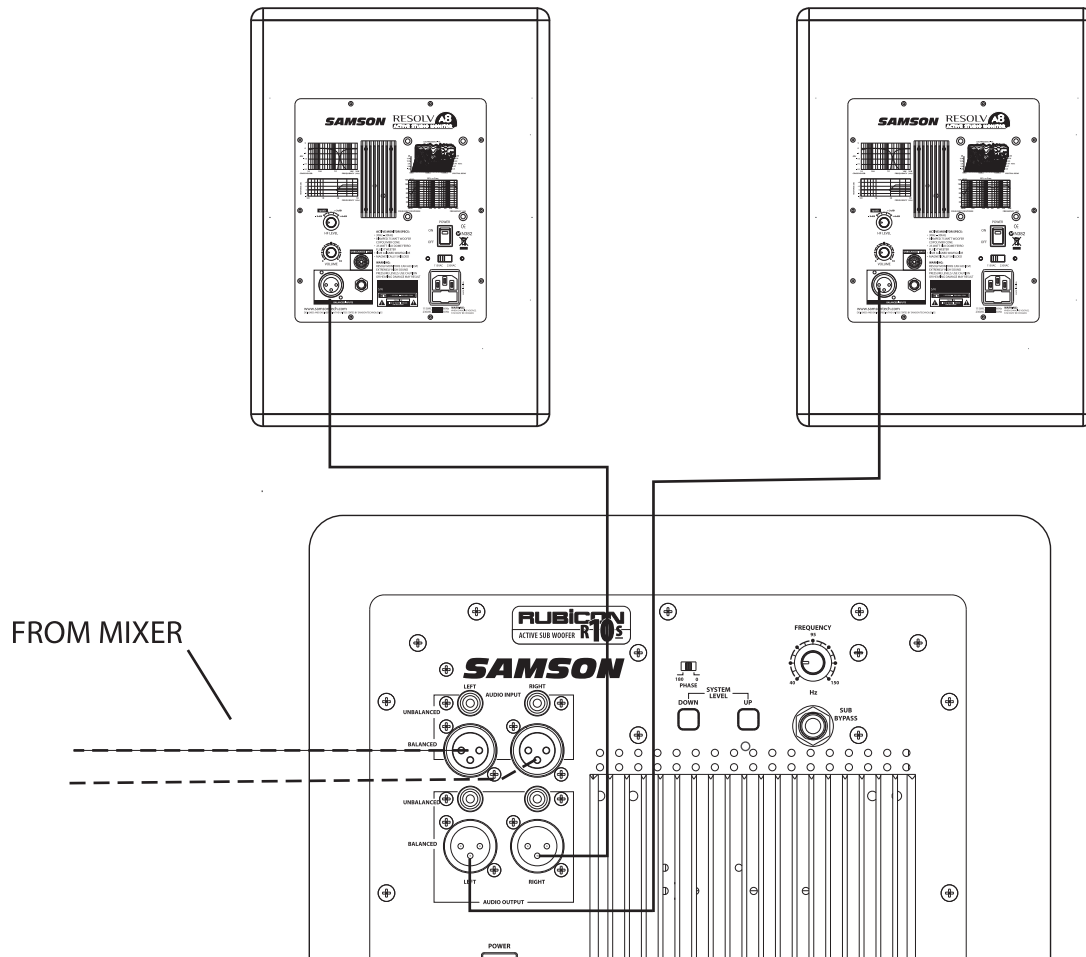

- Lower your mixer's master outputs to all the way off.
- Connect the mixer's left output to the Rubicon R10s' LEFT LINE INPUT and the mixer's right output to the Rubicon R10s' RIGHT LINE INPUT. Now connect the Rubicon R10s' LEFT LINE OUTPUT to the input of the left Resolv A Series , and the Rubicon R10s' RIGHT LINE OUTPUT to the input of the right Resolv A Series .
- Run an audio signal (like some music from a CD) through your mixer and raise the level to a comfortable listening level.
- Now adjust the FREQUENCY control to the desired frequency. You can also use your ears by adjusting the FREQUENCY control to the frequency that sounds good to you. A good place to start is about 70 Hz.

Resolv A Series Connections

Resolv A Series Wiring Guide

There are several ways to interface the Resolv A Series, depending on your exact monitoring set-up. Follow the cable diagrams below for connecting your monitor system.

RCA to RCA Cable

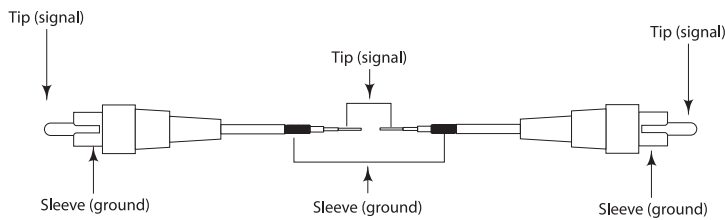

Un-Balanced 1/4" to 1/4" Cable

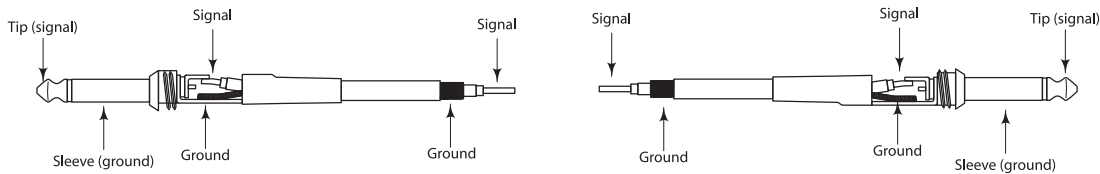

Balanced 1/4" to 1/4" Cable

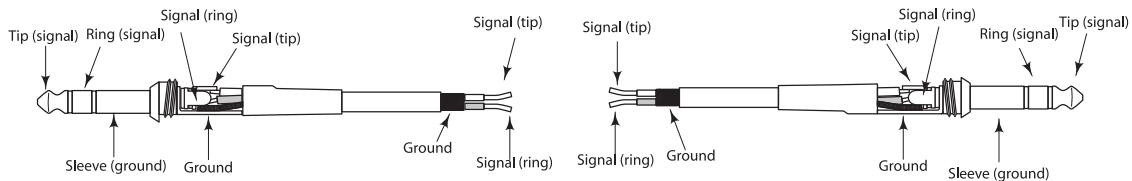

Balanced XLR to XLR Cable

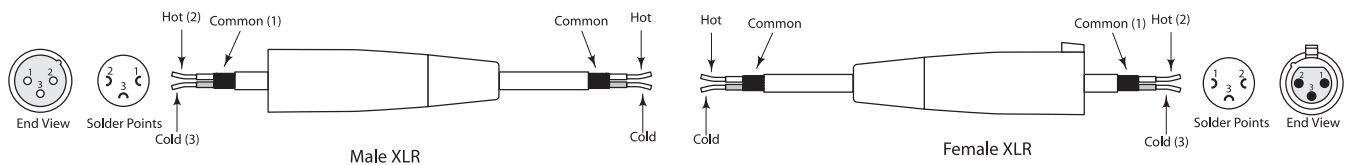

Unbalanced 1/4" to RCA Cable

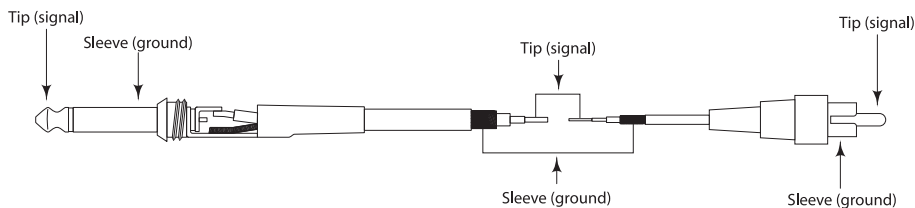

Un-Balanced XLR to RCA Cable

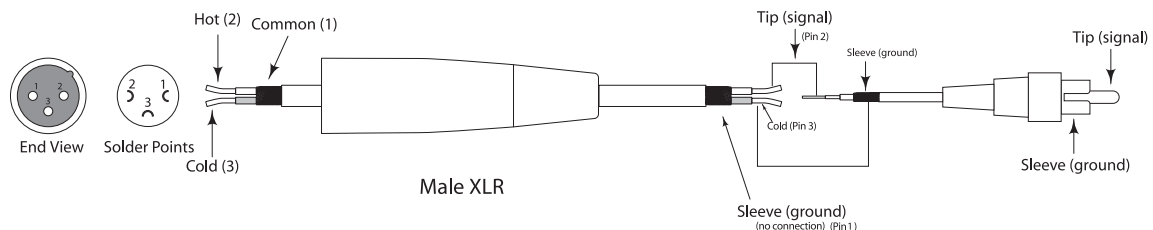

Specifications

A5 Specifications

Transducers:
woofers5" (127mm) woven carbon fiber woofer with butyl surround,
tweeter1.25-inch (31.75mm) silk dome, ferro-fluid cooled tweeter
Frequency response:45Hz - 27KHz +/-3 dB
Amplifier:65Hz-18kHz +/-3 Actual
Power Rating:
Low-frequency -.50 Watts RMS
High-frequency20 Watts RMS
Crossover Frequency:2.3KHz, multi-pole filter
Inputs:
Unbalanced-10dBV Line Level
Connector:RCA
Balanced+4dBu Line Level
Connector:1/4-inch Phone TRS (Tip Ring Sleeve)
Enclosure:
Construction:MDF (Medium Density Fiberboard)
Finish:Black Textured Vinyl covering, painted gloss black baffle
Dimensions:8" (203mm) W x 12" (305mm) H x 8.75" (223mm) D
Weight:15.25 lbs. 6.9 kg.

A6 Specifications

Transducers:
woofers6.5" (165.1mm) woven carbon fiber woofer with butyl surround,
tweeter1.25-inch (31.75mm) silk dome, ferro-fluid cooled tweeter
Frequency response:40Hz - 27KHz +/-3 dB
Amplifier65Hz-22kHz +/-3 Actual
Power Rating:
Low-frequency -.75 Watts RMS
High-frequency25 Watts RMS
Crossover Frequency:2.3KHz, multi-pole filter
Inputs:
Unbalanced-10dBV Line Level
Connector:RCA
Balanced+4dBu Line Level
Connector:1/4-inch Phone TRS (Tip Ring Sleeve), Female XLR
Enclosure:
Construction:MDF (Medium Density Fiberboard)
Finish:Black Textured Vinyl covering
Dimensions:9.25" (236mm) W x 12.75" (324mm) H x 9.85" (251mm) D
Weight:18 lbs. 8.2 kg.

A8 Specifications

Transducers:
woofers8" (203.2mm) woven carbon fiber woofer with butyl surround,
tweeter1.25-inch (31.75mm) silk dome, ferro-fluid cooled tweeter
Frequency response:30Hz - 27KHz +/-3 dB
Amplifier:50Hz-20kHz +/-3 Actual
Power Rating:
Low-frequency -.75 Watts RMS
High-frequency25 Watts RMS
Crossover Frequency:2.3KHz, multi-pole filter
Inputs:
Unbalanced-10dBV Line Level
Connector:RCA
Balanced+4dBu Line Level
Connector:1/4-inch Phone TRS (Tip Ring Sleeve), Female XLR
Enclosure:
Construction:MDF (Medium Density Fiberboard)
Finish:Black Textured Vinyl covering
Dimensions:12" (305mm) W x 16" (407mm) H x 11.25" (284mm) D
Weight:25 lbs. 11.4 kg.

Specifications are subject to change without notice.

Samson Technologies Corp.
45 Gilpin Avenue
Hauppauge, New York 11788-8816
Phone: 1-800-3-SAMSON (1-800-372-6766)
Fax: 631-784-2201
www.samsontech.com