

# Pocket Blender

## Acoustic Instrument Preamp



Thank you for choosing the Fishman Pocket Blender. Our goal is to provide you with acoustic amplification products that will simply let you sound your best. With our long-standing commitment to quality, you can feel confident that your Fishman gear will produce great sound and trouble-free performance for years to come. Please take a few minutes to read this guide and familiarize yourself with the system. Your satisfaction is very important to us. If you have any questions or comments, please contact us at [tech@fishman.com](mailto:tech@fishman.com) or by phone at 978-988-9665.

## CONTENTS

Introduction .....	2
Install pickup/Microphone on the instrument .....	3
Quick Start .....	4
Features .....	5
Power Options .....	6
<i>Front Panel</i>	
Microphone Channel .....	6
Transducer Channel .....	7
Master Section .....	8
Rear Panel .....	8
Suggested Input Options .....	10
Suggested Output Options .....	12
Outputs/Effects Loops .....	13
Trouble Shooting .....	14
Optional Accessories .....	15
Specifications .....	15
Block Diagram .....	16
Appendix - The Microphone .....	17

## INTRODUCTION: THE BLENDER SYSTEM

The Fishman Pocket Blender is a compact yet full-featured 2-channel outboard mixer/preamp designed for acoustic stringed instruments. It is specifically set up for blending a pickup with an onboard miniature microphone.

### 1 - Microphone and Pickup (Transducer)

Everyone loves the way a microphone captures the natural ambience and resonance of an acoustic instrument. But microphones have a downside; they feedback when you crank up the volume and tend to get lost in the mix when there are other amplified instruments onstage. Pickups deliver a balanced high output signal with low feedback, but they can sound somewhat dry compared to microphones.

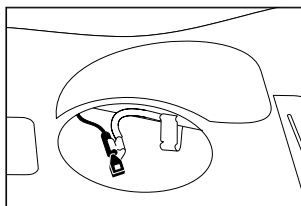

MINI-MICROPHONE MOUNTED ON X-BRACE NEAR SOUNDHOLE

UNDER-SADDLE PIEZO TRANSDUCER



The Pocket Blender allows you to combine the benefits of both pickup and microphone signals to achieve results not available by simply using one or the other. With this system, a microphone rounds out the dry, direct sound of a pickup - while the "bite" of a pickup adds focus and definition to the microphone sound.

We recommend (and sell) the Crown GLM-200 mini-microphone for the Pocket Blender. Electret microphones made by other manufacturer's can be modified for use with the Pocket Blender (contact the manufacturer for specific wiring).

## 2 - Stereo Instrument Cable

For convenience, we use a TRS stereo instrument cable to get the individual microphone and pickup signals from the instrument into the Pocket Blender. The Pocket Blender supplies a 9-Volt bias voltage through the ring connection that in turn powers the mini-microphone.

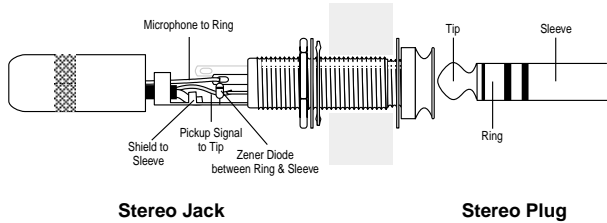

## 3 - The Pocket Blender

Each channel of the Pocket Blender is set up for the particular signal conditioning requirements of microphone and pickup. Once the pickup/microphone signals are blended, the composite signal can be routed to amplification, recording gear or signal processing equipment via XLR and 1/4" outputs. An effects loop is also included for each channel.

## INSTALLING A PICKUP / CROWN GLM 200 MICROPHONE COMBINATION ON YOUR INSTRUMENT

Before you begin using your Pocket Blender, have a repair professional install the appropriate pickup and microphone combination for your instrument.

**Note:** *The Pocket Blender is also compatible with other manufacturers' mini-electret microphones. Consult the manufacturer for specific minimum power requirements, wiring configuration and instrument mounting systems (the Fishman microphone mounts are dedicated to the Crown GLM series).*

## Three Common Scenarios:

### 1 - WIRING A PASSIVE PICKUP & MICROPHONE

A passive pickup is any transducer (piezo or magnetic) that works without a battery.

**Note:** *To minimize crosstalk with a passive pickup, use a "2-pair" premium stereo cable (Fishman part # ACC-BLE-15C) with separate shields for both the pickup and microphone signals.*

1. Connect red microphone wire to ring terminal.
2. Connect white and shield microphone wires to sleeve.
3. Connect pickup signal wire to tip and pickup shield to sleeve.
4. Connect supplied zener diode in place between red wire (ring) and ground (sleeve).  
Note that banded side of diode must be closest to red wire.

## 2 - WIRING TO ACOUSTIC MATRIX NATURAL I & II

1. Remove shielding cap to expose preamp circuit board.
2. Connect red microphone wire to ring pad on circuit board.
3. Connect white and shield microphone wires to "G" pad adjacent to ring pad.
4. Connect supplied zener diode in place between red wire and sleeve. Note that banded side of the zener diode must be closest to red microphone wire.

## 3 - WIRING THE MIC & PICKUP WITH SEPARATE CONNECTORS

The advantages to wiring the microphone and pickup to separate mono connectors are:

- a. Microphone is interchangeable with other instruments.
- b. Less cross talk between passive pickups and the microphone.

Typically, classical guitarists and double bassists find this arrangement convenient for sharing the microphone with several different instruments. Classical guitarists can install the microphone without drilling holes in the instrument. In this configuration, the microphone can also be removed without disturbing the pickup.

1. Connect red microphone wire to tip terminal on a ¼" mono plug.
2. Connect white microphone wire and shield to sleeve terminal the same plug.
3. Solder supplied zener diode in place between red wire and sleeve.

**Note:** *The banded side of the diode must be closest to the red wire. For use with the Pocket Blender, plug the mic into the RING jack of a stereo "Y" cable (available from Fishman).*

**Warning:** Installation by a qualified repairperson is strongly recommended. Fishman Transducers Inc. will not be responsible for any damages due to improper installation.

## QUICK START

*To get up and running you'll need these components:*

- Pocket Blender
- 9-Volt alkaline battery
- Pickup and mini-microphone connected to a stereo jack (See Page 3)
- Stereo instrument cable
- XLR cable or 1/4" instrument cable

1. Install a fresh 9-Volt alkaline battery.
2. Connect the stereo cable between the instrument and the input of the Pocket Blender.
3. Set the Mute, Lo and Hi switches to the out position. Set the phantom power switch on the rear panel to the in position. Set both channel volume controls fully counter clockwise. Set the Master level to 3:00. Set all the bass and treble controls to 12:00.
4. Run a cable from one of the outputs on the rear panel of the Pocket Blender to your amp or PA.
5. Adjust the trim controls - See Page 7
6. With the Pocket Blender's Master Level at 3:00, adjust both the microphone and transducer volume controls to approximately the same level.
7. Set the phase switches - See Page 6

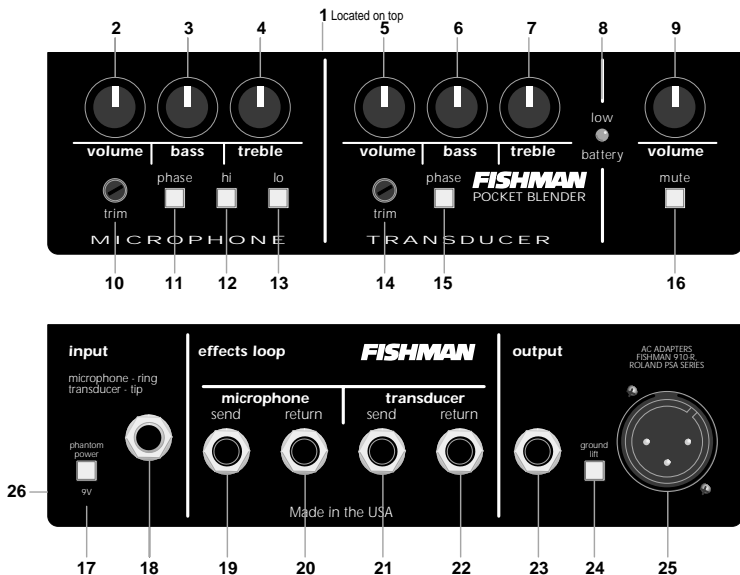

## FEATURES

### FRONT PANEL

- 1) BATTERY COMPARTMENT
- 2) MICROPHONE VOLUME
- 3) MICROPHONE BASS CONTROL
- 4) MICROPHONE TREBLE CONTROL
- 5) TRANSDUCER VOLUME CONTROL
- 6) TRANSDUCER BASS CONTROL
- 7) TRANSDUCER TREBLE CONTROL
- 8) BATTERY LOW LED
- 9) MASTER VOLUME CONTROL
- 10) MICROPHONE TRIM CONTROL
- 11) MICROPHONE PHASE SWITCH
- 12) MICROPHONE HI CUT SWITCH
- 13) MICROPHONE LO CUT SWITCH
- 14) TRANSDUCER TRIM CONTROL
- 15) TRANSDUCER PHASE SWITCH
- 16) MUTE SWITCH

### REAR PANEL

- 17) 9-VOLT PHANTOM POWER SWITCH
- 18) 1/4" INPUT JACK (TRS)
- 19) MICROPHONE EFFECTS SEND
- 20) MICROPHONE EFFECTS RETURN
- 21) TRANSDUCER EFFECTS SEND
- 22) TRANSDUCERS EFFECTS RETURN
- 23) 1/4" UNBALANCED OUTPUT
- 24) GROUND LIFT SWITCH
- 25) XLR BALANCED OUTPUT
- 26) AC ADAPTER INPUT

## POWER OPTIONS

### 9-Volt Battery

Lift the lid on top of the Pocket Blender and insert a fresh 9-Volt alkaline battery. Observe the correct polarity. Battery life is an estimated 60 hours of continuous use.



### 9-Volt AC Adapter Input

Use only a well filtered and regulated 9-Volt AC adapter. We recommend a Fishman Model-910 or Roland PSA series regulated AC Adapter. Use of an unregulated adapter will not only void the warranty, but may damage the unit.

### Input Jack

Plug in a TRS stereo cable here. The input will accept two separate signals via a stereo instrument cable. (*Tip = Transducer Channel, Ring = Microphone Channel*) Engage the Mute switch before you plug into the input to avoid a loud pop through the speakers. When you plug in here the battery turns on. To save the battery remember to unplug the input when you're not using the Pocket Blender.

## MICROPHONE CHANNEL

Use the Microphone Channel for a mini-electret microphone (switch 9-Volt phantom on rear panel on) or with a second pickup (9-Volt phantom off).

### Volume Control

Normally set the volume for the microphone at around 12:00 (see Trim instructions below).

### Bass And Treble

These shelving style tone controls provide basic equalization for the Microphone Channel. Set them at 12:00 for no cut or boost (flat).

### Phase Switches

Prevent feedback and match up the pickup and microphone signals for a stronger amplified sound.

#### How to kill feedback in the Microphone Channel:

- Adjust the Master volume level to 3:00 and turn the Transducer volume off (7:00).
- Adjust the Microphone Channel volume to just below the threshold of feedback. Play your instrument and toggle the Microphone Channel phase switch. Leave the switch where it feeds-back the least.

#### How to get the pickup in phase with the microphone:

- After you perform the above step, raise the Transducer Channel volume until it is about the same level as the Microphone. Play a sustained note or chord on your instrument and toggle the Transducer Channel Phase switch. Leave the switch in the position that sounds strongest and feeds-back the least.
- Once the pickup and Microphone are in Phase, make note of the relative position of the two switches. They will be either in the same position, or one in and one out. To keep pickup/mic in phase, push both switches anytime you adjust the overall polarity.

## **Trim Control**

Set as high as possible without hearing distortion.

Start with the control fully clockwise and play your loudest note or chord. If you hear distortion, lower the trim with a small slotted screwdriver until the distortion goes away.

The Trim control can also be used to set the baseline levels for the Microphone and Transducer Channels. If there is a disparity between the microphone and pickup levels, use the Trim control to attenuate one channel (usually the Transducer Channel). Try setting the Trim controls this way ...

1. Set the Output Level to 3:00.
2. Set both Channel volumes to 12:00.
3. Play a note or chord on your instrument and lower the Transducer Channel Trim control until both levels are equal, or are balanced to suit your taste.

## **Hi Cut Switch**

Push in this switch to reduce microphone feedback.

## **Lo Cut Switch**

Push in this switch to roll off excessive boominess in the Microphone Channel, especially for guitar.

## **TRANSDUCER CHANNEL**

---

### **Volume Control**

Normally set the volume at around 12:00 (see Trim instructions below).

### **Bass and Treble Controls**

These shelving style tone controls provide basic equalization for the Transducer Channel. Set them at 12:00 for no cut or boost (flat).

### **Trim Control**

Set as high as possible without hearing distortion.

Start with the control fully clockwise and play your loudest note or chord. If you hear distortion, lower the trim with a small slotted screwdriver until the distortion goes away.

### **Phase Switches**

Prevent feedback and match up the pickup and microphone signals for a stronger sounding amplified signal.

Refer to Page 6 for more information on how to use the Pocket Blender's Phase switches.

## MASTER SECTION

---

### Low Battery Indicator

If you use a battery to power the Pocket Blender, the LED will flash briefly when you plug into the input, telling you that the unit is powering up.

When the red LED lights with no signal present it is time to change the battery.

If the low battery light comes on while you're playing don't worry, you'll have enough power to get through a gig. Just be sure to change the battery before the next time you use the preamp.

### Master Volume Control

For the cleanest sound, set the master volume as high as you can without distorting your amp or mixer.

### Mute Switch

Mutes all signals at the output section, so you can take breaks without changing any of your volume settings.

With the mute engaged you can also silently disconnect the cable from your instrument without a loud pop through the speakers.

The mute switch is also useful with an electronic tuner. Plug the tuner into the transducer send and engage the mute switch. You can now tune onstage without being heard through the speakers.

## REAR PANEL

---

### 9-Volt Phantom Power Switch

Push the switch in for 9 volts bias voltage to the ring contact of the Input jack.

Push the 9-Volt phantom power switch in when you use a mini-electret microphone. Push the switch out if you will use the Microphone Channel for a second pickup (piezo or magnetic)

### Input jack (see Page 6)

### Effects Loops

The microphone effects loop lets you insert outboard effects or signal processors into the Microphone Channel.

The microphone channel send comes after the:

- Bass and treble controls
- Trim control
- HI cut and LO cut switches
- Phase switch



The Microphone Channel return comes before the:

- Volume and master volume controls
- Mute Switch

The transducer effects loop lets you insert outboard effects or signal processors into the Transducer Channel.

The Transducer Channel send comes after the:

- Bass and treble controls
- Trim control
- Phase switch

The Transducer Channel return comes before:

- Volume and master volume controls
- Phase and mute switches

## PATCHING OPTIONS WITH THE EFFECTS LOOPS

### **Sends**

When you need a fixed level signal (regardless of changes in stage level) use the transducer and microphone sends. Typical applications for the sends:

- **Transducer Send to an Electronic Tuner**

The transducer send provides a strong and steady signal for electronic tuners. Since the send is not affected by the mute switch, you may tune your instrument onstage without being heard through the speakers.

- **Live Recording or Broadcast Feed**

Since the sends are not affected by any of the front panel volume controls, you can plug them into an external DI for a fixed level signal for recording or radio gear.

### **Returns**

The microphone or transducer returns can be used as alternate inputs. A buffered signal appearing at one of the Returns will replace the signal appearing at the respective input of the Pocket Blender.

For example, a CD or MD player can plug into the microphone return, replacing the microphone signal.

### **Outputs**

Plug the 1/4" output into an instrument amplifier or an unbalanced input on a mixer.

Plug the XLR output into the balanced input of a PA mixer or recording console.

### **Ground Lift**

Use this switch to eliminate AC ground loop hum. When you use the XLR output together with the 1/4" output or one of the effects loops and you hear hum from the speakers, push the ground lift switch in and the hum should go away. If you have more than one AC powered device plugged into the Pocket Blender, the "lift" position may not completely eliminate ground loop hum.

## SUGGESTED INPUT OPTIONS

### Internal Microphone and Pickup

- Pickup goes to tip, microphone goes to ring.
- Pickup and microphone signals are routed through a stereo instrument cable to the input jack.
- Pickup signal goes through Transducer Channel.
- Microphone signal goes through Microphone Channel.
- 9-Volt phantom power on (switch pushed in).

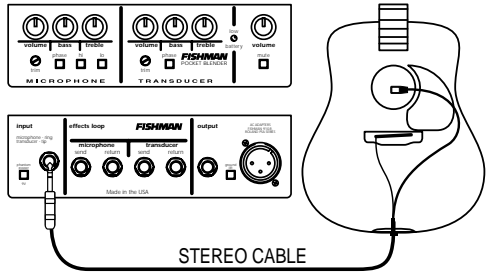

### Pickup Alone

- Single pickup is sent through a mono instrument cable to the input jack.
- The signal goes through the transducer channel.
- Turn the 9-Volt phantom power off (switch pushed out) to save battery life.

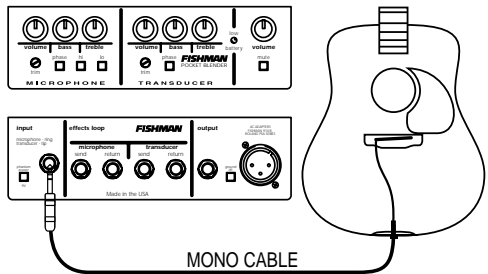

### Mini-Microphone Alone

- Microphone goes through a mono instrument cable to the ring jack of a Stereo "Y" cable (p/n ACC-BLE- CBY). The signal goes to the microphone channel.
- Turn the 9-Volt phantom power on (switch is in).

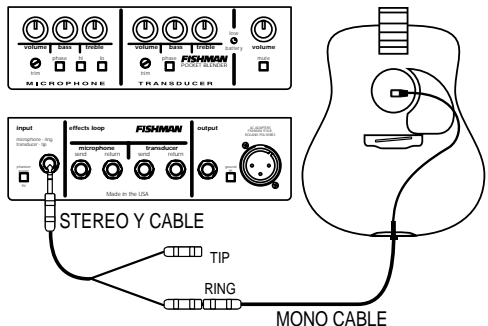

## Piezo and Magnetic Pickup

- Signal from piezo is routed through a mono instrument cable to the tip jack of a Stereo "Y" cable (p/n ACC-BLE-CBY). This signal goes to the transducer channel.
- Signal from magnetic pickup is sent through a mono instrument cable to the ring jack of a Stereo "Y" cable (p/n ACC-BLE-CBY). This signal goes to the microphone channel.
- 9-Volt phantom power is off (switch is out).

**Note:** Both signals may be routed through a stereo instrument cable.

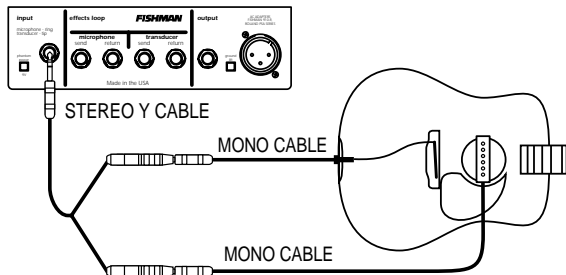

## Under-saddle and Surface-mount Piezo Pickups

- Signals from both pickups are sent through a stereo instrument cable to the input jack.
- Under-saddle pickup signal (tip) is routed to the Transducer Channel.
- Surface-mount pickup (ring) is routed to the Microphone Channel.
- 9-Volt phantom power is off (switch pushed out).

**Note:** Both signals may be routed through two mono instrument cables and a stereo "Y" cable (p/n ACC-BLE-CBY).

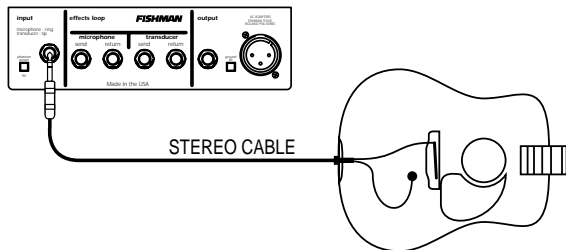

## SUGGESTED OUTPUT OPTIONS

1. Connect the 1/4" output to the input of an instrument amplifier.

The amp will see a blended signal of both microphone and pickup.

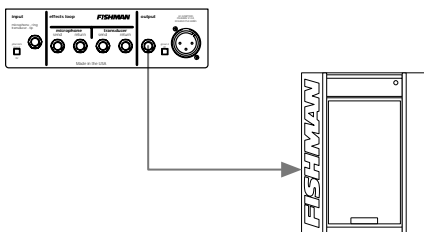

2. Connect the XLR output to the input of your PA system. The PA will see a blended signal of both Microphone and pickup. This is a great way to control exactly what the soundman has to work with and what the audience will hear.

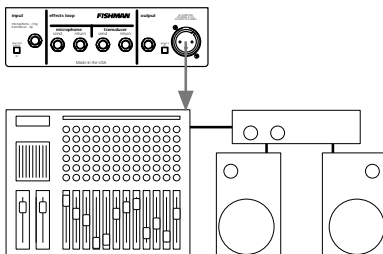

3. XLR to mains and transducer effects to stage monitors to reduce feedback.

Connect the XLR output to the input of your PA system. The house will see a blended signal-both Microphone and pickup.

The signal from the transducer send goes into a direct box and then into the PA. Have the soundman put only this signal through the stage monitors to help reduce feedback.

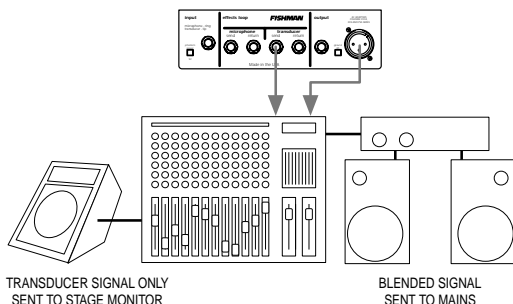

## USING MULTIPLE OUTPUTS

All the Pocket Blender's outputs can be used simultaneously.

This offers a basic combination of signal routing and interfacing options to accommodate most performance and recording situations.

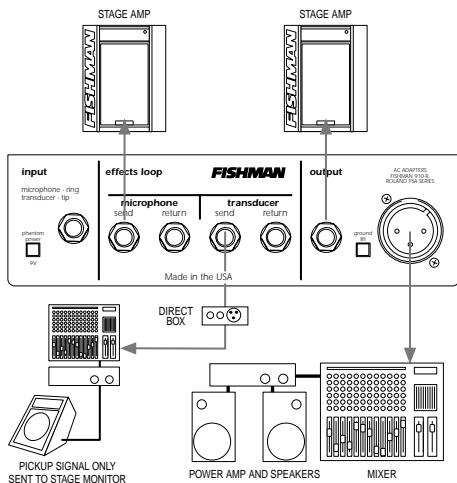

## EFFECTS LOOPS

The Pocket Blender has two effects loops for microphone and for transducer signals. The sends can be used as additional outputs. The returns can be used as alternate inputs. The transducer effects send makes a perfect output signal for electronic tuners.

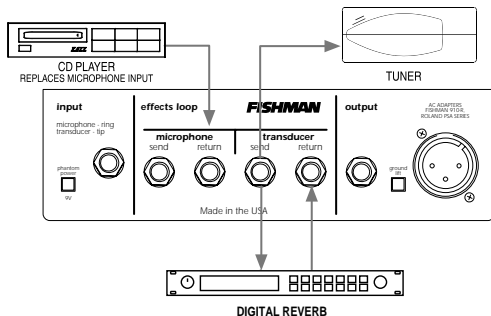

## TROUBLESHOOTING

SYMPTOM	TYPICAL CAUSE	SOLUTION
NO SIGNAL WITH BATTERY POWER	MUTE SWITCH IN  LOOSE BATTERY COMPARTMENT TERMINALS	SET MUTE SWITCH TO OUT POSITION  REMOVE BATTERY AND RE-TENSION TERMINALS BY PULLING THEM UP WITH YOUR FINGER
NO SIGNAL WITH AC POWER	MUTE SWITCH IN	SET MUTE SWITCH TO OUT POSITION
MICROPHONE CHANNEL DEAD WITH MINI-MICROPHONE CONNECTED TO INPUT JACK	PHANTOM POWER IS OFF ( SWITCH IS OUT )  DEVICE APPEARING AT THE MICROPHONE EFFECTS RETURN IS BREAKING THE SIGNAL PATH	TURN PHANTOM POWER ON ( SWITCH IS IN )  REMOVE PLUG FROM THE MICROPHONE EFFECTS RETURN
MICROPHONE IS DEAD AND PICKUP APPEARS IN MICROPHONE CHANNEL	MICROPHONE AND PICKUP ARE WIRED TO STEREO OUTPUT JACK BACKWARDS ( MICROPHONE TO TIP AND PICKUP TO RING )	WIRE PICKUP TO TIP AND MICROPHONE TO RING OF STEREO OUTPUT JACK
NOISE OR DISTORTION FROM EITHER CHANNEL	LOW BATTERY  TRIM CONTROL(S) SET TOO HIGH  MECHANICAL NOISE FROM INSTRUMENT  MECHANICAL NOISE FROM INSTRUMENT CABLE	WHEN LOW BATTERY LED STAYS ON WITH INPUT JACK PLUGGED IN, IT IS TIME TO CHANGE THE BATTERY  LOWER TRIM CONTROL(S) UNTIL DISTORTION DISAPPEARS  LISTEN TO INSTRUMENT ACOUSTICALLY TO ISOLATE NOISE  TIGHTEN ALL PLUG HARDWARE
DISTORTION FROM EXTREMELY 'HOT' SIGNALS SUCH AS EXTERNAL PICKUP	INPUT CLIPS WITH TRIM CONTROL ALL THE WAY DOWN	CONSULT FISHMAN TECH SUPPORT LINE AT 978-988-9665
HUM	AN UNREGULATED POWER SUPPLY WILL CAUSE THE POCKET BLENDER TO HUM UNDER AC POWER  POORLY SHIELDED OR UNSHIELDED CABLE	USE ONLY FISHMAN 910-R OR ROLAND PSA SERIES AC ADAPTERS  USE ONLY QUALITY FULLY SHIELDED INSTRUMENT CABLES
HIGH FREQUENCY LOSS WITH PASSIVE PIEZO	INSTRUMENT CABLE IS TOO LONG	USE ONLY 15' OR SHORTER INSTRUMENT CABLES WITH PASSIVE PICKUP

## OPTIONAL ACCESSORIES

- A/C Adapter: Fishman 910-R regulated 9-Volt power supply.
- Crown GLM-200 mini-mic: Ships without jack; ready to be wired to the jack of your choice. Soldering and assembly required.
- Internal Mic Mount: Allows you to mount the Crown GLM-200 mini-mic to the X-brace of your guitar.
- Guitar Mic Assembly: Mounts to the X-brace of your guitar. Includes a mini-mic, internal mic mount and stereo endpin jack. Soldering and assembly required.
- Bass Mic Assembly: Mounts to the bridge foot of an acoustic bass. Includes pre-wired mini-mic, mic mount and a stereo bass jack.
- Switchjack Stereo Endpin Jack with Tip, Ring, Sleeve and Switch terminals
- Stereo Bass Jack: Mounts on the A and D strings between bridge and tailpiece.
- Transducers: We make a full line of quality Transducers for many types of acoustic stringed instruments.
- BP-100M: Bass pickup and mini-mic pre-wired to stereo bass jack.
- V-200M: Violin pickup and mini-mic pre-wired to a Carpenter-style output jack.
- M-200M Mandolin pickup and mini-mic pre-wired to a Carpenter style output jack.
- Mic Stand Adapter: Allows you to mount the Pocket Blender on any Microphone stand.
- 15' Stereo Cable
- 15' Premium Stereo Cable
- Stereo "Y" Cable: 1/4" stereo male to (2) 1/4" mono female.

## SPECIFICATIONS

### Input Impedance:

Transducer:	10 M $\Omega$
Microphone without phantom power:	1.0 M $\Omega$
Microphone with 9-Volt phantom power:	10 K $\Omega$
Phantom Power:	9-Volts, .5 mA
Nominal Input Level:	-20 dBV
Input Overload:	(20Hz-20kHz) -8 dBV

### Output Type:

Electronically balanced XLR and unbalanced 1/4" Jack

### Output Impedance:

XLR:	220 $\Omega$
1/4" JACK:	1 K $\Omega$
Nominal Output Level:	-11 dBV
Output Overload:	14 dBV (600 Ohm load)

### Effects Loop Nominal Levels:

Transducer channel:	-3.5 dBV
Microphone channel:	-3.0 dBV
Effects Loop Send Impedance:	1 K $\Omega$
Return Impedance:	23 K $\Omega$

Bass Control Range:	$\pm$ 8 dB shelving
Treble Control Range:	$\pm$ 13 dB shelving

Front Panel Trim Gain Range:	16 dB
Overall THD:	.07% @ 1 kHz, -14 dBV input
Overall Dynamic Range:	110 dB
Signal to Noise Ratio:	87 dB (A-weighted, referred to nominal - 20 dBV input)
Dual Power Supply:	9-Volt regulated, or single 9-Volt battery (Estimated 60 hours of continuous use)
Dimensions:	6.75" x 2" x 3"
Weight:	1 lb 2 oz

*All specifications subject to change without notice*

BLOCK DIAGRAM

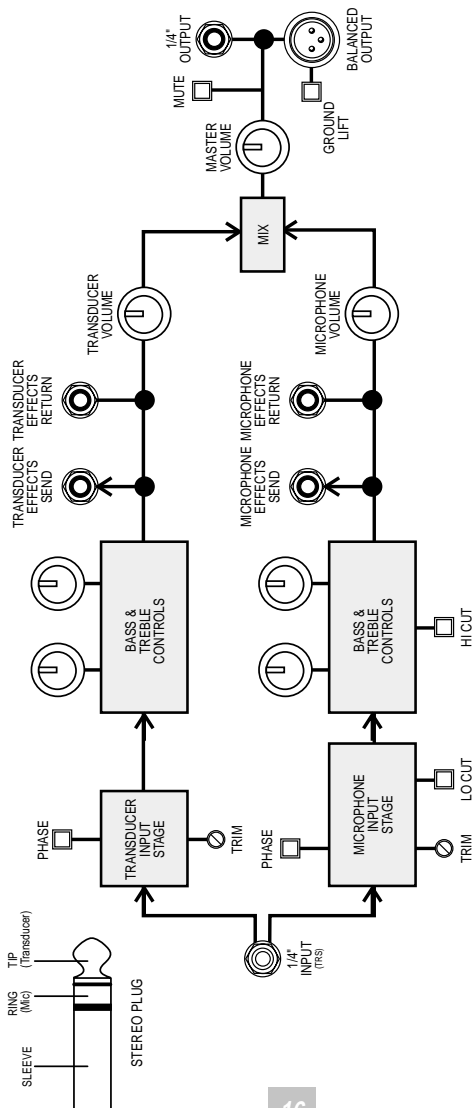



## APPENDIX I - THE MICROPHONE

GLM-200

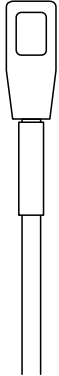

ACTUAL SIZE

A variety of microphones can be used with the Pocket Blender. However, the Crown GLM-200 is our microphone of choice for the system. It is a mini-electret condenser microphone with a hyper-cardioid response pattern. It's high SPL rating (130 dB), small size and crystal clear "rising" frequency response make it ideal for close mic'ing acoustic stringed instruments. We offer the GLM-200 optimized specifically for use with the Blender System.

The Pocket Blender provides 9-Volts of Phantom power to the GLM-200 via the tip terminal at the input jack.

A small zener diode is included with the GLM-200 microphone. It is pre-wired to both the Bass and Violin jack assemblies (BMA, BP-100-M, V-200-M). It is included separately with all other kits. It must be installed for the microphone to be covered under warranty. The zener diode prevents static electricity from damaging the microphone.

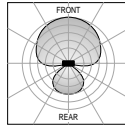

GLM-200  
RESPONSE PATTERN

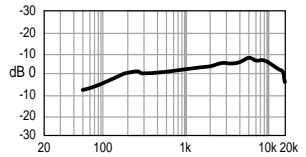

GLM-200  
FREQUENCY RESPONSE CURVE

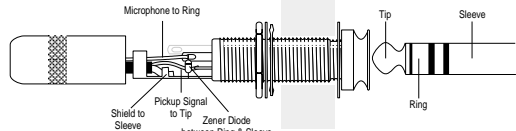

Stereo Jack

Stereo Plug

*Microphone Wiring (Typical)*

The GLM-200's small size allows it to be conveniently mounted in or outside the sound chamber of most stringed instruments. The microphone, with a (TRS) stereo jack included, can be attached to the instrument using one of the following mounting systems:

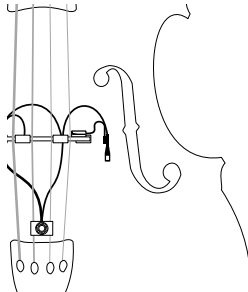

### GMA - Guitar Microphone Assembly

The Microphone is mounted in the sound hole with a clip that attaches to the X-brace under the instrument's soundboard. The jack is run through the instrument's endpin hole. Soldering and some assembly is required.

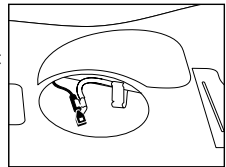

### BMA - Bass Microphone Assembly

The mount attaches to a bridge foot with an adhesive backed nylon clip. The jack (pre wired to Tip) mounts between the A & D strings. Also available with a pre-wired pickup (BP-100M).

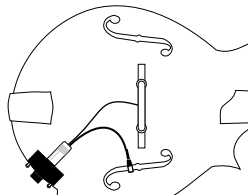

### V-200M Pickup and Mini-Mic

The mount is integrated into a Carpenter-style jack that attaches above the instrument's chin rest.

### M-200M Mandolin Pickup and Mini-Mic

The mount is integrated into a Carpenter-style jack that attaches to the mandolin's lower bout.

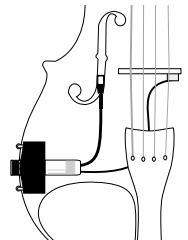

## Using other Microphones

The Pocket Blender is also compatible with other manufacturers' mini-electret Microphones. Consult the manufacturer for specific minimum power requirements, wiring configuration and instrument mounting systems (the Fishman Microphone mounts are dedicated to the Crown GLM series).

Dynamic Microphones (such as the SM 58) may be used with the Pocket Blender. You'll need a low to high impedance adapter plugged into the Ring jack of a stereo "Y" cable. Turn off the 9-Volt Phantom Power (switch is out) for this application.

## Positioning the Crown GLM-200 Microphone

It's worth taking the time to experiment with mic placement. Here are some suggestions to help you get started:

### Internally mounted Microphone (flat top guitars)

Start with the Microphone centered in the soundhole, slightly below the top. Position the face of the Microphone (marked "FRONT") toward the inside of the instrument. Tilting the Microphone as much as 90° may help reduce boominess.

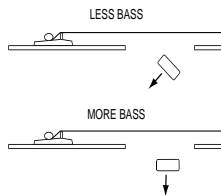

### Externally mounted Microphone

(violin, bass, cello, arch-top guitar).

Start with the Microphone centered halfway between a bridge foot and F-hole. Position the face of the Microphone (marked front) towards the instrument. Tilting the Microphone as much as 90° may help reduce boominess. Placing the Microphone directly over an F-hole will produce a deep, woody tone. However, the Microphone will feedback at the instrument's cavity resonance. This can be easily remedied by notching out the feedback with an external equalizer (see below). Placing the Microphone over the soundboard will produce a tight, focused tone with more midrange emphasis but less overall output.

## ADDRESSING FEEDBACK

### Low Frequency Feedback

All stringed instruments' sound chambers are tuned to resonate at an optimum frequency, in the instrument's lowest octave. Placing a Microphone directly over the opening of the instrument may result in feedback at this "cavity resonance".

#### Typical Resonant Frequencies:

Guitar; 95-105 Hz

Bass; 65-75 Hz

Violin; 275-300 Hz

Cello; 125-135 Hz

#### To Minimize Cavity Resonance Feedback:

1. Position the Microphone away from the opening on non-flattop instruments. This works well in low volume settings.
2. Turn down the bass control on the Microphone Channel.
3. Push in the bass cut switch on the Microphone Channel.
4. Invert the Phase switches on both Channels. (See Page 6 )
5. Insert an outboard equalizer after the Pocket Blender's output (i.e.):
  - a. **Notch Filter:** The Fishman Pro-EQ Platinum has a notch filter for eliminating low freq. feedback.
  - b. **Parametric EQ:** We suggest cutting 5 dB at the instrument's cavity resonance (see above) with a .5 octave bandwidth (Q).
  - c. **Graphic EQ:** Cut 5 dB at the instrument's cavity resonance (see above) with 1/3 octave cuts on either side of the center frequency.

## High Frequency Feedback

The microphone's rising response can create a feedback loop with a high frequency driver in your speaker system. This feedback usually starts above 1.5 kHz, peaks at 4 kHz and subsides at 9 kHz. There are several approaches to minimizing high frequency feedback:

**1. Strategic Positioning:** This works best in low to medium volume settings. The simplest solution for this type of feedback is to keep the microphone out of the path of the loudspeaker.

You can do this by:

- a. Avoid standing directly in front of your amp.
- b. Send separate mix and transducer signals to your soundman and have only the transducer signal sent to your stage monitor.

**2.** Turn down the treble control on microphone channel.

**3.** Reverse phase switches on both channels.

**4.** Insert an outboard equalizer after the Pocket Blender's output (i.e.):

**a. EQ with sweepable frequencies:** The Fishman Pro EQ Platinum has sweepable frequencies to let you dial out high freq. feedback.

**b. Parametric EQ:** We suggest cutting 5 dB at 4 kHz, with a 1.5 octave bandwidth (Q).

**c. Graphic EQ:** Cut 3 dB at 1.2 kHz. Gradually increase the amount of cut to -9 dB at 4-5 kHz. Above 5 kHz, gradually decrease the amount of cut to -3 dB at 10 kHz.

FIG. 1

EQ SETTING TO REDUCE LOW FREQUENCY  
RESONANCE (GUITAR AS EXAMPLE)

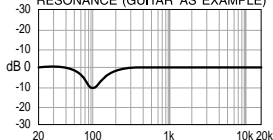
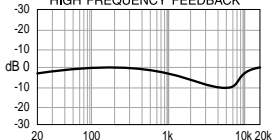
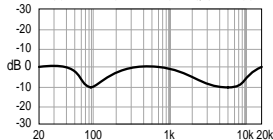

FIG. 2

EQ SETTING TO REDUCE  
HIGH FREQUENCY FEEDBACK



COMBINED LOW AND HIGH EQ SETTINGS



## Limited Warranty

The FISHMAN Pocket Blender is warranted to function for a period of One (1) Year from the date of purchase. If the unit fails to function properly within the warranty period, free repair and the option of replacement or refund in the event that FISHMAN is unable to make repair are FISHMAN's only obligations. This warranty does not cover any consequential damages or damage to the unit due to misuse, accident, or neglect. FISHMAN retains the right to make such determination on the basis of factory inspection. Products returned to FISHMAN for repair or replacement must be shipped in accordance with the Return Policy, as follows. This warranty remains valid only if repairs are performed by FISHMAN. This warranty gives you specific legal rights and you may also have other rights which may vary from state to state.

### Return Policy

To return products to FISHMAN TRANSDUCERS, you must follow these steps...

1. Call FISHMAN TRANSDUCERS at 978-988-9199 for a Return Authorization Number ("RAN").
2. Enclose a copy of the original Bill of Sale as evidence of the date of purchase, with the product in its original packaging and a protective carton or mailer.
3. FISHMAN TRANSDUCERS' technicians will determine whether the item is covered by warranty or if it instead has been damaged by improper customer installation or other causes not related to defects in material or workmanship.
4. Warranty repairs or replacements will be sent automatically free of charge.
5. If FISHMAN TRANSDUCERS determines the item is not covered by warranty, we will notify you of the repair or replacement cost and wait for your authorization to proceed.

**FISHMAN TRANSDUCERS**  
**340-D Fordham Road Wilmington MA 01887 USA**  
**Phone 978-988-9199 • Fax 978-988-0770**  
**www.fishman.com**

Rev 2 • 4-11-02 • 009-010-001

**FISHMAN®**  
*Acoustic Power*