



Pa50
professional arranger

USER'S MANUAL



ENGLISH
Ver. 1.0

KORG

IMPORTANT SAFETY INSTRUCTIONS

WARNING — When using electrical products, basic precautions should be followed, including the following:

Location. Using the unit in the following locations can result in a malfunction.

- In direct sunlight
- Locations of extreme temperature or humidity
- Excessively dusty or dirty locations
- Locations of excessive vibration

Power supply. Please connect the designated AC adapter to an AC outlet of the correct voltage. Do not connect it to an AC outlet of voltage other than that for which your unit is intended.

Interference with other electrical devices. This product contains a microcomputer. Radios and televisions placed nearby may experience reception interference. Operate this unit at a suitable distance from radios and televisions.

Handling. To avoid breakage, do not apply excessive force to the switches or controls.

Care. If the exterior becomes dirty, wipe it with a clean, dry cloth. Do not use liquid cleaners such as benzene or thinner, or cleaning compounds or flammable polishes.

Keep this manual. After reading this manual, please keep it for later reference.

Keeping foreign matter out of your equipment.

- Never set any container with liquid in it near this equipment. If liquid gets into the equipment, it could cause a breakdown, fire, or electrical shock.
- Be careful not to let metal objects get into the equipment. If something does slip into the equipment, unplug the AC adapter from the wall outlet. Then contact your nearest Korg dealer or the store where the equipment was purchased.

**KEEP THESE INSTRUCTIONS
CLEAN ONLY WITH A DRY CLOTH**

THE FCC REGULATION WARNING (FOR THE U.S.A. AND CANADA ONLY)

This equipment has been tested and found to comply with the limits for a Class B digital device, pursuant to Part 15 of the FCC Rules. These limits are designed to provide reasonable protection against harmful interference in a residential installation. This equipment generates, uses, and can radiate radio frequency energy and, if not installed and used in accordance with the instructions, may cause harmful interference to radio communications. However, there is no guarantee that interference will not occur in a particular installation. If this equipment does cause harmful interference to radio or television reception, which can be determined by turning the equipment off and on, the user is encouraged to try to correct the interference by one or more of the following measures:

- Reorient or relocate the receiving antenna.
- Increase the separation between the equipment and receiver.
- Connect the equipment into an outlet on a circuit different from that to which the receiver is connected.
- Consult the dealer or an experienced radio/TV technician for help.

Unauthorized changes or modification to this system can void the user's authority to operate this equipment.

CE MARK FOR EUROPEAN HARMONIZED STANDARDS

CE mark which is attached to our company's products of AC mains operated apparatus until December 31, 1996 means it conforms to EMC Directive (89/336/EEC) and CE mark Directive (93/68/EEC).

And, CE mark which is attached after January 1, 1997 means it conforms to EMC Directive (89/336/EEC), CE mark Directive (93/68/EEC) and Low Voltage Directive (73/23/EEC).

Also, CE mark which is attached to our company's products of Battery operated apparatus means it conforms to EMC Directive (89/336/EEC) and CE mark Directive (93/68/EEC).

DATA HANDLING

Data in memory may sometimes be lost due to incorrect user action. Be sure to save important data to floppy disk. KORG will not be responsible for damages caused by data loss.

LCD DISPLAY

Some pages of the manuals show LCD screens along with an explanation of functions and operations. All sound names, parameter names, and values are merely examples and may not always match the actual display you are working on.

TRADEMARKS

Macintosh is a registered trademark of Apple Computer, Inc. MS-DOS and Windows are registered trademarks of Microsoft Corporation. All trademarks or registered trademarks are the property of their respective holders.

DISCLAIMER

The information contained in this manual have been carefully revised and checked through. Due to our constant efforts to improve our products, the specifications might differ to those in the manual. KORG is not responsible for any eventual differences found between the specifications

and the contents of the instruction manual - the specifications being subject to change without prior notice

LIABILITY

KORG products are manufactured under strict specifications and voltages required by each country. These products are warranted by the KORG distributor only in each country. Any KORG product not sold with a warranty card or carrying a serial number disqualifies the product sold from the manufacturer's/distributor's warranty and liability. This requirement is for your own protection and safety.

SERVICE AND USER'S ASSISTANCE

For service, please contact your nearest Authorized KORG Service Center. For more information on KORG products, and to find software and accessories for your keyboard, please contact your local Authorized KORG distributor.

PA50 ON THE WEB

For up-to-date information, please, point your web browser to <http://www.korgpa.com>.

Copyright © 2003 KORG Italy Spa. Printed in China.

THE BALANCE SLIDER

When turning the instrument on, please be assured the BALANCE slider is set to the center. This sets both Sequencer 1 (SEQ1) and Sequencer 2 (SEQ2) to their maximum level. This will avoid you start a Song without hearing anything.

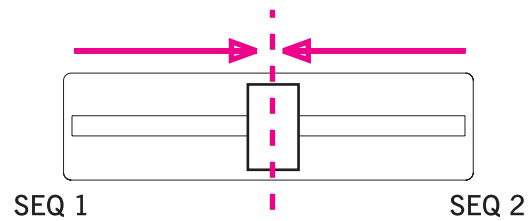

HOW TO...

Keyboard

...select a Sound Program	26
...select a Performance	25
...play a Sound Program across the whole keyboard, as with a piano	24
...split the keyboard in two	24
...add sounds to the right hand	24
...mute/unmute sounds	24

Style Play mode

...select a Style	26
...start/stop the Style	29
...select a Fill or a Break	29
...select a Style Variation	30
...see the Style tracks	41
...create a new Style	52

Song Play mode

...play a Song (Standard MIDI File)	27
...see the Lyrics	74
...see the Song tracks	73
...start both Sequencers at the same time	18, 79

Backing Sequence mode

...record a new Backing Sequence (Song)	82
---	----

Song mode

...record a new Song	91
...edit a Standard MIDI File	88

In general

...turn the speakers off	125
...change the Damper polarity	126
...select the Arabic Scale	34

TABLE OF CONTENTS

Introduction

Welcome!	8
Live Performing	8
Useful links	8
About this manual	8
Making a backup copy of system files	8
Loading the operating system	9
Reloading the Factory Data	9

Start up	10
Connecting the AC power adapter	10
Turning the instrument on and off	10
Controlling the Volume	10
The BALANCE slider	10
Headphones	10
Audio Outputs	10
Audio Inputs	10
MIDI connections	10
Damper Pedal	11
Demo	11
The music stand	11

Front panel	12
--------------------------	-----------

Display and User Interface	19
Display controls	19
Interface structure	20
Message windows	21
Symbols and Icons	21
Grayed-out non-available parameters	21

Rear panel	22
-------------------------	-----------

Basic Guide

Basic operations	24
Playing on the keyboard	24
Selecting, muting/unmuting and soloing a track	24
Selecting a Performance	25
Selecting a Program	26
Selecting a Style	26
Selecting a Single Touch Setting (STS)	27
Changing all keyboard tracks at once	27
Playing a Song from Floppy disk	27
Shortcut to see the original bank for a Style, Performance or Program	27

Tutorial	28
1 - Playing in realtime	28
2 - Playing a Style	29
3 - Playing a Song	30
4 - Recording a Song	31
5 - Editing a Song	32
6 - The Arabic Scale	34

MIDI	35
What is MIDI?	35
Midifiles	35
The General MIDI standard	35
The Global channel	35

The Chord 1 and Chord 2 channels	36
The Control channel	36
MIDI Setup	36
Connecting Pa50 to a Master keyboard	36
Connecting the Pa50 to a MIDI accordion	37
Connecting the Pa50 to an external sequencer	37
Playing another instrument with the Pa50	38

Reference Guide

Style Play operating mode	40
What's a Style?	40
Styles and Performances	40
Changing and resetting the Tempo	40
The DIRECT FD bank	40
Main page	41
Style tracks page	41
How to select Programs	41
The Write window	42
Menu	42
Edit page structure	42
Page 1 - Mixer: Volume	43
Page 2 - Mixer: Pan	43
Page 3 - Mixer: FX Send	43
Page 4 - Tuning: Detune	44
Page 5 - Tuning: Scale	44
Page 6 - Tuning: PitchBend Sensitivity	44
Page 7 - FX: A/B Select	44
Page 8 - FX: C/D Select	44
Page 9 - FX: A editing	45
Page 10 - FX: B editing	45
Page 11 - FX: C editing	45
Page 12 - FX: D editing	45
Page 13 - Track: Easy edit	45
Page 14 - Track: Mode	46
Page 15 - Track: Internal/External	46
Page 16 - R.T. controls: Damper	47
Page 17 - R.T. controls: Joystick	47
Page 18 - R.T. controls: Dynamic range	47
Page 19 - R.T. controls: Ensemble	47
Page 20 - Style controls: Drum/Fill	48
Page 21 - Style controls: Wrap Around / Keyboard Range	49
Page 22 - Pads	49
Page 23 - Preferences: Lock	49
Page 24 - Preferences: controls	50
Style Record mode	52
The Style's structure	52
Style Import/Export	53
Entering the Record mode	53
Listening to the Style while in Record/Edit mode	53
Exit and Save/Abort Style	53
The Write window	54
List of recorded events	54
Fast Delete using the control panel buttons	54
Main page	55
Style Tracks page	56

Step Record page	57	Load Song page	84
Style Record procedure	58	Save Song page	84
Menu	61	Realtime Recording page	85
Edit page structure	61	Chord/Acc Step Recording page	85
Page 1 - Edit: Quantize	62	How to delete a whole Song	87
Page 2 - Edit: Transpose	62	Song operating mode	88
Page 3 - Edit: Velocity	63	Transport controls	88
Page 4 - Event Edit	63	Master Volume and Sequencer Volume	88
Page 5 - Event Filter	64	The Songs and the Standard MIDI File format	88
Event Edit procedure	64	Fast track deletion	88
Page 6 - Edit: Delete	66	How to delete a whole Song	88
Page 7 - Edit: Delete All	66	Main page	88
Page 8 - Edit: Copy	67	Tracks 1-8 page	89
Page 9 - Style Element Controls: Programs	67	Tracks 9-16 page	89
Page 10 - Style Element Controls: Expression	68	Song Select page	89
Page 11 - Style Element Controls: Keyboard Range	68	Save Song page	90
Page 12 - Style Element Controls: Chord Variation		Realtime Record procedure	91
Table	68	Step Record procedure	91
Page 13 - Style Controls: Mode/Tension	68	Song Record page	93
Song Play operating mode	70	Step Record page	94
The Songs and the Standard MIDI File format	70	Menu	95
Transport controls	70	Edit page structure	95
MIDI Clock	70	Page 1 - Mixer: Volume	95
Switching between sequencers during editing	70	Page 2 - Mixer: Pan	95
Selecting a Song composing its progressive number	70	Page 3 - Mixer: FX Block	96
Realtime and sequencer tracks	70	Page 4 - Mixer: FX Send A/B (or C/D)	96
Master Volume, Sequencer Volume, BALANCE	71	Page 5 - Tuning: Detune	96
Effects in Song Play mode	71	Page 6 - Tuning: Scale	97
Groove Quantize window	71	Page 7 - Tuning: PitchBend/Scale	97
The Write window	72	Page 8 - FX: A/B Select	97
Main page	72	Page 9 - FX: C/D Select	97
Tracks 1-8 page	73	Page 10 - FX: A editing	98
Tracks 9-16 page	73	Page 11 - FX: B editing	98
Song Select page	73	Page 12 - FX: C editing	98
The Lyrics page	74	Page 13 - FX: D editing	98
Playing a Jukebox file	74	Page 14 - Track: Easy edit	98
Menu	75	Page 15 - Track: Mode	99
Edit page structure	75	Page 16 - Track: Internal/External	99
Page 1 - Mixer: Volume	75	Page 17 - Edit: Quantize	100
Page 2 - Mixer: Pan	76	Page 18 - Edit: Transpose	100
Page 3 - Mixer: FX send A/B	76	Page 19 - Edit: Velocity	100
Page 3 - Mixer: FX send C/D	76	Page 20 - Edit: Delete	101
Page 4 - FX: A/B Select	77	Page 21 - Edit: Cut Measures	101
Page 4 - FX: C/D Select	77	Page 22 - Edit: Insert Measures	101
Page 5 - FX: A editing	77	Page 23 - Edit: Copy	102
Page 6 - FX: B editing	77	Page 24 - Event Edit	102
Page 5 - FX: C editing	77	Page 25 - Event Filter	103
Page 6 - FX: D editing	78	Event Edit procedure	104
Page 7 - Track: Mode	78	Program operating mode	105
Page 8 - Track: Internal/External	78	Main page	105
Page 9 - Jukebox	79	Sound Programs and Drum Programs	105
Page 10 - Preferences	79	Menu	105
Saving a list of Songs	80	Edit page structure	105
Backing Sequence operating mode	82	The Compare function	106
Transport controls	82	How to select oscillators	106
The Backing Sequence, Song and Song Play modes	82	Erase Program/Oscillator	106
How to playback a Song	82	The 'Write' window	106
Realtime Recording mode	82	Page 1 - Basic	106
Chord/Acc Step recording	83	Page 2 - Sample (Sound Programs)	107
Main Page (Backing Sequence Play)	83	Page 2 - DK Samples (Drum Programs)	108

Page 3 - Pitch	109
Page 4 - Pitch LFO1	110
Page 5 - Pitch LFO2	110
Page 6 - Pitch EG	110
Page 7 - Filter	112
Page 8 - Filter Modulation	113
Page 9 - Filter LFO1	114
Page 10 - Filter LFO2	115
Page 11 - Filter EG	115
Page 12 - Amp	117
Page 13 - Amp Modulation	117
Page 14 - Amp LFO1	118
Page 15 - Amp LFO2	118
Page 16 - Amp EG	118
Page 17 - LFO1	120
Page 18 - LFO2	121
Page 19 - Effects	121
Page 20 - FX1 editing	122
Page 21 - FX2 editing	122
AMS (Alternate Modulation Source) list	123
Global edit environment	125
The Write window	125
Menu	125
Page 1 - General controls	125
Page 2 - Master Transpose	126
Page 3 - Assignable Pedal/Footswitch, Assignable Slider	126
Page 4 - MIDI Setup	126
Page 5 - MIDI Controls	127
Page 6 - MIDI IN Channels	127
Page 7 - MIDI IN Controls (1)	128
Page 8 - MIDI IN Controls (2)	128
Page 9 - MIDI IN Filters	129
Page 10 - MIDI OUT Channels	129
Page 11 - MIDI OUT Filters	129
Disk edit environment	130
The WRITE/DISK IN USE LED	130
Floppy disk handling	130
Loading data created with the Pa80	131
Loading older i-Series data	131
Disk structure	132
File types	132
File and folder size display	132
Page structure	133
Navigation tools	133
Menu	133
Page 1 - Load	133
Page 2 - Save	135
Page 3 - Copy	139

Page 4 - Erase	140
Page 5 - Format	140
Page 6 - New Dir	140
Page 7 - Rename	141
Page 8 - Utilities 1	141
Page 9 - Utilities 2	142

Appendix

Factory Data	144
Styles	144
Style Elements	146
Single Touch Settings (STS)	146
Programs (bank order)	147
Programs (Program Change order)	154
Drum Kits	160
Drum Kit instruments	161
Performances	173
MIDI Setup	174
Effects	175
Diagrams	175
Dynamic Modulation sources	175
Filter/Dynamic	175
Pitch/Phase Mod.	185
Mod./P.Shift	195
ER/Delay	202
Reverb	208
Mono - Mono Chain	210
Assignable parameters	225
List of functions assignable to the Footswitch	225
List of functions assignable to the Pedal or Assignable Slider	226
List of sounds assignable to the Pads	226
List of functions assignable to the Pads	227
Scales	227
MIDI Controllers	228
MIDI Implementation Chart	229
Parameters	230
Recognized chords	233
Error messages & Troubleshooting	235
Error messages	235
Troubleshooting	238
Technical specifications	239
Alphabetical Index	240

INTRODUCTION

1. WELCOME!

Welcome to the world of KORG Pa50 Professional Arranger! Pa50 is one of the most powerful arranger available today, both for professional and home entertainment use.

Here are some of the features of your new instrument:

- Powerful HI (Hyper Integrated) KORG sound generation system, as seen in our best professional synthesizers.
- OPOS (Objective Portable Operating System) multi-tasking operating system, to let you load data while playing your instrument.
- Operating System updates, to load new features from disk. Don't let your instrument get old!
- Solid State Disk (SSD), for any system update—a smart way to replace the usual ROM memory.
- Direct Style access from floppy disk.
- General MIDI Level 2 Sounds-compatible.
- More than 660 Sound Programs.
- 4 multieffect processor, each with 89 effect types.
- 160 Performances and 1,216 Single Touch Settings (STS), for fast setting of keyboard sounds and effects.
- 304 Styles.
- XDS Double Sequencer with Crossfader.
- Style Record and Edit
- Full-featured sequencer (Song Record and Edit)
- Integrated speakers, for the most true sound reproduction.
- Wide Custom Display.

LIVE PERFORMING

Pa50 has been carefully designed to be used live. The “real-time” word has its full meaning in this instrument. **Performances** allow the instant selection of all the tracks on the keyboard and a suitable Style; **STSs** allow an instant selection of the keyboard tracks; and **Styles** are the realtime backing companions for your realtime playing.

USEFUL LINKS

Your preferred KORG dealer not only carries this keyboard, but also a whole bunch of hardware and software accessories. You should ask him for more Programs, Styles, and other useful music materials.

Each KORG distributor can supply you with useful information. Just give him a call for additional services. In the English-speaking world, here are the relevant addresses:

USA	KORG USA, 316 South Service Road, Melville, New York, 11747, USA Tel:1-516-333-9100, Fax:1-516-333-9108
Canada	Jam Industries, 620 McCaffrey, St-Laurent, QC, Canada, H4T 1N1 Tel. (514) 738-3000, Fax (514) 737-5069
UK	KORG UK Ltd, 9 Newmarket Court, Kingston, Milton Keynes, Buckinghamshire, MK10, 0AU

Telephone: 01908 857100

UK Technical Support Tel: 01908 857122, Fax: 01908 857199

E-mail: info@korg.co.uk

Many KORG distributors also have their own web page on the internet, where you can find infos and software. Useful web pages in English are the following:

www.korg.com

www.korg.co.uk

www.jam-industries.com

A place to find operating system updates and various system files (for example, a full backup of the factory data) is at the following link:

www.korgpa.com

Other useful information can be found worldwide by accessing to other KORG web sites, like the following:

www.korg.co.jp

www.korgfr.net

www.korg.de

www.korg.it

ABOUT THIS MANUAL

This manual is divided in three sections:

- A **Basic Guide**, containing an overview of the instrument, as well as a series of practical guides (named “Tutorials”).
- A **Reference Guide**, with each page and parameter described in detail.
- An **Appendix**, with a list of data and useful information for the advanced user.

Within the manual, you will find the following abbreviations:

- ▶ **PERF** The parameter can be saved onto a Performance by pressing the WRITE button.
- ▶ **STYLE** The parameter can be saved onto the current Style Performance by pressing the WRITE button.
- ▶ **STS** The parameter can be saved onto a Single Touch Setting by pressing the WRITE button.
- ▶ **GBL** The parameter can be saved onto the Global, by going to the Global environment (see “Global edit environment” on page 125) and pressing the WRITE button.

MAKING A BACKUP COPY OF SYSTEM FILES

Before starting playing with your new Pa50, we suggest you make a back-up copy of all system data, including Programs, Performances and Styles, in case the internal data is changed.

To backup the Operating System, please see “Save OS” on page 141.

To backup the Factory Data (Styles, Programs...), see “Backup Data” on page 141.

LOADING THE OPERATING SYSTEM

Your Pa50 can be constantly updated as new versions of the operating system are released by KORG. You can download the operating system from www.korgpa.com. Please, read the Readme file included with the operating system itself.

You can see which version of the operating systems is installed in your Pa50 by keeping the SHIFT button pressed, and pressing the ENTER and EXIT buttons together. The operating system version number will appear in the display. Press EXIT to close the message window.

To load a new system, follow these instructions:

1. Copy the three operating system's files in an empty, MS-DOS® formatted, HD-type floppy disk. These are the needed files:
 - OSPa50.LZX
 - BPa50.SYS
 - NBPa50.SYS

2. Turn the instrument off, and insert the operating system disk into the disk drive.
3. Turn the instrument on. A message appears in the display, asking if you want to load the operating system.
4. Press ENTER to load, or EXIT to cancel the loading procedure. If you press ENTER, wait until the loading is finished.

When the operating system is finished loading, a message appears, asking you to remove the floppy disk and press any button.

5. Remove the floppy disk, and press any button.

RELOADING THE FACTORY DATA

Should the internal memory content get damaged, you can reload the original Factory Data from the backup disks. See "Restore Data" on page 142.

2. START UP

CONNECTING THE AC POWER ADAPTER

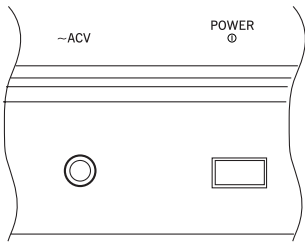

Connect the supplied AC power adapter to the dedicated socket on the rear of the instrument. Then, plug it into a wall socket.

Warning: Use only the supplied adapter, or an adapter suggested by Korg. Other adapters may look similar, but they may damage your instrument!

TURNING THE INSTRUMENT ON AND OFF

- Press the POWER switch on the rear panel to turn the instrument on. The display will light up, showing a welcome message.
- Press again the POWER switch on the rear panel to turn the instrument off.

Warning: When turning the instrument off, all data contained in RAM (a volatile memory, used for Song editing) will be lost. On the contrary, data contained in the SSD disk (a non-volatile memory, used for Factory and User data) will be preserved (see “Memory Mode” on page 51).

CONTROLLING THE VOLUME

- Use the MASTER VOLUME slider to control the overall volume of the instrument. This slider controls the volume of the sound going to the internal speakers, the L/MONO & RIGHT OUTPUTS, and the HEADPHONES connector.

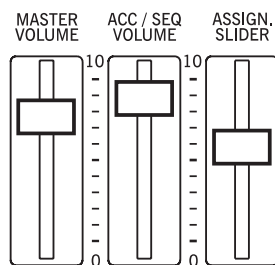

Note: Start at a moderate level, then raise the MASTER VOLUME up. Don't keep the volume at an uncomfortable level for too long.

- Use the ACC/SEQ VOLUME slider to control the Style tracks (drums, percussion, bass...) volume. This slider also controls both Sequencers tracks, excluding the Realtime (Keyboard) tracks.
- By default, you can use the ASSIGN.SLIDER to control the keyboard tracks volume. This slider is user-assignable, but is set to the Keyboard Expression parameter by default.

THE BALANCE SLIDER

The BALANCE slider sets the relative volume of the two onboard sequencers (Sequencer1 and Sequencer 2).

- Move it fully left to set Sequencer 1 to the maximum level and Sequencer 2 to zero.

- Move it fully right to set Sequencer 1 to zero and Sequencer 2 to the maximum level.
- Move it to the center to set both Sequencer at the same level.

Note: When turning the instrument on, move this slider to the center, to avoid starting a Song at the minimum level.

HEADPHONES

Connect a pair of headphones to the PHONES output, on the rear of the instrument. You can use headphones with an impedance of 16-200Ω (50Ω suggested). Use a headphone distributor to connect more than one pair of headphones.

AUDIO OUTPUTS

You can send the sound to an external amplification system, instead of the internal speakers. This is useful when recording, or when playing live.

Stereo. Connect two mono cables to the L/MONO & RIGHT OUTPUTS. Connect the other end of the cables to a stereo channel of your mixer, two mono channels, two powered monitors, or the TAPE/AUX input of your audio system. Don't use the PHONO inputs of your audio system!

Mono. Connect a mono cable to the L/MONO OUTPUT. Connect the other end of the cable to a mono channel of your mixer, a powered monitor, or a channel of your TAPE/AUX input of a hi-fi system (you will hear that channel only, unless you can set the amplifier to Mono mode).

AUDIO INPUTS

Connect any other electronic musical instrument, a mixer's output (non-powered), or a CD/tape player, to the INPUTS on the back of the instrument. These inputs expect a line-level signal. To connect a microphone, you need a dedicated microphone preamplifier or a mixer.

Use the connected device's volume control to adjust the input level. Be careful not to make it distort (or “clip”). Here is how to set the volume of the connected device:

- if the sound heard on Pa50's outputs is too low, you should increase the output level of the connected device.
- if it sounds fine, it's ok.
- if it distorts, you should lower the level a little, until the sounds is fine again.

MIDI CONNECTIONS

You can play the internal sounds of your Pa50 with an external controller, i.e. a master keyboard, a MIDI guitar, a wind controller, a MIDI accordion, or a digital piano.

1. Connect a standard MIDI cable from the MIDI OUT of your controller to the MIDI IN connector on the Pa50.
2. Select a transmission MIDI channel on your controller. Some controllers, like the MIDI accordions, usually transmit on more than one channel (see more information in the MIDI chapter).

3. On the Pa50, select the MIDI Setup that best fit your controllers type (see “Page 4 - MIDI Setup” on page 126).

DAMPER PEDAL

Connect a Damper (Sustain) pedal to the DAMPER connector on the back panel. Use a KORG PS1, PS2 or DS1H foot-switch pedal, or a compatible one. To switch the Damper polarity, see “Damper Pol. (Damper Polarity)” on page 126

DEMO

Listen to the built-in Demo Songs to appreciate the power of the Pa50. There are 16 Demo Songs to choose from.

1. Press the STYLE PLAY and SONG PLAY buttons together. Their LEDs start blinking.
At this point, if you don't press any other button, all the Demo Songs will be played back.
2. Choose a page using the PAGE buttons. There are two different pages in the Demo mode.
3. Select a Demo Song by pressing the corresponding VOLUME/VALUE button around the display. The Demo will automatically start.
4. Stop the Demo by pressing START/STOP.
5. Exit the Demo mode by pressing one of the MODE buttons.

THE MUSIC STAND

A music stand comes standard with your Pa50. Fit it into the two dedicated holes in the back panel.

3. FRONT PANEL

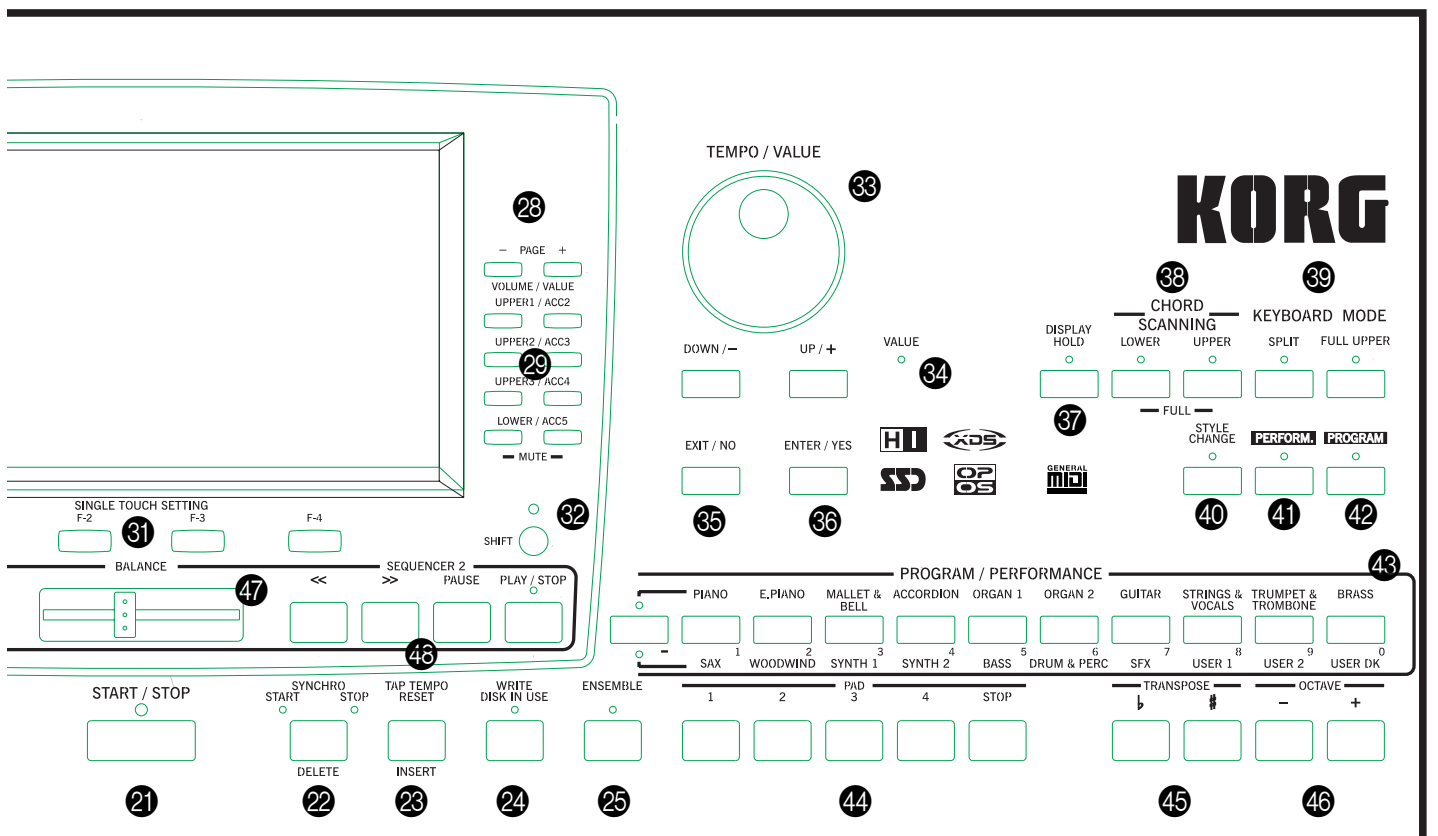
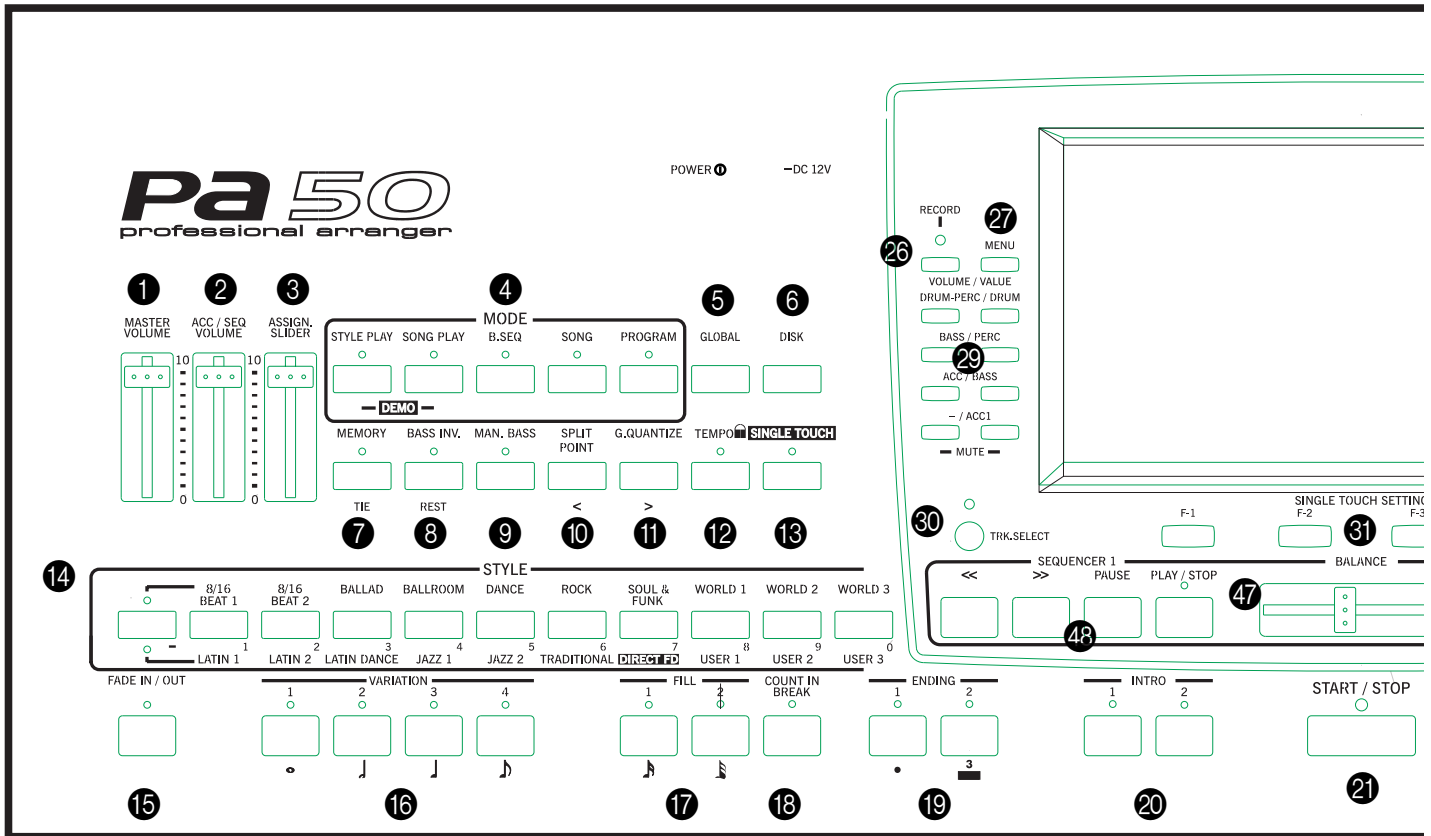

1 MASTER VOLUME

This slider controls the overall volume of the instrument, both of the internal speakers, the L/MONO and RIGHT outputs, and the HEADPHONES output.

Warning: At the maximum level, with rich-sounding Songs, Styles or Programs, the internal speakers could distort during signal peaks. Should this happen, lower the Master Volume a little.

2 ACC/SEQ VOLUME

This slider controls the accompaniment tracks volume (Style Play mode) or the Song tracks volume, excluding the Realtime tracks (Song and Song Play modes). This is a relative control, whose effective maximum value is determined by the MASTER VOLUME slider position.

3 ASSIGN.SLIDER

This is a freely programmable slider (see “Sld (Slider)” on page 126). By default, it acts as the Keyboard Expression control, to let you balance the relative volume of the Realtime (Keyboard) tracks.

4 MODE section

Each of these buttons recalls one of the operating modes of the instrument. Each mode excludes the others.

STYLE PLAY

Style Play mode, where you can play Styles (automatic accompaniments) and/or play up to four Realtime tracks on the keyboard.

In the main page, Realtime (Keyboard) tracks are shown on the right half of the display. You can reach the main page by pressing EXIT from any of the Style Play edit pages. If you are in a different operating mode, press STYLE PLAY to recall the Style Play mode. If the TRACK SELECT LED is on, press TRACK SELECT to turn it off and see the Realtime tracks.

This operating mode is automatically selected when turning the instrument on.

SONG PLAY

Song Play mode, where you can playback 16-track Songs in Standard Midi File (SMF) format directly from disk. You can play “.MID” and “.KAR” files directly from the floppy disk. Since the Pa50 is equipped with two sequencers, you can even play two Songs at the same time, and mix them with the BALANCE slider. In addition to the Song tracks, you can play one to four Realtime (Keyboard) tracks, along with the Song(s). In the main page, Realtime (Keyboard) tracks are shown on the right half of the display. You can reach the main page by pressing EXIT from any of the Song Play edit pages. If you are in a different operating mode, press SONG PLAY to recall the Song Play mode. If the TRACK SELECT LED is on or flashing, press TRK SELECT one or two times to turn it off and see the Realtime tracks.

B.SEQ

Backing Sequence mode, where you can record a new Song based on the Realtime and Style tracks, and save it as a new Standard MIDI File.

SONG

Song mode, where you can play, record, or edit a Song.

PROGRAM

Program mode, to play single Sound Programs on the keyboard, or edit them.

DEMO

Press the STYLE PLAY and SONG PLAY buttons together to select the Demo mode. This mode lets you listen to some Demo Songs, to let you hear the sonic power of the Pa50.

5 GLOBAL

This button recalls the Global edit environment, where you can execute various global settings. This edit environment overlaps any operating mode, that still remains active in the background. Press EXIT to go back to the underlying operating mode.

6 DISK

This button recalls the Disk edit environment, where you can execute various operations on files and disks (Load, Save, Format, etc...). This edit environment overlaps any operating mode, that still remains active in the background. Press EXIT to go back to the underlying operating mode.

7 MEMORY (TIE)

This button turns the Lower and Chord Memory functions on or off. Go to the “Page 24 - Preferences: controls” edit page (Style Play mode, see page 50) to decide if this button should be a Chord Memory only, or a Lower/Chord Memory button. When it works as a Lower/Chord Memory:

ON The sound on the left of the split point, and the chord for the automatic accompaniment, are kept in memory even when you raise your hand from the keyboard.

OFF The sound and chords are released as soon as you raise your hand from the keyboard.

▶ This button doubles as a TIE function for the Song mode (see chapter 13).

8 BASS INVERSION (REST)

This button turns the Bass Inversion function on or off.

ON The lowest note of a chord played in inverted form will always be detected as the root note of the chord. Thus, you can specify to the arranger composite chords such as Am7/G or “F/C”.

OFF The lowest note is scanned together with the other chord notes, and is not always considered as the root note.

▶ This button doubles as a REST function for the Song mode (see chapter 13).

9 MANUAL BASS

This button turns the Manual Bass function on or off.

Note: When you press the MANUAL BASS button, the Bass track volume is automatically set to the maximum value. The volume is automatically set back to the original value when the MANUAL BASS button is deactivated.

- ON The automatic accompaniment stops playing (apart for the Drum and Percussion tracks), and you can manually play the Bass track on the Lower part of the keyboard. You can start the automatic accompaniment again by pressing one of the CHORD SCANNING buttons.
- OFF The bass track is automatically played by the Style.

10 SPLIT POINT (<) ▶ GBL

Keep this button pressed to open the Split Point window. While this window is open, you can set the split point, simply by playing the split point note on the keyboard. Then, release the SPLIT POINT button.

To memorize the selected split point note, press the GLOBAL button, then press WRITE to save the Global in memory (see “The Write window” on page 125).

▶ This button doubles as a PREVIOUS EVENT function for the Backing Sequence and Song modes (see chapters 12 and 13).

11 G.QUANTIZE (>)

Press this button to open the Groove Quantize window, where you can select a realtime groove quantization to be applied to the Song (only Sequencer 1). See “Groove Quantize window” on page 71.

▶ This button doubles as a NEXT EVENT function for the Backing Sequence and Song modes (see chapters 12 and 13).

12 TEMPO (= LOCK)

This button turns the Tempo Lock function on or off.

- ON When you select a different Style or Performance, the tempo doesn't change. You can still change it using the DIAL or the TEMPO buttons.
- OFF When you select a different Style or Performance, the memorized tempo value is automatically selected.

13 SINGLE TOUCH

This button turns the Single Touch function on or off.

- ON When a different Style (or the same again) is selected, a Single Touch Setting (STS1) is automatically selected, meaning that the Realtime tracks and effects will change, together with the Style tracks and effects.
- OFF When you select a different Style (or the same again), the Style tracks and effects are changed, while the Realtime tracks are not changed.

14 STYLE section (NUMERIC KEYPAD)

Use these buttons to open the Style Select window and select a Style. See “Selecting a Style” on page 26.

The leftmost button lets you select the upper or lower row of Style banks. Press it repeatedly to select one of the rows. (After both LEDs have turned on, press the button again to turn them off).

UPPER LED ON

Upper-row Styles selected.

LOWER LED ON

Lower-row Styles selected.

A word about Style banks and names. Styles from “8/16 BEAT” to “WORLD 3”, and from “LATIN1” to “TRADITIONAL” are standard Styles, the user can't normally overwrite with a Load operation (unless you remove the protection; see “Factory Style Protect” on page 142).

“DIRECT FD” Styles are Styles directly accessed from floppy disk (no need to load from disk). See “The DIRECT FD bank” on page 40.

Styles from “USER1” to “USER3” are location where you can load new Styles from disk.

Each button (Style bank) contains 2 pages, each with up to 8 Styles. Browse through the Styles using the PAGE buttons.

Shortcut to see the original bank for a Style. You can see the original bank where a Style is contained. Just keep the SHIFT button pressed, and press the leftmost button of the STYLE section. A message window will appear, showing the name of the original bank. Release the SHIFT button to exit the window.

Shortcut to see all pages of the selected bank. To cycle all pages for a selected bank, repeatedly press the bank's button.

▶ These buttons double as a numeric keypad on certain pages (see “Selecting a Song composing its progressive number” on page 70).

15 FADE IN/OUT

When the Style is in stop, press this button to start it with a volume fade-in (the volume goes from zero to the maximum).

When the Style is in play, press this button to stop it with a volume fade-out (the volume gradually decreases).

You don't need to press START/STOP to start or stop the Style.

16 VARIATION 1-4 (NOTE LENGTH) buttons

▶ PERF ▶ STYLE

Each of these buttons select one of the four variations of the current Style. Each variation can vary in patterns and sounds.

▶ These buttons double as a NOTE LENGTH function for the Song mode (see chapter 13).

17 FILL 1-2 (NOTE LENGTH) buttons ▶ PERF ▶ STYLE

These two buttons trigger a fill-in. Press them twice (LED blinking) to let them play in loop, and select any other Style element (Fill, Intro, Variation...) to exit the loop.

▶ They also double as a NOTE LENGTH function for the Song mode (see chapter 13).

18 COUNT IN / BREAK ▶ PERF ▶ STYLE

While the Style is not running, press this button, then press START/STOP. This combination triggers a one-bar initial count, then the Style starts playing.

While the Style is already in play, this button triggers a break (an empty measure beginning with a kick + crash shot). Press it twice to let it play in loop, and select any other Style element (Fill, Intro, Variation...) to exit the loop.

19 ENDING 1-2 (DOT, TRIPLET) buttons ▶ PERF ▶ STYLE

While the Style is running, these two buttons trigger an Ending, and stop the Style. Press one of them, and the Style will stop running with an Ending. If pressed while the Style is stopped, they act as an additional couple of Intros.

Press them twice (LED blinking) to let them play in loop, and select any other Style element (Fill, Intro, Variation...) to exit the loop.

▶ ENDING1 also doubles as a DOT function, and ENDING2 doubles as a TRIPLET function, to be used in Song mode (see chapter 13).

Note: Ending 1 plays a short sequence with different chords, while Ending 2 plays on the last recognized chord.

20 INTRO 1-2 buttons ▶PERF ▶STYLE

These two buttons set the arranger in Intro mode. After pressing one of these buttons, start the Style, and it will begin with the selected intro. The INTRO LED automatically goes off at the end of the intro.

Press them twice (LED blinking) to let them play in loop, and select any other Style element (Fill, Intro, Variation...) to exit the loop.

Note: Intro 1 plays a short sequence with different chords, while Intro 2 plays on the last recognized chord.

21 START/STOP

Starts or stops the Style running.

SHIFT You can reset all 'frozen' notes and controllers on the Pa50 and any instrument connected to its MIDI OUT, by using the "Panic" key combination. Just press SHIFT + START/STOP to stop all notes and reset all controllers.

22 SYNCHRO START / STOP (DELETE)

This button turns the Synchro Start and Synchro Stop functions on or off. Press it repeatedly to turn the functions on or off. The LEDs cycle in this order: START → START+STOP → OFF.

START LED ON

When this LED is lit, just play a chord in the chord recognition area (usually under the split point, see "CHORD SCANNING section" on page 17) to automatically start the Style running. If you like, you can turn one of the INTROs on before starting the Style.

START+STOP LEDs ON

When both LEDs are lit, raising your hand from the keyboard momentarily stops the Style running. If you play a chord again, the Style starts again.

OFF All Synchro functions are turned off.

▶ This button doubles as a DELETE function for the Backing Sequence and Song modes (see chapters 12 and 13).

It is also used to delete the selected character, during text editing.

23 TAP TEMPO/RESET (INSERT)

This is a double-function button, acting in a different way depending on the Style status (stop/play).

Tap Tempo: When the Style is not playing, you can "beat" the tempo on this button. At the end, the accompaniment starts playing, using the "tapped in" tempo.

Reset: When you press this button while the Style is in play, the Style pattern goes back to the previous strong beat.

▶ This button doubles as a INSERT function for the Backing Sequence and Song modes (see chapters 12 and 13).

It is also used to insert a character at the cursor position, during text editing.

24 WRITE/DISK IN USE

In Style Play mode, this button opens the Write window, that lets you save all the tracks onto a Performance, the Realtime (Keyboard) tracks in a Single Touch Setting (STS), or the accompaniment tracks onto a Style Performance. (See "The Write window" on page 42).

In the Global edit environment, press it to save Global parameters in memory. (See "The Write window" on page 125).

▶ This button's LED doubles as a DISK IN USE indicator, flashing when the floppy disk drive is in use.

25 ENSEMBLE ▶PERF ▶STS

This button turns the Ensemble function on or off. When on, the right-hand melody is harmonized with the left-hand chords.

Note: The Ensemble function works only when the keyboard is in SPLIT mode, and the LOWER Chord Scanning mode selected.

26 RECORD

This button sets the instrument in Record mode (depending on the current operating mode).

27 MENU

This button opens the Menu page for the current operating mode or edit environment. After opening a menu, you can jump to one of the edit pages by pressing the corresponding VOLUME/VALUE buttons; or browse them using the PAGE buttons. Otherwise, go back to the main page of the current operating mode, or close the edit environment, by pressing the EXIT button.

See the relevant chapter devoted to each operating mode or edit environment, to see their "maps" in detail.

28 PAGE -/+

After pressing MENU to open a menu, use these buttons to browse the edit pages of an operating mode or editing environment. Press EXIT to go back from an edit page to the main page of the current operating mode, or to close the Global or Disk edit environment.

In addition, you can use these buttons to select a different page in a Style Select or Program Select window.

29 VOLUME/VALUE (MUTE) A-H buttons

▶PERF ▶STYLE ▶STS

Within this user's manual, each button pair is marked with an alphabetic letter (A-H). See "Display and User Interface" on page 19 for more details.

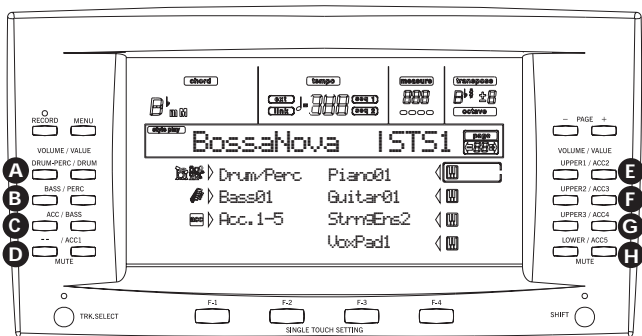

A corresponding track name is printed over each button pair. These names show the corresponding track the button pair affects in the main page of the Style Play mode.

- The left half is for the main page, where you can see the Realtime tracks, and the Style tracks grouped together:

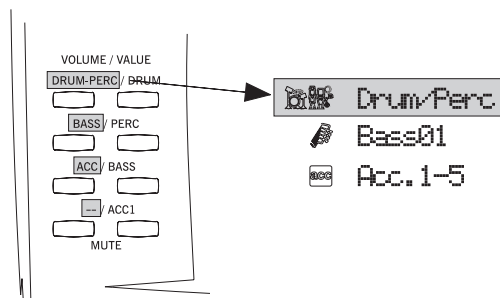

- The right half is for the Style tracks page, where you can see each of the accompaniment tracks:

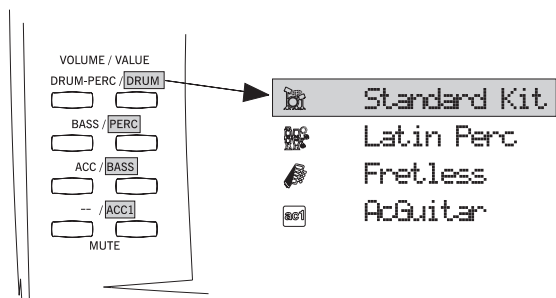

See "Symbols and Icons" on page 21.

Use these buttons to execute various operations on the commands and functions appearing in the display.

SELECTING

Use each button pair to select the corresponding item in the display (i.e. a track, a parameter or a command). Use either the left or right button in a pair.

VOLUME

While you are in the main pages of any operating mode, select a track and use these buttons to change the track's volume. Use the left button to decrease it, or the right button to increase it.

MUTE

Press both buttons in a pair to mute the corresponding track. Press both buttons again to unmute the track.

SOLO

[SHIFT] While in the Style Play, Song Play and Song modes, you can solo one of the tracks. Just keep the SHIFT button pressed, and press both VOLUME/VALUE buttons corresponding to the track you wish to solo.

To exit the solo mode, keep the SHIFT button pressed again, and press both VOLUME/VALUE buttons corresponding to the soloed track.

VALUE

Use each button pair to change the corresponding parameter's value. The left button decreases the value, the right button increases it.

30 TRACK SELECT

Depending on the operating mode, this button switches between the various tracks view.

STYLE PLAY MODE

Switches between the Realtime tracks and the Style tracks.

SONG PLAY MODE

Switches between the main page (showing the Realtime/Keyboard tracks), Song tracks 1-8, and Song tracks 9-16.

SONG MODE

Switches between the main page, Song tracks 1-8 and Song tracks 9-16.

The TRACK SELECT LED shows the current page view:

- Off Main page (Realtime tracks, or Song controls)
- On 2nd page (Style tracks, or Song tracks 1-8)
- Flashing 3rd page (Song tracks 9-16)

31 SINGLE TOUCH SETTING (F1-F4 FUNCTION KEYS) buttons

While in the main page of the Style Play or Backing Sequence mode, these buttons select a Single Touch Setting each. Each of the Styles includes a maximum of four Single Touch Settings (STS), to automatically configure the Realtime tracks and effects at the touch of a finger. When the SINGLE TOUCH LED is lit, an STS is automatically selected when selecting a Style.

▶ In Edit mode, these buttons double as function keys, to select the corresponding items in the display.

32 SHIFT

With this button held down, pressing certain other buttons accesses to a second function.

33 TEMPO/VALUE section

The DIAL and the DOWN/- and UP/+ buttons can be used to control the Tempo, assign a different value to the selected parameter in the display or scroll a list of files in the Song Select and Disk pages. The VALUE LED shows the status of this section.

DIAL

Turn the dial clockwise to increase the value or tempo. Turn it counter-clockwise to decrease the value or tempo.

[SHIFT] When used while pressing the SHIFT button, this control always acts as a Tempo control.

DOWN/- and UP/+

DOWN/- decreases the value or tempo; UP/+ increases the value or tempo.

SHIFT Keep the SHIFT button pressed down, and press either the DOWN/- or UP/+ button to reset the Tempo to the value memorized onto the selected Style.

34 VALUE LED

This LED shows the status of the DIAL and DOWN/- and UP/+ buttons.

ON The DIAL and DOWN/- and UP/+ buttons act as Value controls, to change the value of the selected parameter in the display.

OFF The DIAL and DOWN/- and UP/+ buttons control the Tempo.

35 EXIT/NO

Use this button to perform various actions, leaving from the current status:

- exit a dialog box
- answer “No” to any question that appears in the display
- exit the Menu window
- go back to the main page of the current operating mode
- exit the Global or Disk edit environment, and go back to the main page of the current operating mode
- exit from a Style, Performance or Program Select window

36 ENTER/YES

Use this button to perform various actions, agreeing the current selected status:

- answer “Yes” to any question that appears in the display
- confirm a command

37 DISPLAY HOLD

This button turns the Display Hold function on or off.

ON When you open a temporary windows (like the Program Select window), it remains in the display until you press EXIT/NO or an operating mode button.

OFF Any temporary window closes after a certain time, or after selecting an item in the window.

38 CHORD SCANNING section ▶PERF ▶STS

In Style Play and Backing Sequence mode, use these buttons to define the way chords are recognized by the arranger.

LOWER Chords are detected below the split point. The number of notes you should play to form a chord is defined by the Chord Scanning Mode parameter (see “Chord Recognition Mode” on page 50).

UPPER Chords are detected above the split point. You must always play three or more notes to let the arranger recognize a chord.

FULL (both LEDs on) Chords are detected on the full keyboard range. You must always play three or more notes to let the arranger recognize a chord.

OFF No chords detected. After pressing START/STOP, only the Drum and Percussion accompaniment tracks can play.

39 KEYBOARD MODE section ▶PERF ▶STS

These buttons define how the four Keyboard (or Realtime) tracks are positioned on the keyboard.

SPLIT The Lower track plays below the split point, while the Upper 1, Upper 2 and Upper 3 tracks play above it. By default, selecting this keyboard mode automatically selects the Lower chord scanning mode (see “Chord Recognition Mode” on page 50).

FULL UPPER The Upper 1, Upper 2 and/or Upper 3 tracks play on the whole keyboard range. The Lower track does not play. By default, selecting this keyboard mode automatically selects the Full chord scanning mode (see “Chord Recognition Mode” on page 50).

40 STYLE CHANGE

This button turns the Style Change function on or off.

ON When you select a Performance, the Style could change, according to which Style number is memorized onto the Performance.

OFF When you select a Performance, the Style and Style track settings remain unchanged. Only Realtime (Keyboard) tracks settings are changed.

41 PERFORM.

Press this button to use the PROGRAM/PERFORMANCE section to select a Performance.

42 PROGRAM

Press this button to use the PROGRAM/PERFORMANCE section to select a Program, and assign it to the selected track.

43 PROGRAM/PERFORMANCE section ▶PERF ▶STYLE ▶STS

Use these buttons to open the Program Select or Performance Select window, and select a Program or a Performance. See “Selecting a Program” on page 26, or “Selecting a Performance” on page 25. For a list of available Programs, see “Programs (Program Change order)” on page 154.

The leftmost button selects the upper or lower row of Program or Performance banks. Press it repeatedly to select one of the rows. (After both LEDs have consecutively turned on, press the button again to turn them off).

UPPER LED ON Upper row of Programs or Performances selected.

LOWER LED ON Lower row of Programs or Performances selected.

On the front panel, **Program banks** are identified by the instrument names, while **Performance banks** are identified by numbers (1-10; 0=bank 10).

A note about Program banks and names. Programs from “PIANO” to “SFX” are standard Programs, the user can’t directly modify.

Programs “USER1” and “USER2” are locations where you can load new Programs from disk.

“USER DK” is where you can load new drum kits.

Each Program bank contains various pages, each with up to 8 Programs. You can browse them using the PAGE buttons.

Shortcut to see the original bank for a Performance or Program. You can see the original bank where a Performance or Program is contained. Just keep the SHIFT button pressed, and press the leftmost button of the PROGRAM/PERFORMANCE section. A message window will appear, showing the name of the original bank. Release the SHIFT button to exit the window.

Shortcut to see all pages of the selected bank. To cycle all pages for a selected bank, repeatedly press the bank’s button.

44 PADS (1-4, STOP) ▶PERF ▶STS

These programmable pads can be used to trigger a sound effect. Use the STOP button to stop a cyclic sound. (See “List of sounds assignable to the Pads” on page 226).

Each Pad corresponds to a dedicated Pad track.

45 TRANSPOSE ▶PERF ▶STYLE

These buttons transpose the whole instrument in semitone steps (Master Transpose). The transposition value is shown (as a note name) on the top right of the display.

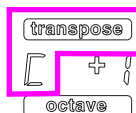

Press both buttons together, to reset the Master Transpose to zero.

Note: The Master Transpose has no effect on tracks set to Drum mode (and, even if set in a different status, on the Drum and Percussion tracks). See “Page 14 - Track: Mode” on page 46, and “Page 7 - Track: Mode” on page 78.

b Lowers the Master Transpose a semitone.

Raises the Master Transpose a semitone.

46 OCTAVE ▶PERF ▶STYLE ▶STS

These buttons transpose the selected track in steps of a whole octave (12 semitones; max ± 2 octaves). The transposition value is shown (in octaves) on the top right area of the display.

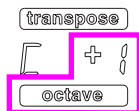

Press both buttons together, to reset the Octave Transpose to zero.

Note: The Octave Transpose has no effect on tracks set to Drum mode (and, even if set in a different status, on the Drum and Percussion tracks).

– Lowers the selected track an octave.

+ Raises the selected track an octave.

47 BALANCE slider

In Song Play mode, this slider balances the volume of the two on-board sequencers. When fully on the left, only the Sequencer 1 can be heard. When fully on the right, only the Sequencer 2 can be heard. When in the middle, both sequencers play at full volume.

48 SEQUENCER TRANSPORT CONTROLS - SEQ1 and SEQ2

The instrument is equipped with two sequencers (Sequencer 1 and Sequencer 2), each with its own set of transport controls.

<< and >> Rewind and Fast Forward commands. If you use them while the Song is in play, they make it scroll back or forward.

When pressed once, these buttons move the Song to the previous or following measure. When kept pressed, they make the Song scrolling continuously, until you release them.

(SHIFT) In Jukebox mode (Sequencer 1), keep the SHIFT button pressed, and press these buttons to scroll to the previous or next Song in the Jukebox list (see “Page 9 - Jukebox” on page 79).

PAUSE Pauses the Song at the current position. Press PAUSE or PLAY/STOP to start the Song playing again.

PLAY/STOP Starts or stops the current Song. When you stop the Song, the Song Position goes back to measure 1.

(SHIFT) In Song Play mode, pressed while keeping SHIFT pressed, starts both sequencers at the same time.

4. DISPLAY AND USER INTERFACE

The display shows the current status of the Pa50 and its performance and editing parameters. You can select each parameter by using the VOLUME/VALUE (A-H) buttons on the side of the display, or each page command appearing along

the last line using the F1-F4 buttons. You can vary many of the parameter's values by pressing the left (-) or right (+) button of any VOLUME/VALUE pair.

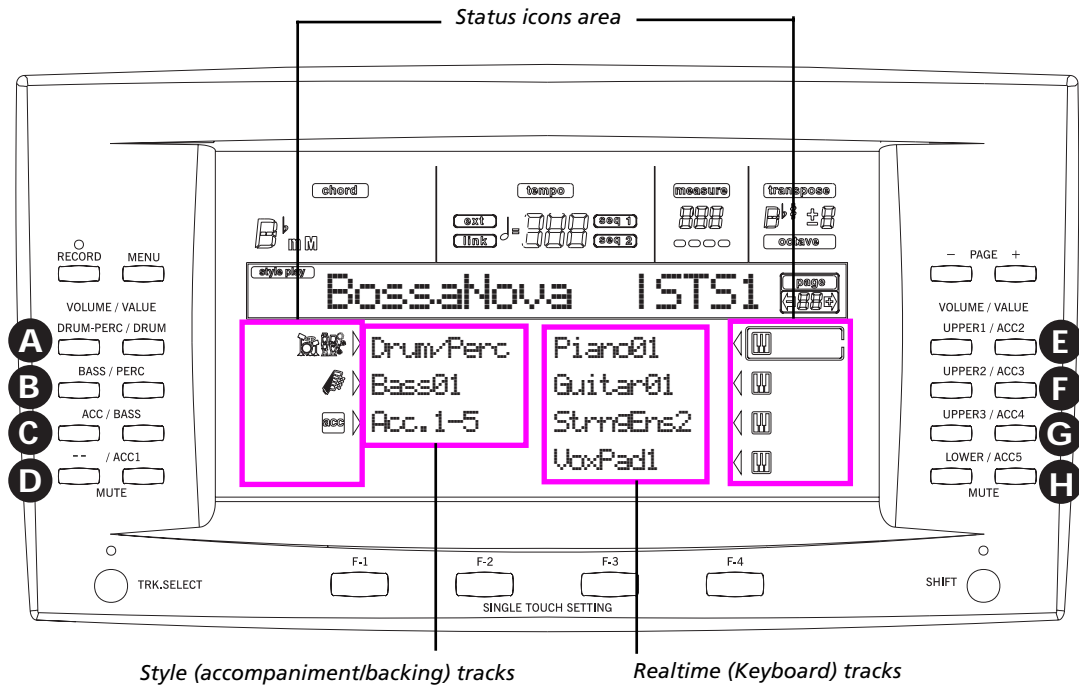

DISPLAY CONTROLS

VOLUME/VALUE (A-H) buttons and display parameters. These buttons are used to select the corresponding parameter or command in the display, to change the parameter's value, or to change the volume of the corresponding track.

While you are in the main page, these buttons can select a track, change the track's volume, or mute/unmute a track. See "VOLUME/VALUE (MUTE) A-H buttons" on page 16 for more information.

F1-F4 buttons. When in an Edit page, these buttons may be used when there are four parameters in a row, as in the following example:

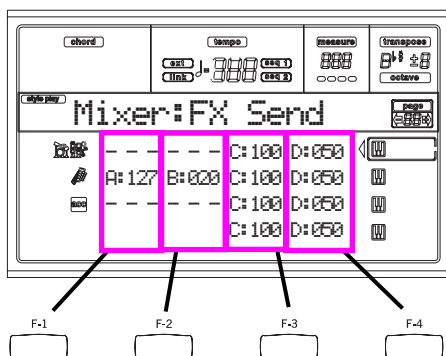

First, select the line using a VOLUME/VALUE (A-H) button. Then, select a column using the F1-F4 function key.

In the Disk edit environment, the F1-F4 buttons can be used also to select one of the page commands appearing in the last line of the display.

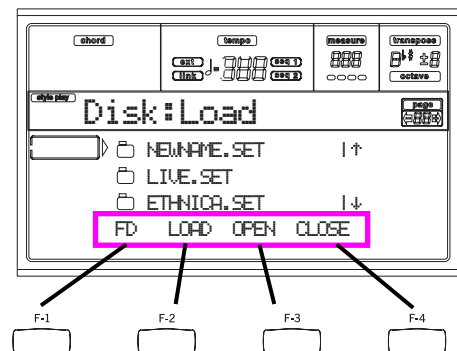

See "SINGLE TOUCH SETTING (F1-F4 FUNCTION KEYS) buttons" on page 16 for more information.

PAGE. The PAGE buttons select the previous or following edit page. When selecting a Style or a Program, they select a different page of Styles or Programs. See "PAGE +/-" on page 15 for more information.

MENU. The MENU button opens the current operating mode or edit environment's Menu. When in a Menu, you can use the VOLUME/VALUE buttons to select an edit section to jump to.

TRACK SELECT. Each of the operating modes have a different number of tracks:

- Style Play 4 Realtime tracks, 8 Style tracks, 4 Pads.
- Song Play 4 Realtime tracks, 2 x 16 Song Tracks, 4 Pads.

Backing Sequence

4 Realtime tracks, 8 Style tracks, 4 Pads.

Song 16 Song tracks.

You can only see up to 8 tracks in the display. So, use the TRACK SELECT button to switch to the other (hidden) tracks. For example, when in Style Play, you can use this button to switch from the Realtime tracks and the Style tracks.

INTERFACE STRUCTURE

Thanks to its multitasking operating system, the Pa50 user interface is structured in “overlapping”, active layers. From the lower level:

- operating modes (Style Play, Backing Sequence, Song Play, Song, Program)
- edit environments (Global, Disk)
- selecting windows (Style Select, Song Select, Program Select, Performance Select).

When opening an edit environment or a selecting page, the current operating mode is still working in the background.

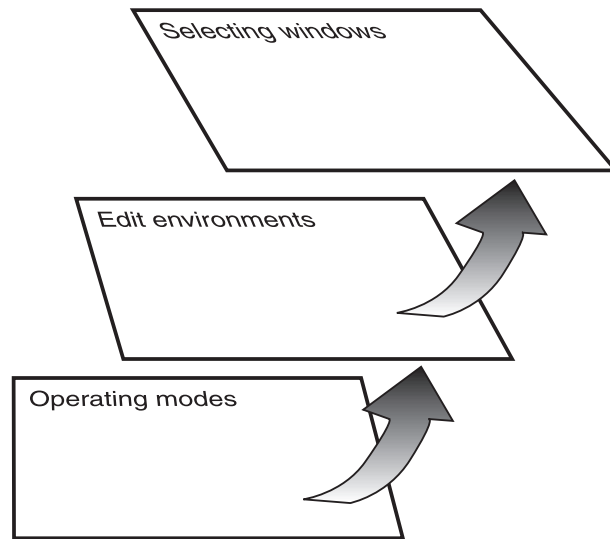

Operating modes. (See diagram at the bottom of this page). At the lowest level, an operating mode is always active. The current operating mode is indicated by the lit LED on the STYLE PLAY, B.SEQ, SONG PLAY, SONG or PROGRAM button in the MODE section. The relevant icon lights up in the display.

An operating mode is divided into a main page (the page where you usually play a Style, a Song or a Program), a menu, and a series of edit pages.

Press MENU to access the Menu. Use the MENU and PAGE buttons to browse across the various edit pages. Press EXIT to go back to the main page.

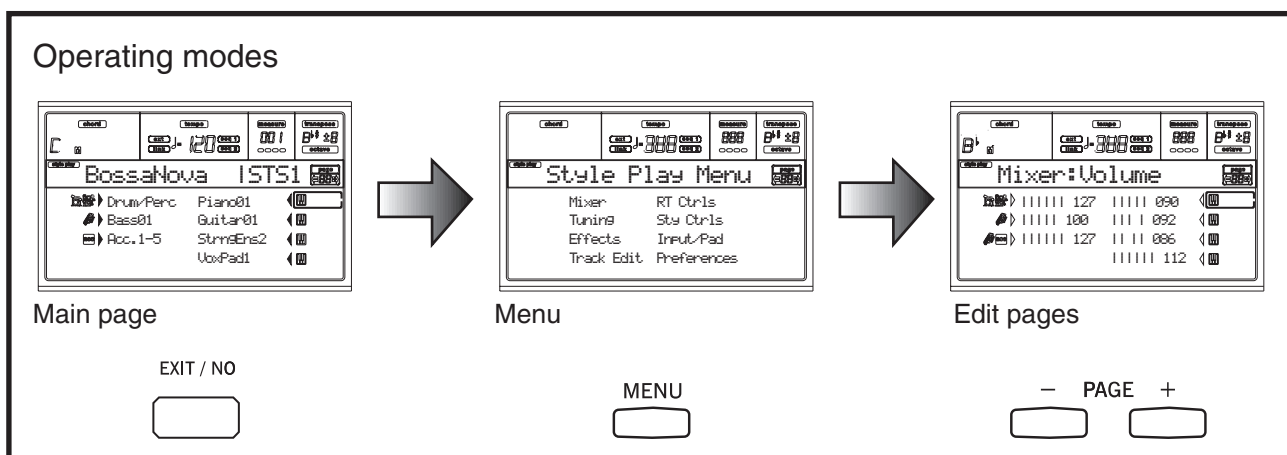

Edit environment. (See diagram at the bottom of this page). When you press GLOBAL or DISK, an edit environment overlaps the current operating mode. Press EXIT to go back to the current operating mode.

An edit environment is made up of a menu and a series of edit pages. Use the MENU and PAGE buttons to browse across the various edit pages.

Selecting windows. When you press one of the STYLE or PROGRAM/PERFORMANCE buttons, you open a selecting window. This window closes after selecting one of the items in it, or after pressing EXIT.

If the DISPLAY HOLD LED is light up, the window doesn't close after selecting an item. Press EXIT to close the window, and go back to the underlying page.

MESSAGE WINDOWS

Sometimes, a message appears in the display, warning about an error or a wrong operation:



Press ENTER or EXIT to exit one of these windows. Other messages ask for an answer, as in the "Are you sure" window below:

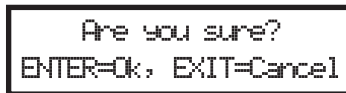

Press ENTER/YES for Yes, or EXIT/NO for No.

SYMBOLS AND ICONS

Many icons and symbols, on the custom display, show the status of a parameter or the display content.



Realtime/Keyboard track (Upper 1-3, Lower).



Drum track (Style track view).



Percussion track (Style track view).



Grouped Drum and Percussion tracks.



Bass track (Style track view).



Grouped accompaniment tracks. This symbol indicates the five grouped accompaniment tracks (Acc1-5).



Accompaniment tracks (Style track view).



Sequencer tracks.



Selected track or parameter. When this symbol appears, you can execute any available operation on the selected item.

(no icon)

The track is in mute, and can't play on the keyboard.

GRAYED-OUT NON-AVAILABLE PARAMETERS

Currently non-available parameters are now shown in "gray" in the display, i.e. with a "ghost" texture. Here is an example of a grayed-out parameter, compared to a normal parameter:

Bottom:G-1 Top:08

Text in solid black

Bottom:G 1 Top:00

Text in gray

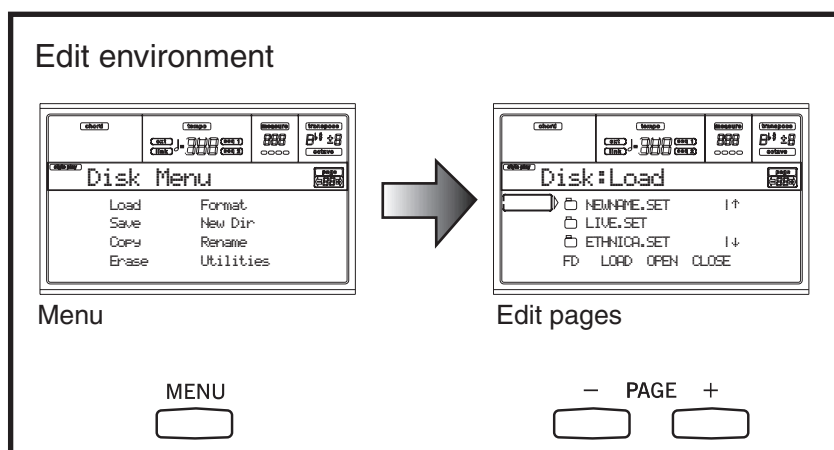

5. REAR PANEL

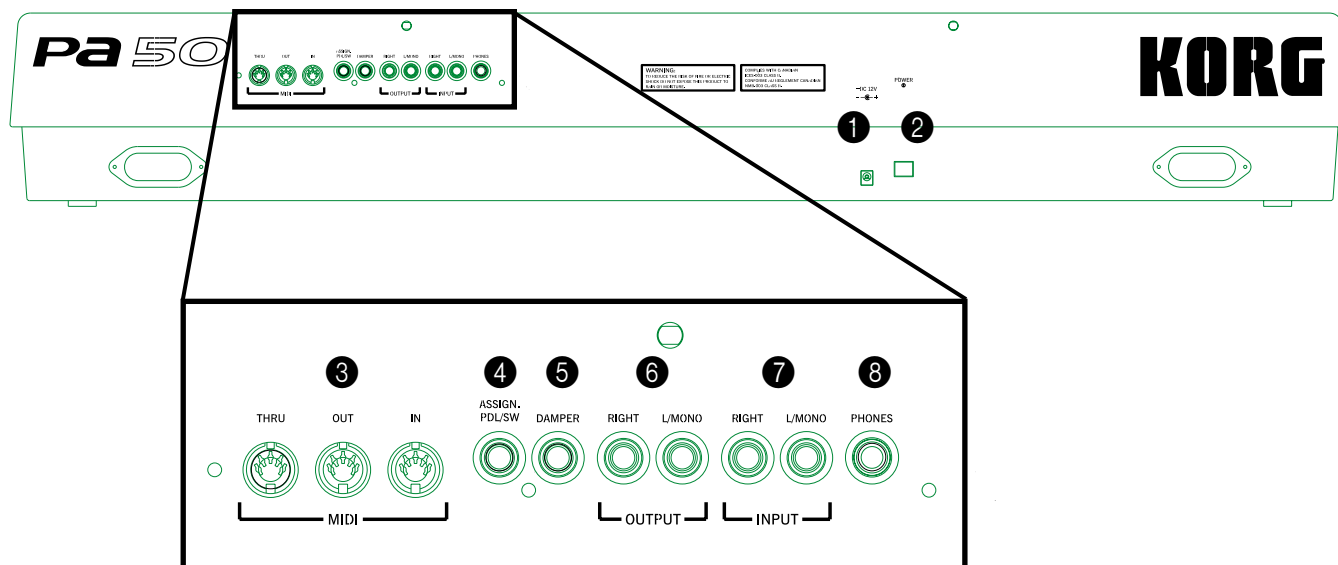

❶ AC POWER ADAPTER CONNECTOR

Plug the supplied power adapter into this connector.

❷ POWER switch

Use this switch to turn the instrument on or off.

❸ MIDI INTERFACE

The MIDI interface allows your Pa50 to be connected to an external controller (master keyboard, MIDI guitar, wind controller, MIDI accordion...), to an expander, or to a computer running a sequencer or an editor. For more information on how to use the MIDI interface, see the MIDI chapter.

IN This connector receives MIDI data from a computer or a controller. Connect it to an external controller's or computer's MIDI OUT.

OUT This connector sends MIDI data generated by Pa50's keyboard, controllers, and/or the internal sequencer. Connect it to an expander's or computer's MIDI IN.

THRU This connector sends an exact copy of the data received on the IN connector. Use it to cascade the Pa50 with other MIDI instruments.

❹ ASSIGNABLE PEDAL/FOOTSWITCH

Use this to connect a continuous or footswitch pedal, like the KORG EXP2 or XVP10. To program it, see "P/S (Pedal/Switch)" on page 126.

❺ DAMPER

Use this to connect a Damper pedal, like the KORG PS1, PS or DS1H. To change its polarity, see "Damper Pol. (Damper Polarity)" on page 126.

❻ OUTPUTS

Use these unbalanced connectors to send the audio signal (sound) to a mixer, a PA system, a set of powered monitors, or your hi-fi system. Set the output level with the MASTER VOLUME slider.

❼ INPUT 1 and 2

Use these unbalanced connectors to input another keyboard/synthesizer, a (non-powered) mixer's output, or a CD/tape player (line impedance). The signal is automatically routed to the speakers, the Audio Outputs and the Phones.

❽ PHONES

Use this connector to connect a pair of headphones. You can use headphones with an impedance of 16-200Ω (50Ω suggested). Use a headphone distributor to connect more than one pair of headphones.

BASIC GUIDE

6. BASIC OPERATIONS

PLAYING ON THE KEYBOARD

Just play on the keyboard. You will hear the Realtime tracks playing. There are four Realtime tracks: Upper 1-3 and Lower. They may play all at the same time, or just one or a few of them, depending on their Mute status. If you cannot hear a track, check the mute status of that part.

Tracks can be set in different ways: use the KEYBOARD MODE section to select the way they are configured on the keyboard.

- Press FULL UPPER to play the Upper 1-3 tracks on the full range of the keyboard, just as you would on a piano.

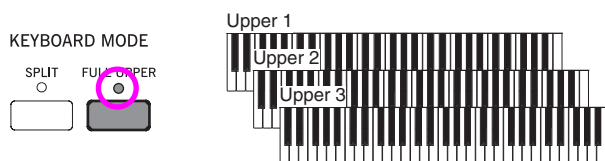

- Press SPLIT to let the Upper 1-3 tracks play on the right of the Split Point, and the Lower track on the left.

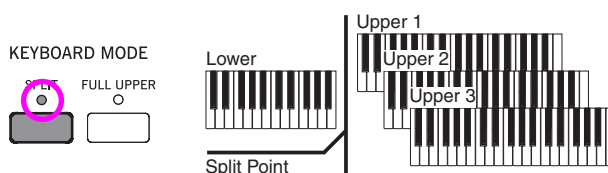

- Keep the SPLIT POINT button pressed, and play a note to change the point where the keyboard is divided in an Upper and a Lower part.

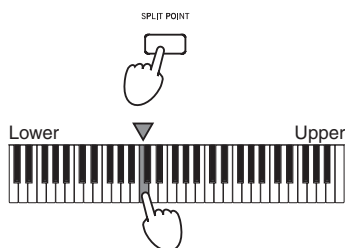

To memorize the selected split point note, press the GLOBAL button, then press WRITE to save the Global in memory (see “The Write window” on page 125).

SELECTING, MUTING/UNMUTING AND SOLOING A TRACK

Selecting. Use the VOLUME/VALUE (A-H) buttons to select a track.

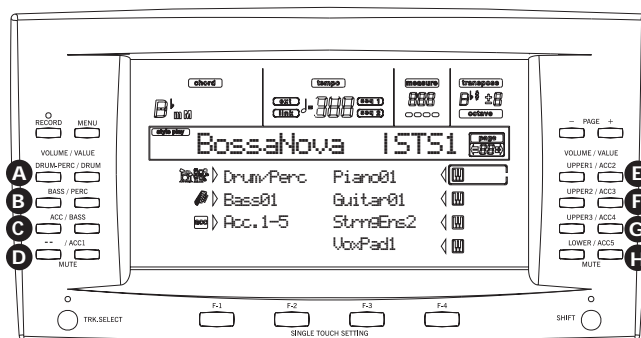

The selected track is shown with a solid square surrounding its status icons.



If you can't see the track you are looking for, use the TRACK SELECT button to scroll up or down the tracks, and find the hidden ones.



Mute/unmute. Press both VOLUME/VALUE (A-H) buttons to mute or unmute a track. For example, if you are in the main page that appears after turning the instrument on, and you want to mute the Upper 1 track, press the E (UPPER1/ACC2) buttons together.

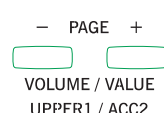

The mute/play status is shown by the relevant icon in the display:

- Play status; the track plays on the keyboard.
- (no icon) Mute status; the track doesn't play on the keyboard.

Solo. While in the Style Play, Song Play and Song modes, you can solo one of the tracks. Just keep the SHIFT button pressed, and press both VOLUME/VALUE buttons corresponding to the track you wish to solo.

To exit the solo mode, keep the SHIFT button pressed again, and press both VOLUME/VALUE buttons corresponding to the soloed track.

SELECTING A PERFORMANCE

A Performance is a set of Programs and settings for the Keyboard and Style tracks, that makes selecting complex combinations live fast and easy. When the STYLE CHANGE LED is on, a Performance can also select a different Style.

It is always advisable to use Performances, rather than single Programs, when playing even a solo sound, since a Performance lets you select the right effects, transposition, plus many other parameters, together with the Programs.

Data type		Parameters
Realtime Tracks	Upper 1, Upper 2, Upper 3, Lower	Master Transpose, Program, Volume, Pan, Octave, Scale, Detune, Pitch Bend, Poly/Mono/Drum, Int/Ext, Damper, Dynamic Range, Joystick C&D Effect Send level, Type, Parameters Program parameters Pads
Style Tracks	Drum, Percussion, Bass, Acc1, Acc2, Acc3, Acc4, Acc5,	Program, Volume, Pan, Octave, Detune, Pitch Bend, Poly/Mono/Drum, Int/Ext, Wrap Around, Keyboard Range A&B Effect Send level, Type, Parameters Program parameters Drum Mapping, Kick&Snare Assignment

Other “performance” parameters are saved in the Global.

Global	Chord Recognition Mode, Memory Mode, Velocity Trigger, Lock
--------	---

1. Press the PERFORM button. This changes the PROGRAM/PERFORMANCE section into a Performance selector.



2. Use the leftmost button of the PROGRAM/PERFORMANCE section to select the first row of ten banks (1-

10, upper LED turned on), or the second row of ten banks (11-20, lower LED turned on).

3. Press one of the 1-0 buttons to select the PROGRAM/PERFORMANCE bank containing the Performance you are looking for.

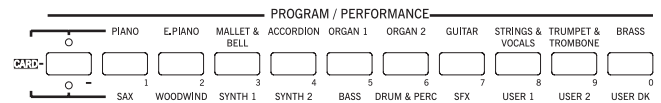

The Performance Select window appears. There are 8 Performances for each bank.

Last selected Performance

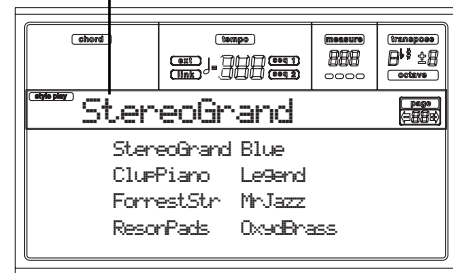

4. Select a Performance using the VOLUME/VALUE (A-H) buttons.
5. If the DISPLAY HOLD LED is on, press EXIT to exit this window.

The STYLE CHANGE button

When you select a Performance, the Style may or may not change, depending on the status of the STYLE CHANGE button. (When you save a Performance, the current Style number is always memorized).

- If the STYLE CHANGE LED is on, the Style memorized in the Performance will be selected.
- If the STYLE CHANGE LED is off, the Style doesn't change.

SELECTING A PROGRAM

You can select a different Program (i.e., sound) to be played by a track. Before selecting a Program, you must select the track you want to assign the Program to.

Note: To assign different Programs to the Style tracks, press TRACK SELECT to see the Style tracks. If you select a Program while grouped tracks (Drum/Percussion or ACC) are selected, the Program will be assigned to the last selected track.

Each Style Element (Variations, Fills...) can have different Programs, so your selection might be automatically reset when selecting a different Element. To avoid this reset, see "Prog (Program)" on page 49.

1. Use the VOLUME/VALUE (E-H) buttons on the right side of the display, to select the Realtime (Keyboard) track you wish to assign a different Program to.

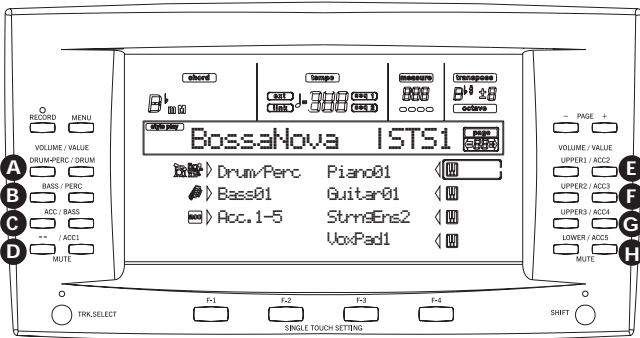

2. Press the PROGRAM button. This changes the PROGRAM/PERFORMANCE section into a Program selector.

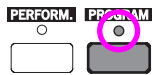

3. Use the leftmost PROGRAM/PERFORMANCE button to select a row of Program banks (upper, lower).

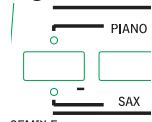

4. Select the PROGRAM/PERFORMANCE bank containing the Program you are looking for (Program banks are identified by instrument names).

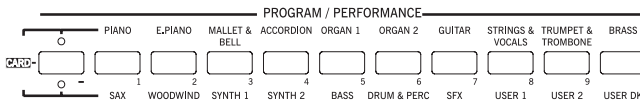

The Program Select window appears. See "Programs (Program Change order)" on page 154 for a list of Factory Programs.

Last selected Program

Selected track

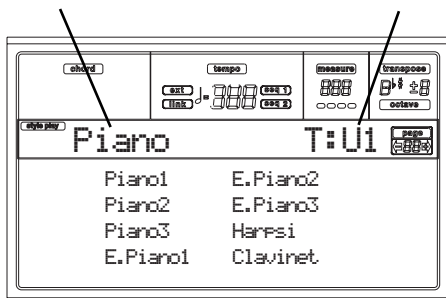

5. Browse all the Programs in the selected bank using the PAGE buttons. There can be various pages for each bank, containing up to 8 Programs each.
6. As you find the Program you are looking for, select it using the VOLUME/VALUE (A-H) buttons.
7. If the DISPLAY HOLD LED is on, press EXIT to exit this window.

SELECTING A STYLE

A Style is a set of rhythm and accompaniment patterns. You can select a Style from the internal memory, or from a floppy disk (see "The DIRECT FD bank" on page 40).

1. Use the leftmost STYLE button to select a row of Style banks (upper, lower).

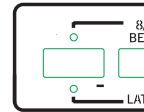

2. Select the STYLE bank containing the Style you are looking for.

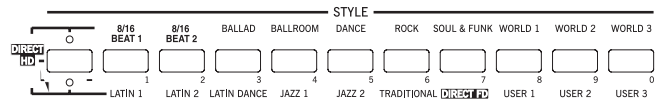

The Style Select window appears.

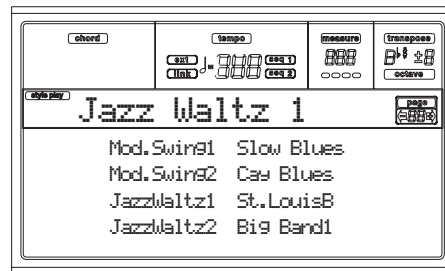

3. There are 2 pages for each bank, each containing 8 Styles. Select a page using the PAGE buttons.
 4. As you find the Style you are looking for, select it using the VOLUME/VALUE (A-H) buttons.
- Note:** The new Style will enter at the next strong beat.
5. If the DISPLAY HOLD LED is on, press EXIT to exit this window.

The SINGLE TOUCH button

When you select a Style, the Realtime (Keyboard) tracks can be changed or not.

- If the SINGLE TOUCH LED is on, the Single Touch Setting (STS) #1 is automatically selected, and the Realtime tracks are changed. Programs, and the Keyboard Mode, may change.
- If the SINGLE TOUCH LED is off, Realtime tracks don't change.

SELECTING A SINGLE TOUCH SETTING (STS)

A Single Touch Setting (STS) contains Realtime (Keyboard) tracks' settings. Four STS are included in each Style, and can be recalled by pressing the SINGLE TOUCH SETTING (F1-F4) buttons under the display.

Note: You can select a STS only when you are in the main page of the Style Play or Backing Sequence operating mode.

CHANGING ALL KEYBOARD TRACKS AT ONCE

Select a Performance or a Single Touch Setting (F1-F4 buttons, when you are in the Style Play main page) to change keyboard Programs and effects at the touch of a button.

PLAYING A SONG FROM FLOPPY DISK

1. Insert the floppy disk containing the Song into the floppy disk drive.
2. Press the SONG PLAY button to access the Song Play mode.

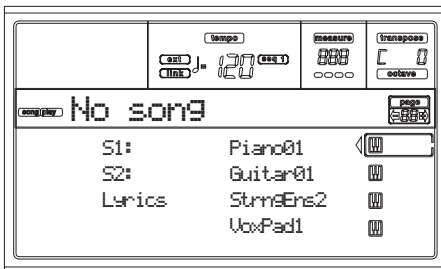

3. Press the A (S1:) VOLUME/VALUE button to open the Song Select window.

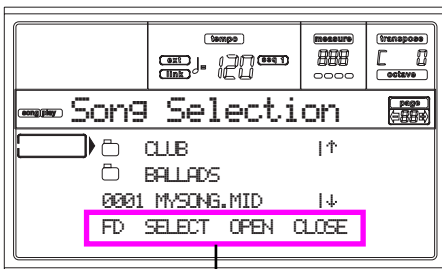

Page commands

Note: You can access the Song Select window also by pressing the PAGE+ button from the main page. You can exit this window either by pressing EXIT or PAGE-.

4. Press the F1 button to select the floppy disk drive (FD). The disk content appears.
5. Use the TEMPO/VALUE controls, or the VOLUME/VALUE (E-H) buttons to scroll the list. The E-F buttons are the Scroll Up (↑), while the G-H buttons are the Scroll Down (↓). Move the file you are looking for to the first line of the display.
 - 6. If the file you are looking for is in a folder (a file whose name begins with “ ”), move the folder to the first line in the display, then select the F3 (OPEN) command. Select the F4 (CLOSE) command to close a folder and go back to the upper level.
 - 7. When the file you are looking for is in the first line of the display, press the F2 (SELECT) button.
 - 8. When the Song appears in the S1 line on the main page of the Song Play mode, press the left (SEQ 1) PLAY/STOP button to start the playback.
 - Note:** If the BALANCE slider is all the way to the right, Sequencer 1 is at the minimum volume and can't be heard.
 - 9. If you wish to play a different Song on the Sequencer 2 at the same time, press the B (S2:) VOLUME/VALUE button (press it twice if a Song is already selected for Sequencer 2), and repeat the above procedure to select a Song for Sequencer 2. Use the right (SEQ 2) PLAY/STOP button to start/stop the second Song. Use the BALANCE cursor to mix between Sequencer 1 and Sequencer 2.
 - 10. Stop the Song(s) using the PLAY/STOP button for the corresponding Sequencer.

SHORTCUT TO SEE THE ORIGINAL BANK FOR A STYLE, PERFORMANCE OR PROGRAM

You can see the original bank where your Style, Performance or Program came from. Just keep the SHIFT button pressed, and press the leftmost button of the STYLE or PROGRAM/PERFORMANCE section. A message window will appear, showing the name of the original bank.

Release the SHIFT button to exit the window.

7. TUTORIAL

This chapter is fully devoted to step-by-step instructions, that we hope may be useful to learn the basics—on-field.

1 - PLAYING IN REALTIME

As soon as you turn your Pa50 on, it is in Style Play mode, and you can play it in realtime. Please follow me...

1 Play on the keyboard.

When you turn the Pa50 on, Performance 1-1 (“StereoGrand”) is automatically selected. This sets the Realtime (Keyboard) tracks for you. In this case (unless someone modified this Performance earlier) you get the Upper 1 track playing on the full keyboard range, with the Grand Piano Program selected.

You may know there are four available Realtime tracks: Upper 1-3 and Lower. Upper Realtime tracks may play on the full range of the keyboard (the selected KEYBOARD MODE shall be FULL UPPER). Otherwise, the Lower track plays on the left of the Split Point, and the Upper tracks on the right (KEYBOARD MODE shall be SPLIT).

If you are not satisfied with this setting at startup, just select another Performance. Or change the track’s settings—as you will see in this tutorial—and save them into Performance 1-1. You’ll soon see how to do it.

2 Select a different Performance.

Is the PERFORM. LED switched on?



If so, press one of the PROGRAM/PERFORMANCE buttons, and select a Performance with the VOLUME/VALUE buttons (on the side of the display).

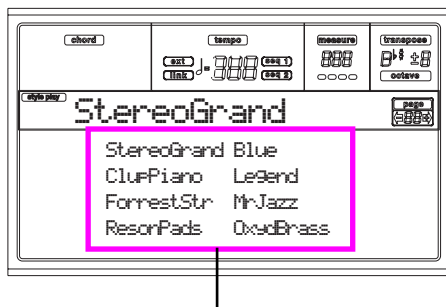

Select a Performance with the VOLUME/VALUE buttons

Go on trying with the different Performances. We provided 160 of them for you.

3 Select Performance 1-1 (“Grand Piano”) again.

As above: press Performance bank 1, and use the A VOLUME/VALUE buttons to select Performance 1-1.

4 Unmute the Upper 2 track.

Press both F VOLUME/VALUE buttons. The Upper 2 track will be selected and unmuted. The Play icon will appear, surrounded by the “selected track” frame and accompanied by



the pointing arrow. You will hear the Dark Pad Program play together with the Grand Piano.



Press the F VOLUME/VALUE buttons

5 Press SPLIT on the KEYBOARD MODE section, and play.

Now, the keyboard is split in two parts: the Lower part on the left, and the Upper part on the right. The AnalogStr Program is playing on the Lower part, while the Grand Piano and the Dark Pad are playing on the Upper part.

6 Set the split point.

Not happy with the current split point? Keep the SPLIT POINT button held down, and play the new split point on the keyboard. You can even save this setting in memory (see “The Write window” on page 125).

7 Mute/unmute various tracks.

Press both H VOLUME/VALUE buttons. You will mute the Lower track.



Press the H VOLUME/VALUE buttons

Press them again to unmute the Lower track.

Try also with the Upper tracks, using the E, F and G VOLUME/VALUE buttons. You will notice the sound becomes more or less fuller-sounding, depending on the number of tracks muted or unmuted.



Press the E-G VOLUME/VALUE buttons

8 Set the relative volume of the Realtime tracks.

Use each E-H VOLUME/VALUE button pair to set the volume of the Realtime tracks. Press one of the VOLUME/VALUE button to select a track. Then press the right one to increase the volume, the left one to lower it.

Press the left one to lower...



...and the right one to raise.

9 Press FULL UPPER on the KEYBOARD MODE section, and play.

Again, the Upper tracks can play across the full keyboard range.

10 Save your track configuration in a Performance.

That's all! When you find the right sound, you can press the WRITE button to save the track configuration into a Performance, a Single Touch Setting (STS), or a Style Performance. The Performance is a handy idea for saving Realtime tracks. See "The Write window" on page 42 for more information.

2 - PLAYING A STYLE

A Style will be your virtual band in your best solos. Select one of the 304 Styles we fitted in this machine...

1 OK, select your favorite musical Style.

There are plenty of Styles to choose from. We will go with a Jazz Style—the "Jazz Brush". Let's come on.

Select the second row of Styles. Press the leftmost STYLE button to switch the lower LED on.

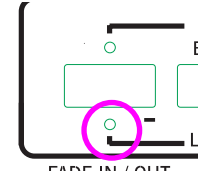

Now, you are free to press button number 4, called "JAZZ 1". The Style Select window appears.

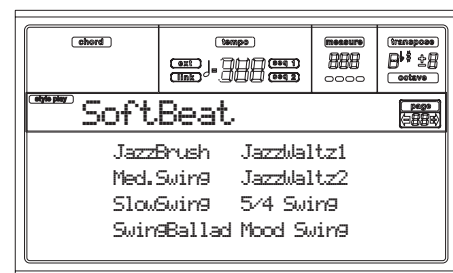

Press one of the A VOLUME/VALUE buttons to select "Jazz Brush".

2 Call an Intro.

You can engage an Intro, to be played before the Style. Press INTRO1 or INTRO2. The former plays more freely, without letting you decide of the chords. The latter lets you play a chord progression during its playing.

3 Start the Style!

Play a chord, and press the START/STOP button. Then begin playing. Usually (when the SPLIT LED is on) chords are recognized under the split point, i.e. on the Lower part of the keyboard. With the UPPER or FULL Chord Scanning mode, you must play three or more notes to have a chord recognized.

4 Play your chords and your melody.

Go on playing. As you may notice, Pa50 features a very sophisticated chord recognition engine. Recognized chords are shown in the display.

5 Make a break—or should we say "a fill"?

During your playing, you are free to call a one-bar break. Try it:

PRESS BREAK

Do you see? Music stopped for one bar. Then, it is back again. After a while, let's go for something different...

PRESS FILL1 OR FILL2

No silence, this time. Pa50 plays a complex passage to let you take a breath. FILL1 is the simpler one, where the FILL2 is the more sophisticated. Usually, you will touch FILL1 when playing with Variations 1 and 2 (the most easy), FILL2 when in business with Variations 3 and 4 (more complex ones).

6 Select other Variations.

There are four VARIATION buttons. These are four different versions of the same Style. Try them all!

You can go to a Variation after a Fill. Just press a FILL button, then, immediately after, a VARIATION button.

7 Stop it!

OK, you could say: “O, that’s easy, I know how to do it, I can just press that big red START/STOP button again”.

Yes, you are perfectly right. But that’s only the easy way. Let us suggest a different way:

PRESS ENDING1 OR ENDING2

An ending is instantaneously called, and will begin playing, to led the Style to a colorful end. As usual, ENDING1 is pre-programmed, while ENDING2 asks for your chord progression.

In Sync

A guy from the end of the classroom stands up asking: “Huh, Sir, and what if I want to avoid all that START/STOP thing? I mean, I prefer to have my hands free for music!” Good point. The SYNCHRO button is there right for this.

1 While the Style is stopped, press the SYNCHRO button.

The SYNCHRO-START LED begins flashing on. The Synchro Start function is enabled.

2 Play a chord on the keyboard.

You must play a chord for the chord recognition engine. Usually, it will be on the left of the split point, but it depends on the CHORD SCANNING section.

The Style starts.

3 Stop the Style as you better prefer.

You know how to do, isn’t it?

Need more information?

Go to “Style Play operating mode” on page 40. The Reference Guide includes all the information you need.

3 - PLAYING A SONG

Nothing easier than playing a Song on the Pa50. You don’t have even to load it from disk.

1 Move the BALANCE slider to the center.

This sets both onboard sequencers at the same level.

2 Insert the floppy disk containing the Song into the disk drive.

Make sure your disk is DOS formatted. This is the typical Window format, and you can make a disk of this type also on the Mac, by selecting the “DOS” option when initializing a disk.

3 Press the SONG PLAY button to access the Song Play mode.

This is the display:

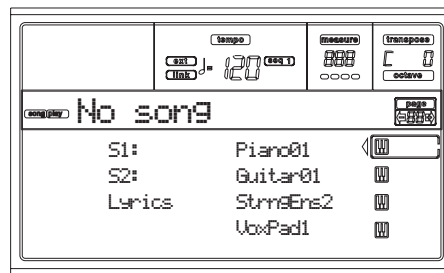

4 Select a Song.

Another easy task. Press the A (S1:) VOLUME/VALUE button to open the Song Select window.

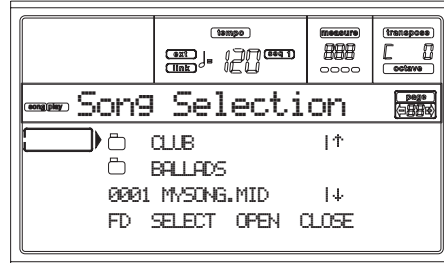

Press the F1 button to select the floppy disk drive. The list of files on disk appears. Songs are files with the “.MID” or “.KAR” extension. Pa50 filters all other file types out for you. Use the TEMPO/VALUE controls, or the VOLUME/VALUE (E-H) buttons to scroll the list. The E-F buttons are the Scroll Up (↑), while the G-H buttons are the Scroll Down (↓). Move the Song to play to the first line of the display. Then press the F2 (SELECT) button.

5 Press PLAY/STOP (SEQ1).

The playback begins.

6 If you like, select a Song for the Sequencer 2.

Press the B (S2:) VOLUME/VALUE button, and repeat the above procedure to select the Song for Sequencer 2. Use the right (SEQ 2) PLAY/STOP button to start/stop the second Song. Use the BALANCE cursor to mix between Sequencer 1 and Sequencer 2.

7 Take a pause.

Press PAUSE to stop the playback without going back to measure 1. The PAUSE LED begins flashing.

Press PAUSE again to resume the playback.

8 Stop it.

Sure, the Song automatically stops when reaching the end. But you can stop it before the end, just by pressing PLAY/STOP again.

4 - RECORDING A SONG

The Backing Sequence mode is a fast and effective way of recording a new Song, making full use of the features of the Style Play mode. So, arm your recorder, and play live with the Styles—a song will be ready in seconds!

1 First, enter Backing Sequence mode

Press B.SEQ to access the Backing Sequence mode. The Realtime tracks, on the keyboard, will remain the same you selected in the Style Play mode.

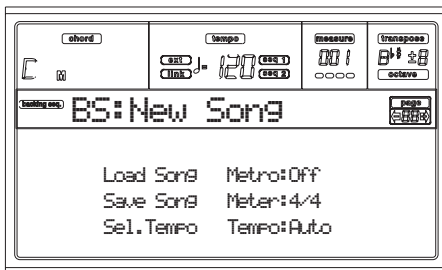

Don't worry about this display: it's something you don't need to learn at this point. You may find more information on it, going to the Reference Guide (see "Backing Sequence operating mode" on page 82).

Suffice you to know this is the Backing Sequence Play page, where you can load, play or save a Song.

2 Now, press RECORD.

You are prompted to select either the Realtime recording mode, or the Chord/Acc Step recording mode.



3 Select the Realtime recording mode.

Simply press one of the A VOLUME/VALUE buttons. The Record page appears.

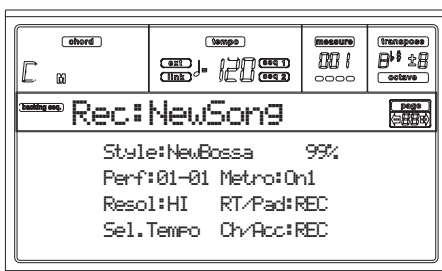

4 If you think the selected Style is not what you like for your backing tracks, select a different one.

Well, you should already know how to do it (see "Selecting a Style" on page 26). But here is a fast reminder:

1. Select one of the Style rows in the STYLE section, using the leftmost button.
2. Select one of the Style Banks, by pressing one of the buttons of the STYLE section.
3. Select one of the pages, using the PAGE buttons.
4. Select a Style, using the VOLUME/VALUE (A-H) buttons.

As you may guess, the Style Bank and number appear after the "Style" parameter in the display.

5 And what about changing the Performance or Single Touch Setting?

As above, you should know the story (see "Selecting a Performance" on page 25, or "Selecting a Single Touch Setting (STS)" on page 27). But, here is a short recap for the Performances:

1. Press the PERFORM button to set the PROGRAM/PERFORMANCE section act as a Performance selector.
2. Select one of the Performance Banks, by pressing one of the buttons of the PROGRAM/PERFORMANCE section.
3. Select a Performance, using the VOLUME/VALUE (A-H) buttons.

...and for the Single Touch Settings (STS):

- Press one of the SINGLE TOUCH SETTING buttons.

6 Ok, now we can go.

As you see, both the RT track and the Ch/Acc track are in RECORD mode. This means you can start recording all you play in a realtime performance with the Styles. So,

PRESS START/STOP

WAIT FOR THE PRECOUNT TO REACH BAR 1 AND BEGIN PLAYING!

7 Play as if you were playing live.

You can do exactly what you do when playing with the Styles: select a different Style, Performance, STS, different Variation, a Fill, and Ending...

You can even start your recording with an Intro: just press one of the INTRO buttons before pressing START/STOP to start recording.

8 Stop the Song.

To stop the Song, press either START/STOP or one of the ENDING buttons. The Song will stop, but the Recording will still be on. So, you can start with another Song to be recorded in the same session (go back to step 6, if you like).

Otherwise, finish the Recording, going to the next step.

9 Finish the recording.

All done, boys/girls? Yes? Fine! Then you may

PRESS PLAY/STOP (SEQ1)

and the Recording status will be gone. Both Backing Sequence tracks (RT and Ch/Acc) will be set to the PLAY status.

10 Listen to the Song.

When back in the Backing Sequence Play page, press PLAY/STOP (SEQ1) to listen to the new Song. How smart were you?

If the Song is fine, you can switch to the Song mode and do some editing. Or you can save it (as seen below), and play it in Song Play mode.

10 And... if I want to delete and record again one of the tracks, or the whole Song?

That's easy!

1. Press RECORD again to enter Record mode.

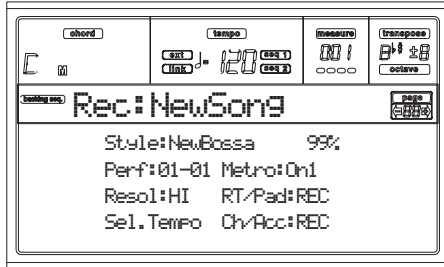

2. Set the track to delete and record again to the REC status.
3. Set the track you want to listen to during recording to the PLAY status. If you don't want to delete it, but you don't want to listen to it, set the track to the MUTE status.
4. Start recording again. Anyway, if you are recording the RT track, you can't use the Style controls.
5. Press PLAY/STOP (SEQ1) to finish the Song and exit Recording mode.

10 Time to save your Song, isn't it?

If you don't save your Song, it is lost when you turn the instrument off, or switch to the Song Play mode. So, save it on a disk. See "Save Song page" on page 84.

Need more information?

Go to "Backing Sequence operating mode" on page 82. The Reference Guide includes all the information you need.

5 - EDITING A SONG

You can edit a Song, either a Standard MIDI File bought at the shop, or one of your Songs made in Backing Sequence mode.

What about changing those boring General MIDI sounds with those gorgeous original KORG sounds? You can do it—in Song mode.

1 Press SONG to go to the Song mode.

This is the Song garage, where you may find tools to reshape your Song.

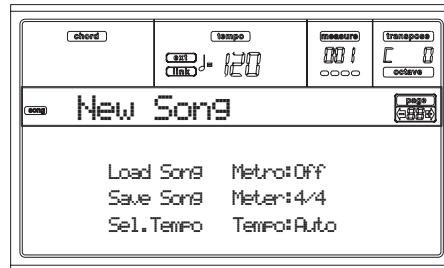

2 Insert in the disk drive the floppy disk containing the midifile you wish to edit.

Midifiles are files generated by a computer sequencer or a musical instrument, usually after a conversion. For example, if working with a computer, you should find a command whose name could sound a little like "Convert to .MID". A midifile has a ".MID" or ".KAR" extension.

3 Load the Song.

Press one of the B VOLUME/VALUE buttons (corresponding to the Load Song command). As expected, the Load page will appear.

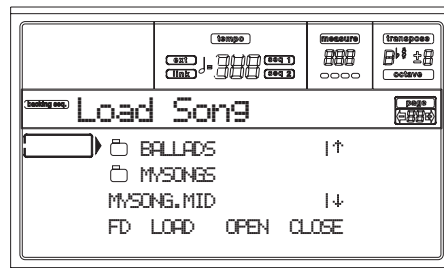

If it is not yet selected, press F1 to select the FD (Floppy Disk) device.

Move the midifile to load to the first line of the display. Use the DIAL or the UP and DOWN buttons to scroll the list; or use the E-F (Scroll Up) or G-H (Scroll down) VOLUME/VALUE buttons.

When the midifile is on the first line of the display, press F2 (Load) to load it. The "Are you sure?" message will appear. Press ENTER to confirm.

Note: When loading a Standard MIDI File, the first MIDI events are converted to the Song Performance events. You will see them as the Programs, Volume, Pan, Effect settings assigned to the tracks.

4 Listen to the Song.

After loading you are back to the main page of the Song mode.

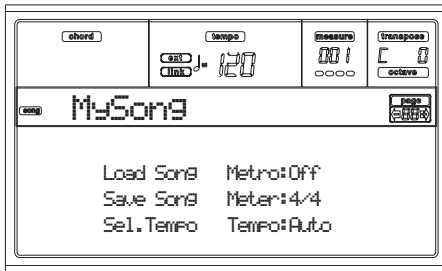

Press PLAY/STOP (SEQ1) to listen to the Song. The LED on the button turns on.

Does it sound good? If it is a General MIDI-compatible midifile, there is a good chance it does. But we can further improve on it.

5 Stop the Song.

This one is easy: press PLAY/STOP (SEQ1). The LED on the PLAY/STOP button turns off.

Please, always remember: make any changes to the Song when the sequencer is not playing. Otherwise, a Stop command will reset all your changes.

(Not funny, huh?)

6 Select different Programs.

You can replace General MIDI Programs with KORG Programs. It will sound more rich, more lively.

1. Press TRACK SELECT to see tracks 1-8. The LED turns on.

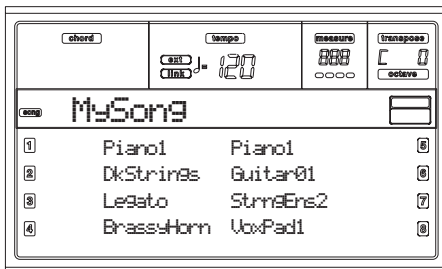

You are watching at tracks 1-8. You can switch to tracks 9-16 by pressing the TRACK SELECT button again.

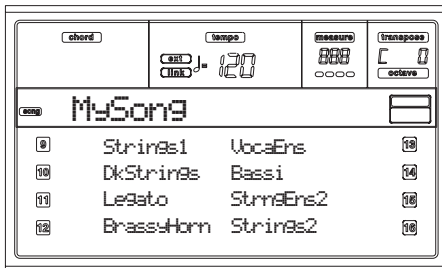

If you press TRACK SELECT again, you are back to the main page. Press TRACK SELECT AGAIN to go to tracks 1-8...

2. Select the track you wish to assign a different Program using the VOLUME/VALUE buttons. Press one of the buttons corresponding to the track to select. For example, one of the A buttons to select track 1:

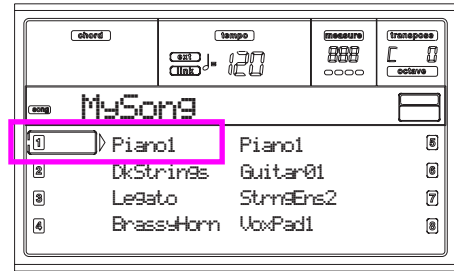

3. Select a Program. You should know how to do. If not, what about going back for a little to the "Basic operations" chapter, "Selecting a Program" section, page 26? It will be of a great help in the future...

Which Programs to choose? With >660 Programs, you will for sure find your preferred sound. Just browse any Program bank, and listen to them. Turn on the DISPLAY HOLD LED, to stay in the Selecting Window until you have found the right Program. (Then, press EXIT or DISPLAY HOLD to exit the window.)

4. Execute as many changes as you like to the other tracks.

7 Change the volume.

Yes, this is another obvious change. Press MENU to open the edit menu.

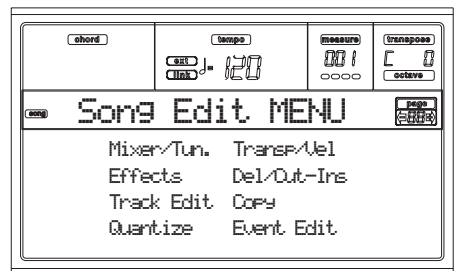

Press one of the A VOLUME/VALUE buttons, to select the Mixer/Tuning item. Suddenly, a Volume edit page appears...

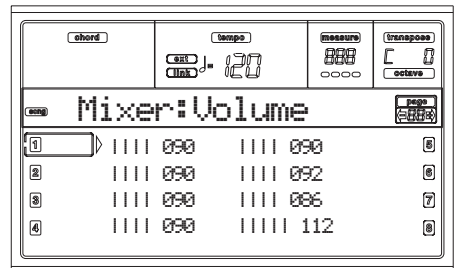

Select a track, and use the DIAL or the UP and DOWN buttons, or the VOLUME/VALUE buttons, to change the track's volume.

Modify all tracks you think need to be modified.

8 Save the Song.

Your changes will be lost when you load a new Song, switch to the Song Play mode, or turn the instrument off. So, press EXIT to go back to the main page of the Song mode.

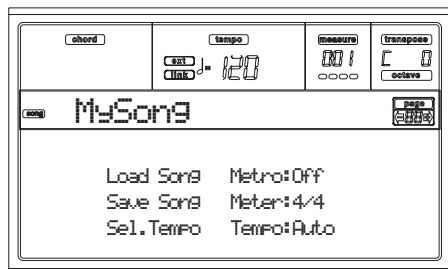

Press one of the C VOLUME/VALUE buttons, to select the Save Song command. Save your Song with a new name. How to accomplish this simple operation is described in great details on page 90 (“Save Song page”).

Note: When saving a Song the Song Performance events (initial Program, Volume, Pan, Effect Send settings) are saved at the beginning of the Standard MIDI File. Effect settings are saved as Pa50 SysEx events, ignored by other musical instruments.

Other editings

The Volume is not the only parameter you can edit. You can edit a lot more things, like the Pan, the Effects, the Tuning... you can even use up to 4 effects (A-D Internal FX Processors), but this will be useful only when reading the Song back on the Pa50 only, since other General MIDI-compliant instruments use only 2 effects.

Need more information?

Go to “Song operating mode” on page 88. The Reference Guide includes all the information you need.

6 - THE ARABIC SCALE

You can program an Arabic scale in real time, by assigning a footswitch or a pad the “Quarter Tone” function.

Another way of changing the scale is assigning it to a Performance or Single Touch Setting (STS), but this is the most convenient way to change the pitch in real time.

1 Program a footswitch to be the Quarter tone switch.

Simply go to the Global environment, and reach “Page 3 - Assignable Pedal/Footswitch, Assignable Slider”. There, you will find the “P/S (Pedal/Switch)” parameter, to which you can assign the Quarter tone function.

Press WRITE to save the Global status in memory (see “The Write window” on page 125).

2 Lower some note pitches.

Keep the Quarter tone pedal pressed. The keyboard will not play at this time. Press the notes you want to lower a quarter of tone. Release the pedal.

3 Play with your new scale.

The notes you pressed are now lowered of a quarter of tone.

4 Reset the original scale.

Press the Quarter tone pedal again. All pitches will be reset, and the scale selected by the Performance, STS or Style Performance will be recalled.

Need more information?

As stated, you can assign an alternative scale to a Performance or STS. Go to “Page 5 - Tuning: Scale” on page 44, and give also a look to the “Scale Mode” parameter (see page 51).

8. MIDI

WHAT IS MIDI?

Here is a brief overview of MIDI, as related to the Pa50. If interested, you may find more information on the general use of MIDI in the various specialized magazines and books.

In general

MIDI stands for Musical Instruments Digital Interface. This interface lets you connect two musical instruments, or a computer and various musical instruments.

Physically, MIDI is composed of three different connectors. The MIDI IN receives data from another device; the MIDI OUT sends data to another device; the MIDI THRU sends to another device exactly what was received on the MIDI IN (this is useful to daisy-chain more instruments).

Channels and messages

Basically, a MIDI cable transmits 16 channels of data. Think to each MIDI channel as a TV channel: the receiver must be set on the same channel of the transmitter. The same happens with MIDI messages: when you send a Note On message on channel 1, it will be received on channel 1 only. This allows for multitimbricity: you can have more than one sound playing on the same MIDI instrument.

There are various messages, but here are the most commonly used:

Note On – This message instructs an instrument to play a note on a specific channel. Notes have both a name (C4 standing for the center C) and a number (60 being the equivalent for C4). A Note Off message is often used to say the note has been released. In some case, a Note On with value “0” is used instead.

Together with the Note On message, a Velocity value is always sent. This value tells the instrument how loud the note must play.

Pitch Bend (PB) – You can generate this message acting on the joystick (X movement). The pitch is translated up or down.

Program Change (PC)– When you select a Program, a Program Change message is generated on the channel. Use this message, together with Control Change 00 and 32, to remotely select Pa50 data from a sequencer or a master keyboard.

Control Change (CC) – This is a wide array of messages, controlling most of the instrument parameters. Some examples:

- CC00, or Bank Select MSB, and CC32, or Bank Select LSB. This message pair is used, together with the Program Change message, to select a Program.
- CC01, or Modulation. This is the equivalent of pressing up the joystick. A vibrato effect is usually triggered on.
- CC07, or Master Volume. Use this controller to set the channel's volume.
- CC10, or Pan. This one sets the channel's position on the stereo front.

- CC64, or Damper Pedal. Use this controller to simulate the Damper pedal.

Tempo

Tempo is a global MIDI message, that is not tied to a particular channel. Each Song includes Tempo data.

Lyrics

Lyrics are non-standard MIDI events, made to display text together with the music. Pa50 can read many of the available Lyrics format on the market.

MIDIFILES

Midifiles, or Standard MIDI Files (SMF), are a practical way of exchanging songs between different instruments and computers. Pa50 has the SMF format as its default song format, so reading a song from a computer, or saving a song that a computer software can read, is not a problem at all.

Pa50 sequencers are compatible with the SMF in format 0 (all data in one track; it is the most common format) and 1 (multitrack). It can read the SMF in Song Play mode and modify/save them in Song mode. It can save a Song in SMF 0 format in the Backing Sequence or Song mode.

When in Song Play mode, the Pa50 can also display SMF lyrics in Solton, M-Live (Midisoft), Tune1000 and compatible (Edirol, GMX, HitBit, XF) formats, and the chord abbreviations of SMF in Solton, M-live (Midisoft), GMX, and XF format.

THE GENERAL MIDI STANDARD

Some years ago, the musical instruments world felt a need for some further standardization. Then, the General MIDI Standard (GM) was born. This extension of the basic MIDI sets new rules for compatibility between instruments:

- A minimum of 16 MIDI channels was required.
- A basic set of 128 Programs, correctly ordered, was mandatory.
- The Drum Kit had a standard order.
- Channel 10 had to be devoted to the Drum Kit.

A most recent extension is the GM2, that further expands the Programs database. The Pa50 is soundwise-compatible with the GM2 standard.

THE GLOBAL CHANNEL

Any channels with the Global option assigned (see “Page 6 - MIDI IN Channels” on page 127) can simulate the Pa50 integrated keyboard. When the Pa50 is connected to a master keyboard, transmission should take place over the Global channel of the Pa50.

The MIDI messages received over a Global channel and not over a standard channel are affected by the buttons of the KEYBOARD MODE section, as well from the split point. Therefore, if the SPLIT button LED is lit up, the notes that arrive to the Pa50 over this channel will be divided by the

split point into the Upper (above the split point) and Lower (below the split point) parts.

The notes that arrive to a Global channel are used for the chord recognition of the automatic accompaniment. If the KEYBOARD MODE is SPLIT, only the notes below the split point will be used. These notes will be combined with the ones of the special Chord 1 and Chord 2 channels.

THE CHORD 1 AND CHORD 2 CHANNELS

You can set two special Chord channels (see page 128) to send to the Pa50 notes for the chord recognition. The notes will be combined with the notes that go through the channel set as Global (Global notes are recognized only under the split point, if the SPLIT LED is lit up).

The Chord channels are not affected by the split point and the KEYBOARD MODE section of the control panel. All the notes – both above and below the split point – will be sent to the chord recognition.

The buttons of the CHORD SCANNING section have a particular effect on the Chord channels:

- if you have selected LOWER, the chord recognition mode will be set by the “Chord Recognition Mode” parameter in the Style Play mode (see page 50);
- if you have selected UPPER or FULL, the chord recognition mode will always be Fingered 2 (you need to play at least three notes in order for the chord to be detected).

These two channels are especially useful for accordion players to assign a different Chord channel to the chords and the bass played with the left hand. In this way, chords and bass will participate to the creation of chords for the chord recognition of the automatic accompaniment.

THE CONTROL CHANNEL

You can set a MIDI IN channel as the Control channel (see page 127), to select Styles and Performance from an external device. See the Appendix for a list of messages corresponding to Pa50 internal data.

MIDI SETUP

You can play Pa50 with an external controller, and use it simply as a gorgeous sound generator. To help you configure the MIDI channels, we have provided a set of MIDI Setups. Go to Global mode to select the one that fits your MIDI needs. (See “Page 4 - MIDI Setup” on page 126 for more information).

We recommend you to consider each MIDI Setup as a starting point you can freely tweak. Once you have selected the most appropriate MIDI Setup for the connection to be made, you can modify the parameters as necessary and save the Global in the memory with the Write function (see “The Write window” on page 125).

CONNECTING PA50 TO A MASTER KEYBOARD

You can control the Pa50 with a master keyboard or any other MIDI keyboard. You only need to connect the MIDI OUT connector of the master keyboard to the MIDI IN connector of the Pa50. The master keyboard will become the integrated keyboard of the Pa50 if it transmits over the same channel programmed as Global in the Pa50.

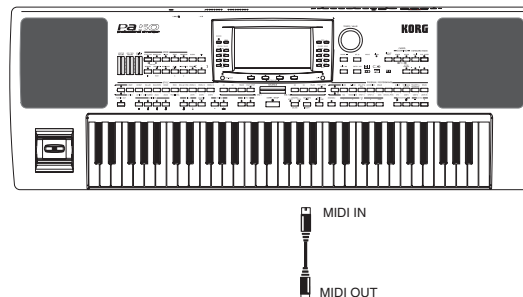

If the master keyboard transmits over the Global channel of the Pa50, the split point and the status of the KEYBOARD MODE section in the control panel will affect the notes received from the master keyboard.

Connections and settings

To connect the master keyboard to the Pa50 follow this procedure:

1. Connect the MIDI OUT connector of the master keyboard to the MIDI IN connector of the Pa50.
2. Program the master keyboard to transmit over the Global channel of the Pa50 (see “Page 6 - MIDI IN Channels” on page 127).

For information on the master keyboard programming, see the user’s manual of the master keyboard.

3. Press GLOBAL to enter the Global mode, then go to “Page 4 - MIDI Setup” (see page 126).
4. Select the Master Keyboard Setup.

Note: The settings can change when new data is loaded from disk. To protect the settings from loading, use the Global Protect function (see “Global Protect” on page 142).

5. Press WRITE, select Global, and press ENTER to save the Global. The “Are you sure?” message will appear. Press ENTER to confirm, or EXIT to abort.
6. Press one of the buttons in the MODE section to go to the desired operative mode.

CONNECTING THE PA50 TO A MIDI ACCORDION

There are different types of MIDI accordion and each type requires a different configuration of the Pa50. Select one of the MIDI “Accordion” Setups to configure the module properly (see page 126).

Connection and settings

To connect the accordion to the Pa50 follow this procedure:

1. Connect the MIDI OUT connector of the accordion to the MIDI IN connector of the Pa50.
2. Press GLOBAL to enter the Global mode, then go to “Page 4 - MIDI Setup” (see page 126).
3. Select one of the Accordion Setups.

Note: The settings can change when new data is loaded from disk. To protect the settings from loading, use the Global Protect function (see “Global Protect” on page 142).

4. Press WRITE, select Global, and press ENTER to save the Global. The “Are you sure?” message will appear. Press ENTER to confirm, or EXIT to abort.
5. Press one of the buttons in the MODE section to go to the desired operative mode.

CONNECTING THE PA50 TO AN EXTERNAL SEQUENCER

You can program a new Song on an external sequencer, using Pa50 as a multi-timbral expander.

Connections and settings

In order to connect the Pa50 to a computer, you need to have a computer with the MIDI interface.

1. Connect the Pa50 and the computer as in the following diagram.

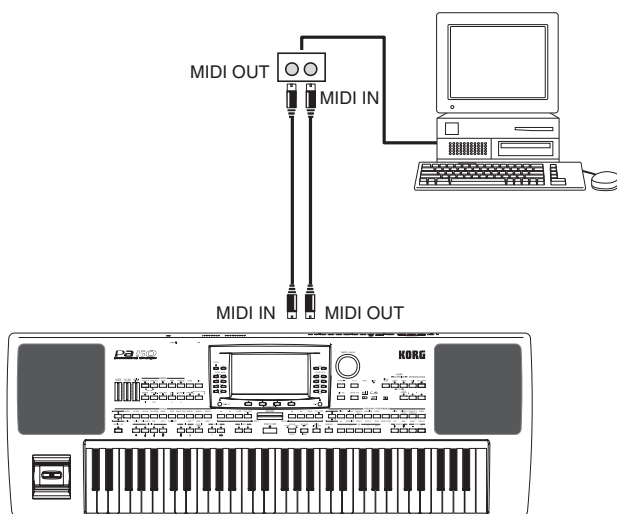

2. Press GLOBAL, and go to “Page 5 - MIDI Controls”. Set the Local parameter to Off (see page 127).

3. Go to “Page 4 - MIDI Setup” (see page 126). Select the Ext.Seq Setup.

Note: The settings can change when new data is loaded from disk. To protect the settings from loading, use the Global Protect function (see “Global Protect” on page 142).

4. Press WRITE, select Global, and press ENTER to save the Global. The “Are you sure?” message will appear. Press ENTER to confirm, or EXIT to abort.
5. Set the Upper 1 track in play, and press FULL UPPER in the KEYBOARD MODE section. This way, you can transmit to the external sequencer on the full keyboard range.
6. At this point, the notes played on the Upper 1 track go from the MIDI OUT of the Pa50 to the MIDI IN of the computer/MIDI interface.

The notes generated by the computer (i.e. a Song played by its sequencer) are sent thru the MIDI OUT of the MIDI interface to the MIDI IN connector of the Pa50.

The Local Off

When the Pa50 is connected to an external sequencer, we recommend you to set the Pa50 in Local Off mode (see “Local” on page 127) to avoid that the notes are simultaneously played by the keyboard and by the MIDI events sent by the external sequencer.

When the Pa50 is in Local Off, the Pa50 keyboard transmits data to the external sequencer, but not to the internal sound generation. The sequencer will receive the notes played on the Pa50 keyboard (Upper 1) and send them to the selected track of the song. The track will transmit the data to the internal sound generation of the Pa50.

Note: In order to send data to the Pa50 sound generation, the “MIDI Thru” function must be activated in the external sequencer (normally active; the name may be different according to the type of sequencer). For more information refer to the instructions manual of the sequencer.

The programs

The Song that is played back by the computer sequencer can select the Pa50 Programs through the MIDI messages Bank Select MSB and Bank Select LSB (bank selection, two messages) and Program Change (program selection). For a list of Programs and MIDI values, see “Programs (Program Change order)” on page 154.

A suggestion for those who program songs on computer: Even though it is not essential, you usually set the bass on channel 2, melody on channel 4, drum kit on channel 10, control for an external voice harmonizer on channel 5.

PLAYING ANOTHER INSTRUMENT WITH THE PA50

You can use the Pa50 as the master controller for your MIDI setup.

1. Connect Pa50's MIDI OUT to the other instrument's MIDI IN.
2. Set-up the other instrument's tracks to the same channels you want to play from Pa50. For example, if you wish to play the Upper 1 and Upper 2 tracks with the other instrument's sound, set the other instrument to receive on the same channels of the Upper 1 and Upper 2 tracks (by default, channels 1 and 2).
3. Set the general volume of the other instrument with its own volume controls.
4. Mute/unmute any track right from the Pa50 front panel. Set each track's volume using Pa50 own VOLUME/VALUE controls.
5. Play on Pa50's keyboard.

The Keyboard

Pa50's physical keyboard can drive up to 4 tracks via the MIDI OUT (Upper 1-3 and Lower). MIDI output channels are set in Global mode (see "Page 10 - MIDI OUT Channels" on page 129).

As a default situation (Default Setup), each of Pa50 Realtime Tracks transmit on these channels:

Track	Out Channel
Upper1	1
Upper2	2
Upper3	3
Lower	4

When a track is in mute, it can't transmit any MIDI data to an external expander or sequencer connected Pa50's MIDI OUT.

To hear only the expander's sounds, you can lower the MASTER VOLUME control on the Pa50, or set the Realtime

Tracks to the External status (see "Page 15 - Track: Internal/External" on page 46).

The Sequencer

Any Sequencer's track can drive a channel on an external instrument. To set each track's MIDI output channel, see "Page 10 - MIDI OUT Channels" on page 129.

To hear only the expander's sounds, you can lower the MASTER VOLUME control on the Pa50, or set the Song tracks to the External status (see "Page 8 - Track: Internal/External" on page 78).

Select the Sequencer 1 or Sequencer 2 MIDI Setup (depending on the Sequencer you are using on the Pa50) to set the channels as follows.

Track	Out Channel
Song 1...16	1...16

The Arranger

One of the most interesting aspect of MIDI, is that you can use your Pa50 to play an external instrument with its onboard arranger. Yes, it's hard to beat the audio quality of Pa50, but you could wish to use that old faithful synth you are still accustomed to...

To assign some of Pa50 Style tracks to an external instrument, set them to the External status (see "Page 15 - Track: Internal/External" on page 46).

Select the Default MIDI Setup to set the channels as follows (this is the default status of Pa50).

Track	Out Channel
Bass	9
Drums	10
Percussion	11
Acc1...5	12...16

REFERENCE GUIDE

9. STYLE PLAY OPERATING MODE

The Style Play mode is the boot-up operating mode. When in this mode, you can play Styles (i.e. automatic accompaniments), or just play with one to four Realtime tracks on the keyboard (Upper 1...3 and Lower).

WHAT'S A STYLE?

A Style is a rhythm/accompaniment structure, that simulates a band backing your solos.

In a *vertical* direction, it is composed of 8 different tracks (Drums, Percussion, Bass, and 5 different harmonic or melodic instruments). You can play on the keyboard with 4 more *Realtime* tracks (Upper 1-3 and Lower).

In a *horizontal* direction, it is a series of *Style Elements* (i.e., the various sets of patterns for each chord and each of the Intros, Variations, Fills, Breaks and Endings).

STYLES AND PERFORMANCES

Styles and Performances are linked in many ways.

- When the SINGLE TOUCH LED is on, selecting a Style also changes the Realtime (Keyboard) tracks (a Single Touch Setting is selected). The Performance settings are overridden.
- When the STYLE CHANGE LED is on, selecting a Performance also selects a Style (the one whose number is memorized with the Performance).
- When pressing the WRITE button, you can save the track's settings either in a Performance, a Style Performance, or a Single Touch Setting (STS).

CHANGING AND RESETING THE TEMPO

While in the main page of the Style Play mode, you can change the Tempo using the DIAL or the DOWN/- and UP/+ buttons.

In any other page, keep the SHIFT button pressed, and use the DIAL to change the Tempo.

To recall the Tempo stored in the current Style, keep the SHIFT button pressed, and press one of the DOWN/- or UP/+ buttons.

THE DIRECT FD BANK

In addition to the internal memory Styles, you can have DIRECT FD Styles, directly accessed by the floppy disk.

Just insert a disk, and press the DIRECT FD Style bank. The disk drive will read the first (in alphabetical order) ".SET" folder in the floppy disk, and will give you direct access to the Style it contains (no loading required).

Note: Reading from floppy disk may take some seconds, before the Styles are shown.

Browse through the DIRECT FD Styles using the PAGE buttons. You can have up to 6 pages, and up to 48 DIRECT FD Styles in a disk.

Folder	DIRECT FD pages
*.SET > STYLE > USER01	1, 2

Folder	DIRECT FD pages
*.SET > STYLE > USER02	3, 4
*.SET > STYLE > USER03	5, 6

Note: Reading from floppy disk is a little slower than reading from the internal memory. So, there is a chance that you will have to wait some beats, before the selected DIRECT FD Style is ready to play. The Style will enter at the next beginning of measure.

How to make the DIRECT FD bank

To configure the DIRECT FD bank, save your Styles into the first folder in the floppy disk. Folders are read in alphabetical order.

Note: The following procedures requires you overwrite the User Style banks. Save these banks before proceeding, to avoid losing important data.

1. Insert the floppy disk into the disk drive.
2. Press DISK and go to the Load page.

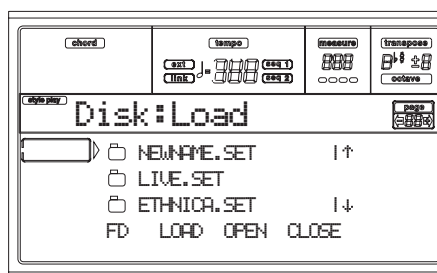

3. Use the F1 (Disk device) button to select the FD (Floppy Disk) device.
4. Load three banks of Styles, to be transformed into the DIRECT FD bank.
5. Go to the Save page.

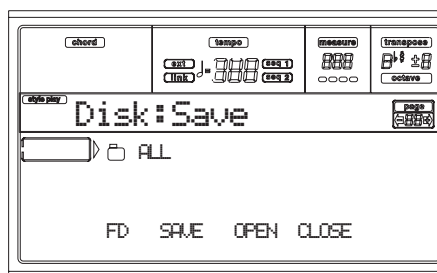

6. While the "ALL" item is selected, press F3 (Open) to open it.
7. Use the E-F (Scroll Up) and G-H (Scroll Down) VOLUME/VALUE buttons (or the TEMPO/VALUE section controls) to move the "STYLE" item to the first line of the display, and press F2 (Save).
8. Select the floppy disk (FD) as the target, using the F1 button.
9. The floppy disk directory appears. Use the E-F (Scroll Up) and G-H (Scroll Down) VOLUME/VALUE buttons (or the TEMPO/VALUE section controls), to scroll the disk content. Move the first folder of the directory to the first line of the display.
10. Press ENTER twice to save the banks.

MAIN PAGE

This is the page you see after you turn the instrument on. To access this page from another operating mode, press the STYLE PLAY button.

Note: When switching from Song Play to Style Play, a Performance is automatically selected, and various track parameters may change.

To return to this page from one of the Style Play edit pages, press the EXIT/NO button.

To switch between the Realtime (Keyboard) tracks and the Style tracks, use the TRACK SELECT button.

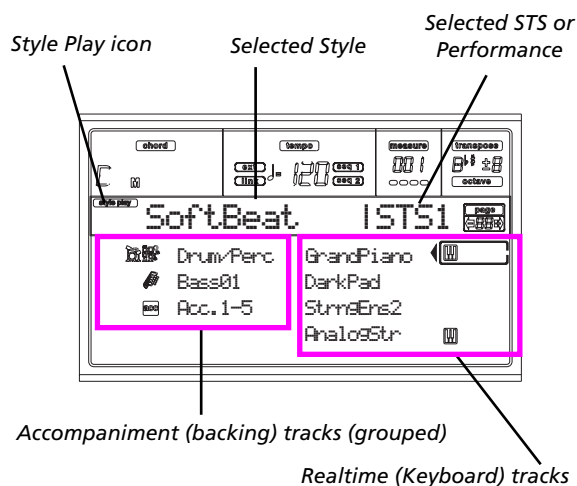

Style Play icon

When on, this icon indicates that the instrument is in Style Play mode.

Selected Style

Currently selected Style.

Selected STS or Performance

The last selected Single Touch Setting (STS) or Performance.

A (Drum/Perc grouped tracks)

Use these buttons to select, mute/unmute or change the volume of both Drum and Percussion tracks (grouped together) at the same time. To mute these tracks, press both VOLUME/VALUE buttons. To unmute, press both buttons again. To change the volume, select the track, then keep one of the buttons pressed.

B (Bass track Program name)

Name of the Program assigned to the Bass backing track. Use these buttons to select, mute/unmute or change the volume of the Bass track. To mute this track, press both VOLUME/

VALUE buttons. To unmute, press both buttons again. To change the volume, select the track, then keep one of the buttons pressed.

C (Acc.1-5 grouped tracks)

Use these buttons to select, mute/unmute or change the volume of the instrumental accompaniment tracks (tracks 1-5, other than Bass, Drum and Percussion). To mute these tracks, press both VOLUME/VALUE buttons. To unmute them, press both buttons again. To change the volume, keep one of the buttons pressed.

E (Upper 1 Program), F (Upper 2 Program), G (Upper 3 Program), H (Lower Program)

Name of the Programs assigned to the Realtime (Keyboard) tracks. Use these buttons to select, mute/unmute or change the volume of the corresponding tracks.

STYLE TRACKS PAGE

To see and edit the Style tracks, press TRACK SELECT from the main page. The TRACK SELECT LED turns on.

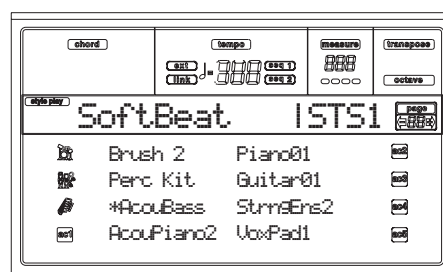

Press the TRACK SELECT button once again to go back to the main page.

A-H (Style Track Programs)

Name of the Programs assigned to the Style tracks. Use these buttons to select, mute/unmute or change the volume of the corresponding tracks.

HOW TO SELECT PROGRAMS

You can assign a different Program to each of the Realtime (Keyboard) and Style tracks. See "Selecting a Program" on page 26 for more information.

After selecting a new Program, save your changes into a Performance, Style or STS (see below "The Write window" section).

Note: If you select a Program while grouped tracks (Drum/Percussion or ACC) are selected, the Program will be assigned to the last selected track.

THE WRITE WINDOW

Open this window by pressing the WRITE button. Here, you can save all track settings into a Performance, the Realtime (Keyboard) track settings into a Single Touch Setting, or the Style track settings into the current Style Performance.

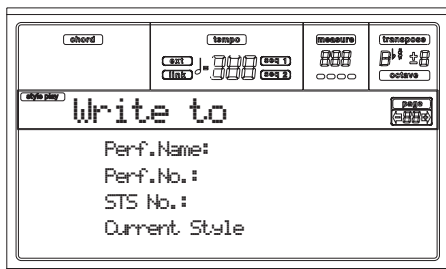

1. Select the kind of object you want to save your tracks into.
 - Select the “Perf No.” line to save all tracks (and the current selected Style settings) into a Performance. Use the corresponding VOLUME/VALUE buttons, or the TEMPO/VALUE section controls, to select a Performance location in memory. The name of the Performance already at the target destination will be shown.
 - Select the “STS No.” line to save the Realtime (Keyboard) tracks into a Single Touch Setting (STS). Use the corresponding VOLUME/VALUE buttons or the TEMPO/VALUE section controls, to select a Single Touch Setting number.
 - Select the Current Style line, to save the Style tracks into the current Style Performance.

If you select...	...you save...	...to this location...
Performance	All track settings, selected Style number, Master Transpose	Selected Performance
STS	Realtime (Keyboard) track settings	Selected Single Touch Setting (a part of the current Style)
Current Style	Style track settings, Master Transpose	Current Style Performance

2. If you are saving a Performance, you can change its name. Select the “Perf name” line. Move the cursor using the DOWN/- and UP/+ buttons. Select a character using the DIAL. Insert a character at the cursor position by pressing the INSERT button. Delete a character at the cursor position by pressing the DELETE button.
3. Press ENTER to save the settings in memory. The “Are you sure?” message appears. Press ENTER to confirm, or EXIT to abort.

MENU

From any page, press MENU to open the Style Play edit menu. This menu gives access to the various Style Play edit sections.

When in the menu, select an edit section using the VOLUME/VALUE (A-H) buttons, select an edit page using PAGE +, or press EXIT to exit the menu.

When in an edit page, press EXIT to go back to the main page of the Style Play operating mode.

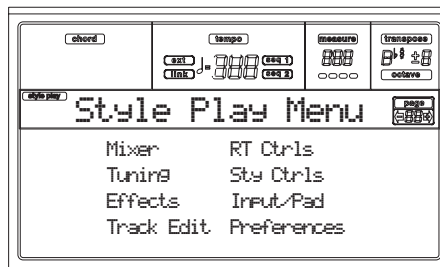

Each item in this menu corresponds to an edit section. Each edit section groups various edit pages.

EDIT PAGE STRUCTURE

Select an edit section from the Menu, and/or use the PAGE buttons to reach the desired page.

Press EXIT to go back to the main page of the Style Play mode.

All edit pages share the same structure.

Style Play icon *Page header* *Page number*

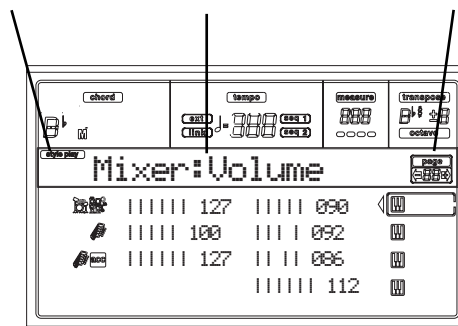

Style Play icon

When on, this icon indicates that the instrument is in Style Play mode.

Page header

The header shows the name of the current edit page. As a general rule, the header is divided into a first word, identifying the section name (e.g., “Mixer:FX Send” is a “Mixer” section page), and a second word, referring to the page name (e.g. “FX Send”).

Section name *Page name*

Mixer:FX Send

Page number

This area shows the current page number.

A-H

Each pair of VOLUME/VALUE (A-H) buttons selects a different parameter of command, depending on the edit page. After selecting a parameter, you can change its value by press-

ing one of the two buttons in a pair, or using the TEMPO/VALUE controls.

PAGE 1 - MIXER: VOLUME

This page lets you set the volume for each of the Realtime (Keyboard) or Style tracks.

Use the TRACK SELECT button to switch from the Realtime (Keyboard) tracks to the Style tracks, and vice versa.

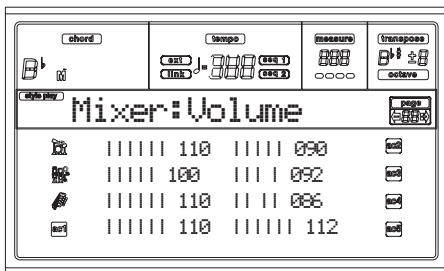
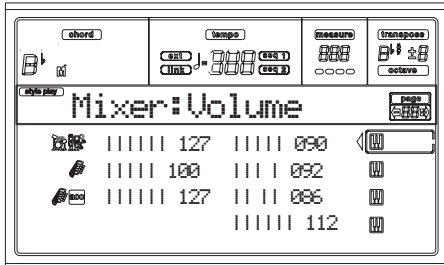

Volume ▶PERF ▶STYLE ▶STS
 Track's volume.
 0...127 MIDI value of the track's volume.

PAGE 2 - MIXER: PAN

This page lets you set the pan (position in the stereo front) for each track.

Use the TRACK SELECT button to switch from the Realtime (Keyboard) tracks to the Style tracks, and vice-versa.

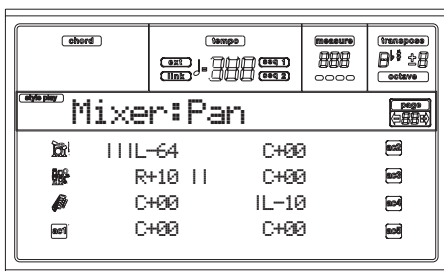
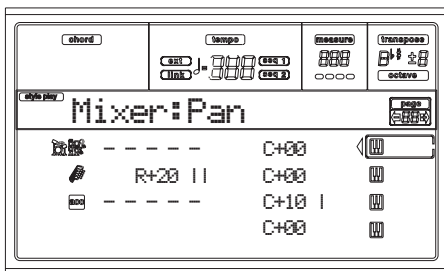

Pan ▶PERF ▶STYLE ▶STS
 L-64 Hard Left.
 C+00 Center.

R+63 Hard Right.
 Off The direct (unaffected) signal does not go to the outputs; only the FX signal is heard for this track.

PAGE 3 - MIXER: FX SEND

This page lets you set the level of the track's direct (unaffected) signal going to the Internal FX processors. The effect processors included in Pa50 are connected in parallel, so you can decide which percentage of the direct signal should be effected:

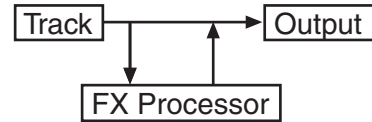

There are four Internal FX processors in Style Play mode. You can assign them any kind of available effects, but we found it convenient to arrange them in the following way, for all the Styles included with the Pa50:

- A Reverb processor for the Style tracks.
- B Modulating FX processor for the Style tracks.
- C Reverb processor for the Realtime (Keyboard) tracks.
- D Modulating FX processor for the Realtime (Keyboard) tracks.

Use the TRACK SELECT button to switch from the Realtime (Keyboard) tracks to the Style tracks, and vice-versa.

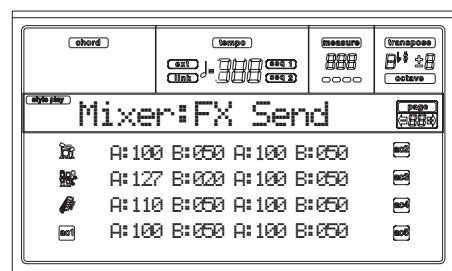
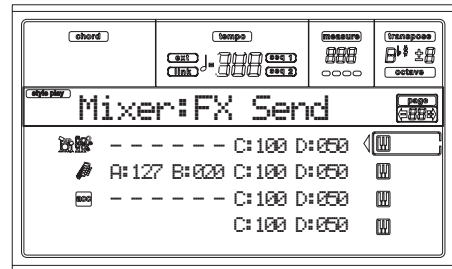

To select a parameter and edit its value:

1. Use the VOLUME/VALUE (A-H) buttons to select a track.
2. Use the F1-F4 buttons to select one of the effect processors.
3. Use the TEMPO/VALUE controls to change the value.

Send level ▶PERF ▶STYLE ▶STS
 000 No effect. Only the direct (unaffected) signal goes to the outputs.
 127 100% effect. The direct (unaffected) and effected signals go to the outputs with the same level.

PAGE 4 - TUNING: DETUNE

This page is the place where you can set the fine tuning for each track.

Use the TRACK SELECT button to switch from the Realtime (Keyboard) tracks to the Style tracks, and vice-versa.

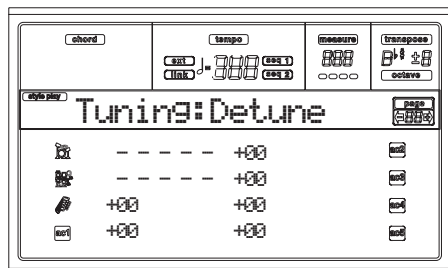
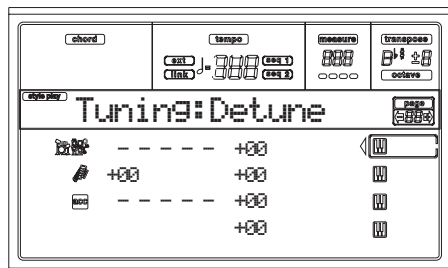

Detune

►PERF ►STYLE ►STS

This is the fine tuning value.

- 64 Lowest pitch.
- 00 Standard tuning.
- +63 Highest pitch.

PAGE 5 - TUNING: SCALE

This page lets you program the alternative scale for the selected tracks (see “Scale Mode” on page 51). The remaining tracks use the Scale set in the Global mode (see “Scale” on page 125).

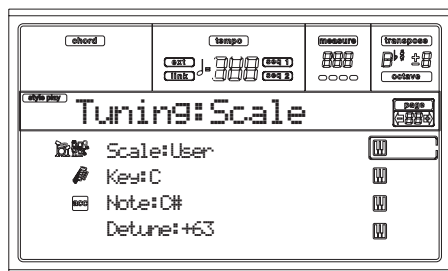

Scale

►PERF ►STS

Selected scale. See “Scales” on page 227 for a list of the available scales.

Key

►PERF ►STS

Parameter required for some Scales, when you should select a preferred key.

Note

►PERF ►STS

Note in edit, to be detuned. This parameter can be accessed when a User Scale is selected.

Detune

►PERF ►STS

Note detune, relative to the standard Equal tuning. This parameter can be accessed when a User Scale is selected.

PAGE 6 - TUNING: PITCHBEND SENSITIVITY

This page lets you program the Pitch Bend range for the Real-time (Keyboard) tracks.

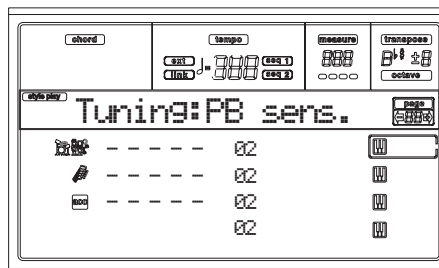

Parameters

►PERF ►STYLE ►STS

These parameters show the Pitch Bend range for each track, in semitones.

- 01...12 Maximum up/down pitchbend range (in semitones). 12 = ±1 octave.
- Off No pitchbend allowed.

PAGE 7 - FX: A/B SELECT

This page enables you to select the A and B effects. Usually, the A effect is the reverb, and the B effect is the modulating effect for the Style tracks.

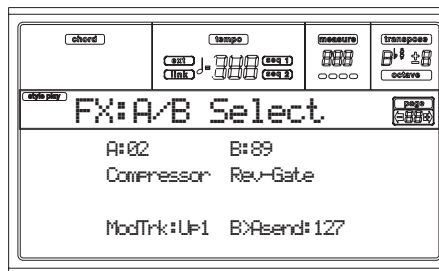

A, B

►PERF ►STYLE

Effects assigned to the A and B effect processors. Usually, A is the reverb, while B is the modulating effect (chorus, flanger, delay...). For a list of the available effects, see “Effects” on page 175.

ModTrk (Modulating Track)

►PERF ►STYLE

Source track for modulating MIDI messages. You can modulate an effect parameter with a MIDI message generated by a physical controller.

B>Asend (B>A Send)

►PERF ►STYLE

Amount of the B effect going back to the input of the A effect.

PAGE 8 - FX: C/D SELECT

This page lets you select the C and D effects. Usually, the C effect is the reverb, and the D effect is the modulating effect for the Realtime (Keyboard) tracks.

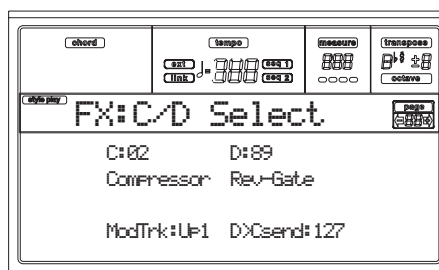

C, D ▶PERF ▶STS
Effects assigned to the C and D effect processors. Usually, C is the reverb, while D is the modulating effect (chorus, flanger, delay...). For a list of the available effects, see “Effects” on page 175.

ModTrk (Modulating Track) ▶PERF ▶STS
Source track for modulating MIDI messages. You can modulate an effect parameter with a MIDI message generated by a physical controller.

D>Csend (D>C Send) ▶PERF ▶STS
Amount of the D effect going back to the input of the C effect.

PAGE 9 - FX: A EDITING

This page contains the editing parameters for the A effect (usually, reverb for the Style tracks).



Use the E and H VOLUME/VALUE buttons to scroll the parameter list.

Parameters ▶PERF ▶STYLE
See “Effects” on page 175 for a list of available parameters for each effect type.

PAGE 10 - FX: B EDITING

This page contains the editing parameters for the B effect (usually modulating effect for the Style tracks). For more details, see “Page 9 - FX: A editing” above.

Parameters ▶PERF ▶STYLE

PAGE 11 - FX: C EDITING

This page contains the editing parameters for the C effect (usually reverb for the Realtime tracks). For more details, see “Page 9 - FX: A editing” above.

Parameters ▶PERF ▶STS

PAGE 12 - FX: D EDITING

This page contains the editing parameters for the D effect (usually modulating effect for the Realtime tracks). For more details, see “Page 9 - FX: A editing” above.

Parameters ▶PERF ▶STS

PAGE 13 - TRACK: EASY EDIT

In this page you can edit the main parameters of the Programs assigned to each track.

Note: All values are relative to the value of the original Program.

You can also change the volume for each class of Drums and Percussion, if the selected track is set in Drum mode (see below “Page 14 - Track: Mode”).

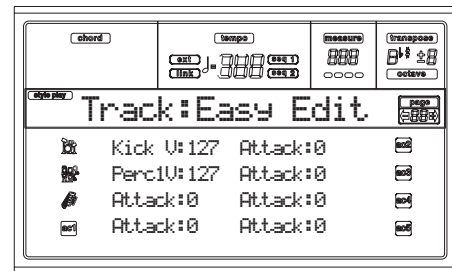
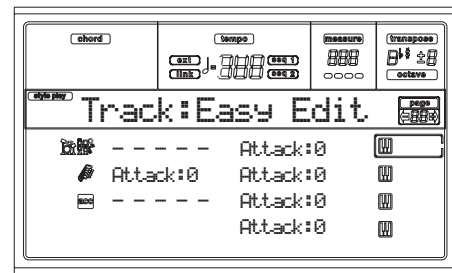

Here is the edit procedure:

1. Use the VOLUME/VALUE (A-H) buttons to select a track.
2. Use the F1-F4 buttons to select a Program parameter, or its value. (For the Drum and Percussion tracks, see below the “Drum tracks” section).
3. Use the TEMPO/VALUE controls to change the Program parameter or its value.

Parameters ▶PERF ▶STYLE ▶STS

- Attack** Attack time. This is the time during which the sound goes from zero (at the moment when you strike a key) to it’s maximum level.
- Decay** Decay time. Time to go from the final Attack level to the beginning of the Release.
- Release** Release time. This is the time during which the sound goes from the sustaining (or Decay) phase, to zero. The Release is triggered by releasing a key.
- Cutoff** Filter cutoff. This sets the sound brightness.
- Resonance** Use the Filter Resonance to define the width of the frequency range affected by the Filter.
- Vibrato Rate** Speed of the Vibrato.
- Vibrato Depth** Intensity of the Vibrato.
- Vibrato Delay** Delay time before the Vibrato begins, after the sound starts.

Drum tracks

When a track is set in Drum Mode (like the Drum and Percussion tracks), you can adjust the volume for each of the Drum and Percussion categories.

- Kick V** Kick drums volume.
- Snare V** Snare drums volume.
- Tom V** Toms volume.
- HiHat V** Hi-Hat volume.
- CymbalV** Ride, Crash and other cymbals volume.

- Percus1V "Classic" percussion set volume.
- Percus2V "Ethnic" percussion set volume.
- SFX V Special effects volume.

Reset

You can reset the parameters' value by keeping the SHIFT button pressed, while pressing one of the selected track VOLUME/VALUE buttons. After you press the above button combination, the Reset window appears:



Press ENTER/YES to reset the currently selected track. Keep SHIFT pressed, and press ENTER/YES, to reset all tracks. Press EXIT/NO to abort and keep all parameters unchanged.

PAGE 14 - TRACK: MODE

This page lets you set the polyphony mode for each track.

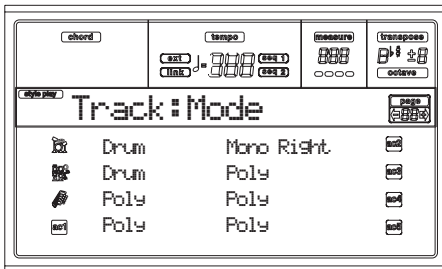
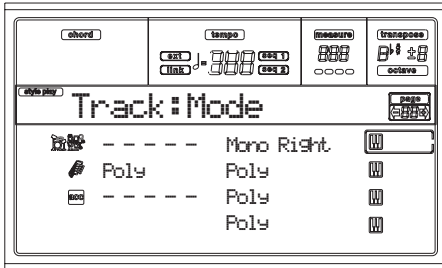

Parameters

▶PERF ▶STYLE ▶STS

- Drum** This is a Drum/Percussion track. No Master or Octave Transpose applies to this track. You can set a different volume for each class of percussive instruments (see "Page 13 - Track: Easy edit" on page 45).
- Poly** Tracks of this kind are polyphonic, i.e. they can play more than one note at the same time.
- Mono** Tracks of this kind are monophonic, i.e. each new note stops the previous note.

Mono Right A Mono track, but with priority assigned to the rightmost (highest) note.

PAGE 15 - TRACK: INTERNAL/EXTERNAL

This page lets you set the Internal or External status for each track. It is very useful to let a Style track drive an external expander, or play a digital piano with one of Pa50's Realtime tracks.

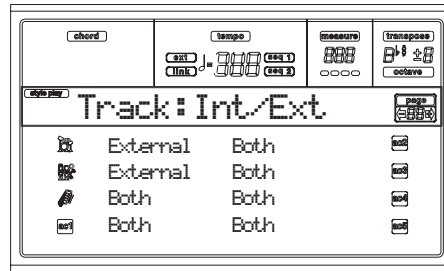
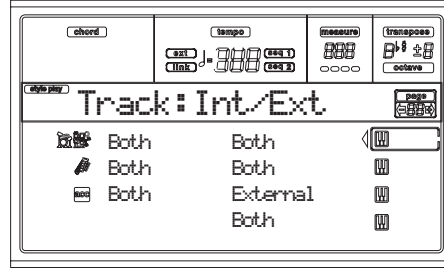

Parameters

▶PERF ▶STYLE ▶STS

- Internal** The track plays the sounds generated by the internal sound engine. It does not play an external instrument connected to the MIDI OUT.
- External** The track plays an external instrument connected to the MIDI OUT. It does not play the internal sounds, therefore saving polyphony. When a track is set to "External", a strings of transmitted Control Change and Program Change data is shown instead of the Program name assigned to the track. In the following example, CC#0 is the Control Change 0 (Bank Select MSB), CC#32 is the Control Change 32 (Bank Select LSB), PC is the Program Change.

```

121- 3- 0
  |   |   |
  CC#0 CC#32 PC
    
```

Both

The track plays both the internal sounds and an external instrument connected to the MIDI OUT.

PAGE 16 - R.T. CONTROLS: DAMPER

This page lets you enable/disable the Damper pedal for each of the Realtime (Keyboard) tracks.

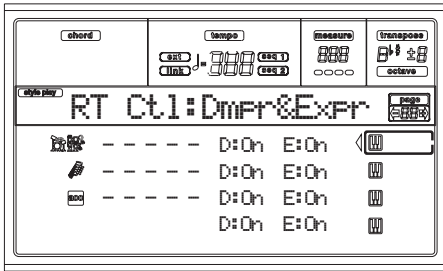

- D (Damper)** ▶PERF ▶STS
- On When you press the Damper pedal and release the keys, the track's sound is kept sustained.
- Off The Damper pedal is not active on any track set to this status.

E (Expression) ▶PERF ▶STS

This parameters allows you to switch the Expression control on/off on each individual Realtime track. The Expression control is a relative level control, always subtracted from the Volume value of the track.

As an example, imagine you have a Piano sound assigned to Upper 1, and a Strings sound assigned to Upper 2. If you turn the Expression switch on on Upper 2, and off on Upper 1, you can use a pedal to control only the Strings' volume, while the Piano remains unchanged.

To program a pedal or the Assignable Slider to act as an Expression control, see "Page 3 - Assignable Pedal/Foot-switch, Assignable Slider" on page 126. You can only assign this function to a volume-type pedal, not to a switch-type one. Assign the "KB Expression" option to the pedal or Assignable Slider, then press WRITE to save the setting into the Global.

PAGE 17 - R.T. CONTROLS: JOYSTICK

This page lets you enable/disable the Joystick for each of the Realtime (Keyboard) tracks.

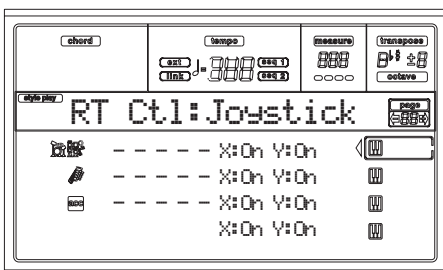

- Here is the edit procedure:
- Use the VOLUME/VALUE (E-H) buttons to select a track.
 - Use the F3-F4 buttons to select the X or Y parameter for that track.
 - Use the TEMPO/VALUE controls to change the status.
- X** ▶PERF ▶STS
- This enables/disables the left/right movement of the Joystick (Pitch Bend, and sometimes the sound parameter's control).

- Y** ▶PERF ▶STS
- This enables/disables the front/rear movement of the Joystick (Y+: Modulation, and sometimes the sound parameter's control; Y-: Various controls, or non-active).

PAGE 18 - R.T. CONTROLS: DYNAMIC RANGE

This page lets you program a dynamic range for each of the Realtime (Keyboard) tracks. This is useful to create a sound made of up to three dynamic layers, assigning each of the Upper tracks to a different dynamic range.

As an example, you may assign the El.Piano 1 Program to the Upper 1, and the El.Piano 2 Program to the Upper 2 track. Then, set Upper 1 to [L=0, H=80], and Upper 2 to [L=81, H=127]. The El.Piano 1 will play when playing softer, the El.Piano 2 when playing louder.

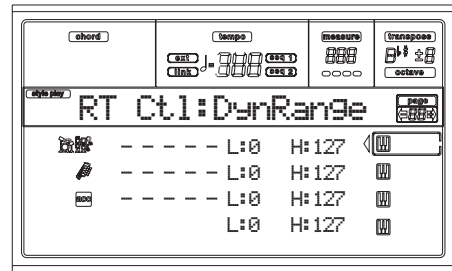

- Here is the edit procedure:
- Use the VOLUME/VALUE (E-H) buttons to select a track.
 - Use the F3-F4 buttons to select the L or H parameter for that track.
 - Use the TEMPO/VALUE controls to change the parameter's value.

- L/H** ▶PERF ▶STS
- This parameter pair sets the Lower and Higher dynamic range for the track.
- 0 Lowest velocity value.
- 127 Highest velocity value.

PAGE 19 - R.T. CONTROLS: ENSEMBLE

This page lets you program the Ensemble function. This function harmonizes the right-hand played melody with the left-hand recognized chords.

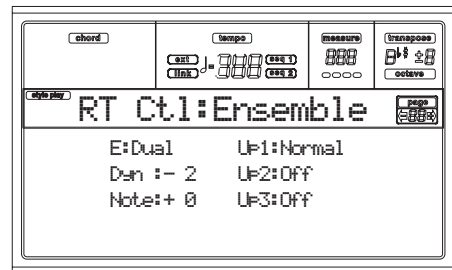

- Up1...Up3** ▶PERF ▶STS
- Right-hand (Upper) tracks.
- Off There is no harmonization on this track.
- Normal This track is included in the harmonization.
- Mute This track only plays the Ensemble notes, but not the original note.

E(nsemble)

▶PERF ▶STS

Harmonization type.

- Duet Adds a single note to the melody.
- Close Adds a closed-position chord to the melody.
- Open 1 Adds an open-position chord to the melody.
- Open 2 As the above, but with a different algorithm.
- Block Block harmonization – very typical of jazz music.

Power Ensemble

Adds a fifth and an octave to the melody, as heard in hard rock.

Fourths LO Typical of jazz, this option adds a perfect fourth and a minor seventh under the melody.

Fourths UP As the above, but with notes added over the melody.

Fifths This adds a series of Fifths below the original note.

Octave Adds one or more octaves to the melody.

Dual This option adds to the melody line a second note, at a fixed interval set with the “Note” parameter. When selecting this option, a transposition value appears (-24...+24 semitones to the original note).

Brass Typical Brass section harmonization.

Reed Typical Reed section harmonization.

Trill This option trills the melody note. You can set the trill speed by using the Tempo parameter (see below).

Note: You must play at least two notes with this option!

Repeat The played note is repeated in sync with the Tempo parameter (see below). When playing a chord, only the first note is repeated.

Echo As the Repeat option, but with the repeated notes fading away after the time set with the Feedback parameter (see below).

Dyn(amics)

▶PERF ▶STS

This parameter sets the velocity difference between the right-hand melody and the added harmonization notes.

-10...0 Subtracted velocity value.

Tempo

▶PERF ▶STS

Note: This parameter only appears when the Trill, Repeat or Echo options are selected.

Note value for the Trill, Repeat or Echo Ensemble options. This is in sync with the Metronome Tempo.

Feedback

▶PERF ▶STS

Note: This parameter only appears when the Echo option is selected.

This parameter sets how many times the original note/chord is repeated by the Echo option.

PAGE 20 - STYLE CONTROLS: DRUM/FILL

In this page you can select various general parameters for the Style.

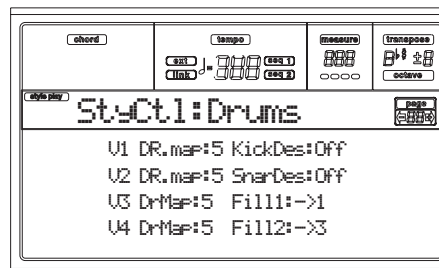
**V1-V4 Drum Map**

▶PERF ▶STYLE

The Drum Mapping lets you select an alternative arrangement of percussive instruments for the selected Drum Kit, without any additional programming. Just select a Drum Map, and some percussive instruments will be replaced with different instruments.

0...7 Drum Map number. Number 0 is the standard mapping.

Kick D(esignation)

▶PERF ▶STYLE

The Kick Designation replaces the original Kick (Bass Drum) sound with a different Kick of the same Drum Kit.

Off, 1...3 Kick replacing the original one. Off corresponds to the original Kick.

Snare D(esignation)

▶PERF ▶STYLE

The Snare Designation replaces the original Snare Drum sound with a different Snare of the same Drum Kit.

Off, 1...3 Snare replacing the original one. Off corresponds to the original Snare.

Fill1/2

▶PERF ▶STYLE

These parameters set a Variation to be automatically selected at the end of the Fill.

Off The same Variation, playing before selecting a Fill, will be selected again.

1&2...3&4 The specified Variations will be alternatively selected. For example, with the “1&2” option, Variation 1 and Variation 2 will be alternatively selected after the end of the Fill.

Up/Down The next higher/lower numbered Variation is selected, in cycle. After Variation 4, an Up command will select Variation 1. After Variation 1, a Down command will select Variation 4.

Inc/Dec The next higher/lower numbered Variation is selected. When Variation 4 is reached, an Inc command will select Variation 4 again. When Variation 1 is reached, a Dec command will select Variation 1 again.

->1...->4 “Fill to Variation” (->1, ->2, ->3, ->4) automatically selects one of the four available Style Variations at the end of the fill.

PAGE 21 - STYLE CONTROLS: WRAP AROUND / KEYBOARD RANGE

In this page you can program the Wrap Around function and the Keyboard Range for the Style tracks.

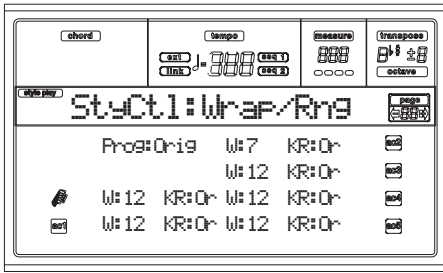

Here is the edit procedure:

1. Use the VOLUME/VALUE (A-H) buttons to select a parameter.
2. Use the F1-F4 buttons to move the cursor between the parameter and its status or value.
3. Use the TEMPO/VALUE controls to change the parameter's status or value.

Prog (Program) ▶PERF ▶STYLE

This parameter lets you select a different Program, other than the one recorded into the Style Element (Variations, Fills, Intros, Endings).

Note: This parameter is automatically set to On each time you assign a Program to any of the Style tracks, either from the front panel or via MIDI.

Original Style tracks always use the original Programs. If you assign a different Program to a Style track, it may be reset to the original one when selecting a different Style Element.

On You can assign different Programs to each Style track, and save them in a Performance or Style Performance. This becomes the only track's Program for all Style Elements.

W (Wrap Around) ▶PERF ▶STYLE

The wrap-around point is the highest register limit for the backing track. The accompaniment patterns will be transposed according to the detected chord. If the chord is too high, the Style tracks might play in a register that is too high, and therefore unnatural. If, however, it reaches the wrap-around point, it will be automatically transposed an octave lower.

The wrap-around point can be set for each track in semitone steps up to a maximum of 12 semitones, relative to the chord root. This value will be the interval between the key specified by the Style Element and the wrap-around point.

1...12 Maximum transposition (in semitones) of the track, referred to the original key of the pattern.

KR (Keyboard Range) ▶PERF ▶STYLE

This parameter is an on/off switch for the Key Range parameter memorized into the Style.

Original The Keyboard Range is used. When a track goes over the lower or higher limit set by this (hidden) parameter, it is transposed, to play into the programmed range.

Off No Keyboard Range used.

PAGE 22 - PADS

This page lets you select a different sound or function for each of the four PAD buttons.

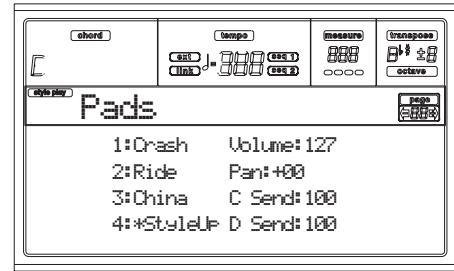

1-4 ▶PERF ▶STS

Each of the four PAD buttons. See "List of sounds assignable to the Pads" on page 226 and "List of functions assignable to the Pads" on page 227.

Note: Function names are preceded by an asterisk (*)

Volume ▶PERF ▶STS

Volume for each of the four Pad tracks.

Pan ▶PERF ▶STS

Pan for each of the four Pad tracks.

- 64 Fully Left.
- 00 Centered.
- +63 Fully Right.

C Send ▶PERF ▶STS

Send level to the C Internal FX processor (usually reverb) for each of the four Pad tracks.

D Send ▶PERF ▶STS

Send level to the D Internal FX processor (usually modulating effect) for each of the four Pad tracks.

PAGE 23 - PREFERENCES: LOCK

You can "lock" various functions, to avoid they can be changed when selecting a different Performance, Style or Single Touch Setting.

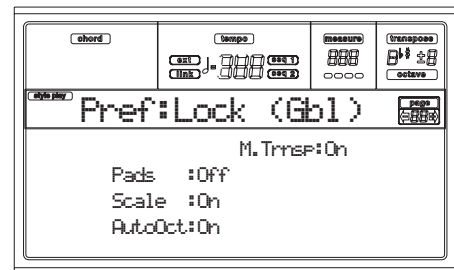

Hint: When turning the instrument on, Performance 1 is automatically selected. Therefore, if you wish your parameters to stay unchanged, save your preferred default settings into Performance 1 (see "The Write window" on page 42), and turn these locks on.

Note: These settings are stored in the Global file. After changing these settings, press WRITE to save them into the Global. The Write Global window will appear (see "The Write window" on page 125).

Pads ▶GBL

Sounds or functions assigned to the Pads.

Scale ▶ GBL

When this lock function is On, the Scale parameter does not change when selecting a different Performance, Style or Single Touch Setting.

Auto Octave ▶ GBL

This lock lets the instrument automatically transpose the Upper tracks when switching between the FULL UPPER and the SPLIT Keyboard modes.

On When switching to the FULL UPPER or SPLIT Keyboard Mode, the Upper tracks transposition is left unchanged.

Off When switching to the FULL UPPER Keyboard Mode, the Upper tracks Octave Transpose is automatically set to "0".

When switching to the SPLIT Keyboard Mode, the Upper tracks Octave Transpose is automatically set to "-1".

M.Trnsp (Master Transpose) ▶ GBL

The Master Transpose value is memorized into the Performance or Style Performance. To prevent the Master Transpose to be automatically changed when selecting a Style or Performance, this lock should be set to On.

On (Default) The lock is engaged. When selecting a Style or Performance, the Master Transpose will not change.

Off The lock is turned off. When selecting a Style or Performance, the Master Transpose value may change, according to the data memorized into the Performance or Style Performance.

Note: These settings are stored in the Global file. After changing these settings, press WRITE to save them into the Global. The Write Global window will appear (see "The Write window" on page 125).

Chord Recognition Mode ▶ GBL

This parameter sets how chords are recognized by the auto-accompaniment engine. Please note that when in Full or Upper Chord Scanning mode, the Fingered 3 mode is always selected, and you must always play at least three notes, to let a chord be recognized.

Fingered 1 Play one or more notes, according to the selected Chord Scanning Mode. A full Major chord will be recognized even if only a single note is played.

Fingered 2 You must always play three or more notes for a full chord to be recognized. If you play just one note, a unison will be played. If you play a suspended 5th, a suspended chord will be played. The full chord will be recognized when you play three or more notes.

Fingered 3 You must always play three or more notes for a chord to be recognized.

One Finger You can also compose a chord using a simplified chord playing technique:

- If you play only one note, a Major chord is recognized.
- Play the root note, plus a white key on the left, for a 7th. Ex.: C3 + B2.
- Play the root note, plus a black key on the left, for a Minor chord. Ex.: C3 + Bb2.
- Play the root note, plus a white and a black key on the left, for a Minor 7th. Ex.: C3 + B2 + Bb2.

PAGE 24 - PREFERENCES: CONTROLS

In this page you can set various general parameters for the Style.

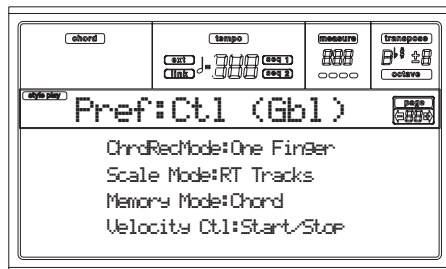

Scale Mode

▶GBL

This parameter determines which tracks will use the selected alternative scale (see “Scale” on page 44).

Realtime tracks

The scale will only affect the Realtime (Keyboard) tracks.

Upper tracks

The scale will only affect the Upper 1-3 Realtime (Keyboard) tracks.

All Tracks

The scale will affect all tracks (Realtime, Style, Pads).

Memory Mode

▶GBL

This parameter sets the way the MEMORY button works.

Chord

When its LED is on, the MEMORY button keeps the recognized chord in memory. When its LED is off, the chord is reset when raising the hand from the keyboard.

Chord + Lower

When its LED is on, the MEMORY button keeps the recognized chord in memory, and keeps the Lower track held until the next note or chord is played. When its LED is off, the

chord is reset when raising the hand from the keyboard, and the Lower track is not sustained.

Lower

When its LED is on, the MEMORY button keeps the Lower track held until the next note or chord is played. When off, the Lower track is not sustained when raising the hand from the keyboard. The chord is always kept in memory.

Velocity Control

▶GBL

Set this parameter to trigger a Fill or a Break simply by playing louder with your left hand. When playing on the Lower track with a velocity higher than 95, the selected Style Element will start. For this function to work, the SPLIT Keyboard Mode and LOWER Chord Scanning Mode must be selected.

Off

The function is turned off.

Break, Fill 1, Fill 2

When playing with a velocity higher than 95 on the Lower track, the selected element is automatically triggered.

Start/Stop

You can start or stop the Style by playing harder on the keyboard.

10. STYLE RECORD MODE

By entering the Style Record mode, you can create your own Styles, or edit an existing Style.

THE STYLE'S STRUCTURE

The term "Style" relates with music sequences automatically played by the arranger of the Pa50. A Style consists of a pre-defined number of **Style Elements (E)** (Pa50 features ten different Style Elements: Variation 1-4, Intro 1-2, Fill 1-2, Ending 1-2). When playing, these Style Elements can be selected directly from the control panel, using the corresponding buttons.

To explain the Style structure, we can use a tree-structure, as shown in the following diagram:

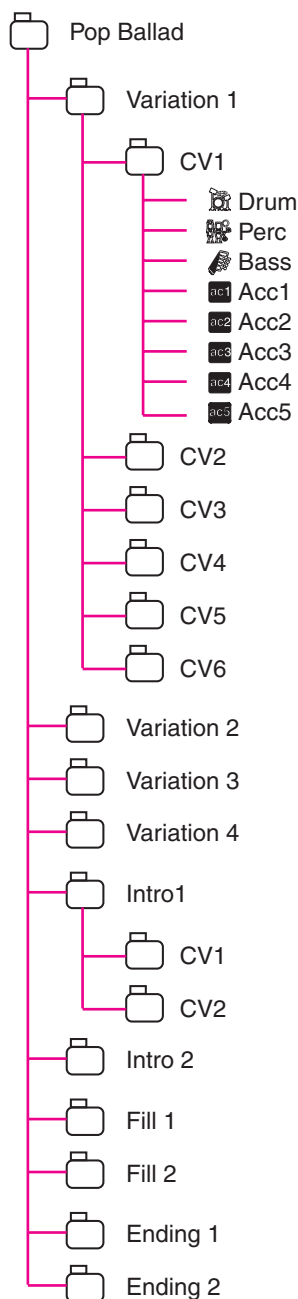

Each Style Element is made up of smaller units, called **Chord Variations (CV)**, but not all of them have the same number of CVs. Variations 1-4 have up to 6 CVs each, while the other Style Elements have only up to 2 CVs.

When you play on the chord recognition area (Lower, Upper or Full, depending on the Chord Scanning section on the control panel), the arranger scans the keyboard and determines which chord you are playing. Then, depending on the selected Style Element, it determines which Chord Variation (CV) should be played for the scanned chord. Which Chord Variation corresponds to each scanned chord is a setting of the Style: the **Chord Variation Table**. Each Style Element contains a Chord Variation Table, whose prototype is the following:

Chord	Chord Variations (CVs)	
	Variation 1-4	Intro 1-2, Fill 1-2, Ending 1-2
Maj	CV1 – CV6	CV1 – CV2
6		
M7		
M7b5		
Sus4		
Sus2		
M7sus4		
min		
m6		
m7		
m7b5		
mM7		
7		
7b5		
7sus4		
dim		
dimM7		
aug		
aug7		
augM7		
no 3rd		
no 3rd, no 5th		

After deciding what CV to play, the arranger triggers the right sequence for each track. Since each sequence is written in a particular key (for example, CMajor, GMajor or Emin), the arranger transposes it according to the scanned chord. Notes in the sequence are carefully transposed according to the **Note Transposition Tables (NTT)**, to make them work fine with all recognized chords. The NTT allows you to record just some Chord Variations, and have all the notes play in the right place, avoiding dissonances and transposing the pattern notes to the notes of the recognized chord.

Going deeper into the Style structure, we can see that each Chord Variation is made up of **Track Sequences**, and the Pa50 supports 8 different tracks. DRUM and PERC are used for drum and percussion sequences, BASS for bass and

ACC1-5 are for accompaniment sequences (string, guitar, piano or other accompaniment instruments).

Just to summarize, when you play a chord on the chord recognition area, the arranger determines which Style Element is used, then determines which Chord Variation should be used for the played chord, then Style sequences for every track of that Chord Variation are transposed from the original chord to the recognized chord using the NTT, and so on every time you play a chord.

Note: *The Break and the Count In are not Style Elements, and cannot be programmed by the user. While in record/edit, the BREAK/COUNT IN button does not work.*

What to record

Recording a Style is a matter of recording tracks, inside a series of Chord Variations, inside a series of Style Elements, inside the Style itself.

You don't need to record all Chord Variations for all Style Elements. It is often only necessary to record just a Chord Variation for each Style Element. Exceptions are the Intro 1 and Ending 1, where we suggest to record both a Major and minor Chord Variations.

STYLE IMPORT/EXPORT

You can use Korg's Style To Midi application to exchange Styles between your computer and the Pa50, through the Standard MIDI File (SMF) format. The application is freely downloadable from www.korgpa.com. Please read the included instructions.

ENTERING THE RECORD MODE

While in the Style Play operating mode, press RECORD. The following page will appear in the display:



- Select **Current Style** to edit the current Style. If it is a Factory Style, you will not be able to save it on the original location; you will select a User Style instead. When editing an existing Style, the original Style Performance is recalled, but the following parameters are reset to their default values: Drum Mapping (0), Snare & Kick Designation (Off), Program (Original), Keyboard Range (Original). This means that you can hear some differences between the Style in play and the same Style being edited; for example, resetting the Drum Mapping may lead to some instrument's replacement.

After editing the Style, please save it (see "Exit and Save/Abort Style" below). Then, edit the Style Performance to adjust the track's settings (Tempo, Volume, Pan, FX Send... see page 43 and following in the "Style Play operating mode" chapter) and save it by pressing the WRITE button.

- Select **New Style** to start from a new, empty Style. A default Style Performance will be recalled. When finished recording, you will save the new Style onto a User Style location.

After recording the Style, please save it (see "Exit and Save/Abort Style" below). Then, edit the Style Performance to adjust the track's settings (Tempo, Volume, Pan, FX Send... see page 43 and following in the "Style Play operating mode" chapter) and save it by pressing the WRITE button.

Note: *After a record or edit operation, the Style is rewritten in memory. When you press START/STOP there is a delay before you can actually listen to the Style. This delay is higher with a Style containing more MIDI events.*

Note: *While in Record mode, all footswitches are disabled.*

LISTENING TO THE STYLE WHILE IN RECORD/EDIT MODE

While you are in Record/Edit mode, you can listen to the selected Chord Variation or to the whole Style, depending on the page you are in.

To select a Chord Variation, go to the Main page of the Record/Edit mode (see "E (Style Element)" and "CV (Chord Variation)" on page 55).

- When you are in the Quantize, Transpose, Velocity, or Delete pages, you can listen to the selected Chord Variation. Press START/STOP to check how it works. Press START/STOP again to stop the playback.
- When you are in the Delete All, Copy, Style Element Controls or Style Control pages, you can listen to the whole Style. Press START/STOP and play some chords to do your tests. Select any Style Element using the control panel buttons (VARIATION 1-4, INTRO 1-2, FILL 1-2, ENDING 1-2). Press START/STOP again to stop the playback.

Note: *When doing the above tests, the Fingered 3 Chord Scanning mode is automatically selected.*

EXIT AND SAVE/ABORT STYLE

When finished editing, you can save your Style in memory, or abort any change. Press WRITE or RECORD to go to the Write page (see "The Write window" on page 54).

Note: *When saving the Style in memory, Pa50 automatically compresses it to reduce its size and save memory.*

Hint: *Save often while recording, to avoid accidentally losing your Style.*

THE WRITE WINDOW

This page appears when you press the WRITE or RECORD button while in Record mode. Here you can save the recorded or edited Style in memory.

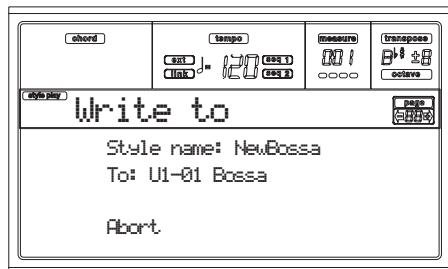

- To save the Style to the internal memory, press the A or B VOLUME/VALUE buttons, then press ENTER. The “Are you sure?” message will appear. Press ENTER to confirm, or EXIT to abort.
- To return to the previous Style Record page, leaving all untouched and the Style unsaved, press EXIT.
- To delete all changes to the Style, press one of the D VOLUME/VALUE buttons to select the Abort command. The “Are you sure message?” will appear. Press ENTER to confirm deletion, or EXIT to return to the Write page.

Style name

Use this parameter to change the Style’s name. Press the right A VOLUME/VALUE button to enter editing, and modify the name using the UP/DOWN buttons to move the cursor, and the DIAL to select a character. Press INSERT to insert a character at the cursor position, or DELETE to delete it

To (Style number)

Use the B VOLUME/VALUE buttons, or the TEMPO/VALUE controls, to select a different User Style location in memory.
Note: Only User locations are available.

Abort

Select this command to delete any change to the Style.

LIST OF RECORDED EVENTS

The Style Record mode filters out some events that may damage the right operation of the Style. Here are the recorded events, and the most important filtered-out events.

Control function	CC# (Control Change Number)
Allowed	
Note On	

Control function	CC# (Control Change Number)
Note Off*	
Pitch Bend	
Modulation 1	1
Modulation 2	2
Pan	10
Expression	11
CC#12	12
CC#13	13
Damper	64
Filter Resonance	71
Low Pass Filter Cutoff	74
CC#80	80
CC#81	81
CC#82	82
Not allowed	
After Touch	
Volume	7
All other Control Change messages	

(*) A Note Off will always be inserted at the end of the Chord Variation.

Note: Some Control Change messages cannot be recorded directly using Pa50 integrated controls.

FAST DELETE USING THE CONTROL PANEL BUTTONS

While in the Main page or the Style Tracks page, you can use the control panel buttons to delete various elements of the Style:

DELETE + note

When a track is selected, you can use this key sequence to delete a single note or a single percussive instrument.

If the Style is playing, this shortcut deletes the instrument only while the key is kept pressed, leaving all other notes untouched within the track.

DELETE + Track

While in the Style Tracks page, you can delete a whole track with a single shortcut. Keep the DELETE button pressed, then press one of the VOLUME/VALUE buttons corresponding to the track to be deleted. The “Are you sure?” message appear. Press ENTER to confirm, EXIT to abort.

MAIN PAGE

After pressing the RECORD button, and selected the Style to record/edit, the Main page of the Style Record mode appears.

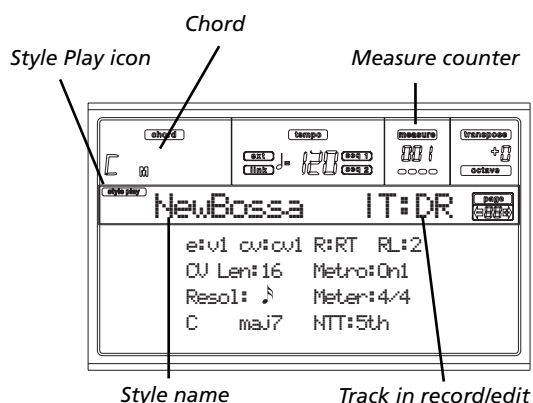

Style Play icon

When this icon appears in the display, you are in Style Play or Style Record mode.

Chord

While in the Main and Style Tracks page, this area shows the Original Key/Chord (see “Original Key/Chord” on page 56) for the selected track.

Style name

This is the name of the Style in record/edit.

Measure counter

This counter shows the measure in record. The measure range is specified by the “RecLen” parameter (see “RL (Recording Length)” on page 55).

Track in record/edit

Most editing in this edit mode are executed on a single track. While in the main page, the currently selected track is shown on the upper right area of the display. The abbreviations are: DR (Drums), PC (Percussion), BS (Bass), A1...A5 (Accompaniment 1...5).

To select the track to edit, press TRACK SELECT to jump to the Style Tracks page (see “Style Tracks page” on page 56) and use the VOLUME/VALUE buttons to select it.

E (Style Element)

Use the A VOLUME/VALUE buttons to select the line, and the F1 button to select this parameter.

This parameter lets you select the Style Element to put in edit. Each Style Element corresponds to one of the buttons on the control panel carrying the same name.

Note: When this parameter and the assigned value is in small letters (*e:v1*), the Style Element is empty; when it is in capitals (*E:V1*), it is already recorded

V1...V4 Variation 1 to Variation 4

I1...I2 Intro 1 to Intro 2

F1...F2 Fill 1 to Fill 2

E1...E2 Ending 1 to Ending 2

CV (Chord Variation)

Use the A VOLUME/VALUE buttons to select the line, and the F2 button to select this parameter. This parameter lets you select the Chord Variation to edit, after selecting the Style Element this Chord Variation pertains to.

Note: When this parameter and the assigned value is in small letters (*cv:cv1*), the Chord Variation is empty; when it is in capitals (*CV:CV1*), it is already recorded

SE:V1...V4 You can select one of 6 Chord Variations to edit.

SE:I1...E4 You can select one of 2 Chord Variations to edit.

R (Recording Mode)

This parameters lets you select between the Realtime and the Step recording modes. Use one of the E VOLUME/VALUE buttons and the F3 function key to select this parameter. Change its status using the E VOLUME/VALUE buttons, or the TEMPO/VALUE controls.

RT Realtime. This methods allows you to record in realtime each pattern of the Style.

Stp Step Record. This method allows you to enter the events one at a time. See “Style Record procedure” below for more information.

RL (Recording Length)

This parameter sets the recording length (in measures) of the selected track. Its value is always equal to, or a divider of, the Chord Variation Length (see next parameter).

This is not the total length of the Chord Variation, but just of the current track. For example, you may have a Chord Variation eight measures long, with a drum pattern repeating each two measures. If so, set the CV Len parameter to “8”, and the RecLen parameter to “2” before starting recording the Drum track. When saving the Style, or executing any edit operation on the Style, the 2-measures pattern will be extended to the full 8-measures length of the Chord Variation.

Warning: If you assign CVLen a value lower than RecLen, the value of RecLen is not immediately updated in the display. Therefore, you are still free of changing the value of CVLen, before the measures exceeding its value are deleted (see warning in “CVLen (Chord Variation Length)” below).

However, if you press START/STOP to begin recording, the real RecLen value is changed to the new one, even if the display still shows the old value.

For example, you may have CVLen = 4 and RecLen = 4. If you set CVLen to 2, and press START/STOP to begin recording, RecLen is still shown as 4, but it is in reality set to 2, and recording will cycle for just 2 measures. After you press START/STOP to stop recording, RecLen is updated to 2, and all measures after the second measure are deleted.

CVLen (Chord Variation Length)

This parameter sets the total length (in measures) for the selected Chord Variation. When playing a Style, this will be the length of the accompaniment pattern to be cycled, when the chord corresponding to the Chord Variation is recognized on the keyboard.

Warning: If you reduce the Chord Variation Length after recording, any measure after the selected length will be deleted. Be very careful when setting the CVLen to a lower value after recording!

Metro (Metronome)

This is the metronome heard during recording.

Off No metronome click will be heard during recording. A one-bar precount will be played before starting recording.

- On1 Metronome on, with a one-bar precount before starting recording.
- On2 Metronome on, with a two-bar precount before starting recording.

Resol (Resolution)

This parameter sets the quantization during recording.

♪ (1/32)...♪ (1/8)

Grid resolution, in musical values. For example, when you select 1/16, all notes are moved to the nearest 1/16 division. When you select 1/8, all notes are moved to the nearest 1/8 division.

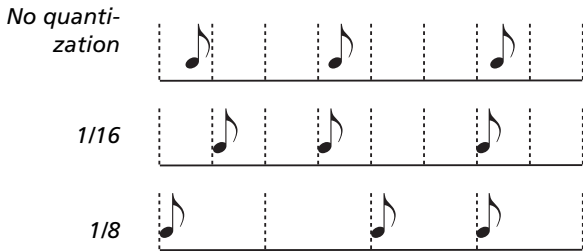

Meter

This is the meter (time signature) of the Style. You can edit this parameter only when the Style is empty, i.e. before you begin recording anything.

Original Key/Chord

This is the track's original key and chord. Use the D VOLUME/VALUE buttons to select the line, and the F1 and F2 buttons to switch from the key/chord name and the key/chord type (Maj, min...).

When in Style Play mode, this chord will be played back exactly as it was recorded, without any NTT processing (see below). To record just one Chord Variation for a Style Element, the suggested original key/chord is "maj7". Be very careful to play the 7th+ note (i.e., with a "Cmaj7th" key/chord, the B), to avoid the lack of notes, or a bad NTT conversion when playing different chords.

Note: To conform to Korg specifications, it is advisable to record both the "Major" and "minor" Chord Variations for the Intro 1 and Ending 1 Style Elements.

When you select a track, the original key/chord assigned to the selected track will be activated. All recorded tracks will play back on that key/chord. For example, if the original key/chord for the Acc1 track is A7th, when selecting the Acc1 tracks all the remaining tracks will play according to the A7th key/chord.

In the above example, you will record the Acc1 track in the AMajor key, with notes that will comply with the A7th chord. This is the pattern that will be recalled exactly as it was recorded, when playing an A7th chord.

Copying the Key/Chord value to all other tracks of the same Chord Variation. While in this page, you can keep the SHIFT button pressed, while pressing one of the [D] VOLUME/VALUE buttons, to copy the Key of the currently selected track to all other tracks of the same Chord Variation. This function is useful to speed-up pattern programming, and to avoid having different tracks in different keys within the same Chord Variation.

NTT

The Note Transposition Table (NTT) determines how the arranger will transpose pattern notes, when playing a chord that does not exactly match to the original chord of a Chord Variation. For example, if you only recorded a Chord Variation for the CMaj chord, when a CMaj7 is recognized on the keyboard the arranger must transpose some notes to create the missing 7th.

Note: To conform to Korg specifications, it is advisable to set the NTT to "No Transpose" on the Intro 1 and Ending 1.

- Root The root note (in CMaj = C) is transposed to the missing notes.
- 5th The 5th note (in CMaj = G) is transposed to the missing notes.
- i-Series All original patterns must be programmed on the "Maj7" or "min7" chords. When loading old Korg i-Series instruments, this option is automatically selected.
- No Transp No transposition applied. The pattern will always play as recorded. This is the standard setting of Intro 1 and Ending 1 in Korg's original Styles.

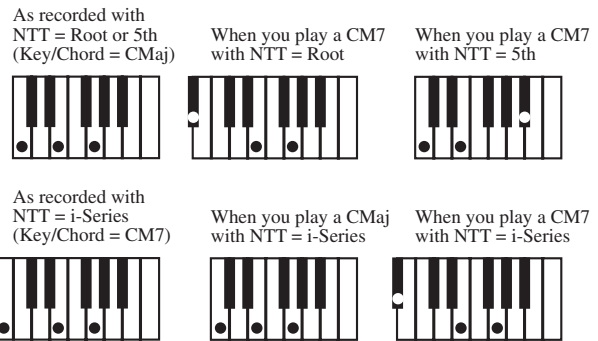

STYLE TRACKS PAGE

While in the main Style Record page, press TRACK SELECT to jump to this page. Here you can see and select any Style track.

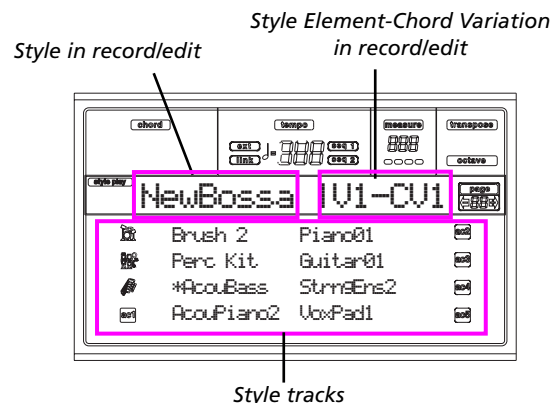

Program name

Select a track using the VOLUME/VALUE buttons. Select a Program using the PROGRAM/PERFORMANCE section. While in this page, you can set the track's volume using the VOLUME/VALUE buttons. Since the track's volume is memorized in the Style Performance and not in the pattern, this setting will not be recorded and saved. However, this will

allow you to play back louder any reference track, or the track you are recording.

Track status

When in the Style Tracks page, each track can be in one of three status.

Play (*Visible status icon*). This status is available only for non-selected tracks. When in play, a track can play back the recorded pattern.

Mute (*Hidden status icon*). When in this status, you can play the track on the keyboard, but you can't record on it. This is useful to do some preliminary test, before actually start recording.

To set a track in mute, first select it, then press both corresponding VOLUME/VALUE buttons to hide the status icon. To set the track in record again, press again the corresponding VOLUME/VALUE buttons.

Record (*Flashing status icon*). When in this status, the track is ready to record. Just select a track to set it in record status.

STEP RECORD PAGE

Access this page from the Main page of the Style Record mode, by selecting the "Stp" recording mode ("R" parameter), and pressing START/STOP.

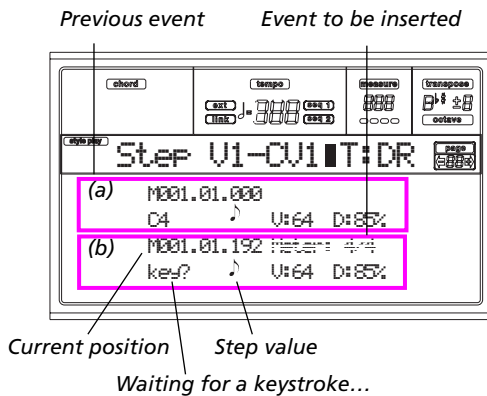

(a) section

Previously inserted event. You may delete this event, and set it in edit again, by pressing the < button.

(b) section

Event to be inserted. See the following parameters for information on each element of this section.

M (Measure)

This is the position of the event (note, rest or chord) to be inserted.

Meter

Meter of the current measure. This parameter can't be edited. You can set the Meter in the Main page of the Style Record

mode, before actually starting recording (see step 6 on page 58 for more information).

key?

This is a prompt, asking for a note or chord to be played on the keyboard, to enter an event on the current step.

Step value

Length of the event to be inserted. Use the NOTE VALUE buttons, on the lower left area of the control panel, to change this value.

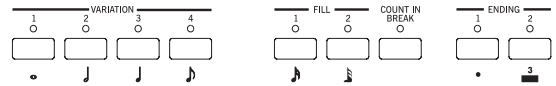

- o ... Note value.
- Dot (.) Augments the selected note by one half of its value.
- Triplet (3) Makes the selected note a triplet note.

V (Velocity)

Set this parameter before entering a note or chord. This will be the playing strength (i.e., velocity value) of the event to be inserted.

KBD Keyboard. You can select this parameter, by turning all counter-clockwise the dial. When this option is selected, the playing strength of the played note is recognized and recorded.

1...127 Velocity value. The event will be inserted with this velocity value, and the actual playing strength of the note played on the keyboard will be ignored.

D (Duration)

Relative duration of the inserted note. The percentage is always referred to the step value.

- 50% Staccato.
- 85% Ordinary articulation.
- 100% Legato.

Buttons used in Step Record mode

TIE button

Ties the note to be inserted to the previous note.

REST button

Inserts a rest.

NOTE VALUE buttons

Select the step value.

START/STOP button

Exits the Step Record mode.

< (Previous step)

Goes to the previous step, deleting the inserted step.

>> (Fast Forward)

Goes to the next measure, and fill the remaining space with rests.

STYLE RECORD PROCEDURE

There are two different methods for recording a Style: Real-time and Step.

- Realtime Recording allows you to record Style patterns in realtime.
- Step Recording allows you to create a new Style by entering the single notes or chords in each track. This is very useful when transcribing an existing score, or needing a higher grade of detail, and is particularly suitable to create drum and percussion tracks.

Preparing to record

1. If you like to edit an existing Style, select that Style.
2. Press RECORD to enter the Style Record mode. You are prompted to select either the Current Style, or a New Style.

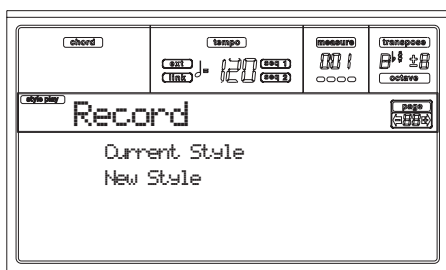

Select "Current Style" if you want to edit the current Style, or make a new Style starting from an existing one. Select "New Style" if you want to start from scratch with an empty Style.

3. After you select your preferred option, the Main page of the Style Record mode will appear.

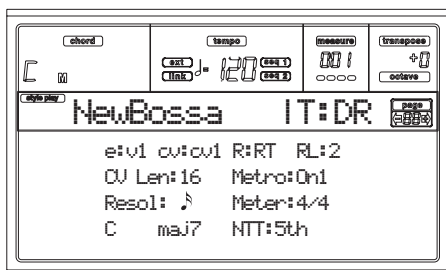

4. Use the A VOLUME/VALUE buttons, and the F1 and F2 function keys to select the E (Style Element) and CV (Chord Variation) parameter.

Note: For more information on the Style Elements and Chord Variations, and the Style structure in general, see "The Style's structure" on page 52.

5. Use the RL (Recording Length) parameter to set the length (in measures) of the pattern to step-record. Select this parameter using the E VOLUME/VALUE buttons and the F4 function key. Use the TEMPO/VALUE controls to set the value.
6. Use the Meter parameter to set the Style's meter. You can edit this parameter only if you selected the New Style option when entering the Record mode.
7. Set the tempo. Keep the SHIFT button pressed, and use the TEMPO/VALUE controls to change the tempo.
8. At this point, if you want to do a Realtime Recording go on reading "Realtime Record procedure" below. Other-

wise, if you prefer to do a Step Record, jump to "Step Record procedure" on page 59.

Realtime Record procedure

1. When still in the Main page of the Style Record mode, press one of the E VOLUME/VALUE buttons, to select the "R" parameter. Use these buttons, or the TEMPO/VALUE controls, to select the "RT" (Realtime) recording mode.

R:RT

2. Press TRK SELECT to switch to the Style Tracks page. Here you can assign the right Program to each Style track. (For more details, see "Style Tracks page" on page 56).

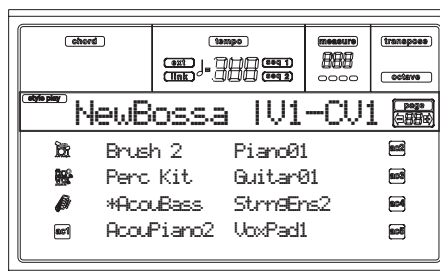

3. If you like, you can set the tempo again from this page: just use the TEMPO/VALUE controls.
4. Assign a Program to each track, by using the PROGRAM/PERFORMANCE section.
5. If needed, set the Octave Transpose for each track. *Note:* The Octave Transpose will affect only the notes coming from the keyboard, and not from the arranger.
6. Select the track to put in record. Its status icon will begin flashing.

Note: When entering the Record mode, the last selected track is already in record. When you press START/STOP after entering the Record mode, you can immediately start recording.

If you like, you can try your part before recording:

- Set the track in mute, by pressing both corresponding VOLUME/VALUE buttons; the status icon disappears.
 - Press START/STOP to play back the other tracks, if already recorded, and practice on the keyboard.
 - When you have finished practicing, press START/STOP to stop the arranger, and unmute the track by pressing both VOLUME/VALUE buttons; the track will be in record again.
7. While the status icon is flashing, press START/STOP to begin recording. Depending on the "Metro" (metronome) option you selected, a 1- or 2-bars precount may play before the recording actually begins. When it begins, play freely. The pattern will last for some measures, according to the RecLen value, then restart. Since the recording will happen in overdub, you can add notes on any following passage. This is very useful to record different percussive instruments at any cycle on a Drum or Percussion track.
- Note:* While recording, the track's **Keyboard Range** (see page 68) is ignored, and the track can play over the whole keyboard range. The **Local** parameter (see "Local" on

page 127) is also automatically set to On, to allow playing on the keyboard.

- When finished recording, press START/STOP to stop the arranger. Select a different track, and go on recording the whole Chord Variation.

Note: You can select a different track only when the arranger is not running.

- When finished recording the Chord Variation, select a different Chord Variation or Style Element to go on recording the whole Style.
- When finished recording the new Style, press WRITE or RECORD to save it in memory. The Write page will appear:

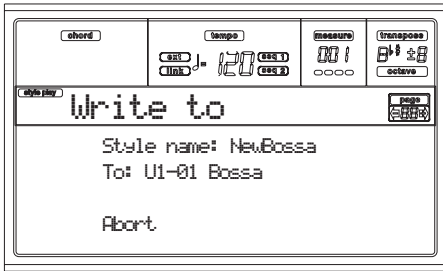

- To change the Style's name: press the right A VOLUME/VALUE button to enter editing, and modify the name using the UP/DOWN buttons to move the cursor, and the DIAL to select a character. Press INSERT to insert a character at the cursor position, or DELETE to delete it.

- To select a different location in memory, press one of the B VOLUME/VALUE buttons, then select a location with these buttons or the TEMPO/VALUE controls. Press ENTER to confirm, or one of the D (Abort) VOLUME/VALUE buttons to abort the save. The "Are you sure?" message will appear in the display. Press ENTER to confirm, EXIT to abort. After pressing ENTER, you will exit from the Record mode.

If you press EXIT while in the Write page, you will go back to the previous Style Record page, without any change.

Step Record procedure

- When still in the Main page of the Style Record mode, press one of the E VOLUME/VALUE buttons, to select the "R" parameter. Use these buttons, or the TEMPO/VALUE controls, to select the "Stp" recording mode.

R:Stp

- Press TRK SELECT to switch to the Style Tracks page. Here you can assign the right Program to each Style track. (For more details, see "Style Tracks page" on page 56).

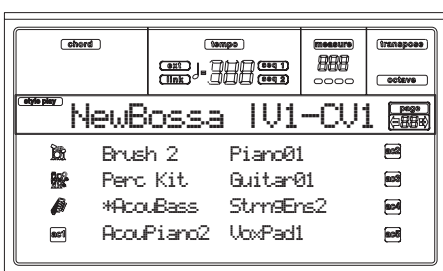

- Assign a Program to each track, by using the PROGRAM/PERFORMANCE section.
- Press START/STOP to turn on its LED and enter the Step Record page. (See "Step Record page" on page 57 for more information on each parameter of this page).

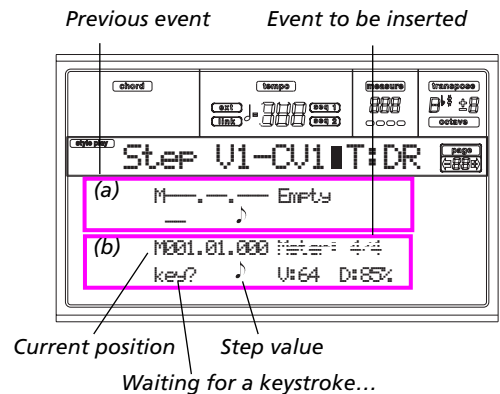

The first two lines (a) are the latest inserted event. The last two lines (b) are the event currently in edit, ready to be inserted.

The "Empty" event marks the beginning of the pattern, when there are no events inserted. It is automatically inserted when entering the Record mode. It will be removed when an event is inserted.

- The "Maaa.bb.ccc" parameter in (b) is the current position. This is the place where the note in edit will be inserted.

- If you don't want to insert a note at this position, insert a rest instead, as shown in step 7.

- To jump to the next measure, filling the remaining beats with rests, press the >> button.

- To change the step value, use the NOTE VALUE buttons, on the lower left area of the control panel.

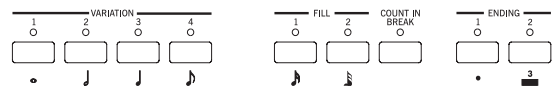

- Insert a note, rest or chord at the current position.

- To insert a single note, just play it on the keyboard. The inserted note length will match the step length. You may change the velocity and relative duration of the note, by editing the V (Velocity) and D (Duration) parameters. See "V (Velocity)" and "D (Duration)" on page 57.

- To insert a rest, just press the REST button. Its length will match the step value.

- To tie the note to be inserted to the previous one, press the TIE button. A note will be inserted, tied to the previous one, with exactly the same name. You don't need to play it on the keyboard again.

- To insert a chord or a second voice, see "Chords and second voices in Step Record mode" below.

- After inserting a new event, you may go back by pressing the < button. This will delete the previously inserted event, and set the step in edit again.

- When the end of the pattern is reached, the "End Loop" (End of Loop) event is shown in the first two lines of the display (a), and the recording restarts from the "M001.01.000" position. Any note exceeding the pattern length, inserted at its end, will be reduced to fit the total length of the pattern.

At this point, you may go on, inserting new events in overdub mode (the previously inserted events will not be deleted). This is very useful when recording a drum or percussion track, where you may want to record the bass drum on a first cycle, the snare drum on the second cycle, and the hi-hat and cymbals during the following cycles.

- When finished recording, press START/STOP to turn off its LED. The Main page of the Style Record mode appears.

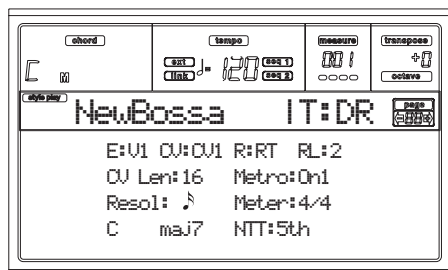

When exiting, the “RT” recording mode is automatically selected. You may press START/STOP to listen to the Style. Press START/STOP again to stop the playback. To enter the Step Record mode again, select the “Stp” recording mode, and press START/STOP.

- From the Main page of the Style Record mode, press RECORD to exit the Record mode. You will be prompted to assign a new name to the Style, and select a memory location where to save it. See “The Write window” on page 54 for information on how to save a Style.

Chords and second voices in Step Record mode

With Pa50, you are not obliged to insert single notes in a track. There are several ways to insert chords and double voices. Lets look at some.

Inserting a chord. When the “key?” prompt appears in the display, play a chord instead of a single note. The event’s name will be the first note of the chord you pressed, followed by the “...” marking.

C4 , ... ♩ U:64 D:85%

Inserting a chord with notes with different velocity values. You can make the upper or lower note of a chord, for example, louder than the remaining ones, to make the most important note emerge from the chord. Here is how to insert a three-note chord:

- Edit the Velocity value of the first note.
- Press the first note and keep it pressed.
- Edit the Velocity value of the second note.
- Press the second note and keep it pressed.
- Edit the Velocity value of the third note.

- Press the third note, then release all notes.

Inserting a second voice. You can insert passages where one note is kept pressed, and another voice moves freely.

Ex. 1:

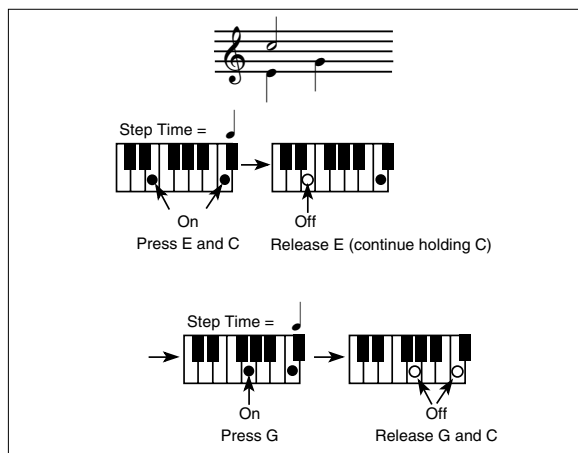

Ex. 2:

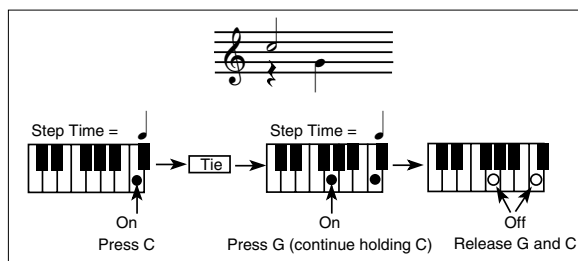

Ex. 3:

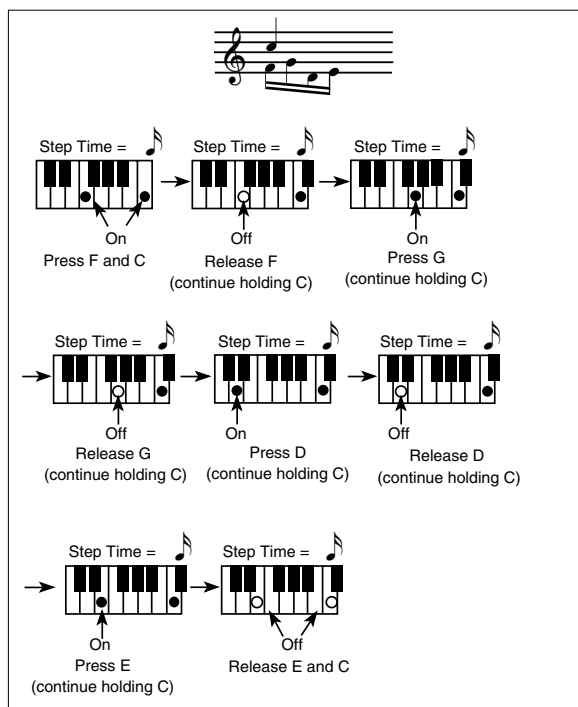

MENU

From any page of the Style Record mode, press MENU to open the Style Record edit menu. This menu gives access to the various Style Record edit sections.

Note: While the Style is in play, you cannot access the Edit section pages from the Main page and the Style Tracks page (see page 55 and page 56). Stop the playback before pressing MENU.

When in the menu, select an edit section using the VOLUME/VALUE (A-H) buttons, select an edit page using PAGE +, or press EXIT to exit the menu.

When in an edit page, press EXIT to go back to the main page (or the Style Tracks page) of the Style Record mode.

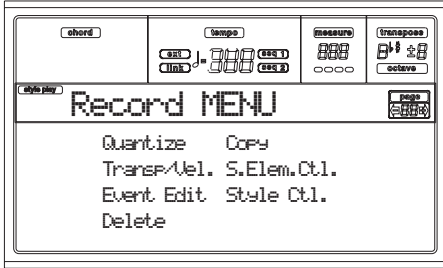

Each item in this menu corresponds to an edit section. Each edit section groups various edit pages.

Note: When switching from the Edit section pages (Quantize, Transpose, Velocity, Delete) to the other pages, or vice-versa, the Style (if in play) is automatically stopped.

EDIT PAGE STRUCTURE

Select an edit section from the Menu, and/or use the PAGE buttons to reach the desired page.

Press EXIT to go back to the main page of the Style Record mode.

All edit pages share the same structure.

Style Play icon Page header Page number

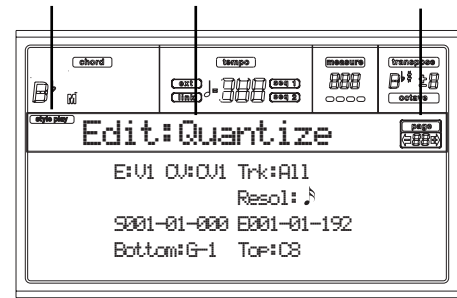

Style Play icon

When on, this icon indicates that the instrument is in Style Play mode.

Page header

The header shows the name of the current edit page. As a general rule, the header is divided in a first word, identifying the section name (e.g., “Edit:Quantize” is an “Edit” section page), and a second word, referring to the page name (e.g. “Quantize”).

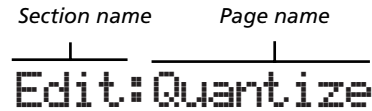

Page number

This area shows the current page number.

A-H

Each pair of VOLUME/VALUE (A-H) buttons selects a different parameter of command, depending on the edit page. After selecting a parameter, you can change its value by pressing one of the two buttons in a pair, or using the TEMPO/VALUE controls.

PAGE 1 - EDIT: QUANTIZE

The quantize function may be used to correct any rhythm error after recording, or to give the pattern a “groovy” feeling.



After setting the various parameters, press ENTER to execute. The “Are you sure?” message will appear. Press ENTER to confirm, EXIT to abort.

E/CV (Style Element/Chord Variation)

(Non editable) These read-only parameters show which Style Element and Chord Variation are currently selected for editing. See the Main page “E (Style Element)” and “CV (Chord Variation)” parameters on page 55 for information on selecting a different Style Element and Chord Variation.

Trk (Track)

Use this parameter to select a track.

All All tracks selected.
Drum...Acc5 Selected track.

Resol (Resolution)

This parameter sets the quantization after recording. For example, when you select 1/8a, all notes are moved to the nearest 1/8 division. When you select 1/4, all notes are moved to the nearest 1/4 division.

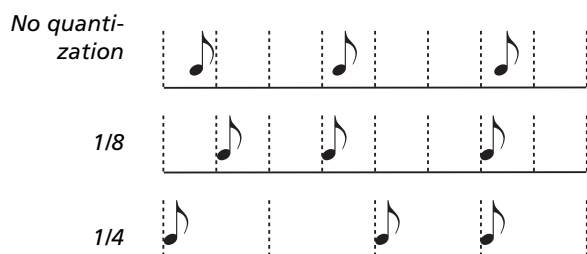

♩ (1/32)...♩ (1/4)

Grid resolution, in musical values. An “a” after the value means no swing. A “b...f” after the value means swing-quantization.

S / E (Start/End)

Use these parameters to set the starting (S) and ending (E) points of the range to quantize.

If a Chord Variation is four measures long, and you want to select it all, the Start will be positioned at 1.01.000, and the End at 5.01.000.

Bottom / Top

Use these parameters to set the bottom and top of the keyboard range to quantize. If you select the same note as the

Bottom and Top parameters, you can select a single percussive instrument in a Drum or Percussion track.

Note: These parameters are available only when a Drum or Percussion track is selected.

PAGE 2 - EDIT: TRANSPOSE

In this page you can transpose the selected track(s).

Note: After transposing, please don't forget to readjust the “Original Key/Chord” parameter in the Style Record page (see page 56).

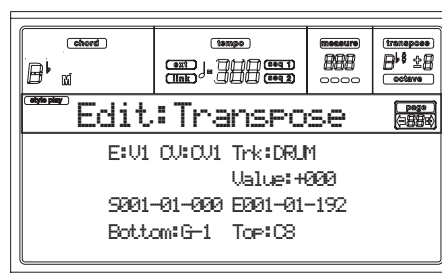

After setting the various parameters, press ENTER to execute. The “Are you sure?” message will appear. Press ENTER to confirm, EXIT to abort.

E/CV (Style Element/Chord Variation)

(Non editable) These read-only parameters show which Style Element and Chord Variation are currently selected for editing. See the Main page “E (Style Element)” and “CV (Chord Variation)” parameters on page 55 for information on selecting a different Style Element and Chord Variation.

Trk (Track)

Use this parameter to select a track.

All All tracks selected, apart for tracks set in Drum mode (like the Drum and Percussion tracks). The whole selected Chord Variation will be transposed.

Drum...Acc5 Single selected track.

Value

Transpose value (± 127 semitones).

S / E (Start/End)

Use these parameters to set the starting (S) and ending (E) points of the range to be transposed.

If a Chord Variation is four measures long, and you want to select it all, the Start will be positioned at 1.01.000, and the End at 5.01.000.

Bottom / Top

Use these parameters to set the bottom and top of the keyboard range to be transposed. If you select the same note as the Bottom and Top parameters, you can select a single percussive instrument in a Drum or Percussion track. Since in a Drum Kit each instrument is assigned to a different note of the scale, transposing a percussive instrument means assigning the part to a different instrument.

Note: These parameters are available only when a Drum or

PAGE 3 - EDIT: VELOCITY

In this page you can change the velocity (dynamics) value of notes in the selected track.

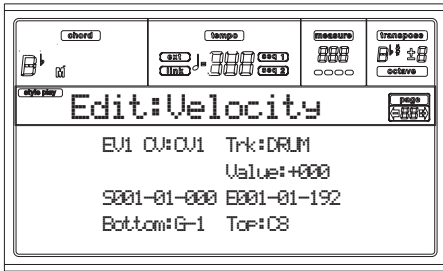

After setting the various parameters, press ENTER to execute. The “Are you sure?” message will appear. Press ENTER to confirm, EXIT to abort.

E/CV (Style Element/Chord Variation)

(Non editable) These read-only parameters show which Style Element and Chord Variation are currently selected for editing. See the Main page “E (Style Element)” and “CV (Chord Variation)” parameters on page 55 for information on selecting a different Style Element and Chord Variation.

Trk (Track)

Use this parameter to select a track.

All All tracks selected. The velocity for all notes of the whole selected Chord Variation will be changed.

Drum...Acc5 Selected track.

Value

Velocity change value (±127).

S / E (Start/End)

Use these parameters to set the starting (S) and ending (E) points of the range to be modified.

If a Chord Variation is four measures long, and you want to select it all, the Start will be positioned at 1.01.000, and the End at 5.01.000.

Bottom / Top

Use these parameters to set the bottom and top of the keyboard range to be modified. If you select the same note as the Bottom and Top parameters, you can select a single percussive instrument in a Drum or Percussion track.

Note: These parameters are available only when a Drum or Percussion track is selected.

PAGE 4 - EVENT EDIT

The Event Edit page allows you to edit each event in a single track. See “Event Edit procedure” on page 64 for more information on the event editing procedure.

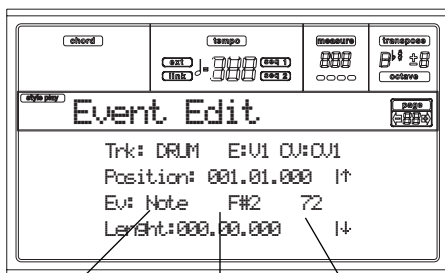

Event Type First value Second value

Trk (Track)

Track in edit. To select a different track, press one of the A VOLUME/VALUE buttons to open the Go To Track window.



Use the TEMPO/VALUE controls to select a track, and press ENTER to confirm, or EXIT to abort.

E/CV (Style Element/Chord Variation)

Selected Style Element and Chord Variation. This parameter can't be edited. To select a different Style Element and Chord Variation, press EXIT to go back to the Main page of the Style Record mode (see “Main page” on page 55).

Position

Position of the event shown in the display, expressed in the form 'aaa.bb.ccc':

- 'aaa' is the measure
- 'bb' is the beat
- 'ccc' is the tick (each quarter beat = 384 ticks)

You can edit this parameter to move the event to a different position.

Ev (Event)

Type and values of the event shown in the display. Depending on the selected event, the value may change. This parameter also shows the (non-editable) “End Loop” marking, when the end of a track is reached.

Event	First value	Second value
Note	Note name	Velocity
Ctrl	Control Change number	Control Change value
Bend	Bending value	-

To change the event type, use the C VOLUME/VALUE buttons to select the Event line, then use the same buttons or the TEMPO/VALUE controls to select a different event type.

To select and edit the event's value, use the F3 and F4 function keys, and use the G/VOLUME/VALUE buttons or the TEMPO/VALUE controls.

Length

Length of the selected Note event. The value format is the same as the Position value.

Note: If you change a length of “000.00.000” to a different value, you can't go back to the original value. This rather uncommon zero-length value may be found in some drum or percussion tracks.

Transport, navigation and editing controls

E/F and H VOLUME/VALUE buttons

These buttons are the “Scroll to previous event” (E/F) and “Scroll to next event” (H) controls. They corresponds to the scrolling arrows shown on the screen.

G VOLUME/VALUE buttons

Use these buttons to select the corresponding parameter value area.

F3 and F4 buttons

After selecting the parameter value area with the G VOLUME/VALUE buttons, use these buttons to select, respectively, the first and second value of the event in edit.

START/STOP button

Press START/STOP and play some chords on the keyboard to test the pattern in edit. Press START/STOP again to stop the pattern running.

SHIFT + << or >>

Keep the SHIFT button pressed and press the << or >> button to open the Go to Measure window.

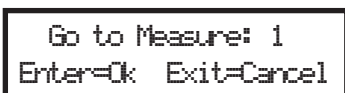

Use the TEMPO/VALUE controls to select a measure, then press ENTER to confirm, or EXIT to abort.

INSERT

Press the INSERT button to insert a new event at the current shown Position. The default values are Type = Note, Pitch = C4, Velocity = 100, Length = 192.

After inserting an event, use the C VOLUME/VALUE buttons to select the Event line, and the same buttons or the TEMPO/VALUE controls to select a different event type.

DELETE

Press the DELETE button to delete the event shown in the display.

PAGE 5 - EVENT FILTER

This page is where you can select the event types to be shown in the Event Edit page. You can access this page by pressing the PAGE+ button, while you are in the Event Edit page.

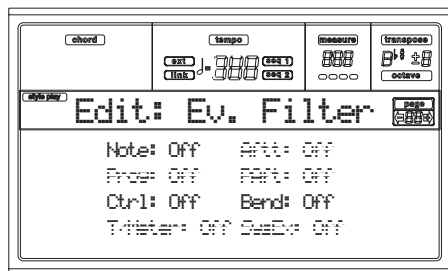

Turn Off the filter for all event types you wish to see in the Event Edit page.

Note: Some of the events are “ghosted”, and non editable, since the corresponding events are not editable in a Style.

Note Notes.

Ctrl Control Change events. Only the following Control Change numbers are allowed.

Control function	CC# (Control Change Number)
Modulation 1	1
Modulation 2	2
Pan	10
Expression ^(a)	11
CC#12	12
CC#13	13

Control function	CC# (Control Change Number)
Damper	64
Filter Resonance	71
Low Pass Filter Cutoff	74
CC#80	80
CC#81	81
CC#82	82

(a) Expression events cannot be inserted at the starting Position (001.01.000). An Expression value is already among the default “header” parameters of the Style Element.

Bend Pitch Bend events.

EVENT EDIT PROCEDURE

The Event Edit is the page where you can edit each single MIDI event of the selected Style Element. You can, for example, replace a note with a different one, or change its playing strength (i.e., velocity value). Here is the general event editing procedure.

1. Select the Style to edit, and press RECORD. Select the “Current Style” option to enter recording. The LED on the RECORD button will turn on, and the Main page of the Style Record mode will appear.

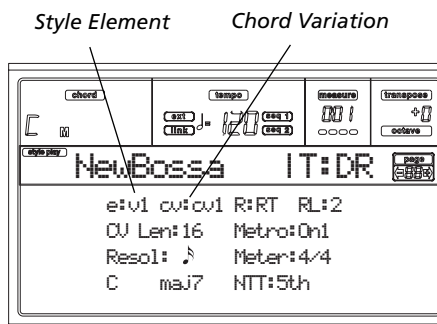

2. Use the A VOLUME/VALUE buttons, and the F1 and F2 function keys to select the E (Style Element) and CV (Chord Variation) parameters.

Note: For more information on the Style Elements and Chord Variations, and the Style structure in general, see “The Style’s structure” on page 52.

3. Press MENU, and use the VOLUME/VALUE (A-H) buttons to select the Event Edit section. The Event Edit page appears (see “Page 4 - Event Edit” on page 63 for more information).

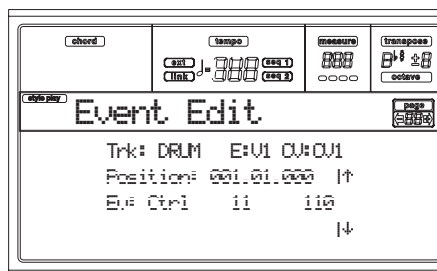

4. Press START/STOP to listen to the selected Chord Variation. If you like, play some chords on the keyboard, to test the pattern. Press START/STOP to stop it.
5. Press PAGE+ to go to the Event Filter page, and turn “Off” the filters for the event types you wish to see in the

display (see “Page 5 - Event Filter” on page 64 for more information).

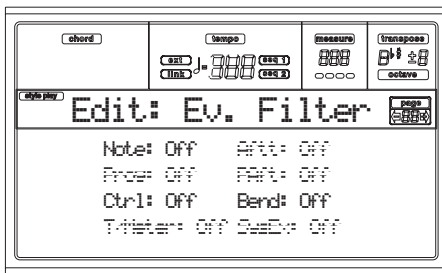

6. Press PAGE- to go back to the Event Edit page.
7. Press the A VOLUME/VALUE button (Trk), to select the track to edit. The Go To Track window appears.



Use the TEMPO/VALUE controls to select a track, and press ENTER to confirm (or EXIT to abort).

8. The list of events contained in the selected track (in the Style Element and Chord Variation selected on step 2) will appear in the display. The first step, or Measure Start, is currently shown. Since it contains an initialization event, it is not editable and appears “in grey” (i.e., written with a “ghost” character).

Position: 001.01.000 |
Ev: Ctr1 11 110

9. Press one of the H VOLUME VALUE buttons (Scroll Down arrow), to go to the next step. This is usually a note, that you can edit.

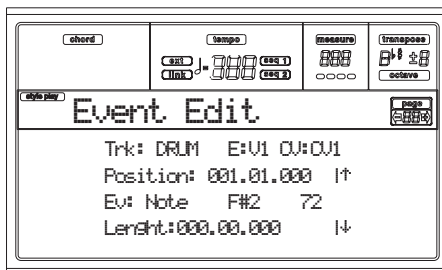

For more information on the event types and their values, see “Page 4 - Event Edit” on page 63.

10. Use the B VOLUME/VALUE buttons to select the Position line. Use these buttons or the TEMPO/VALUE controls to change the event’s position.

Position: 001.01.001
Measure Beat Tick

11. Use the C VOLUME/VALUE buttons to select the Event line. You may use the C VOLUME/VALUE buttons or the TEMPO/VALUE controls to change the event type. Use the G VOLUME/VALUE buttons, and the F3 and F4 function keys to respectively select the first and second value of the parameter. Use the G VOLUME/VALUE

buttons or the TEMPO/VALUE controls to modify the selected value.

Ev: Note F#2 72
Event Type First value Second value

12. If a Note event is selected, use the D VOLUME/VALUE buttons to select the Length line, and use the same buttons, or the TEMPO/VALUE controls, to change the event’s length.

Length: 000.00.000
Measure Beat Tick

- After having modified the shown event, you may scroll to the next event with the H VOLUME/VALUE buttons (Scroll to next), or to the previous event with the E/F VOLUME/VALUE buttons (Scroll to previous).
 - You may use the SHIFT + << or >> shortcut to go to a different measure (see “SHIFT + << or >>” on page 64)
 - As described in step 4, you may press START/STOP and play some chords to listen how the pattern sounds after your changes. Press START/STOP again to stop the pattern running.
13. Use the INSERT button to insert an event at the Position shown in the display (a Note event with default values will be inserted). Use the DELETE button to delete the event shown in the display.
 14. When the editing is complete, you may select a different track (go to step 7), or a different Style Element and Chord Variation (press EXIT to go back to the Main page of the Style Record mode, then go to step 2).
 15. When finished editing the whole Style, press WRITE to open the Write Style page.

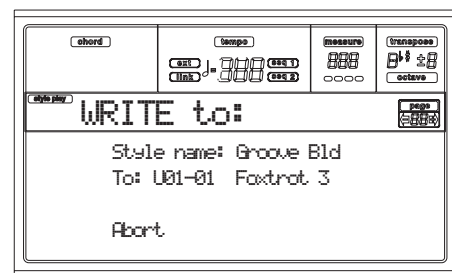

- Use the A or E VOLUME/VALUE buttons to enter the Text Editing mode. Use the UP and DOWN buttons to move the cursor, and the dial to select a character.
- Use the B VOLUME/VALUE buttons to select a target location. The name of the Style already existing at the selected location is shown after the Style Bank-Location number.

Warning: If you select an existing Style and confirm writing, the older Style is deleted and replaced by the new one. Save the Styles you don’t want to loose on disk, before overwriting them.

16. Press ENTER to save the Style to the internal memory, or one of the D VOLUME/VALUE buttons (Abort) to delete any changes made in Style Record mode. When the “Are you sure?” message appears, press ENTER to confirm, or EXIT to go back to the Write Style page.

PAGE 6 - EDIT: DELETE

This page is where you can delete single elements or MIDI events out of the Style.

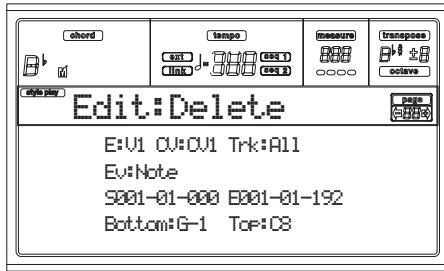

After setting the various parameters, press ENTER to execute. The “Are you sure?” message will appear. Press ENTER to confirm, EXIT to abort.

E/CV (Style Element/Chord Variation)

(Non editable) These read-only parameters show which Style Element and Chord Variation are currently selected for editing. See the Main page “E (Style Element)” and “CV (Chord Variation)” parameters on page 55 for information on selecting a different Style Element and Chord Variation.

Trk (Track)

Use this parameter to select a track.

All All tracks selected. After deletion, the selected Chord Variation will remain empty.

Drum...Acc5 Selected track.

Ev (Event)

Type of MIDI event to delete.

All All events. The measures are not removed from the Chord Variation.

Note All notes in the selected range.

Dup.Note All duplicate notes. When two notes with the same pitch are encountered on the same tick, the one with the lowest velocity is deleted.

A.Touch After Touch events.

Note: This kind of data is automatically removed during recording.

P.Bend Pitch Bend events.

PrChange Program Change events, excluding the bundled Control Change #00 (Bank Select MSB) and #32 (Bank Select LSB).

Note: This kind of data is automatically removed during recording.

C.Change All Control Change events, for example Bank Select, Modulation, Damper, Soft Pedal...

CC00/32...CC127

Single Control Change events. Double Control Change numbers (like 00/32) are MSB/LSB bundles.

Note: Some CC data are automatically removed during recording. See the table on page 54 for more information on the allowed data.

S / E (Start/End)

Use these parameters to set the starting (S) and ending (E) points of the range to delete.

If a Chord Variation is four measures long, and you want to select it all, the Start will be positioned at 1.01.000, and the End at 5.01.000.

Bottom / Top

Use these parameters to set the bottom and top of the keyboard range to delete. If you select the same note as the Bottom and Top parameters, you can select a single percussive instrument in a Drum or Percussion track.

Note: These parameters are available only when the All or Note option is selected.

PAGE 7 - EDIT: DELETE ALL

This function lets you quickly delete a selected Style Element or Chord Variation, or the whole Style, resetting it to the default parameter's values.



After setting the various parameters, press ENTER to execute. The “Are you sure?” message will appear. Press ENTER to confirm, EXIT to abort.

When in this page, press the corresponding button on the control panel to select a Style Element (VARIATION1 ... ENDING2).

Del (Delete)

Use this parameter to select the whole Style, a single Style Element, or a single Chord Variation.

All All Style Elements, i.e. the whole Style. When Del=All and Trk=All, the whole Style is deleted, and all parameters set to the default status.

Var1...End2 Single Style Element.

V1-CV1...E2-CV2

Single Chord Variation.

Trk (Track)

All All tracks of the selected Style, Style Element or Chord Variation.

Drum-Acc5 Single track of the selected Style, Style Element or Chord Variation.

PAGE 8 - EDIT: COPY

Here you can copy a track, Chord Variation or Style Element inside the same Style, or from a different one. Furthermore, you can copy a whole Style.

Warning: The Copy operation deletes all data at the target location (overwrite).

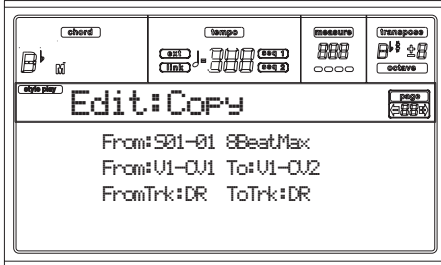

After setting the various parameters, press ENTER to execute. The "Are you sure?" message will appear. Press ENTER to confirm, EXIT to abort.

Note: If you copy too many events on the same "tick", the "Too many events!" message appears, and the copy operation is aborted.

Note: When you copy over an existing Chord Variation, Program Change data is not copied, to leave the original Programs unchanged for that Chord Variation.

When in this page, press the corresponding button on the control panel to select a Style Element (VARIATION1 ... ENDING2).

From Style

Use the first parameter to select the source Style to copy the track, Chord Variation or Style Element from.

From... to Style Element/Chord Variation

Use these parameters to select the source and target Style Elements or Chord Variations.

Note: You can't copy from a Variation to a different Style Element (or vice-versa), because of their different structure.

All All Style Elements, i.e. the whole Style. You can't change the target, that is automatically set to All.

Var1...End2 Single Style Element.

V1-CV1...E2-CV2
Single Chord Variation.

From... to Track

Use these parameters to select the source and target track to copy.

All All tracks of the selected Style, Style Element or Chord Variation.

Drum-Acc5 Single track of the selected Style, Style Element or Chord Variation.

Copying on a Chord Variation with a different length

You can copy a Chord Element on a different Chord Element with a different length. Just keep in mind the following:

- If the source length is a divider of the target length, the source Chord Variation will be multiplied to fit the target Chord Variation. For example, if the source is 4-measures long, and the target 8-measures, the source will be copied two times.

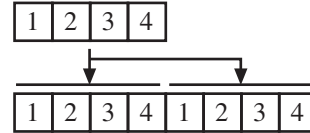

- If the source length is not a divider of the target length, the source Chord Variation will be copied for as many measures as can fit the target Chord Variation. For example, if the source is 6-measures long, and the target 8-measures, the source will be copied once, then the first 2 measures will be copied to fit the remaining 2 measures.

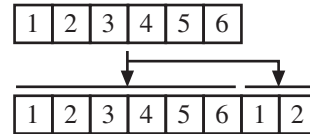

Note: Avoid copying on a Chord Variation with a different meter, for example a 4/4 Chord Variation onto a 3/4 one.

PAGE 9 - STYLE ELEMENT CONTROLS: PROGRAMS

In this page you can assign a different Program to each track of the selected Style Element. Each Style Element can have different Programs; after saving the new Style, please don't forget to set the "Prog" parameter to "Original" (see "Prog (Program)" on page 49), to let the Style select the Program bypassing the Style Performance settings.

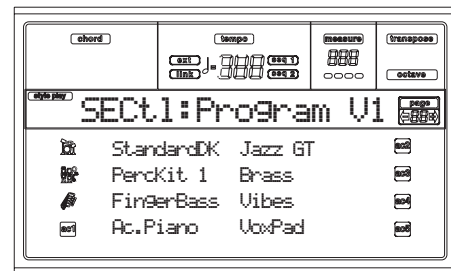

When in this page, press the corresponding button on the control panel to select a Style Element (VARIATION1 ... ENDING2).

To copy the settings of this page to another Style Element, keep the SHIFT button pressed, and press the button of the target Style Element.

Program

Use the PROGRAM/PERFORMANCE section to assign a Program to the selected track.

PAGE 10 - STYLE ELEMENT CONTROLS: EXPRESSION

In this page you can modify the Expression (CC#11) value for each of the Style tracks. This lets you reduce the relative level of a track in a single Style Element, without reducing the overall Volume of the Style.

This is a very useful control, when you have different Programs assigned to the same track in different Style Elements, and the internal level of these Programs is different.

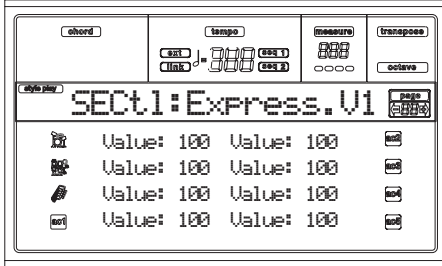

When in this page, press the corresponding button on the control panel to select a Style Element (VARIATION1 ... ENDING2).

To copy the settings of this page to another Style Element, keep the SHIFT button pressed, and press the button of the target Style Element.

Value

Use this parameter to set the Expression value for the corresponding track.

PAGE 11 - STYLE ELEMENT CONTROLS: KEYBOARD RANGE

The Keyboard Range automatically transposes any pattern note that would otherwise play too high or too low in pitch, compared to the original acoustic instrument, when transposed by the arranger. This will result in a more natural sound for each accompaniment instrument.

For example, the lower limit for a guitar is E2. If you play a chord under the E2, the transposed pattern could exceed this limit, and sound unnatural. A Bottom limit set to E2 for the guitar track will solve the problem.

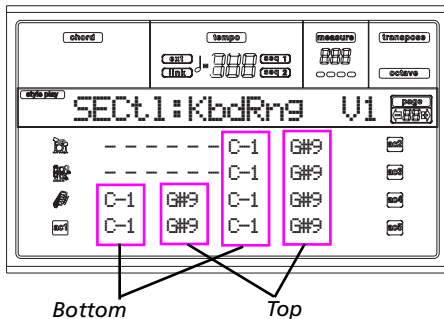

Note: The Keyboard Range is ignored while recording. The selected track can play on the full range of the keyboard.

When in this page, press the corresponding button on the control panel to select a Style Element (VARIATION1 ... ENDING2).

To copy the settings of this page to another Style Element, keep the SHIFT button pressed, and press the button of the target Style Element.

Bottom/Top

Use these parameters to set the bottom and top of the keyboard range for the corresponding track.

PAGE 12 - STYLE ELEMENT CONTROLS: CHORD VARIATION TABLE

This is the page where you can assign a Chord Variation to each recognized chord. When a chord is recognized, the assigned Chord Variation will be automatically selected by the arranger to play the accompaniment.

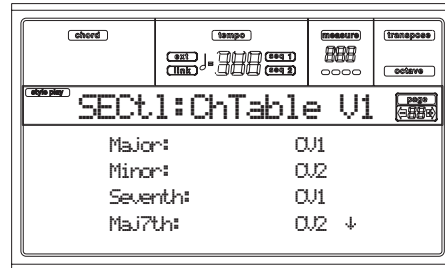

When in this page, press the corresponding button on the control panel to select a Style Element (VARIATION1 ... ENDING2).

E-F (Scroll Up), G-H (Scroll Down)

Use these buttons to scroll the available parameters in the display.

Chords / Chord Variation

Use these parameters to assign a Chord Variation to each of the enlisted chords.

PAGE 13 - STYLE CONTROLS: MODE/TENSION

In this page you can set the Retrigger mode for the Style tracks, and activate/deactivate the Tension for the Accompaniment tracks.

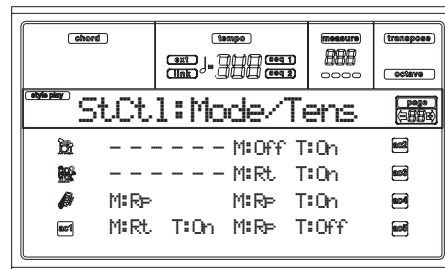

When in this page, press the corresponding button on the control panel to select a Style Element (VARIATION1 ... ENDING2).

M (Mode)

This setting harmonizes the notes of the Bass track or the Acc1-5 tracks to the new chord when the chord is changed.

Off Each time you play a new chord, the current notes will be stopped. The track will remain silent until a new note will be encountered in the pattern.

Rt (Retrigger) The sound will be stopped, and new notes matching the recognized chord will be played back.

Rp (Repitch) New notes matching the recognized chord will be played back, by repitching notes already playing. There will be no break in the

sound. This is very useful on Guitar and Bass tracks.

T (Tension)

Tension adds notes (a 9th, 11th and/or 13th) that have actually been played to the accompaniment, even if they haven't been written in the Style pattern. This parameter specifies

whether or not the Tension included in the recognized chord will be added to the Acc1-5 tracks.

On The Tension will be added.

Off No Tension will be added.

11. SONG PLAY OPERATING MODE

The Song Play operating mode is where you can listen to Songs (played directly from disk), and play along with the Song on the four Realtime (Keyboard) tracks (Upper 1-3, Lower). Since the Pa50 is equipped with two onboard sequencers, you can play two Songs at the same time. This is very useful to mix between two Songs during a live performance.

THE SONGS AND THE STANDARD MIDI FILE FORMAT

The native Song file format of the Pa50 is the Standard MIDI File (SMF), an universal standard set by all manufacturers. You can read these files with any musical instrument or computer.

A difference could be in the sound played by each track. If you recorded a Song with the Pa50 (Song mode), using only General MIDI programs, you can play the same Song on virtually any other musical instrument or computer. If you used KORG native programs, you cannot reproduce the same sounds on instruments from other brands.

When you read SMFs in Song Play mode, there is no problem reading files made using only General MIDI sounds. Sounds could be different when playing a Song made on a different instrument: despite the wide compatibility of Pa50 with other, non-standard formats, differences may arise.

If so, go to the Song operating mode and load the SMF. Then, manually reassign the non-matching Programs, replacing them with similar Programs on the Pa50. Then, save the SMF again, and you will be able to play it in Song Play mode with the correct Programs.

TRANSPORT CONTROLS

You can use the separate transport controls for each of the two onboard sequencers. Use the SEQ1 controls for Sequencer 1, and SEQ2 controls for Sequencer 2. See "SEQUENCER TRANSPORT CONTROLS - SEQ1 and SEQ2" on page 18 for more information).

MIDI CLOCK

In Song Play mode the MIDI Clock is always generated by the internal sequencer, even if the Clock parameter is set to External (see "Clock" on page 127). Pa50 transmits only the MIDI Clock message generated by Sequencer 1.

SWITCHING BETWEEN SEQUENCERS DURING EDITING

When you enter Edit mode, you can edit the selected sequencer's parameters. Go to the main page of Song Play mode, and select the S1 (A buttons) or S2 (B buttons) to select the sequencer you wish to edit (see "Main page" on page 72).

SELECTING A SONG COMPOSING ITS PROGRESSIVE NUMBER

Each Song on disk (up to 9,999) has a progressive number assigned. You can see this number before the Song's name in the Song Select page.

0001 MYSONG.MID

While in the Main, Song Select, or Lyrics page, the STYLE section doubles as a numeric keypad. You can use it for composing the 4-digit number corresponding to the Song you wish to select; the folder selected in the Song Select page will become the current folder. This way, you can speed up the Song retrieval.

Selecting a Song in the Song Select page

1. Open the Song Select page.
2. Select the disk and open the folder containing the Song to be selected. This folder will be used also in the Main and Lyrics page.
3. Compose the 4-digit number corresponding to the Song you wish to select (for example: if the Song is number "1043", dial 1, 0, 4, 3).

Song number:
000-

After the fourth digit has been inserted, the window automatically disappears, and the Song is selected.

- If the Song number is just 1, 2 or 3-digit long, dial the number, then press ENTER to confirm (for example: if the Song is number "52", dial 5, 2, ENTER).

Note: If no Song corresponds to the dialed number, the "Song not available" message appears. Press any button to make it disappear.

Selecting a Song in the Main page

While the S1 or S2 field is selected, compose the number corresponding to the Song you wish to select. The current folder is the one selected in the Song Select page.

Selecting a Song in the Lyrics page

Compose the number corresponding to the Song you wish to select. The current folder is the one selected in the Song Select page.

REALTIME AND SEQUENCER TRACKS

The Pa50 is equipped with a double sequencer. Each Song can play a maximum of 16 tracks, for a total of 32 sequencer tracks.

In addition, you can play on the keyboard with four additional Realtime tracks (Upper 1-3 and Lower). You can edit the Volume, Mute status, and Program selection for these tracks on the main page of the Song Play mode.

When you enter Song Play mode from the Style Play mode, the Realtime tracks are the same as the Style Play mode. A

quick way to select Programs and Effects for the Realtime tracks is choosing a different Performance.

MASTER VOLUME, SEQUENCER VOLUME, BALANCE

While the MASTER VOLUME slider controls the general volume of the instrument, you can use the ACC/SEQ VOLUME slider to control only the Sequencer's tracks volume. This lets you adjust the Sequencer's volume alone, while the Realtime (Keyboard) tracks are not affected by this slider.

Use the BALANCE slider to mix between Sequencer 1 and Sequencer 2. Move it to the center for the maximum volume of both sequencers.

EFFECTS IN SONG PLAY MODE

The Pa50 is equipped with four effect processors, or DSPs (Digital Signal Processors). In Song Play mode you can have two or four effects at the same time, depending on the midi-file you are reading.

Note: When playing back a Song that makes use of all four effects (A-D), you can't edit any parameter devoted to the effects. These parameters appear greyed out in the display.

- A Song created on the Pa50 (in Song or Backing Sequence mode) can use up to 4 effects (usually 2 reverbs + 2 modulating effects); each track may use the A/B or C/D pair.
- A Standard MIDI File will only use 2 effects (usually 1 reverb + 1 modulating effect). This lets you use the remaining 2 effects for the Realtime tracks.
- When using both sequencers at the same time, and the "S2 FX Mode" is set to "A/B Mode" (see page 80), they only use the A/B pair, while the C/D pair is reserved to the Realtime (keyboard tracks).
- When using both sequencers at the same time, and the "S2 FX Mode" is set to "C/D Mode" (see page 80), Sequencer 1 uses the A/B pair, while Sequencer 2 uses the C/D pair, sharing it with the Realtime (keyboard tracks).

GROOVE QUANTIZE WINDOW

You can apply a realtime "groove-quantization" to Sequencer 1. Groove-quantization is a way of changing the music groove during the playback, moving notes to the nearest axis of a rhythmic "grid". Please feel free to experiment: this function is a great source of musical invention.

While in Song Play, press G.QUANTIZE. The following window will appear.

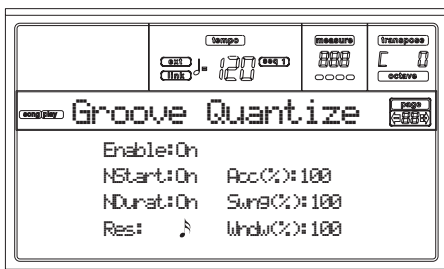

Press EXIT to exit this window.

Enable

Enables/disables the quantize. It is automatically set to Off each time the instrument is turned on, or when selecting a different Song.

NStart (Note Start)

Enables/disables the quantization of the Note On event (i.e. beginning of the note).

NDurat (Note Duration)

Enables/disables the quantization of the Note Off event (i.e. the length of the note).

Res (Resolution)

Coarse quantize grill resolution. This parameter is the main quantization value, to be varied with the Acc, Swing and Window values.

♪ (1/32)...♪ (1/4)

Grid resolution, in musical values (a "3" after the value means "triplet"). For example, when you select 1/8, all notes are moved to the nearest 1/8 division. When you select 1/4, all notes are moved to the nearest 1/4 division.

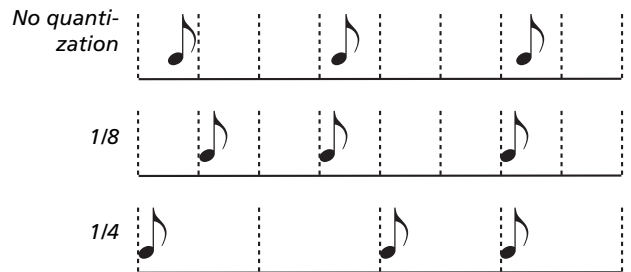

Acc (Accuracy)

Accuracy percentage of quantize. For example, if Acc=50, and the note is 20 tics away from the coarse grid, it is moved to the grid of only 10 tics.

- 0 No accuracy. The quantize is not executed.
- 100 Maximum accuracy. The note is moved exactly at the grid position.

Swing

Asymmetry of quantization. Grid axis are moved to the nearest grid axis.

- 0 Even-numbered axis are totally moved over the previous odd-numbered axis.
- 50 Axis are perfectly equidistant.
- 100 Even-numbered axis are totally moved over the following odd-numbered axis.

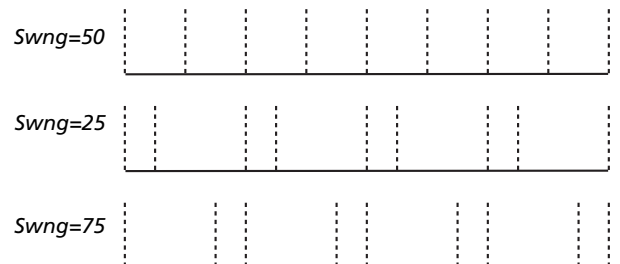

Window

Area of quantize intervention, bordering the grid axis.

- 0 The quantize window corresponds to the axis. No quantization happens.

100 The quantize window extends to the nearest window; all events are quantized.

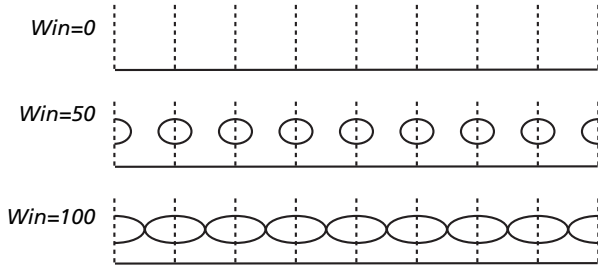

THE WRITE WINDOW

You can save onto the internal memory a Seq1+Seq2 Setup. There is a separate Setup for each of the two onboard sequencers.

This Setup memorizes the Internal FX settings, the Internal/External status of each track, and the Play/Mute status of each track. When a new Song is selected, the saved Setup is automatically recalled, and all parameters are reset.

- Globally setting the Internal FX parameters allows you, for example, to assign to all Songs a Reverb suitable for the venue where you are performing, without having to modify any of the Songs. (This is true only for non-Pa50/80 Songs).
- Globally setting the Internal/External status allows you, for example, to send the Piano track of all Songs to a dedicated expander (just set globally the Piano track to the External mode).
- The Play/Mute status allows you to globally mute tracks that you don't want to play during a show, for example the melody track. (This is true only for non-Pa50/80 Songs).

For more information on the Internal FX settings for the Song Play mode, see "Page 3 - Mixer: FX send A/B" or "Page 3 - Mixer: FX send C/D", and following, on page 76.

Here is the procedure to save the Seq1+Seq2 Setup in memory.

1. Press WRITE. The Write page appears.

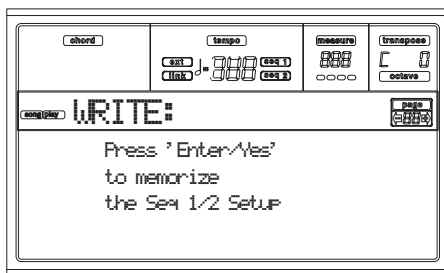

2. Press ENTER to confirm, or EXIT to abort. If you confirm, the Setup is saved into the Global. You may then save this Setup on disk together with the Global data.

MAIN PAGE

Press SONG PLAY to access this page from another operating mode.

Note: When switching from Style Play to Song Play, the Song Setup is automatically selected, and various track parameters may change.

Press EXIT/NO to access this page from the Menu or any of the Song Play edit pages.

To see the Song's tracks, use the TRACK SELECT button to switch from the main page (showing the Realtime tracks), to the other tracks. Pressed a first time, you will see tracks 1-8 (enlightened TRACK SELECT LED); a second press will show tracks 9-16 (flashing TRACK SELECT LED); pressed again, you will go back to the Realtime tracks (TRACK SELECT LED switched off).

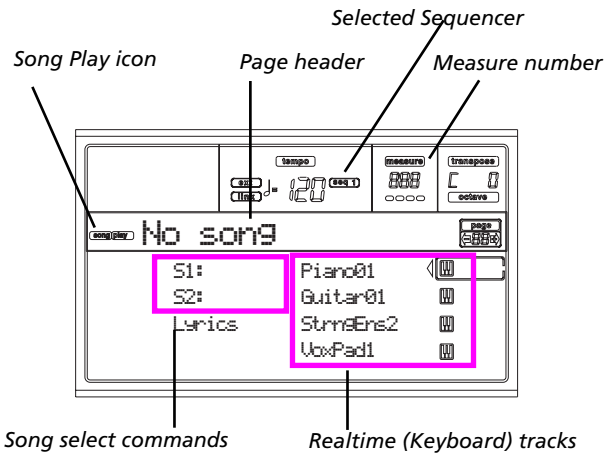

Song Play icon

When on, this icon shows that the instrument is in Song Play mode.

Page header

This line shows the currently selected sequencer, and the assigned Song ("S1:Song Name" or "S2:Song Name").

When no Song is assigned to the current sequencer, this line shows only the selected sequencer number ("S1:" or "S2:", depending on the selected sequencer).

When no sequencer or Song is selected, only the "No Song" text appears.

Press either A (S1:) or B (S2:) to switch between Sequencer 1 and Sequencer 2. When one of the sequencers is selected, the sequencer number is also shown at the right of the metronome Tempo.

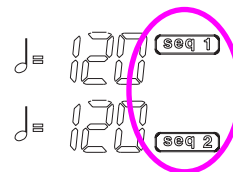

When a Jukebox file is in play, its name appears on the page header.

Selected Sequencer

These indicators show if the currently selected sequencer is Seq1 or Seq2. Use the A and B VOLUME/VALUE buttons to select a sequencer.

Bar number

This counter shows the current bar number position of the selected Song.

A (S1:SongName)

Pressed a first time (with a Song already selected) this button pair selects Sequencer 1. Pressed a second time (or with no Song selected), it opens the Song Selection page (see “Song Select page” on page 73), allowing for selection of a single Song or a Jukebox file for Sequencer 1.

If you select another Song, while a Song is in play within the same Sequencer, the new Song will start playing.

While this parameter is selected, you can select a Song by composing its progressive number (see “Selecting a Song composing its progressive number” on page 70).

B (S2:SongName)

Pressed a first time (with a Song already selected) this button pair selects Sequencer 2. Pressed a second time (or with no Song selected), it opens the Song Selection page (see “Song Select page” on page 73), allowing for selection of a single Song for Sequencer 2.

If you select another Song, while a Song is in play within the same Sequencer, the new Song will start playing.

While this parameter is selected, you can select a Song by composing its progressive number (see “Selecting a Song composing its progressive number” on page 70).

C (Lyrics)

Open the Lyrics page (see “The Lyrics page” on page 74). Lyrics will be shown only if included into the selected Song, and compatible with a standard format that Pa50 can recognize.

E (Upper 1 Program), F (Upper 2 Program), G (Upper 3 Program), H (Lower)

Name of the Programs assigned to the Realtime (Keyboard) tracks. Use these buttons to select, mute/unmute or change the volume of the corresponding tracks.

TRACKS 1-8 PAGE

To see and edit tracks 1-8, press TRACK SELECT from the main page. The TRACK SELECT LED turns on.

Press the TRACK SELECT button twice, to go back to the main page.

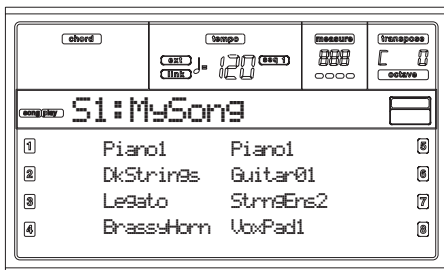

A-H (Tracks 1-8 Programs)

Name of the Programs assigned to tracks 1-8. Use these buttons to select, mute/unmute or change the volume of the corresponding tracks.

TRACKS 9-16 PAGE

To see and edit tracks 9-16, press TRACK SELECT once from the Tracks 1-8 page, or twice from the main page. The TRACK SELECT LED begins flashing.

Press the TRACK SELECT button again, to go back to the main page.



A-H (Tracks 9-16 Programs)

Name of the Programs assigned to tracks 9-16. Use these buttons to select, mute/unmute or change the volume of the corresponding tracks.

SONG SELECT PAGE

This page appears when you press either the A (S1:) or B (S2:) button while you are in the main page. You can also access the Song Select page by pressing PAGE +.

Press EXIT (or PAGE-) to go back to the main page of the Song Play operating mode, without selecting a Song.

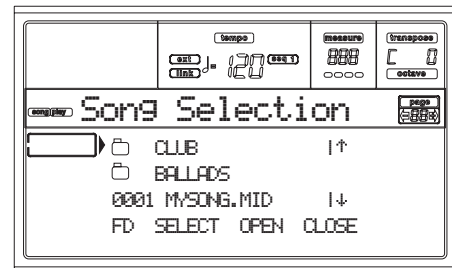

While in this page, select a Song for the selected Sequencer, or a Jukebox file for Sequencer 1.

Note: There is a separate working directory for each onboard sequencer.

A-C (File, folder)

Move the “.MID”, “.KAR” or “.JBX” file, or folder, to be selected to the first line of the display. To select a file, press the F2 (Select) button. To open a folder, press the F3 (Open) button.

The “” symbol identifies a folder.

E-F (Scroll Up)

Scroll the list up. Keep SHIFT pressed and press one of these buttons to jump to the previous alphabetical section.

G-H (Scroll Down)

Scroll the list down. Keep SHIFT pressed and press one of these buttons to jump to the next alphabetical section.

F1 (FD)

Press this button after replacing a floppy disk in the floppy disk drive. The new floppy disk will be read, and the file list shown on the display will be updated.

F2 (Select)

Selects the item on the first line in the display (Song or Jukebox file). If a Song is already playing, it stops, and the new Song starts playing. You are returned to the Main page.

F3 (Open)

Opens the selected folder (item whose name begins with “”).

F4 (Close)

Closes the current folder, returning to the parent (“upper”) folder.

THE LYRICS PAGE

This page shows the lyrics and chord abbreviations included in the midfile (if any).

To access this page, select the Lyrics command, or press PAGE+ twice, from the main page of the Song Play mode (see “Main page” on page 72).

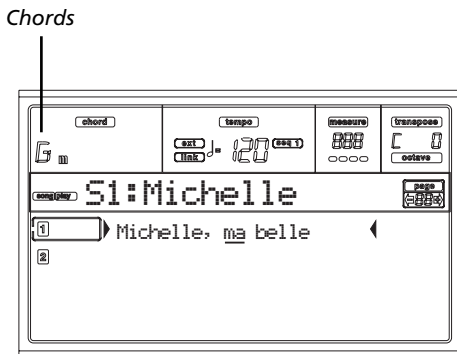

Exit from this display, and go back to the main page of the Song Play mode, by pressing the EXIT button.

While the Song is playing, the text flows in the display, and the chord abbreviations (if any) will appear on the chords area of the display. The lyrics at the current position are underlined:

Michelle, ma belle

A (1)

Press this button pair to show Lyrics and Chords of Sequencer 1.

B (2)

Press this button pair to show Lyrics and Chords of Sequencer 2.

Lyrics display on an external monitor

As soon as you enter the Song Play mode, lyrics included in the Song assigned to the Sequencer 1 are shown in the display. To select a different sequencer, go to the Lyrics page, and press one of the A VOLUME/VALUE buttons to select Sequencer 1, or one of the B VOLUME/VALUE buttons to select Sequencer 2.

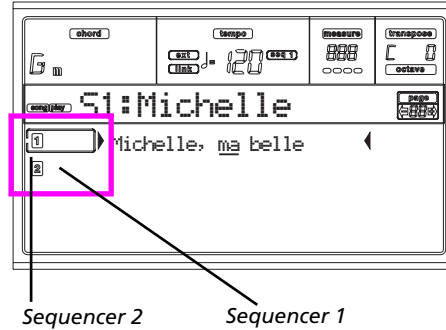

Note: You can have Sequencer 2 selected in the Main page of the Song Play mode, and Sequencer 1 selected in the Lyrics page, or vice-versa. In this way, you can select a Song whose lyrics to display on the external monitor, while selecting a different sequencer for editing operations.

PLAYING A JUKEBOX FILE

With Sequencer 1, you can select a Jukebox file (a file with the “.JBX” extension) instead of a single Song. This lets you play a list of Songs without multiple selections.

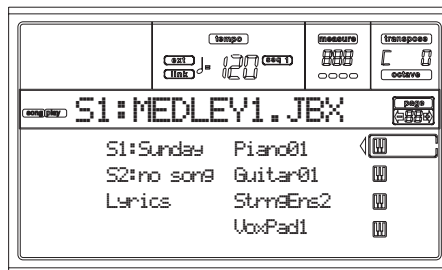

Note: The Jukebox file can be assigned to the Sequencer 1 only.

Note: To create a Jukebox file, go to the Jukebox page (see page 79).

Warning: Should you delete a Song included into the Jukebox list currently in play, the sequencer will stop, and the “No Song” message will appear. At this point, press SHIFT+>> (Seq1) to go to the next Song, and press PLAY/STOP again.

Transport controls

When you select a Jukebox file, Sequencer 1 transport controls are slightly different than with single Songs.

<< and >> Pressed alone, these buttons are the Rewind and Fast Forward commands.

(SHIFT) Keep the SHIFT button pressed, and press these buttons to scroll to the previous or next Song in the Jukebox list.

PAUSE

Pauses the Song at the current position. Press PAUSE or PLAY/STOP to start the Song playing again.

PLAY/STOP Starts or stops the current Song. When you stop the Song, the sequencer goes back to measure 1 of the current Song.

If the Jukebox page is open, you can start from the Song at the first line of the display. See “Page 9 - Jukebox” on page 79.

MENU

From any page, press MENU to open the Song Play edit menu. This menu gives access to the various Song Play edit sections.

When in the menu, select a section using the VOLUME/VALUE buttons, press PAGE+ to select a page, or press EXIT to exit the menu.

When in an edit page, press EXIT to go back to the Song Play mode main page.



Each item of this menu corresponds to an edit section. Each edit section groups many edit pages.

EDIT PAGE STRUCTURE

Select an edit section from the Menu, and/or use the PAGE buttons to reach the desired page.

Press EXIT to go back to the main page of the Song Play mode.

All edit pages share the same structure.

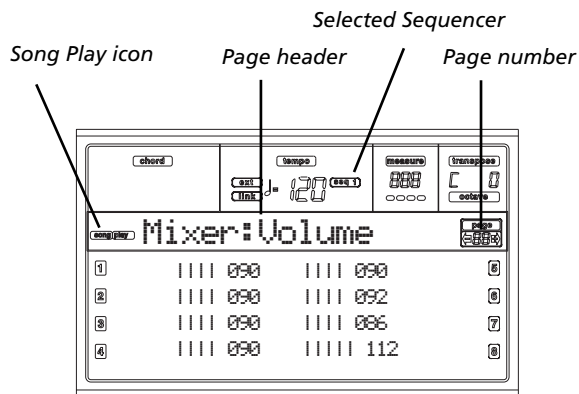

Song Play icon

When on, this icon indicates that the instrument is in Song Play mode.

Page header

The header shows the name of the current edit page. Usually, the header is divided into a first word, identifying the section name (e.g., “Mixer:FX Send” is a “Mixer” section page), and a second word, referring to the page name (e.g. “FX Send”).

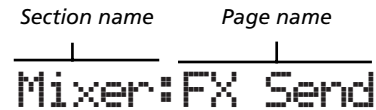

Selected Sequencer

These indicators show if the currently selected sequencer is Seq1 or Seq2. Go to the Main page and use the A and B VOLUME/VALUE buttons to select a sequencer.

Page

This area shows the current page number.

A-H

Each pair of VOLUME/VALUE buttons select a different parameter of command, depending on the edit page.

PAGE 1 - MIXER: VOLUME

Here you can adjust the volume for each of the 16 sequencer tracks. Press both VOLUME/VALUE button to mute/unmute the corresponding track.

A muted track remains muted even when selecting a different Song.

Use the TRACK SELECT button to switch between Song tracks 1-8, Song tracks 9-16, and back again.

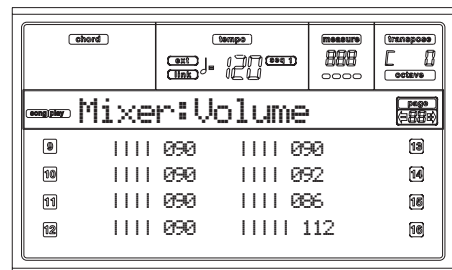
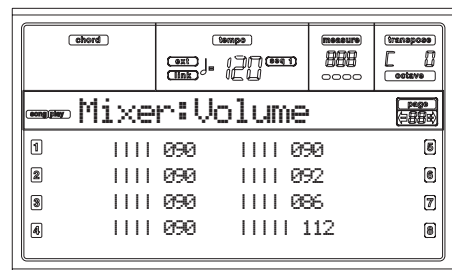

PAGE 2 - MIXER: PAN

Here you can adjust the pan for each Song track. Use the TRACK SELECT button to switch between Song tracks 1-8, Song tracks 9-16, and back again.

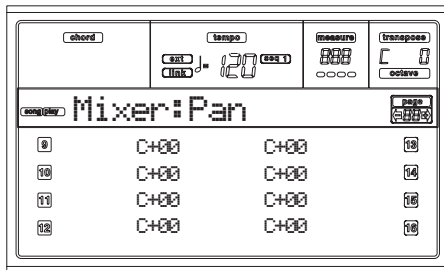
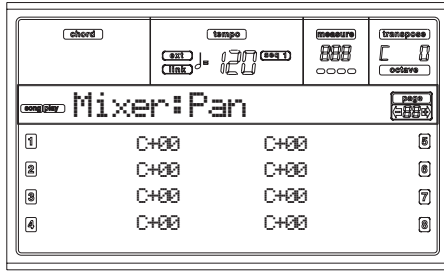

Pan	
-64	Hard Left.
+00	Center.
+63	Hard Right.
Off	The direct (unaffected) signal does not go to the outputs; only the FX signal is heard for this track.

PAGE 3 - MIXER: FX SEND A/B

This page lets you set the level of the track's direct (unaffected) signal going to the A and B Internal FX processors (usually assigned to Sequencer 1). Use the TRACK SELECT button to switch from tracks 1-8 to tracks 9-16.

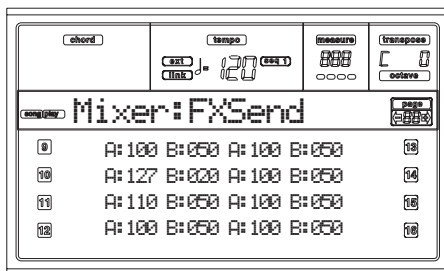
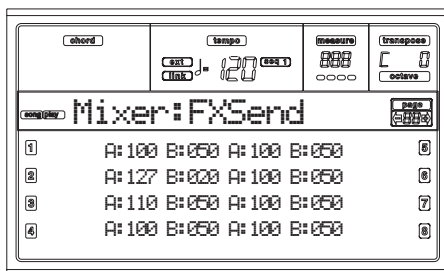

Note: When playing back a Song that makes use of all four effects (A-D), you can't edit any effect parameter. These parameters appear greyed out in the display.

Note: When you stop the Song, or select a different Song, the default effects are selected again. You can, however, stop the Song, change the effects, then start the Song again. Edit the Song in Song mode to permanently change the effects.

Here is the edit procedure:

1. Use the VOLUME/VALUE (A-H) buttons to select a track.
2. Use the F1-F4 buttons to select a parameter for that track.
3. Use the TEMPO/VALUE controls to change the parameter's value.

Parameters

000	No effect. Only the direct (unaffected) signal goes to the outputs.
127	100% effect. The direct (unaffected) and effected signals go to the outputs with the same level.

PAGE 3 - MIXER: FX SEND C/D

This page lets you set the level of the track's direct (unaffected) signal going to the C and D Internal FX processors.

Note: You can access this page only while editing the Sequencer 2, and the "S2 FX Mode" parameter is set to "CD Mode" (see page 80).

Use the TRACK SELECT button to switch from tracks 1-8 to tracks 9-16.

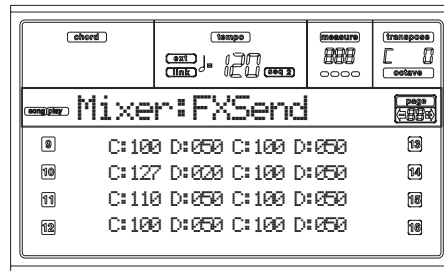
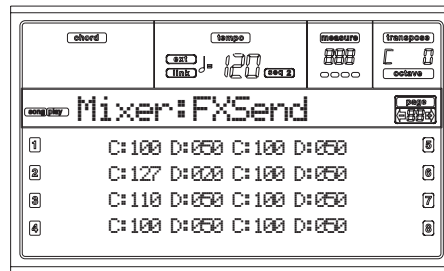

Here is the edit procedure:

1. Use the VOLUME/VALUE (A-H) buttons to select a track.
2. Use the F1-F4 buttons to select a parameter for that track.
3. Use the TEMPO/VALUE controls to change the parameter's value.

Parameters

000	No effect. Only the direct (unaffected) signal goes to the outputs.
127	100% effect. The direct (unaffected) and effected signals go to the outputs with the same level.

PAGE 4 - FX: A/B SELECT

This page lets you select the A and B effects. Usually, the A effect is a reverb, while the B effect is a modulating effect.

Effects A and B are usually reserved to Sequencer 1. You can, however, create Songs by using all four effects in Song mode. Depending on the status of the “S2 FX Mode” parameter, this effect pair could be reserved to Sequencer 2, too (see page 80).

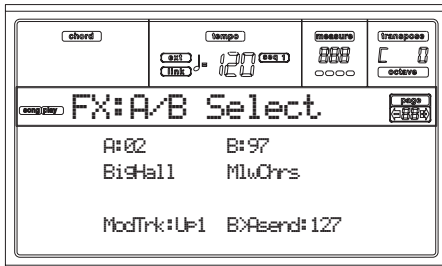

Note: When playing back a Song that makes use of all four effects (A-D), you can't edit any effect parameter. These parameters appear greyed out in the display.

Note: When you stop the Song, or select a different Song, the default effects are selected again. You can, however, stop the Song, change the effects, then start the Song again. Edit the Song in Song mode to permanently change the effects.

A, B

Effects assigned to the A and B effect processors. Usually, A is the reverb, while B is the modulating effect (chorus, flanger, delay...). For a list of the available effects, see “Effects” on page 175.

ModTrk (Modulating Track)

Source track for modulating MIDI messages. You can modulate an effect parameter with a MIDI message generated by a physical controller.

B>Asend (B>A Send)

Amount of the B effect going back to the input of the A effect.

PAGE 4 - FX: C/D SELECT

This page lets you select the C and D effects. Usually, the C effect is a reverb, while the D effect is a modulating effect.

Effects C and D are usually reserved to Sequencer 2 and the Realtime tracks. You can, however, create Songs using all four effects in Song mode. Depending on the status of the “S2 FX Mode” parameter, Sequencer 2 might also use the A/B effect pair (see page 80).

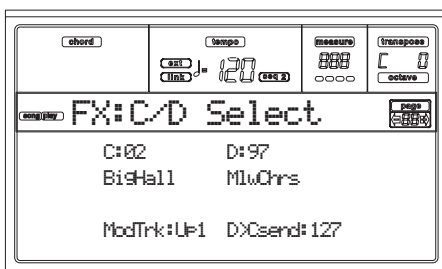

Note: When playing back a Song that makes use of all four effects (A-D), you can't edit any effect parameter. These parameters appear greyed out in the display.

Note: When you stop the Song, or select a different Song, the default effects are selected again. You can, however, stop the

Song, change the effects, then start the Song again. Edit the Song in Song mode to permanently change the effects.

C, D

Effects assigned to the C and D effect processors. Usually, C is the reverb, while D is the modulating effect (chorus, flanger, delay...). For a list of the available effects, see “Effects” on page 175.

ModTrk (Modulating Track)

Source track for modulating MIDI messages. You can modulate an effect parameter with a MIDI message generated by a physical controller.

D>Csend (D>C Send)

Amount of the D effect going back to the input of the C effect.

PAGE 5 - FX: A EDITING

This page contains the editing parameters for the A effect (usually, reverb for Sequencer 1).

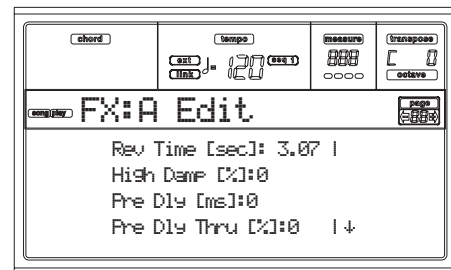

Use the E-F and G-H VOLUME/VALUE button pairs to scroll the parameter list.

Use the A-D VOLUME/VALUE button pairs to select and edit a parameter.

Use the TEMPO/VALUE controls to edit the selected parameter.

Note: When playing back a Song that makes use of all four effects (A-D), you can't edit any effect parameter. These parameters appear greyed out in the display.

Note: When you stop the Song, or select a different Song, the default effects are selected again. You can, however, stop the Song, change the effects, then start the Song again. Edit the Song in Song mode to permanently change the effects.

Parameters

See “Effects” on page 175 for a list of available parameters for each effect type.

PAGE 6 - FX: B EDITING

This page contains the editing parameters for the B effect (usually modulating effect for Sequencer 1). For more details, see “Page 5 - FX: A editing” above.

PAGE 5 - FX: C EDITING

This page contains the editing parameters for the C effect. You can access this page only when the “S2 FX Mode” parameter is set to C/D (see “S2 FX Mode” on page 80). For more details, see “Page 5 - FX: A editing” above.

Note: C and D effects are used also by the Realtime (Keyboard) tracks.

PAGE 6 - FX: D EDITING

This page contains the editing parameters for the D effect. You can access this page only when the “S2 FX Mode” parameter is set to C/D (see “S2 FX Mode” on page 80). For more details, see “Page 5 - FX: A editing” above.

Note: C and D effects are used also by the Realtime (Keyboard) tracks.

PAGE 7 - TRACK: MODE

This page lets you set the polyphony mode for each Song track.

Use the TRACK SELECT button to switch from tracks 1-8 to tracks 9-16.

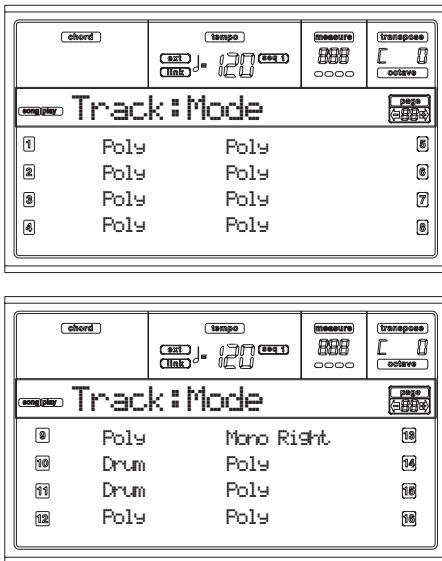

Parameters

- Drum** This is a Drum/Percussion track. No Master or Octave Transpose applies to this track.
- Poly** Tracks of this kind are polyphonic, i.e. they can play more than one note at the same time.
- Mono** Tracks of this kind are monophonic, i.e. each new note stops the previous note.
- Mono Right** A Mono track, but with priority assigned to the rightmost (highest) note.

PAGE 8 - TRACK: INTERNAL/EXTERNAL

This page lets you set the Internal or External status for each track. It is very useful to let a Song track drive an external expander.

Use the TRACK SELECT button to switch from tracks 1-8 to tracks 9-16.

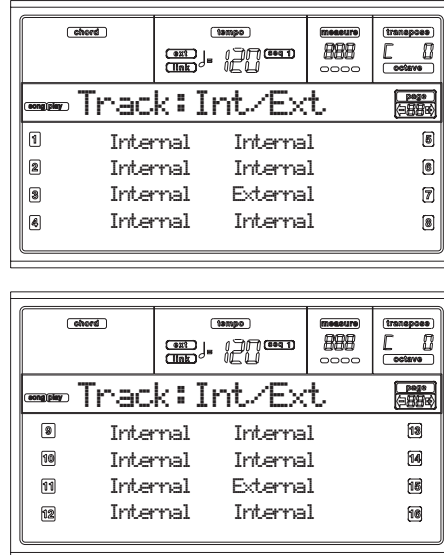

Parameters

- Internal** The track plays the sounds generated by the internal sound engine. It does not play an external instrument connected to the MIDI OUT.
 - External** The track plays an external instrument connected to the MIDI OUT. It does not play the internal sounds, therefore saving polyphony. When a track is set to “External”, a strings of transmitted Control Change and Program Change data is shown instead of the Program name assigned to the track. In the following example, CC#0 is the Control Change 0 (Bank Select MSB), CC#32 is the Control Change 32 (Bank Select LSB), PC is the Program Change.
- 121- 3- 0
 | | |
 CC#0 CC#32 PC
- Both** The track plays both the internal sounds and an external instrument connected to the MIDI OUT.

PAGE 9 - JUKEBOX

The Jukebox function lets you play a list of Songs (127 max), at the simple touch of a button. You can play a Jukebox file by selecting it in the Song Select page (see “Playing a Jukebox file” on page 74), just as if it was a normal Song.

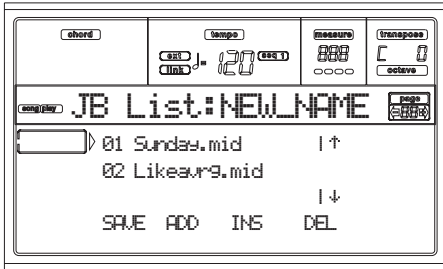

In this page, you can create, edit and save a Jukebox file. If a Jukebox file is already selected into a Sequencer, you will enter this page with that file ready to be edited. Otherwise, you will enter this page with an empty “NEW_NAME.JBX” file.

To create a new file, even when a Jukebox file is already selected, press SHIFT+ F4 (Del), and confirm with ENTER (see below the “F4 (Del)” paragraph).

When you press PLAY/STOP from this page, the Jukebox playback begins from the currently selected Song (i.e., the Song on the first line of the display).

F1 (Save)

Press this button to save the Jukebox file on disk. The Jukebox Save page appears, allowing you to save your file on disk.

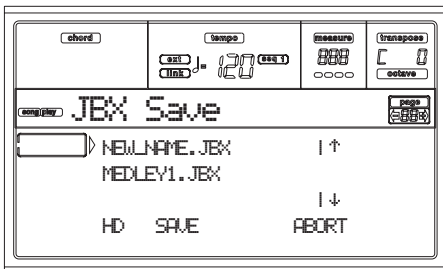

Note: You can save your “JBX” file only in the same folder as the Songs in the list.

You can create a new file, or overwrite an existing one.

1. Move to the first line of the display the “JBX” file you want to save your list into. Select an existing file if you want to **overwrite** it. Select the “NEW_NAME.JBX” item to **create** a new file.

Use the E-F (Scroll Up) and G-H (Scroll Down) VOLUME/VALUE buttons, or the TEMPO/VALUE controls to scroll the list.

2. If you are making a new file, when the “NEW_NAME.JBX” item is on the first line of the display, press one of the A VOLUME/VALUE buttons. You are prompted to assign a name to the selected item:

NEW_NAME

3. Move the cursor using the DOWN/- and UP/+ buttons. Select a character using the DIAL. Insert a character at the cursor position by pressing the INSERT button. Delete a character at the cursor position by pressing the DELETE button.

4. When you have finished writing a name, press F2 (Save) to confirm. The “Are you sure?” message appears. Press ENTER to confirm, EXIT to abort.

F2 (Add)

Adds a Song at the end of the current list. You can add up to 127 Songs in a list.

Note: A Jukebox list can include only Songs contained in the same folder.

F3 (Ins)

Inserts a Song at the cursor position (i.e., the first line of the display). All subsequent Songs are moved to the next higher-numbered slot. You can add up to 127 Songs in a list.

Note: A Jukebox list can include only Songs contained in the same folder.

F4 (Del)

This command let’s you delete the Song on the first line of the display.

(SHIFT) Pressed while keeping SHIFT pressed, the whole Jukebox list is deleted. (The instrument asks for a confirmation with the “Are you sure?” message; press ENTER to confirm, EXIT to abort).

The Jukebox file name changes to “NEW_NAME.JBX”.

PAGE 10 - PREFERENCES

In this page, you can set various general parameters.

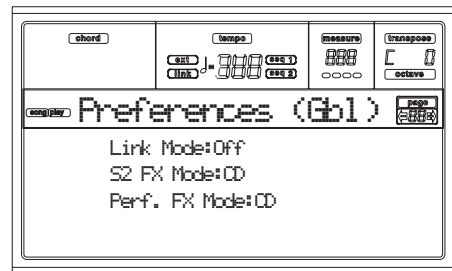

Use the A-D VOLUME/VALUE button pairs to select a parameter.

Note: These settings are stored in the Global file. After changing these settings, press WRITE to save them into the Global. The Write Global window will appear (see “The Write window” on page 72).

Note: You can always start both sequencers simultaneously. Start both sequencers simultaneously by keeping SHIFT held down while pressing one of the PLAY/STOP controls.

Link Mode

►GBL

The two onboard Sequencers can work each with a different Tempo (Off), or use the same Tempo (Link modes).

Off The sequencers Tempo are not linked. Each sequencer uses its own Tempo.

Link Measure

The two sequencers Tempo are linked together. The Tempo data written into the Songs are ignored. Adjust the Tempo using the TEMPO/VALUE controls.

Start one of the sequencers, by pressing its own PLAY/STOP control. Then, start the other sequencer, by pressing the other PLAY/STOP control; the second sequencer starts at the next measure.

Link Beat The two sequencers Tempo are linked together. The Tempo data written into the Songs are ignored. Adjust the Tempo using the TEMPO/VALUE controls.
Start one of the sequencers, by pressing its own PLAY/STOP control. Then, start the other sequencer, by pressing the other PLAY/STOP control; the second sequencer starts at the next beat (quarter or octave, depending on the Song's Time Signature).

S2 FX Mode ▶ GBL

This parameter selects the effects mode for Sequencer 2. When a 4-effects Song is loaded, all four effects are used, independently from this setting.

AB The A and B effect pair is used. Sequencer 2 shares its effects with Sequencer 1.

CD The C and D effect pair is used.
Note: When this parameter is set to CD, Sequencer 2 shares its effects with the Realtime (Keyboard) tracks, so these effects can be changed either selecting a Song for Sequencer 2, or selecting a Performance (unless the "Performance FX Mode" parameter is set to Off – see below).

Performance FX Mode ▶ GBL

This parameter selects the effects mode for the Performance.

Off When selecting a Performance, no effect is selected.

CD The Performance selects the C and D effect pair.
Note: When both this parameter and the "S2 FX Mode" parameter are set to CD, Sequencer 2 shares its effects with the Realtime (Keyboard) tracks, so these effects can be changed either selecting a Song for Sequencer 2, or selecting a Performance.

SAVING A LIST OF SONGS

How to save a list of Songs contained in a folder

1. Press SONG PLAY to select the Song Play operative mode.
2. Press one of the A (S1:) VOLUME/VALUE button to select the Load Song page.
3. Use the F3 (Open) and F4 (Close) buttons to browse through the folders inside the floppy disk.
4. Move the folder you are looking for to the first line of the display. Use the TEMPO/VALUE controls, or the E-F (Scroll Up) and G-H (Scroll Down) VOLUME/VALUE buttons.
5. Once the folder is selected, press SHIFT + F2.
6. A dialog box will appear, asking you to insert a new floppy disk into the disk drive. Insert the disk, and press ENTER to confirm, or EXIT to abort.

Note: The text file will contain a list of "*.mid", "*.kar" and "*.jbx" files only (i.e., the files you can select using the numeric keypad – see "Selecting a Song composing its progressive number" on page 70). Folders and different kinds of files will not be included.

When saved, the text file will be named after the selected folder. For example, a folder named "Dummy" will generate a "Dummy.txt" file. If a file with the same name already exists on the floppy disk, it will be overwritten without waiting for any confirmation. A file containing the list of all valid files contained into the root of the disk will generate a "Root.txt" file.

The list will include the progressive number assigned to each Song, file names in MS-DOS format (8.3), the total number of files in the list.

For the correct display and printing of the list on a personal computer, use a fixed size (i.e., non-proportional) character in your text editor.

Warning: While the list may contain more than 9999 files, you can't select Songs outside the 0001-9999 range when using the numeric keypad.

How to save a list of Songs contained in a Jukebox file

1. Press SONG PLAY to select the Song Play operative mode.
2. To select an existing Jukebox file, press one of the A (S1:) VOLUME/VALUE buttons to select the Load Song page. If you are creating a new Jukebox file, press MENU instead, select the Jukebox page, and jump to step 7.
3. Use the F3 (Open) and F4 (Close) buttons to browse through the folders inside the floppy disk.
4. Move the folders and files to select to the first line of the display. Use the TEMPO/VALUE controls, or the E-F (Scroll Up) and G-H (Scroll Down) VOLUME/VALUE buttons.
5. When the Jukebox file you are looking for is selected, press F2 (Select) to select it.
6. Once the Jukebox file is selected, press MENU and select the Jukebox page.
7. While you are in the Jukebox page, press SHIFT + F2 to save the list.
8. A dialog box will appear, asking you to insert a new floppy disk into the disk drive. Insert the disk, and press ENTER to confirm, or EXIT to abort.

Note: When saved, the text file will be named after the selected Jukebox file. For example, a Jukebox file named "Dummy.jbx" will generate a "Dummy.txt" file. A new, unnamed Jukebox file will generate a "New_name.txt" file. If a file with the same name already exists on the floppy disk, it will be overwritten without waiting for any confirmation.

The list will include the progressive number assigned to each Song, file names in MS-DOS format (8.3), the total number of files in the list.

For the correct display and printing of the list on a personal computer, use a fixed size (i.e., non-proportional) character in your text editor.

12. BACKING SEQUENCE OPERATING MODE

The Backing Sequence mode lets you record a live performance with the Styles. The front panel controls work mostly as in Style Play mode, but here you are recording what you are playing. After recording, the result is a new Song made of the Realtime tracks and the Style tracks.

TRANSPORT CONTROLS

When in Backing Sequence mode, use SEQ1 transport controls (PLAY/STOP, PAUSE...). See “SEQUENCER TRANSPORT CONTROLS - SEQ1 and SEQ2” on page 18 for more information).

THE BACKING SEQUENCE, SONG AND SONG PLAY MODES

The Backing Sequence and Song modes are linked together: go to Backing Sequence mode to record a Song, and switch to Song mode to edit it.

Since they use the same sequencer and memory area, recording a new Song in Backing Sequence mode deletes the Song loaded in Song mode.

Note: The Song is kept in RAM, so save it before turning the instrument off, or it will be lost.

Warning: When switching to Song Play, the Song is deleted, since Backing Sequence, Song and Song Play share the same sequencer (Sequencer 1). The “Erase Song?” message appears. Press ENTER to confirm, EXIT to stay in Backing Sequence mode, and avoid deleting the Song.

HOW TO PLAYBACK A SONG

You can load a Standard MIDI File, and play it back while in Backing Sequence mode.

Note: When in the Main page (Backing Sequence Play) the keyboard doesn't play.

1. Enter the Backing Sequence mode. The Backing Sequence Playback page appears (see page 83).

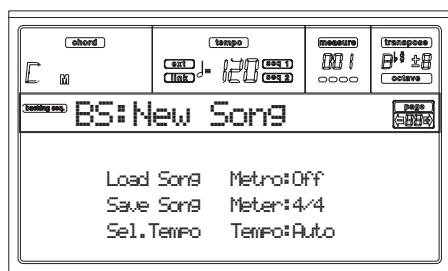

2. Press one of the B (Load Song) VOLUME/VALUE buttons to load a Song (see “Load Song page” on page 84). You can load any Standard Midi File (files with the “.MID” or “.KAR” extension).
3. Press PLAY/STOP to start the playback.
4. Press PLAY/STOP again to stop the playback. The playback is automatically stopped at the end of the Song.

REALTIME RECORDING MODE

While in Backing Sequence mode, you can record a new Song in realtime mode (i.e., recording exactly what you play). Realtime (Keyboard) tracks will be Song tracks 1-4, Pads will be Song tracks 5-8, while Style tracks will be Song tracks 9-16.

1. Enter the Backing Sequence mode.
2. Press RECORD. You will be prompted to select the Realtime Recording mode, or the Chord/Acc Step Mode.



3. Press one of the A VOLUME/VALUE buttons to select the Realtime Recording mode. The Realtime Recording page appears (see “Realtime Recording page” on page 85).

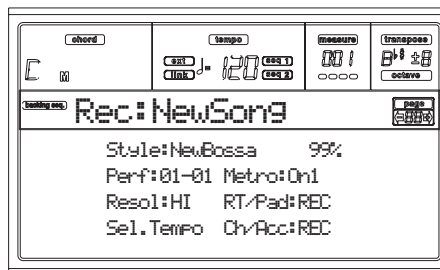

4. The last selected Style is currently selected. Should it not be the right one, select a different Style to start recording with. (See “Selecting a Style” on page 26).
5. The last selected Performance or STS is currently selected. If you prefer, select a different Performance or STS. (See “Selecting a Performance” on page 25, and “Selecting a Single Touch Setting (STS)” on page 27).
6. Select the status of the Backing Sequence tracks, using the G (RT) and H (Ch/Acc) button pairs. (RT stays for Realtime/Keyboard; Ch/Acc stays for Chord/Accompaniment, i.e. the Style tracks). To record all you play on the keyboard, plus the automatic accompaniment, leave their status to REC (see “Realtime Recording page” on page 85).

Warning: Tracks set to REC are automatically deleted when starting recording. Set a track to the PLAY status, when you don't want to delete it. For example, if you are recording a Realtime (Keyboard) part on and existing Style track, set the Ch/Acc parameter to PLAY, and the RT track to REC.

7. Start recording by pressing the left PLAY/STOP button (or the START/STOP button). After a count-in (see “Metro (Metronome)” on page 85), you can start recording.

Play a solo intro, or start the auto-accompaniment with the START/STOP button. To start with the Style playing

right from bar 1, keep the chord pressed during the pre-count, and press START/STOP before the end of the precount. Otherwise, the Style will start playing from the next bar, following the one where you pressed START/STOP.

Since you can use any Style control, you could start with the usual combinations (INTRO, ENDING, FILL... see "2 - Playing a Style" on page 29 for more information).

Note: While in Backing Sequence mode, you can't record the SYNCHRO, FADE IN/OUT, TAP TEMPO/RESET, ACCOMPANIMENT VOLUME controls.

8. Play your music. You can even stop the Style by pressing START/STOP. If you stop the Style while recording, start it again with the START/STOP button.
9. When finished recording your performance, press the left PLAY/STOP button. The RECORD LED will turn off, and you will go back to the Playback page (see "How to playback a Song" before).

The recorded Song will be automatically converted to the Standard MIDI File format.

10. At this point, you can edit the Song in Song mode (see "Song operating mode" on page 88), or save it on disk (see "Save Song page" on page 84).

Warning: The recorded Song is in RAM (Random Access Memory), and will be deleted when turning the instrument off, or entering Record again (either in Backing Sequence or Song mode). Save the Song on disk, if you wish to preserve it.

CHORD/ACC STEP RECORDING

While in the Backing Sequence operative mode, you can enter the Chord/Acc Step Mode to create or edit the Style (Chord/Acc) part of a Song. This mode lets you enter chords even if you are not a keyboard player, or fix any error made playing chords or selecting Style controls, during the Real-time Recording mode.

You can edit only Songs created on the Pa50 or Pa80 (Backing Sequence mode), provided that you have the same Styles in the same locations. When saving a Song created in Backing Sequence mode, all Chord/Acc data is preserved, and can be loaded later, to be edited using the Chord/Acc Step Mode.

Here is how to enter the Chord/Acc Step Mode, and execute your editing:

1. Press B.SEQ to enter the Backing Sequence mode.
2. Press RECORD. You will be prompted to select the Real-time Recording mode or the Chord/Acc Step Mode.



3. Press one of the B (Chord/Acc Step Mode) VOLUME/VALUE buttons to enter the Step Mode. The Chord/Acc

Step mode page appears (see "Chord/Acc Step Recording page" on page 85).

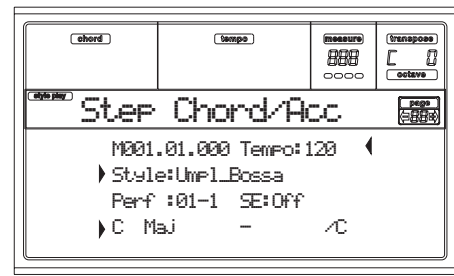

4. Select the M(easure) parameter, and go to a different position into the Song, using the TEMPO/VALUE controls, or the A VOLUME/VALUE buttons. Alternatively, you can move the locator using the < > and << >> buttons. See "Transport controls" on page 87.
5. Select the parameter type to insert, edit or delete at the current position. If an arrow (▶) appears next to a parameter, the shown event has been inserted at the current position.
6. Use the TEMPO/VALUE controls to modify the selected event. Delete it using the DELETE button. When editing a parameter without the arrow (▶) next to it, a new event is inserted.
7. Exit the Chord/Acc Step Mode by pressing the RECORD button.
8. Press START/STOP to listen to the results of your editing. If they are fine, save the Backing Sequence on a disk.

MAIN PAGE (BACKING SEQUENCE PLAY)

This is the main page of the Backing Sequence mode.

To access this page from another operating mode, press the B.SEQ button.

Note: When in this page, the keyboard doesn't play.

Backing Sequence icon Page header

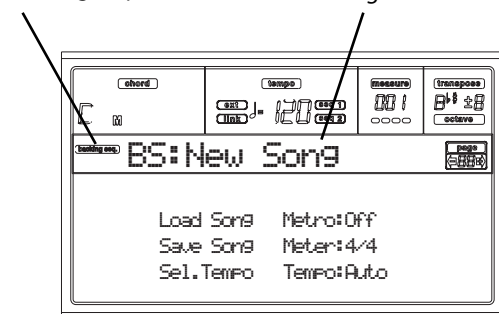

Backing Sequence icon

When on, this icon indicates that the instrument is in Backing Sequence mode.

Page header

This header shows the name of the selected Song.

B (Load Song)

Use these buttons to select a Song (i.e., a Standard MIDI File). The Song Select page opens, and you can select a Song (see below "Load Song page").

C (Save Song)

This command saves the recorded Song as a Standard MIDI File. The file is automatically added the ".MID" extension.

After pressing this command, the Save Song page appears (see “Save Song page” on page 84).

D (Select Tempo)

Select this parameter to use the TEMPO/VALUE section to select the Tempo. When you select this parameter, the VALUE LED turns off.

F (Metro)

Use these buttons to turn the metronome on/off during playback.

G (Meter)

This non-editable parameter shows the starting meter (or time signature) of the selected Song.

H (Tempo mode)

This sets the Tempo change mode.

Man(ual) When the cursor is on the “D (Select Tempo)” parameter, you can change the Tempo using the TEMPO/VALUE section controls. The Song will be played back using the manually selected tempo.

Auto The Tempo recorded into the Song will be used instead.

LOAD SONG PAGE

This page appears when you press PAGE+ or either the B (Load Song) buttons while you are in the main page.

Press EXIT to go back to the main page of the Backing Sequence operating mode, without selecting a Song.

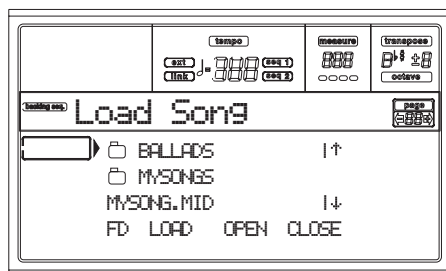

A-C (File, folder)

Move the file or folder to be selected to the first line of the display. To select a file, press the F2 (Select) button. To open a folder, press the F3 (Open) button.

The “” symbol identifies a folder.

E-F (Scroll Up)

Scroll the list up. Keep SHIFT pressed and press one of these buttons to jump to the previous alphabetical section.

G-H (Scroll Down)

Scroll the list down. Keep SHIFT pressed and press one of these buttons to jump to the next alphabetical section.

TEMPO/VALUE section

These controls scroll the list up or down.

F1 (FD)

Press this button after replacing a floppy disk in the floppy disk drive. The new floppy disk will be read, and the file list

shown on the display will be updated.

F2 (Load)

Load the Song at the first line of the display.

F3 (Open)

Opens the selected folder (file whose name begins with the “” symbol).

F4 (Close)

Closes the current folder, returning to the parent (“upper”) folder.

SAVE SONG PAGE

The recorded Song is contained in RAM, and is lost when turning the instrument off. The Song is also lost when you overwrite it in Record mode, or when switching to the Song Play mode. You must save on disk any Song you wish to preserve.

1. If you are in Record mode (RECORD LED on), stop the sequencer and press RECORD to go back to the Backing Sequence Playback page.
2. Select the Save Song button. The Save Song page appears.

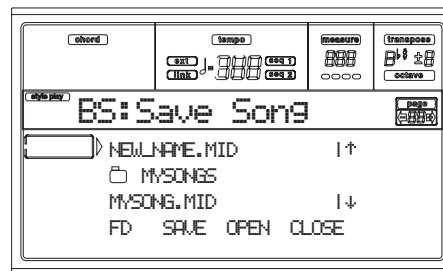

3. Move the folder where you wish to save your Song to the first line of the display, using the E-F (Scroll Up) and G-H (Scroll Down) VOLUME/VALUE buttons, or the TEMPO/VALUE controls. Press F3 (Open) to open it. Close the current folder by pressing F4 (Close).
4. When in the selected folder, you can save the Song over an existing file, or create a new file.
 - To **overwrite** an existing file, move it to the first line of the display.
 - To **create** a new file, move the “NEW_NAME.MID” item to the first line of the display.
5. When the “NEW_NAME.MID” item is selected, press one of the A VOLUME/VALUE buttons. You are prompted to assign a name to the new folder:

NEW_NAME.MID

Move the cursor using the DOWN/- and UP/+ buttons. Select a character using the DIAL. Insert a character at the cursor position by pressing the INSERT button. Delete a character at the cursor position by pressing the DELETE button.

6. When you have finished writing a name for the new midfile, press F2 (Save) to confirm. The “Are you sure?” message will appear. Press ENTER to confirm, or EXIT to abort.

REALTIME RECORDING PAGE

While you are in Backing Sequence mode, press RECORD, then one of the A VOLUME/VALUE buttons, to access the Realtime Recording mode. The RECORD LED turns on.

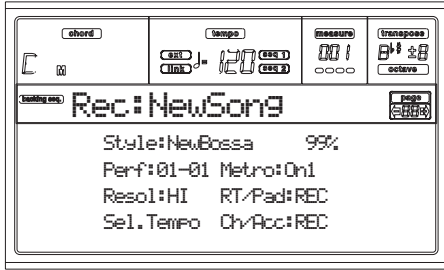

Style

This non-editable parameter shows the selected Style. If no Style is selected, the name will be empty. You can select a different Style, using the STYLE section (see “Selecting a Style” on page 26).

0...99%

This non-editable parameters shows the remaining recording space in memory, as a percentage.

Perf or STS (Performance or STS)

This non-editable parameter shows the selected Performance or STS (depending on the last item selected). If no Performance or STS is selected, the name will be empty. You can select a different Performance, using the PROGRAM/PERFORMANCE section (see “Selecting a Performance” on page 25). To select one of the four STS for the current Style, use the F1-F4 buttons.

Resol (Resolution)

Use this parameter to set the quantization during recording. Quantization is a way of correcting timing errors; notes played too soon or too later are moved to the nearest axis of a rhythmic “grid”, set with this parameter, thus playing perfectly in time.

Hi No quantization applied.

♪ (1/32)...♪ (1/8)

Grid resolution, in musical values. For example, when you select 1/8, all notes are moved to the nearest 1/8 division. When you select 1/4, all notes are moved to the nearest 1/4 division.

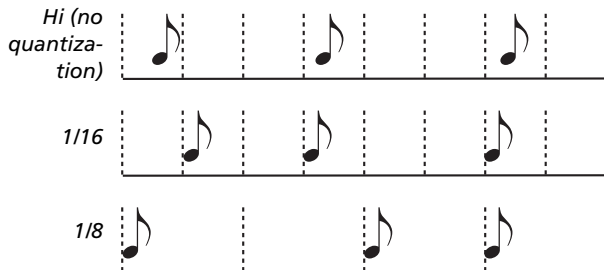

Sel. Tempo (Select Tempo)

Select this parameter to use the TEMPO/VALUE section to select the Tempo. When you select this parameter, the VALUE LED turns off.

Metro (Metronome)

This parameter sets the metronome mode during recording.
 Off The metronome can be heard only during the precount.

On1 The metronome plays during recording. Recording begins with a 1-bar precount. Start recording after bar -1.

On2 The metronome plays during recording. Recording begins with a 2-bar precount. Start recording after bar -1.

RT/Pads

Ch/Acc

These parameters let you decide the track status during recording.

RT/Pads: This Backing Sequence track includes the four Realtime (Keyboard) tracks, and the four Pads. They will be Song tracks 1-8, as in the following table:

RT/Pad track	Song track/Channel
Upper 1	1
Upper 2	2
Upper 3	3
Lower	4
Pad 1	5
Pad 2	6
Pad 3	7
Pad 4	8

Ch/Acc: This Backing Sequence track includes all Style tracks, including recognized chords. They will be Song tracks 9-16.

MUTE The track is muted. If this tracks has already been recorded, it will not be heard during recording of the other Backing Sequence track.

PLAY The track is in play. If there are recorded data, they will be heard during recording of the other Backing Sequence track.

REC The track is in record. All previously recorded data will be deleted.

CHORD/ACC STEP RECORDING PAGE

While you are in Backing Sequence mode, press RECORD, then one of the B VOLUME/VALUE buttons, to access the Chord/Acc Step Recording mode. The RECORD LED turns on.

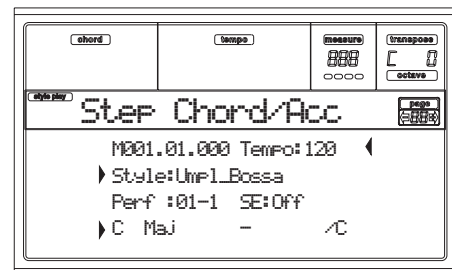

Side arrow (▶)

The small arrow next to a parameter means that its value is effective at the current position. For example, if you are at the “M003.01.000” position, and an arrow lights up next to the Chord parameter, this means that a chord change happens at the “M003.01.000” position.

M(easure)

This is the locator. It shows the current position of the Step Editor. To go to a different position within the Song, select this parameter, then use the TEMPO/VALUE controls, the A VOLUME/VALUE buttons, or the < > buttons (while the << >> buttons let you move to the previous or following measure). When using one of these controls, the locator moves in steps of 1/8 (192 ticks), or jumps to the next event.

The locator's format is as follows:

M001.01.000

| | |

Measure Beat Tick

Measure: Measure or bar number.

Beat: Divider in the Time Signature ratio (e.g., a quarter in a 3/4 time).

Tick: Minimal sequencer's resolution. The Pa50 internal sequencers feature a resolution of 384 ticks per quarter.

INSERT When the Measure parameter is selected, press INSERT to insert a measure starting from the current position. All Chord/Acc events contained into the current measure will be moved to the following measure. The event at the Mxxx.xx.000 position (i.e., exactly at the beginning of the measure, like a Time Signature or Style change) will not be moved.

DELETE When the Measure parameter is selected, press DELETE to delete the current measure. All Chord/Acc event contained into the following measures are moved to the current measure.

SHIFT + DELETE

When the Measure parameter is selected, press SHIFT + DELETE to delete all events in the Style tracks, starting from the current position to the end of the Song. **To delete all events in the Style tracks**, go back to the M001.01.000 position, and press SHIFT + DELETE.

Note: All events on the very first tick (M001.01.000), like Style, Tempo, Chord, Style Element selection, cannot be deleted.

Tempo

This is the Tempo Change parameter. To insert a Tempo Change event at the current position, select this parameter and use the TEMPO/VALUE controls to change its value.

DELETE When the Tempo parameter is selected, and the side arrow (▶) – showing that a Tempo Change event has been selected at the current position – appears next to it, press DELETE to delete the Tempo Change at the current position.

Note: If the side arrow doesn't appear, the event was not selected at the current position, and will not be deleted.

SHIFT + DELETE

When the Tempo parameter is selected, press SHIFT + DELETE to delete all Tempo Change events, starting from the current position to

the end of the Song. **To delete all Tempo Change events in the Song**, go back to the M001.01.000 position, and press SHIFT + DELETE.

Note: All events on the very first tick (M001.01.000), like Perf, Style, Tempo, Chord, Style Element selection, cannot be deleted.

Style

This is the last selected Style. To insert a Style change at the current position, follow the standard selecting procedure using the buttons of the STYLE section.

Note: Any Style Change inserted after the beginning of the measure (i.e., to a position other than Mxxx.01.000) will be effective at the following measure. For example, if a Style Change event has been inserted at M004.03.000, the selected Style will be effectively selected at M005.01.000. (This works exactly as in Style Play mode).

Note: When inserting a Style Change, you may also insert a Tempo Change at the same position. A Style Change will not automatically insert the Style's Tempo.

DELETE When the Style parameter is selected, and the side arrow (▶) – showing that a Style Change event has been selected at the current position – appears next to it, press DELETE to delete the Style Change at the current position.

Note: If the side arrow doesn't appear, the event was not selected at the current position, and will not be deleted.

SHIFT + DELETE

When the Style parameter is selected, press SHIFT + DELETE to delete all Style Change events, starting from the current position to the end of the Song. **To delete all Style Change events in the Song**, go back to the M001.01.000 position, and press SHIFT + DELETE.

Note: All events on the very first tick (M001.01.000), like Perf, Style, Tempo, Chord, Style Element selection, cannot be deleted.

Perf

This is the last selected Performance. Select a Performance to recall the Style it memorizes. To insert a Performance change at the current position, follow the standard selecting procedure using the buttons of the PROGRAM/PERFORMANCE section.

Note: The STYLE CHANGE LED is automatically turned on when entering the Chord/Acc Step Mode. This means that selecting a Performance automatically selects the Style memorized into the Performance.

The SINGLE TOUCH and STS buttons are automatically disabled, meaning that you can't change the Realtime (Keyboard) tracks while in Chord/Acc Step Mode.

DELETE When the Perf parameter is selected, and the side arrow (▶) – showing that a Performance Change event has been selected at the current position – appears next to it, press DELETE to delete the Performance Change at the current position.

Note: If the side arrow doesn't appear, the event was not selected at the current position, and will not be deleted.

SHIFT + DELETE

When the Perf parameter is selected, press SHIFT + DELETE to delete all Performance Change events, starting from the current position to the end of the Song. **To delete all Performance Change events in the Song**, go back to the M001.01.000 position, and press SHIFT + DELETE.

Note: All events on the very first tick (M001.01.000), like Perf, Style, Tempo, Chord, Style Element selection, cannot be deleted.

SE (Style Element)

This is the Style Element (i.e., a Variation, Fill, Intro, or Ending). The length of the selected Style Element is always shown on the measure counter, at the top of the display:

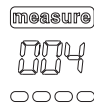

This will let you know where to place the following Style Element Change. For example, if you inserted an Intro event lasting for 4 measures, you can insert 4 empty measure after this event, and a Variation event at the end of the Intro, beginning at the 4th empty measure.

“Off” means that the accompaniment will not play at the selected position – only the Realtime tracks will play.

Hint: Insert a Style Element Off event exactly where the auto-accompaniment must stop, at the end of the Song.

Chord

Use the D VOLUME/VALUE buttons to select the Chord line. Use the F1-F4 buttons to select the part of the chord you wish to edit.

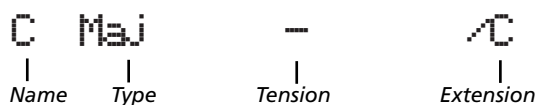

Use the TEMPO/VALUE controls to modify the selected parameter. You can also play a chord, and it will be automati-

cally recognized. While recognizing a chord, the status of the BASS INVERSION button will be considered.

“No chord” means that the accompaniment will not play at the current position (apart for the Drum and Percussion tracks). To select the “No chord” option, press F1 to select the Name part of the Chord, then use the TEMPO/VALUE section to select the very last value (C...B, Off).

Note: If you replace a chord with a different one, please remember that the Lower track will not be automatically changed.

Transport controls

While in Step Mode, you can use various control panel buttons to accomplish the editing procedure.

<< or >> (Rewind or Fast Forward)

Use these buttons to move to the previous or following measure. These commands are effective even if the M(easure) parameter is not selected.

< or > (Previous or Next Step)

Use these button to go to the previous or next step (1/8, or 192 ticks). If an event is located before the previous or next step, the locator stops on that event. For example, if you are positioned on M001.01.000, and no event exists before M001.01.192, the > button moves to the M001.01.192 location. If an event exists on M001.01.010, the > button stops to the M001.01.010 location.

These commands are effective even if the M(easure) parameter is not selected.

[SHIFT] + < or > (Previous or Next Event)

Keep the SHIFT button pressed while pressing the < or > button, to move to the previous or next recorded event.

HOW TO DELETE A WHOLE SONG

You can delete a whole Song with the simple SHIFT + DELETE key sequence.

1. Enter the Backing Sequence mode. You must be in the main page of the mode. If you are in Record mode, go back to the Playback mode.
2. Press SHIFT + DELETE.
3. The “Delete Song?” message appears. Press ENTER to confirm, EXIT to abort.

13. SONG OPERATING MODE

The Song operating mode is the full-featured onboard sequencer, where you can create from scratch or edit a Song. You can also use this mode to edit the initial parameters of a Standard MIDI File, either made with an external sequencer or with Pa50 own Song and Backing Sequence modes.

You can save the edited Song as a Standard MIDI File (".MID" file), and playback it either in Song Play, Backing Sequence or Song mode.

For a practical example of Song editing, see "5 - Editing a Song" on page 32.

TRANSPORT CONTROLS

While in Song mode, use the SEQ1 transport controls for the Song playback. See "SEQUENCER TRANSPORT CONTROLS - SEQ1 and SEQ2" on page 18 for more information).

MASTER VOLUME AND SEQUENCER VOLUME

You can use the MASTER VOLUME and ACC/SEQ VOLUME sliders to set the volume. See "Master Volume, Sequencer Volume, BALANCE" on page 71.

Move the BALANCE slider to the center (or the left) for the maximum volume of the sequencer (Song mode relies on Sequencer 1).

THE SONGS AND THE STANDARD MIDI FILE FORMAT

The native Song format for Pa50 is the Standard MIDI File. See "The Songs and the Standard MIDI File format" on page 70.

When saving a Song as a SMF, an empty measure is automatically inserted to the beginning of the Song. This measure contains various Song initialization parameters.

When a SMF is loaded, the empty measure is automatically removed.

FAST TRACK DELETION

When you are in the Main page of the Song Record mode, and the Song tracks are shown in the display, keep the DELETE button pressed, and press one of the VOLUME/VALUE buttons corresponding to the track to delete. The "Are you sure?" message will appear. Press ENTER to delete the track, or EXIT to abort.

HOW TO DELETE A WHOLE SONG

While in the Main page, you can delete a whole Song, with the simple SHIFT + DELETE key sequence.

1. Enter the Song mode. You must be in the Main page of the mode. If you are in Record mode, go back to the Playback mode.
2. Press SHIFT + DELETE.
3. The "Delete Song?" message appears. Press ENTER to confirm, EXIT to abort.

MAIN PAGE

Press SONG to access this page from another operating mode.

Note: When switching from Style Play to Song, the Song Setup is automatically selected, and various track parameters may change.

Press EXIT/NO to access this page from the Menu or any of the Song Play edit pages.

To see the Song's tracks, use the TRK SELECT button to switch from the Main page to the Tracks pages. Pressed a first time, you will see tracks 1-8 (enlightened TRK SELECT LED); a second press will show tracks 9-16 (flashing TRK SELECT LED); pressed again, you will go back to the Main page (TRK SELECT LED switched off).

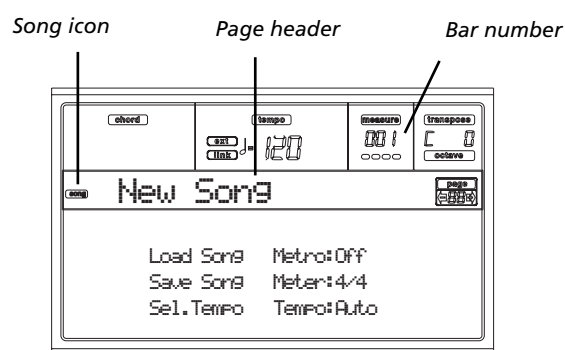

Song icon

When on, this icon shows that the instrument is in Song mode.

Page header

This line shows the selected Song name.

Bar number

This counter shows the current bar number position of the selected Song.

B (Load Song)

Use these buttons to select a Song (i.e., a Standard MIDI File). The Song Select page opens, and you can select a Song (see below "Song Select page").

C (Save Song)

This command saves the edited Song as a Standard MIDI File. After pressing this command, the Save Song page appears (see "Save Song page" on page 90).

D (Select Tempo)

Select this parameter to use the TEMPO/VALUE section to select the Tempo. When you select this parameter, the VALUE LED turns off.

Note: The tempo is always record in overwrite mode (old data is replaced by the new data).

F (Metro)

Use these buttons to turn the metronome on/off during playback.

G (Meter)

This non-editable parameter shows the starting meter (or time signature) of the selected Song.

H (Tempo mode)

This sets the Tempo change mode.

Man(ual) When the cursor is on the “D (Select Tempo)” parameter, you can change the Tempo using the TEMPO/VALUE section controls. The Song will be played back using the manually selected tempo.

Auto The Tempo recorded to the Song will be used.

TRACKS 1-8 PAGE

To see and edit tracks 1-8, press TRACK SELECT from the main page. The TRACK SELECT LED turns on.

Press the TRACK SELECT button twice, to go back to the main page.

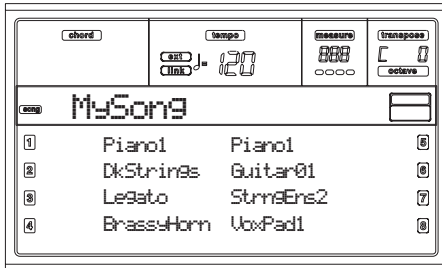

A-H (Tracks 1-8 Programs)

Name of the Programs assigned to tracks 1-8. Use these buttons to select, mute/unmute or change the volume of the corresponding tracks.

TRACKS 9-16 PAGE

To see and edit tracks 9-16, press TRACK SELECT once from the Tracks 1-8 page, or twice from the main page. The TRACK SELECT LED begins flashing.

Press the TRACK SELECT button again, to go back to the main page.

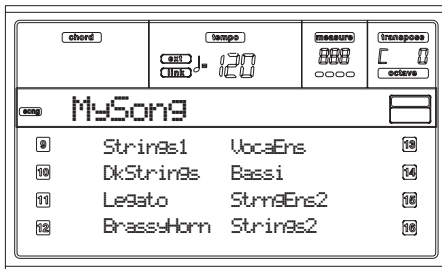

A-H (Tracks 9-16 Programs)

Name of the Programs assigned to tracks 9-16. Use these buttons to select, mute/unmute or change the volume of the corresponding tracks.

SONG SELECT PAGE

This page appears when you press PAGE+ or either the B (Load Song) buttons while you are in the main page.

Press EXIT to go back to the Main page of the Song operating mode, without selecting a Song.

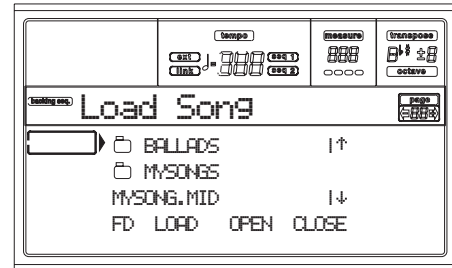

A-C (File, folder)

Move the file or folder to be selected to the first line of the display. To select a file, press the F2 (Load) button. To open a folder, press the F3 (Open) button.

The “” symbol identifies a folder.

E-F (Scroll Up)

Scroll the list up.

G-H (Scroll Down)

Scroll the list down.

TEMPO/VALUE section

These controls scroll the list up or down.

F1 (FD)

Press this button after replacing a floppy disk in the floppy disk drive. The new floppy disk will be read, and the file list shown on the display will be updated.

F2 (Load)

Load the Song at the first line of the display.

F3 (Open)

Opens the selected folder (file whose name begins with the “” symbol).

F4 (Close)

Closes the current folder, returning to the parent (“upper”)

SAVE SONG PAGE

The new or edited Song is contained in RAM, and is lost when turning the instrument off. The Song is also lost when you overwrite it in Backing Sequence Record mode, or when switching to the Song Play mode. You must save on disk any Song you wish to preserve. The Song is saved as a Standard MIDI File (SMF).

Note: When saving a Song as a SMF, an empty measure in automatically inserted to the beginning of the Song. This measure contains various Song initialization parameters.

1. If you are in an edit page, press EXIT to go back to the Main page.
2. Select the Save Song button. The Save Song page appears.



3. Move the folder where you wish to save your Song to the first line of the display, using the E-F (Scroll Up) and G-H (Scroll Down) VOLUME/VALUE buttons, or the TEMPO/VALUE controls. Press F3 (Open) to open it. Close the current folder by pressing F4 (Close).
4. When in the selected folder, you can save the Song over an existing midifile (a file with a ".MID" extension), or create a new midifile.
 - To **overwrite** an existing midifile, move it to the first line of the display.
 - To **create** a new midifile, move the "NEW_NAME.MID" item to the first line of the display.
5. When the "NEW_NAME.MID" item is selected, press one of the A VOLUME/VALUE buttons. You are prompted to assign a name to the new file:

NEWNAME.MID

Move the cursor using the DOWN/- and UP/+ buttons. Select a character using the DIAL. Insert a character at the cursor position by pressing the INSERT button. Delete a character at the cursor position by pressing the DELETE button.

6. When you have finished writing a name for the new midifile, press F2 (Save) to confirm. The "Are you sure?" message will appear. Press ENTER to confirm, or EXIT to abort.

Play/Mute status saved with the Song

When saving a Song, the Play/Mute status is saved with the Song. This status is preserved when playing back the same Song in Song Play mode.

Master Transpose saved with the Song

When saving a Song, the Master Transpose value is saved with the Song. Since this value is saved as System Exclusive data, it is preserved when playing back the Song in Song Play mode.

Hint: Since the Master Transpose is a global parameter, loading a Song with a non-standard transposition may result in unwanted transposing when loading other Songs that do not contain their own transposition data. To transpose a Song it is advisable to use the Edit-Transpose function; you can access this function by pressing the MENU button and one of the E VOLUME/VALUE buttons (see "Page 18 - Edit: Transpose" on page 100).

You may also lock the Master Transpose for various tracks, to avoid unwanted transposition. See "Page 2 - Master Transpose" on page 126 of the Global chapter.

As a general rule, you should use the Master Transpose (TRANSPPOSE buttons on the control panel) when you need to transpose the Realtime tracks together with the Song. You should use the Edit-Transpose function (Song Edit mode) when only the Song has to be transposed.

Note: The Master Transpose value is always shown in the upper right corner of the display:

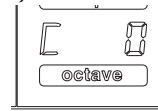

REALTIME RECORD PROCEDURE

Here is the general procedure to follow for the Realtime Recording.

1. Press SONG to enter the Song mode.
2. Press RECORD to enter the Song Record mode. You are now in the Main page of the Song Record mode, and you can prepare your recording. (For more details, see "Song Record page" on page 93).

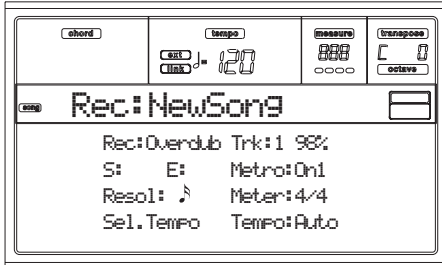

3. Be sure one of the Overdub or Overwrite recording options is selected (see "Rec (Record mode)" on page 93).
4. Set the tempo. There are two ways of changing tempo:
 - Keep the SHIFT button pressed, and use the TEMPO/VALUE controls to change the tempo.
 - Move the cursor to the "Sel. Tempo" parameter, and use the TEMPO/VALUE controls to change tempo.
5. Press TRK SELECT to switch to the Song Tracks 1-8 page.

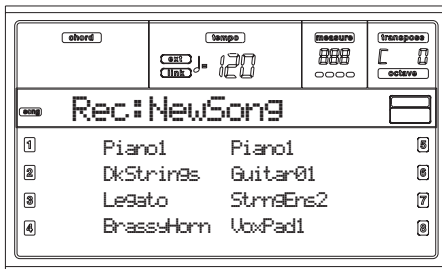

Press the button again to switch to the Song Tracks 9-16 page.



6. If you like, you can set the tempo again from these pages: just use the TEMPO/VALUE controls.
7. Assign the right Program to each track.
8. Select the track to put in record. Its status icon will automatically begin flashing.

9. While the status icon is flashing, press PLAY/STOP to begin recording. Depending on the Metro option you selected, a 1- or 2-bars precount may play before the recording actually begins. When it begins, play freely.
 - If you selected the Auto Punch recording mode, the recording will begin only when reaching the Start point.
 - If you selected the Pedal Punch recording mode, press the pedal when you want to begin recording. Press it again to finish recording.

Note: The Punch functions will not work on an empty Song. At least one track must already be recorded.

10. When finished recording, press PLAY/STOP to stop the sequencer. Select a different track, and go on recording the whole Song.
11. When finished recording the new Song, press RECORD to exit the Record mode. The Song will be saved in memory.

Warning: Save the Song on a disk, to avoid it is lost when turning the instrument off.

Note: When exiting the Record mode, the Octave Transpose is automatically reset to "0".

12. Edit the new Song; press the MENU page, and select the various edit pages.

STEP RECORD PROCEDURE

The Step Record allows you to create a new Song by entering the single notes or chords in each track. This is very useful when transcribing an existing score, or needing a higher grade of detail, and is particularly suitable to create drum and percussion tracks.

1. While in the Main screen of the Song mode, press RECORD to enter the Song Record mode. The Main page of the Song Record mode will appear.

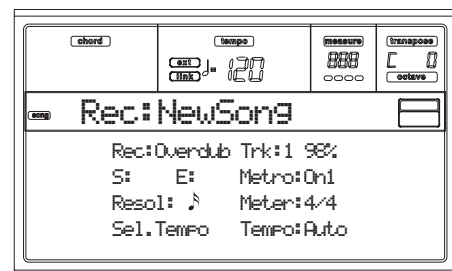

2. Use the A VOLUME/VALUE buttons to select the "Rec" (Recording Mode) parameter. Use these buttons, or the TEMPO/VALUE controls, to select the "Step Dub" (Step Overdub) or the "StepOwr" (Step Overwrite) recording mode.
 - The Step Overdub mode lets you add events to the existing events.
 - The Step Overwrite mode will overwrite all existing events.
3. Press SEQ1 PLAY/STOP to turn its LED on, and enter the Step Record page. (See "Step Record page" on

page 94 for more information on each parameter of this page).

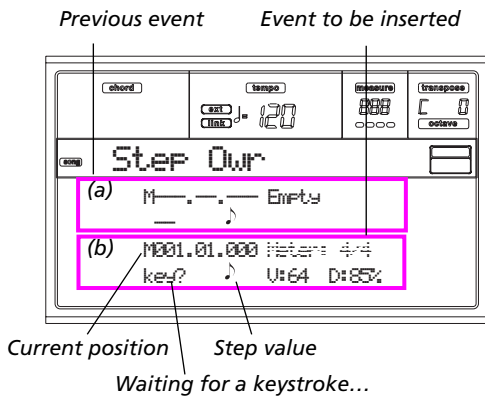

The first two lines (a) are the latest inserted event. The second two lines (b) are the event currently in edit, ready to be inserted.

The “Empty” event marks the beginning of the Song, when there are no events inserted. It is automatically inserted when entering the Record mode. It will be removed when an event is inserted.

- The “Maaa.bb.ccc” parameter in (b) is the current position. This is the place where the note in edit will be inserted.

• If you don't want to insert a note at this position, insert a rest instead, as shown in step 6.

• To jump to the next measure, filling the remaining beats with rests, press the >> button.

- To change the step value, use the NOTE VALUE buttons, on the lower left area of the control panel.

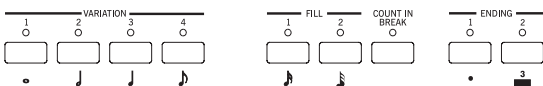

- Insert a note, rest or chord at the current position.

• To insert a single note, just play it on the keyboard. The inserted note length will match the step length. You may change the velocity and relative duration of the note, by

editing the V (Velocity) and D (Duration) parameters. See “V (Velocity)” and “D (Duration)” on page 94.

• To insert a rest, just press the REST button. Its length will match the step value.

• To tie the note to be inserted to the previous one, press the TIE button. A note will be inserted, tied to the previous one, with exactly the same name. You don't need to play it on the keyboard again.

• To insert a chord or a second voice, see “Chords and second voices” below.

- After inserting a new event, you may go back by pressing the < button. This will delete the previously inserted event, and set the step in edit again.
- When finished recording, press SEQ1 PLAY/STOP to turn off its LED. The Main page of the Song Record mode appears again.



- From the Main page of the Song Record mode, press RECORD to exit the Record mode. While in the Main page of the Song mode, you may press SEQ1 PLAY/STOP to listen to the Song, or select the Save Song command to save the Song on disk.

Chords and second voices

With Pa50, you are not obliged to insert single notes in a track. There are several ways to insert chords and double voices. For more information, see the “Chords and second voices in Step Record mode” section on page 10-60 of the “Style Record mode” chapter.

SONG RECORD PAGE

While in the Song mode, press RECORD to enter the Song Record mode. The Song Record page appears.

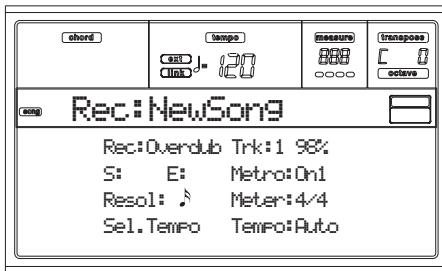

Rec (Record mode)

Set this parameter to select a recording mode.

Overdub The newly recorded events will be mixed to any existing events.

Overwrite The newly recorded events will replace any existing events.

Auto Punch Recording will automatically begin at the “S” position, and stop at the “E” position (see the following line).

Note: The Auto Punch function will not work on an empty Song. At least one track must already be recorded.

PedalPunch Recording will begin when pressing a pedal set to the “Punch In/Out” function, and will finish when pressing the same pedal again.

Note: The Pedal Punch function will not work on an empty Song. At least one track must already be recorded.

StepDub Step Overdub. This recording mode lets you enter events one at a time, adding events to the existing events.

StepOwr Step Overwrite. This recording mode lets you enter events one at a time, overwriting all existing events.

Trk (Track)

Track in record.

1...16 One of the 16 tracks selected. To select a track, go to the Track pages (see “Tracks 1-8 page” on page 89 and “Tracks 9-16 page” on page 89).

S/E (Start/End)

These parameters appear only when the “Auto Punch” recording mode is selected. They set the starting and ending points of the Punch recording.

Metro (Metronome)

This is the metronome heard during recording.

Off No metronome click will be heard during recording. A one-bar precount will be played before starting recording.

On1 Metronome on, with a one-bar precount before starting recording.

On2 Metronome on, with a two-bar precount before starting recording.

Resol (Resolution)

Use this parameter to set the quantization during recording. Quantization is a way of correcting timing errors; notes played too soon or too later are moved to the nearest axis of a rhythmic “grid”, set with this parameter, thus playing perfectly in time.

Hi No quantization applied.

♪ (1/32)...♪ (1/8)

Grid resolution, in musical values. For example, when you select 1/16, all notes are moved to the nearest 1/16 division. When you select 1/8, all notes are moved to the nearest 1/8 division.

No quantization



1/16



1/8



Meter

This is the meter (or time signature) of the Song. You can edit this parameter only when the Song is empty, i.e. before you begin recording anything. To insert a meter change in the middle of the Song, use the “Insert Measure” function (see page 13-101).

Sel. Tempo (Select Tempo)

Select this parameter to use the TEMPO/VALUE controls to set the tempo.

Note: You can always change the Tempo, when other parameters are selected, by keeping the SHIFT button pressed, and rotating the DIAL.

Note: The tempo is always record in overwrite mode (old data is replaced by the new data).

Tempo (Tempo mode)

This parameter sets the way tempo events are read.

Record All Tempo changes made during recording will be recorded to the Master Track.

Auto The Sequencer plays back all recorded Tempo events. No new Tempo events are recorded.

Manual The latest manual Tempo setting (made using the TEMPO/VALUE controls) is considered the current Tempo value. No Tempo change will be recorded. This is very useful to record the Song much slower than its actual Tempo.

STEP RECORD PAGE

Access this page from the Main page of the Song Record mode, by selecting the “StepDub” or “StepOvr” recording mode (“Rec” parameter), and pressing SEQ1 PLAY/STOP.

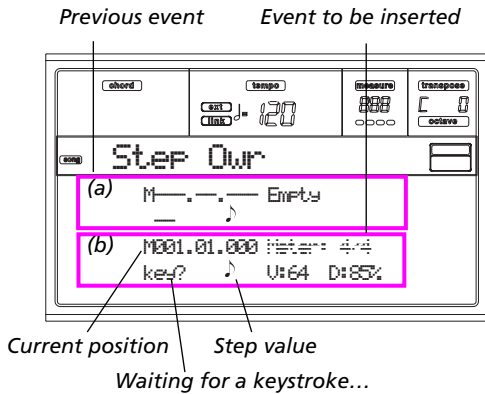

(a) section

Previously inserted event. You may delete this event, and set it in edit again, by pressing the < button.

(b) section

Event to be inserted. See the following parameters for information on each element of this section.

M (Measure)

This is the position of the event (note, rest or chord) to be inserted.

Meter

Meter of the current measure. This parameter can't be edited. You can set a Meter change by using the Insert function of the Edit menu, and inserting a new series of measures with a different Meter (see “Page 22 - Edit: Insert Measures” on page 101).

key?

This is a prompt, asking for a note or chord to be played on the keyboard, to enter an event on the current step.

Step value

Length of the event to be inserted. Use the NOTE VALUE buttons, on the lower left area of the control panel, to change this value.

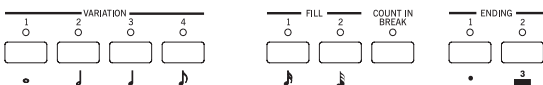

o...♪
Dot (.)

Note value.

Triplet (3)

Augments the selected note by one half of its value.

V (Velocity)

Makes the selected note a triplet note.

KBD

Set this parameter before entering a note or chord. This will be the playing strength (i.e., velocity value) of the event to be inserted.

1...127

Keyboard. You can select this parameter, by turning all counter-clockwise the dial. When this option is selected, the playing strength of the played note is recognized and recorded.

Velocity value. The event will be inserted with this velocity value, and the actual playing strength of the note played on the keyboard will be ignored.

D (Duration)

Relative duration of the inserted note. The percentage is always referred to the step value.

50%

Staccato.

85%

Ordinary articulation.

100%

Legato.

Buttons used in Step Record mode

TIE button

Ties the note to be inserted to the previous note.

REST button

Inserts a rest.

NOTE VALUE buttons

Select the step value.

SEQ1 PLAY/STOP button

Exits the Step Record mode.

< (Previous step)

Goes to the previous step, erasing the inserted event.

>> (Fast Forward)

Goes to the next measure, and fill the remaining space with rests.

MENU

While in any page, press MENU to open the Song edit menu. This menu gives access to the various Song edit sections. When in the menu, select an edit section using the VOLUME/VALUE (A-H) buttons, select an edit page using PAGE +, or press EXIT to exit the menu. When in an edit page, press EXIT to go back to the main page of the Song operating mode.

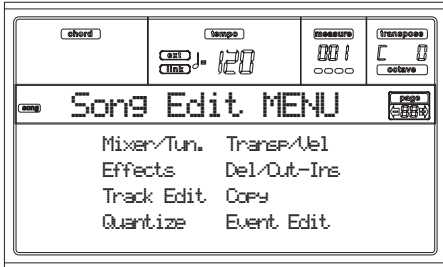

Each item in this menu corresponds to an edit section. Each edit section groups various edit pages.

EDIT PAGE STRUCTURE

Select an edit section from the Menu, and/or use the PAGE buttons to reach the desired page. Press EXIT to go back to the main page of the Song mode. All edit pages share the same structure.

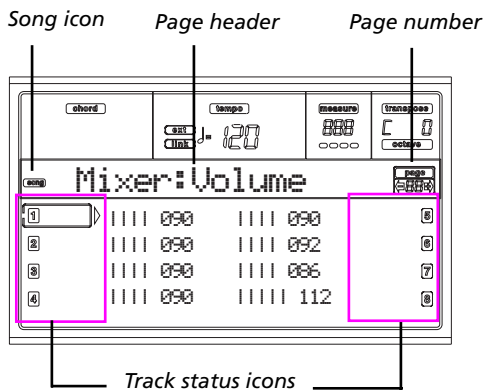

Song icon

When on, this icon indicates that the instrument is in Song mode.

Page header

The header shows the name of the current edit page. Usually the header is divided in a first word, identifying the section name (e.g., "Mixer:FX Send" is a "Mixer" section page), and a second word, referring to the page name (e.g. "FX Send").

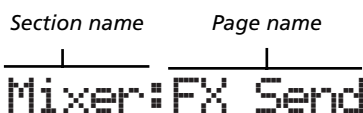

Page

This area shows the current page number.

A-H

Each pair of VOLUME/VALUE buttons select a different track, parameter of command, depending on the edit page.

Track status icons

A series of icons near each track show the track's status.

- Selected track or parameter. When this symbol appears, you can execute any available operation on the selected item.
- Track in play or already recorded.
- The track is in mute, or does not contain data.

PAGE 1 - MIXER: VOLUME

Here you can adjust the volume for each of the 16 sequencer tracks. Press both VOLUME/VALUE button to mute/unmute the corresponding track.

A muted track remains muted even when selecting a different Song.

Use the TRACK SELECT button to switch between Song tracks 1-8, Song tracks 9-16, and back again.

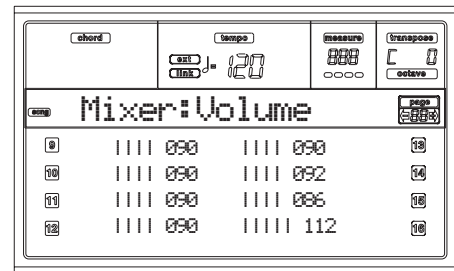
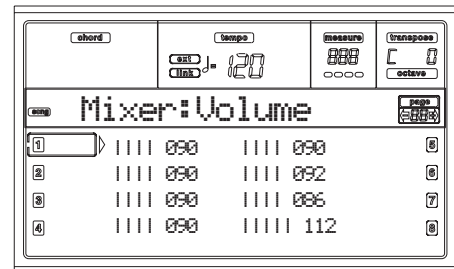

PAGE 2 - MIXER: PAN

Here you can adjust the pan for each Song track.

Use the TRACK SELECT button to switch between Song tracks 1-8, Song tracks 9-16, and back again.

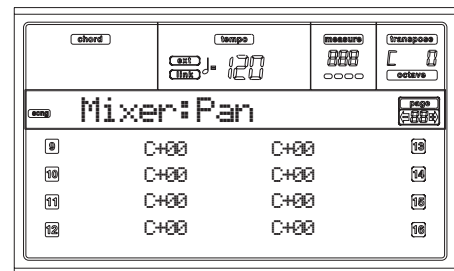
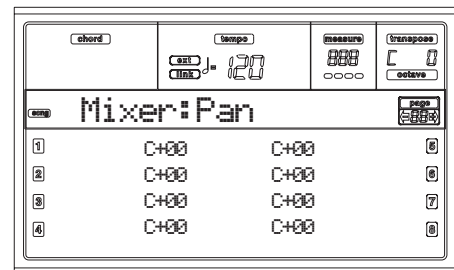

- Pan**
- 64 Hard Left.
 - +00 Center.
 - +63 Hard Right.
 - Off The direct (unaffected) signal does not go to the outputs; only the FX signal is heard for this track.

PAGE 3 - MIXER: FX BLOCK

This page lets you select a pair of effect processor (AB or CD) for each of the Song track.

Use the TRACK SELECT button to switch between Song tracks 1-8, Song tracks 9-16, and back again.

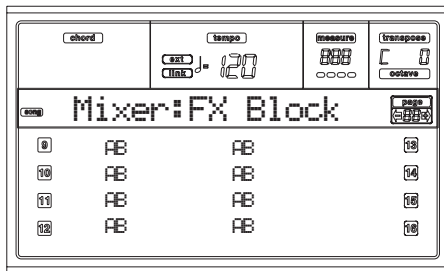
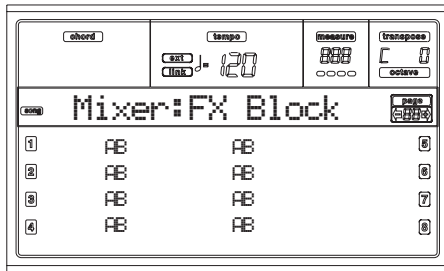

PAGE 4 - MIXER: FX SEND A/B (OR C/D)

This page lets you set the level of the track's direct (unaffected) signal going to the A and B, or C and D Internal FX pair. Go to the previous page ("Page 3 - Mixer: FX Block") to select an FX pair.

Use the TRACK SELECT button to switch from tracks 1-8 to tracks 9-16.

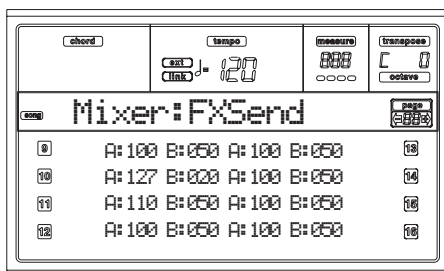
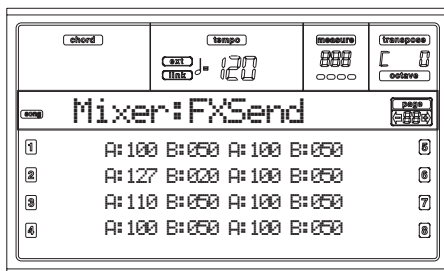

Here is the edit procedure:

1. Use the VOLUME/VALUE (A-H) buttons to select a track.
2. Use the F1-F4 buttons to select a parameter for that track.
3. Use the TEMPO/VALUE controls to change the parameter's value.

Parameters

- 000 No effect. Only the direct (unaffected) signal goes to the outputs.
- 127 100% effect. The direct (unaffected) and effected signals go to the outputs with the same level.

PAGE 5 - TUNING: DETUNE

This page is where you can set the fine tuning for each track. Use the TRACK SELECT button to switch between Song tracks 1-8, Song tracks 9-16, and back again.

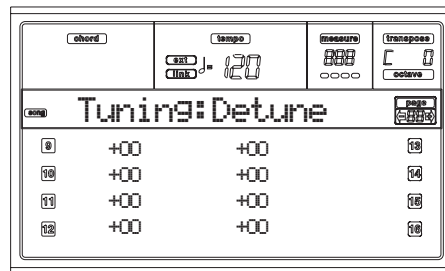
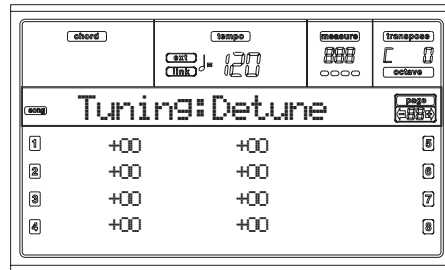

Detune

This is the fine tuning.

- 64 Lowest pitch.
- 0 Standard tuning.
- +63 Highest pitch.

PAGE 6 - TUNING: SCALE

This page lets you program the alternative scale for the Song tracks.

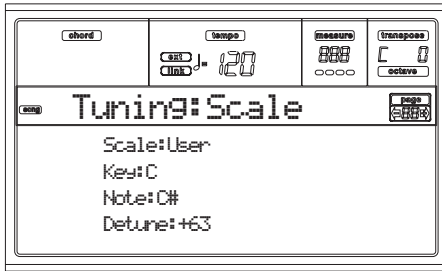

Scale

Alternative scale for the Song tracks. See “Scales” on page 227 for a list of available scales. To enable/disable the alternative scale for each Song track, see “Page 7 - Tuning: PitchBend/Scale” on page 97.

Key

Parameter required for some Scales, when you should set a preferred key.

Note

Note in edit, to be detuned. This parameter can be accessed when a User Scale is selected.

Detune

Note detune, compared to the standard Equal tuning. This parameter can be accessed when a User Scale is selected.

PAGE 7 - TUNING: PITCHBEND/SCALE

This page lets you program the Pitch Bend range for the Song tracks. Furthermore, it lets you activate/deactivate the alternative scale for each track.

Use the TRACK SELECT button to switch between Song tracks 1-8, Song tracks 9-16, and back again.

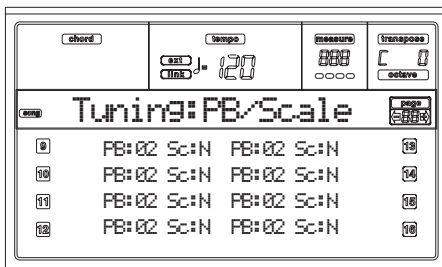
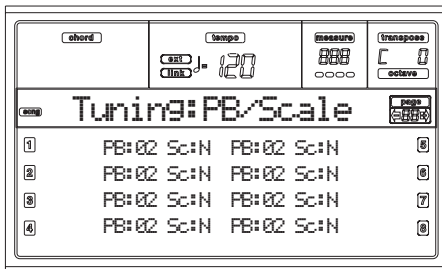

PB(end)

This parameters shows the Pitch Bend range for each track, in semitones.

- 01...12 Maximum positive/negative pitchbend range (in semitones). 12 = ±1 octave.
- Off No pitchbend allowed.

Sc(ale)

This parameter lets you activate/deactivate the alternative scale for each track. (See “Page 6 - Tuning: Scale” on page 97 for more information on selecting an alternative scale).

- Yes The track is tuned according to the alternative scale.
- No The track is tuned according to the Global scale (see “Scale” on page 125).

PAGE 8 - FX: A/B SELECT

This page lets you select the A and B effects. Usually, the A effect is a reverb, while the B effect is a modulating effect. Standard MIDI Files usually require two effects only. You can, however, assign all four effects to a Song (see “Page 3 - Mixer: FX Block” on page 96).

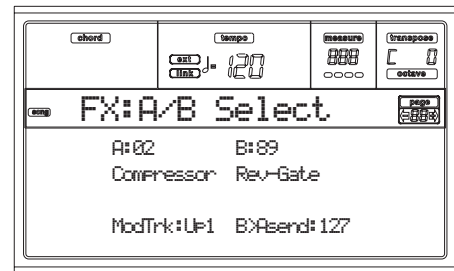

Note: When you stop the Song, or select a different Song, the default effects are selected again. You can, however, stop the Song, change the effects, then start the Song again. Save the Song to permanently change the effects.

A, B

Effects assigned to the A and B effect processors. Usually, A is the reverb, while B is the modulating effect (chorus, flanger, delay...). For a list of the available effects, see “Effects” on page 175.

ModTrk (Modulating Track)

Source track for modulating MIDI messages. You can modulate an effect parameter with a MIDI message generated by a physical controller.

B>Asend (B>A Send)

Amount of the B effect going back to the input of the A effect.

PAGE 9 - FX: C/D SELECT

This page lets you select the C and D effects. Usually, the C effect is a reverb, while the D effect is a modulating effect. Standard MIDI Files usually require two effects only. You can, however, assign all four effects to a Song (see “Page 3 - Mixer: FX Block” on page 96).

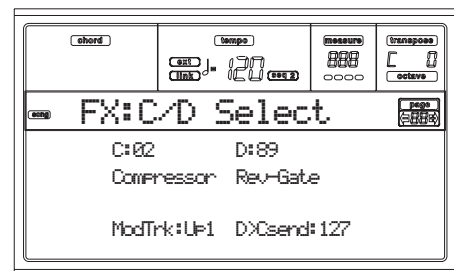

Note: When you stop the Song, or select a different Song, the default effects are selected again. You can, however, stop the

Song, change the effects, then start the Song again. Edit the Song in Song mode to permanently change the effects.

C, D

Effects assigned to the C and D effect processors. Usually, C is the reverb, while D is the modulating effect (chorus, flanger, delay...). For a list of the available effects, see “Effects” on page 175.

ModTrk (Modulating Track)

Source track for modulating MIDI messages. You can modulate an effect parameter with a MIDI message generated by a physical controller.

D>Csend (D>C Send)

Amount of the D effect going back to the input of the C effect.

PAGE 10 - FX: A EDITING

This page contains the editing parameters for the A effect (usually a reverb).

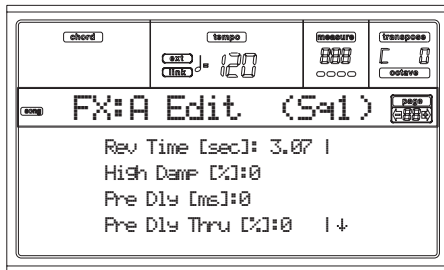

Use the E-F and G-H VOLUME/VALUE button pairs to scroll the parameter list.

Use the A-D VOLUME/VALUE button pairs to select and edit a parameter.

Use the TEMPO/VALUE controls to edit the selected parameter.

Note: When you stop the Song, or select a different Song, the default effects are selected again. You can, however, stop the Song, change the effects, then start the Song again. Edit the Song in Song mode to permanently change the effects.

Parameters

See “Effects” on page 175 for a list of available parameters for each effect type.

PAGE 11 - FX: B EDITING

This page contains the editing parameters for the B effect (usually a modulating effect). For more details, see “Page 10 - FX: A editing” above.

PAGE 12 - FX: C EDITING

This page contains the editing parameters for the C effect. For more details, see “Page 10 - FX: A editing” above.

PAGE 13 - FX: D EDITING

This page contains the editing parameters for the D effect. For more details, see “Page 10 - FX: A editing” above.

PAGE 14 - TRACK: EASY EDIT

In this page you can edit the main parameters of the Programs assigned to each track.

Note: All values are relative to the value of the original Program.

You can also change the volume for each class of Drums and Percussions, if the selected track is set in Drum mode (see below “Page 15 - Track: Mode”).

Use the TRACK SELECT button to switch between Song tracks 1-8, Song tracks 9-16, and back again.

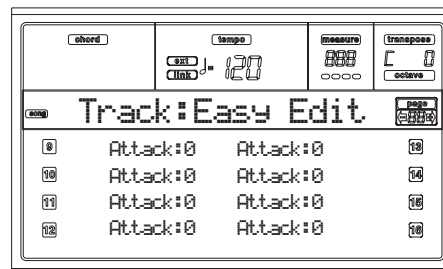
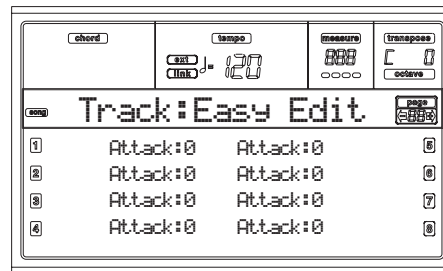

Here is the edit procedure:

1. Use the VOLUME/VALUE (A-H) buttons to select a track.
2. Use the F1-F4 buttons to select a sound parameter, or its value. (For the Drum and Percussion tracks, see below the “Drum tracks” section).
3. Use the TEMPO/VALUE controls to change the sound parameter or its value.

Parameters

- Attack** Attack time. This is the time during which the sound goes from zero (at the moment when you strike a key) to its maximum level.
- Decay** Decay time. Time to go from the final Attack level to the beginning of the Release.
- Release** Release time. This is the time during which the sound goes from the sustaining (or Decay) phase, to zero. The Release is triggered by releasing a key.
- Cutoff** Filter cutoff. This sets the sound brightness.
- Resonance** Use the Filter Resonance to define the width of the frequency range affected by the Filter.
- Vibrato Rate** Speed of the Vibrato.
- Vibrato Depth** Intensity of the Vibrato.
- Vibrato Delay** Delay time before the Vibrato begins, after the sound starts.

Drum tracks

When a track is set in Drum Mode (like the Drum and Percussion tracks), you can adjust the volume for each of the Drum and Percussion categories.

- Kick V Kick drums volume.
- Snare V Snare drums volume.
- Tom V Toms volume.
- HiHat V Hi-Hat volume.
- CymbalV Ride, Crash and other cymbals volume.
- Percus1V "Classic" percussion set volume.
- Percus2V "Ethnic" percussion set volume.
- SFX V Special effects volume.

Reset

You can reset the parameters' value by keeping the SHIFT button pressed, while pressing the selected track VOLUME/VALUE button. When you press the above combination, the Reset window appears:



Press ENTER/YES to reset the currently selected track. Keep SHIFT pressed, and press ENTER/YES, to reset all tracks. Press EXIT/NO to abort and leave all parameters unchanged.

PAGE 15 - TRACK: MODE

This page lets you set the polyphony mode for each track. Use the TRACK SELECT button to switch between Song tracks 1-8, Song tracks 9-16, and back again.

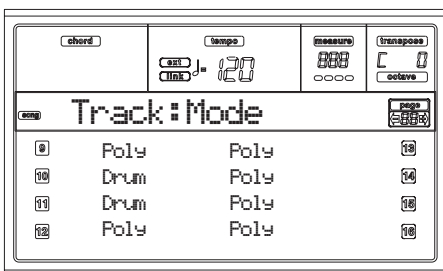
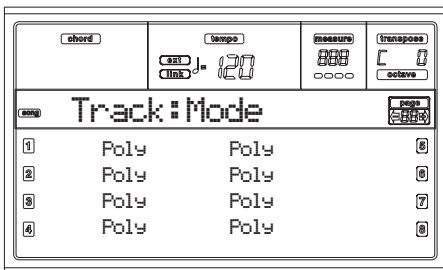

Parameters

Drum This is a Drum/Percussion track. No Master or Octave Transpose applies to this track. You can set a different volume for each class of percussive instruments ("Page 14 - Track: Easy edit" on page 98).

- Poly** Tracks of this kind are polyphonic, i.e. they can play more than one note at the same time.
- Mono** Tracks of this kind are monophonic, i.e. each new note stops the previous note.
- Mono Right** A Mono track, but with priority assigned to the rightmost (highest) note.

PAGE 16 - TRACK: INTERNAL/EXTERNAL

This page lets you set the Internal or External status for each track. It is very useful to let a Song track drive an external expander.

Use the TRACK SELECT button to switch between Song tracks 1-8, Song tracks 9-16, and back again.

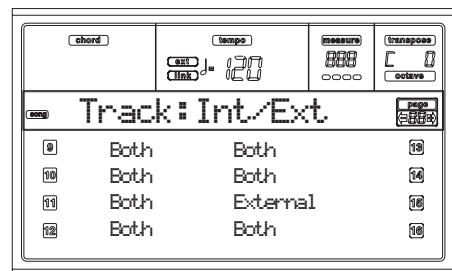
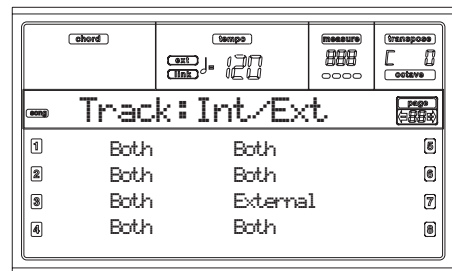

Parameters

Internal The track plays the sounds generated by the internal sound engine. It does not play an external instrument connected to the MIDI OUT.

External The track plays an external instrument connected to the MIDI OUT. It does not play the internal sounds, thus saving polyphony.

When a track is set to "External", a strings of transmitted Control Change and Program Change data is shown instead of the Program name assigned to the track. In the following example, CC#0 is the Control Change 0 (Bank Select MSB), CC#32 is the Control Change 32 (Bank Select LSB), PC is the Program Change.

121- 3- 0
| | |
CC#0 CC#32 PC

Both The track plays both the internal sounds and an external instrument connected to the MIDI OUT.

PAGE 17 - EDIT: QUANTIZE

The quantize function corrects any rhythm error after recording.

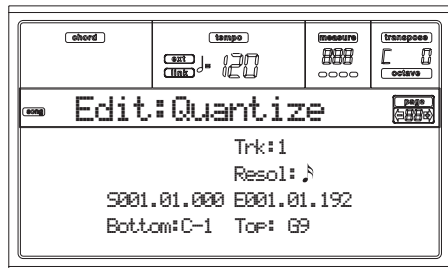

After setting the various parameters, press ENTER to execute. The "Are you sure?" message will appear. Press ENTER to confirm, EXIT to abort.

Trk (Track)

Use this parameter to select a track.

- All All tracks selected.
- 1...16 Selected track.

Resol (Resolution)

This parameter sets the quantization after recording. For example, when you select 1/8a, all notes are moved to the nearest 1/8 division. When you select 1/4, all notes are moved to the nearest 1/4 division.

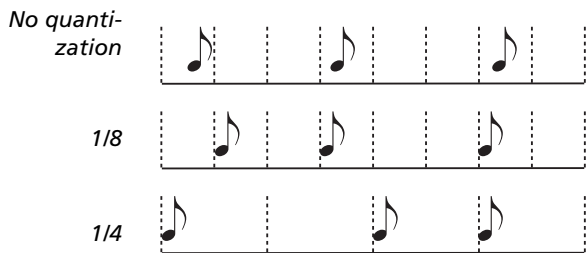

♩ (1/32)...♪ (1/4)

Grid resolution, in musical values. An "a" after the value means no swing. A "b...f" after the value means swing-quantization.

S / E (Start/End)

Use these parameters to set the starting (S) and ending (E) points of the range to quantize.

If you wish to select a four-measure sequence starting at the beginning of the Song, the Start will be positioned at 1.01.000, and the End at 5.01.000.

Bottom / Top

Use these parameters to set the bottom and top of the keyboard range to quantize. If you select the same note as the Bottom and Top parameters, you can select a single percussive instrument in a Drum track.

Note: These parameters are available only when a Drum track is selected.

PAGE 18 - EDIT: TRANSPOSE

Here you can transpose the Song, a track or a part of a track.

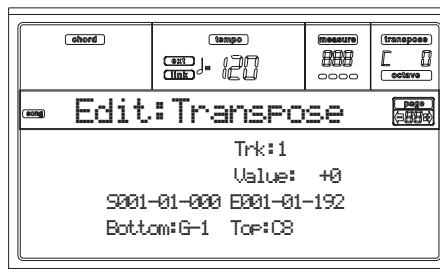

After setting the various parameters, press ENTER to execute. The "Are you sure?" message will appear. Press ENTER to confirm, EXIT to abort.

Trk (Track)

Use this parameter to select a track.

- All All tracks selected (apart for Drum tracks).
- 1...16 Selected track.

Value

Value of the transpose (in semitones).

S / E (Start/End)

Use these parameters to set the starting (S) and ending (E) points of the range to transpose.

If you wish to select a four-measure sequence starting at the beginning of the Song, the Start will be positioned at 1.01.000, and the End at 5.01.000.

Bottom / Top

Use these parameters to set the bottom and top of the keyboard range to transpose. If you select the same note as the Bottom and Top parameters, you can select a single percussive instrument in a Drum track.

PAGE 19 - EDIT: VELOCITY

Here you can change the Velocity value for the notes.

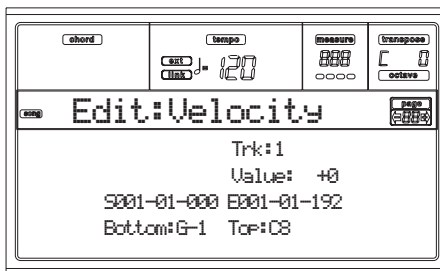

After setting the various parameters, press ENTER to execute. The "Are you sure?" message will appear. Press ENTER to confirm, EXIT to abort.

Trk (Track)

Use this parameter to select a track.

- All All tracks selected.
- 1...16 Selected track.

Value

Velocity change value.

S / E (Start/End)

Use these parameters to set the starting (S) and ending (E) points of the range to edit.

If you wish to select a four-measure sequence starting at the beginning of the Song, the Start will be positioned at 1.01.000, and the End at 5.01.000.

Bottom / Top

Use these parameters to set the bottom and top of the keyboard range to edit. If you select the same note as the Bottom and Top parameters, you can select a single percussive instrument in a Drum track.

PAGE 20 - EDIT: DELETE

This page is where you can delete MIDI events from the Song.

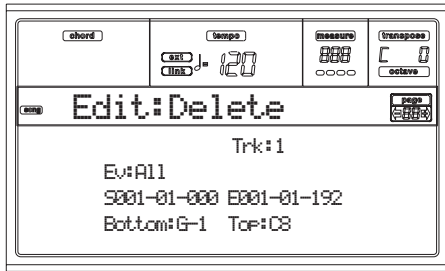

After setting the various parameters, press ENTER to execute. The “Are you sure?” message will appear. Press ENTER to confirm, EXIT to abort.

Trk (Track)

Use this parameter to select a track.

- All All tracks selected.
- 1...16 Selected track.
- Master Master track. This is where the Tempo, Scale and Effect events are recorded.

Ev (Event)

Type of MIDI event to delete.

- All All events. The measures will not be removed from the Song.
- Note All notes in the selected range.
- Dup.Note All duplicate notes. When two notes with the same pitch are encountered on the same tick, the one with the lowest velocity is deleted.
- A.Touch After Touch events.
- P.Bend Pitch Bend events.
- PrChange Program Change events, excluding the bundled Control Change #00 (Bank Select MSB) and #32 (Bank Select LSB).
- C.Change All Control Change events, for example Bank Select, Modulation, Damper, Soft Pedal...
- CC00/32...CC127 Single Control Change events. Double Control Change numbers (like 00/32) are MSB/LSB bundles.

S / E (Start/End)

Use these parameters to set the starting (S) and ending (E) points of the range to delete.

If you wish to select a four-measure sequence starting at the beginning of the Song, the Start will be positioned at 1.01.000, and the End at 5.01.000.

Bottom / Top

Use these parameters to set the bottom and top of the keyboard range to delete. If you select the same note as the Bottom and Top parameters, you can select a single percussive instrument in a Drum track.

Note: These parameters are available only when the All or Note options are selected.

PAGE 21 - EDIT: CUT MEASURES

In this page you can cut measures from the Song.



After selecting the Start and Length parameters, press ENTER to execute. The “Are you sure?” message will appear. Press ENTER to confirm, EXIT to abort.

After the cut, the following measure are moved back, to fill the cut measures.

Start

First measure where to begin cutting.

Length

Number of measures to be cut.

PAGE 22 - EDIT: INSERT MEASURES

In this page you can insert measures in the Song. You can also use this function to insert measures with a different meter (time signature).

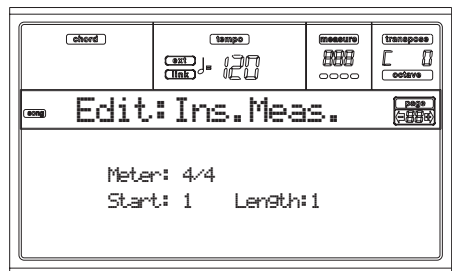

After selecting the Meter, Start and Length parameters, press ENTER to execute. The “Are you sure?” message will appear. Press ENTER to confirm, EXIT to abort.

Note: You cannot append measures after the end of the Song. To append measures use the Record or Copy function.

Note: You cannot use this function on an empty Song.

Meter

Meter of the measures to be inserted.

Start

First of the inserted measures.

Length

Number of measures to be inserted.

PAGE 23 - EDIT: COPY

Here you can copy tracks or phrases.

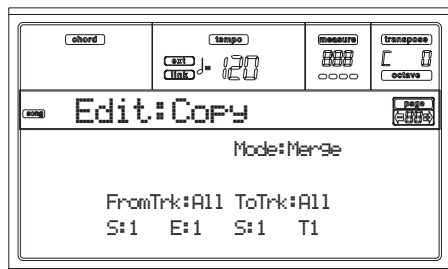

After setting the various parameters, press ENTER to execute. The “Are you sure?” message will appear. Press ENTER to confirm, EXIT to abort.

Note: If you copy too many events on the same “tick”, the “Too many events!” message appears, and the copy operation is aborted.

Mode

Use this parameter to select the Copy mode.

- Merge** Copied data are merged with the data at the target position.
- Overwrite** Copied data replace all data at the target position.

Warning: Deleted data cannot be recovered!

FromTrk (From Track)

ToTrk (To Track)

Use these parameters to select the source and target track to copy.

- All** All tracks. The target track cannot be selected.
- 1...16** Selected source and target tracks.

S/E

The left “S/E” parameters are the starting and ending measure to copy. For example, if S=1 and E=4, the first four measures are copied.

S

The right “S” parameter is the first of the target measures.

T

Number of times the copy must be executed.

PAGE 24 - EVENT EDIT

Enter this page from the Menu of the Song mode. The Event Edit page allows you to edit each event in a single track. See “Event Edit procedure” on page 104 for more information on the event editing procedure.



Event Type First value Second value

Trk (Track)

Track in edit. To select a different track, press one of the A VOLUME/VALUE buttons to open the Go To Track window.

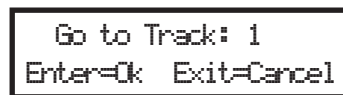

Use the TEMPO/VALUE controls to select a track, and press ENTER to confirm, or EXIT to abort.

1...16 One of the ordinary tracks of the Song. These tracks contains musical data, like notes and controllers.

Master This is a special track, containing Tempo changes, Meter changes, Scale and Transpose data, and the effect parameters.

Position

Position of the event shown in the display, expressed in the form ‘aaa.bb.ccc’:

- ‘aaa’ is the measure
- ‘bb’ is the beat
- ‘ccc’ is the tick (each quarter beat = 384 ticks)

You can edit this parameter to move the event to a different position.

Ev (Event)

Type and values of the event shown in the display. Depending on the selected event, the value may change. This parameter also shows the (non-editable) “End Of Track” marking, when the end of the track is reached.

Here are the events contained in ordinary tracks (1-16).

Event	First value	Second value
Note	Note name	Velocity
Prog	Program Change number	–
Ctrl	Control Change number	Control Change value
Bend	Bending value	–
Aftt	Mono (Channel) After-touch value	–
PAft	Note to which the After-touch is applied	Poly Aftertouch value

And here are the events contained in the Master track.

Event	First value	Second value
Tempo	Tempo change	-
Volume	Master Volume value	-
Meter	Meter change ^(a)	-
Scale	One of the available pre-set Scales	Root note for the selected Scale
UScale (User Scale)	One of the available User Scales	Root note for the selected Scale
QT (Quarter Tone)	Altered note	Note alteration ^(b)
QT Clear (Quarter Tone Clearing)	Reset of all Scale changes	-
FXType	One of the four available FX processors	Effect number ^(c)
FXSend	Feedback Send (B>A or D>C)	Feedback send level

(a) Meter changes can't be edited or inserted. To insert a Meter change, use the Insert function in the Edit section and insert a series of measures with the new meter. Existing data can then be copied or entered to these measures

(b) To edit the Quarter Tone settings, select the first value, then select the scale's degree to edit. Edit the second value to change the tuning of the selected note of the scale.

(c) When selecting a different effect number during this edit, default settings will be assigned to this event.

To change the event type, use the C VOLUME/VALUE buttons to select the Event line, then use the same buttons or the TEMPO/VALUE controls to select a different event type.

To select and edit the event's value, use the F3 and F4 function keys, and use the G/VOLUME/VALUE buttons or the TEMPO/VALUE controls.

Length

Length of the selected Note event. The value format is the same as the Position value.

Note: If you change a length of "000.00.000" to a different value, you can't go back to the original value. This rather uncommon zero-length value may be found in the drum and percussion tracks of Songs made in Backing Sequence mode.

Transport, navigation and editing controls

E/F and H VOLUME/VALUE buttons

These buttons are the "Scroll to previous event" and "Scroll to next event" controls. They corresponds to the scroll arrows shown on the screen.

G VOLUME/VALUE buttons

Use these buttons to select the corresponding parameter value area.

F3 and F4 buttons

After selecting the parameter value area with the G VOLUME/VALUE buttons, use these buttons to select, respectively, the first and second value of the event in edit.

SEQ1 PLAY/STOP button

Press PLAY/STOP to listen to the Song in edit. Press PLAY/STOP again to stop it.

SHIFT + << or >>

Keep the SHIFT button pressed and press the << or >> button to open the Go to Measure window.

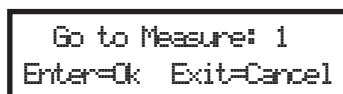

Use the TEMPO/VALUE controls to select a measure, and press ENTER to confirm, or EXIT to abort.

SHIFT + PAUSE

While the sequencer is running, keep the SHIFT button pressed, and press the PAUSE button to display the event that is currently playing. This is called the Catch Locator function.

INSERT

Press the INSERT button to insert a new event at the current shown Position. The default values are Type = Note, Pitch = C4, Velocity = 100, Length = 192.

Note: You can't insert new events in an empty, non-recorded Song. To insert an event, you must first insert some empty measures. To use the Insert function, press MENU and one of the F VOLUME/VALUE buttons, then press the PAGE+ button twice.

DELETE

Press the DELETE button to delete the event shown in the display.

PAGE 25 - EVENT FILTER

This page is where you can select the event types to be shown in the Event Edit page. You can access this page by pressing the PAGE+ button while in the Event Edit page.

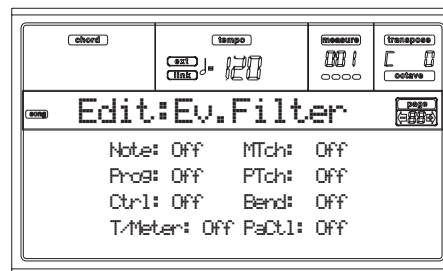

Turn On the filter for all event types you do not wish to see in the Event Edit page.

- Note Notes.
- Prog Program Change values.
- Ctrl Control Change events.
- T/Meter Tempo and Meter changes (Master Track only).
- Aft Mono (Channel) Aftertouch events.
- PAft Poly Aftertouch events.
- Bend Pitch Bend events.
- PaCtl Controls exclusive of the Pa50, like the FX and Scale settings. These controls are recorded to the Master Track, and saved as System Exclusive data.

EVENT EDIT PROCEDURE

The Event Edit is the page where you can edit each single MIDI event of the selected track. You can, for example, replace a note with a different one, or change its playing strength. Here is the general event editing procedure.

1. While in the Main page of the Song mode, load the Song to edit (see “Main page” on page 88). If a Song is already loaded or just recorded, this step is not needed.
2. Press MENU, and use one of the H VOLUME/VALUE buttons to select the Event Edit section. The Event Edit page appears (see “Page 24 - Event Edit” on page 102 for more information).

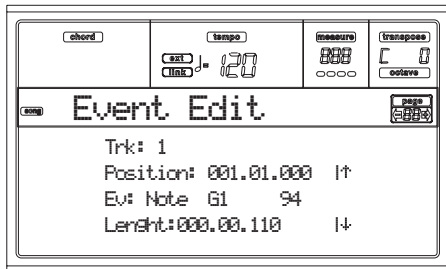

3. Press SEQ1 PLAY/STOP to listen to the Song. Press SEQ1 PLAY/STOP again to stop it.
4. Press PAGE+ to go to the Event Filter page, and turn “Off” the filter for the event types you wish to see in the display (see “Page 25 - Event Filter” on page 103 for more information).

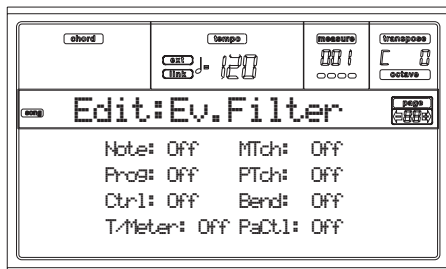

5. Press PAGE- to go back to the Event Edit page.
6. Press the A VOLUME/VALUE button (Trk), to select the track to edit. The Go To Track window appears.



Use the TEMPO/VALUE controls to select a track, and press ENTER to confirm (or EXIT to abort).

7. The list of events contained in the selected track will appear in the display.

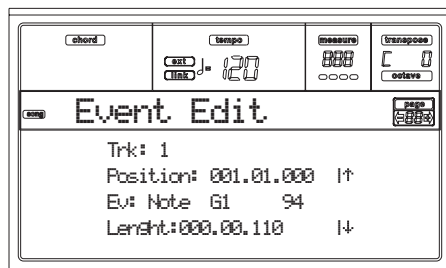

For more information on the event types and their values, see “Page 24 - Event Edit” below.

8. Use the B VOLUME/VALUE buttons to select the Position line. Use these buttons or the TEMPO/VALUE controls to change the event’s position.

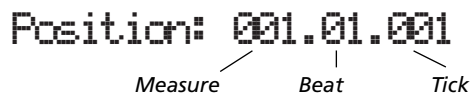

9. Use the C VOLUME/VALUE buttons to select the Event line. You may use the C VOLUME/VALUE buttons or the TEMPO/VALUE controls to change the event type. Use the G VOLUME/VALUE buttons, and the F3 and F4 function keys to respectively select the first and second value of the parameter. Use the G VOLUME/VALUE buttons or the TEMPO/VALUE controls to modify the selected value.



10. In the case of a Note event, use the D VOLUME/VALUE buttons to select the Length line, and use the same buttons, or the TEMPO/VALUE controls, to change the event’s length.

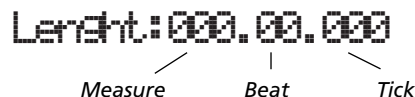

- After having modified the shown event, you may scroll to the next event with the H VOLUME/VALUE buttons (Scroll to next), or to the previous event with the E/F VOLUME/VALUE buttons (Scroll to previous).

- You may use the SHIFT + << or >> shortcut to go to a different measure (see “SHIFT + << or >>” on page 103)

- While the sequencer is running, you may use the SHIFT + PAUSE shortcut to move the current event in the display (see “SHIFT + PAUSE” on page 103).

- As described in step 3, you may press SEQ1 PLAY/STOP to listen to the Song, and press SEQ1 PLAY/STOP again to stop the sequencer.

11. Use the INSERT button to insert an event at the Position shown in the display (a Note event with default values will be inserted). Use the DELETE button to delete the event shown in the display.
12. When the editing is complete, you may select a different track (go to step 6).
13. When finished editing the whole Song, press EXIT to go back to the Main page of the Song mode, and select the Save Song command to save the Song on disk. See “Save Song page” on page 90 for more information on saving a Song.

14. PROGRAM OPERATING MODE

The Program operating mode is where you can listen to individual Programs, and edit them.

To select a Program, see the “Basic operations” chapter.

In this mode, the selected Program can always be played across the full keyboard range.

To automatically select the Program to be assigned to the last selected track, keep the SHIFT button pressed, and press the PROGRAM button.

Hint: This is useful to see the Bank Select/Program Change numbers when programming a Song on an external sequencer.

Note: The Program uses the same Scale of the latest selected Performance or STS.

MAIN PAGE

Here is the main page of the Program operating mode.

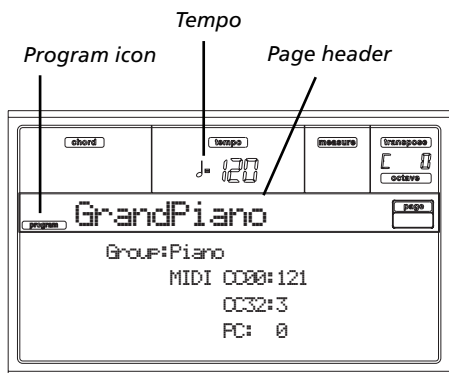

Program icon

When turned on, this icon shows that the instrument is in Program mode.

Page header

This line shows the selected Program name. Use the TEMPO/VALUE controls, or the PROGRAM/PERFORMANCE section to select a Program. (See “Selecting a Program” on page 26 for more information).

Tempo

This is the tempo of Sequencer 1. The Tempo is one of the AMSs (see “AMS (Alternate Modulation Source) list” on page 123). Use the SHIFT + DIAL combination to change it.

A (Group)

This non-editable parameter shows which group the Program is included into. A group is the equivalent of a PROGRAM/PERFORMANCE button.

B (CC00)

This non-editable parameter shows the value of the Control Change (CC) 00 message (or Bank Select MSB) for the selected Program.

C (CC32)

This non-editable parameter shows the value of the Control Change (CC) 32 message (a.k.a. Bank Select LSB) for the selected Program.

D (PC)

This non-editable parameter shows the value of the Program Change (PC) message for the selected Program. Values are in the standard 0-127 MIDI numbering format.

Note: Some manufacturers could use the 1-128 numbering system; when connecting your Pa50 to an instrument of this kind, increment the PC value by 1 unit.

Effects

In Program mode, the Program uses its own effects instead of relying on A-D effects. Two effect processors (FX1 and FX2) are available.

The MIDI channel

In Program mode, Pa50 receives and transmits on the same channel of the Upper 1 track. If the Global channel is assigned, notes can be received also on this channel. See “Page 6 - MIDI IN Channels” on page 127 and “Page 10 - MIDI OUT Channels” on page 129 for more information.

SOUND PROGRAMS AND DRUM PROGRAMS

Pa50 features two different kinds of Programs:

- Sound Programs. These are normal instrument Programs, like pianos, strings, basses.
- Drum Programs. These are drum and percussion kits, where each note of the keyboard is a different percussive instrument. You can find Drum Programs in the DRUM KIT and USER DK banks.

Before pressing MENU to enter the edit environment, you should select a Program of the type you wish to edit or create. Notes pointing to special Drum Program features are marked by the **DRUM** icon.

MENU

While in any other page of the Program operative mode, press MENU to open the Program edit menu. This menu gives access to the various Program edit sections.

When in the menu, select an edit section using the VOLUME/VALUE (A-G) buttons, select an edit page using PAGE +, or press EXIT to exit the menu.

When in an edit page, press EXIT to go back to the main page of the Program operating mode.

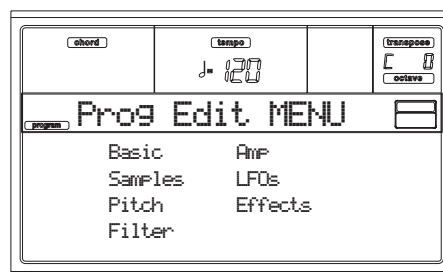

Each item in this menu corresponds to an edit section. Each edit section groups various edit pages.

EDIT PAGE STRUCTURE

Select an edit section from the Menu, and/or use the PAGE buttons to reach the desired page.

Press EXIT to go back to the main page of the Program mode.
All edit pages share the same structure.

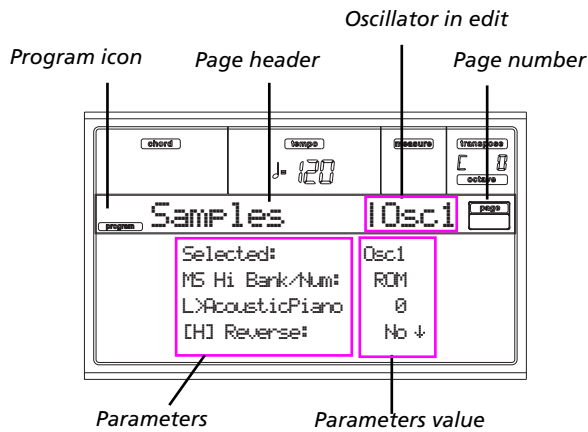

Program icon

When switched on, this icon shows that the instrument is in Program mode.

Page header

The header shows the name of the current edit page.

Oscillator in edit

When in an edit page where selecting an oscillator is required, this area shows the selected oscillator. Use the F1-F4 buttons to select one of the four available oscillators.

Page number

This area shows the current page number.

Parameters

Select an edit parameter using the A-D VOLUME/VALUE buttons. You can scroll the parameter list using the E-F (Scroll Up) and G-H (Scroll Down) VOLUME/VALUE buttons.

Parameter value

Use the A-D VOLUME/VALUE buttons, or the TEMPO/VALUE controls, to change the parameter value.

THE COMPARE FUNCTION

While in edit, you can compare the current Program with its original values. You cannot edit the Program while you are in Compare mode.

- Keep the SHIFT button pressed, and press ENTER to enter the Compare function. The PROGRAM LED begins flashing. Play on the keyboard to listen to the original Program.
- Press SHITF + ENTER again to exit the Compare mode and return to the edited Program.

HOW TO SELECT OSCILLATORS

While in an edit page requiring an oscillator to be selected for editing, use the F1-F4 buttons to select one of the available oscillators.

ERASE PROGRAM/OSCILLATOR

You can initialize any parameter value, by using one of the following shortcuts:

- While in the Basic page, keep the SHIFT button pressed, and press the DELETE button to initialize the whole Program to a default status.
- While in an edit page where the “Osc” abbreviation appears in the upper right area of the display, keep the SHIFT button pressed, and press the DELETE button to initialize the currently selected oscillator to a default status

After you press the shortcut, the “Init osc?” message appears. Press ENTER to confirm, EXIT to abort.

THE ‘WRITE’ WINDOW

This page appears when you press the WRITE button. Here you can save the Program into a User Program location in memory.

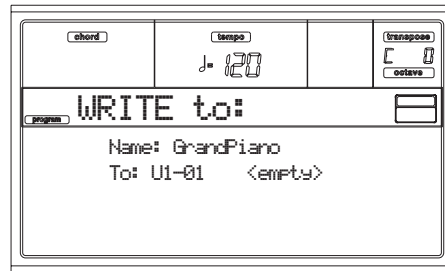

1. Select a name and a location, then press ENTER to save the Program.
2. The “Are you sure?” message appears. Press ENTER to confirm, or EXIT to abort.

Warning: If you write over an existing User Program, the Program will be deleted and replaced by the one you are saving (“overwrite”). Please save on disk any Program you don’t want to lose.

Name

Use this parameter to change the Program’s name. Press the right A VOLUME/VALUE button to enter editing. Modify the name using the UP/DOWN buttons to move the cursor, and the DIAL to select a character. Press INSERT to insert a character at the cursor position, or DELETE to delete it

To (Location number)

Use the B VOLUME/VALUE buttons to select a different User Program location in memory. Otherwise, select this parameter and use the VOLUME/VALUE controls to select the location.

Note: You can’t save over a Factory Program location.

PAGE 1 - BASIC

Here you can make basic settings for the Program, such as basic oscillator settings, the oscillator count, and the polyphonic mode.

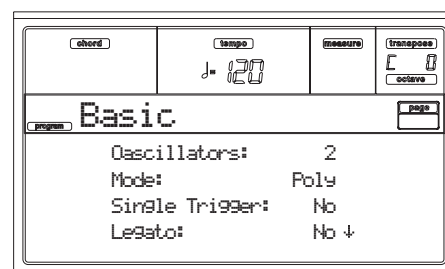

Oscillators

Use this parameter to specify the basic Program type; whether it will use one or more oscillators (up to four).

DRUM Drum Programs use only one oscillator.

1...4 Number of oscillators the Program will use. The total amount of polyphony varies depending on the number of oscillators used by the Program (a maximum of 62 with only 1 oscillator, or a maximum of 15 with 4 oscillators).

Mode

This is the polyphonic mode of the Program.

Poly The Program will play polyphonically, allowing you play chords.

Mono The Program will play monophonically, producing only one note at a time.

Single Trigger

This parameter is available when the “Mode” parameter is set to Poly.

Yes When the same note is played repeatedly, the previous note will be silenced before the next note is sounded, so that the notes do not overlap.

No When the same note is played repeatedly, the previous note will not be silenced before the next note is sounded.

Legato

This parameter is available when the “Mode” parameter is set to Mono.

Yes Legato is on. When multiple note-on's occur, the first note-on will retrigger the sound, and the second and subsequent note-on's will not retrigger. When legato is on, multiple note-on's will not retrigger the voice. If one note is already on and another note is turned on, the first voice will continue sounding. The oscillator sound, envelope, and LFO will not be reset, and only the pitch of the oscillator will be updated. This setting is effective for wind instrument sounds and analog synth-type sounds.

No Legato is off. Notes will always be retriggered when note-on occurs. When legato is off, multiple note-on's will retrigger the voice at each note-on. The oscillator sound, envelope, and LFO will be reset (and retriggered) according to the settings of the Program.

Note: If “Legato” is On, certain multisamples or keyboard locations may produce an incorrect pitch.

Priority

This parameter is available when the “Mode” parameter is set to Mono. It specifies which note will be given priority to play when two or more notes are played simultaneously.

Low Lowest note will take priority.

High Highest note will take priority.

Last Last note will take priority.

PAGE 2 - SAMPLE (SOUND PROGRAMS)

The multisample(s) (waveform) on which the Program will be based can be selected here for each of the four oscillators. Each oscillator can use 1 or 2 multisamples, each one assigned to the High or Low layer.

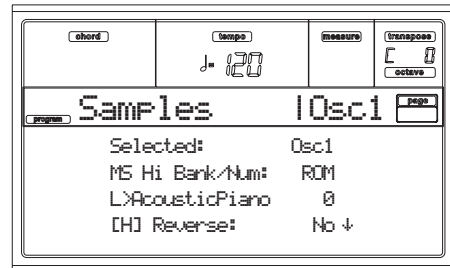

The internal Flash-ROM contains 340 different multisamples (preset multisamples).

Selected

Use this parameter to select an oscillator to put in edit. Alternatively, you can select oscillators using the F1-F4 buttons.

MS Hi/Lo Bank/Num

Use these parameters to select a different multisample for each of the High and Low layers. You can use velocity to switch between the two multisamples. Reverse, Offset and Level can be adjusted independently for the High and Low multisamples.

The first line shows the bank (ROM), while the second line is for selecting the multisample. The Program number appears at the end of the second line.

The multisample you select for the High layer will be triggered by velocities higher than the value of the “Velocity Switch” parameter (see page 14-108). If you do not wish to use velocity switching, set the switch to a value of 001, and select only the High multisample.

Note: Each multisample has an upper limit, and may not produce sound when played above that limit.

[H/L] Reverse

The multisample will be played in reverse. In the case of Flash-ROM multisamples that were originally specified to loop, the multisample will be played back in “one-shot” reverse mode. If the multisample was originally set to reverse, it will playback without change.

Yes The multisample will playback in reverse.

No The multisample will play back normally.

[H/L] Use Offset

These parameters specify the point where the multisample(s) will begin to play. For some multisamples this parameter will not be available.

Yes The sound will begin from the offset location pre-determined for each multisample.

No The sound will start from the beginning of the multisample waveform.

[H/L] Level

These parameters specify the level of each multisample.

0...127 Multisample level.

Note: Depending on the multisample, high settings of this parameter may cause the sound to distort when a chord is played. If this occurs, lower the level.

Velocity Switch

This is the velocity value dividing the High and Low layers for the selected oscillator. Notes struck harder than this value will be played by the High multisample.

V-Zone Top/Bottom (Velocity Zone)

Here you can specify the velocity range for the selected oscillator.

Note: You cannot set the Bottom Velocity higher than the Top Velocity, nor the Top Velocity lower than the Bottom Velocity.

0...127 Assigned velocity.

Octave

Use this parameter to adjust the pitch of the selected oscillator in octave units. The normal octave of the multisample is "0".

-2...+1 Octave transposition.

Transpose

Use this parameter to adjust the pitch of the selected oscillator in semitone steps over a range of ± 1 octave.

-12...+12 Transposition in semitones.

Tune

Use this parameter to adjust the pitch of the sample in one-cent steps (a semitone is 100 cents) over a range of ± 1 octave.

-1200...+1200
Fine-tune value in cents.

Delay (ms)

This parameter sets a delay time from the note-on to the real beginning of the sound. With a setting of KeyOff, the sound will begin when note-off occurs. This is useful to create sounds such as the "click" that is heard when a harpsichord note is released. In this case, set the "Sustain Level" parameter to 0 (see page 14-115).

Key Off The sound will begin when the note is released.
0...5000 Delay time in milliseconds.

PAGE 2 - DK SAMPLES (DRUM PROGRAMS)

This page appears when you edit a Drum Program. Here you can select a different percussive sample for each layer (High and Low) on each key.

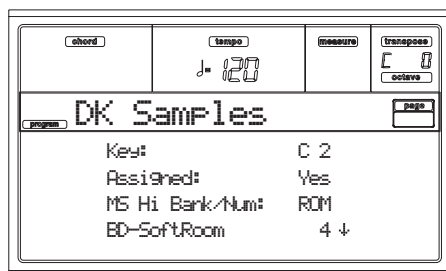

Key

Key in edit. You can press a key on the keyboard to select a key.

Assigned

Use this parameter to turn the sample on/off.

Yes The sample is assigned to the selected key.

No The sample is not assigned. The sample assigned to the next highest assigned key is used instead.

MS Hi/Lo Bank/Num

Use these parameters to select a different multisample (drum kit) for each of the High and Low layers. For more information, see "MS Hi/Lo Bank/Num" on page 107.

[H/L] Level

These parameters specify the level of each multisample. For more information, see "[H/L] Level" on page 107.

[H/L] Transpose

These parameters transpose the selected multisample. Use them to change the pitch of the selected key.

0 No transposition applied.

-64...+63 Transpose value in semitones.

[H/L] Tune

Use these parameters to fine-tune the assigned sample.

0 No fine-tuning.

-99...+99 Fine-tuning value in cents (1/100 of a semitone).

[H/L] Reverse

The multisample will be played in reverse. For more information see "[H/L] Reverse" on page 107.

[H/L] Use Offset

These parameters specify the point where the multisample(s) will begin to play. For more information see "[H/L] Use Offset" on page 107.

[H/L] Cutoff

These parameters set the cutoff frequency for the filter applied to the selected sample.

[H/L] Resonance

These parameters set the resonance for the filter applied to the selected sample.

[H/L] Attack

These parameters are an offset to the selected sample's EG Attack.

[H/L] Decay

These parameters are an offset to the selected sample's EG Decay.

Velocity Switch

This is the velocity value dividing the High and Low layers for the selected sample/key. Notes stricken harder than this value will be played by the High multisample.

Single Trigger

Use this parameter to set the sample as a single-triggered one.

Yes When the same key (note) is played repeatedly, the previous note will be stopped before the new note is triggered, so that they will not overlap.

No When the same key (note) is played repeatedly, the previous note will not be stopped before the new note is triggered.

Receive Note On

Use this parameter to enable/disable the reception of the Note On (Key On) message.

Yes The Note On message is normally received.

No The Note On message is not received. Therefore, the corresponding key is muted.

Receive Note Off

Use this parameter to enable/disable the reception of the Note Off (Key Off) message.

- Yes The sound will stop as soon as you release the key.
- No The sound will continue playing up to the end of the sample. The Note Off message is ignored.

Warning: If the “Single Trigger” parameter is set to No, and the sound is looped, the sound will play endlessly. In an “emergency” situation, use the Panic command (see “START/STOP” on page 15).

Exclusive Group

Exclusive Groups are sets of mutually exclusive keys, stopping each other. For example, if the Open Hi-Hat and Closed Hi-Hat are assigned the same Exclusive Group, playing an Open Hi-Hat will stop the Closed Hi-Hat playing.

- None No Exclusive Group assigned. The selected key will not be stopped by any other key.
- 1...127 Exclusive Groups assigned to the selected key. When you play this key, all other keys assigned to the same Exclusive Group will be stopped, and this key will be stopped by other keys assigned to the same Exclusive Group.

Pan

This parameter sets the position in the stereo panorama of the selected key.

Send FX1

This parameter sets the FX1 send level for of the selected key.

Send FX2

This parameter sets the FX2 send level for of the selected key.

PAGE 3 - PITCH

Here you can make pitch settings for each oscillator. These settings specify how keyboard location will affect the pitch of each oscillator, and select the controllers that will affect the oscillator pitch and specify the depth of control. You can also specify the amount of pitch change produced by the Pitch EG and by LFO1 and LFO2, switch portamento on/off and specify how it will apply.

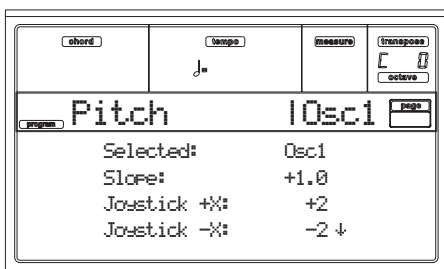

Selected

Use this parameter to select an oscillator to put in edit. Alternatively, you can select oscillators using the F1-F4 buttons.

Slope

Normally you will leave this parameter at +1.0. Positive (+) values will cause the pitch to rise as you play higher notes,

and negative (-) values will cause the pitch to fall as you play higher notes.

With a value of 0, there will be no change in pitch, and the C4 pitch will sound regardless of the keyboard location you play.

The diagram shows how the Pitch Slope and pitch are related:

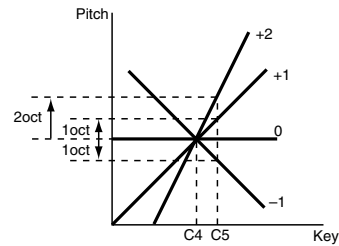

-1.0...+2.0 Pitch slope value.

JS (+X)

This parameter specifies how the pitch will change when the joystick is moved all the way to the right. A setting of 12 produces 1 octave of change.

For example if you set this to +12 and move the joystick all the way to the right, the pitch will rise one octave above the original pitch.

-60...+12 Maximum pitch change in semitones.

JS (-X)

This parameter specifies how the pitch will change when the joystick is moved all the way to the left. A setting of 12 produces 1 octave of change.

For example, if you set this to -60 and move the joystick all the way to the left, the pitch will fall five octaves below the original pitch. This can be used to simulate the downward swoops that a guitarist produces using the tremolo arm.

-60...+12 Maximum pitch change in semitones.

Pitch modulation

AMS (Alternate Modulation Source)

This parameter selects the source that will modulate the pitch of the selected oscillator. See “AMS (Alternate Modulation Source) list” on page 123.

Intensity

This parameter specifies the depth and direction of the effect produced by “AMS”. With a setting of 0, no modulation will be applied. With a setting of 12.00, the pitch will change up to one octave.

For example, if you set “AMS” to Joystick +Y and push the joystick, the pitch will rise if this parameter is set to a positive (+) value, or fall if this parameter is set to a negative (-) value. The range is a maximum of one octave.

-12.00...+12.00

Parameter value.

Pitch EG modulation

EG Intensity

This parameter specifies the depth and direction of the modulation that the pitch EG specified on “Page 6 - Pitch EG” will apply to the pitch. With a setting of 12.00, the pitch will change a maximum of ±1 octave.

-12.00...+12.00

Parameter value.

EG AMS (EG Alternate Modulation Source)

This parameter selects the source that will modulate the pitch EG of the selected oscillator. See “AMS (Alternate Modulation Source) list” on page 123).

Intensity (AMS Intensity)

This parameter specifies the depth and direction of the effect that “AMS” will have. For example, if you set “AMS” to Velocity and set this value to +12.00, the velocity will control the range of pitch change produced by the pitch EG in a range of ±1 octave. As you play more softly, the pitch change will draw closer to the pitch EG levels.

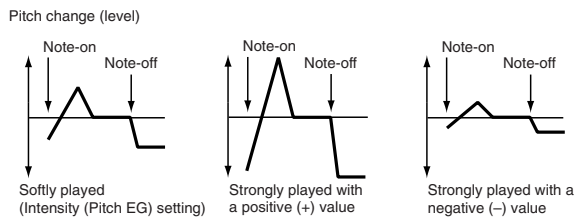

Note: “Intensity” (Pitch EG) and AMS will be added to determine the depth and direction of the pitch modulation applied by the pitch EG.

Portamento

Portamento

This parameter turns the portamento effect (smooth change in pitch from one note to the next) on/off, and specifies how it will be applied.

Note: Portamento will also be switched when CC#65 (Portamento SW) is received.

- On Portamento will be applied.
- Off Portamento will not be applied.

Portamento Time

This parameter sets the portamento time. Increasing the value will produce a slower change in pitch.

000...127 Portamento time in MIDI value.

PAGE 4 - PITCH LFO1

In this page you can set the LFO1 modulation parameters for the selected oscillator.

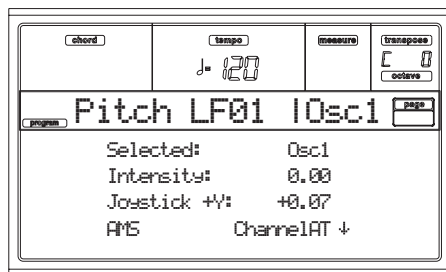

Selected

Use this parameter to select an oscillator to put in edit. Alternatively, you can select oscillators using the F1-F4 buttons.

Intensity

This parameter specifies the depth and direction of the pitch modulation applied by the LFO1 settings you made on “Page 17 - LFO1”. With a setting of 12.00, a maximum of ±1 octave

of pitch modulation will be applied. Negative (-) values will invert the LFO waveform.

-12.00...+12.00

Intensity depth and direction.

JS+Y (JoyStick +Y)

This parameter specifies the depth and direction of the effect that joystick movement in the +Y direction (away from yourself) will have on the pitch modulation applied by the LFO1. As this value is increased, moving the joystick in the +Y direction will cause the LFO1 to produce deeper pitch modulation. With a setting of 12.00 a maximum of ±1 octave of pitch modulation will be applied. Negative (-) values will invert the LFO waveform.

-12.00...+12.00

Joystick action depth.

Pitch LFO1 ‘Level’ modulation

AMS (Alternate Modulation Source)

This parameter selects the source that will control the depth of pitch modulation produced by the LFO1. See “AMS (Alternate Modulation Source) list” on page 123.

Intensity

This parameter specifies the depth and direction of the effect that “AMS” will have. With a setting of 0, modulation will not be applied. With a setting of 12.00, the LFO1 will apply a maximum of ±1 octave of pitch modulation. Negative (-) settings will invert the LFO waveform.

For example if “AMS” is set to Joystick +Y and push the joystick, a positive (+) setting of this parameter will cause the pitch modulation created by LFO1 to be applied with the normal phase, and a negative (-) setting will cause the LFO to be applied with inverted phase.

The “LFO1 Intensity”, “JS+Y” and “AMS” settings will be added to determine the depth and direction of the pitch modulation applied by LFO1.

-12.00...+12.00

Parameter value.

PAGE 5 - PITCH LFO2

In this page you can set the LFO2 modulation parameters for the selected oscillator. See “Page 4 - Pitch LFO1” for information on the various parameters.



PAGE 6 - PITCH EG

Here you can make settings for the pitch EG, which creates time-variant changes in the pitch of the oscillators. The depth of pitch change produced by these EG settings on the oscilla-

tors is adjusted by the “Intensity (AMS1/2 Intensity)” parameter (see page 14-111).

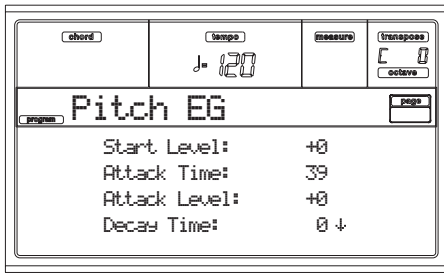

Pitch envelope

Time-varying pitch settings (when Pitch EG Intensity = +12.00)

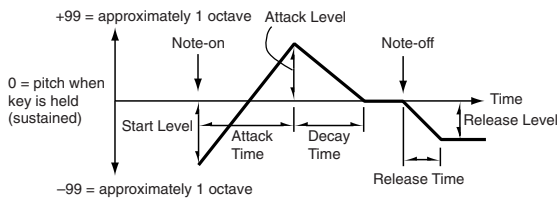

Start/Attack/Decay/Release Level

These parameters specify the amount of pitch change. The actual amount of pitch change will depend on the “Intensity (AMS1/2 Intensity)” parameter (see below). For example, with an “Intensity” setting of +12.00, a “Level” setting of +99 would raise the pitch one octave, and a “Level” setting of -99 would lower the pitch one octave.

-99...+99 Parameter value.

Start Level

Specifies the amount of pitch change at note-on.

Attack Level

Specifies the amount of pitch change when the attack time has elapsed.

Release Level

Specifies the amount of pitch change when the release time has elapsed.

Attack/Decay/Release Time

These parameters specify the time over which the pitch change will occur.

0...99 Parameter value.

Attack Time

Specifies the time over which the pitch will change from note-on until it reaches the pitch specified as the attack level.

Decay Time

Specifies the time over which the pitch will change after reaching the attack level until it reaches the normal pitch.

Release Time

Specifies the time over which the pitch will change from note-off until it reaches the pitch specified as the release level.

Pitch EG ‘Level’ modulation

Pitch EG change (level) (AMS=JS-Y/Velocity, Intensity= positive (+) value)

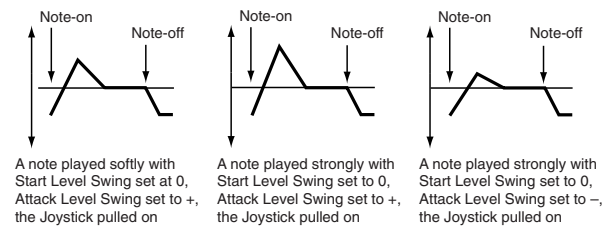

AMS1/2 (L) (Alternate Modulation Source 1/2)

These parameters select the source that will control the pitch EG “Level” parameters (“AMS (Alternate Modulation Source) list” on page 123).

Intensity (AMS1/2 Intensity)

These parameters specify the depth and direction of the effect applied by “AMS1”. With a setting of 0, the levels specified by “Start/Attack/Decay/Release Level” will be used.

For example if “AMS1” is Joystick +Y, pushing the joystick to turn it on will change the “Level” parameters of the Pitch EG. As the absolute value of “Intensity” is increased, the pitch EG levels will change more greatly when the joystick is released. The direction of the change is specified by “Start Level Swing” and “Attack Level Swing”. When the key pressure is released, the pitch EG levels will return to their own settings. If “AMS1” is set to Velocity, increasing the absolute value of “Intensity” will produce increasingly wider change in pitch EG levels for strongly-played notes. The direction of the change is specified by “Start Level Swing” and “Attack Level Swing”. As you play more softly, the pitch change will draw closer to the pitch EG levels.

-99...+99 Parameter value.

Start Level Swing

This parameter specifies the direction of change in “Start Level” caused by “AMS1/2”. If “Intensity” is a positive (+) value, a setting of + will raise the EG level, and a setting of - will decrease it. With a setting of 0 there will be no change.

Attack Level Swing

This parameter specifies the direction of change in “Attack Level” caused by “AMS1/2”. If “Intensity” is a positive (+) value, a setting of + will raise the EG level, and a setting of - will decrease it. With a setting of 0 there will be no change.

Pitch EG ‘Time’ modulation

Pitch EG changes (Time) (AMS = Velocity, Intensity = positive (+) value)

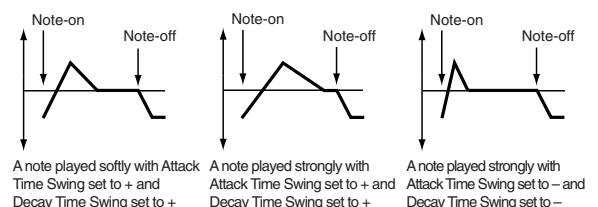

AMS(T) (Alternate Modulation Source)

This parameter selects the source that will control the “Time” parameters of the pitch EG (see “AMS (Alternate Modulation Source) list” on page 123).

Intensity (AMS(T) Intensity)

This parameter specifies the depth and direction of the effect that “AMS” will have on the “Time” parameters. With a set-

ting of 0, the pitch EG times will be just as specified by the "Attack/Decay/Release Time" settings.

The alternate modulation value at the moment that the EG reaches each point will determine the actual value of the EG time that comes next.

For example, the decay time will be determined by the alternate modulation value at the moment that the attack level is reached.

When this parameter is set to values of 16, 33, 49, 66, 82, or 99, the specified EG times will speed up as much as 2, 4, 8, 16, 32, or 64 times respectively (or slowed down to 1/2, 1/4, 1/8, 1/16, 1/32, or 1/64 of the original time).

For example if "AMS" is set to Velocity, increasing the absolute value of "Intensity" will allow strongly-played notes to increase the changes in pitch EG "Time" values. The direction of the change is specified by "Attack Time Swing" and "Decay Time Swing". As you play more softly, the pitch EG times will more closely approach the actual settings of the pitch EG.

-99...+99 Parameter value.

Attack Time Swing

This parameter specifies the direction in which "AMS" will affect the "Attack Time" parameter. With positive (+) values of "Intensity", a setting of + will cause the time to be lengthened, and a setting of - will cause the time to be shortened. With a setting of 0 there will be no change.

Decay Time Swing

Specify the direction in which "AMS" will affect the "Decay Time". With positive (+) values of "Intensity", a setting of + will cause the time to be lengthened, and a setting of - will cause the time to be shortened. With a setting of 0 there will be no change.

PAGE 7 - FILTER

Here you can make settings for the filters that will be used by the oscillators. You can select either a 24 dB/octave low pass filter with resonance, or a series connection of a 12 dB/octave low pass filter and a 12 dB/octave high pass filter.

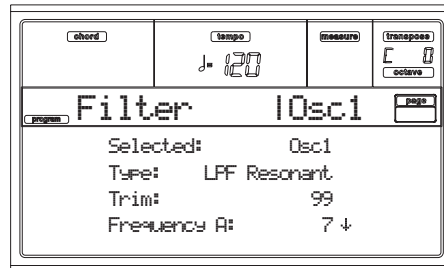

Selected

Use this parameter to select an oscillator to put in edit. Alternatively, you can select oscillators using the F1-F4 buttons.

Filter Type

This parameter selects the type of filter (Low Pass Resonant, Low Pass & High Pass) for the selected oscillator. When the Low Pass & High Pass filter type is selected, the filter B will be activated.

Low Pass Resonance: 24 dB/octave low pass filter with resonance

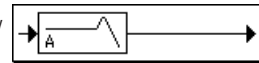

Low Pass & High Pass: 12 dB/octave low pass filter and 12 dB/octave high pass filter in series

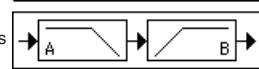

Trim

Use this parameter to adjust the level at which the audio signal output from the selected oscillator is input to filter A.

Note: If this value is raised, the sound may distort if Resonance is set to a high value or when you play a chord.

00...99 Trim level.

Frequency A (Cutoff Frequency A)

This parameter specifies the cutoff frequency of filter A.

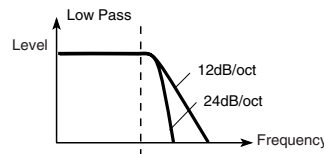

This is a filter that cuts the high-frequency region above the cutoff frequency. This is the most common type of filter, and is used to cut part of the overtone components, making an originally bright timbre sound more mellow (darker). When the "Filter Type" is Low Pass Resonance, the cutoff will have a steeper slope.

00...99 Cutoff frequency value.

Resonance A

The resonance emphasizes the overtone components that lie in the region of the cutoff frequency specified by "Frequency", producing a more distinctive sound. Increasing this value will produce a stronger effect.

00...99 Resonance value.

Resonance modulation

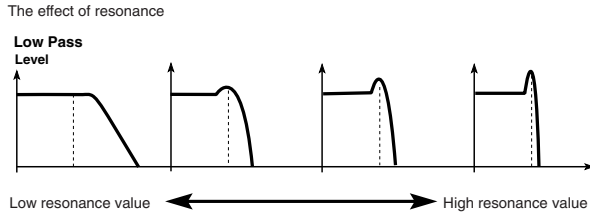

AMS (Alternate Modulation Source)

Selects the source that will control the “Resonance” level. See “AMS (Alternate Modulation Source) list” on page 123.

Intensity (AMS Intensity)

This parameter specifies the depth and direction of the effect that “AMS (Alternate Modulation Source)” will have on the resonance level specified by “Resonance A”.

For example if Velocity has been selected, changes in keyboard velocity will affect the resonance.

With positive (+) values, the resonance will increase as you play more strongly, and as you play more softly the resonance will approach the level specified by the “Resonance” setting.

With negative (-) values, the resonance will decrease as you play more strongly, and as you play more softly the resonance will approach the level specified by the “Resonance” setting.

The resonance level is determined by adding the “Resonance” and “Intensity (AMS Intensity)” values.

-99...+99 Parameter value.

Filter B

Frequency B (Cutoff Frequency B)

This parameter specifies the cutoff frequency of filter B. This parameter will be displayed when “Filter Type” is set to Low Pass & High Pass.

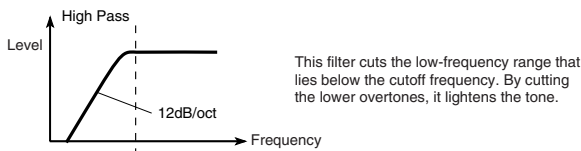

00...99 Cutoff frequency value.

PAGE 8 - FILTER MODULATION

These settings let you apply modulation to the cutoff frequency (“Frequency”) of the filter for the selected oscillator to modify the tone.

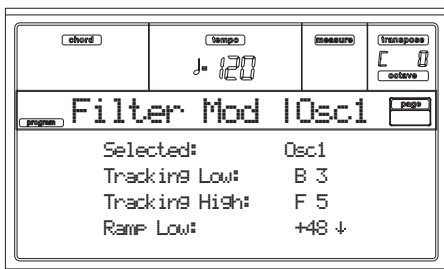

When “Filter Type” is Low Pass Resonance, parameters for filter B will not be editable (greyed out).

Selected

Use this parameter to select an oscillator to put in edit. Alternatively, you can select oscillators using the F1-F4 buttons.

Filter keyboard tracking

Tracking Low/High

These settings specify keyboard tracking for the cutoff frequency of the filter for the selected oscillator. The way in which the cutoff frequency is affected by the keyboard location you play can be specified by the “Tracking Low”, “Tracking High”, “Ramp Low” and “Ramp High” parameters.

C-1...G9 Lowest/Highest note in the range.

Tracking Low

Keyboard tracking will apply to the range below the specified note number.

Tracking High

Keyboard tracking will apply to the range above the specified note number.

Ramp

This parameter specifies the angle of keyboard tracking.

-99...+99 Angle value.

Here is how cutoff frequency is affected by keyboard location and the Ramp setting (“Intensity to A” and “Intensity to B” = +50):

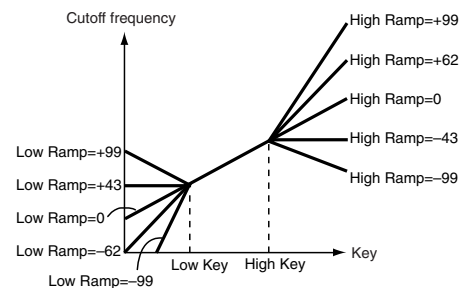

Ramp Low

Ramp High

If “Intensity to A” and “Intensity to B” are set to +50, “Ramp Low” is set to -62 and “Ramp High” is set to +62, the angle of the change in cutoff frequency will correspond to the keyboard location (pitch). This means that the oscillation that occurs when you increase the “Resonance A” will correspond to the keyboard location.

If you set “Ramp Low” to +43 and “Ramp High” to -43, the cutoff frequency will not be affected by keyboard location.

Use this setting when you do not want the cutoff frequency to change for each note.

Tracking to A/B

These parameters specify the note numbers at which keyboard tracking will begin to apply, and set the “Intensity to A” and “Intensity to B” parameters to specify the depth and direction of the change applied to filters A and B.

For the range of notes between “Key Low” and “Key High”, the cutoff frequency will change according to the keyboard location (pitch).

-99...+99 Parameter value.

Filter EG modulation

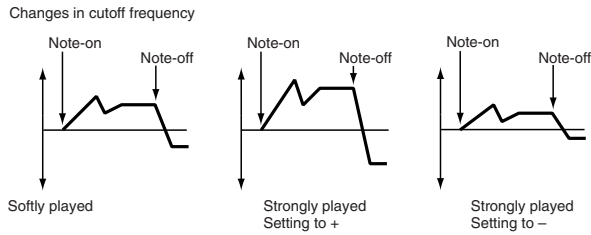

Velocity to A

This parameter specifies the depth and direction of the effect that velocity will have on the time-varying changes created by the filter EG (as set on “Page 11 - Filter EG”) to control the filter A cutoff frequency.

With positive (+) values, playing more strongly will cause the filter EG to produce greater changes in cutoff frequency. With negative (-) values, playing more strongly will also cause the filter EG to produce greater changes in cutoff frequency, but with the polarity of the EG inverted.

99...+99 Value of the Velocity to A parameter.

Velocity to B

This parameter specifies the depth and direction of the effect that velocity will have on the time-varying changes created by the filter EG to control the filter B cutoff frequency (see “Velocity to A”).

99...+99 Value of the Velocity to B parameter.

EG Intensity to A

Specifies the depth and direction of the effect that the time-varying changes created by the filter 1 EG will have on the filter A cutoff frequency.

With positive (+) settings, the sound will become brighter when the EG levels set by Filter EG “Level” and “Time” parameters are in the “+” area, and darker when they are in the “-” area.

With negative (-) settings, the sound will become darker when the EG levels set by Filter EG “Level” and “Time” parameters are in the “+” area, and brighter when they are in the “-” area.

-99...+99 Parameter value.

EG Intensity to B

Specifies the depth and direction of the effect that the time-varying changes created by the filter EG will have on the filter B cutoff frequency (see “EG Intensity to A”).

-99...+99 Parameter value.

EG AMS (Alternate Modulation Source)

Selects the source that will control the depth and direction of the effect that the time-varying changes produced by the filter EG will have on the cutoff frequency of filters A and B. See “AMS (Alternate Modulation Source) list” on page 123.

Intensity to A

Specifies the depth and direction of the effect that “AMS” will have on filter A. For details on how this will apply, refer to “EG Intensity to A”.

Intensity to B

Specifies the depth and direction of the effect that “AMS” will have on filter B. For details on how this will apply, refer to “EG Intensity to A”.

Note: The sum of the settings for “Velocity to A/B”; “Intensity to A/B”; and “(AMS) Intensity to A/B” will determine the depth and direction of the effect produced by the filter EG.

Filter A/B modulation

AMS1(fA/B) (Alternate Modulation Source1 for filter A/B)

Selects the source that will control modulation of the filter A cutoff frequency. See “AMS (Alternate Modulation Source) list” on page 123.

Note: The filter B parameters will be displayed when “Filter Type” on page 112 is Low Pass & High Pass.

Intensity

Specifies the depth and direction of the effect that “AMS1” will have.

When “AMS1” is JS X, a positive (+) value for this parameter will cause the cutoff frequency to rise when the joystick is moved toward the right, and fall when the joystick is moved toward the left. With a negative (-) value for this parameter, the opposite will occur.

This value is added to the setting of the Filter A “Frequency”.

AMS2 (Alternate Modulation Source2)

Selects the source that will control modulation of the filter A cutoff frequency (see “AMS (Alternate Modulation Source) list” on page 123).

Intensity

Specifies the depth and direction of the effect that the selected source will have (see “Intensity” on page 114).

PAGE 9 - FILTER LFO1

Here you can use the filter LFO to apply cyclic modulation to the cutoff frequency of the filter (for the selected oscillator) to create cyclical changes in tone.

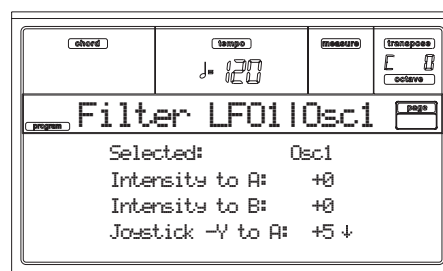

Selected

Use this parameter to select an oscillator to put in edit. Alternatively, you can select oscillators using the F1-F4 buttons.

Intensity to A

Specifies the depth and direction of the modulation that LFO1 (set on “Page 17 - LFO1”) will have on the cutoff frequency of filter A. Negative (-) settings will invert the phase.

-99...+99 Parameter value.

Intensity to B

Specify the depth and direction of the modulation that LFO1 will have on the cutoff frequency of filter B (see “Intensity to A”).

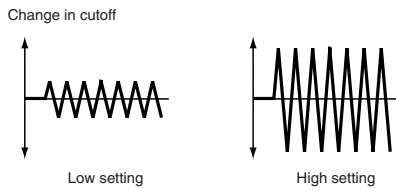

-99...+99 Parameter value.

Joystick -Y to A

By moving the joystick in the Y direction (toward yourself), you can control the depth at which LFO1 modulates the cut-off frequency of filter A. This parameter specifies the depth and direction of the control.

Higher settings of this parameter will produce greater increases in the effect of LFO1 on the filter when the joystick is moved toward yourself.

-99...+99 Parameter value.

Joystick -Y to B

By moving the joystick in the Y direction (toward yourself), you can control the depth at which LFO1 modulates the cut-off frequency of filter B. This parameter specifies the depth and direction of the control (see “Joystick -Y to A”).

Filter LFO1 modulation

AMS (Alternate Modulation Source)

Select a source that will control the depth and direction of cutoff frequency change for both filters A and B. See “AMS (Alternate Modulation Source) list”.

Intensity to A

Specifies the depth and direction of the effect that “AMS” will have on filter A.

For example if “AMS” is Joystick +Y, higher settings of this parameter will allow greater change to be applied to LFO1 when you push the joystick.

-99...+99 Parameter value.

Intensity to B

Specifies the depth and direction of the effect that “AMS” will have on filter B (see “Intensity to A”).

PAGE 10 - FILTER LFO2

Adjusts the depth of the cyclic modulation applied by LFO2 (set on “Page 18 - LFO2”) to the cutoff frequency of filters A and B. For more information on the parameters see “Page 9 - Filter LFO1” on page 114.

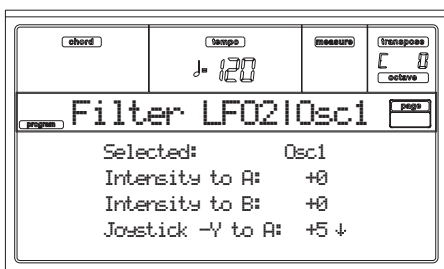

PAGE 11 - FILTER EG

Here you can make settings for the EG that will produce time-varying changes in the cutoff frequency of filters A and B for the selected oscillator. The depth of the effect that these settings will have on the filter cutoff frequency is determined by the “Velocity” and “Intensity” parameters.

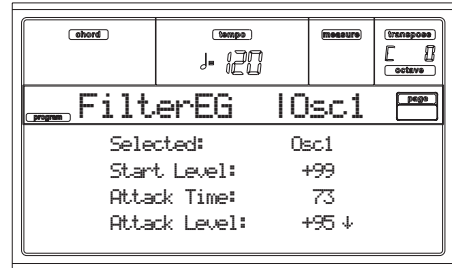

Selected

Use this parameter to select an oscillator to put in edit. Alternatively, you can select oscillators using the F1-F4 buttons.

Filter envelope

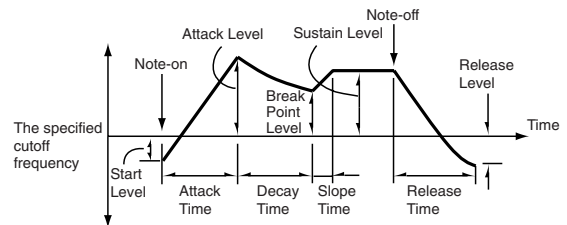

Start/Attack/Break/Sustain/Release Level

These are the envelope segment levels. The result will depend on the filter that was selected in “Filter Type”. For example, with the Low Pass Resonance filter, positive (+) values of EG Intensity will cause the tone to be brightened by positive (+) levels, and darkened by negative (-) levels.

-99...+99 Level value.

Start Level

This parameter specifies the change in cutoff frequency at the time of note-on.

Attack Level

This parameter specifies the change in cutoff frequency after the attack time has elapsed.

Break Point Level

This parameter specifies the change in cutoff frequency after the decay time has elapsed.

Sustain Level

This parameter specifies the change in cutoff frequency that will be maintained from after the slope time has elapsed until note-off occurs.

Release Level

This parameter specifies the change in cutoff frequency that will occur when the release time has elapsed.

Attack/Decay/Slope/Release Time

These parameters specify the time over which the filter change will occur.

0...99 Time value.

Attack Time

This parameter specifies the time over which the level will change from note-on until the attack level is reached.

Decay Time

This parameter specifies the time over which the level will change from the attack level to the break point level.

Slope Time

This parameter specifies the time over which the level will change after the decay time has elapsed until the sustain level is reached.

Release Time

This parameter specifies the time over which the level will change after note-on occurs until the release level is reached.

Filter EG 'Level' modulation

Filter 1 EG changes (level) (AMS = Velocity, Intensity = a positive (+) value)

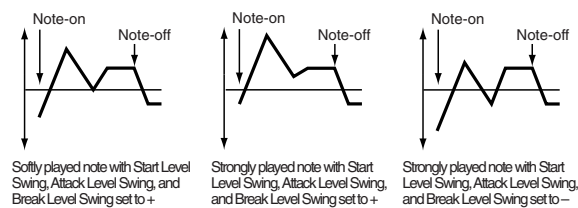

AMS(L) (Alternate Modulation Source)

This parameter selects the source that will control the "Level" parameters of the filter EG ("AMS (Alternate Modulation Source) list" on page 123).

Intensity (AMS Intensity)

This parameter specifies the depth and direction of the effect applied by "AMS". With a setting of 0, the levels specified by "Frequency A (Cutoff Frequency A)" will be used.

For example, if "AMS" is Velocity, and you set "Start Level Swing", "Attack Level Swing" and "Break Level Swing" to + and set "Intensity" to a positive (+) value, the EG levels will rise as you play more strongly. If "Intensity" is set to a negative (-) values, the EG levels will fall as you play more strongly.

-99...+99 Intensity value.

Start Level Swing

This parameter specifies the direction in which "AMS" will affect "Start Level". When "Intensity" has a positive (+) value, a setting of + for this parameter will allow "AMS" to raise the EG level, and a setting of - will allow "AMS" to lower the EG level. With a setting of 0 there will be no change.

Attack Level Swing

This parameter specifies the direction in which "AMS" will affect "Attack Level". When "Intensity" has a positive (+) value, a setting of + for this parameter will allow "AMS" to raise the EG level, and a setting of - will allow "AMS" to lower the EG level. With a setting of 0 there will be no change.

Break Level Swing

This parameter specifies the direction in which "AMS" will affect "Break Point Level". When "Intensity" has a positive (+) value, a setting of + for this parameter will allow "AMS" to raise the EG level, and a setting of - will allow "AMS" to lower the EG level. With a setting of 0 there will be no change.

Filter EG 'Time' modulation

Filter 1 EG changes (Time) (AMS = Velocity, Intensity = a positive (+) value)

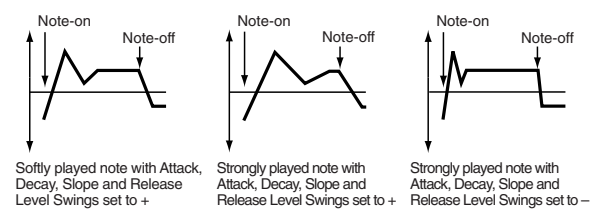

AMS1/2(T)

Use this parameter to select the source that will control the "Time" parameters of the filter EG. See "AMS (Alternate Modulation Source) list" on page 123.

Intensity

This parameter specifies the depth and direction of the effect that "AMS1/2(T)" will have.

For example, if "AMS1/2(T)" is set to FltKTr +/+, the EG "Time" parameters will be controlled by the Keyboard Tracking settings. With positive (+) values of this parameter, positive (+) values of "Ramp" will lengthen the EG times, and negative (-) values of "Ramp" will shorten the EG times. The direction of change is specified by "Attack Time Swing", "Decay Time Swing", "Slope Time Swing", and "Release Time Swing".

With a setting of 0, the times specified by "Frequency A (Cutoff Frequency A)" will be used.

If "AMS1/2(T)" is set to Velocity, positive (+) values of this parameter will cause EG times to lengthen as you play more strongly, and negative (-) values will cause EG times to shorten as you play more strongly.

-99...+99 Intensity value.

Attack Time Swing

This parameter specifies the direction in which "AMS1/2(T)" will affect the attack time. With positive (+) values of "Intensity", setting this parameter to + will allow AMS to lengthen the time, and setting this parameter to - will allow AMS to shorten the time. With a setting of 0 there will be no change.

Decay Time Swing

This parameter specifies the direction in which "AMS1/2(T)" will affect the decay time. With positive (+) values of "Intensity", setting this parameter to + will allow AMS to lengthen the time, and setting this parameter to - will allow AMS to shorten the time. With a setting of 0 there will be no change.

Slope Time Swing

This parameter specifies the direction in which "AMS1/2(T)" will affect the slope time. With positive (+) values of "Intensity", setting this parameter to + will allow AMS to lengthen the time, and setting this parameter to - will allow AMS to shorten the time. With a setting of 0 there will be no change.

Release Time Swing

This parameter specifies the direction in which "AMS1/2(T)" will affect the release time. With positive (+) values of "Intensity", setting this parameter to + will allow AMS to lengthen the time, and setting this parameter to - will allow AMS to shorten the time. With a setting of 0 there will be no change.

PAGE 12 - AMP

These parameters control the volume and pan of the selected oscillator.

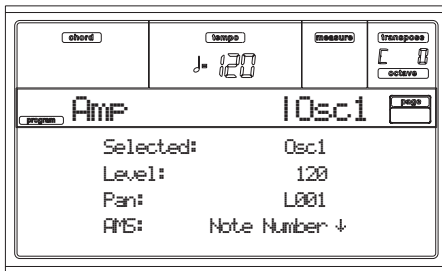

Selected

Use this parameter to select an oscillator to put in edit. Alternatively, you can select oscillators using the F1-F4 buttons.

Level

Volume of the selected oscillator.

Note: The volume of a Program can be controlled by CC#7 (volume) and #11 (expression). The resulting level is determined by multiplying the values of CC#7 and #11. The Global MIDI channel is used for control.

0...127 Volume level.

Pan

Pan (stereo position) of the selected oscillator.

DRUM This parameter is not available when editing a Drum Program. Use the individual Pan control for each key (see "Pan" on page 109).

Random The sound will be heard from a different location at each note-on.

L001 Places the sound at far left.

C064 Places the sound in the center.

R127 Places the sound to far right.

Note: This can be controlled by CC#10 (panpot). A CC#10 value of 0 or 1 will place the sound at the far left, a value of 64 will place the sound at the location specified by the "Pan" setting for each oscillator, and a value of 127 will place the sound at the far right. This is controlled on the global MIDI channel.

Pan modulation

AMS (Alternate Modulation Source)

Selects the source that will modify pan (see "AMS (Alternate Modulation Source) list" on page 123). This change will be relative to the "Pan" setting.

Intensity

Specifies the depth of the effect produced by "AMS". For example, if "Pan" is set to C064 and "AMS" is Note Number, positive (+) values of this parameter will cause the sound to move toward the right as the note numbers increase beyond the C4 note (i.e., as you play higher), and toward the left as the note numbers decrease (i.e., as you play lower). Negative (-) values of this parameter will have the opposite effect.

-99...+99 Parameter value.

PAGE 13 - AMP MODULATION

These settings allow you to apply modulation to amp (for each oscillator) to modulate the volume.

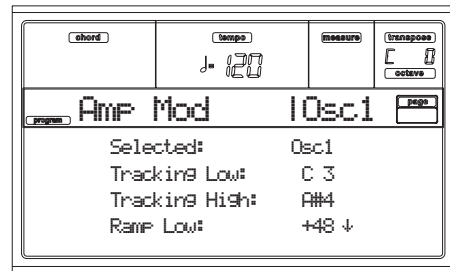

Selected

Use this parameter to select an oscillator to put in edit. Alternatively, you can select oscillators using the F1-F4 buttons.

Amplifier keyboard tracking

These parameters let you use keyboard tracking to adjust the volume of the selected oscillator. Use the "Key" and "Ramp" parameters to specify how the volume will be affected by the keyboard location that you play.

Tracking Low/High

These settings specify the note number at which keyboard tracking will begin to apply. The volume will not change between "Tracking Low" and "Tracking High".

C-1...G9 Lowest/Highest note in the range.

Tracking Low

Keyboard tracking will apply to the range below the specified note number.

Tracking High

Keyboard tracking will apply to the range above the specified note number.

Ramp

These parameters specify the angle of keyboard tracking.

-99...+99 Angle value.

Here is an example of volume changes produced by keyboard location and "Ramp" settings:

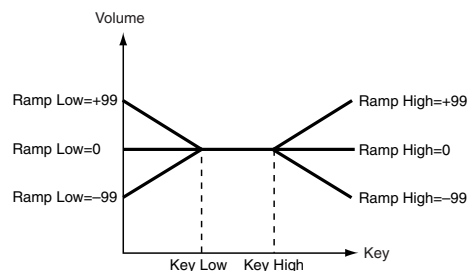

Ramp Low

With positive (+) values of this parameter, the volume will increase as you play notes below the "Tracking Low" note number. With negative (-) values, the volume will decrease.

Ramp High

With positive (+) values of this parameter, the volume will increase as you play notes above the "Key High" note number. With negative (-) values, the volume will decrease.

Amplifier Modulation

These parameters specify how the volume of the selected oscillator will be affected by velocity.

Velocity Intensity

With positive (+) values, the volume will increase as you play more strongly. With negative (-) values, the volume will decrease as you play more strongly.

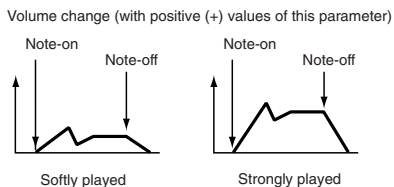

-99...+99 Intensity value.

EG AMS (Alternate Modulation Source)

Selects the source that will control the volume of the amp for the selected oscillator (See “AMS (Alternate Modulation Source) list” on page 123). “Velocity” cannot be selected.

Intensity

This parameter specifies the depth and direction of the effect that “AMS” will have. The actual volume will be determined by multiplying the value of the changes produced by the amp EG with the values of Alternate Modulation etc., and if the levels of the amp EG are low, the modulation applied by Alternate Modulation will also be less.

For example, if “AMS” is set to Joystick +Y, positive (+) values of this parameter will cause the volume to increase when you push the joystick. However if the EG settings etc. have already raised the volume to its maximum level, the volume cannot be increased further.

With negative (-) values of this parameter, the volume will decrease when the joystick is pushed.

-99...+99 Intensity value.

PAGE 14 - AMP LFO1

These parameters let you use “LFO1” (see “Page 17 - LFO1” on page 120) and “LFO 2” (see “Page 18 - LFO2” on page 121) to control the volume of the selected oscillator.

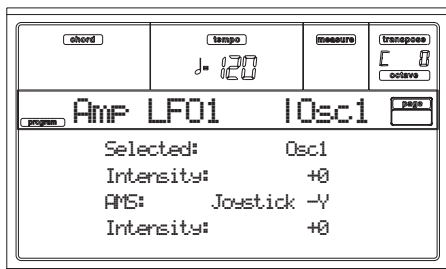

Selected

Use this parameter to select an oscillator to put in edit. Alternatively, you can select oscillators using the F1-F4 buttons.

Intensity

This parameter specifies the depth and direction of the effect that “LFO1” will have on the volume of the selected oscillator. Negative (-) values will invert the LFO waveform.

-99...+99 Intensity value.

Amplifier LFO1 modulation

AMS (Alternate Modulation Source)

Use this parameter to select a source that will control the depth by which “LFO1” will modulate the volume of the selected oscillator. See “AMS (Alternate Modulation Source) list” on page 123.

Intensity

As the absolute value of this setting is increased, the effect of “AMS” on “LFO1” will increase. Negative (-) values will invert the LFO waveform.

-99...+99 Intensity value.

PAGE 15 - AMP LFO2

These parameters let you use “LFO1” (see “Page 17 - LFO1” on page 120) and “LFO 2” (see “Page 18 - LFO2” on page 121) to control the selected oscillator volume. See “Page 14 - Amp LFO1” for more information on parameter’s editing.

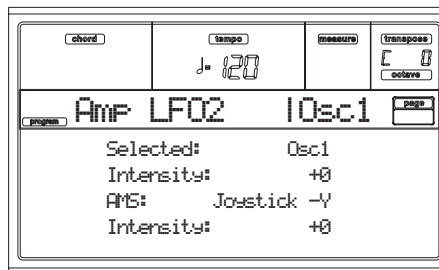

PAGE 16 - AMP EG

These parameters let you create time-varying changes in the volume of the selected oscillator.

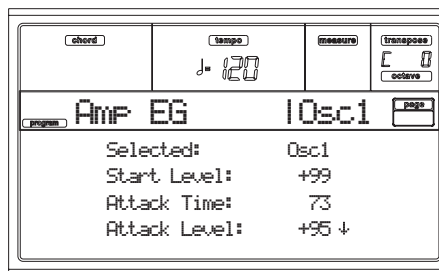

Selected

Use this parameter to select an oscillator to put in edit. Alternatively, you can select oscillators using the F1-F4 buttons.

Amp envelope

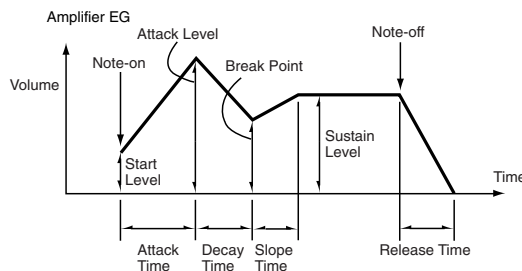

Start/Attack/Break/Sustain/Release Level

These parameters are the level of the envelope segment.
0...99 Level value.

Start Level

This parameter specifies the volume level at note-on. If you want the note to begin at a loud level, set this to a high value.

Attack Level

This parameter specifies the volume level that will be reached after the attack time has elapsed.

Break Level

This parameter specifies the volume level that will be reached after the decay time has elapsed.

Sustain Level

This parameter specifies the volume level that will be maintained from after the slope time has elapsed until note-off occurs.

Attack/Decay/Slope/Release Time

These parameters specify the time over which the volume change will occur.

0...99 Time value.

Attack Time

This parameter specifies the time over which the volume will change after note-on until it reaches the attack level. If the start level is 0, this will be the rise time of the sound.

Decay Time

This parameter specifies the time over which the volume will change from when it reaches the attack level until it reaches the break point level.

Slope Time

This parameter specifies the time over which the volume will change from when it reaches the break point level until it reaches the sustain level.

Release Time

This parameter specifies the time over which the volume will change after note-off until it reaches 0.

Amp EG 'Level' modulation

Amp 1 EG changes (Level) (AMS=Velocity, Intensity = a positive (+) value)

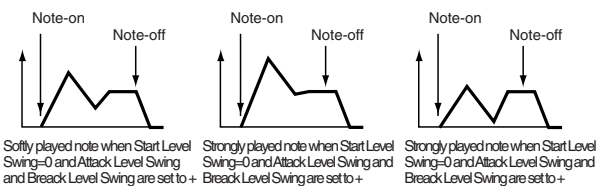

AMS(L) (Alternate Modulation Source)

This parameter specifies the source that will control the "Level" parameters of the amp EG. See "AMS (Alternate Modulation Source) list" on page 123.

Intensity

This parameter specifies the depth and direction of the effect that "AMS" will have. For example, if "AMS" is Velocity, setting "Start Level Swing", "Attack Level Swing" and "Break Point Level Swing" to + and setting "Intensity" to a positive (+) value will cause the amp EG volume levels to increase as you play more strongly. Setting "Intensity" to a negative (-) values will cause the amp EG volume levels to decrease as you play more strongly. With a setting of 0, the levels will be as specified on "Page 16 - Amp EG".

-99...+99 Intensity value.

Start Level Swing

This parameter specifies the direction in which "AMS" will change "Start Level". If "Intensity" is set to a positive (+) value, setting this parameter to + will allow AMS to increase the EG level, and setting this parameter to - will allow AMS to decrease the EG level. With a setting of 0, no change will occur.

Attack Level Swing

This parameter specifies the direction in which "AMS" will change "Attack Level". If "Intensity" is set to a positive (+) value, setting this parameter to + will allow AMS to increase the EG level, and setting this parameter to - will allow AMS to decrease the EG level. With a setting of 0, no change will occur.

Break Point Level Swing

This parameter specifies the direction in which "AMS" will change "Break Level". If "Intensity" is set to a positive (+) value, setting this parameter to + will allow AMS to increase the EG level, and setting this parameter to - will allow AMS to decrease the EG level. With a setting of 0, no change will occur.

Amp EG 'Time' modulation

These parameters let you use an alternate modulation source to modify the amp EG times that were specified in "Attack/Decay/Slope/Release Time" on page 119.

Amp 1 EG changes (Time) (AMS=Amp KTrk +/-, Intensity = a positive (+) value) (When Amp Keyboard Track "Low Ramp" = a positive (+) value, and "High Ramp" = a positive (+) value)

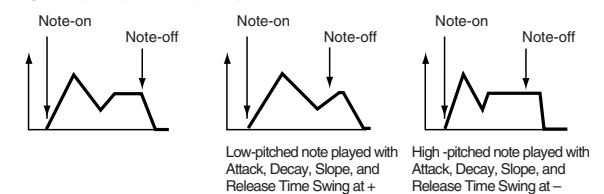

Amp 1 EG changes (Time) (AMS=Velocity, Intensity = a positive (+) value)

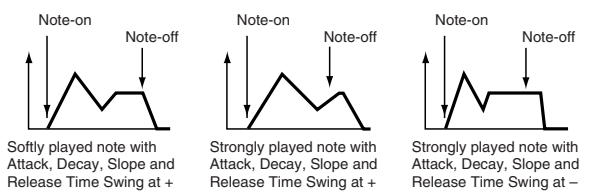

AMS1(T) (Alternate Modulation Source 1 - Time)

This parameter specifies the source that will control the "Time" parameters of the amp EG (see "AMS (Alternate Modulation Source) list" on page 123). With a setting of Off, there will be no modulation.

Intensity

This parameter specifies the depth and direction of the effect that "AMS1" will have. For example, if "AMS1(T)" is Amp KTrk +/+, the (Amp) Keyboard Track settings (see "Amplifier keyboard tracking" on page 117) will control the EG "Time" parameters. With positive (+) values of this parameter, positive (+) values of "Ramp (Ramp Setting)" will cause EG times to be lengthened, and negative (-) values of "Ramp (Ramp Setting)" will cause EG times to be shortened. The direction of the change is specified by "Attack Time Swing", "Decay Time Swing", "Slope Time Swing", and "Release Time".

When "AMS1(T)" is Velocity, positive (+) values will cause EG times to lengthen as you play more strongly, and negative

(-) values will cause EG times to shorten as you play more strongly. With a setting of 0, the EG times will be as specified by the "Amp envelope" parameters (see page 14-118).

Attack Time Swing

This parameter specifies the direction of the effect that "AMS1" will have on "Attack Time". With positive (+) values of "Intensity", setting this parameter to + will allow AMS1 to lengthen the time, and setting it to - will allow AMS1 to shorten the time. With a setting of 0 there will be no effect.

Decay Time Swing

This parameter specifies the direction of the effect that "AMS1" will have on "Decay Time". With positive (+) values of "Intensity", setting this parameter to + will allow AMS1 to lengthen the time, and setting it to - will allow AMS1 to shorten the time. With a setting of 0 there will be no effect.

Slope Time Swing

This parameter specifies the direction of the effect that "AMS1" will have on "Slope Time". With positive (+) values of "Intensity", setting this parameter to + will allow AMS1 to lengthen the time, and setting it to - will allow AMS1 to shorten the time. With a setting of 0 there will be no effect.

Release Time

This parameter specifies the direction of the effect that "AMS1" will have on "Release Time". With positive (+) values of "Intensity", setting this parameter to + will allow AMS1 to lengthen the time, and setting it to - will allow AMS1 to shorten the time. With a setting of 0 there will be no effect.

AMS2 (Alternate Modulation Source 2)

This is another alternate modulation source for the Amp EG. See above "AMS1" parameters.

PAGE 17 - LFO1

In this and the next page you can make settings for the LFO that can be used to cyclically modulate the Pitch, Filter, and Amp of each oscillator. There are two LFO units for each oscillator. By setting the LFO1 or LFO2 Intensity to a negative (-) value for Pitch, Filter, or Amp, you can invert the LFO waveform.

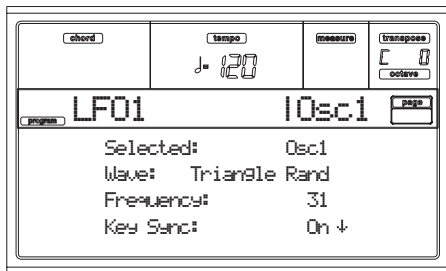

Wave

This parameter selects the LFO waveform. The numbers that appear at the right of some of the LFO waveforms indicate the phase at which the waveform will begin.

Triangle	0			Step Triangle - 4	
Triangle	90		Triangle wave	Step Triangle - 6	
Triangle Random			Phase will change randomly at each key-in	Step Saw - 4	
Saw	0		Sawtooth down ↓	Step Saw - 6	
Saw	180				
Square			Square wave		
Sine			Sine wave		
Guitar			Guitar vibrato		
Exponential Triangle					
Exponential Saw Down					
Exponential Saw Up					

Random1 (S/H):
Conventional sample & hold (S/H) in which the level changes randomly at fixed intervals of time

Random2 (S/H):
Both the levels and the time intervals will change randomly.

Random3 (S/H):
The maximum level and minimum level will alternate at random intervals of time (i.e., a square wave with random period).

Random4 (Vector)
Random5 (Vector)
Random6 (Vector)
These types cause Random 1-3 to change smoothly. They can be used to simulate the instability of acoustic instruments etc.

Frequency

Set the LFO frequency. A setting of 99 is the fastest.

00...99 Frequency rate.

Key Sync

This parameter specifies if the LFO is synchronized to key strokes.

On The LFO will start each time you play a note, and an independent LFO will operate for each note.

Off The LFO effect that was started by the first-played note will continue to be applied to each newly-played note. (In this case, Delay and Fade will be applied only to the LFO when it is first started).

Offset

This parameter specifies the central value of the LFO waveform. For example, with a setting of 0 as shown in the following diagram, the vibrato that is applied will be centered on the note-on pitch. With a setting of +99, the vibrato will only raise the pitch above the note-on pitch, in the way in which vibrato is applied on a guitar.

When "Wave" is set to Guitar, the modulation will occur only in the positive (+) direction even if you set "Offset" to 0.

Here are offset settings and pitch change produced by vibrato

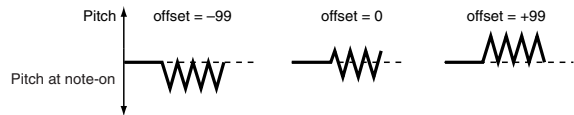

-99...+99 Offset value.

Delay

This parameter specifies the time from note-on until the LFO effect begins to apply. When "Key Sync" is Off, the delay will apply only when the LFO is first started.

0...99 Delay time.

Fade In

This parameter specifies the time from when the LFO begins to apply until it reaches the maximum amplitude. When "Key Sync." is Off, the fade will apply only when the LFO is first started.

Here is how “Fade In” affects the LFO (when “Key Sync” is On):

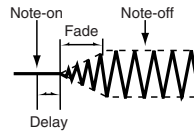

00...99 Fade rate.

Frequency MIDI/Tempo Sync

MIDI/Tempo Sync

This parameter enables/disables the LFO synchronization with Sequencer 1 Tempo.

On The LFO frequency will synchronize to the tempo (MIDI Clock) of Sequencer 1. In this case, the values you specified for “Frequency” (see page 14-120) and “Frequency modulation” (see page 14-121) will be ignored.

Base Note/Times

When “MIDI/Tempo Sync” is On, these parameters set a note length relative to “♩ (Tempo)” and the multiple (“Times”) that will be applied to it. These parameters will determine the frequency of the LFO1. For example if “Base Note” is ♩ (quarter note) and “Times” is 04, the LFO will perform one cycle every four beats.

Even if you change the “♩ (Tempo)” setting of Sequencer 1, the LFO will always perform one cycle every four beats.

Base Note

DRUM This parameter is not available when editing a Drum Program.

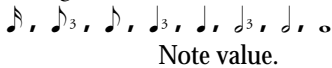

Note value.

Times

DRUM This parameter is not available when editing a Drum Program.

01...16 Beats before restarting the cycle.

Frequency modulation

You can use two alternate modulation sources to adjust the speed of the LFO1 for the selected oscillator.

AMS1(F) (Alternate Modulation Source1)

Selects the source that will adjust the frequency of the selected oscillator LFO1 (see “AMS (Alternate Modulation Source) list” on page 123). LFO1 can be modulated by LFO2.

Intensity (AMS1 Intensity)

This parameter specifies the depth and direction of the effect that “AMS1(F)” will have. When this parameter is set to a value of 16, 33, 49, 66, 82, or 99, the LFO frequency being can be increased by a maximum of 2, 4, 8, 16, 32, or 64 times respectively (or decreased by 1/2, 1/4, 1/8, 1/16, 1/32, or 1/64 respectively).

For example, if “AMS1(F)” is Note Number, positive (+) values of this parameter will cause the oscillator LFO to speed up as you play higher notes. Negative (-) values will cause the oscillator LFO to slow down as you play higher notes. This change will be centered on the C4 note.

If “AMS1(F)” is set to JS +Y, raising the value of this parameter will cause the oscillator LFO1 speed to increase as the joystick is moved away from yourself. With a setting of +99, moving the joystick all the way away from yourself will increase the LFO speed by approximately 64 times.

-99...+99 Intensity value.

AMS2(F) (Alternate Modulation Source2)

Intensity (AMS2 Intensity)

Make settings for a second alternate modulation source that will adjust the frequency of the oscillator LFO1 (see above “AMS1(F) (Alternate Modulation Source1)” and “Intensity (AMS1 Intensity)”).

PAGE 18 - LFO2

Here you can make settings for the LFO2, which is the second LFO that can be applied to the selected oscillator. See “Page 17 - LFO1” for more information on the parameters value.

However in “Frequency modulation”, the LFO cannot be selected as a modulation source in “AMS1” or “AMS2.”

PAGE 19 - EFFECTS

Here you can select two effects for the whole Program, switch them on/off, and specify chaining.

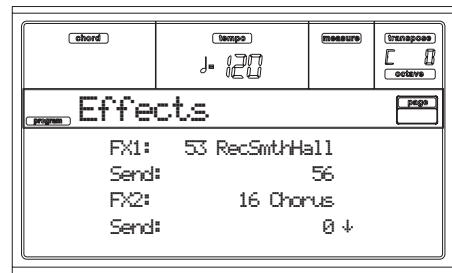

Note: For details on the effects, refer to the “Effects” chapter.

FX1/2

Use these parameters to select the effect type for effect 1/2. See the “Effects” chapter for more information.

Note: If 000: No Effect is selected, the output from the master effect will be muted.

Send

Send level for each effect.

DRUM Drum samples have their own send level settings (see “Send FX1” and “Send FX2” on page 14-109). Use this parameter to adjust the general offset of the Drum Program.

000...127 Effect level.

Chain 2>1

Use this parameter to send the output of effect 2 to the input of effect 1.

000...127 Level of the signal exiting the effect 2 going back to the effect 1.

Send to Master

This parameters allows you to decide if the direct + effected signal must go to the Master, or just the effected signal.

Yes Only the effected signal will be sent to the Audio Outputs. The direct (non-effected) signal will not be sent.

No Both the effected signal and direct signals will be sent to the Audio Outputs.

PAGE 20 - FX1 EDITING

In this page you can edit the effected assigned to the FX1 (A or C) effect processor (usually reverb). See the “Effects” chapter for more information.

PAGE 21 - FX2 EDITING

In this page you can edit the effected assigned to the FX2 (B or D) effect processor (usually modulating effect). See the “Effects” chapter for more information.

AMS (ALTERNATE MODULATION SOURCE) LIST

Off	Do not use Alternate Modulation
Pitch EG	Pitch EG
Filter EG	Filter EG within the same oscillator
Amp EG	Amp EG within the same oscillator
LFO1	LFO1 within the same oscillator
LFO2	LFO2 within the same oscillator
Flt KTrk +/+ (Filter Keyboard Track +/+)	Filter keyboard tracking within the same oscillator
Flt KTrk +/- (Filter Keyboard Track +/-)	Filter keyboard tracking within the same oscillator
Flt KTrk 0/+ (Filter Keyboard Track 0/+)	Filter keyboard tracking within the same oscillator
Flt KTrk +/0 (Filter Keyboard Track +/0)	Filter keyboard tracking within the same oscillator
Amp KTrk +/+ (Amp Keyboard Track +/+)	Amp keyboard tracking within the same oscillator
Amp KTrk +/- (Amp Keyboard Track +/-)	Amp keyboard tracking within the same oscillator
Amp KTrk 0/+ (Amp Keyboard Track 0/+)	Amp keyboard tracking within the same oscillator
Amp KTrk +/0 (Amp Keyboard Track +/0)	Amp keyboard tracking within the same oscillator
Note Number	Note number
Velocity	Velocity
Poly AT (Poly After Touch) ^(a)	Polyphonic After Touch (transmitted from the Pa50 only as sequence data)
Channel AT (Channel After Touch) ^(a)	After Touch (Channel After Touch)
Joystick X	Joystick X (horizontal) axis
Joystick +Y	Joystick +Y (vertical upward) direction (CC#01)
Joystick -Y	Joystick -Y (vertical downward) direction (CC#02)
JS+Y & AT/2 (Joy Stick +Y & After Touch/2) ^(a)	Joystick +Y (vertical upward) direction and After Touch
JS-Y & AT/2 (Joy Stick -Y & After Touch/2) ^(a)	Joystick -Y (vertical downward) direction and After Touch
Ass.Pedal	Assignable foot pedal (CC#04)
CC#18	CC#18
CC#17	CC#17
CC#19	CC#19
CC#20	CC#20
CC#21	CC#21
Damper	Ddamper pedal (CC#64)
CC#65	Portamento switch (CC#65)
Sostenuto	Sostenuto pedal (CC#66)
CC#80	CC#80
CC#81	CC#81
CC#82	CC#82
CC#83	CC#83
Tempo	Tempo (tempo data from Sequencer 1 clock or external MIDI clock)

(a) After Touch data can only be received via MIDI, or create as a MIDI event in Song Record-Step Recording mode.

Flt KTrk +/+ (Filter Keyboard Track +/+)	+/-	The direction of the effect will be determined by the sign of the “Ramp Low” setting, and by the opposite sign of the “Ramp High” setting (-50 for a setting of +50, and +50 for a setting of -50).
Flt KTrk +/- (Filter Keyboard Track +/-)		
Flt KTrk 0/+ (Filter Keyboard Track 0/+)		
Flt KTrk +/0 (Filter Keyboard Track +/0)		
Amp KTrk +/+ (Amp Keyboard Track +/+)	0/+	
Amp KTrk +/- (Amp Keyboard Track +/-)		“Ramp Low” will have no AMS effect. The sign of the “Ramp High” setting will determine the direction of its effect.
Amp KTrk 0/+ (Amp Keyboard Track 0/+)		
Amp KTrk +/0 (Amp Keyboard Track +/0)		
+/+	The direction of the effect will be determined by the sign (positive or negative) of the “Ramp Low” or “Ramp High” setting.	

+ / 0

The sign of the “Ramp Low” setting will determine the direction of its effect. “Ramp High” will have no AMS effect.

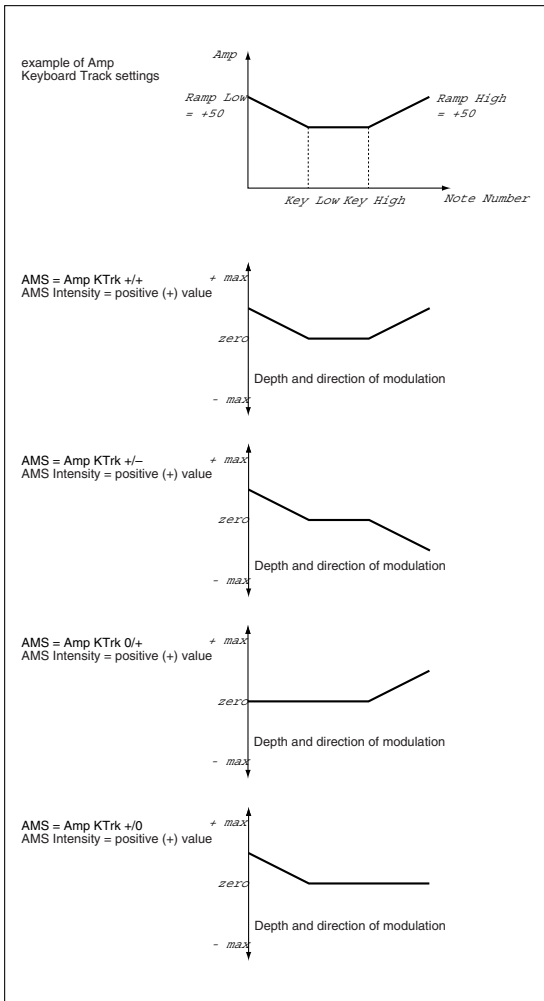

JS +Y & AT/2 (Joy Stick +Y & After Touch/2)

The effect will be controlled by the joystick +Y (vertically upward) and by after touch data (received via MIDI). In this case, the effect of after touch will be only half of the specified intensity.

JS -Y & AT/2 (Joy Stick -Y & After Touch/2)

The effect will be controlled by the joystick -Y (vertically downward) and by after touch data (received via MIDI). In this case, the effect of after touch will be only half of the specified intensity.

15. GLOBAL EDIT ENVIRONMENT

The Global edit environment is the place where you can set most of the Pa50 global functions, i.e. functions overriding any operating mode. This edit environment overlaps the current operating mode (Style, Song Play, Song, Backing Sequence).

THE WRITE WINDOW

Open this window by pressing the WRITE button while one of the Global pages is in the display. Here, you can save various global settings. Among the global settings saved with this page are also the Preference parameters of the Style Play and Song Play mode, plus the Global Protect parameter of the Disk mode. The Split Point is also saved here.



While this page is on the display, press ENTER twice. The parameters are saved to the Flash-ROM, and will stay in memory even when turning the instrument off.

MENU

From any page, press MENU to open the Global edit menu. This menu gives access to the various Global edit pages.

When in this menu, select a section using the VOLUME/VALUE buttons, press PAGE+ to select a page, or press EXIT to exit the menu.

When in a page, press EXIT to go back to current operating mode (Style Play, Song Play, Song, Backing Sequence).

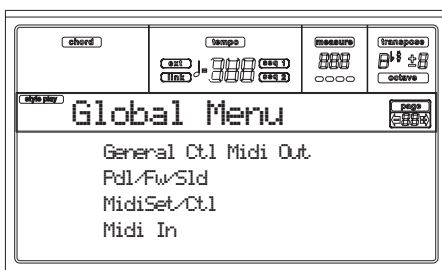

PAGE 1 - GENERAL CONTROLS

This page contains various general parameters, setting the status of the keyboard, the speakers and the metronome.

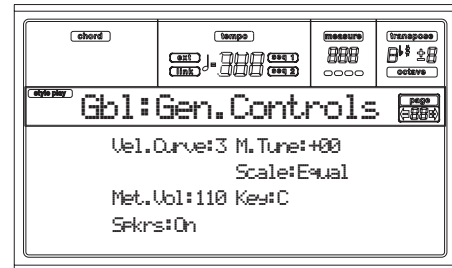

Vel.Curve (Velocity Curve) ▶GBL

This parameter sets the sensitivity of the keyboard to your touch.

- 1 No dynamic control available. Dynamic values are fixed, as in a classic organ.
- 2...9 Curves, from the lightest one to the hardest one.

M.Tune (Master Tune) ▶GBL

This is the master tuning of the instrument. Use it to adapt your keyboard tuning to an acoustic instrument, for example an acoustic piano.

- 50 Lowest pitch.
- 00 Standard pitch (A4=440Hz).
- +50 Highest pitch.

Scale ▶GBL

This parameter sets the main scale (or temperament) for the whole instrument, apart for tracks where a different scale is selected by a Performance or STS (see "Scale" on page 44).

See "Scales" on page 227 for a list of available scales.

Note: You cannot select a User scale in Global mode.

Key ▶GBL

This parameter is needed by some scales to set the preferred key (see "Scale" on page 44).

Speakers

This parameter turns the internal speakers on or off.

Note: Speakers are always turned on again each time you turn the instrument on.

Met.Vol (Metronome Volume) ▶GBL

Volume of the metronome.

- 40...127 Relative volume, from minimum to maximum.

PAGE 2 - MASTER TRANSPOSE

This page is where you can turn the Master Transpose on or off.

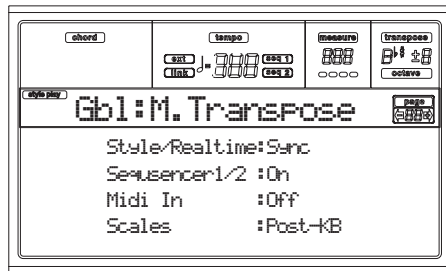

Style/Realtime

► GBL

This is a flag to turn the Master Transpose on or off on the Style and Realtime (Keyboard) tracks.

Off No Master Transpose is applied to the Style and Realtime tracks.

Sync Sync mode. When you press either the TRANSPOSE [b] or [♯] buttons, the new transpose setting will not take effect until the first beat of the next measure is reached. The Realtime tracks sounding at the time of the transpose will be stopped.

RTime Realtime mode. When you press either the TRANSPOSE [b] or [♯] buttons, the new transpose setting will occur when the next note is played for both the Style and Realtime tracks individually. (Note that any notes sounding from the Realtime tracks will be stopped when you press the TRANSPOSE button) The next key or chord you press will sound with the new transpose setting. (Note that if you play a Realtime track prior to a new chord, the Realtime track will play in the new key as the Style will continue to play in the old key until a new chord is entered).

Seq 1/2

► GBL

This is a flag to turn the Master Transpose on or off on the two onboard Sequencers' tracks.

Midi In

► GBL

This is a flag to turn the Master Transpose on or off on the received MIDI messages.

Scales

The Scale Transpose Position allows you to decide the relation between the Scale and the Master Transpose.

Post-KB When this option is selected, notes will be transposed immediately after they leave the keyboard. The Scale will be applied to the transposed notes. For example, if you altered an E, and then set the Master Transpose to +1, the E key will play F, and the altered key will be E_b (that will play an altered E).

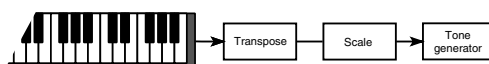

Pre-OSC

When this option is selected, all notes are transposed immediately before they enter the

internal tone generator. Therefore, the Scale will be applied before transposition. For example, if you altered an E, and then set the Master Transpose to +1, the altered key will still be E (that will play an altered F).

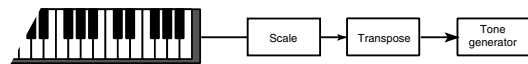

PAGE 3 - ASSIGNABLE PEDAL/FOOTSWITCH, ASSIGNABLE SLIDER

This page lets you program the Assignable Pedal/Footswitch, and the Assignable Slider.

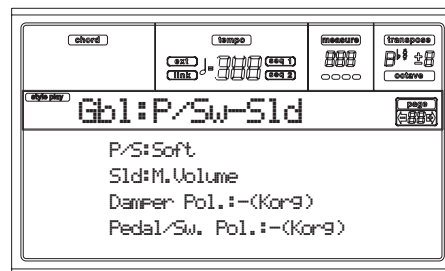

See page 225 for a list of the assignable functions. The first functions are switch-type functions, while the remaining (starting from Master Volume) are continuous-like functions.

P/S (Pedal/Switch)

► GBL

Continuous pedal, or footswitch, connected to the ASSIGNABLE PDL/SW connector.

Sld (Slider)

► GBL

Function assigned to the ASSIGNABLE SLIDER on the front panel.

Damper Pol. (Damper Polarity)

► GBL

Polarity of the Damper pedal.

Pedal/Sw. Pol. (Pedal/Footswitch Polarity)

► GBL

Polarity of the Assignable pedal or footswitch.

PAGE 4 - MIDI SETUP

MIDI channels can be automatically configured by selecting a MIDI Setup. Each of them assigns the best values to various MIDI parameters, to allow an easier connection with a particular MIDI controller.

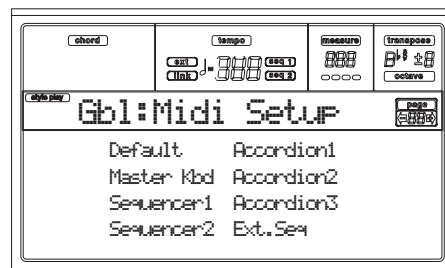

Note: After selecting a MIDI Setup, you can apply any changes to each channel's settings. To store the changes in memory, press WRITE and save the Global in memory.

See "MIDI" on page 35 for more information on using the MIDI Setups.

- Default This a default setting. It is suitable both for programming on an external sequencer, and for playing Pa50 with a master keyboard.
- Master Kbd Select this setting when you are connecting a mute master keyboard.
- Sequencer 1 This setting is for playing a Song (Sequencer 1) with an external instrument sounds, or for listening to a Song performed by an external sequencer using Pa50 as a sound generator. Each track (S1 Tr1-16) corresponds to a MIDI channel with the same number (1-16).
- Sequencer 2 As above, but with Sequencer 2.
- Accordion 1...3 Select one of these settings when connecting a MIDI Accordion.
- Ext.Seq This setting is for programming a Song on an external sequencer.

PAGE 5 - MIDI CONTROLS

This page lets you program general MIDI parameters.

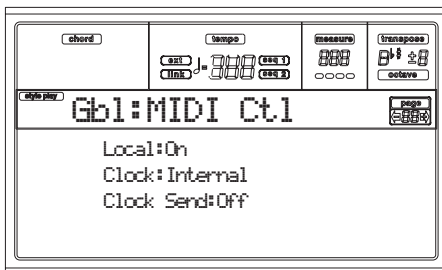

Local

The Local parameter turns the keyboard on or off.

Note: The Local parameter is always turned on again each time you turn the instrument on.

- On When you play on the keyboard, MIDI data is sent to the internal sound generator and to the MIDI OUT port.
- Off The keyboard is connected to the MIDI OUT, but cannot play the internal sound generator. This is very useful when working with an external sequencer, to send notes and controllers from the keyboard to the external sequencer, and then let the sequencer send them back to the sound generator, without overlapping. See the MIDI chapter.

Clock

This parameter selects the MIDI Clock source.

Note: The Clock parameter is always set to "Int" each time you turn the instrument on.

- Internal Internal, i.e. the clock generated by the Pa50 Sequencer 1 internal metronome.
- MIDI External from MIDI. The Pa50 is slaved to an external instrument or sequencer, connected to its MIDI IN port. The Start/Stop and Play/Stop commands, and the metronome Tempo, can-

not be selected from the control panel of the Pa50. Use the external instrument to set the Tempo, and start or stop the sequencers (Song, Song Play, Backing Sequence modes) and the arranger (Style and Backing Sequence modes).

Clock Send

►GBL

This parameter turns the clock information on the MIDI OUT on or off.

- Off The Pa50 cannot send the MIDI Clock signal. You cannot slave another instrument to the Pa50, even when connected to the MIDI OUT.
- MIDI The Pa50 can send the MIDI Clock signal. You can slave another instrument to the Pa50 Tempo, Start/Stop and Play/Stop commands. Connect the other instrument to the Pa50 MIDI OUT port.

PAGE 6 - MIDI IN CHANNELS

In this page, you can assign the Pa50 tracks to any of the MIDI IN channels. Use the TRACK SELECT button to switch from channels 1-8 to channels 9-16.

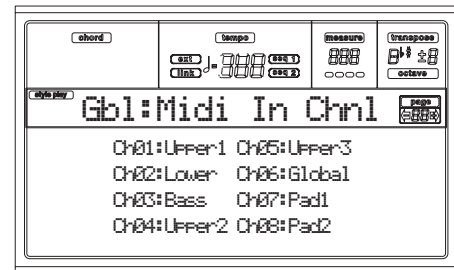

Channel

►GBL

You can assign to each channel one of the following tracks:

- (Off) No track assigned.
- Lower Lower track.
- Upper1...3 One of the Upper tracks.
- Drum Drum track.
- Perc Percussion track.
- Bass Bass track.
- Acc1...5 One of the Auto-accompaniment tracks.
- S1 T1...16 One of Sequencer 1 tracks.
- S2 T1...16 One of Sequencer 2 tracks.
- Global Special channel to simulate the Pa50's integrated controls (keyboard, pedals, joystick) with an external keyboard or controller. MIDI messages coming on this channel are considered as being generated by Pa50's integrated controllers.
- Control On this special channel, the Pa50 receives MIDI messages to remotely select Styles, Performances, STS and Style Elements. See tables on page 144 and following for more information on the received data

PAGE 7 - MIDI IN CONTROLS (1)

This page is where you can program the Chord Recognition channels for the internal arranger, and a fixed velocity value for all notes appearing at the input.

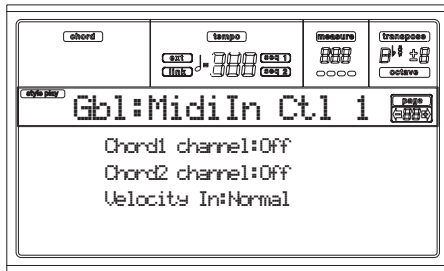

There are two separate Chord channels. This is very useful when you must send chords to Pa50 on two channels (like with some MIDI Accordions).

Chord1 channel ▶GBL

Notes entering this channel are sent to the Chord Recognition engine.

Chord2 channel ▶GBL

Notes entering this channel are sent to the Chord Recognition engine.

Velocity Input ▶GBL

Use this parameter to set a fixed velocity (dynamics) value for all MIDI notes entering. This is useful when playing the Pa50 with an organ or a MIDI Accordion.

Normal	Normal velocity values are received.
40...127	All received velocity values are converted to the selected value.

PAGE 8 - MIDI IN CONTROLS (2)

This is another page containing various MIDI IN settings, like note transposition for the Realtime tracks. The transpose parameters are useful to many MIDI accordion players, whose MIDI interface may transmit on an unexpected octave.

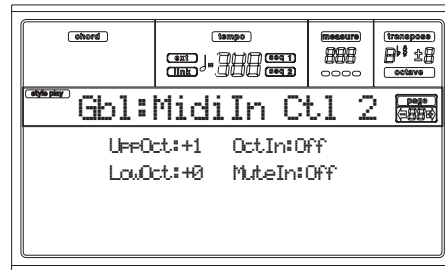

UppOct (Upper Octave) ▶GBL

Octave transposition of data received on the MIDI IN for the Upper tracks. For example, if you select the +1 value, a received C4 will play a C5 on the Pa50.

LowOct (Lower Octave) ▶GBL

Octave transposition of data received on the MIDI IN for the Lower track. For example, if you select the +1 value, a received C4 will play a C5 on the Pa50.

OctIn (Octave In) ▶GBL

Enables/disables the octave transposition of data received via MIDI.

On	Data received via MIDI can be transposed, according to the selected Octave Transposition. For example, if the Octave Transposition is +1, a received C4 will actually play a C5.
Off	Data received via MIDI can't be transposed by the Octave Transposition applied to the track. For example, if the Octave Transposition is +1, a received C4 will still play a C4.

Mute In ▶GBL

Use this parameter to determine if a muted track can still play data received via MIDI.

On	No data received via MIDI on a muted track can be played by Pa50.
Off	Data received via MIDI on a muted track can still play on the Pa50.

PAGE 9 - MIDI IN FILTERS

Use this page to set up to 8 filters for the MIDI data received by the Pa50.

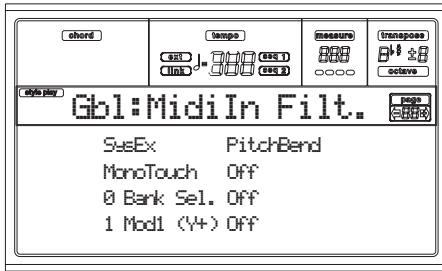

Filters

Selected MIDI IN filters.

- Off No filter.
- Pitch Bend Pitch Bend.
- MonoTouch Mono (or Channel) After Touch.
- PolyTouch Poly After Touch.
- PrgChange Program Change.
- SysExcl System Exclusive.
- All CC All Control Change messages.
- 0...127 Control Change message #0...127. See "MIDI Controllers" on page 228 for a list of available Control Change messages.

▶GBL

PAGE 10 - MIDI OUT CHANNELS

In this page, you can assign to any MIDI OUT channel one of Pa50's tracks. Use the TRACK SELECT button to switch from channels 1-8 to channels 9-16.

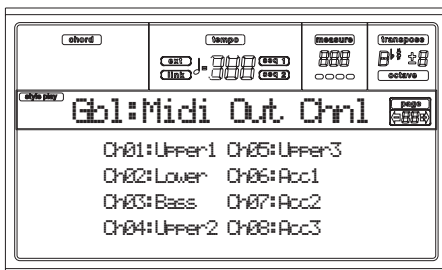

Channel

You can assign to each channel one of the following tracks:

- (Off) No track assigned.
- Lower Lower track.

▶GBL

- Upper1...3 One of the Upper tracks.
- Drum Drum track.
- Perc Percussion track.
- Bass Bass track.
- Acc1...5 One of the Auto-accompaniment tracks.
- S1 T1...16 One of Sequencer 1 tracks.
- S2 T1...16 One of Sequencer 2 tracks.
- SQ Tr01...16 Use these channels to send data generated by a track with the same name on either or both onboard sequencers at the same time.
- Chord Use this channel to send notes recognized by the Chord Recognition engine to the MIDI OUT. This is useful, for example, to control an external Harmonizer from the Pa50, using the Lower track to play chords, even if the track is in mute.

PAGE 11 - MIDI OUT FILTERS

Use this page to set up to 8 filters for the MIDI data sent by the Pa50.

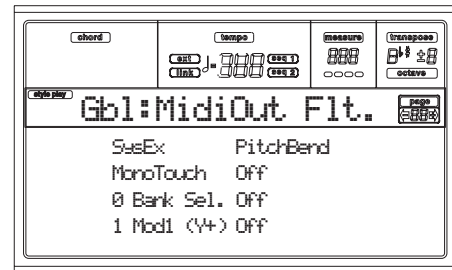

Filters

Selected MIDI OUT filters.

- Off No filter.
- Pitch Bend Pitch Bend.
- MonoTouch Mono (or Channel) After Touch.
- PolyTouch Poly After Touch.
- PrgChange Program Change.
- SysExcl System Exclusive.
- All CC All Control Change messages.
- 0...127 Control Change message #0...127. See "MIDI Controllers" on page 228 for a list of available Control Change messages.

▶GBL

16. DISK EDIT ENVIRONMENT

The Disk edit environment is the place where you can manage files. This edit environment overlaps the current operating mode (Style Play, Song Play, Backing Sequence, Song, Program).

THE WRITE/DISK IN USE LED

When a disk is reading or writing data, the WRITE/DISK IN USE indicator lights up. While in a Disk page, the "Wait" message appears in the display; in this situation, you can't select a different Disk page (you can, however, select a different operative mode).

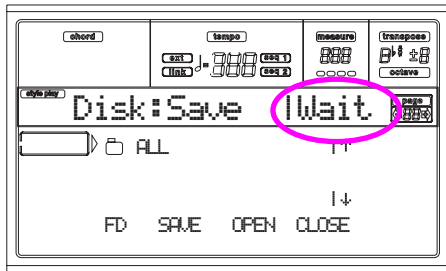

Warning! Never remove a floppy disk when the WRITE/DISK IN USE LED is turned on!

Note: When loading or saving, you can obtain the maximum speed by loading or saving into the same location as the source data. When loading or saving into a different location, some data restructuring is needed, and the operation becomes slower.

FLOPPY DISK HANDLING

The Pa50 can save most of the data contained in memory on a 3.5" DS-DD disk (720KB capacity) or HD (1,44MB capacity), MS-DOS®-formatted. Here are some precautions when handling disks.

Write protection

You can protect a disk from the accidental overwriting of data, by opening the write protect hole. To protect the disk from overwriting, slide the protection flap so that the hole becomes visible.

To write-protect the disk: move the flap and open the hole
To write-enable the disk: move the flap to close the hole

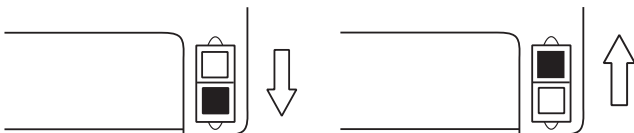

Inserting a disk

Insert the disk delicately into the disk drive, with the label facing upwards and the metal part to the front. Press it in as far as it will go.

Note: The Pa50 incorporates a new type of disk drive and you cannot hear "click" when the disk is inserted into place.

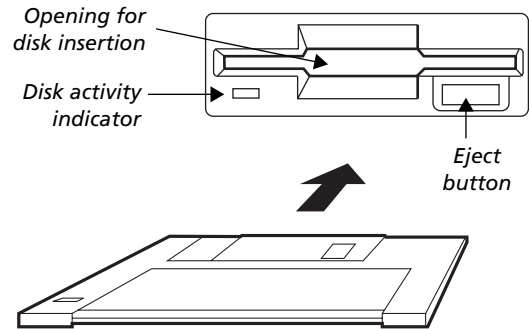

Removing a disk

Before removing a disk, make sure that the disk activity indicator is off. If the LED is off, remove the disk by pressing the eject button.

Warning: Do not remove the disk if the disk activity indicator is lit up.

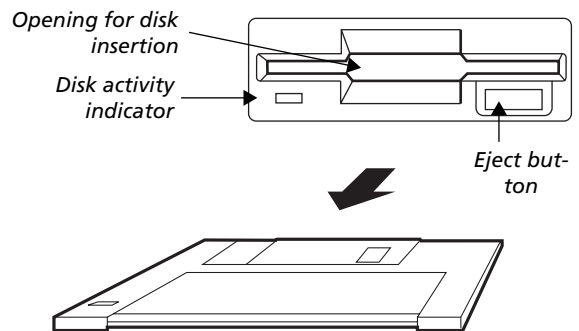

Cleaning the heads

The disk drive read/write heads get dirty with use and become less accurate. You can clean the heads with a special cleaning disk, you can purchase from any computer or musical instrument store. Use a 3.5" DS wet type head cleaning disk; and carefully follow the instructions included with it.

Precautions

- Do not remove the disk or move the instrument while the disk drive is operating (disk drive LED and WRITE/DISK IN USE LED lit up).
- Make a backup copy of the disks, in order not to lose data forever in case of damage. If you have a personal computer, you can keep a copy of the data on its hard disk.
- Do not open the metallic shutter on the disk, and do not touch the surface of the magnetic media inside it. If the magnetic media becomes scratched or soiled, data can be lost.
- Do not leave a disk in the disk drive while carrying the instrument: the read/write heads may scratch the disk and damage saved data.
- Keep the disks away from sources of magnetic fields, for example televisions, refrigerators, computers, monitors, speakers and transformers. Magnetic fields can alter the contents of the disks.
- Do not keep disks in very hot or wet places, do not expose them to direct sunlight and do not store them without use in dusty or dirty places.
- Do not place heavy objects on top of the disks.
- After use, replace the disks in a case.

Possible problems

- In exceptional cases, the disk can get stuck in the disk drive. In order to avoid this happening, you should only use high quality disks. If the disk does get stuck, do not try to force it out using sharp objects. Contact your local dealer or your nearest KORG Service Center.
- Magnetic fields, dirt, humidity and usage can damage data on disk. You can try to recover the data with disk repair utilities for personal computers. It is, however, advisable to make a backup copy of data.

LOADING DATA CREATED WITH THE PA80

Pa50 data is perfectly interchangeable with its Pa80 and Pa60 counterparts. The only data Pa50 can't load from a Pa80/Pa60 disk is the following:

- Digital Drawbar Programs
- Input 1/2 settings
- VHG1 Vocal/Guitar Processor Board settings
- EC5 settings
- TO HOST port setting
- Audio Output routing

At the same time, Pa80 and Pa60 can read any data created with the Pa50.

LOADING OLDER I-SERIES DATA

Pa50 is compatible with the Styles of the older i-Series instruments. You can load them as if they were ordinary Pa50 data.

1. Insert an older i-Series floppy disk into the disk drive.
2. Press DISK to go to the Disk environment.
3. In case you must replace the disk, insert the new disk, and press the F1 button to scan the floppy disk again.
4. If you are reading an i30 disk, move the ".SET" folder to the first line of the display (use the TEMPO/VALUE controls, or the E-H buttons), and press F3 (Open).
5. Move the ".STY" folder to the first line of the display (use the TEMPO/VALUE controls, or the E-H buttons).
6. At this point, you can load the whole ".STY" folder, or open it and select a single Style.
 - To load the whole folder, press F2 (Load). You will be prompted to select one of the three USER Style banks in memory.

Once the target bank is selected, press F2 (Load) to load the bank. The "Are you sure?" message will appear. Press ENTER to confirm, or EXIT to abort.

- To load a single Style, press F3 (Open) to open the ".STY" folder. Since a conversion will be started at this point, please wait some seconds for the operation to be completed.

Move the Style to load to the first line of the display. Then press F2 (Load). You will be prompted to select a target location in memory.

Once the target location is selected, press F2 (Load) to load the Style. The "Are you sure?" message will appear. Press ENTER to confirm, or EXIT to abort.

Note: Loading a whole ".SET" folder from an i30 disk takes very long. You are advised to load a single bank or a single Style a time.

7. Select the loaded Style. Set the Tempo, then press WRITE and select "Current Style" to memorize the changes to the Style Performance. Press ENTER twice to confirm.
8. Due to difference in Programs, you will probably make some adjustment to the old Styles, once they are loaded in Pa50 (changing the Program, Volume, Pan, Tempo, Drum Mapping, Wrap Around...).
9. To make the Program assignment to the Style tracks effective, you should set the "Prog (Program)" parameter to On (see page 49).
10. Save the Style Performance again. Press WRITE and select "Current Style" to save the changes in memory. Press ENTER twice to confirm.

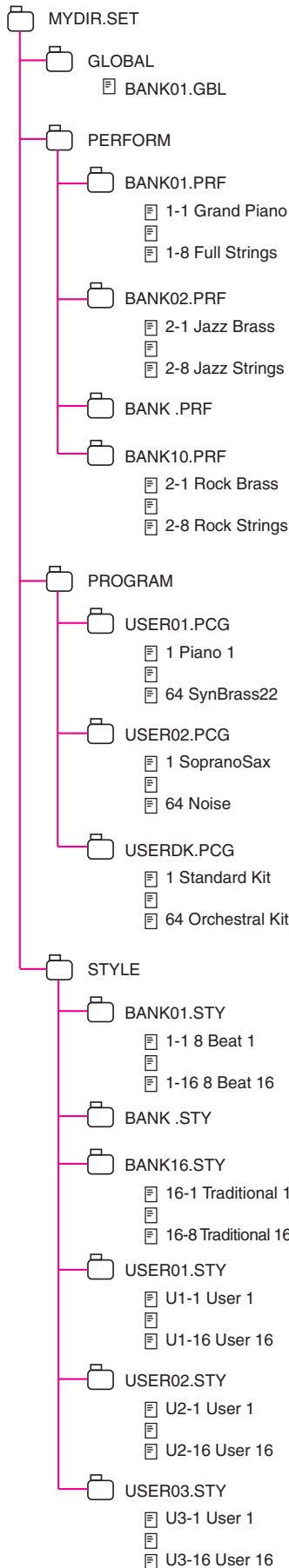

DISK STRUCTURE

Each disk (and the internal memory) can contain files and folders. The data structure in Pa50 is slightly more rigorously determined than in a computer, due to the pre-configured data structure inside the instrument's memory. The diagram on the left shows the global structure of a Pa50 disk.

Note: Style banks from 1 to 16 (Factory Styles) can be seen in Disk mode only when the "Factory Style Protect" parameter is set to Off (see page 142), and only when loading or saving a single Style bank.

FILE TYPES

The following tables describe all the file and folder types the Pa50 can manage. Here are the files you can read or write on the Pa50.

Extension	File/folder type
SET	All the User data. (This is a folder containing other folders).
GBL	Global, Seq1+Seq2 Setup
PRF	Performance
PCG	User Program
STY	User Style

The Pa50 can also read the following common types of data.

Extension	File type
MID	Midi file (Standard MIDI File, SMF)
KAR	Karaoke file
JBX	Jukebox

FILE AND FOLDER SIZE DISPLAY

The size of any file and folder in the disk can be seen in the display.

The single file size is always shown on the right of the file:

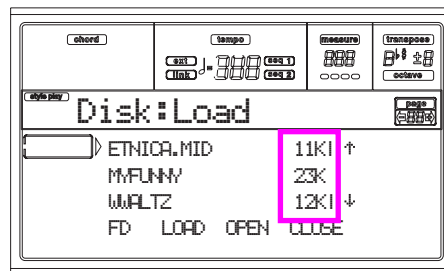

To see a folder size, first move it to the first line of the display, then keep the SHIFT button pressed, and press the F3 (Open) function key under the display. A dialog box will appear, showing the size of the folder:

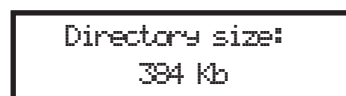

Press EXIT to exit this dialog.

PAGE STRUCTURE

Here is the typical structure of a Disk page.

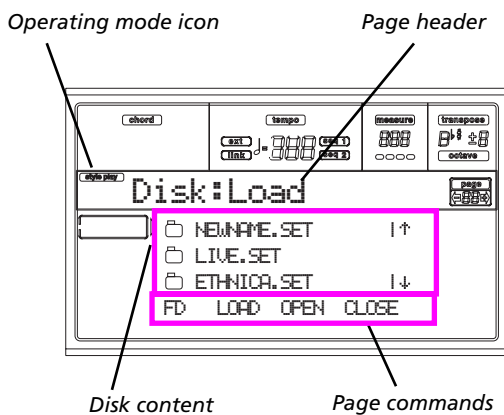

Operating mode icon

When in the Disk edit environment, one of the operating modes is still active in the background. The operating mode icon shows which mode is currently active. Press EXIT to go back to the current operating mode from any of the Disk pages.

Page header

This line shows the Disk page you are in.

Disk content

These lines show the content of the current folder. Move the item to select to the first line, using the E-F (Scroll Up) and G-H (Scroll Down) VOLUME/VALUE buttons, or the TEMPO/VALUE controls.

Use the Page commands (F1-F4) on the last line to execute an operation on the selected file or folder.

The "📁" symbol before a name identifies a folder (i.e., a "folder" containing other files).

Page commands

You can use these commands to browse through files and folders, and to execute disk commands (load, save...). Commands may be different in any Disk page. Use the F1-F4 buttons to select the corresponding command.

NAVIGATION TOOLS

When in a Disk page, you can use any of the following commands to browse through the files and folders, or through the list of commands.

E-F (Scroll Up)

Scroll the list up. Keep SHIFT pressed and press one of these buttons to jump to the previous alphabetical section.

G-H (Scroll Down)

Scroll the list down. Keep SHIFT pressed and press one of these buttons to jump to the next alphabetical section.

TEMPO/VALUE section

These controls scroll the list up or down.

F1 (FD)

Press this button after replacing a floppy disk in the floppy disk drive. After pressing this button, the new disk will be scanned, and the file list shown on the display will be updated.

F2 (Disk command)

Executes the disk operation.

F3 (Open)

Opens the selected folder or bank (files whose name begins with the "📁" icon).

F4 (Close)

Closes the current folder, returning to the parent ("upper") folder.

MENU

From any page, press MENU to open the Disk edit menu. This menu gives access to the various Disk edit pages.

When in this menu, select a section using the VOLUME/VALUE buttons, press PAGE+ to select a page, or press EXIT to exit the menu.

When in any page, press EXIT to go back to the current operating mode.

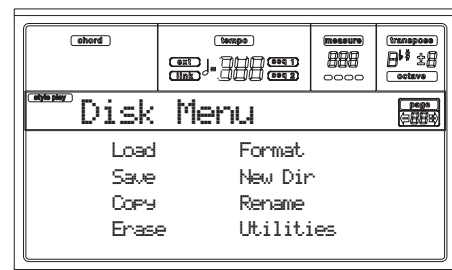

PAGE 1 - LOAD

In this page you can load files from a disk to the internal memory.

Press DISK and use the MENU button to reach this page.

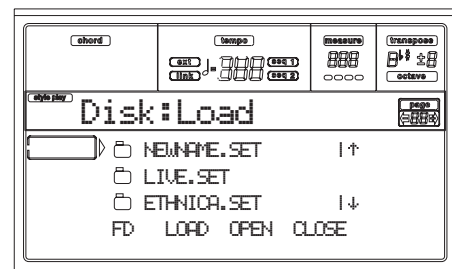

Loading all the User data

You can load all the User data (Performances, User Programs, User Styles, Global) with a single operation.

1. Insert the source disk into the disk drive.
2. Press F1 to scan the disk and show the file list.
3. Use the E-H (Scroll) buttons (or the TEMPO/VALUE controls) to select the ".SET" folder containing the data you wish to load.

Move the folder to the first line of the display. If the folder you are looking for is in another folder, use the F3 (Open) button to open it. Use the F4 (Close) button to go back to the parent folder.

4. Press F2 (Load) to confirm the selection. The "Are you sure?" message appears. Press ENTER to confirm, or EXIT to abort.

When the operation is completed (the “Wait” indicator disappears), the source page comes back in the display, and you may perform further loading operations.

Note: Data loaded from disk, and data already in memory is merged. For example, if there is data in all three USER Style banks in memory (USER01, USER02, USER03), and there is only the USER01 Style bank on disk, the USER01 bank is overwritten, while USER02 and USER03 banks are left unchanged.

As a result, you will have a STYLE folder in memory containing the USER01 bank you just loaded, and the old USER02 and USER03 banks.

Loading all data of a specified type

You can load all User data of a specified type (User Programs, User Styles, Performances) with a single operation.

1. Insert the source disk into the disk drive.
2. Press F1 to scan the disk and show the file list.
3. Use the E-H (Scroll) buttons (or the TEMPO/VALUE controls) to select the “.SET” folder containing the data you wish to load.
Move the folder to the first line of the display. If the folder you are looking for is in another folder, use the F3 (Open) button to open it. Use the F4 (Close) button to go back to the parent folder.
4. Press F3 (Open) to open the “.SET” folder. A list of User data appears (Performance, Program, Style, Global).

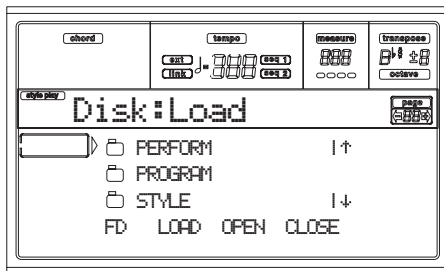

5. Use the E-H (Scroll) buttons (or the TEMPO/VALUE controls) to move the data type you are looking for to the first line of the display.
6. Press F2 (Load) to confirm your selection. The “Are you sure?” message will appear. Press ENTER to confirm, or EXIT to abort.

When the operation is completed (the “Wait” indicator disappears), the source page comes back in the display, and you may perform further loading operations.

Note: Data loaded from disk, and data already in memory are merged. For example, if there is data in all three USER Style banks in memory (USER01, USER02, USER03), and there is only the USER01 Style bank on disk, the USER01 bank is overwritten, while USER02 and USER03 banks are left unchanged.

As a result, you will have a STYLE folder in memory containing the USER01 bank you just loaded, and the old USER02 and USER03 banks.

Loading a single bank

You can load a single bank of User data (User Programs, User Styles, Performances) with a single operation. A bank corresponds to a STYLE or PROGRAM/PERFORMANCE button.

1. Insert the source disk into the disk drive.
2. Press F1 to scan the disk and show the file list.
3. Use the E-H (Scroll) buttons (or the TEMPO/VALUE controls) to select the “.SET” folder containing the data you wish to load.

Move the folder to the first line of the display. If the folder you are looking for is in another folder, use the F3 (Open) button to open it. Use the F4 (Close) button to go back to the parent folder.

4. Press F3 (Open) to open the “.SET” folder. A list of User data appears (Global, Performance, Program, Style).

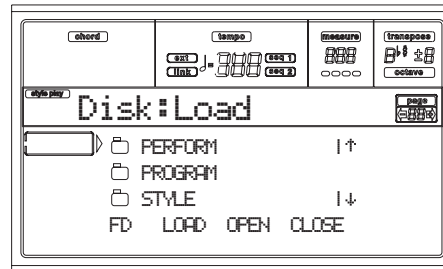

5. Use the E-H (Scroll) buttons (or the TEMPO/VALUE controls) to move the data type you are looking for to the first line of the display.
6. Press F3 (Open) to open the selected folder. A list of User banks appears.

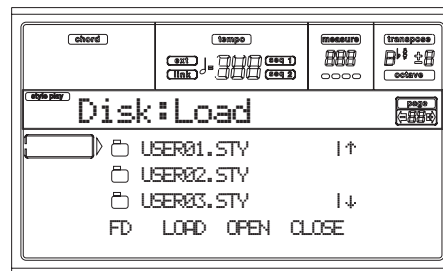

7. Use the E-H (Scroll) buttons (or the TEMPO/VALUE controls) to move the desired bank to the first line of the display.
8. Press F2 (Load) to confirm the file selection. The list of User banks in memory appears.

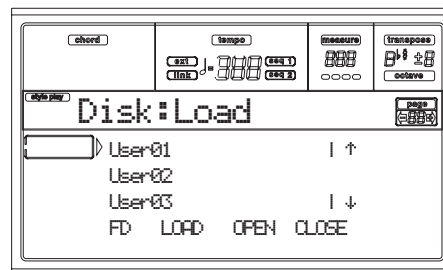

In the page above, the previously selected Style bank will be loaded into the bank 1 (USER1 button) in memory. The existing Styles in memory will be deleted and overwritten.

9. Scroll the available locations in memory, using the E-H (Scroll) buttons (or the TEMPO/VALUE controls).
10. When the target bank is selected (i.e., it is in the first line of the display), press F2 (Load) to load the bank. The “Are you sure message” will appear. Press ENTER to confirm, or EXIT to abort.

Warning: After confirming, all User data contained in the bank in memory is deleted.

When the operation is completed (the “Wait” indicator disappears), the source page comes back in the display, and you may perform further loading operations.

Loading a single item

You can load a single User item (i.e., a single User Program, a single User Style, or a single Performance) with a single operation.

1. Insert the source disk into the disk drive.
2. Press F1 to scan the disk and show the file list.
3. Use the E-H (Scroll) buttons (or the TEMPO/VALUE controls) to select the “.SET” folder containing the item you wish to load.

Move the folder to the first line of the display. If the folder you are looking for is in another folder, use the F3 (Open) button to open it. Use the F4 (Close) button to go back to the parent folder.

4. Press F3 (Open) to open the “.SET” folder. A list of User data appears (Global, Performance, Program, Style).



5. Use the E-H (Scroll) buttons (or the TEMPO/VALUE controls) to move the data type you are looking for to the first line of the display.
6. Press F3 (Open) to open the selected folder. A list of User banks appears.

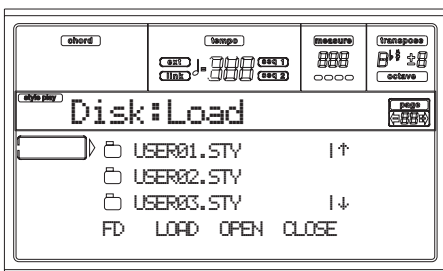

7. Use the E-H (Scroll) buttons (or the TEMPO/VALUE controls) to move the desired bank to the first line of the display.
8. Press F3 (Open) to open the selected bank. A list of User items appears.

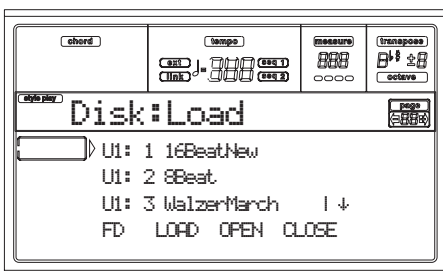

9. Use the E-H (Scroll) buttons (or the TEMPO/VALUE controls) to move the desired item to the first line of the display.

10. Press F2 (Load) to confirm the file selection. The internal memory file list appears. If you are loading a single file or bank of Styles, Programs or Performances, you are prompted to choose a destination in memory. For example, when loading a single Style, after selecting the Load command, a page similar to the following appears in the display:

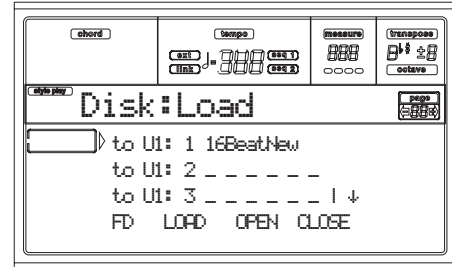

In the page above, the previously selected Style will be loaded into the location U1:1 (USER1 button, Style 01) in memory. The existing Style in memory will be deleted and overwritten.

11. Scroll the available locations in memory, using the E-H (Scroll) buttons (or the TEMPO/VALUE controls). When the target location is selected (i.e., it is in the first line of the display), press F2 (Load) to load the file. Locations marked with a row of underscores (“_ _ _”) are empty locations.
12. Once the target location is selected, press F2 (Load) to load the file. The “Are you sure?” message will appear. Press ENTER to confirm, or EXIT to abort.

Warning: After confirming, the item you are overwriting in memory will be deleted.

When the operation is completed (the “Wait” indicator disappears), the source page comes back in the display, and you may perform further loading operations.

PAGE 2 - SAVE

In this page, you can save User data from the internal memory to a disk. You can save files, banks, or all the User files of the internal memory.

Press DISK and use the MENU or PAGE buttons to reach this page.

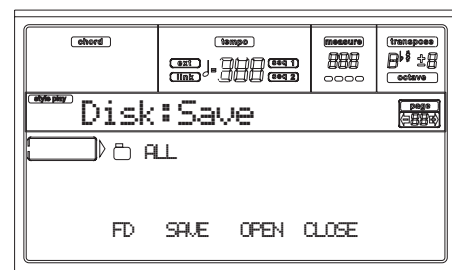

Here are the various types of files contained in memory:

The file/folder type...	...contains...	...and will create on disk...
ALL	All the User data in memory	A .SET folder
Style	The USER 01-03 Styles	A STYLE folder inside a .SET folder

The file/folder type...	...contains...	...and will create on disk...
Program	The USER Programs and Drum Kits	A PROGRAM folder inside a .SET folder
Perform (Performances)	The Performances	A PERFORM folder inside a .SET folder
.GBL file	The Global. All parameters marked with ▶GBL within the Style Play, Song Play, Song and Global chapters are saved in the Global.	A GLOBAL folder inside a .SET folder

Saving the whole memory content

You can save the whole content of the memory with a single operation.

1. Insert the target disk into the disk drive.
2. The whole content ("All") of the internal memory is already selected. Press F2 (Save) to confirm the selection.
3. The content of the target disk appears.

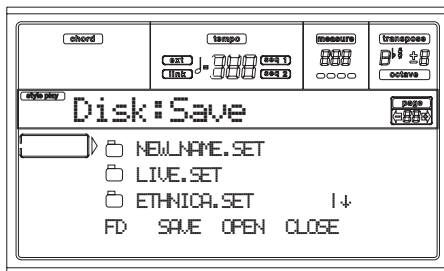

At this point, you can:

- Create a new ".SET" folder (see "Creating a new ".SET" folder" on page 138).
 - Save onto an existing ".SET" folder.
4. If you are saving into an existing folder, move the desired ".SET" folder to the first line of the display, using the E-H (Scroll) buttons (or the TEMPO/VALUE controls).
 5. Once the target folder is selected, press F2 (Save) to save the files. The "Are you sure?" message will appear. Press ENTER to confirm, or EXIT to abort.

Warning: After confirming, all data in the target folder is deleted.

When the operation is completed (the "Wait" indicator disappears), the source page comes back in the display, and you may perform further saving operations.

Saving all data of a specific type

You can save all data of a specific type with a single operation.

1. Insert the target disk into the disk drive.
2. The whole content ("All") of the internal memory is already selected. Press F3 (Open) to open the "All"

folder. A list of User data types appear (each type is a separate folder).

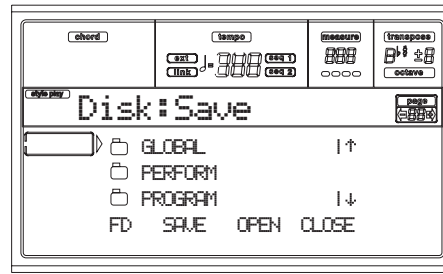

3. Use the E-H (Scroll) buttons (or the TEMPO/VALUE controls) to move the data type you are looking for to the first line of the display.
4. Once you have selected the type of data required, press F2 (Save) to confirm the selection.
5. The content of the target disk appears.

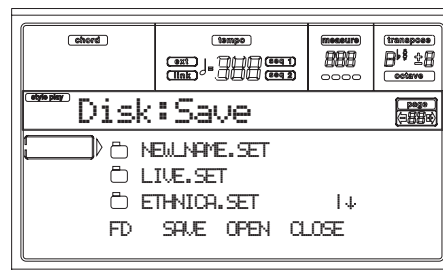

At this point, you can:

- Create a new ".SET" folder (see "Creating a new ".SET" folder" on page 138).
 - Save onto an existing ".SET" folder.
6. If you are saving into an existing folder, move the desired ".SET" folder to the first line of the display, using the E-H (Scroll) buttons (or the TEMPO/VALUE controls).
 7. Once the target folder is selected, press F2 (Save) to save the files. The "Are you sure?" message will appear. Press ENTER to confirm, or EXIT to abort.

Warning: After confirming, all data in the target folder is deleted.

When the operation is completed (the "Wait" indicator disappears), the source page comes back in the display, and you may perform further saving operations.

Saving a single bank

You can save a single User bank with a single operation. A bank corresponds to a button on the control panel of the instrument (i.e. a button of the STYLE section).

1. Insert the target disk into the disk drive.
2. The whole content ("All") of the internal memory is already selected. Press F3 (Open) to open the "All"

folder. A list of User data types appear (each type is a separate folder).

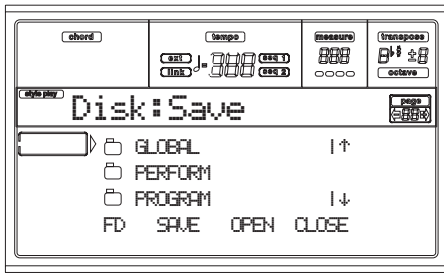

3. Use the E-H (Scroll) buttons (or the TEMPO/VALUE controls) to move the data type you are looking for to the first line of the display.
4. Once the data type is selected, press F3 (Open) to open the folder and gain access to the separate banks.

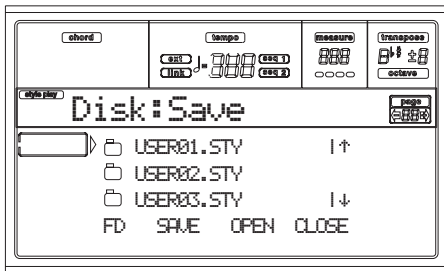

5. Use the E-H (Scroll) buttons (or the TEMPO/VALUE controls) to move the bank to save to the first line of the display.
6. Once you have selected the bank that you want to save, press F2 (Save) to confirm the selection.
7. The content of the target disk appears.

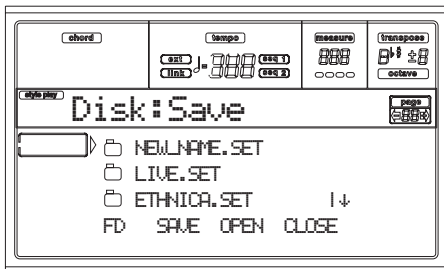

At this point, you can:

- Create a new ".SET" folder (see "Creating a new ".SET" folder" on page 138).
- Save onto an existing ".SET" folder.

8. If you are saving into an existing folder, move the desired ".SET" folder to the first line of the display, using the E-H (Scroll) buttons (or the TEMPO/VALUE controls).
9. Press F2 (Save) to confirm. A list of banks on the target disk appears. Only banks of the selected type are shown.
10. Use the E-H (Scroll) buttons (or the TEMPO/VALUE controls) to move the target bank to the first line of the display.

11. Once the target bank is selected, press F2 (Save) to save the files. The "Are you sure?" message will appear. Press ENTER to confirm, or EXIT to abort.

Warning: If you confirm, any data in the target bank will be deleted.

When the operation is completed (the "Wait" indicator disappears), the source page comes back in the display, and you may perform further saving operations.

Saving a single item

You can save a single User item with a single operation.

1. Insert the target disk into the disk drive.
2. The whole content ("All") of the internal memory is already selected. Press F3 (Open) to open the "All" folder. A list of User data types appear (each type is a separate folder).

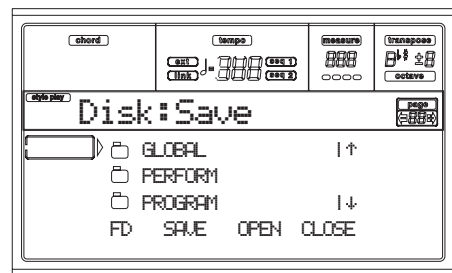

3. Use the E-H (Scroll) buttons (or the TEMPO/VALUE controls) to move the data type you are looking for to the first line of the display.
4. Once the data type is selected, press F3 (Open) to open the folder and gain access to the separate banks.

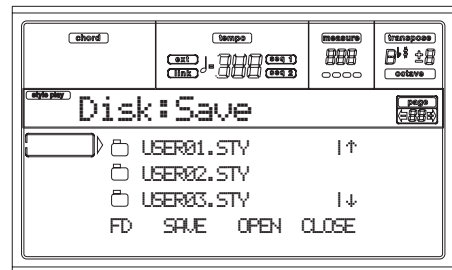

5. Use the E-H (Scroll) buttons (or the TEMPO/VALUE controls) to move the bank containing the file to save to the first line of the display.
6. Once you have selected the bank, press F3 (Open) to gain access to the single files.

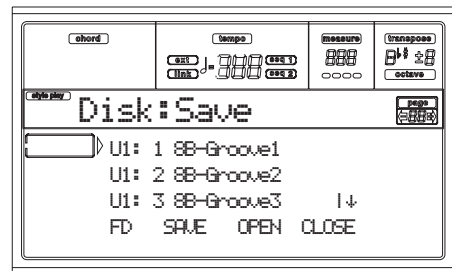

7. Once you have selected the file that you want to save, press F2 (Save) to confirm the selection.

8. The content of the target disk appears in the display.

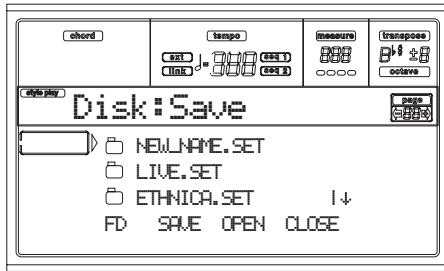

At this point, you can:

- Create a new “.SET” folder (see “Creating a new “.SET” folder” on page 138).
 - Save onto an existing “.SET” folder (saved data is merged with the existing data on disk).
9. If you are saving into an existing folder, move the desired “.SET” folder to the first line of the display, using the E-H (Scroll) buttons (or the TEMPO/VALUE controls).
10. Press F2 (Save) to confirm. A list of files on the target device appears. Only files of the selected type are shown.

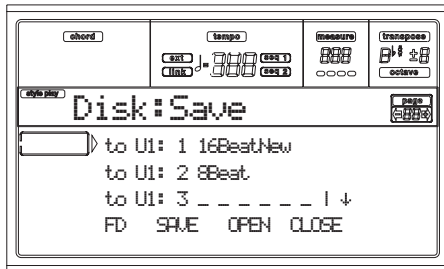

Locations marked with a row of underscores (“_”) are empty locations.

11. Use the E-H (Scroll) buttons (or the TEMPO/VALUE controls) to move the target location to the first line of the display.

12. Once the target location is selected, press F2 (Save) to save the file. The “Are you sure?” message will appear. Press ENTER to confirm, or EXIT to abort.

Warning: If you confirm, any data at the target location will be deleted.

When the operation is completed (the “Wait” indicator disappears), the source page comes back in the display, and you may perform further saving operations.

Creating a new “.SET” folder

When saving data (Save operations), you can save onto existing folders, or you can create a new “.SET” folder. Here is how to do it.

1. When the file list of the target disk is in the display, use the E-H (Scroll) buttons (or the TEMPO/VALUE controls) to move the “NEW_NAME.SET” item to the first line of the display.
Note: A “NEW_NAME.SET” item is always the first item in any directory.
2. When the “NEW_NAME.SET” item is selected, press one of the A VOLUME/VALUE buttons. You are prompted to assign a name to the new folder:

NEW_NAME.SET

3. Move the cursor using the DOWN/- and UP/+ buttons. Select a character using the DIAL. Insert a character at the cursor position by pressing the INSERT button. Delete a character at the cursor position by pressing the DELETE button.
4. When you have finished writing a name for the new folder, press F2 (Save) to confirm. The “Are you sure?” message will appear. Press ENTER to confirm, or EXIT to abort.

PAGE 3 - COPY

In this page you can copy single files (i.e., midifiles of Jukebox files), whole folders (generic or “.SET” folders), or a generic folder’s content. You can copy within the same disk, or from a disk to a different one.

To preserve the data structure integrity, during Copy operations you can’t open a “.SET” folder, and copy one of its files. You can only open generic folders.

Press DISK and use the MENU or PAGE buttons to reach this page.

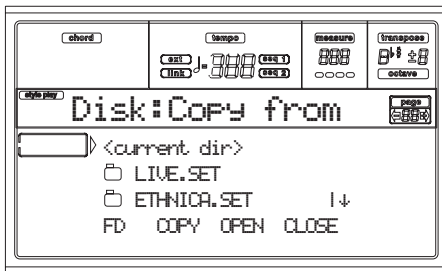

Copying a whole folder or folder’s content

You can copy a folder (generic or “.SET”) into a different disk or folder. If selecting the <current dir> item, you can copy the current folder’s content, without copying the folder itself. If copying a whole folder, a new folder with the same name is created at the target location.

Note: During the Copy procedure, you can’t open a “.SET” folder. You can, anyway, open any generic folder.

1. Insert the source disk into the disk drive.
2. Press F1 to scan the disk and show the file list.
3. Move the folder that you want to copy to the first line of the display. If it is contained in another folder, use the F3 (Open) button to open it. Press F4 (Close) to go back to the previous hierarchic level.

To copy just the current folder’s content, move the <current dir> item to the first line of the display.

4. Once the item to copy is on the first line, press F2 (Copy) to confirm the item selection. You are prompted to insert a target disk. The window’s header changes from “Copy from” to “Copy to”.



5. Insert the target disk, and press F1 to update the file list shown on the display.
6. When the target disk content appears in the display, move the target folder to the first line in the display.
 - To copy into an existing generic folder (not a “.SET” folder), select that folder.
 - To copy into the current folder, select the <current dir> item.

7. Once the target is selected, press F2 (Copy). The “Overwrite?” message appears:

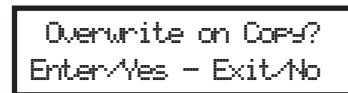

Press ENTER to confirm overwriting, EXIT to avoid it. When you decide to **overwrite**, the data you are copying will replace the existing data on the target. For example, if the same midifile exists on the target folder, it will be overwritten. If a USER bank exists, it will be overwritten.

Data that doesn’t exist on the source folder is left unchanged. For example, if the USER03 Style bank exists on the target folder, but not in the source folder, it is left untouched after copying the other banks.

When you decide **not to overwrite**, data existing on the target folder is left unchanged, therefore are not copied.

8. The “Are you sure?” message appears. Press ENTER to confirm, EXIT to abort the copy.

Copying a single file

You can copy a single file from a generic folder to a different folder. The file must reside on the root (the main/highest folder in the disk hierarchy) or into a generic folder. You can’t copy single files from a “.SET” folder.

1. Insert the source disk into the disk drive.
2. Press F1 to scan the disk and show the file list.
3. Move the folder, containing the file you wish to copy, to the first line of the display. If it is contained in another folder, use the F3 (Open) button to open it. Press F4 (Close) to go back to the previous hierarchic level.
4. Press F3 (Open) to open the folder containing the file to copy.
5. Move the file to copy to the first line of the display.
6. Once the file is on the first line, press F2 (Copy) to confirm its selection. You are prompted to insert a target disk. The window’s header changes from “Copy from” to “Copy to”.

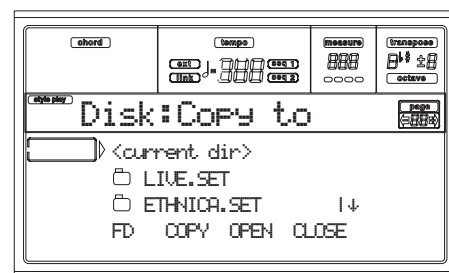

7. Insert the target disk, and press F1 to update the file list shown on the display.
8. When the target disk content appears in the display, move the target folder to the first line in the display. Press F3 (Open) to open a folder, F4 (Close) to close it.
9. Once the target is selected, press F2 (Copy). The “Overwrite?” message appears:

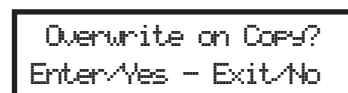

Press ENTER to confirm overwriting, EXIT to avoid it. When you decide to **overwrite**, the data you are copying will replace the existing data on the target. For example, if the same midfile exists on the target folder, it will be overwritten.

Data that doesn't exist on the source folder is left unchanged. For example, if the MYSONG01.MID midfile exists on the target folder, but not in the source folder, it is left untouched after copying the other data.

When you decide **not to overwrite**, data existing on the target folder is left unchanged, therefore are not copied.

- The "Are you sure?" message appears. Press ENTER to confirm, EXIT to abort the copy.

PAGE 4 - ERASE

The Erase function lets you erase files and folders from disks.

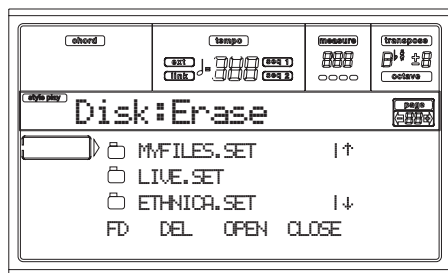

Erase procedure

- If the file to be deleted is contained in a floppy disk, insert the disk into the disk drive.
- Press F1 to select a device. Devices are selected in this order: FD -> SSD -> FD...

Device	Type
FD	Floppy disk
SSD	Solid State Disk (internal memory)

- Move the file or folder that you want to erase to the first line of the display. If the file or folder you are looking for is in another folder, use the F3 (Open) button to open it. Press F4 (Close) to go back to the previous hierarchic level.
- Press F2 (Erase) to delete the selected item. The "Are you sure?" message will appear. Press ENTER to confirm, or EXIT to abort.

When the operation is completed (the "Wait" indicator disappears), you are kept on the Erase page, and you may perform further erase operations.

PAGE 5 - FORMAT

The Format function lets you initialize a disk.

Press DISK and use the MENU or PAGE buttons to reach this page.

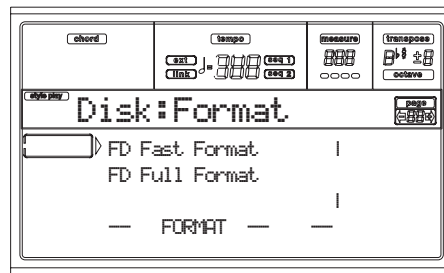

Warning: When formatting a disk, all data it contains is lost.

FD Fast Format

This is a very fast format command, that you can use on previously formatted floppy disks. This command rewrites just the FAT (File Allocation Table) of the disk, without actual reformatting of all sectors.

If it cannot be executed, the "FD Fast Format failed. Full Format?" message appears. Press ENTER/YES to proceed with the Full Format, or EXIT/NO to abort.

- Insert a 3.5" HD or DD/DS floppy disk into the disk drive, and select this option to format it.
- Move the FD Fast Format option to the first line of the display.
- Press F2 (Format) to confirm formatting.
- The "Delete all data?" message appears in the display; press ENTER to confirm, EXIT to abort.

FD Full Format

This is the traditional format command, where each sector of the floppy disk is formatted. It is slower than the Fast Format command, but sometimes more reliable.

See above for the procedure.

PAGE 6 - NEW DIR

The New Dir function lets you create a new folder in any of the disks, or inside any generic folder. You can't create or open ".SET" folders, since these are reserved folders, to be created with a Save operation.

Press DISK and use the MENU or PAGE buttons to reach this page.



New folder procedure

- Insert a disk into the disk drive.
- Press F1 to scan the disk.
- Press one of the A VOLUME/VALUE buttons. You are prompted to assign a name to the new folder:

NEW NAME

Move the cursor using the DOWN/- and UP/+ buttons. Select a character using the DIAL. Insert a character at

the cursor position by pressing the INSERT button. Delete a character at the cursor position by pressing the DELETE button.

4. Press F2 (Create) to confirm. The “Are you sure?” message appears. Press ENTER to confirm, EXIT to abort.

PAGE 7 - RENAME

Use the Rename function to change the name of a folder or a file. To preserve data structure consistence, you can't rename single files inside a “.SET” folder, or the “.SET” folder name extension.

Press DISK and use the MENU or PAGE buttons to reach this page.

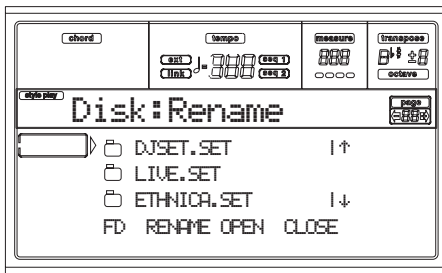

Rename procedure

1. Insert the disk that contains the file to be renamed into the disk drive.
2. Press F1 to scan the disk.
3. Move the item to rename to the first line. Then press one of the A VOLUME/VALUE buttons. You are prompted to change the name:

ethnic.set

Move the cursor using the DOWN/- and UP/+ buttons. Select a character using the DIAL. Insert a character at the cursor position by pressing the INSERT button. Delete a character at the cursor position by pressing the DELETE button.

4. Press F2 (Rename) to confirm. The “Are you sure?” message appears. Press ENTER to confirm, EXIT to abort.

PAGE 8 - UTILITIES 1

This page includes a set of disk utilities.

Press DISK and use the MENU or PAGE buttons to reach this page.



FD info

Select this command to see the name of the inserted floppy disk, and the free space on it.

If pressed without a disk inserted, the “No disk!” warning appears. Please, insert a disk and press ENTER (or EXIT to abort).

SSD info

Select this command to see the free space on the Solid State Disk (SSD), used as the system's internal memory.

Save OS

This command starts an Operating System backup, to save a copy of the instrument's Operating System on a floppy disk.

Note: Should you not do a back-up and your internal data is changed, you can download the data from www.korgpa.com, or ask your local KORG dealer.

1. Prepare a formatted, empty disk (1.44MB, MS-DOS formatted). You can prepare this kind of disk using a PC or the Pa50 itself (see “Page 5 - Format” on page 140).

Note: You can't prepare a Pa50 OS disk on a Macintosh. After formatting, the Mac includes some invisible files in the root, that may interfere with the Pa50 OS loading procedure.

2. Select the Save OS command.
3. Insert a disk and press ENTER. The following files are created on disk:

- OSPa50.LZX
- BPa50.SYS
- NBPa50.SYS

If the disk is not formatted or empty, Pa50 asks if you want to format it:

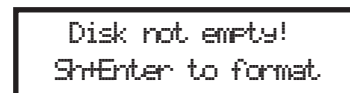

Keep SHIFT pressed, and press ENTER to format the disk. Pa50 first tries a Fast Format, then makes a Full Format if the former is not possible.

Backup Data

This command starts a backup of all internal factory data (Styles, Programs, Performances...) excluding the Operating System itself.

Note: Should you not do a back-up and your internal data is changed, you can download the data from www.korgpa.com, or ask your local KORG dealer.

1. Prepare 5 disks. Disks don't need to be formatted, because Pa50 will format them for you during the Backup procedure.
2. Select the Backup Data command.
3. The "Are you sure?" message appears. Press ENTER to continue, EXIT to abort.
4. The "Insert backup disk #1 and press Enter" message appears. Insert a disk and press ENTER
5. When the Pa50 asks for it, insert a new disk into the floppy disk drive. Write the disk number on each disk's label.

```
Insert 1.44MB FD #1
and press Enter
```

If a disk is not formatted or empty, Pa50 asks if you want to format it:

```
Disk not empty!
Shift+Enter to format
```

Keep SHIFT pressed, and press ENTER to format the disk. Pa50 first tries a Fast Format, then makes a Full Format if the former is not possible.

Restore Data

This command restores the backup of the internal factory data, executed with the "Backup Data" command.

Note: Should your Factory Data disks become corrupt, you can download the data from www.korgpa.com, or ask your local KORG dealer.

Warning: Don't play on the keyboard while restoring data, and stay in the Disk mode. Wait until the "Wait" message disappears, and the WRITE/DISK IN USE LED turns off.

1. Select this command.
2. The "Are you sure?" message appears. Press ENTER to continue, EXIT to abort.
3. The "Insert backup disk #1 and press Enter" message appears. Insert the first backup disk, and press ENTER.
4. Wait until the first backup disk has been read. A message will appear: "Insert backup disk #2 and press Enter". Insert the second backup disk and press ENTER.
5. Repeat the same procedure with backup disks #3, #4 and #5. When the backup disk #5 has been loaded, the backup data has been restored into the internal memory.

Note: After the last disk has been loaded, a "Some files missing" message may appear. This may refer to some User

data, so it is not a problem. Press EXIT to exit the message.

6. When the Wait message has disappeared, and the WRITE/DISK IN USE LED has turned off, turn the instrument off, then on again.

Note: At the end of a Restore Data operation, the "Missing some files" error message may appear. This is due to the lack of Performance banks 11-20 on older versions of the operating system of Pa80, whose disk you are probably reading. However, this is not a problem. Press EXIT to close the message window.

PAGE 9 - UTILITIES 2

This page includes the Protect functions.



Global Protect

► GBL

When loading a ".SET" file, this parameter (if On) protects the Global from being reprogrammed by the loaded data. All Global parameters are therefore left unchanged.

When loading a single ".GLB" file, this parameter is ignored, and the Global is overwritten by the loaded data.

Note: This parameter is saved in memory, but not on disk.

Factory Style Protect

When On, this parameter protects the Factory Styles (from the "8 BEAT/16 BEAT 1" to the "TRADITIONAL" bank) from being overwritten when loading data from disk. Furthermore, you can't access these banks when saving data.

When Off, you can load or save User Styles even into the Factory Styles banks (from "8 BEAT/16 BEAT 1" to "TRADITIONAL"). This way, you can personalize your Factory Style banks.

Please note that the Save All procedure always saves only the USER Style banks.

Note: This parameter is automatically set to On when turning the instrument off.

Note: Should you accidentally delete some Factory Data, reload the Backup data, contact your KORG dealer or service center, or download the data from www.korgpa.com.

APPENDIX

17. FACTORY DATA

STYLES

Note: You can remotely select Styles on the Pa50, by sending it Bank Select MSB (CC#0), Bank Select LSB (CC#32) and Program Change messages on the Control channel (see page 127).

#	CC#0	CC#32	PC	Bank: 8/16 Beat 1	CC#0	CC#32	PC	Bank: 8/16 Beat 2	CC#0	CC#32	PC	Ballad
1	0	0	0	Soft Beat	0	1	0	Guitar Bld1	0	2	0	Groove Bld
2			1	Pop Beat			1	Guitar Bld2			1	Diva
3			2	Stndrd8Beat			2	8Bt Analog1			2	Rock Ballad
4			3	Unplug8Bt 1			3	Analogyst			3	Folk Ballad
5			4	Love 8 Beat			4	8Bt Analog2			4	PopBallad 2
6			5	Half Beat			5	Trendy Beat			5	HalfTimeBld
7			6	UK 8 Beat			6	Slow Ballad			6	Country Bld
8			7	8BeatGroove			7	6Strings Bt			7	4/4 Ballad
9			8	UK RnB			8	Std16Beat 1			8	Love Ballad
10			9	PopBallad 1			9	Std16Beat 2			9	NaturalBeat
11			10	HipHop Beat			10	Unpl.16Beat			10	Celtic Bld
12			11	LightRock 1			11	Pop 16Beat1			11	16BtAnalog1
13			12	LightRock 2			12	Pop 16Beat2			12	Color Beat
14			13	Miami Beat			13	Cinema Bld			13	PopBallad 3
15			14	ClassicBeat			14	Windy Beat			14	8Bt Analog3
16			15	Unplug8Bt 2			15	Home Beat			15	16BtAnalog2
#	CC#0	CC#32	PC	Bank: Ballroom	CC#0	CC#32	PC	Bank: Dance	CC#0	CC#32	PC	Bank: Rock
1	0	3	0	Slow Pop	0	4	0	HouseGarage	0	5	0	Open Rock 1
2			1	Slow Rock 1			1	House			1	Open Rock 2
3			2	Slow Rock 2			2	Dream			2	Pop Rock
4			3	Unpl.SlRock			3	Techno			3	Fire Rock
5			4	BigBnd Fox1			4	Underground			4	Hard Rock
6			5	Slow Waltz1			5	Progressive			5	Heavy Rock
7			6	Slow Waltz2			6	Jungle			6	RockShuffle
8			7	Foxtrot 1			7	Rap			7	Rock Ballad
9			8	BigBnd Fox2			8	Hip Hop			8	Half Time
10			9	Slow Fox			9	Disco 70			9	Rock 6/8
11			10	Foxtrot 2			10	80's Dance			10	Abbey Road
12			11	Operetta			11	Love Disco			11	Surf Rock
13			12	BigBnd Fox3			12	Disco Party			12	Pop Shuffle
14			13	Charleston			13	Disco Funky			13	BluesShuffl
15			14	Quick Step			14	Disco Gully			14	60's Rock
16			15	New Jive			15	Twist			15	Rock & Roll
#	CC#0	CC#32	PC	Bank: Soul & Funk	CC#0	CC#32	PC	Bank: World 1	CC#0	CC#32	PC	Bank: World 2
1	0	6	0	Rubber Funk	0	7	0	OberkrWaltz	0	8	0	Bluegrass
2			1	Groove Funk			1	OberkrPolka			1	Country 8Bt
3			2	Acid Jazz			2	Bavar.Pop1			2	Country16Bt
4			3	Double Beat			3	Bavar.Pop 2			3	CountryBeat
5			4	Groove			4	Party Polka			4	Mod.Country
6			5	Jazz Funk			5	Pop Polka			5	CntryBoogie
7			6	Al Swing			6	Flipper 6/8			6	CountryShf1
8			7	HipHop Funk			7	Flipper 4/4			7	CountryShf2
9			8	HipHop Soul			8	Schlager 1			8	Country Bld
10			9	MotownShufl			9	Schlager 2			9	Country 3/4
11			10	PopBallad 4			10	Schlager 3			10	Orleans
12			11	RhythmBlues			11	Schlager 4			11	Jig
13			12	Soul			12	PopSchlager			12	CelticDream
14			13	Memphis			13	Trucker			13	Norteno
15			14	Motown			14	Cajun			14	Quebradita
16			15	Gospel			15	Zydeco			15	Tejano

#	CC#0	CC#32	PC	Bank: Direct FD Page 1-2	CC#0	CC#32	PC	Bank: Direct FD Page 3-4	CC#0	CC#32	PC	Bank: Direct FD Page 5-6
1	0	29	0-15	*.SET	0	30	0-15	*.SET	0	31	0-15	*.SET
2												
3												
4												
5												
6												
7												
8												
9												
10												
11												
12												
13												
14												
15												
16												

STYLE ELEMENTS

Note: You can remotely select the various Style Elements on the Pa50, by sending it Program Change messages on the Control channel (see page 127).

PC	Style Element	PC	Style Element	PC	Style Element	PC	Style Element	PC	Style Element
80	Var.1	81	Var.2	82	Var.3	83	Var.4	84	Intro 1
85	Intro 2	86	Fill 1	87	Fill 2	88	Ending 1	89	Ending 2
90	Break/Count IN	91	Fade IN/OUT	92	Memory	93	Bass Inversion	94	Manual Bass
95	Tempo Lock	96	Single Touch	97	Style Change				

SINGLE TOUCH SETTINGS (STS)

Note: You can remotely select Single Touch Settings (STS) on the Pa50, by sending it Bank Select MSB (CC#0), Bank Select LSB (CC#32) and Program Change messages on the Control channel (see page 127). If a Style is already selected, just send the Program Change message.

CC#0	CC#32	PC	STS	PC	STS	PC	STS	PC	STS
The same as the Style to which the STS pertains		64	STS 1	65	STS 2	66	STS 3	66	STS 4

PROGRAMS (BANK ORDER)

The following table enlists all Pa50 Factory Programs in the same order as they appear by pressing the PROGRAM/PERFORMANCE bank buttons.

Legend: The table also includes MIDI data used to remotely select the Programs. **CC00:** Control Change 0, or Bank Select MSB. **CC32:** Control Change 32, or Bank Select LSB. **PC:** Program Change.

Name	CC00	CC32	PC
Bank: Piano			
Grand Piano	121	3	0
Class.Piano	121	4	0
L/R Piano	121	5	0
AcPianoWide	121	1	0
Ac. Piano	121	0	0
BrightPian	121	0	1
ElGranPian	121	0	2
ElGrandWide	121	1	2
AcPianoDark	121	2	0
BrPianoWide	121	1	1
90's Piano	121	3	2
M1 Piano	121	2	2
2000'sPiano	121	4	2
ChorusPiano	121	5	2
Honky-Tonk	121	0	3
Honky-Wide	121	1	3
Piano Pad	121	2	1
Piano Pad 2	121	3	1
PnoStrngPad	121	4	1
Pno&Strings	121	7	0
PianoLayers	121	6	2
Piano&Vibes	121	6	0
Harpsichord	121	0	6
Harpsi Oct.	121	1	6
Harpsi Wide	121	2	6
HarpsiK.Off	121	3	6
Harpsi Korg	121	4	6
Clav	121	0	7
Pulse Clav	121	1	7
Clav Wah	121	2	7
Clav Snap	121	3	7
Sticky Clav	121	4	7
Bank: E. Piano			
ClubElPiano	121	11	4
DynoTine EP	121	10	4
Vintage EP	121	4	4
Pro-Dyno EP	121	5	4
ProStage EP	121	6	4
Studio EP	121	7	4
StereoDigEP	121	6	5
ClassDigiEP	121	7	5
EP Phase	121	4	5
Hybrid EP	121	8	5
Class.Tines	121	9	5
PhantomTine	121	10	5
Sweeping EP	121	12	5
WhitePad EP	121	13	5
ThinElPiano	121	9	4

Name	CC00	CC32	PC
DW8000 EP	121	11	5
E.Piano 1	121	0	4
E.Piano 2	121	0	5
DetunedEP 1	121	1	4
EP1Veloc.sw	121	2	4
60'sElPiano	121	3	4
DetunedEP 2	121	1	5
EP2Veloc.sw	121	2	5
EP Legend	121	3	5
R&B E.Piano	121	8	4
SynPiano X	121	5	5
Bank: Mallet & Bell			
Vibraphone	121	0	11
Vibraphone2	121	2	11
Vibrap.Wide	121	1	11
Marimba	121	0	12
MarimbaWide	121	1	12
RimbaKeyOff	121	2	12
MonkeySkuls	121	3	12
Xylophone	121	0	13
Balaphon	121	6	12
Celesta	121	0	8
Glocken	121	0	9
Music Box	121	0	10
Sistro	121	1	9
Orgel	121	1	10
Digi Bell	121	4	98
Vs Bell Boy	121	2	98
Steel Drum	121	0	114
Warm Steel	121	1	114
TubularBell	121	0	14
Church Bell	121	1	14
Carillon	121	2	14
KrystalBell	121	3	98
ChurchBell2	121	3	14
Tinkle Bell	121	0	112
Dulcimer	121	0	15
Santur	121	1	15
Kalimba	121	0	108
VeloKalimba	121	1	108
MalletClock	121	5	12
Gamelan	121	1	112
BaliGamelan	121	2	112
GarbageMall	121	3	112
Bank: Accordion			
Sweet Harm.	121	1	22
Harmonica	121	0	22
Harmonica 2	121	2	22
Cassotto	121	9	21
Fisa Master	121	8	21
Fisa 16+8	121	6	21
Fisa 16+4	121	7	21
MusetteClar	121	5	21
Musette 1	121	3	21
Musette 2	121	4	21
Accordion	121	0	21
TangoAccord	121	0	23
Fisa Tango!	121	1	23
Akordeon	121	2	21

Name	CC00	CC32	PC
Accordion 2	121	1	21
Arab.Accord	121	10	21
Bank: Organ 1			
Jimmy Organ	121	10	18
BX3 Velo Sw	121	1	18
ClassiClick	121	4	18
M1 Organ	121	5	17
Jazz Organ	121	8	16
Dist. Organ	121	5	18
RotaryOrgan	121	8	17
DarkJazzOrg	121	4	16
Bx3ShortDec	121	7	17
SuperBX Perc	121	6	18
Percuss.BX3	121	4	17
Killer B	121	2	18
Drawb.Organ	121	0	16
DetDrawbOrg	121	1	16
lt60'sOrgan	121	2	16
DrawbOrgan2	121	3	16
Old Wheels	121	3	17
Perc. Organ	121	0	17
Det.PercOrg	121	1	17
Perc.Organ2	121	2	17
Rock Organ	121	0	18
Good Old B	121	10	16
Dirty B	121	3	18
IperDarkOrg	121	5	16
FullDrawbar	121	6	16
DWGS Organ	121	7	16
GospelOrgan	121	9	16
PercShorDec	121	8	18
Perc.Wheels	121	9	18
DirtyJazOrg	121	7	18
VOX Legend	121	11	16
TeknoOrgBas	121	6	17
ArabianOrg.	121	12	16
Bank: Organ 2			
PipeMixture	121	3	19
FlautoPipes	121	3	20
Pipe Tutti	121	6	19
PositiveOrg	121	7	19
ChurchOrg.1	121	0	19
ChurchOcMix	121	1	19
DetunChurch	121	2	19
ChurchPipes	121	4	19
Full Pipes	121	5	19
Reed Organ	121	0	20
Puff Organ	121	1	20
Small Pipe	121	2	20
Bank: Guitar			
NylonGuitar	121	0	24
Spanish Gtr	121	6	24
SteelGuitar	121	0	25
12StringGtr	121	1	25
Club J.Gtr1	121	2	26
CleanGuitar	121	0	27
MutedGuitar	121	0	28
DistortionG	121	0	30
Nylon Bossa	121	4	24

Name	CC00	CC32	PC
NylonKeyOff	121	2	24
Steel Gtr 2	121	4	25
AcGtrKeyOff	121	5	24
Club J.Gtr2	121	3	26
Vintage S.	121	4	27
CleanMutGtr	121	6	28
Stereo Dist	121	8	30
Nylon Gtr 2	121	3	24
Gtr Strings	121	7	24
FingerK.Off	121	7	25
St12Strings	121	5	25
Jazz Guitar	121	0	26
SingleCoil	121	6	27
Clean Funk	121	8	28
JoystGtr Y-	121	3	30
Reso.Guitar	121	12	25
St.Folk Gtr	121	9	25
Steel&Body	121	3	25
Hackbrett	121	6	25
Jazz Man	121	3	28
DetCleanGtr	121	1	27
R&R Guitar	121	4	28
OverdriveG	121	0	29
Ukulele	121	1	24
Mandolin	121	2	25
Mandol.KOff	121	10	25
MandoTrem	121	11	25
Banjo	121	0	105
BanjoKeyOff	121	1	105
Bouzouki	121	5	104
Tambra	121	6	104
Finger Tips	121	8	25
MidToneGtr	121	2	27
Chorus Gtr	121	3	27
ProcesElGtr	121	5	27
NewStra.Gtr	121	7	27
DistRhytmGt	121	2	30
WetDistGtr	121	6	30
SoloDistGtr	121	7	30
L&R El.Gtr	121	9	27
L&R El.Gtr2	121	10	27
RhythmElGtr	121	7	28
Guitarish	121	8	27
Country Nu	121	11	27
Stra. Chime	121	5	28
MuteMonster	121	5	30
Disto Mute	121	9	28
FunkyCutGtr	121	1	28
MuteVeloGtr	121	2	28
FeedbackGtr	121	1	30
Guitar Pinc	121	1	29
Ped.Steel 2	121	4	26
PedSteelGtr	121	1	26
GtrFeedback	121	1	31
PowerChords	121	4	30
FunkyWhaSw	121	12	27
VoxWahChick	121	3	120
EGHarmonics	121	2	31
GtrHarmonic	121	0	31
Sitar	121	0	104

Name	CC00	CC32	PC
Sitar 2	121	1	104
SitarTambou	121	2	104
IndianStars	121	3	104
Oud	121	2	105
Kanun	121	2	107
Kanun Trem.	121	3	107
Kanun Mix	121	4	107
Shamisen	121	0	106
Koto	121	0	107
Taisho Koto	121	1	107
IndianFrets	121	4	104
Bank: Strings & Vocals			
Solo Violin	121	2	40
StringQuart	121	9	48
Ens. & Solo	121	11	48
St. Strings	121	3	48
Analog Str	121	2	50
i3 Strings	121	5	48
Oh-AhVoices	121	9	52
Take Voices	121	4	52
Slow Violin	121	3	40
Camera Str.	121	12	48
ArcoStrings	121	7	48
LegatoStrng	121	4	48
MasterPad	121	2	89
N Strings	121	6	48
OhSlowVoice	121	3	52
TakeVoices2	121	5	52
SlowAttViol	121	1	40
PizzEnsembl	121	1	45
Fiddle	121	0	110
PizzSection	121	2	45
SweeperStr.	121	1	49
AnalogVelve	121	3	50
Aaah Choir	121	7	52
Oooh Voices	121	2	52
Violin	121	0	40
Viola	121	0	41
Cello	121	0	42
Contrabass	121	0	43
Tremolo Str	121	0	44
PizzicatoSt	121	0	45
Choir Aahs	121	0	52
Voice Ooohs	121	0	53
StringsEns1	121	0	48
StringsEns2	121	0	49
Orches.Harp	121	0	46
60s Strings	121	2	48
Oct.Strings	121	8	48
SynStrings3	121	1	50
Oooh Choir	121	6	52
Choir Aahs2	121	1	52
String&Bras	121	1	48
Dbl Strings	121	3	45
ArabStrings	121	13	48
SynStrings1	121	0	50
SynStrings2	121	0	51
Odissey	121	4	50
Grand Choir	121	11	52

Name	CC00	CC32	PC
Slow Choir	121	10	52
Symph. Bows	121	10	48
Cyber Choir	121	2	85
Choir Light	121	12	52
Vocalesque	121	2	54
Synth Voice	121	0	54
Voice Lead	121	0	85
Choir Pad	121	0	91
Halo Pad	121	0	94
FullVox Pad	121	9	91
FreshBreath	121	7	91
EtherVoices	121	1	85
DreamVoice	121	5	54
Humming	121	1	53
AnalogVoice	121	1	54
Mmmh Choir	121	8	52
StringChoir	121	13	52
ClassicVox	121	4	54
Doolally	121	2	53
Fresh Air	121	2	91
Vocalscape	121	3	54
Heaven	121	3	91
Airways	121	3	53
Yang Chin	121	1	46
Bank: Trumpet & Trombone			
MonoTrumpet	121	3	56
Flugel Horn	121	7	56
TrumpetPitch	121	5	56
TrumpetExpr	121	4	56
HardTrombon	121	3	57
SoftTrombon	121	4	57
Wha Trumpet	121	2	59
Muted Trp	121	0	59
Dual Trump	121	6	56
Warm Flugel	121	8	56
Trumpet	121	0	56
Trumpet 2	121	2	56
Trombone	121	0	57
Trombone 2	121	1	57
PitchTromb	121	5	57
BeBopCornet	121	9	56
DarkTrumpet	121	1	56
Tuba	121	0	58
Tuba Gold	121	2	58
Ob.Tuba	121	1	58
Dynabone	121	3	58
BrightTromb	121	2	57
Muted Trp 2	121	1	59
Bank: Brass			
BigBandBras	121	4	61
Tight Brass	121	2	61
Trp & Brass	121	7	61
Glen&Friend	121	3	61
MutEnsemble	121	3	59
Horns & Ens	121	4	60
Syn Brass	121	0	62
Orches. Hit	121	0	55
BrassSect.	121	0	61
Fat Brass	121	13	61

Name	CC00	CC32	PC
Trumpet Ens	121	9	61
Glen & Boys	121	6	61
MutEnsembl2	121	4	59
French Horn	121	0	60
Syn Brass	121	0	63
Brass Hit	121	25	61
AttackBrass	121	8	61
BrassSect.2	121	1	61
TromboneEns	121	10	61
Sax & Brass	121	5	61
Flute Muted	121	6	73
FrenchHorn2	121	1	60
Syn Brass 3	121	1	62
Euro Hit	121	3	55
TightBrass2	121	12	61
Dyna Brass	121	14	61
Trombones	121	11	61
Brass Band	121	16	61
Brass Pad	121	3	63
French Sect	121	2	60
Syn Brass 4	121	1	63
6th Hit	121	2	55
Power Brass	121	21	61
Brass Expr.	121	15	61
Dyna Brass2	121	22	61
Film Brass	121	17	61
Brass Slow	121	18	61
ClassicHorn	121	3	60
ElektrikBrS	121	4	62
BrassImpact	121	4	55
Fanfare	121	19	61
Movie Brass	121	20	61
Sfz Brass	121	23	61
Jump Brass	121	3	62
AnalogBras1	121	2	62
AnalogBras2	121	2	63
Syn Brass 5	121	5	62
Brass Fall	121	26	61
BassHitPlus	121	1	55
Dbl Brass	121	24	61
Bank: Sax			
Tenor Noise	121	1	66
Alto Breath	121	1	65
Sweet Sprno	121	1	64
Barit Growl	121	1	67
BreathyBari	121	2	67
Soft Tenor	121	2	66
SaxEnsemble	121	2	65
Folk Sax	121	5	66
Tenor Sax	121	0	66
Alto Sax	121	0	65
Soprano Sax	121	0	64
BaritoneSax	121	0	67
TenorBreath	121	3	66
Tenor Growl	121	4	66
BreathyAlto	121	3	65
AltSaxGrowl	121	4	65

Name	CC00	CC32	PC
Bank: Woodwind			
Jazz Flute	121	1	73
Old Shaku	121	1	77
FluteSwitch	121	2	73
FluteDyn5th	121	3	73
Flute Frull	121	4	73
Pan Flute	121	0	75
Jazz Clarin	121	1	71
Flute 2	121	9	73
Double Reed	121	1	68
EnglisHorn2	121	1	69
Recorder 2	121	1	74
Nay	121	2	72
Orch. Flute	121	5	73
WoodenFlute	121	7	73
War Pipes	121	1	109
ClarinetEns	121	5	71
Woodwinds	121	6	71
Small Orch	121	1	72
Kawala	121	1	75
Shaku 2	121	2	77
Whistle 2	121	1	78
Sect Winds	121	3	71
Sect Winds2	121	4	71
Clarinet G	121	2	71
Folk Clarin	121	7	71
Oboe	121	0	68
EnglishHorn	121	0	69
Bassoon	121	0	70
Clarinet	121	0	71
Piccolo	121	0	72
Flute	121	0	73
Recorder	121	0	74
Bambu Flute	121	8	73
BlownBottle	121	0	76
Shakuhachi	121	0	77
Whistle	121	0	78
Ocarina	121	0	79
Bag Pipe	121	0	109
Zurna	121	1	111
Hichiriki	121	2	111
Shanai	121	0	111
Flute Click	121	1	121
Bank: Synth 1			
The Pad	121	4	89
Future Pad	121	5	91
Air Clouds	121	1	97
Dark Pad	121	6	89
Tinklin Pad	121	3	97
Pods In Pad	121	4	97
Analog Pad	121	8	89
Analog Pad2	121	9	89
Money Pad	121	5	89
TsunamiWave	121	6	91
RavelianPad	121	8	91
AstralDream	121	1	95
Meditate	121	2	95
Reso Down	121	2	97
Sky Watcher	121	2	90

Name	CC00	CC32	PC
Super Sweep	121	4	90
Wave Sweep	121	5	90
Cross Sweep	121	6	90
Digi IcePad	121	2	101
Crimson5ths	121	1	86
Freedom Pad	121	7	89
Noble Pad	121	5	97
Mellow Pad	121	4	95
Lonely Spin	121	1	100
Cinema Pad	121	5	95
VirtualTrav	121	1	88
Syn Ghostly	121	2	100
MotionOcean	121	1	96
Moon Cycles	121	5	102
Farluce	121	11	90
Bell Pad	121	6	98
Bell Choir	121	7	98
Warm Pad	121	0	89
Sweep Pad	121	0	95
Soundtrack	121	0	97
Sine Pad	121	1	89
ltopia Pad	121	1	91
Big Panner	121	4	63
Dance ReMix	121	10	91
Rave	121	6	97
ElastickPad	121	7	97
Moving Bell	121	5	98
Bank: Synth 2			
Old Portam	121	3	80
Power Saw	121	5	81
Octo Lead	121	6	81
ElectroLead	121	2	87
Rich Lead	121	3	87
ThinAnaLead	121	4	87
Dance Lead	121	4	80
Wave Lead	121	5	80
Sine Wave	121	6	80
Synchro Cit	121	2	84
Wild Arp	121	6	55
EspressLead	121	5	87
HipHop Lead	121	6	87
Analog Lead	121	7	80
Seq Lead	121	7	81
Old&Analog	121	8	80
PhatSawLead	121	8	81
Glide Lead	121	9	81
Gliding Sq.	121	9	80
Flip Blip	121	7	55
Power Synth	121	3	89
Sine Switch	121	10	80
Reso Sweep	121	1	90
Syn Sweeper	121	3	90
Cosmic	121	1	93
MotionRaver	121	1	101
Sync Kron	121	3	84
Fire Wave	121	10	81
Dig PolySix	121	7	90
Pop Syn Pad	121	4	91
Noisy Stabb	121	8	90

Name	CC00	CC32	PC
Mega Synth	121	9	90
TecnoPhonic	121	10	90
DarkElement	121	3	95
Band Passed	121	3	102
Cat Lead	121	9	87
Pan Reso	121	4	102
Square Rez	121	11	80
Rezbo	121	11	81
Auto Pilot	121	14	38
MetallicRez	121	4	84
Square Bass	121	7	87
Syn Pianoid	121	12	81
Brian Sync	121	5	84
Arp Twins	121	6	84
Arp Angeles	121	2	88
Big & Raw	121	8	87
Caribbean	121	2	96
Lead Square	121	0	80
Lead Saw	121	0	81
Calliope	121	0	82
Chiff	121	0	83
Charang	121	0	84
Fifths Lead	121	0	86
Bass & Lead	121	0	87
New Age Pad	121	0	88
Polysynth	121	0	90
BowedGlass	121	0	92
MetallicPad	121	0	93
Crystal	121	0	98
Atmosphere	121	0	99
Brightness	121	0	100
LeadSquare2	121	1	80
Lead Sine	121	2	80
Lead Saw 2	121	1	81
LeadSawPuls	121	2	81
LeadDbISaw	121	3	81
Seq. Analog	121	4	81
Wire Lead	121	1	84
Soft Wrl	121	1	87
Bank: Bass			
Acous. Bass	121	0	32
Finger Bass	121	0	33
Picked Bass	121	0	34
Fretl. Bass	121	0	35
Slap Bass	121	0	36
Slap Bass	121	0	37
SynthBass	121	0	38
SynthBass	121	0	39
AcBass Buzz	121	1	32
Fing ElBass	121	2	33
Pick ElBass	121	1	34
Fret. Bass2	121	1	35
SuperSwBass	121	1	36
SuperSwBas2	121	2	36
SynBassWarm	121	1	38
SynBassReso	121	2	38
Bass & Ride	121	2	32
FingElBass2	121	3	33
PickElBass2	121	2	34

Name	CC00	CC32	PC
Fretless Sw	121	2	35
Thumb Bass	121	1	37
Finger Slap	121	1	33
Attack Bass	121	1	39
Rubber Bass	121	2	39
FingElBass3	121	4	33
DarkR&BBass	121	4	35
Sweet Fret	121	3	35
Dyna Bass	121	2	37
Stick Bass	121	5	33
Gtr Bass	121	4	34
Bass Mute	121	5	34
Dr. Octave	121	16	38
Nasty Bass	121	6	39
30303 Bass	121	5	38
Stein Bass	121	3	34
Euro Bass	121	4	39
Jungle Rez	121	5	39
30303Square	121	6	38
Bass Square	121	7	38
Phat Bass	121	7	39
SynBass Res	121	8	38
Clav Bass	121	3	38
Hammer	121	4	38
AttackPulse	121	3	39
Digi Bass 1	121	9	38
BlindAsABat	121	12	38
PoinkerBass	121	8	39
Digi Bass 3	121	11	38
Jungle Bass	121	13	38
Hybrid Bass	121	15	38
Digi Bass 2	121	10	38
Bank: Drum & Perc			
Std. Kit1	120	0	0
Std. Kit2	120	0	1
Std. Kit3	120	0	2
Std. Kit4	120	0	4
AcousticKit	120	0	3
Room Kit1	120	0	8
Room Kit2	120	0	12
Jungle Kit	120	0	10
HipHop Kit1	120	0	9
HipHop Kit2	120	0	13
Techno Kit1	120	0	11
Techno Kit2	120	0	14
Techno Kit3	120	0	15
Power Kit1	120	0	16
Power Kit2	120	0	17
Electro Kit	120	0	24
Analog Kit	120	0	25
House Kit1	120	0	26
House Kit2	120	0	27
House Kit3	120	0	28
House Kit4	120	0	29
Jazz Kit	120	0	32
Brush Kit1	120	0	40
Brush V.S.2	120	0	41
OrchestraK.	120	0	48
Bdrum&Sdrum	120	0	50

Name	CC00	CC32	PC
SFX Kit	120	0	56
Percus.Kit1	120	0	64
Latin P.Kit	120	0	65
TRI-Per.KIT	120	0	66
ArabianKit1	120	0	116
ArabianKit2	120	0	117
Timpani	121	0	47
Agogo	121	0	113
Log Drum	121	4	12
Woodblock	121	0	115
Taiko Drum	121	0	116
Melodic Tom	121	0	117
Synth Drum	121	0	118
Reverse Cym	121	0	119
Dragon Gong	121	1	119
Castanets	121	1	115
Concert BD	121	1	116
MelodicTom2	121	1	117
Rhyt.BoxTom	121	1	118
Electr.Drum	121	2	118
Rev Tom	121	2	117
Rev Snare	121	3	118
i30Perc.Kit	120	0	67
Bank: SFX			
Goblins	121	0	101
Echo Drops	121	0	102
Star Theme	121	0	103
GtFretNoise	121	0	120
BreathNoise	121	0	121
Seashore	121	0	122
Bird Tweet	121	0	123
AcBassStrng	121	2	120
Telephone	121	0	124
Helicopter	121	0	125
Applause	121	0	126
Gun Shot	121	0	127
SynthMallet	121	1	98
Echo Bell	121	1	102
Echo Pan	121	2	102
GtrCutNoise	121	1	120
Rain	121	1	122
Thunder	121	2	122
Wind	121	3	122
Stream	121	4	122
Bubble	121	5	122
Dog	121	1	123
HorseGallop	121	2	123
Bird Tweet2	121	3	123
Telephone 2	121	1	124
Door Creak	121	2	124
Door	121	3	124
Scratch	121	4	124
Wind Chime	121	5	124
Car Engine	121	1	125
Car Stop	121	2	125
Car Pass	121	3	125
Car Crash	121	4	125
Siren	121	5	125
Train	121	6	125

Name	CC00	CC32	PC
Jetplane	121	7	125
Starship	121	8	125
Burst Noise	121	9	125
Laughing	121	1	126
Screaming	121	2	126
Punch	121	3	126
Heart Beat	121	4	126
Footsteps	121	5	126
Machine Gun	121	1	127
Lasergun	121	2	127
Explosion	121	3	127
Ice Rain	121	0	96
Jaw Harp	121	3	105
HitInIndia	121	5	55
Stadium	121	6	126

PROGRAMS (PROGRAM CHANGE ORDER)

The following table enlists all Pa50 Factory Programs in order of Bank Select-Program Change number.

Legend: The table also includes MIDI data used to remotely select the Programs. **CC00:** Control Change 0, or Bank Select MSB. **CC32:** Control Change 32, or Bank Select LSB. **PC:** Program Change.

CC00	CC32	PC	Name	Pa50 Bank	GM2
121	0	0	Ac. Piano	Piano	√
121	1	0	AcPianoWide	Piano	√
121	2	0	AcPianoDark	Piano	√
121	3	0	Grand Piano	Piano	
121	4	0	Class.Piano	Piano	
121	5	0	L/R Piano	Piano	
121	6	0	Piano&Vibes	Piano	
121	7	0	Pno&Strings	Piano	
121	0	1	BrightPiano	Piano	√
121	1	1	BrPianoWide	Piano	√
121	2	1	Piano Pad	Piano	
121	3	1	Piano Pad 2	Piano	
121	4	1	PnoStrngPad	Piano	
121	0	2	ElGranPiano	Piano	√
121	1	2	ElGrandWide	Piano	√
121	2	2	M1 Piano	Piano	
121	3	2	90's Piano	Piano	
121	4	2	2000'sPiano	Piano	
121	5	2	ChorusPiano	Piano	
121	6	2	PianoLayers	Piano	
121	0	3	Honky-Tonk	Piano	√
121	1	3	Honky-Wide	Piano	√
121	0	4	E.Piano 1	E.Piano	√
121	1	4	DetunedEP 1	E.Piano	√
121	2	4	EP1Veloc.sw	E.Piano	√
121	3	4	60'sElPiano	E.Piano	√
121	4	4	Vintage EP	E.Piano	
121	5	4	Pro-Dyno EP	E.Piano	
121	6	4	ProStage EP	E.Piano	
121	7	4	Studio EP	E.Piano	
121	8	4	R&B E.Piano	E.Piano	
121	9	4	ThinElPiano	E.Piano	
121	10	4	DynoTine EP	E.Piano	
121	11	4	ClubElPiano	E.Piano	
121	0	5	E.Piano 2	E.Piano	√
121	1	5	DetunedEP 2	E.Piano	√
121	2	5	EP2Veloc.sw	E.Piano	√
121	3	5	EP Legend	E.Piano	√
121	4	5	EP Phase	E.Piano	√
121	5	5	SynPiano X	E.Piano	
121	6	5	StereoDigEP	E.Piano	
121	7	5	ClassDigiEP	E.Piano	
121	8	5	Hybrid EP	E.Piano	
121	9	5	Class.Tines	E.Piano	
121	10	5	PhantomTine	E.Piano	
121	11	5	DW8000 EP	E.Piano	
121	12	5	Sweeping EP	E.Piano	
121	13	5	WhitePad EP	E.Piano	
121	0	6	Harpsichord	Piano	√
121	1	6	Harpsi Oct.	Piano	√
121	2	6	Harpsi Wide	Piano	√

CC00	CC32	PC	Name	Pa50 Bank	GM2
121	3	6	HarpsiK.Off	Piano	√
121	4	6	Harpsi Korg	Piano	
121	0	7	Clav	Piano	√
121	1	7	Pulse Clav	Piano	√
121	2	7	Clav Wah	Piano	
121	3	7	Clav Snap	Piano	
121	4	7	Sticky Clav	Piano	
121	0	8	Celesta	Mallet & Bell	√
121	0	9	Glocken	Mallet & Bell	√
121	1	9	Sistro	Mallet & Bell	
121	0	10	Music Box	Mallet & Bell	√
121	1	10	Orgel	Mallet & Bell	
121	0	11	Vibraphone	Mallet & Bell	√
121	1	11	Vibrap.Wide	Mallet & Bell	√
121	2	11	Vibraphone2	Mallet & Bell	
121	0	12	Marimba	Mallet & Bell	√
121	1	12	MarimbaWide	Mallet & Bell	√
121	2	12	RimbaKeyOff	Mallet & Bell	
121	3	12	MonkeySkuls	Mallet & Bell	
121	4	12	Log Drum	Drum & Perc	
121	5	12	MalletClock	Mallet & Bell	
121	6	12	Balaphon	Mallet & Bell	
121	0	13	Xylophone	Mallet & Bell	√
121	0	14	TubularBell	Mallet & Bell	√
121	1	14	Church Bell	Mallet & Bell	√
121	2	14	Carillon	Mallet & Bell	√
121	3	14	ChurchBell2	Mallet & Bell	
121	0	15	Dulcimer	Mallet & Bell	√
121	1	15	Santur	Mallet & Bell	
121	0	16	Drawb.Organ	Organ 1	√
121	1	16	DetDrawbOrg	Organ 1	√
121	2	16	It60'sOrgan	Organ 1	√
121	3	16	DrawbOrgan2	Organ 1	√
121	4	16	DarkJazzOrg	Organ 1	
121	5	16	IperDarkOrg	Organ 1	
121	6	16	FullDrawbar	Organ 1	
121	7	16	DWGS Organ	Organ 1	
121	8	16	Jazz Organ	Organ 1	
121	9	16	GospelOrgan	Organ 1	
121	10	16	Good Old B	Organ 1	
121	11	16	VOX Legend	Organ 1	
121	12	16	ArabianOrg.	Organ 1	
121	0	17	Perc. Organ	Organ 1	√
121	1	17	Det.PercOrg	Organ 1	√
121	2	17	Perc.Organ2	Organ 1	√
121	3	17	Old Wheels	Organ 1	
121	4	17	Percuss.BX3	Organ 1	
121	5	17	M1 Organ	Organ 1	
121	6	17	TeknoOrgBas	Organ 1	
121	7	17	Bx3ShortDec	Organ 1	
121	8	17	RotaryOrgan	Organ 1	
121	0	18	Rock Organ	Organ 1	√
121	1	18	BX3 Velo Sw	Organ 1	
121	2	18	Killer B	Organ 1	
121	3	18	Dirty B	Organ 1	
121	4	18	ClassiClick	Organ 1	
121	5	18	Dist. Organ	Organ 1	
121	6	18	SuperBXPerc	Organ 1	
121	7	18	DirtyJazOrg	Organ 1	
121	8	18	PercShorDec	Organ 1	

CC00	CC32	PC	Name	Pa50 Bank	GM2
121	9	18	Perc.Wheels	Organ 1	
121	10	18	Jimmy Organ	Organ 1	
121	0	19	ChurchOrg.1	Organ 2	√
121	1	19	ChurchOcMix	Organ 2	√
121	2	19	DetunChurch	Organ 2	√
121	3	19	PipeMixture	Organ 2	
121	4	19	ChurchPipes	Organ 2	
121	5	19	Full Pipes	Organ 2	
121	6	19	Pipe Tutti	Organ 2	
121	7	19	PositiveOrg	Organ 2	
121	0	20	Reed Organ	Organ 2	√
121	1	20	Puff Organ	Organ 2	√
121	2	20	Small Pipe	Organ 2	
121	3	20	FlautoPipes	Organ 2	
121	0	21	Accordion	Accordion	√
121	1	21	Accordion 2	Accordion	√
121	2	21	Akordeon	Accordion	
121	3	21	Musette 1	Accordion	
121	4	21	Musette 2	Accordion	
121	5	21	MusetteClar	Accordion	
121	6	21	Fisa 16+8	Accordion	
121	7	21	Fisa 16+4	Accordion	
121	8	21	Fisa Master	Accordion	
121	9	21	Cassotto	Accordion	
121	10	21	Arab.Accord	Accordion	
121	0	22	Harmonica	Accordion	√
121	1	22	Sweet Harm.	Accordion	
121	2	22	Harmonica 2	Accordion	
121	0	23	TangoAccordion	Accordion	√
121	1	23	Fisa Tango!	Accordion	
121	0	24	NylonGuitar	Guitar	√
121	1	24	Ukulele	Guitar	√
121	2	24	NylonKeyOff	Guitar	√
121	3	24	Nylon Gtr 2	Guitar	√
121	4	24	Nylon Bossa	Guitar	
121	5	24	AcGtrKeyOff	Guitar	
121	6	24	Spanish Gtr	Guitar	
121	7	24	Gtr Strings	Guitar	
121	0	25	SteelGuitar	Guitar	√
121	1	25	12StringGtr	Guitar	√
121	2	25	Mandolin	Guitar	√
121	3	25	Steel&Body	Guitar	√
121	4	25	Steel Gtr 2	Guitar	
121	5	25	St12Strings	Guitar	
121	6	25	Hackbrett	Guitar	
121	7	25	FingerK.Off	Guitar	
121	8	25	Finger Tips	Guitar	
121	9	25	St.Folk Gtr	Guitar	
121	10	25	Mandol.KOff	Guitar	
121	11	25	MandoTrem	Guitar	
121	12	25	Reso.Guitar	Guitar	
121	0	26	Jazz Guitar	Guitar	√
121	1	26	PedSteelGtr	Guitar	√
121	2	26	Club J.Gtr1	Guitar	
121	3	26	Club J.Gtr2	Guitar	
121	4	26	Ped.Steel 2	Guitar	
121	0	27	CleanGuitar	Guitar	√
121	1	27	DetCleanGtr	Guitar	√
121	2	27	MidToneGtr	Guitar	√
121	3	27	Chorus Gtr	Guitar	

CC00	CC32	PC	Name	Pa50 Bank	GM2
121	4	27	Vintage S.	Guitar	
121	5	27	ProcesElGtr	Guitar	
121	6	27	SingleCoil	Guitar	
121	7	27	NewStra.Gtr	Guitar	
121	8	27	Guitarish	Guitar	
121	9	27	L&R El.Gtr	Guitar	
121	10	27	L&R El.Gtr2	Guitar	
121	11	27	Country Nu	Guitar	
121	12	27	FunkyWhaSw	Guitar	
121	0	28	MutedGuitar	Guitar	√
121	1	28	FunkyCutGtr	Guitar	√
121	2	28	MuteVeloGtr	Guitar	√
121	3	28	Jazz Man	Guitar	√
121	4	28	R&R Guitar	Guitar	
121	5	28	Stra.Chime	Guitar	
121	6	28	CleanMutGtr	Guitar	
121	7	28	RhythmElGtr	Guitar	
121	8	28	Clean Funk	Guitar	
121	9	28	Disto Mute	Guitar	
121	0	29	OverdriveGt	Guitar	√
121	1	29	Guitar Pinch	Guitar	√
121	0	30	DistortionG	Guitar	√
121	1	30	FeedbackGtr	Guitar	√
121	2	30	DistRhytmGt	Guitar	√
121	3	30	JoystGtr Y-	Guitar	
121	4	30	PowerChords	Guitar	
121	5	30	MuteMonster	Guitar	
121	6	30	WetDistGtr	Guitar	
121	7	30	SoloDistGtr	Guitar	
121	8	30	Stereo Dist	Guitar	
121	0	31	GtrHarmonic	Guitar	√
121	1	31	GtrFeedback	Guitar	√
121	2	31	EGHarmonics	Guitar	
121	0	32	Acous. Bass	Bass	√
121	1	32	AcBass Buzz	Bass	
121	2	32	Bass & Ride	Bass	
121	0	33	Finger Bass	Bass	√
121	1	33	Finger Slap	Bass	√
121	2	33	Fing ElBass	Bass	
121	3	33	FingElBass2	Bass	
121	4	33	FingElBass3	Bass	
121	5	33	Stick Bass	Bass	
121	0	34	Picked Bass	Bass	√
121	1	34	Pick ElBass	Bass	
121	2	34	PickElBass2	Bass	
121	3	34	Stein Bass	Bass	
121	4	34	Gtr Bass	Bass	
121	5	34	Bass Mute	Bass	
121	0	35	Fretl. Bass	Bass	√
121	1	35	Fret. Bass2	Bass	
121	2	35	Fretless Sw	Bass	
121	3	35	Sweet Fret	Bass	
121	4	35	DarkR&BBass	Bass	
121	0	36	Slap Bass 1	Bass	√
121	1	36	SuperSwBass	Bass	
121	2	36	SuperSwBas2	Bass	
121	0	37	Slap Bass 2	Bass	√
121	1	37	Thumb Bass	Bass	
121	2	37	Dyna Bass	Bass	
121	0	38	SynthBass 1	Bass	√

CC00	CC32	PC	Name	Pa50 Bank	GM2
121	1	38	SynBassWarm	Bass	√
121	2	38	SynBassReso	Bass	√
121	3	38	Clav Bass	Bass	√
121	4	38	Hammer	Bass	√
121	5	38	30303 Bass	Bass	
121	6	38	30303Square	Bass	
121	7	38	Bass Square	Bass	
121	8	38	SynBass Res	Bass	
121	9	38	Digi Bass 1	Bass	
121	10	38	Digi Bass 2	Bass	
121	11	38	Digi Bass 3	Bass	
121	12	38	BlindAsABat	Bass	
121	13	38	Jungle Bass	Bass	
121	14	38	Auto Pilot	Synth 2	
121	15	38	Hybrid Bass	Bass	
121	16	38	Dr. Octave	Bass	
121	0	39	SynthBass 2	Bass	√
121	1	39	Attack Bass	Bass	√
121	2	39	Rubber Bass	Bass	√
121	3	39	AttackPulse	Bass	√
121	4	39	Euro Bass	Bass	
121	5	39	Jungle Rez	Bass	
121	6	39	Nasty Bass	Bass	
121	7	39	Phat Bass	Bass	
121	8	39	PoinkerBass	Bass	
121	0	40	Violin	Strings & Vocals	√
121	1	40	SlowAttViol	Strings & Vocals	√
121	2	40	Solo Violin	Strings & Vocals	
121	3	40	Slow Violin	Strings & Vocals	
121	0	41	Viola	Strings & Vocals	√
121	0	42	Cello	Strings & Vocals	√
121	0	43	Contrabass	Strings & Vocals	√
121	0	44	Tremolo Str	Strings & Vocals	√
121	0	45	PizzicatoSt	Strings & Vocals	√
121	1	45	PizzEnsembl	Strings & Vocals	
121	2	45	PizzSection	Strings & Vocals	
121	3	45	Dbl Strings	Strings & Vocals	
121	0	46	Orches.Harp	Strings & Vocals	√
121	1	46	Yang Chin	Strings & Vocals	√
121	0	47	Timpani	Drum & Perc	√
121	0	48	StringsEns1	Strings & Vocals	√
121	1	48	String&Bras	Strings & Vocals	√
121	2	48	60s Strings	Strings & Vocals	√
121	3	48	St. Strings	Strings & Vocals	
121	4	48	LegatoStrng	Strings & Vocals	
121	5	48	i3 Strings	Strings & Vocals	
121	6	48	N Strings	Strings & Vocals	
121	7	48	ArcoStrings	Strings & Vocals	
121	8	48	Oct.Strings	Strings & Vocals	
121	9	48	StringQuart	Strings & Vocals	
121	10	48	Symph. Bows	Strings & Vocals	
121	11	48	Ens. & Solo	Strings & Vocals	
121	12	48	Camera Str.	Strings & Vocals	
121	13	48	ArabStrings	Strings & Vocals	
121	0	49	StringsEns2	Strings & Vocals	√
121	1	49	SweeperStr.	Strings & Vocals	
121	0	50	SynStrings1	Strings & Vocals	√
121	1	50	SynStrings3	Strings & Vocals	√
121	2	50	Analog Str	Strings & Vocals	
121	3	50	AnalogVelve	Strings & Vocals	

CC00	CC32	PC	Name	Pa50 Bank	GM2
121	4	50	Odissey	Strings & Vocals	
121	0	51	SynStrings2	Strings & Vocals	√
121	0	52	Choir Aahs	Strings & Vocals	√
121	1	52	Choir Aahs2	Strings & Vocals	√
121	2	52	Oooh Voices	Strings & Vocals	
121	3	52	OhSlowVoice	Strings & Vocals	
121	4	52	Take Voices	Strings & Vocals	
121	5	52	TakeVoices2	Strings & Vocals	
121	6	52	Oooh Choir	Strings & Vocals	
121	7	52	Aaah Choir	Strings & Vocals	
121	8	52	Mmmh Choir	Strings & Vocals	
121	9	52	Oh-AhVoices	Strings & Vocals	
121	10	52	Slow Choir	Strings & Vocals	
121	11	52	Grand Choir	Strings & Vocals	
121	12	52	Choir Light	Strings & Vocals	
121	13	52	StringChoir	Strings & Vocals	
121	0	53	Voice Oohs	Strings & Vocals	√
121	1	53	Humming	Strings & Vocals	√
121	2	53	Doolally	Strings & Vocals	
121	3	53	Airways	Strings & Vocals	
121	0	54	Synth Voice	Strings & Vocals	√
121	1	54	AnalogVoice	Strings & Vocals	√
121	2	54	Vocalesque	Strings & Vocals	
121	3	54	Vocalscape	Strings & Vocals	
121	4	54	ClassicVox	Strings & Vocals	
121	5	54	DreamVoice	Strings & Vocals	
121	0	55	Orches. Hit	Brass	√
121	1	55	BassHitPlus	Brass	√
121	2	55	6th Hit	Brass	√
121	3	55	Euro Hit	Brass	√
121	4	55	BrassImpact	Brass	
121	5	55	HitInIndia	SFX	
121	6	55	Wild Arp	Synth 2	
121	7	55	Flip Blip	Synth 2	
121	0	56	Trumpet	Trp & Trbn	√
121	1	56	DarkTrumpet	Trp & Trbn	√
121	2	56	Trumpet 2	Trp & Trbn	
121	3	56	MonoTrumpet	Trp & Trbn	
121	4	56	TrumpetExpr	Trp & Trbn	
121	5	56	TrumptPitch	Trp & Trbn	
121	6	56	Dual Trump	Trp & Trbn	
121	7	56	Flugel Horn	Trp & Trbn	
121	8	56	Warm Flugel	Trp & Trbn	
121	9	56	BeBopCornet	Trp & Trbn	
121	0	57	Trombone	Trp & Trbn	√
121	1	57	Trombone 2	Trp & Trbn	√
121	2	57	BrightTromb	Trp & Trbn	√
121	3	57	HardTrombon	Trp & Trbn	
121	4	57	SoftTrombon	Trp & Trbn	
121	5	57	PitchTromb	Trp & Trbn	
121	0	58	Tuba	Trp & Trbn	√
121	1	58	Ob.Tuba	Trp & Trbn	
121	2	58	Tuba Gold	Trp & Trbn	
121	3	58	Dynabone	Trp & Trbn	
121	0	59	Muted Trp	Trp & Trbn	√
121	1	59	Muted Trp 2	Trp & Trbn	√
121	2	59	Wha Trumpet	Trp & Trbn	
121	3	59	MutEnsemble	Trp & Trbn	
121	4	59	MutEnsembl2	Trp & Trbn	
121	0	60	French Horn	Brass	√

CC00	CC32	PC	Name	Pa50 Bank	GM2
121	1	60	FrenchHorn2	Brass	√
121	2	60	French Sect	Brass	
121	3	60	ClassicHorn	Brass	
121	4	60	Horns & Ens	Brass	
121	0	61	BrassSect.1	Brass	√
121	1	61	BrassSect.2	Brass	√
121	2	61	Tight Brass	Brass	
121	3	61	Glen&Friend	Brass	
121	4	61	BigBandBrs	Brass	
121	5	61	Sax & Brass	Brass	
121	6	61	Glen & Boys	Brass	
121	7	61	Trp & Brass	Brass	
121	8	61	AttackBrass	Brass	
121	9	61	Trumpet Ens	Brass	
121	10	61	TromboneEns	Brass	
121	11	61	Trombones	Brass	
121	12	61	TightBrass2	Brass	
121	13	61	Fat Brass	Brass	
121	14	61	Dyna Brass	Brass	
121	15	61	Brass Expr.	Brass	
121	16	61	Brass Band	Brass	
121	17	61	Film Brass	Brass	
121	18	61	Brass Slow	Brass	
121	19	61	Fanfare	Brass	
121	20	61	Movie Brass	Brass	
121	21	61	Power Brass	Brass	
121	22	61	Dyna Brass2	Brass	
121	23	61	Sfz Brass	Brass	
121	24	61	Dbl Brass	Brass	
121	25	61	Brass Hit	Brass	
121	26	61	Brass Fall	Brass	
121	0	62	Syn Brass 1	Brass	√
121	1	62	Syn Brass 3	Brass	√
121	2	62	AnalogBras1	Brass	√
121	3	62	Jump Brass	Brass	√
121	4	62	ElektrikBrs	Brass	
121	5	62	Syn Brass 5	Brass	
121	0	63	Syn Brass 2	Brass	√
121	1	63	Syn Brass 4	Brass	√
121	2	63	AnalogBras2	Brass	√
121	3	63	Brass Pad	Brass	
121	4	63	Big Panner	Synth 1	
121	0	64	Soprano Sax	Sax	√
121	1	64	Sweet Sprno	Sax	
121	0	65	Alto Sax	Sax	√
121	1	65	Alto Breath	Sax	
121	2	65	SaxEnsemble	Sax	
121	3	65	BreathyAlto	Sax	
121	4	65	AltSaxGrowl	Sax	
121	0	66	Tenor Sax	Sax	√
121	1	66	Tenor Noise	Sax	
121	2	66	Soft Tenor	Sax	
121	3	66	TenorBreath	Sax	
121	4	66	Tenor Growl	Sax	
121	5	66	Folk Sax	Sax	
121	0	67	BaritoneSax	Sax	√
121	1	67	Barit Growl	Sax	
121	2	67	BreathyBari	Sax	
121	0	68	Oboe	Woodwind	√
121	1	68	Double Reed	Woodwind	

CC00	CC32	PC	Name	Pa50 Bank	GM2
121	0	69	EnglishHorn	Woodwind	√
121	1	69	EnglisHorn2	Woodwind	
121	0	70	Bassoon	Woodwind	√
121	0	71	Clarinet	Woodwind	√
121	1	71	Jazz Clarin	Woodwind	
121	2	71	Clarinet G	Woodwind	
121	3	71	Sect Winds	Woodwind	
121	4	71	Sect Winds2	Woodwind	
121	5	71	ClarinetEns	Woodwind	
121	6	71	Woodwinds	Woodwind	
121	7	71	Folk Clarin	Woodwind	
121	0	72	Piccolo	Woodwind	√
121	1	72	Small Orch	Woodwind	
121	2	72	Nay	Woodwind	
121	0	73	Flute	Woodwind	√
121	1	73	Jazz Flute	Woodwind	
121	2	73	FluteSwitch	Woodwind	
121	3	73	FluteDyn5th	Woodwind	
121	4	73	Flute Frull	Woodwind	
121	5	73	Orch. Flute	Woodwind	
121	6	73	Flute Muted	Woodwind	
121	7	73	WoodenFlute	Woodwind	
121	8	73	Bambu Flute	Woodwind	
121	9	73	Flute 2	Woodwind	
121	0	74	Recorder	Woodwind	√
121	1	74	Recorder 2	Woodwind	
121	0	75	Pan Flute	Woodwind	√
121	1	75	Kawala	Woodwind	
121	0	76	BlownBottle	Woodwind	√
121	0	77	Shakuhachi	Woodwind	√
121	1	77	Old Shaku	Woodwind	
121	2	77	Shaku 2	Woodwind	
121	0	78	Whistle	Woodwind	√
121	1	78	Whistle 2	Woodwind	
121	0	79	Ocarina	Woodwind	√
121	0	80	Lead Square	Synth 2	√
121	1	80	LeadSquare2	Synth 2	√
121	2	80	Lead Sine	Synth 2	√
121	3	80	Old Portam	Synth 2	
121	4	80	Dance Lead	Synth 2	
121	5	80	Wave Lead	Synth 2	
121	6	80	Sine Wave	Synth 2	
121	7	80	Analog Lead	Synth 2	
121	8	80	Old&Analog	Synth 2	
121	9	80	Gliding Sq.	Synth 2	
121	10	80	Sine Switch	Synth 2	
121	11	80	Square Rez	Synth 2	
121	0	81	Lead Saw	Synth 2	√
121	1	81	Lead Saw 2	Synth 2	√
121	2	81	LeadSawPuls	Synth 2	√
121	3	81	LeadDblSaw	Synth 2	√
121	4	81	Seq. Analog	Synth 2	√
121	5	81	Power Saw	Synth 2	
121	6	81	Octo Lead	Synth 2	
121	7	81	Seq Lead	Synth 2	
121	8	81	PhatSawLead	Synth 2	
121	9	81	Glide Lead	Synth 2	
121	10	81	Fire Wave	Synth 2	
121	11	81	Rezbo	Synth 2	
121	12	81	Syn Pianoid	Synth 2	

CC00	CC32	PC	Name	Pa50 Bank	GM2
121	0	82	Calliope	Synth 2	√
121	0	83	Chiff	Synth 2	√
121	0	84	Charang	Synth 2	√
121	1	84	Wire Lead	Synth 2	√
121	2	84	Synchro City	Synth 2	
121	3	84	Sync Kron	Synth 2	
121	4	84	MetallicRez	Synth 2	
121	5	84	Brian Sync	Synth 2	
121	6	84	Arp Twins	Synth 2	
121	0	85	Voice Lead	Strings & Vocals	√
121	1	85	EtherVoices	Strings & Vocals	
121	2	85	Cyber Choir	Strings & Vocals	
121	0	86	Fifths Lead	Synth 2	√
121	1	86	Crimson5ths	Synth 2	
121	0	87	Bass & Lead	Synth 2	√
121	1	87	Soft Wrl	Synth 2	√
121	2	87	ElectroLead	Synth 2	
121	3	87	Rich Lead	Synth 2	
121	4	87	ThinAnaLead	Synth 2	
121	5	87	EspressLead	Synth 2	
121	6	87	HipHop Lead	Synth 2	
121	7	87	Square Bass	Synth 2	
121	8	87	Big & Raw	Synth 2	
121	9	87	Cat Lead	Synth 2	
121	0	88	New Age Pad	Synth 1	√
121	1	88	VirtualTrav	Synth 1	
121	2	88	Arp Angeles	Synth 1	
121	0	89	Warm Pad	Synth 1	√
121	1	89	Sine Pad	Synth 1	√
121	2	89	MasterPad	Synth 1	
121	3	89	Power Synth	Synth 1	
121	4	89	The Pad	Synth 1	
121	5	89	Money Pad	Synth 1	
121	6	89	Dark Pad	Synth 1	
121	7	89	Freedom Pad	Synth 1	
121	8	89	Analog Pad	Synth 1	
121	9	89	Analog Pad2	Synth 1	
121	0	90	Polysynth	Synth 1	√
121	1	90	Reso Sweep	Synth 1	
121	2	90	Sky Watcher	Synth 1	
121	3	90	Syn Sweeper	Synth 1	
121	4	90	Super Sweep	Synth 1	
121	5	90	Wave Sweep	Synth 1	
121	6	90	Cross Sweep	Synth 1	
121	7	90	Dig PolySix	Synth 1	
121	8	90	Noisy Stabb	Synth 1	
121	9	90	Mega Synth	Synth 1	
121	10	90	TecnoPhonic	Synth 1	
121	11	90	Farluce	Synth 1	
121	0	91	Choir Pad	Synth 1	√
121	1	91	Itopia Pad	Synth 1	√
121	2	91	Fresh Air	Strings & Vocals	
121	3	91	Heaven	Synth 1	
121	4	91	Pop Syn Pad	Synth 1	
121	5	91	Future Pad	Synth 1	
121	6	91	TsunamiWave	Synth 1	
121	7	91	FreshBreath	Synth 1	
121	8	91	RavelianPad	Synth 1	
121	9	91	FullVox Pad	Synth 1	
121	10	91	Dance ReMix	Synth 1	

CC00	CC32	PC	Name	Pa50 Bank	GM2
121	0	92	BowedGlass	Synth 1	√
121	0	93	MetallicPad	Synth 1	√
121	1	93	Cosmic	Synth 1	
121	0	94	Halo Pad	Synth 1	√
121	0	95	Sweep Pad	Synth 1	√
121	1	95	AstralDream	Synth 1	
121	2	95	Meditate	Synth 1	
121	3	95	DarkElement	Synth 1	
121	4	95	Mellow Pad	Synth 1	
121	5	95	Cinema Pad	Synth 1	
121	0	96	Ice Rain	Synth 1	√
121	1	96	MotionOcean	Synth 1	
121	2	96	Caribbean	Synth 1	
121	0	97	Soundtrack	Synth 1	√
121	1	97	Air Clouds	Synth 1	
121	2	97	Reso Down	Synth 1	
121	3	97	Tinklin Pad	Synth 1	
121	4	97	Pods In Pad	Synth 1	
121	5	97	Noble Pad	Synth 1	
121	6	97	Rave	Synth 1	
121	7	97	ElastickPad	Synth 1	
121	0	98	Crystal	Synth 2	√
121	1	98	SynthMallet	SFX	√
121	2	98	Vs Bell Boy	Mallet & Bell	
121	3	98	KrystalBell	Mallet & Bell	
121	4	98	Digi Bell	Mallet & Bell	
121	5	98	Moving Bell	Synth 1	
121	6	98	Bell Pad	Mallet & Bell	
121	7	98	Bell Choir	Synth 1	
121	0	99	Atmosphere	Synth 2	√
121	0	100	Brightness	Synth 2	√
121	1	100	Lonely Spin	Synth 1	
121	2	100	Syn Ghostly	Synth 1	
121	0	101	Goblins	SFX	√
121	1	101	MotionRaver	Synth 2	
121	2	101	Digi IcePad	Synth 1	
121	0	102	Echo Drops	SFX	√
121	1	102	Echo Bell	SFX	√
121	2	102	Echo Pan	SFX	√
121	3	102	Band Passed	Synth 2	
121	4	102	Pan Reso	Synth 2	
121	5	102	Moon Cycles	Synth 1	
121	0	103	Star Theme	SFX	√
121	0	104	Sitar	Guitar	√
121	1	104	Sitar 2	Guitar	√
121	2	104	SitarTambou	Guitar	
121	3	104	IndianStars	Guitar	
121	4	104	IndianFrets	Guitar	
121	5	104	Bouzouki	Guitar	
121	6	104	Tambra	Guitar	
121	0	105	Banjo	Guitar	√
121	1	105	BanjoKeyOff	Guitar	
121	2	105	Oud	Guitar	
121	3	105	Jaw Harp	SFX	
121	0	106	Shamisen	Guitar	√
121	0	107	Koto	Guitar	√
121	1	107	Taisho Koto	Guitar	√
121	2	107	Kanun	Guitar	
121	3	107	Kanun Trem.	Guitar	
121	4	107	Kanun Mix	Guitar	

CC00	CC32	PC	Name	Pa50 Bank	GM2
121	0	108	Kalimba	Mallet & Bell	√
121	1	108	VeloKalimba	Mallet & Bell	
121	0	109	Bag Pipe	Woodwind	√
121	1	109	War Pipes	Woodwind	
121	0	110	Fiddle	Strings & Vocals	√
121	0	111	Shanai	Woodwind	√
121	1	111	Zurna	Woodwind	
121	2	111	Hichiriki	Woodwind	
121	0	112	Tinkle Bell	Mallet & Bell	√
121	1	112	Gamelan	Mallet & Bell	
121	2	112	BaliGamelan	Mallet & Bell	
121	3	112	GarbageMall	Mallet & Bell	
121	0	113	Agogo	Drum & Perc	√
121	0	114	Steel Drums	Mallet & Bell	√
121	1	114	Warm Steel	Mallet & Bell	
121	0	115	Woodblock	Drum & Perc	√
121	1	115	Castanets	Drum & Perc	√
121	0	116	Taiko Drum	Drum & Perc	√
121	1	116	Concert BD	Drum & Perc	√
121	0	117	Melodic Tom	Drum & Perc	√
121	1	117	MelodicTom2	Drum & Perc	√
121	2	117	Rev Tom	Drum & Perc	
121	0	118	Synth Drum	Drum & Perc	√
121	1	118	Rhyt.BoxTom	Drum & Perc	√
121	2	118	Electr.Drum	Drum & Perc	√
121	3	118	Rev Snare	Drum & Perc	
121	0	119	Reverse Cym	Drum & Perc	√
121	1	119	Dragon Gong	Drum & Perc	
121	0	120	GtFretNoise	SFX	√
121	1	120	GtrCutNoise	SFX	√
121	2	120	AcBassStrng	SFX	√
121	3	120	VoxWahChick	Guitar	
121	0	121	BreathNoise	SFX	√
121	1	121	Flute Click	Woodwind	√
121	0	122	Seashore	SFX	√
121	1	122	Rain	SFX	√
121	2	122	Thunder	SFX	√
121	3	122	Wind	SFX	√
121	4	122	Stream	SFX	√
121	5	122	Bubble	SFX	√
121	0	123	Bird Tweet	SFX	√
121	1	123	Dog	SFX	√
121	2	123	HorseGallop	SFX	√
121	3	123	Bird Tweet2	SFX	√
121	0	124	Telephone 1	SFX	√
121	1	124	Telephone 2	SFX	√
121	2	124	Door Creak	SFX	√
121	3	124	Door	SFX	√
121	4	124	Scratch	SFX	√
121	5	124	Wind Chime	SFX	√
121	0	125	Helicopter	SFX	√
121	1	125	Car Engine	SFX	√
121	2	125	Car Stop	SFX	√
121	3	125	Car Pass	SFX	√
121	4	125	Car Crash	SFX	√
121	5	125	Siren	SFX	√
121	6	125	Train	SFX	√
121	7	125	Jetplane	SFX	√
121	8	125	Starship	SFX	√
121	9	125	Burst Noise	SFX	√

CC00	CC32	PC	Name	Pa50 Bank	GM2
121	0	126	Applause	SFX	√
121	1	126	Laughing	SFX	√
121	2	126	Screaming	SFX	√
121	3	126	Punch	SFX	√
121	4	126	Heart Beat	SFX	√
121	5	126	Footsteps	SFX	√
121	6	126	Stadium	SFX	
121	0	127	Gun Shot	SFX	√
121	1	127	Machine Gun	SFX	√
121	2	127	Lasergun	SFX	√
121	3	127	Explosion	SFX	√

DRUM KITS

The following table enlists all Pa50 Factory Drum Kit Programs in order of Bank Select-Program Change number.

Legend: The table also includes MIDI data used to remotely select the Programs. **CC00:** Control Change 0, or Bank Select MSB. **CC32:** Control Change 32, or Bank Select LSB. **PC:** Program Change.

CC00	CC32	PC	Name	GM2	
120	0	0	Std. Kit1	√	
120	0	1	Std. Kit2		
120	0	2	Std. Kit3		
120	0	3	AcousticKit		
120	0	4	Std. Kit4		
120	0	5-7: (remap to 0)			
120	0	8	Room Kit1	√	
120	0	9	HipHop Kit1		
120	0	10	Jungle Kit		
120	0	11	Techno Kit1		
120	0	12	Room Kit2		
120	0	13	HipHop Kit2		
120	0	14	Techno Kit2		
120	0	15	Techno Kit3		
120	0	16	Power Kit1	√	
120	0	17	Power Kit2		
120	0	18-23: (remap to 16)			
120	0	24	Electro Kit	√	
120	0	25	Analog Kit	√	
120	0	26	House Kit1		

CC00	CC32	PC	Name	GM2	
120	0	27	House Kit2		
120	0	28	House Kit3		
120	0	29	House Kit4		
120	0	30-31: (remap to 24)			
120	0	32	Jazz Kit	√	
120	0	33-39: (remap to 32)			
120	0	40	Brush Kit1	√	
120	0	41	Brush V.S.2		
120	0	42-47: (remap to 40)			
120	0	48	OrchestraK.	√	
120	0	49: (remap to 48)			
120	0	50	Bdrum&Sdrum		
120	0	51: (remap to 116)			
120	0	52-55: (remap to 48)			
120	0	56	SFX Kit	√	
120	0	57-63: (remap to 56)			
120	0	64	Percus.Kit1		
120	0	65	Latin P.Kit		
120	0	66	TRI-Per.KIT		
120	0	67	i30 Perc.Kit		
120	0	68-71: (remap to 64)			
120	0	72-115: (remap to 0)			
120	0	116	Arabian Kit 1		
120	0	117	Arabian Kit 2		
120	0	118-127: (remap to 0)			

DRUM KIT INSTRUMENTS

Legend: In the Drum Kit tables, the numer 120-x-x before each Drum Kit name is the Bank Select MSB (CC00) - Bank Select LSB (CC32) - Program Change (PC) number. **Sample** enlists both the sample number in memory, and the sample name. **Excl** is the Exclusive parameter: when a note is struck, all notes with the same Exclusive number are stopped. A right-pointing arrow (→) indicates a velocity switch.

Note		120-0-0: Std. Kit1			120-0-1: Std. Kit2			120-0-2: Std. Kit3		
8	G#-1	Sample	Excl.	0	Sample	Excl.	Sample	Excl.		
9	A-1	17 BD-House 1	Off	17	BD-House 1	Off	17	BD-House 1	Off	
10	A#-1	125 99-SD	Off	125	99-SD	Off	125	99-SD	Off	
11	B-1	123 88-BD	Off	123	88-BD	Off	123	88-BD	Off	
12	C0	124 88-SD	Off	124	88-SD	Off	124	88-SD	Off	
13	C#0	37 SD-Full Room	Off	40	SD-Amb.Piccolo	Off	38	SD-Off Center	Off	
14	D0	48 SD-Processed	1	48	SD-Processed	Off	48	SD-Processed	Off	
15	D#0	0 BD-Dry 1	Off	6	BD-Pillow	Off	6	BD-Pillow	Off	
16	E0	12 BD-Tight	Off	27	BD-Amb.Rocker	Off	27	BD-Amb.Rocker	Off	
17	F0	31 SD-Dry 1	Off	39	SD-Jazz Ring	Off	42	SD-BrushHit	Off	
18	F#0	87 HH1 Closed2	1	87	HH1 Closed2	1	87	HH1 Closed2	1	
19	G0	2 BD-Dry 3	Off	0	BD-Dry 1	Off	5	BD-Jazz	Off	
20	G#0	73 SideStickAmb	Off	72	SideStickDry	Off	72	SideStickDry	Off	
21	A0	120 SD-Orch.	7	32	SD-Dry 2	7	69	SD-Brasser	7	
22	A#0	119 SD-Orch.Roll	7	49	SD-CrackerRoom	7	32	SD-Dry 2	Off	
23	B0	74 DrumStickHit	Off	74	DrumStickHit	Off	74	DrumStickHit	Off	
24	C1	120 SD-Orch.	7	120	SD-Orch.	7	120	SD-Orch.	7	
25	C#1	119 SD-Orch.Roll	7	119	SD-Orch.Roll	7	119	SD-Orch.Roll	7	
26	D1	121 FingerSnaps	Off	121	FingerSnaps	Off	121	FingerSnaps	Off	
27	D#1	143 Zap2	Off	143	Zap2	Off	143	Zap2	Off	
28	E1	281 Noise White	Off	281	Noise White	Off	281	Noise White	Off	
29	F1	145 DJ-Scratch2	7	145	DJ-Scratch2	7	145	DJ-Scratch2	7	
30	F#1	145 DJ-Scratch2	7	145	DJ-Scratch2	7	145	DJ-Scratch2	7	
31	G1	74 DrumStickHit	Off	74	DrumStickHit	Off	74	DrumStickHit	Off	
32	G#1	142 Zap1	Off	142	Zap1	Off	142	Zap1	Off	
33	A1	249 Click	Off	249	Click	Off	249	Click	Off	
34	A#1	213 Triangle-Open	Off	213	Triangle-Open	Off	213	Triangle-Open	Off	
35	B1	2 BD-Dry 3	Off	12	BD-Tight	Off	0	BD-Dry 1	Off	
36	C2	0 BD-Dry 1	Off	10	BD-Tubby	Off	10	BD-Tubby	Off	
37	C#2	73 SideStickAmb	Off	73	SideStickAmb	Off	73	SideStickAmb	Off	
38	D2	32 SD-Dry 2	Off	38	SD-Off Center	Off	39	SD-Jazz Ring	Off	
39	D#2	122 Hand Claps	Off	127	88-Claps	Off	127	88-Claps	Off	
40	E2	37 SD-Full Room	Off	38	SD-Off Center	Off	40	SD-Amb.Piccolo	Off	
41	F2	79 Tom 2-Floor	Off	79	Tom 2-Floor	Off	79	Tom 2-Floor	Off	
42	F#2	90 HH1 Open 2	1	86	HH1 Closed1	1	92	HH2 Closed1	1	
43	G2	79 Tom 2-Floor	Off	79	Tom 2-Floor	Off	79	Tom 2-Floor	Off	
44	G#2	94 HH2 Foot	1	88	HH1 Foot	1	94	HH2 Foot	1	
45	A2	78 Tom 2-Lo	Off	78	Tom 2-Lo	Off	78	Tom 2-Lo	Off	
46	A#2	89 HH1 Open 1	1	89	HH1 Open 1	1	89	HH1 Open 1	1	
47	B2	78 Tom 2-Lo	Off	78	Tom 2-Lo	Off	78	Tom 2-Lo	Off	
48	C3	77 Tom 2-Hi	Off	77	Tom 2-Hi	Off	77	Tom 2-Hi	Off	
49	C#3	104 Crash Cymbal 1	Off	104	Crash Cymbal 1	Off	104	Crash Cymbal 1	Off	
50	D3	77 Tom 2-Hi	Off	77	Tom 2-Hi	Off	77	Tom 2-Hi	Off	
51	D#3	113 Ride-Edge 2	Off	113	Ride-Edge 2	Off	113	Ride-Edge 2	Off	
52	E3	106 China Cymbal	Off	106	China Cymbal	Off	106	China Cymbal	Off	
53	F3	114 Ride-Jazz	Off	114	Ride-Jazz	Off	114	Ride-Jazz	Off	
54	F#3	212 Tambourin-Acc2	Off	212	Tambourin-Acc2	Off	212	Tambourin-Acc2	Off	
55	G3	107 Splash Cymbal	Off	107	Splash Cymbal	Off	107	Splash Cymbal	Off	
56	G#3	225 Cowbell	Off	225	Cowbell	Off	225	Cowbell	Off	
57	A3	104 Crash Cymbal 1	Off	104	Crash Cymbal 1	Off	104	Crash Cymbal 1	Off	
58	A#3	198 Vibraslap	Off	198	Vibraslap	Off	198	Vibraslap	Off	
59	B3	113 Ride-Edge 2	Off	113	Ride-Edge 2	Off	113	Ride-Edge 2	Off	
60	C4	171 BongoHi-Open	Off	171	BongoHi-Open	Off	171	BongoHi-Open	Off	
61	C#4	168 BongoLo-Open	Off	168	BongoLo-Open	Off	168	BongoLo-Open	Off	
62	D4	159 CongaLoMtSlp	Off	159	CongaLoMtSlp	Off	163	CongaHiMtSlap	Off	
63	D#4	161 CongaHi-Open	Off	161	CongaHi-Open	Off	161	CongaHi-Open	Off	
64	E4	158 CongaLo-Open	Off	158	CongaLo-Open	Off	158	CongaLo-Open	Off	
65	F4	207 TimbaleHi-Rim2	Off	207	TimbaleHi-Rim2	Off	207	TimbaleHi-Rim2	Off	
66	F#4	202 TimbaleLo-Open	Off	202	TimbaleLo-Open	Off	202	TimbaleLo-Open	Off	
67	G4	224 Agogo-Bell	Off	224	Agogo-Bell	Off	224	Agogo-Bell	Off	
68	G#4	224 Agogo-Bell	Off	224	Agogo-Bell	Off	224	Agogo-Bell	Off	
69	A4	219 Cabasa-Up	Off	219	Cabasa-Up	Off	219	Cabasa-Up	Off	
70	A#4	182 MaracasPush	Off	182	MaracasPush	Off	182	MaracasPush	Off	
71	B4	234 SambaWhistle	2	234	SambaWhistle	2	234	SambaWhistle	2	
72	C5	234 SambaWhistle	2	234	SambaWhistle	2	234	SambaWhistle	2	
73	C#5	181 Guiro Short	3	181	Guiro Short	3	181	Guiro Short	3	
74	D5	180 Guiro Long	3	180	Guiro Long	3	180	Guiro Long	3	
75	D#5	199 Claves	Off	199	Claves	Off	199	Claves	Off	
76	E5	200 Woodblock1	Off	200	Woodblock1	Off	200	Woodblock1	Off	
77	F5	200 Woodblock1	Off	200	Woodblock1	Off	200	Woodblock1	Off	
78	F#5	215 Cuica-Hi	4	215	Cuica-Hi	4	215	Cuica-Hi	4	
79	G5	216 Cuica-Lo	4	216	Cuica-Lo	4	216	Cuica-Lo	4	
80	G#5	214 Triangle-Mute	5	214	Triangle-Mute	5	214	Triangle-Mute	5	
81	A5	213 Triangle-Open	5	213	Triangle-Open	5	213	Triangle-Open	5	
82	A#5	220 Cabasa-Down	Off	220	Cabasa-Down	Off	220	Cabasa-Down	Off	
83	B5	228 Sleigh Bell	Off	228	Sleigh Bell	Off	228	Sleigh Bell	Off	
84	C6	231 Marc Tree	Off	231	Marc Tree	Off	231	Marc Tree	Off	
85	C#6	178 CastSingle	Off	178	CastSingle	Off	178	CastSingle	Off	
86	D6	203 TimbaleLo-Mute	6	203	TimbaleLo-Mute	6	203	TimbaleLo-Mute	6	
87	D#6	202 TimbaleLo-Open	6	202	TimbaleLo-Open	6	202	TimbaleLo-Open	6	
88	E6	243 Stadium	Off	243	Stadium	Off	243	Stadium	Off	

Note		120-0-3: AcousticKit			120-0-4: Std. Kit4			120-0-8: Room Kit1			120-0-9: HipHop Kit1		
	A#-1	Sample	Excl.		Sample	Excl.		Sample	Excl.		Sample	Excl.	
9	A-1	17 BD-House 1	Off	17	BD-House 1	Off	13	BD-Squash	Off	13	BD-Squash	Off	
10	A#-1	125 99-SD	Off	125	99-SD	Off	59	SD-Hip 6	Off	59	SD-Hip 6	Off	
11	B-1	123 88-BD	Off	123	88-BD	Off	123	88-BD	Off	123	88-BD	Off	
12	C0	124 88-SD	Off	124	88-SD	Off	124	88-SD	Off	124	88-SD	Off	
13	C#0	38 SD-Off Center	Off	38	SD-Off Center	Off	56	SD-Hip 3	Off	56	SD-Hip 3	Off	
14	D0	49 SD-CrackerRoom	Off	48	SD-Processed	1	58	SD-Hip 5	Off	58	SD-Hip 5	Off	
15	D#0	6 BD-Pillow	Off	27	BD-Amb.Rocker	Off	25	BD-Ambi Kick	Off	25	BD-Ambi Kick	Off	
16	E0	27 BD-Amb.Rocker	Off	12	BD-Tight	Off	11	BD-Gated	Off	11	BD-Gated	Off	
17	F0	40 SD-Amb.Piccolo	Off	39	SD-Jazz Ring	Off	40	SD-Amb.Piccolo	Off	40	SD-Amb.Piccolo	Off	
18	F#0	87 HH1 Closed2	1	87	HH1 Closed2	1	90	HH1 Open 2	1	90	HH1 Open 2	1	
19	G0	5 BD-Jazz	Off	2	BD-Dry 3	Off	6	BD-Pillow	Off	6	BD-Pillow	Off	
20	G#0	72 SideStickDry	Off	72	SideStickDry	Off	72	SideStickDry	Off	72	SideStickDry	Off	
21	A0	120 SD-Orch.	7	32	SD-Dry 2	Off	47	SD-Yowie	7	47	SD-Yowie	Off	
22	A#0	119 SD-Orch.Roll	7	31	SD-Dry 1	Off	59	SD-Hip 6	7	59	SD-Hip 6	Off	
23	B0	74 DrumStickHit	Off	74	DrumStickHit	Off	74	DrumStickHit	Off	74	DrumStickHit	Off	
24	C1	120 SD-Orch.	7	120	SD-Orch.	7	120	SD-Orch.	7	120	SD-Orch.	7	
25	C#1	119 SD-Orch.Roll	7	119	SD-Orch.Roll	7	119	SD-Orch.Roll	7	119	SD-Orch.Roll	7	
26	D1	121 FingerSnaps	Off	121	FingerSnaps	Off	121	FingerSnaps	Off	121	FingerSnaps	Off	
27	D#1	143 Zap2	Off	143	Zap2	Off	143	Zap2	Off	143	Zap2	Off	
28	E1	281 Noise White	Off	281	Noise White	Off	281	Noise White	Off	281	Noise White	Off	
29	F1	145 DJ-Scratch2	7	145	DJ-Scratch2	7	145	DJ-Scratch2	7	145	DJ-Scratch2	7	
30	F#1	145 DJ-Scratch2	7	145	DJ-Scratch2	7	145	DJ-Scratch2	7	145	DJ-Scratch2	7	
31	G1	74 DrumStickHit	Off	74	DrumStickHit	Off	74	DrumStickHit	Off	74	DrumStickHit	Off	
32	G#1	142 Zap1	Off	142	Zap1	Off	142	Zap1	Off	142	Zap1	Off	
33	A1	249 Click	Off	249	Click	Off	249	Click	Off	249	Click	Off	
34	A#1	213 Triangle-Open	Off	213	Triangle-Open	Off	213	Triangle-Open	Off	213	Triangle-Open	Off	
35	B1	3 BD-Normal	Off	2	BD-Dry 3	Off	10	BD-Tubby	Off	28	BD-Pop 99	Off	
36	C2	0-6 BD-Dry 1->BD-Pillow	Off	12	BD-Tight	Off	27	BD-Amb.Rocker	Off	21	BD-Hip 3	Off	
37	C#2	73 SideStickAmb	Off	73	SideStickAmb	Off	72	SideStickDry	Off	126	88-Rimshot	Off	
38	D2	35-36 SD-Ghost f->SD-Ghost p	Off	40	SD-Amb.Piccolo	Off	49	SD-CrackerRoom	Off	60	SD-Ringy	Off	
39	D#2	122 Hand Claps	Off	127	88-Claps	Off	127	88-Claps	Off	127	88-Claps	Off	
40	E2	35-36 SD-Ghost f->SD-Ghost p	Off	37	SD-Full Room	Off	37	SD-Full Room	Off	67	SD-Vintage6	Off	
41	F2	79 Tom 2-Floor	Off	79	Tom 2-Floor	Off	79	Tom 2-Floor	Off	75	Tom 1-Hi	Off	
42	F#2	90 HH1 Open 2	1	90	HH1 Open 2	1	86	HH1 Closed1	1	97	HH-OldClose1	1	
43	G2	79 Tom 2-Floor	Off	79	Tom 2-Floor	Off	79	Tom 2-Floor	Off	75	Tom 1-Hi	Off	
44	G#2	94 HH2 Foot	1	94	HH2 Foot	1	94	HH2 Foot	1	100	HH-OldClose2	Off	
45	A2	78 Tom 2-Lo	Off	78	Tom 2-Lo	Off	78	Tom 2-Lo	Off	75	Tom 1-Hi	Off	
46	A#2	89 HH1 Open 1	1	89	HH1 Open 1	1	96	HH2 Open	1	98	HH-Old Open1	1	
47	B2	78 Tom 2-Lo	Off	78	Tom 2-Lo	Off	78	Tom 2-Lo	Off	75	Tom 1-Hi	Off	
48	C3	77 Tom 2-Hi	Off	77	Tom 2-Hi	Off	77	Tom 2-Hi	Off	75	Tom 1-Hi	Off	
49	C#3	104 Crash Cymbal 1	Off	104	Crash Cymbal 1	Off	104	Crash Cymbal 1	Off	104	Crash Cymbal 1	Off	
50	D3	77 Tom 2-Hi	Off	77	Tom 2-Hi	Off	77	Tom 2-Hi	Off	75	Tom 1-Hi	Off	
51	D#3	113 Ride-Edge 2	Off	113	Ride-Edge 2	Off	113	Ride-Edge 2	Off	113	Ride-Edge 2	Off	
52	E3	106 China Cymbal	Off	106	China Cymbal	Off	106	China Cymbal	Off	108	CymbalReverse	Off	
53	F3	115 Ride-Cup	Off	114	Ride-Jazz	Off	114	Ride-Jazz	Off	114	Ride-Jazz	Off	
54	F#3	212 Tambourin-Acc2	Off	212	Tambourin-Acc2	Off	212	Tambourin-Acc2	Off	212	Tambourin-Acc2	Off	
55	G3	107 Splash Cymbal	Off	107	Splash Cymbal	Off	107	Splash Cymbal	Off	107	Splash Cymbal	Off	
56	G#3	225 Cowbell	Off	225	Cowbell	Off	225	Cowbell	Off	136	88-Cowbell	Off	
57	A3	104 Crash Cymbal 1	Off	104	Crash Cymbal 1	Off	104	Crash Cymbal 1	Off	104	Crash Cymbal 1	Off	
58	A#3	198 Vibraslap	Off	198	Vibraslap	Off	198	Vibraslap	Off	198	Vibraslap	Off	
59	B3	114 Ride-Jazz	Off	113	Ride-Edge 2	Off	113	Ride-Edge 2	Off	113	Ride-Edge 2	Off	
60	C4	171 BongoHi-Open	Off	171	BongoHi-Open	Off	171	BongoHi-Open	Off	171	BongoHi-Open	Off	
61	C#4	168 BongoLo-Open	Off	168	BongoLo-Open	Off	168	BongoLo-Open	Off	168	BongoLo-Open	Off	
62	D4	163 CongaHiMtslap	Off	163	CongaHiMtslap	Off	163	CongaHiMtslap	Off	163	CongaHiMtslap	Off	
63	D#4	161 CongaHi-Open	Off	161	CongaHi-Open	Off	161	CongaHi-Open	Off	161	CongaHi-Open	Off	
64	E4	158 CongaLo-Open	Off	158	CongaLo-Open	Off	158	CongaLo-Open	Off	158	CongaLo-Open	Off	
65	F4	207 TimbaleHi-Rim2	Off	207	TimbaleHi-Rim2	Off	207	TimbaleHi-Rim2	Off	207	TimbaleHi-Rim2	Off	
66	F#4	202 TimbaleLo-Open	Off	202	TimbaleLo-Open	Off	202	TimbaleLo-Open	Off	202	TimbaleLo-Open	Off	
67	G4	224 Agogo-Bell	Off	224	Agogo-Bell	Off	224	Agogo-Bell	Off	224	Agogo-Bell	Off	
68	G#4	224 Agogo-Bell	Off	224	Agogo-Bell	Off	224	Agogo-Bell	Off	224	Agogo-Bell	Off	
69	A4	219 Cabasa-Up	Off	219	Cabasa-Up	Off	219	Cabasa-Up	Off	219	Cabasa-Up	Off	
70	A#4	182 MaracasPush	Off	182	MaracasPush	Off	182	MaracasPush	Off	101	HH-Old Open2	Off	
71	B4	234 SambaWhistle	2	234	SambaWhistle	2	234	SambaWhistle	2	234	SambaWhistle	2	
72	C5	234 SambaWhistle	2	234	SambaWhistle	2	234	SambaWhistle	2	234	SambaWhistle	2	
73	C#5	181 Guiro Short	3	181	Guiro Short	3	181	Guiro Short	3	181	Guiro Short	3	
74	D5	180 Guiro Long	3	180	Guiro Long	3	180	Guiro Long	3	180	Guiro Long	3	
75	D#5	199 Claves	Off	199	Claves	Off	199	Claves	Off	199	Claves	Off	
76	E5	200 Woodblock1	Off	200	Woodblock1	Off	200	Woodblock1	Off	200	Woodblock1	Off	
77	F5	200 Woodblock1	Off	200	Woodblock1	Off	200	Woodblock1	Off	200	Woodblock1	Off	
78	F#5	215 Cuica-Hi	4	215	Cuica-Hi	4	215	Cuica-Hi	4	215	Cuica-Hi	4	
79	G5	216 Cuica-Lo	4	216	Cuica-Lo	4	216	Cuica-Lo	4	216	Cuica-Lo	4	
80	G#5	214 Triangle-Mute	5	214	Triangle-Mute	5	214	Triangle-Mute	5	214	Triangle-Mute	5	
81	A5	213 Triangle-Open	5	213	Triangle-Open	5	213	Triangle-Open	5	213	Triangle-Open	5	
82	A#5	220 Cabasa-Down	Off	220	Cabasa-Down	Off	220	Cabasa-Down	Off	220	Cabasa-Down	Off	
83	B5	228 Sleigh Bell	Off	228	Sleigh Bell	Off	228	Sleigh Bell	Off	228	Sleigh Bell	Off	
84	C6	231 Marc Tree	Off	231	Marc Tree	Off	231	Marc Tree	Off	231	Marc Tree	Off	
85	C#6	178 CastSingle	Off	178	CastSingle	Off	178	CastSingle	Off	178	CastSingle	Off	
86	D6	203 TimbaleLo-Mute	6	203	TimbaleLo-Mute	6	203	TimbaleLo-Mute	6	203	TimbaleLo-Mute	6	
87	D#6	202 TimbaleLo-Open	6	202	TimbaleLo-Open	6	202	TimbaleLo-Open	6	202	TimbaleLo-Open	6	
88	E6	243 Stadium	Off	243	Stadium	Off	243	Stadium	Off	243	Stadium	Off	

Note		120-0-10: Jungle Kit		120-0-11: Techno Kit1		120-0-12: Room Kit2		120-0-13: HipHop Kit2		
		Sample	Excl.	Sample	Excl.	Sample	Excl.	Sample	Excl.	
9	A-1	13	BD-Squash	Off	21	BD-Hip 3	Off	13	BD-Squash	Off
10	A#-1	59	SD-Hip 6	Off	59	SD-Hip 6	Off	59	SD-Hip 6	Off
11	B-1	123	88-BD	Off	123	88-BD	Off	123	88-BD	Off
12	C0	124	88-SD	Off	124	88-SD	Off	124	88-SD	Off
13	C#0	56	SD-Hip 3	Off	56	SD-Hip 3	Off	56	SD-Hip 3	Off
14	D0	58	SD-Hip 5	Off	58	SD-Hip 5	Off	58	SD-Hip 5	Off
15	D#0	25	BD-Ambi Kick	Off	25	BD-Ambi Kick	Off	25	BD-Ambi Kick	Off
16	E0	11	BD-Gated	Off	11	BD-Gated	Off	11	BD-Gated	Off
17	F0	40	SD-Amb.Piccolo	Off	40	SD-Amb.Piccolo	Off	40	SD-Amb.Piccolo	Off
18	F#0	90	HH1 Open 2	1	90	HH1 Open 2	1	90	HH1 Open 2	1
19	G0	6	BD-Pillow	Off	6	BD-Pillow	Off	6	BD-Pillow	Off
20	G#0	72	SideStickDry	Off	72	SideStickDry	Off	72	SideStickDry	Off
21	A0	47	SD-Yowie	Off	47	SD-Yowie	Off	46	SD-Big Rock	Off
22	A#0	59	SD-Hip 6	Off	59	SD-Hip 6	Off	59	SD-Hip 6	Off
23	B0	74	DrumStickHit	Off	74	DrumStickHit	Off	74	DrumStickHit	Off
24	C1	120	SD-Orch.	7	120	SD-Orch.	7	120	SD-Orch.	7
25	C#1	119	SD-Orch.Roll	7	119	SD-Orch.Roll	7	119	SD-Orch.Roll	7
26	D1	121	FingerSnaps	Off	121	FingerSnaps	Off	121	FingerSnaps	Off
27	D#1	143	Zap2	Off	143	Zap2	Off	143	Zap2	Off
28	E1	281	Noise White	Off	281	Noise White	Off	281	Noise White	Off
29	F1	145	DJ-Scratch2	7	145	DJ-Scratch2	7	145	DJ-Scratch2	7
30	F#1	145	DJ-Scratch2	7	145	DJ-Scratch2	7	145	DJ-Scratch2	7
31	G1	74	DrumStickHit	Off	74	DrumStickHit	Off	74	DrumStickHit	Off
32	G#1	142	Zap1	Off	142	Zap1	Off	142	Zap1	Off
33	A1	249	Click	Off	249	Click	Off	249	Click	Off
34	A#1	213	Triangle-Open	Off	213	Triangle-Open	Off	213	Triangle-Open	Off
35	B1	19	BD-Hip 1	Off	13	BD-Squash	Off	12	BD-Tight	Off
36	C2	29	BD-Deep 88	Off	17	BD-House 1	Off	27	BD-Amb.Rocker	Off
37	C#2	121	FingerSnaps	Off	242	Comp Voice Noise	Off	72	SideStickDry	Off
38	D2	66	SD-Vintage5	Off	125	99-SD	Off	48	SD-Processed	Off
39	D#2	127	88-Claps	Off	127	88-Claps	Off	127	88-Claps	Off
40	E2	61	SD-Tiny	Off	125	99-SD	Off	47	SD-Yowie	Off
41	F2	75	Tom 1-Hi	Off	139	Real El.Tom	Off	76	Tom 1-Floor	Off
42	F#2	129	88-HH Open	1	99	HH-Old TiteClose	1	93	HH2 Closed2	1
43	G2	75	Tom 1-Hi	Off	139	Real El.Tom	Off	76	Tom 1-Floor	Off
44	G#2	102	HH-Hip	Off	103	HH-AlpoClose	Off	94	HH2 Foot	1
45	A2	75	Tom 1-Hi	Off	139	Real El.Tom	Off	75	Tom 1-Hi	Off
46	A#2	98	HH-Old Open1	1	101	HH-Old Open2	1	91	HH1 Sizzle	1
47	B2	75	Tom 1-Hi	Off	139	Real El.Tom	Off	75	Tom 1-Hi	Off
48	C3	75	Tom 1-Hi	Off	139	Real El.Tom	Off	75	Tom 1-Hi	Off
49	C#3	132	88-Crash	Off	104	Crash Cymbal 1	Off	104	Crash Cymbal 1	Off
50	D3	75	Tom 1-Hi	Off	139	Real El.Tom	Off	75	Tom 1-Hi	Off
51	D#3	113	Ride-Edge 2	Off	113	Ride-Edge 2	Off	113	Ride-Edge 2	Off
52	E3	108	CymbalReverse	Off	108	CymbalReverse	Off	106	China Cymbal	Off
53	F3	114	Ride-Jazz	Off	114	Ride-Jazz	Off	114	Ride-Jazz	Off
54	F#3	212	Tambourin-Acc2	Off	212	Tambourin-Acc2	Off	212	Tambourin-Acc2	Off
55	G3	107	Splash Cymbal	Off	106	China Cymbal	Off	107	Splash Cymbal	Off
56	G#3	136	88-Cowbell	Off	225	Cowbell	Off	225	Cowbell	Off
57	A3	104	Crash Cymbal 1	Off	104	Crash Cymbal 1	Off	104	Crash Cymbal 1	Off
58	A#3	198	Vibraslap	Off	198	Vibraslap	Off	198	Vibraslap	Off
59	B3	113	Ride-Edge 2	Off	113	Ride-Edge 2	Off	113	Ride-Edge 2	Off
60	C4	171	BongoHi-Open	Off	171	BongoHi-Open	Off	171	BongoHi-Open	Off
61	C#4	168	BongoLo-Open	Off	168	BongoLo-Open	Off	168	BongoLo-Open	Off
62	D4	163	CongaHiMtSlap	Off	163	CongaHiMtSlap	Off	163	CongaHiMtSlap	Off
63	D#4	161	CongaHi-Open	Off	161	CongaHi-Open	Off	161	CongaHi-Open	Off
64	E4	158	CongaLo-Open	Off	158	CongaLo-Open	Off	158	CongaLo-Open	Off
65	F4	207	TimbaleHi-Rim2	Off	207	TimbaleHi-Rim2	Off	207	TimbaleHi-Rim2	Off
66	F#4	202	TimbaleLo-Open	Off	202	TimbaleLo-Open	Off	202	TimbaleLo-Open	Off
67	G4	224	Agogo-Bell	Off	224	Agogo-Bell	Off	224	Agogo-Bell	Off
68	G#4	224	Agogo-Bell	Off	224	Agogo-Bell	Off	224	Agogo-Bell	Off
69	A4	219	Cabasa-Up	Off	219	Cabasa-Up	Off	219	Cabasa-Up	Off
70	A#4	101	HH-Old Open2	Off	182	MaracasPush	Off	182	MaracasPush	Off
71	B4	234	SambaWhistle	2	234	SambaWhistle	2	234	SambaWhistle	2
72	C5	234	SambaWhistle	2	234	SambaWhistle	2	234	SambaWhistle	2
73	C#5	181	Guiro Short	3	181	Guiro Short	3	181	Guiro Short	3
74	D5	180	Guiro Long	3	180	Guiro Long	3	180	Guiro Long	3
75	D#5	199	Claves	Off	199	Claves	Off	199	Claves	Off
76	E5	200	Woodblock1	Off	200	Woodblock1	Off	200	Woodblock1	Off
77	F5	200	Woodblock1	Off	200	Woodblock1	Off	200	Woodblock1	Off
78	F#5	215	Cuica-Hi	4	215	Cuica-Hi	4	215	Cuica-Hi	4
79	G5	216	Cuica-Lo	4	216	Cuica-Lo	4	216	Cuica-Lo	4
80	G#5	214	Triangle-Mute	5	214	Triangle-Mute	5	214	Triangle-Mute	5
81	A5	213	Triangle-Open	5	213	Triangle-Open	5	213	Triangle-Open	5
82	A#5	220	Cabasa-Down	Off	220	Cabasa-Down	Off	220	Cabasa-Down	Off
83	B5	228	Sleigh Bell	Off	228	Sleigh Bell	Off	228	Sleigh Bell	Off
84	C6	231	Marc Tree	Off	231	Marc Tree	Off	231	Marc Tree	Off
85	C#6	178	CastSingle	Off	178	CastSingle	Off	178	CastSingle	Off
86	D6	203	TimbaleLo-Mute	6	203	TimbaleLo-Mute	6	203	TimbaleLo-Mute	6
87	D#6	202	TimbaleLo-Open	6	202	TimbaleLo-Open	6	202	TimbaleLo-Open	6
88	E6	243	Stadium	Off	243	Stadium	Off	243	Stadium	Off

		120-0-14: Techno Kit2			120-0-15: Techno Kit3			120-0-16: Power Kit1			120-0-17: Power Kit2		
Note		Sample	Excl.	Sample	Excl.	Sample	Excl.	Sample	Excl.	Sample	Excl.		
9	A-1	13 BD-Squash	Off	13 BD-Squash	Off	24 BD-Dance 99	Off	24 BD-Dance 99	Off	24 BD-Dance 99	Off		
10	A#-1	59 SD-Hip 6	Off	59 SD-Hip 6	Off	125 99-SD	Off	125 99-SD	Off	125 99-SD	Off		
11	B-1	123 88-BD	Off	123 88-BD	Off	123 88-BD	Off	123 88-BD	Off	123 88-BD	Off		
12	C0	124 88-SD	Off	124 88-SD	Off	124 88-SD	Off	124 88-SD	Off	124 88-SD	Off		
13	C#0	56 SD-Hip 3	Off	56 SD-Hip 3	Off	65 SD-Vintage4	Off	65 SD-Vintage4	Off	65 SD-Vintage4	Off		
14	D0	58 SD-Hip 5	Off	58 SD-Hip 5	Off	64 SD-Vintage3	Off	64 SD-Vintage3	Off	64 SD-Vintage3	Off		
15	D#0	25 BD-Ambi Kick	Off	25 BD-Ambi Kick	Off	27 BD-Amb.Rocker	Off	27 BD-Amb.Rocker	Off	27 BD-Amb.Rocker	Off		
16	E0	11 BD-Gated	Off	11 BD-Gated	Off	19 BD-Hip 1	Off	19 BD-Hip 1	Off	19 BD-Hip 1	Off		
17	F0	40 SD-Amb.Piccolo	Off	40 SD-Amb.Piccolo	Off	38 SD-Off Center	Off	38 SD-Off Center	Off	38 SD-Off Center	Off		
18	F#0	90 HH1 Open 2	1	90 HH1 Open 2	1	93 HH2 Closed2	1	93 HH2 Closed2	1	93 HH2 Closed2	1		
19	G0	6 BD-Pillow	Off	6 BD-Pillow	Off	13 BD-Squash	Off	13 BD-Squash	Off	13 BD-Squash	Off		
20	G#0	72 SideStickDry	Off	72 SideStickDry	Off	73 SideStickAmb	Off	73 SideStickAmb	Off	73 SideStickAmb	Off		
21	A0	47 SD-Yowie	Off	47 SD-Yowie	Off	62 SD-Vintage1	Off	62 SD-Vintage1	Off	62 SD-Vintage1	Off		
22	A#0	59 SD-Hip 6	Off	59 SD-Hip 6	Off	69 SD-Brasser	Off	69 SD-Brasser	Off	69 SD-Brasser	Off		
23	B0	74 DrumStickHit	Off	74 DrumStickHit	Off	74 DrumStickHit	Off	74 DrumStickHit	Off	74 DrumStickHit	Off		
24	C1	120 SD-Orch.	7	120 SD-Orch.	7	120 SD-Orch.	7	120 SD-Orch.	7	120 SD-Orch.	7		
25	C#1	119 SD-Orch.Roll	7	119 SD-Orch.Roll	7	119 SD-Orch.Roll	7	119 SD-Orch.Roll	7	119 SD-Orch.Roll	7		
26	D1	121 FingerSnaps	Off	121 FingerSnaps	Off	121 FingerSnaps	Off	121 FingerSnaps	Off	121 FingerSnaps	Off		
27	D#1	143 Zap2	Off	143 Zap2	Off	143 Zap2	Off	143 Zap2	Off	143 Zap2	Off		
28	E1	281 Noise White	Off	281 Noise White	Off	281 Noise White	Off	281 Noise White	Off	281 Noise White	Off		
29	F1	145 DJ-Scratch2	7	145 DJ-Scratch2	7	145 DJ-Scratch2	7	145 DJ-Scratch2	7	145 DJ-Scratch2	7		
30	F#1	145 DJ-Scratch2	7	145 DJ-Scratch2	7	145 DJ-Scratch2	7	145 DJ-Scratch2	7	145 DJ-Scratch2	7		
31	G1	74 DrumStickHit	Off	74 DrumStickHit	Off	74 DrumStickHit	Off	74 DrumStickHit	Off	74 DrumStickHit	Off		
32	G#1	142 Zap1	Off	142 Zap1	Off	142 Zap1	Off	142 Zap1	Off	142 Zap1	Off		
33	A1	249 Click	Off	249 Click	Off	249 Click	Off	249 Click	Off	249 Click	Off		
34	A#1	213 Triangle-Open	Off	213 Triangle-Open	Off	213 Triangle-Open	Off	213 Triangle-Open	Off	213 Triangle-Open	Off		
35	B1	23 BD-Pop Kick	Off	23 BD-Pop Kick	Off	11 BD-Gated	Off	23 BD-Pop Kick	Off	23 BD-Pop Kick	Off		
36	C2	17 BD-House 1	Off	17 BD-House 1	Off	9 BD-Terminator	Off	11 BD-Gated	Off	11 BD-Gated	Off		
37	C#2	126 88-Rimshot	Off	140 PR-House05	Off	73 SideStickAmb	Off	72 SideStickDry	Off	72 SideStickDry	Off		
38	D2	52 SD-Noise	Off	70 SD-Chili	Off	50 SD-Dance	Off	48 SD-Processed	Off	48 SD-Processed	Off		
39	D#2	127 88-Claps	Off	127 88-Claps	Off	122 Hand Claps	Off	122 Hand Claps	Off	122 Hand Claps	Off		
40	E2	143 Zap2	Off	124 88-SD	Off	49 SD-CrackerRoom	Off	60 SD-Ringy	Off	60 SD-Ringy	Off		
41	F2	133 88-Tom	Off	257 Tribe	Off	82 Tom Processed	Off	82 Tom Processed	Off	82 Tom Processed	Off		
42	F#2	99 HH-Old TiteClos	1	130 99-HH Close	1	92 HH2 Closed1	1	93 HH2 Closed2	1	93 HH2 Closed2	1		
43	G2	133 88-Tom	Off	273 Wind	Off	82 Tom Processed	Off	82 Tom Processed	Off	82 Tom Processed	Off		
44	G#2	103 HH-AlpoClose	Off	100 HH-OldClose2	Off	88 HH1 Foot	1	94 HH2 Foot	1	94 HH2 Foot	1		
45	A2	133 88-Tom	Off	296 Amp Noise	Off	82 Tom Processed	Off	82 Tom Processed	Off	82 Tom Processed	Off		
46	A#2	101 HH-Old Open2	1	131 99-HH Open	1	96 HH2 Open	1	96 HH2 Open	1	96 HH2 Open	1		
47	B2	133 88-Tom	Off	139 Real El.Tom	Off	82 Tom Processed	Off	82 Tom Processed	Off	82 Tom Processed	Off		
48	C3	133 88-Tom	Off	139 Real El.Tom	Off	82 Tom Processed	Off	82 Tom Processed	Off	82 Tom Processed	Off		
49	C#3	104 Crash Cymbal 1	Off	104 Crash Cymbal 1	Off	104 Crash Cymbal 1	Off	104 Crash Cymbal 1	Off	104 Crash Cymbal 1	Off		
50	D3	133 88-Tom	Off	139 Real El.Tom	Off	82 Tom Processed	Off	82 Tom Processed	Off	82 Tom Processed	Off		
51	D#3	113 Ride-Edge 2	Off	113 Ride-Edge 2	Off	113 Ride-Edge 2	Off	113 Ride-Edge 2	Off	113 Ride-Edge 2	Off		
52	E3	108 CymbalReverse	Off	108 CymbalReverse	Off	106 China Cymbal	Off	106 China Cymbal	Off	106 China Cymbal	Off		
53	F3	114 Ride-Jazz	Off	114 Ride-Jazz	Off	114 Ride-Jazz	Off	114 Ride-Jazz	Off	114 Ride-Jazz	Off		
54	F#3	212 Tambourin-Acc2	Off	212 Tambourin-Acc2	Off	212 Tambourin-Acc2	Off	212 Tambourin-Acc2	Off	212 Tambourin-Acc2	Off		
55	G3	107 Splash Cymbal	Off	278 Xylophone Spectr	Off	107 Splash Cymbal	Off	107 Splash Cymbal	Off	107 Splash Cymbal	Off		
56	G#3	136 88-Cowbell	Off	136 88-Cowbell	Off	225 Cowbell	Off	225 Cowbell	Off	225 Cowbell	Off		
57	A3	104 Crash Cymbal 1	Off	104 Crash Cymbal 1	Off	104 Crash Cymbal 1	Off	104 Crash Cymbal 1	Off	104 Crash Cymbal 1	Off		
58	A#3	198 Vibraslap	Off	212 Tambourin-Acc2	Off	198 Vibraslap	Off	198 Vibraslap	Off	198 Vibraslap	Off		
59	B3	113 Ride-Edge 2	Off	113 Ride-Edge 2	Off	113 Ride-Edge 2	Off	113 Ride-Edge 2	Off	113 Ride-Edge 2	Off		
60	C4	134 88-Conga	Off	171 BongoHi-Open	Off	171 BongoHi-Open	Off	171 BongoHi-Open	Off	171 BongoHi-Open	Off		
61	C#4	134 88-Conga	Off	168 BongoLo-Open	Off	168 BongoLo-Open	Off	168 BongoLo-Open	Off	168 BongoLo-Open	Off		
62	D4	134 88-Conga	Off	163 CongaHiMtSlap	Off	163 CongaHiMtSlap	Off	163 CongaHiMtSlap	Off	163 CongaHiMtSlap	Off		
63	D#4	134 88-Conga	Off	161 CongaHi-Open	Off	161 CongaHi-Open	Off	161 CongaHi-Open	Off	161 CongaHi-Open	Off		
64	E4	134 88-Conga	Off	158 CongaLo-Open	Off	158 CongaLo-Open	Off	158 CongaLo-Open	Off	158 CongaLo-Open	Off		
65	F4	207 TimbaleHi-Rim2	Off	207 TimbaleHi-Rim2	Off	207 TimbaleHi-Rim2	Off	207 TimbaleHi-Rim2	Off	207 TimbaleHi-Rim2	Off		
66	F#4	202 TimbaleLo-Open	Off	202 TimbaleLo-Open	Off	202 TimbaleLo-Open	Off	202 TimbaleLo-Open	Off	202 TimbaleLo-Open	Off		
67	G4	224 Agogo-Bell	Off	224 Agogo-Bell	Off	224 Agogo-Bell	Off	224 Agogo-Bell	Off	224 Agogo-Bell	Off		
68	G#4	224 Agogo-Bell	Off	224 Agogo-Bell	Off	224 Agogo-Bell	Off	224 Agogo-Bell	Off	224 Agogo-Bell	Off		
69	A4	219 Cabasa-Up	Off	219 Cabasa-Up	Off	219 Cabasa-Up	Off	219 Cabasa-Up	Off	219 Cabasa-Up	Off		
70	A#4	182 MaracasPush	Off	182 MaracasPush	Off	182 MaracasPush	Off	182 MaracasPush	Off	182 MaracasPush	Off		
71	B4	234 SambaWhistle	2	234 SambaWhistle	2	234 SambaWhistle	2	234 SambaWhistle	2	234 SambaWhistle	2		
72	C5	234 SambaWhistle	2	234 SambaWhistle	2	234 SambaWhistle	2	234 SambaWhistle	2	234 SambaWhistle	2		
73	C#5	181 Guiro Short	3	181 Guiro Short	3	181 Guiro Short	3	181 Guiro Short	3	181 Guiro Short	3		
74	D5	180 Guiro Long	3	180 Guiro Long	3	180 Guiro Long	3	180 Guiro Long	3	180 Guiro Long	3		
75	D#5	199 Claves	Off	199 Claves	Off	199 Claves	Off	199 Claves	Off	199 Claves	Off		
76	E5	200 Woodblock1	Off	200 Woodblock1	Off	200 Woodblock1	Off	200 Woodblock1	Off	200 Woodblock1	Off		
77	F5	200 Woodblock1	Off	200 Woodblock1	Off	200 Woodblock1	Off	200 Woodblock1	Off	200 Woodblock1	Off		
78	F#5	215 Cuica-Hi	4	239 Uhh	Off	215 Cuica-Hi	4	215 Cuica-Hi	4	215 Cuica-Hi	4		
79	G5	215 Cuica-Hi	4	237 Yeah!	Off	216 Cuica-Lo	4	216 Cuica-Lo	4	216 Cuica-Lo	4		
80	G#5	233 Flexatone	5	214 Triangle-Mute	5	214 Triangle-Mute	5	214 Triangle-Mute	5	214 Triangle-Mute	5		
81	A5	233 Flexatone	5	213 Triangle-Open	5	213 Triangle-Open	5	213 Triangle-Open	5	213 Triangle-Open	5		
82	A#5	220 Cabasa-Down	Off	220 Cabasa-Down	Off	220 Cabasa-Down	Off	220 Cabasa-Down	Off	220 Cabasa-Down	Off		
83	B5	228 Sleigh Bell	Off	228 Sleigh Bell	Off	228 Sleigh Bell	Off	228 Sleigh Bell	Off	228 Sleigh Bell	Off		
84	C6	231 Marc Tree	Off	231 Marc Tree	Off	231 Marc Tree	Off	231 Marc Tree	Off	231 Marc Tree	Off		
85	C#6	178 CastSingle	Off	178 CastSingle	Off	178 CastSingle	Off	178 CastSingle	Off	178 CastSingle	Off		
86	D6	203 TimbaleLo-Mute	6	203 TimbaleLo-Mute	6	203 TimbaleLo-Mute	6	203 TimbaleLo-Mute	6	203 TimbaleLo-Mute	6		
87	D#6	342 Darbuka 1 DumOp	6	202 TimbaleLo-Open	6	202 TimbaleLo-Open	6	202 TimbaleLo-Open	6	202 TimbaleLo-Open	6		
88	E6	243 Stadium	Off	243 Stadium	Off	243 Stadium	Off	243 Stadium	Off	243 Stadium	Off		

		120-0-24: Electro Kit			120-0-25: Analog Kit			120-0-26: House Kit1			120-0-27: House Kit2		
Note		Sample	Excl.	Sample	Excl.	Sample	Excl.	Sample	Excl.	Sample	Excl.		
9	A-1	19	BD-Hip 1	Off	271	Explosion	Off	23	BD-Pop Kick	Off	23	BD-Pop Kick	Off
10	A#-1	125	99-SD	Off	59	SD-Hip 6	Off	67	SD-Vintage6	Off	125	99-SD	Off
11	B-1	123	88-BD	Off	3	BD-Normal	Off	29	BD-Deep 88	Off	29	BD-Deep 88	Off
12	C0	124	88-SD	Off	47	SD-Yowie	Off	124	88-SD	Off	124	88-SD	Off
13	C#0	38	SD-Off Center	Off	39	SD-Jazz Ring	Off	50	SD-Dance	Off	50	SD-Dance	Off
14	D0	64	SD-Vintage3	Off	71	SD-Whopper	Off	40	SD-Amb.Piccolo	Off	40	SD-Amb.Piccolo	Off
15	D#0	23	BD-Pop Kick	Off	23	BD-Pop Kick	Off	25	BD-Ambi Kick	Off	25	BD-Ambi Kick	Off
16	E0	25	BD-Ambi Kick	Off	24	BD-Dance 99	Off	9	BD-Terminator	Off	9	BD-Terminator	Off
17	F0	59	SD-Hip 6	Off	69	SD-Brasser	Off	65	SD-Vintage4	Off	65	SD-Vintage4	Off
18	F#0	128	88-HH Close	1	86	HH1 Closed1	1	143	Zap2	Off	143	Zap2	Off
19	G0	17	BD-House 1	Off	19	BD-Hip 1	Off	22	BD-Hip 4	Off	22	BD-Hip 4	Off
20	G#0	143	Zap2	Off	142	Zap1	Off	142	Zap1	Off	142	Zap1	Off
21	A0	48	SD-Processed	Off	59	SD-Hip 6	Off	66	SD-Vintage5	Off	66	SD-Vintage5	Off
22	A#0	65	SD-Vintage4	Off	61	SD-Tiny	Off	310	Mouth Harp	Off	310	Mouth Harp	Off
23	B0	74	DrumStickHit	Off	74	DrumStickHit	Off	74	DrumStickHit	Off	74	DrumStickHit	Off
24	C1	120	SD-Orch.	7	120	SD-Orch.	7	120	SD-Orch.	7	120	SD-Orch.	7
25	C#1	119	SD-Orch.Roll	7	119	SD-Orch.Roll	7	119	SD-Orch.Roll	7	119	SD-Orch.Roll	7
26	D1	121	FingerSnaps	Off	121	FingerSnaps	Off	121	FingerSnaps	Off	121	FingerSnaps	Off
27	D#1	143	Zap2	Off	143	Zap2	Off	143	Zap2	Off	143	Zap2	Off
28	E1	281	Noise White	Off	281	Noise White	Off	281	Noise White	Off	281	Noise White	Off
29	F1	145	DJ-Scratch2	7	145	DJ-Scratch2	7	145	DJ-Scratch2	7	145	DJ-Scratch2	7
30	F#1	145	DJ-Scratch2	7	145	DJ-Scratch2	7	145	DJ-Scratch2	7	145	DJ-Scratch2	7
31	G1	74	DrumStickHit	Off	74	DrumStickHit	Off	74	DrumStickHit	Off	74	DrumStickHit	Off
32	G#1	142	Zap1	Off	142	Zap1	Off	142	Zap1	Off	142	Zap1	Off
33	A1	249	Click	Off	249	Click	Off	249	Click	Off	249	Click	Off
34	A#1	213	Triangle-Open	Off	213	Triangle-Open	Off	213	Triangle-Open	Off	213	Triangle-Open	Off
35	B1	15	BD-Dance 2	Off	29	BD-Deep 88	Off	21	BD-Hip 3	Off	21	BD-Hip 3	Off
36	C2	138	FM El.Tom	Off	29	BD-Deep 88	Off	25	BD-Ambi Kick	Off	13	BD-Squash	Off
37	C#2	141	PR-House06	Off	126	88-Rimshot	Off	141	PR-House06	Off	319	Rek-Jingle	Off
38	D2	139	Real El.Tom	Off	124	88-SD	Off	61	SD-Tiny	Off	65	SD-Vintage4	Off
39	D#2	127	88-Claps	Off	127	88-Claps	Off	127	88-Claps	Off	127	88-Claps	Off
40	E2	58	SD-Hip 5	Off	124	88-SD	Off	125	99-SD	Off	51	SD-Rap	Off
41	F2	139	Real El.Tom	Off	133	88-Tom	Off	257	Tribe	Off	79	Tom 2-Floor	Off
42	F#2	90	HH1 Open 2	1	128	88-HH Close	1	130	99-HH Close	1	99	HH-Old TiteClos	1
43	G2	139	Real El.Tom	Off	133	88-Tom	Off	82	Tom Processed	Off	79	Tom 2-Floor	Off
44	G#2	94	HH2 Foot	1	129	88-HH Open	1	96	HH2 Open	Off	103	HH-AlpoClose	Off
45	A2	139	Real El.Tom	Off	133	88-Tom	Off	123	88-BD	Off	78	Tom 2-Lo	Off
46	A#2	89	HH1 Open 1	1	129	88-HH Open	1	131	99-HH Open	1	97	HH-OldClose1	1
47	B2	139	Real El.Tom	Off	133	88-Tom	Off	139	Real El.Tom	Off	78	Tom 2-Lo	Off
48	C3	139	Real El.Tom	Off	133	88-Tom	Off	139	Real El.Tom	Off	77	Tom 2-Hi	Off
49	C#3	104	Crash Cymbal 1	Off	132	88-Crash	Off	104	Crash Cymbal 1	Off	104	Crash Cymbal 1	Off
50	D3	139	Real El.Tom	Off	133	88-Tom	Off	139	Real El.Tom	Off	77	Tom 2-Hi	Off
51	D#3	113	Ride-Edge 2	Off	113	Ride-Edge 2	Off	113	Ride-Edge 2	Off	113	Ride-Edge 2	Off
52	E3	108	CymbalReverse	Off	106	China Cymbal	Off	108	CymbalReverse	Off	108	CymbalReverse	Off
53	F3	114	Ride-Jazz	Off	114	Ride-Jazz	Off	114	Ride-Jazz	Off	114	Ride-Jazz	Off
54	F#3	212	Tambourin-Acc2	Off	282	Noise FM Mod	Off	212	Tambourin-Acc2	Off	212	Tambourin-Acc2	Off
55	G3	107	Splash Cymbal	Off	107	Splash Cymbal	Off	106	China Cymbal	Off	106	China Cymbal	Off
56	G#3	225	Cowbell	Off	136	88-Cowbell	Off	225	Cowbell	Off	225	Cowbell	Off
57	A3	104	Crash Cymbal 1	Off	104	Crash Cymbal 1	Off	104	Crash Cymbal 1	Off	104	Crash Cymbal 1	Off
58	A#3	198	Vibraslap	Off	198	Vibraslap	Off	198	Vibraslap	Off	198	Vibraslap	Off
59	B3	113	Ride-Edge 2	Off	113	Ride-Edge 2	Off	113	Ride-Edge 2	Off	113	Ride-Edge 2	Off
60	C4	171	BongoHi-Open	Off	134	88-Conga	Off	171	BongoHi-Open	Off	171	BongoHi-Open	Off
61	C#4	168	BongoLo-Open	Off	134	88-Conga	Off	168	BongoLo-Open	Off	168	BongoLo-Open	Off
62	D4	163	CongaHiMtSlap	Off	134	88-Conga	Off	163	CongaHiMtSlap	Off	163	CongaHiMtSlap	Off
63	D#4	161	CongaHi-Open	Off	133	88-Tom	Off	161	CongaHi-Open	Off	161	CongaHi-Open	Off
64	E4	158	CongaLo-Open	Off	133	88-Tom	Off	158	CongaLo-Open	Off	158	CongaLo-Open	Off
65	F4	207	TimbaleHi-Rim2	Off	207	TimbaleHi-Rim2	Off	207	TimbaleHi-Rim2	Off	207	TimbaleHi-Rim2	Off
66	F#4	202	TimbaleLo-Open	Off	202	TimbaleLo-Open	Off	202	TimbaleLo-Open	Off	202	TimbaleLo-Open	Off
67	G4	224	Agogo-Bell	Off	224	Agogo-Bell	Off	224	Agogo-Bell	Off	224	Agogo-Bell	Off
68	G#4	224	Agogo-Bell	Off	224	Agogo-Bell	Off	224	Agogo-Bell	Off	224	Agogo-Bell	Off
69	A4	219	Cabasa-Up	Off	219	Cabasa-Up	Off	219	Cabasa-Up	Off	219	Cabasa-Up	Off
70	A#4	182	MaracasPush	Off	182	MaracasPush	Off	102	HH-Hip	Off	209	Tambourin-Push	Off
71	B4	234	SambaWhistle	2	234	SambaWhistle	2	234	SambaWhistle	2	234	SambaWhistle	2
72	C5	234	SambaWhistle	2	234	SambaWhistle	2	234	SambaWhistle	2	234	SambaWhistle	2
73	C#5	181	Guiro Short	3	181	Guiro Short	3	181	Guiro Short	3	181	Guiro Short	3
74	D5	180	Guiro Long	3	180	Guiro Long	3	180	Guiro Long	3	180	Guiro Long	3
75	D#5	199	Claves	Off	135	88-Clave	Off	199	Claves	Off	199	Claves	Off
76	E5	200	Woodblock1	Off	200	Woodblock1	Off	200	Woodblock1	Off	200	Woodblock1	Off
77	F5	200	Woodblock1	Off	200	Woodblock1	Off	200	Woodblock1	Off	200	Woodblock1	Off
78	F#5	215	Cuica-Hi	4	215	Cuica-Hi	4	239	Uhh	Off	215	Cuica-Hi	4
79	G5	216	Cuica-Lo	4	215	Cuica-Hi	4	237	Yeah!	Off	216	Cuica-Lo	4
80	G#5	214	Triangle-Mute	5	230	Finger Cymbal	5	214	Triangle-Mute	5	214	Triangle-Mute	5
81	A5	213	Triangle-Open	5	230	Finger Cymbal	5	213	Triangle-Open	5	213	Triangle-Open	5
82	A#5	220	Cabasa-Down	Off	220	Cabasa-Down	Off	101	HH-Old Open2	Off	220	Cabasa-Down	Off
83	B5	228	Sleigh Bell	Off	228	Sleigh Bell	Off	228	Sleigh Bell	Off	228	Sleigh Bell	Off
84	C6	231	Marc Tree	Off	231	Marc Tree	Off	231	Marc Tree	Off	231	Marc Tree	Off
85	C#6	178	CastSingle	Off	178	CastSingle	Off	178	CastSingle	Off	178	CastSingle	Off
86	D6	203	TimbaleLo-Mute	6	203	TimbaleLo-Mute	6	203	TimbaleLo-Mute	6	203	TimbaleLo-Mute	6
87	D#6	202	TimbaleLo-Open	6	202	TimbaleLo-Open	6	202	TimbaleLo-Open	6	202	TimbaleLo-Open	6
88	E6	243	Stadium	Off	243	Stadium	Off	243	Stadium	Off	243	Stadium	Off

Note	120-0-28: House Kit3			120-0-29: House Kit4			120-0-32: Jazz Kit			120-0-40: Brush Kit1		
	A#	Sample	Excl.	A#	Sample	Excl.	A#	Sample	Excl.	A#	Sample	Excl.
9	A-1	23 BD-Pop Kick	Off	23	BD-Pop Kick	Off	17	BD-House 1	Off	79	Tom 2-Floor	Off
10	A#-1	125 99-SD	Off	125	99-SD	Off	125	99-SD	Off	79	Tom 2-Floor	Off
11	B-1	29 BD-Deep 88	Off	29	BD-Deep 88	Off	29	BD-Deep 88	Off	79	Tom 2-Floor	Off
12	C0	124 88-SD	Off	124	88-SD	Off	124	88-SD	Off	78	Tom 2-Lo	Off
13	C#0	50 SD-Dance	Off	50	SD-Dance	Off	39	SD-Jazz Ring	Off	77	Tom 2-Hi	Off
14	D0	40 SD-Amb.Piccolo	Off	40	SD-Amb.Piccolo	Off	40	SD-Amb.Piccolo	Off	32	SD-Dry 2	Off
15	D#0	25 BD-Ambi Kick	Off	25	BD-Ambi Kick	Off	27	BD-Amb.Rocker	Off	5	BD-Jazz	Off
16	E0	9 BD-Terminator	Off	9	BD-Terminator	Off	6	BD-Pillow	Off	6	BD-Pillow	Off
17	F0	65 SD-Vintage4	Off	65	SD-Vintage4	Off	37	SD-Full Room	Off	121	FingerSnaps	Off
18	F#0	143 Zap2	Off	143	Zap2	Off	87	HH1 Closed2	1	86	HH1 Closed1	1
19	G0	22 BD-Hip 4	Off	22	BD-Hip 4	Off	0	BD-Dry 1	Off	2	BD-Dry 3	Off
20	G#0	142 Zap1	Off	142	Zap1	Off	73	SideStickAmb	Off	72	SideStickDry	Off
21	A0	66 SD-Vintage5	Off	66	SD-Vintage5	Off	32	SD-Dry 2	Off	43	SD-BrushTap1	7
22	A#0	310 Mouth Harp	Off	310	Mouth Harp	Off	42	SD-BrushHit	Off	43	SD-BrushTap1	7
23	B0	74 DrumStickHit	Off	74	DrumStickHit	Off	74	DrumStickHit	Off	74	DrumStickHit	Off
24	C1	120 SD-Orch.	7	120	SD-Orch.	7	120	SD-Orch.	7	120	SD-Orch.	7
25	C#1	119 SD-Orch.Roll	7	119	SD-Orch.Roll	7	119	SD-Orch.Roll	7	119	SD-Orch.Roll	7
26	D1	121 FingerSnaps	Off	121	FingerSnaps	Off	121	FingerSnaps	Off	121	FingerSnaps	Off
27	D#1	143 Zap2	Off	143	Zap2	Off	143	Zap2	Off	143	Zap2	Off
28	E1	281 Noise White	Off	281	Noise White	Off	281	Noise White	Off	281	Noise White	Off
29	F1	145 DJ-Scratch2	7	145	DJ-Scratch2	7	145	DJ-Scratch2	7	145	DJ-Scratch2	7
30	F#1	145 DJ-Scratch2	7	145	DJ-Scratch2	7	145	DJ-Scratch2	7	145	DJ-Scratch2	7
31	G1	74 DrumStickHit	Off	74	DrumStickHit	Off	74	DrumStickHit	Off	74	DrumStickHit	Off
32	G#1	142 Zap1	Off	142	Zap1	Off	142	Zap1	Off	142	Zap1	Off
33	A1	249 Click	Off	249	Click	Off	249	Click	Off	249	Click	Off
34	A#1	213 Triangle-Open	Off	213	Triangle-Open	Off	213	Triangle-Open	Off	213	Triangle-Open	Off
35	B1	28 BD-Pop 99	Off	21	BD-Hip 3	Off	5	BD-Jazz	Off	6	BD-Pillow	Off
36	C2	24 BD-Dance 99	Off	11	BD-Gated	Off	4	BD-SoftRoom	Off	5	BD-Jazz	Off
37	C#2	141 PR-House06	Off	73	SideStickAmb	Off	73	SideStickAmb	Off	73	SideStickAmb	Off
38	D2	47 SD-Yowie	Off	31	SD-Dry 1	Off	31	SD-Dry 1	Off	43	SD-BrushTap1	Off
39	D#2	127 88-Claps	Off	127	88-Claps	Off	127	88-Claps	Off	42	SD-BrushHit	Off
40	E2	59 SD-Hip 6	Off	52	SD-Noise	Off	39	SD-Jazz Ring	Off	45	SD-BrushSwirl	Off
41	F2	139 Real El.Tom	Off	139	Real El.Tom	Off	84	Tom JazzFloor	Off	85	Tom Brush Hi	Off
42	F#2	128 88-HH Close	1	128	88-HH Close	1	92	HH2 Closed1	1	90	HH1 Open 2	1
43	G2	139 Real El.Tom	Off	139	Real El.Tom	Off	84	Tom JazzFloor	Off	85	Tom Brush Hi	Off
44	G#2	128 88-HH Close	1	129	88-HH Open	Off	94	HH2 Foot	1	94	HH2 Foot	1
45	A2	139 Real El.Tom	Off	139	Real El.Tom	Off	83	Tom Jazz Hi	Off	85	Tom Brush Hi	Off
46	A#2	129 88-HH Open	1	129	88-HH Open	1	91	HH1 Sizzle	1	95	HH2 FootOpen	1
47	B2	139 Real El.Tom	Off	139	Real El.Tom	Off	83	Tom Jazz Hi	Off	85	Tom Brush Hi	Off
48	C3	139 Real El.Tom	Off	139	Real El.Tom	Off	83	Tom Jazz Hi	Off	85	Tom Brush Hi	Off
49	C#3	104 Crash Cymbal 1	Off	132	88-Crash	Off	104	Crash Cymbal 1	Off	104	Crash Cymbal 1	Off
50	D3	139 Real El.Tom	Off	139	Real El.Tom	Off	83	Tom Jazz Hi	Off	85	Tom Brush Hi	Off
51	D#3	113 Ride-Edge 2	Off	111	CYM-99 Ride	Off	113	Ride-Edge 2	Off	112	Ride-Edge 1	Off
52	E3	108 CymbalReverse	Off	108	CymbalReverse	Off	106	China Cymbal	Off	106	China Cymbal	Off
53	F3	114 Ride-Jazz	Off	114	Ride-Jazz	Off	115	Ride-Cup	Off	114	Ride-Jazz	Off
54	F#3	212 Tambourin-Acc2	Off	211	Tambourin-Acc1	Off	212	Tambourin-Acc2	Off	212	Tambourin-Acc2	Off
55	G3	107 Splash Cymbal	Off	107	Splash Cymbal	Off	105	Crash Cymbal 2	Off	107	Splash Cymbal	Off
56	G#3	225 Cowbell	Off	136	88-Cowbell	Off	225	Cowbell	Off	225	Cowbell	Off
57	A3	104 Crash Cymbal 1	Off	104	Crash Cymbal 1	Off	104	Crash Cymbal 1	Off	104	Crash Cymbal 1	Off
58	A#3	198 Vibraslap	Off	198	Vibraslap	Off	198	Vibraslap	Off	198	Vibraslap	Off
59	B3	113 Ride-Edge 2	Off	113	Ride-Edge 2	Off	112	Ride-Edge 1	Off	113	Ride-Edge 2	Off
60	C4	171 BongoHi-Open	Off	171	BongoHi-Open	Off	171	BongoHi-Open	Off	171	BongoHi-Open	Off
61	C#4	168 BongoLo-Open	Off	168	BongoLo-Open	Off	168	BongoLo-Open	Off	168	BongoLo-Open	Off
62	D4	163 CongaHiMtSlap	Off	163	CongaHiMtSlap	Off	165	CongaHi-Slap2	Off	163	CongaHiMtSlap	Off
63	D#4	161 CongaHi-Open	Off	161	CongaHi-Open	Off	161	CongaHi-Open	Off	161	CongaHi-Open	Off
64	E4	158 CongaLo-Open	Off	158	CongaLo-Open	Off	158	CongaLo-Open	Off	158	CongaLo-Open	Off
65	F4	207 TimbaleHi-Rim2	Off	207	TimbaleHi-Rim2	Off	207	TimbaleHi-Rim2	Off	207	TimbaleHi-Rim2	Off
66	F#4	202 TimbaleLo-Open	Off	202	TimbaleLo-Open	Off	202	TimbaleLo-Open	Off	202	TimbaleLo-Open	Off
67	G4	224 Agogo-Bell	Off	224	Agogo-Bell	Off	224	Agogo-Bell	Off	224	Agogo-Bell	Off
68	G#4	224 Agogo-Bell	Off	224	Agogo-Bell	Off	224	Agogo-Bell	Off	224	Agogo-Bell	Off
69	A4	219 Cabasa-Up	Off	219	Cabasa-Up	Off	219	Cabasa-Up	Off	219	Cabasa-Up	Off
70	A#4	102 HH-Hip	Off	209	Tambourin-Push	Off	182	MaracasPush	Off	182	MaracasPush	Off
71	B4	234 SambaWhistle	2	234	SambaWhistle	2	234	SambaWhistle	2	234	SambaWhistle	2
72	C5	234 SambaWhistle	2	234	SambaWhistle	2	234	SambaWhistle	2	234	SambaWhistle	2
73	C#5	181 Guiro Short	3	181	Guiro Short	3	181	Guiro Short	3	181	Guiro Short	3
74	D5	180 Guiro Long	3	180	Guiro Long	3	180	Guiro Long	3	180	Guiro Long	3
75	D#5	199 Claves	Off	199	Claves	Off	199	Claves	Off	199	Claves	Off
76	E5	200 Woodblock1	Off	200	Woodblock1	Off	200	Woodblock1	Off	200	Woodblock1	Off
77	F5	200 Woodblock1	Off	200	Woodblock1	Off	200	Woodblock1	Off	200	Woodblock1	Off
78	F#5	215 Cuica-Hi	Off	215	Cuica-Hi	4	215	Cuica-Hi	4	215	Cuica-Hi	4
79	G5	215 Cuica-Hi	Off	215	Cuica-Hi	4	216	Cuica-Lo	4	216	Cuica-Lo	4
80	G#5	233 Flexatone	5	233	Flexatone	5	214	Triangle-Mute	5	214	Triangle-Mute	5
81	A5	233 Flexatone	5	233	Flexatone	5	213	Triangle-Open	5	213	Triangle-Open	5
82	A#5	101 HH-Old Open2	Off	220	Cabasa-Down	Off	220	Cabasa-Down	Off	220	Cabasa-Down	Off
83	B5	228 Sleigh Bell	Off	228	Sleigh Bell	Off	228	Sleigh Bell	Off	228	Sleigh Bell	Off
84	C6	231 Marc Tree	Off	231	Marc Tree	Off	231	Marc Tree	Off	231	Marc Tree	Off
85	C#6	178 CastSingle	Off	178	CastSingle	Off	178	CastSingle	Off	178	CastSingle	Off
86	D6	203 TimbaleLo-Mute	6	203	TimbaleLo-Mute	6	203	TimbaleLo-Mute	6	203	TimbaleLo-Mute	6
87	D#6	202 TimbaleLo-Open	6	202	TimbaleLo-Open	6	202	TimbaleLo-Open	6	202	TimbaleLo-Open	6
88	E6	243 Stadium	Off	243	Stadium	Off	243	Stadium	Off	243	Stadium	Off

Note		120-0-41: Brush V.S.2		120-0-48: OrchestraK		120-0-116: Arabian Kit 1		120-0-117: Arabian Kit 2					
		Sample	Excl.	Sample	Excl.	Sample	Excl.	Sample	Excl.				
9	A-1	79	Tom 2-Floor	Off		17	BD-House 1	Off	17	BD-House 1	Off		
10	A#-1	79	Tom 2-Floor	Off		125	99-SD	Off	125	99-SD	Off		
11	B-1	79	Tom 2-Floor	Off		123	88-BD	Off	123	88-BD	Off		
12	C0	78	Tom 2-Lo	Off		124	88-SD	Off	124	88-SD	Off		
13	C#0	77	Tom 2-Hi	Off		37	SD-Full Room	Off	37	SD-Full Room	Off		
14	D0	32	SD-Dry 2	Off		48	SD-Processed	1	48	SD-Processed	1		
15	D#0	5	BD-Jazz	Off		0	BD-Dry 1	Off	0	BD-Dry 1	Off		
16	E0	6	BD-Pillow	Off		12	BD-Tight	Off	12	BD-Tight	Off		
17	F0	121	FingerSnaps	Off		31	SD-Dry 1	Off	31	SD-Dry 1	Off		
18	F#0	86	HH1 Closed1	1		87	HH1 Closed2	1	87	HH1 Closed2	1		
19	G0	2	BD-Dry 3	Off		2	BD-Dry 3	Off	2	BD-Dry 3	Off		
20	G#0	72	SideStickDry	Off		73	SideStickAmb	Off	73	SideStickAmb	Off		
21	A0	43	SD-BrushTap1	7		74	DrumStickHit	Off	74	DrumStickHit	Off		
22	A#0	43	SD-BrushTap1	7		283	Tubular	Off	283	Tubular	Off		
23	B0	74	DrumStickHit	Off		225	Cowbell	Off	225	Cowbell	Off		
24	C1	120	SD-Orch.	7	120	SD-Orch.	7	225	Cowbell	Off	225	Cowbell	Off
25	C#1	119	SD-Orch.Roll	7	119	SD-Orch.Roll	7	119	SD-Orch.Roll	Off	119	SD-Orch.Roll	Off
26	D1	121	FingerSnaps	Off	121	FingerSnaps	Off	121	FingerSnaps	Off	121	FingerSnaps	Off
27	D#1	143	Zap2	Off	86	HH1 Closed1	Off	143	Zap2	Off	143	Zap2	Off
28	E1	281	Noise White	Off	88	HH1 Foot	Off	87	HH1 Closed2	Off	87	HH1 Closed2	Off
29	F1	145	DJ-Scratch2	7	89	HH1 Open 1	7	145	DJ-Scratch2	Off	145	DJ-Scratch2	Off
30	F#1	145	DJ-Scratch2	7	112	Ride-Edge 1	Off	145	DJ-Scratch2	Off	145	DJ-Scratch2	Off
31	G1	74	DrumStickHit	Off	74	DrumStickHit	Off	74	DrumStickHit	Off	74	DrumStickHit	Off
32	G#1	142	Zap1	Off	142	Zap1	Off	165	CongaHi-Slap2	Off	165	CongaHi-Slap2	Off
33	A1	249	Click	Off	249	Click	Off	249	Click	Off	249	Click	Off
34	A#1	213	Triangle-Open	Off	213	Triangle-Open	Off	249	Click	Off	249	Click	Off
35	B1	5	BD-Jazz	Off	4	BD-SoftRoom	Off	2	BD-Dry 3	Off	2	BD-Dry 3	Off
36	C2	3-4	BD-Normal BD ->SoftRoom	Off	116	BD-Orch.	Off	17	BD-House 1	Off	12	BD-Tight	Off
37	C#2	43	SD-BrushTap1	Off	73	SideStickAmb	Off	72	SideStickDry	Off	72	SideStickDry	Off
38	D2	43 ->44	SD-BrushTap1 ->SD-BrushTap2	Off	120	SD-Orch.	Off	33	SD-Dry 3	Off	33	SD-Dry 3	Off
39	D#2	39 ->42	SD-Jazz Ring SD ->BrushHit	Off	178	CastSingle	Off	337	Alkis	Off	122	Hand Claps	Off
40	E2	45 ->45	SD-BrushSwirl SD ->BrushSwirl	Off	120	SD-Orch.	Off	68	SD-AmbilHop	Off	33	SD-Dry 3	Off
41	F2	85	Tom Brush Hi	Off	118	Timpani	Off	79	Tom 2-Floor	Off	79	Tom 2-Floor	Off
42	F#2	90	HH1 Open 2	1	118	Timpani	Off	88	HH1 Foot	1	90	HH1 Open 2	1
43	G2	85	Tom Brush Hi	Off	118	Timpani	Off	79	Tom 2-Floor	Off	79	Tom 2-Floor	Off
44	G#2	94	HH2 Foot	1	118	Timpani	Off	94	HH2 Foot	1	94	HH2 Foot	1
45	A2	85	Tom Brush Hi	Off	118	Timpani	Off	78	Tom 2-Lo	Off	78	Tom 2-Lo	Off
46	A#2	95	HH2 FootOpen	1	118	Timpani	Off	89	HH1 Open 1	1	89	HH1 Open 1	1
47	B2	85	Tom Brush Hi	Off	118	Timpani	Off	78	Tom 2-Lo	Off	78	Tom 2-Lo	Off
48	C3	85	Tom Brush Hi	Off	118	Timpani	Off	77	Tom 2-Hi	Off	77	Tom 2-Hi	Off
49	C#3	104	Crash Cymbal 1	Off	118	Timpani	Off	104	Crash Cymbal 1	Off	104	Crash Cymbal 1	Off
50	D3	85	Tom Brush Hi	Off	118	Timpani	Off	77	Tom 2-Hi	Off	77	Tom 2-Hi	Off
51	D#3	112	Ride-Edge 1	Off	118	Timpani	Off	113	Ride-Edge 2	Off	113	Ride-Edge 2	Off
52	E3	106	China Cymbal	Off	118	Timpani	Off	352	Hollo 1	Off	301	Dbk-Tky-Open	Off
53	F3	114	Ride-Jazz	Off	118	Timpani	Off	353	Hollo 2	Off	300	Dbk-Tky-Mute	Off
54	F#3	212	Tambourin-Acc2	Off	212	Tambourin-Acc2	Off	211	Tambourin-Acc1	Off	211	Tambourin-Acc1	Off
55	G3	107	Splash Cymbal	Off	107	Splash Cymbal	Off	345	Darbuka 2	Off	302	Dbk-Tky-Rim	Off
56	G#3	225	Cowbell	Off	225	Cowbell	Off	225	Cowbell	Off	225	Cowbell	Off
57	A3	104	Crash Cymbal 1	Off	104	Crash Cymbal 1	Off	350	Darbuka D3	Off	302	Dbk-Tky-Rim	Off
58	A#3	198	Vibraslap	Off	198	Vibraslap	Off	219	Cabasa-Up	Off	219	Cabasa-Up	Off
59	B3	113	Ride-Edge 2	Off	117	Orch Cymb	Off	339	Bandir Closed	Off	304	Douf-Dom-ak	Off
60	C4	171	BongoHi-Open	Off	171	BongoHi-Open	Off	353	Hollo 2	Off	307	Douf-Tek-ak 2	Off
61	C#4	168	BongoLo-Open	Off	168	BongoLo-Open	Off	168	BongoLo-Open	Off	168	BongoLo-Open	Off
62	D4	163	CongaHiMtSlap	Off	163	CongaHiMtSlap	Off	353	Hollo 2	Off	306	Douf-Tek-ak 1	Off
63	D#4	161	CongaHi-Open	Off	161	CongaHi-Open	Off	171	BongoHi-Open	Off	171	BongoHi-Open	Off
64	E4	158	CongaLo-Open	Off	158	CongaLo-Open	Off	305	Douf-rim-ak	Off	305	Douf-rim-ak	Off
65	F4	207	TimbaleHi-Rim2	Off	207	TimbaleHi-Rim2	Off	344	Darbuka 1 Closed	Off	328	Tabla-Dom	Off
66	F#4	202	TimbaleLo-Open	Off	202	TimbaleLo-Open	Off	348	Darbuka D1	4	348	Darbuka D1	4
67	G4	224	Agogo-Bell	Off	224	Agogo-Bell	Off	346	Darbuka 3	4	331	Tabla-Tak	4
68	G#4	224	Agogo-Bell	Off	224	Agogo-Bell	Off	349	Darbuka D2	Off	329	Tabla-Flam	Off
69	A4	219	Cabasa-Up	Off	219	Cabasa-Up	Off	341	Darbuka 1 Tek7	Off	330	Tabla-Rim	Off
70	A#4	182	MaracasPush	Off	182	MaracasPush	Off	341	Darbuka 1 Tek7	Off	189	Tabla-Na	Off
71	B4	234	SambaWhistle	2	234	SambaWhistle	2	343	Darbuka 1 Tek5	Off	191	Tabla-Tin	Off
72	C5	234	SambaWhistle	2	234	SambaWhistle	2	359	Tef 1	Off	318	Rek-dom-ak	Off
73	C#5	181	Guiro Short	3	181	Guiro Short	3	360	Tef 2	Off	321	Rik2	Off
74	D5	180	Guiro Long	3	180	Guiro Long	3	320	Rik1	Off	320	Rik1	Off
75	D#5	199	Claves	Off	199	Claves	Off	322	Rik3	Off	322	Rik3	Off
76	E5	200	Woodblock1	Off	200	Woodblock1	Off	360	Tef 2	Off	322	Rik3	Off
77	F5	200	Woodblock1	Off	200	Woodblock1	Off	359	Tef 1	Off	319	Rek-Jingle	Off
78	F#5	215	Cuica-Hi	4	215	Cuica-Hi	4	360	Tef 2	Off	360	Tef 2	Off
79	G5	216	Cuica-Lo	4	216	Cuica-Lo	4	318	Rek-dom-ak	Off	318	Rek-dom-ak	Off
80	G#5	214	Triangle-Mute	5	214	Triangle-Mute	5	359	Tef 1	Off	359	Tef 1	Off
81	A5	213	Triangle-Open	5	213	Triangle-Open	5	321	Rik2	Off	321	Rik2	Off
82	A#5	220	Cabasa-Down	Off	220	Cabasa-Down	Off	361	Tef 3	Off	322	Rik3	Off
83	B5	228	Sleigh Bell	Off	228	Sleigh Bell	Off	360	Tef 2	Off	319	Rek-Jingle	Off
84	C6	231	Marc Tree	Off	231	Marc Tree	Off	312	Bells Open	2	312	Bells Open	2
85	C#6	178	CastSingle	Off	178	CastSingle	Off	323	Sagat-HalfOpen	2	323	Sagat-HalfOpen	2
86	D6	203	TimbaleLo-Mute	6	203	TimbaleLo-Mute	6	324	Sagat-Close	2	324	Sagat-Close	2
87	D#6	202	TimbaleLo-Open	6	202	TimbaleLo-Open	6	351	Davul	Off	351	Davul	Off
88	E6	243	Stadium	Off	243	Stadium	Off	357	Ramazan DVL2	3	175	Djembe-Open	3

(continues on the next page)

(continued)

Note		120-0-41: Brush V.S.2		120-0-48: OrchestraK		120-0-116: Arabian Kit 1		120-0-117: Arabian Kit 2			
		Sample	Excl.	Sample	Excl.	Sample	Excl.	Sample	Excl.		
89	F6					356	Ramazan DVL1	3	175	Djembe-Open	3
90	F#6					358	Ramazan DVL3	3	301	Dbk-Tky-Open	3
91	G6					355	Kup 2	5	312	Bells Open	5
92	G#6					83	Tom Jazz Hi	5	323	Sagat-HalfOpen	5
93	A6					355	Kup 2	5	324	Sagat-Close	5
94	A#6					354	Kup 1	Off	351	Davul	Off
95	B6					2	BD-Dry 3	Off	5	BD-Jazz	Off
96	C7					354	Kup 1	Off	361	Tef 3	Off

		120-0-50: Bdrum & Sdrum			120-0-56: SFX Kit			120-0-64: Percus.Kit1			120-0-65: Latin P.Kit		
Note		Sample	Excl.	Sample	Excl.	Sample	Excl.	Sample	Excl.	Sample	Excl.		
0	C-1	257	Tribe										
1	C#-1	142	Zap1										
2	D-1	133	88-Tom										
3	D#-1	123	88-BD										
4	E-1	123	88-BD										
5	F-1	22	BD-Hip 4										
6	F#-1	23	BD-Pop Kick										
7	G-1	19	BD-Hip 1										
8	G#-1	18	BD-House 2										
9	A-1	28	BD-Pop 99										
10	A#-1	123	88-BD										
11	B-1	138	FM El.Tom										
12	C0	28	BD-Pop 99										
13	C#0	27	BD-Amb.Rocker										
14	D0	25	BD-Ambi Kick					181	Guiro Short	Off			
15	D#0	24	BD-Dance 99					209	Tambourin-Push	Off			
16	E0	23	BD-Pop Kick					210	Tambourin-Pull	Off			
17	F0	22	BD-Hip 4					211	Tambourin-Acc1	Off			
18	F#0	21	BD-Hip 3					211	Tambourin-Acc1	Off	240		
19	G0	19	BD-Hip 1					212	Tambourin-Acc2	Off	238		
20	G#0	18	BD-House 2					212	Tambourin-Acc2	Off	237		
21	A0	16	BD-Dance 3					209	Tambourin-Push	Off	241		
22	A#0	15	BD-Dance 2					212	Tambourin-Acc2	Off	214		
23	B0	13	BD-Squash					319	Rek-Jingle	Off	213		
24	C1	30	BD-Klanger					233	Flexatone	Off	233		
25	C#1	29	BD-Deep 88					230	Finger Cymbal	Off	230		
26	D1	29	BD-Deep 88		0	BD-Dry 1	Off	197	Tsuzumi	Off	136		
27	D#1	123	88-BD		296	Amp Noise	Off	172	BongoHi-Slap	Off	179		
28	E1	12	BD-Tight		235	Chinese Gong	Off	173	BongoHi-Stk1	Off	178		
29	F1	29	BD-Deep 88		153	DJ-BD Rub	Off	170	BongoLo-Stk	Off	121		
30	F#1	17	BD-House 1		148	DJ-Scratch3c	Off	211	Tambourin-Acc1	Off	121		
31	G1	14	BD-Dance 1		154	DJ-SD Rub	Off	224	Agogo-Bell	Off	99		
32	G#1	16	BD-Dance 3		145	DJ-Scratch2	Off	273	Wind	Off	236		
33	A1	20	BD-Hip 2		286	GtCutNois1	Off	224	Agogo-Bell	Off	197		
34	A#1	26	BD-Amb.Crackle		287	GtCutNois2	Off	174	BongoHi-Stk2	Off	197		
35	B1	29	BD-Deep 88		292	E.GtrPick1	Off	200	Woodblock1	Off	197		
36	C2	17	BD-House 1		294	Gtr Scratch1	Off	199	Claves	Off	116		
37	C#2	23	BD-Pop Kick		290	Dist.Slide1	Off	201	Woodblock2	Off	116		
38	D2	12	BD-Tight		291	Dist.Slide2	Off	225	Cowbell	Off	224		
39	D#2	1	BD-Dry 2		143	Zap2	Off	200	Woodblock1	Off	224		
40	E2	2	BD-Dry 3		258	GunShot 1	Off	179	CastDouble	Off	158		
41	F2	7	BD-Woofier		144	DJ-Scratch1	7	184	Baya-Open	Off	159		
42	F#2	3	BD-Normal		145	DJ-Scratch2	7	217	Shaker1	Off	164		
43	G2	0	BD-Dry 1		74	DrumStickHit	Off	186	Baya-Mute1	Off	165		
44	G#2	10	BD-Tubby		143	Zap2	Off	182	MaracasPush	Off	137		
45	A2	3	BD-Normal		249	Click	Off	184	Baya-Open	Off	161		
46	A#2	0	BD-Dry 1		224	Agogo-Bell	Off	219	Cabasa-Up	Off	214		
47	B2	3	BD-Normal		289	Fret Noise	Off	190	Tabla-Open	Off	213		
48	C3	6	BD-Pillow		286	GtCutNois1	Off	192	Tabla-Mute1	Off	159		
49	C#3	116	BD-Orch.		287	GtCutNois2	Off	198	Vibraslap	Off	162		
50	D3	11	BD-Gated		286	GtCutNois1	Off	189	Tabla-Na	Off	165		
51	D#3	10	BD-Tubby		121	FingerSnaps	Off	214	Triangle-Mute	3	211		
52	E3	8	BD-MondoKill		246	Laughing	Off	116	BD-Orch.	Off	161		
53	F3	10	BD-Tubby		245	Scream	Off	213	Triangle-Open	3	170		
54	F#3	9	BD-Terminator		256	Punch	Off	181	Guiro Short	Off	170		
55	G3	15	BD-Dance 2		255	Hear-Beat	Off	311	Jingle Bell	Off	173		
56	G#3	138	FM El.Tom		248	Footsteps 2	Off	180	Guiro Long	Off	202		
57	A3	133	88-Tom		247	Footsteps 1	Off	232	Marc Tree LP	Off	174		
58	A#3	29	BD-Deep 88		244	Applause	Off	231	Marc Tree	Off	202		
59	B3	16	BD-Dance 3		260	DoorCreak	Off	182	MaracasPush	Off	211		
60	C4	33	SD-Dry 3		261	DoorSlam	Off	122	Hand Claps	Off	208		
61	C#4	37	SD-Full Room		145	DJ-Scratch2	Off	127	88-Claps	Off	205		
62	D4	38	SD-Off Center		231	Marc Tree	Off	144	DJ-Scratch1	Off	208		
63	D#4	39	SD-Jazz Ring		262	Car Engine	Off	145	DJ-Scratch2	Off	205		
64	E4	31	SD-Dry 1		263	Car Stop	Off	150	DJ-HitRub	Off	207		
65	F4	41	SD-Paper		264	Car Pass	Off	234	SambaWhistle	Off	206		
66	F#4	65	SD-Vintage4		265	Car Crash	Off	234	SambaWhistle	Off	318		
67	G4	69	SD-Brasser		254	Crickets	Off	165	CongaHi-Slap2	Off	318		
68	G#4	47	SD-Yowie		266	Train	Off	166	CongaHeel	Off	318		
69	A4	49	SD-CrackerRoom		281	Noise White	Off	161	CongaHi-Open	Off	319		
70	A#4	46	SD-Big Rock		267	Helicopter	Off	158	CongaLo-Open	Off	227		
71	B4	59	SD-Hip 6		298	Swish Terra	Off	215	Cuica-Hi	Off	200		
72	C5	48	SD-Processed		258	GunShot 1	Off	216	Cuica-Lo	Off	201		
73	C#5	50	SD-Dance		269	MachineGun	Off	208	Timbale-Paila	Off	225		
74	D5	52	SD-Noise		270	Laser gun	Off	207	TimbaleHi-Rim2	Off	182		
75	D#5	62	SD-Vintage1		271	Explosion	Off	206	TimbaleHi-Rim1	Off	227		
76	E5	47	SD-Yowie		252	Dog	Off	202	TimbaleLo-Open	Off	219		
77	F5	70	SD-Chili		253	Gallop	Off	135	88-Clave	Off	217		
78	F#5	139	Real El.Tom		250	Bird 1	Off	136	88-Cowbell	Off	225		
79	G5	125	99-SD		259	Rainstick	Off	121	FingerSnaps	Off	220		
80	G#5	124	88-SD		272	Thunder	Off	196	Taiko Rim	Off	220		

(continues on the next page)

(continued)

Note		120-0-50: Bdrum & Sdrum			120-0-56: SFX Kit			120-0-64: Percus.Kit1			120-0-65: Latin P.Kit		
		Sample	Excl.	Sample	Excl.	Sample	Excl.	Sample	Excl.	Sample	Excl.		
81	A5	124	88-SD	Off	273	Wind	Off	195	Taiko Open	Off	220	Cabasa-Down	Off
82	A#5	125	99-SD	Off	281	Noise White	Off	143	Zap2	Off	334	Tambourin-Mute2	Off
83	B5	55	SD-Hip 2	Off	274	Stream	Off	119	SD-Orch.Roll	5	333	Tambourin-Open	5
84	C6	44	SD-BrushTap2	Off	275	Bubble	Off	120	SD-Orch.	5	332	Tambourin-Mute	5
85	C#6	43	SD-BrushTap1	Off	299	Cat	Off	117	Orch Cymb	6	332	Tambourin-Mute	6
86	D6	42	SD-BrushHit	Off	251	Bird 2	Off	117	Orch Cymb	6	333	Tambourin-Open	6
87	D#6	42	SD-BrushHit	Off	308	Growl	Off	336	Udu-f-open	Off	336	Udu-f-open	Off
88	E6	42	SD-BrushHit	Off	243	Stadium	Off	155	Orchestra Hit	Off	175	Djembe-Open	Off
89	F6	45	SD-BrushSwirl	Off	277	Telephone Ring	Off	155	Orchestra Hit	Off	183	MaracasPull	Off
90	F#6	45	SD-BrushSwirl	Off	276	ChurchBell	Off	155	Orchestra Hit	Off	183	MaracasPull	Off
91	G6	45	SD-BrushSwirl	Off	244	Applause	Off	155	Orchestra Hit	Off	215	Cuica-Hi	Off
92	G#6	31	SD-Dry 1	Off	244	Applause	Off	155	Orchestra Hit	Off	180	Guiro Long	3
93	A6	33	SD-Dry 3	Off	243	Stadium	Off	155	Orchestra Hit	Off	181	Guiro Short	3
94	A#6	46	SD-Big Rock	Off	281	Noise White	Off	155	Orchestra Hit	Off	181	Guiro Short	3
95	B6	68	SD-AmbiHop	Off	258	GunShot 1	Off	155	Orchestra Hit	Off	216	Cuica-Lo	Off
96	C7	54	SD-Hip 1	Off	266	Train	Off	155	Orchestra Hit	Off	199	Claves	Off
97	C#7	62	SD-Vintage1	Off				155	Orchestra Hit	Off	234	SambaWhistle	4
98	D7	56	SD-Hip 3	Off				155	Orchestra Hit	Off	234	SambaWhistle	4
99	D#7	67	SD-Vintage6	Off				155	Orchestra Hit	Off	323	Sagat-HalfOpen	5
100	E7	143	Zap2	Off				155	Orchestra Hit	Off	323	Sagat-HalfOpen	5
101	F7	58	SD-Hip 5	Off				155	Orchestra Hit	Off	324	Sagat-Close	5
102	F#7	71	SD-Whopper	Off				155	Orchestra Hit	Off	311	Jingle Bell	Off
103	G7	69	SD-Brasser	Off				155	Orchestra Hit	Off	231	Marc Tree	Off
104	G#7	62	SD-Vintage1	Off				155	Orchestra Hit	Off	231	Marc Tree	Off
105	A7	125	99-SD	Off				155	Orchestra Hit	Off	228	Sleigh Bell	2
106	A#7	71	SD-Whopper	Off				155	Orchestra Hit	Off	340	Bongo Roll	6
107	B7	71	SD-Whopper	Off				155	Orchestra Hit	Off	140	PR-House05	Off
108	C8	50	SD-Dance	Off				155	Orchestra Hit	Off	140	PR-House05	Off
109	C#8	50	SD-Dance	Off				290	Dist.Slide1	Off	17	BD-House 1	Off
110	D8	125	99-SD	Off				291	Dist.Slide2	Off	125	99-SD	Off
111	D#8	125	99-SD	Off				286	GtCutNois1	Off	29	BD-Deep 88	Off
112	E8	60	SD-Ringy	Off				287	GtCutNois2	Off	124	88-SD	Off
113	F8							292	E.GtrPick1	Off	39	SD-Jazz Ring	Off
114	F#8							293	E.GtrPick2	Off	48	SD-Processed	Off
115	G8							294	Gtr Scratch1	Off	0	BD-Dry 1	Off
115	G#8							295	Gtr Scratch2	Off	27	BD-Amb.Rocker	Off
117	A8							289	Fret Noise	Off	40	SD-Amb.Piccolo	Off
118	A#8							288	Power Chord	Off	86	HH1 Closed1	Off
119	B8							288	Power Chord	Off	6	BD-Pillow	Off
120	C9							296	Amp Noise	Off	73	SideStickAmb	Off

		120-0-66: TRI-Per.KIT			120-0-67: i30 Perc.Kit		
Note		Sample		Excl.	Sample		Excl.
0	C-1						
1	C#-1						
2	D-1						
3	D#-1						
4	E-1						
5	F-1						
6	F#-1						
7	G-1						
8	G#-1						
9	A-1						
10	A#-1						
11	B-1						
12	C0	322	Rik3	Off			
13	C#0	321	Rik2	Off			
14	D0	320	Rik1	Off			
15	D#0	319	Rek-Jingle	Off			
16	E0	318	Rek-dom-ak	Off			
17	F0	303	Djembe-Bass	Off			
18	F#0	195	Taiko Open	Off			
19	G0	317	Pand-Pattern4	Off			
20	G#0	316	Pand-Pattern3	Off			
21	A0	315	Pand-Pattern2	Off	209	Tambourin-Push	Off
22	A#0	314	Pand-Pattern1	Off	212	Tambourin-Acc2	Off
23	B0	313	Pand-Open	Off	189	Tabla-Na	Off
24	C1	196 → 195	Taiko Rim → Taiko Open	Off	233	Flexatone	Off
25	C#1	197	Tsuzumi → Tsuzumi	Off	230	Finger Cymbal	Off
26	D1	175 → 175	Djembe-Open → Djembe-Open	Off	197	Tsuzumi	Off
27	D#1	177 → 176	Djembe-Slap → Djembe-Mute	Off	172	BongoHi-Slap	Off
28	E1	185 → 184	Baya-Ghe → Baya-Open	Off	173	BongoHi-Stk1	Off
29	F1	186 → 187	Baya-Mute1 → Baya-Mute2	Off	170	BongoLo-Stk	Off
30	F#1	188 → 303	Baya-Mute5 → Djembe-Bass	Off	211	Tambourin-Acc1	Off
31	G1	190 → 190	Tabla-Open → Tabla-Open	Off	224	Agogo-Bell	Off
32	G#1	191 → 194	Tabla-Tin → Tabla-Mute3	Off	273	Wind	Off
33	A1	192 → 193	Tabla-Mute1 → Tabla-Mute2	Off	224	Agogo-Bell	Off
34	A#1	189 → 193	Tabla-Na → Tabla-Mute2	6	174	BongoHi-Stk2	Off
35	B1	192	Tabla-Mute1	Off	200	Woodblock1	Off
36	C2	116	BD-Orch.	Off	199	Claves	Off
37	C#2	257	Tribe	Off	201	Woodblock2	Off
38	D2	121	FingerSnaps	Off	225	Cowbell	Off
39	D#2	122	Hand Claps	Off	200	Woodblock1	Off
40	E2	214	Triangle-Mute	1	179	CastDouble	Off
41	F2	213	Triangle-Open	1	184	Baya-Open	Off
42	F#2	179	CastDouble	Off	217	Shaker1	Off
43	G2	178	CastSingle	Off	186	Baya-Mute1	Off
44	G#2	179	CastDouble	Off	182	MaracasPush	Off
45	A2	180	Guero Long	2	184	Baya-Open	Off
46	A#2	181	Guero Short	2	219	Cabasa-Up	Off
47	B2	180	Guero Long	2	190	Tabla-Open	Off
48	C3	198	Vibraslap	Off	192	Tabla-Mute1	Off
49	C#3	199	Claves	Off	198	Vibraslap	Off
50	D3	135	88-Clave	Off	189	Tabla-Na	Off
51	D#3	216 → 216	Cuica-Lo → Cuica-Lo	3	214	Triangle-Mute	3
52	E3	215 → 215	Cuica-Hi → Cuica-Hi	Off	116	BD-Orch.	Off
53	F3	202	TimbaleLo-Open	Off	213	Triangle-Open	3
54	F#3	200	Woodblock1	Off	181	Guero Short	Off
55	G3	204	TimbaleLo-Rim	Off	311	Jingle Bell	Off
56	G#3	200	Woodblock1	Off	180	Guero Long	Off
57	A3	203	TimbaleLo-Mute	Off	232	Marc Tree LP	Off
58	A#3	200	Woodblock1	Off	231	Marc Tree	Off
59	B3	205	TimbaleHi-Edge	Off	182	MaracasPush	Off
60	C4	207	TimbaleHi-Rim2	Off	122	Hand Claps	Off
61	C#4	226	ChachaBell	Off	127	88-Claps	Off
62	D4	206	TimbaleHi-Rim1	Off	144	DJ-Scratch1	Off
63	D#4	227	Mambo Bell	Off	145	DJ-Scratch2	Off
64	E4	208 → 208	Timbale-Paila → Timbale-Paila	Off	150	DJ-HitRub	Off
65	F4	168	BongoLo-Open	Off	234	SambaWhistle	Off
66	F#4	225	Cowbell	Off	234	SambaWhistle	Off
67	G4	169	BongoLo-Slap	Off	165	CongaHi-Slap2	Off
68	G#4	225	Cowbell	Off	166	CongaHeel	Off
69	A4	171	BongoHi-Open	Off	161	CongaHi-Open	Off
70	A#4	174	BongoHi-Stk2	Off	158	CongaLo-Open	Off
71	B4	172 → 172	BongoHi-Slap → BongoHi-Slap	Off	215	Cuica-Hi	Off
72	C5	158 → 158	CongaLo-Open → CongaLo-Open	Off	216	Cuica-Lo	Off
73	C#5	160	CongaLoSlap	Off	208	Timbale-Paila	Off
74	D5	159	CongaLoMtSlp	Off	207	TimbaleHi-Rim2	Off
75	D#5	163	CongaHiMtSlap	Off	206	TimbaleHi-Rim1	Off
76	E5	161 → 161	CongaHi-Open → CongaHi-Open	Off	202	TimbaleLo-Open	Off
77	F5	162	CongaHiMute	Off	135	88-Clave	Off
78	F#5	166	CongaHeel	Off	136	88-Cowbell	Off
79	G5	164	CongaHi-Slap1	Off	121	FingerSnaps	Off
80	G#5	167	CongaToe	Off	196	Taiko Rim	Off
81	A5	165	CongaHi-Slap2	Off	195	Taiko Open	Off
82	A#5	224	Agogo-Bell	Off	143	Zap2	Off

(continues on the next page)

(continued)

Note		120-0-66: TRI-Per.KIT			120-0-67: i30 Perc.Kit		
		Sample	Excl.	Sample	Excl.		
83	B5	224	Agogo-Bell	Off	119	SD-Orch.Roll	5
84	C6	183 →182	MaracasPull →MaracasPush	Off	120	SD-Orch.	5
85	C#6	217 →217	Shaker1 →Shaker1	Off	117	Orch Cymb	6
86	D6	218 →218	Shaker2 →Shaker2	Off	117	Orch Cymb	6
87	D#6	221 →220	Cabasa-Tap →Cabasa-Down	Off	336	Udu-f-open	Off
88	E6	219 →221	Cabasa-Up →Cabasa-Tap	Off	155	Orchestra Hit	Off
89	F6	222 →223	Caxixi-Hard →Caxixi-Soft	Off	155	Orchestra Hit	Off
90	F#6	209	Tambourin-Push	Off	155	Orchestra Hit	Off
91	G6	211 →211	Tambourin-Acc1 →Tambourin-Acc1	Off	155	Orchestra Hit	Off
92	G#6	210	Tambourin-Pull	Off	155	Orchestra Hit	Off
93	A6	212	Tambourin-Acc2	Off	155	Orchestra Hit	Off
94	A#6	228 →228	Sleigh Bell →Sleigh Bell	Off	155	Orchestra Hit	Off
95	B6	234	SambaWhistle	4	155	Orchestra Hit	Off
96	C7	234	SambaWhistle	4	155	Orchestra Hit	Off
97	C#7	229	RapSleighBell	Off	155	Orchestra Hit	Off
98	D7	234	SambaWhistle	4	155	Orchestra Hit	Off
99	D#7	231	Marc Tree	5	155	Orchestra Hit	Off
100	E7	234	SambaWhistle	4	155	Orchestra Hit	Off
101	F7	312	Bells Open	5	155	Orchestra Hit	Off
102	F#7	259	Rainstick	Off	155	Orchestra Hit	Off
103	G7	235	Chinese Gong	Off	155	Orchestra Hit	Off
104	G#7	250	Bird 1	Off	155	Orchestra Hit	Off
105	A7	250	Bird 1	Off	155	Orchestra Hit	Off
106	A#7	251	Bird 2	Off	155	Orchestra Hit	Off
107	B7	279	Cricket Spectrum	Off	155	Orchestra Hit	Off
108	C8	231	Marc Tree	Off	155	Orchestra Hit	Off
109	C#8				290	Dist.Slide1	Off
110	D8				214	Triangle-Mute	3
111	D#8				213	Triangle-Open	3
112	E8				233	Flexatone	Off
113	F8				312	Bells Open	Off
114	F#8				223	Caxixi-Soft	Off
115	G8				179	CastDouble	Off
115	G#8				179	CastDouble	Off
117	A8				121	FingerSnaps	Off
118	A#8				121	FingerSnaps	Off
119	B8				236	Metal Hit	Off
120	C9				236	Metal Hit	Off

PERFORMANCES

All Performances are user-editable. Use the following table as a model for your own Performance lists.

Note: You can remotely select Performances on the Pa50, by sending it Bank Select MSB (CC#0), Bank Select LSB (CC#32) and Program Change messages on the Control channel (see page 127).

#	CC#0	CC#32	PC	Bank: 1	CC#0	CC#32	PC	Bank: 2	CC#0	CC#32	PC	Bank: 3	CC#0	CC#32	PC	Bank: 4
1	1	0	0		1	1	0		1	2	0		1	3	0	
2			1				1				1				1	
3			2				2				2				2	
4			3				3				3				3	
5			4				4				4				4	
6			5				5				5				5	
7			6				6				6				6	
8			7				7				7				7	
	CC#0	CC#32	PC	Bank: 5	CC#0	CC#32	PC	Bank: 6	CC#0	CC#32	PC	Bank: 7	CC#0	CC#32	PC	Bank: 8
1	1	4	0		1	5	0		1	6	0		1	7	0	
2			1				1				1				1	
3			2				2				2				2	
4			3				3				3				3	
5			4				4				4				4	
6			5				5				5				5	
7			6				6				6				6	
8			7				7				7				7	
	CC#0	CC#32	PC	Bank: 9	CC#0	CC#32	PC	Bank: 10	CC#0	CC#32	PC	Bank: 11	CC#0	CC#32	PC	Bank: 12
1	1	8	0		1	9	0		1	10	0		1	11	0	
2			1				1				1				1	
3			2				2				2				2	
4			3				3				3				3	
5			4				4				4				4	
6			5				5				5				5	
7			6				6				6				6	
8			7				7				7				7	
	CC#0	CC#32	PC	Bank: 13	CC#0	CC#32	PC	Bank: 14	CC#0	CC#32	PC	Bank: 15	CC#0	CC#32	PC	Bank: 16
1	1	12	0		1	13	0		1	14	0		1	15	0	
2			1				1				1				1	
3			2				2				2				2	
4			3				3				3				3	
5			4				4				4				4	
6			5				5				5				5	
7			6				6				6				6	
8			7				7				7				7	
	CC#0	CC#32	PC	Bank: 17	CC#0	CC#32	PC	Bank: 18	CC#0	CC#32	PC	Bank: 19	CC#0	CC#32	PC	Bank: 20
1	1	16	0		1	17	0		1	18	0		1	19	0	
2			1				1				1				1	
3			2				2				2				2	
4			3				3				3				3	
5			4				4				4				4	
6			5				5				5				5	
7			6				6				6				6	
8			7				7				7				7	

MIDI SETUP

		DEFAULT	Master Kbd	Sequencer1	Sequencer 2	Accordion 1	Accordion 2	Accordion 3	Ext. Seq
MIDI IN Channel	1	S1_Tr 1	Global	S1_Tr 1	S2_Tr 1	Global	Upp1	Upp1	S1_Tr 1
	2	S1_Tr 2	-	S1_Tr 2	S2_Tr 2	Lower	Lower	Lower	S1_Tr 2
	3	S1_Tr 3	-	S1_Tr 3	S2_Tr 3	Bass	-	Bass	S1_Tr 3
	4	S1_Tr 4	-	S1_Tr 4	S2_Tr 4	-	Upp2	Upp2	S1_Tr 4
	5	S1_Tr 5	-	S1_Tr 5	S2_Tr 5	-	Upp3	Upp3	S1_Tr 5
	6	S1_Tr 6	-	S1_Tr 6	S2_Tr 6	-	-	-	S1_Tr 6
	7	S1_Tr 7	-	S1_Tr 7	S2_Tr 7	-	-	-	S1_Tr 7
	8	S1_Tr 8	-	S1_Tr 8	S2_Tr 8	-	-	-	S1_Tr 8
	9	S1_Tr 9	-	S1_Tr 9	S2_Tr 9	-	Bass	-	S1_Tr 9
	10	S1_Tr 10	-	S1_Tr 10	S2_Tr 10	Drum	Drum	Drum	S1_Tr 10
	11	S1_Tr 11	-	S1_Tr 11	S2_Tr 11	Perc	Perc	Perc	S1_Tr 11
	12	S1_Tr 12	-	S1_Tr 12	S2_Tr 12	Acc1	Acc1	Acc1	S1_Tr 12
	13	S1_Tr 13	-	S1_Tr 13	S2_Tr 13	Acc2	Acc2	Acc2	S1_Tr 13
	14	S1_Tr 14	-	S1_Tr 14	S2_Tr 14	Acc3	Acc3	Acc3	S1_Tr 14
	15	S1_Tr 15	-	S1_Tr 15	S2_Tr 15	Acc4	Acc4	Acc4	S1_Tr 15
	16	S1_Tr 16	-	S1_Tr 16	S2_Tr 16	Acc5	Acc5	Acc5	S1_Tr 16
MIDI OUT Channel	1	1 Upp1	Upp1	S1_Tr 1	S2_Tr 1	Upp1	S1_Tr 1	S2_Tr 1	Upp. 1
	2	Upp2	Upp2	S1_Tr 2	S2_Tr 2	Upp2	S1_Tr 2	S2_Tr 2	-
	3	Upp3	Upp3	S1_Tr 3	S2_Tr 3	Upp3	S1_Tr 3	S2_Tr 3	-
	4	Lower	Lower	S1_Tr 4	S2_Tr 4	Lower	S1_Tr 4	S2_Tr 4	-
	5	-	-	S1_Tr 5	S2_Tr 5	-	S1_Tr 5	S2_Tr 5	-
	6	-	-	S1_Tr 6	S2_Tr 6	-	S1_Tr 6	S2_Tr 6	-
	7	-	-	S1_Tr 7	S2_Tr 7	-	S1_Tr 7	S2_Tr 7	-
	8	-	-	S1_Tr 8	S2_Tr 8	-	S1_Tr 8	S2_Tr 8	-
	9	Bass	Bass	S1_Tr 9	S2_Tr 9	Bass	S1_Tr 9	S2_Tr 9	-
	10	Drum	Drum	S1_Tr 10	S2_Tr 10	Drum	S1_Tr 10	S2_Tr 10	-
	11	Perc	Perc	S1_Tr 11	S2_Tr 11	Perc	S1_Tr 11	S2_Tr 11	-
	12	Acc1	Acc1	S1_Tr 12	S2_Tr 12	Acc1	S1_Tr 12	S2_Tr 12	-
	13	Acc2	Acc2	S1_Tr 13	S2_Tr 13	Acc2	S1_Tr 13	S2_Tr 13	-
	14	Acc3	Acc3	S1_Tr 14	S2_Tr 14	Acc3	S1_Tr 14	S2_Tr 14	-
	15	Acc4	Acc4	S1_Tr 15	S2_Tr 15	Acc4	S1_Tr 15	S2_Tr 15	-
	16	Acc5	Acc5	S1_Tr 16	S2_Tr 16	Acc5	S1_Tr 16	S2_Tr 16	-
MIDI IN Velocity		Normal	Normal	Normal	Normal	110	110	Normal	Normal
Chord 1 Chann.		Off	1	Off	Off	2	2	2	Off
Chord 2 Chann.		Off	Off	Off	Off	3	3	3	Off

18. EFFECTS

Pa50 is equipped with four powerful Effect Processors (A, B, C, D). You can send them the internal tracks.

DIAGRAMS

The following instructions show the signal path diagram for each of the effect types. The signal coming from the tracks (**Send**) is mono. Before entering an effect processor, it is split in two “wires” (**Left** and **Right**), and processed in stereo. The signal is then output in stereo from the effect processor, and sent to the Mix output (Left&Right, the headphones or the internal speakers).

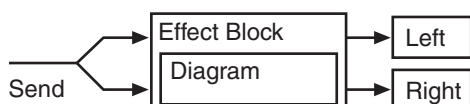

DYNAMIC MODULATION SOURCES

When the **D_{mod}** symbol is encountered, a Dynamic Modulation can be applied to the corresponding parameter. The following table shows the available modulation sources.

Modulation source	Note
Off	No modulation
Gate1	
Gate1+Dmpr	
Gate2	
Gate2+Dmpr	
Note Nr	Note Number
Velocity	Note Velocity
ATouch	After Touch
JS X	Joystick Left/Right
JS+Y: CC#01	Joystick Forward
JS-Y: CC#02	Joystick Backward
MIDI(CC#04)	
MIDI(CC#12)	
MIDI(CC#13)	
MIDI(CC#16)	
MIDI(CC#18)	
MIDI(CC#17)	
MIDI(CC#19)	

Modulation source	Note
MIDI(CC#20)	
MIDI(CC#21)	
Damper: #64	
Prta.SW: #65	Portamento Switch
Sostenu: #66	Sostenuto Pedal
MIDI(CC#80)	
MIDI(CC#81)	
MIDI(CC#82)	
MIDI(CC#83)	
Tempo	

FILTER/DYNAMIC

Filter and dynamics control effects

000: No Effect

Select this option when you do not use any effects. When this option is selected, the effect is muted.

001: Amp Simulat (Stereo Amp Simulation)

This effect simulates the frequency response characteristics of guitar amplifiers. It is also effective for organ and drum sounds.

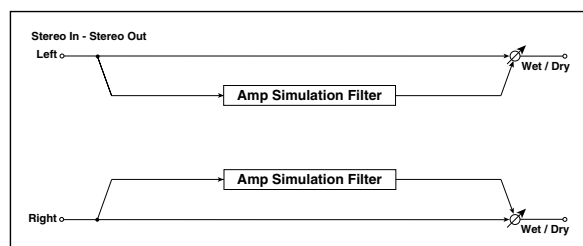

a	Amplifier Type Selects the type of guitar amplifier	SS, EL84, 6L6
b	Wet/Dry Sets the balance between the effect and dry sounds	Dry, 1:99...99:1, Wet D_{mod}
	Src Selects the modulation source of the effect balance	Off...Tempo
	Amt Sets the modulation amount of the effect balance	-100...+100

002: Compressor (Stereo Compressor)

This effect compresses the input signal to regulate the level and give a “punchy” effect. It is useful for guitar, piano, and drum sounds. This is a stereo compressor. You can link left and right channels, or use each channel separately.

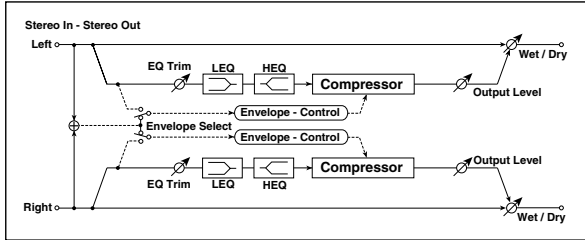

a	Envelope Select Determines whether the left and right channels are linked or used separately	L/R Mix, L/R Individually	
b	Sensitivity Sets the sensitivity		1...100
c	Attack Sets the attack level		1...100
d	EQ Trim Sets the EQ input level		0...100
e	Pre LEQ Gain [dB] Sets the gain of Low EQ		-15.0...+15.0dB
	Pre HEQ Gain [dB] Sets the gain of High EQ		-15.0...+15.0dB
f	Output Level Sets the output level of the compressor		0...100
	Src Selects the modulation source for the compressor output level	Off...Tempo	
	Amt Sets the modulation amount of the compressor output level		-100...+100
g	Wet/Dry Table , “Sets the balance between the effect and dry sounds,” on page 175	Dry, 1:99...99:1, Wet	
	Src Table , “Selects the modulation source of the effect balance,” on page 175	Off...Tempo	
	Amt Table , “Sets the modulation amount of the effect balance,” on page 175		-100...+100

a: Envelope Select

This parameter selects whether the left and right channels are linked to control both signals simultaneously, or whether each channel is controlled independently.

b: Sensitivity, f: Output Level

The “Sensitivity” parameter sets the sensitivity of the compressor. If this parameter is set to a higher value, lower level sounds will be boosted. With a higher Sensitivity, the overall volume level is higher. To adjust the final volume level, use the “Output Level” parameter.

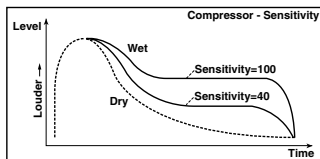

c: Attack

This parameter controls the attack level.

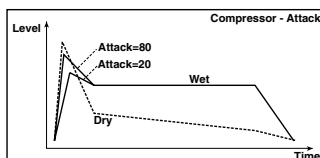

003: Limiter (Stereo Limiter)

The Limiter regulates the input signal level. It is similar to the Compressor, except that the Limiter compresses only signals that exceed the specified level to lower unnecessary peak signals. The Limiter applies a peaking-type EQ to the trigger signal (which controls the degree of the Limiter effect), allowing you to set any band width to be covered. This effect is a stereo limiter. You can link left and right channels, or use each channel individually.

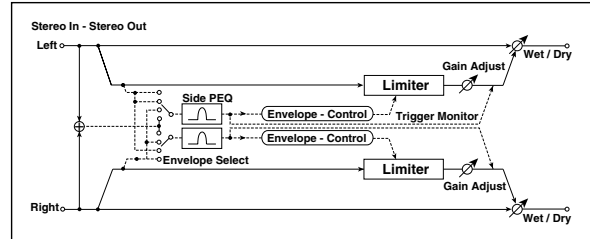

a	Envelope Select Selects from linking both channels, controlling only from left channel, only from the right channel, or controlling each channel individually	L/R Mix, L Only, R Only, L/R Individually	
b	Ratio Sets the signal compression ratio		1.0:1...50.0:1, Inf:1
c	Threshold [dB] Sets the level above which the compressor is applied		-40...0dB
d	Attack Sets the attack time		1...100
	Release Sets the release time		1...100
e	Gain Adjust [dB] Sets the output gain		-Inf, -38...+24dB
	Src Selects the modulation source for the output gain	Off...Tempo	
	Amt Sets the modulation amount of the output gain		-63...+63
f	Side PEQ Insert Toggles between on/off of the trigger signal's EQ		Off, On
	Trigger Monitor Switches between effect output monitor and trigger signal monitor	Off, On	
g	Side PEQ Cutoff [Hz] Sets the EQ center frequency for the trigger signal		20...12.00kHz
	Q Sets the EQ bandwidth for the trigger signal		0.5...10.0
	Gain [dB] Sets the EQ gain for the trigger signal		-18.0...+18.0dB
h	Wet/Dry Table , “Sets the balance between the effect and dry sounds,” on page 175	Dry, 1:99...99:1, Wet	
	Src Table , “Selects the modulation source of the effect balance,” on page 175	Off...Tempo	
	Amt Table , “Sets the modulation amount of the effect balance,” on page 175		-100...+100

a: Envelope Select

When L/R Mix is selected for this parameter, the left and right channels are linked to control the Limiter using the mixed signal. If L Only (or R Only) is selected, the left and right channels are linked, and the Limiter is controlled via only the left (or right) channel.

With L/R individually, the left and right channels control the Limiter individually.

b: Ratio, c: Threshold [dB], e: Gain Adjust [dB]

This parameter sets the signal compression “Ratio”. Compression is applied only when the signal level exceeds the “Threshold” value.

Adjust the output level using the "Gain Adjust" parameter, since compression causes the entire level to be reduced.

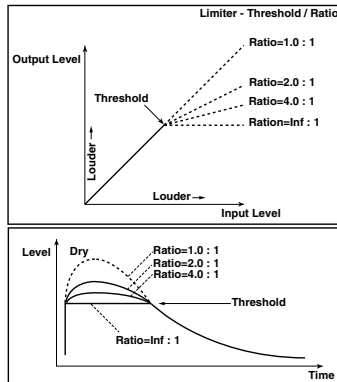

d: Attack, d: Release

These parameters set the attack time and release time. A higher attack time will cause the compression to be applied more slowly.

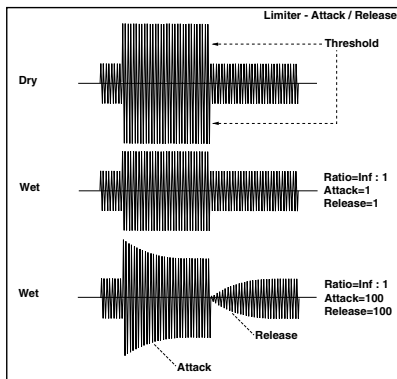

f: Side PEQ Insert, g: Side PEQ Cutoff [Hz], g: Q, g: Gain [dB]

These parameters are used to set the EQ applied to the trigger signal.

The Limiter determines whether the compression is applied or not, based on the post-EQ trigger signal. Setting the equalizer allows you to set the Limiter to respond to any frequency band.

f: Trigger Monitor

Setting this parameter **On** will cause the trigger signal to be output, instead of the effect sound. Use this parameter to check the trigger signal with EQ applied.

Usually, set this to **Off**.

004: MBandLimit (Multiband Limiter)

This effect applies the Limiter to the low range, mid range, and high range of the input signal. You can control dynamics for each range to adjust the sound pressure of the low range, mid range, and high range in a different way from the EQ.

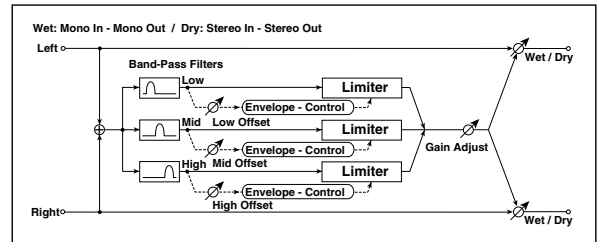

a	Ratio Sets the signal compression ratio	1.0:1...50.0:1, Inf:1 Fx:003
b	Threshold [dB] Sets the level above which the compressor is applied	-40...0dB Fx:003
c	Attack Sets the attack time	1...100 Fx:003
d	Release Sets the release time	1...100 Fx:003
e	Low Offset [dB] Gain of the low-range trigger signal	-40...0dB Fx:003
f	Mid Offset [dB] Gain of the mid-range trigger signal	-40...0dB Fx:003
g	High Offset [dB] Gain of the high-range trigger signal	-40...0dB Fx:003
h	Gain Adjust [dB] Sets the output gain	-Inf, -38...+24dB Fx:003, D ^{mod}
	Src Selects the modulation source for the output gain	Off...Tempo
	Amt Sets the modulation amount of the output gain	-63...+63
i	Wet/Dry Dry, 1:99...99:1, Wet Table, "Sets the balance between the effect and dry sounds," on page 175 D ^{mod}	
	Src Table, "Selects the modulation source of the effect balance," on page 175	Off...Tempo
	Amt Table, "Sets the modulation amount of the effect balance," on page 175	-100...+100

e: Low Offset [dB], f: Mid Offset [dB], g: High Offset [dB]

These parameters set the gain of the trigger signal.

For example, if you do not want to apply compression to the high range, reduce the "High Offset" value down below the "Threshold" level. In this way, the high range limiter will not respond, and compression will not be applied.

005: Gate
(Stereo Gate)

This effect mutes the input signal if its level is lower than the specified level. It also reverses the on and off operation of the gate, and uses Note On and Off messages to turn the gate on and off.

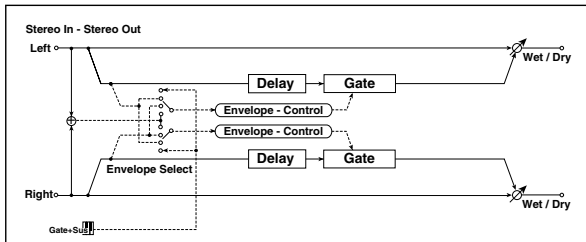

a	Envelope Select	D-mod, L/R Mix, L Only, R Only Selects from Control via the modulation source, mixing the left and right signals, Only left, and Only right	E^{mod} , D^{mod}
	Src	Off...Gate2+Dmpr Selects the modulation source that controls the gate when Envelope Select = D-mod	
b	Polarity	Switches between non-reversed and reversed Gate on/off	$+$, $-$ E^{mod}
c	Threshold	Sets the level to which the Gate is applied	0...100 E^{mod}
	Attack	Sets the attack time	1...100 E^{mod}
d	Release	Sets the release time	1...100 E^{mod}
	Delay Time [msec]	Sets the delay time of the gate input	0...100msec E^{mod}
f	Wet/Dry	Dry, 1:99...99:1, Wet Table, "Sets the balance between the effect and dry sounds," on page 175	D^{mod}
	Src	Off...Tempo Table, "Selects the modulation source of the effect balance," on page 175	
	Amt	Table, "Sets the modulation amount of the effect balance," on page 175	-100...+100

a: Envelope Select, a: Src

The "Envelope Select" parameter selects whether the gate on/off is triggered by the level of the input signal, or controlled directly by the modulation source. The Src parameter specifies the modulation source, selected from Off to Gate2+Dpmr.

With "Envelope Select" = L/R Mix, the left and right channel signal mixture will trigger the gate on/off. When L Only or R Only is selected, the gate is controlled by either of the channel signals.

b: Polarity

This parameter reverses the Gate on/off operation. With a negative value, the gate is closed when the input signal level exceeds the Threshold. The gate operation controlled by the modulation source is also reversed.

c: Threshold, d: Attack, d: Release

This parameter sets the signal level below which Gate is applied when "Envelope Select" is set to L/R Mix, L Only, or R Only.

The Attack and Release parameters set the Gate attack time and release time.

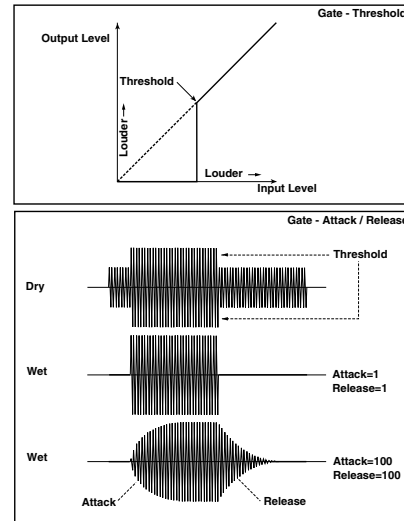

e: Delay Time

This parameter sets the delay time of the Gate input. If the sound has a very fast attack, increase the delay time so that the signal will be input after the Gate is opened. This will preserve the attack part of the sound.

006: OD/HGainWah
(Overdrive/Hi-Gain Wah)

This distortion effect utilizes an Overdrive mode and a Hi-Gain mode. Controlling the wah effect, the 3-band EQ, and the amp simulation will allow you to create versatile distortion sounds. This effect is suitable for guitar and organ sounds.

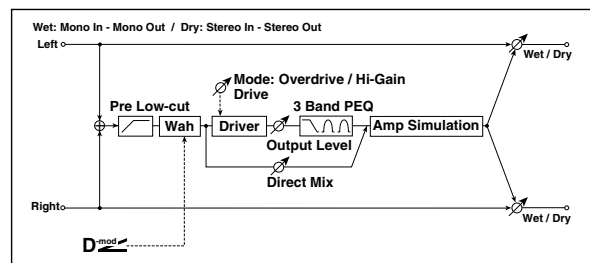

a	Wah	Switches Wah on/off	Off, On E^{mod} , D^{mod}
	Src	Off...Tempo Selects the modulation source that switches the Wah on and off	
	Sw	Toggle, Moment Selects the switching mode for the modulation source that switches the Wah on and off	E^{mod}
b	Wah Sweep Range	Sets the range of Wah	-10...+10 E^{mod} , D^{mod}
	Wah Sweep Src	Off...Tempo Selects the modulation source that controls the Wah	E^{mod}
c	Drive Mode	Overdrive, Hi-Gain Switches between overdrive and hi-gain distortion	
	Drive	Sets the degree of distortion	1...100 E^{mod}
d	Pre Low-cut	Sets the low range cut amount of the distortion input	0...10 E^{mod}
	Output Level	Sets the output level	0...50 E^{mod} , D^{mod}
e	Src	Off...Tempo Selects the modulation source for the output level	
	Amt	Sets the modulation amount of the output level	-50...+50

f	Low Cutoff [Hz] Sets the center frequency for Low EQ (shelving type)	20...1.0kHz
	Gain [dB] Table , "Sets the gain of Low EQ," on page 176	-18...+18dB
g	Mid1 Cutoff [Hz] Sets the center frequency for Mid/High EQ 1 (peaking type)	300...10.00kHz
	Q Sets the band width of Mid/High EQ 1	0.5...10.0 F _{3dB}
	Gain [dB] Sets the gain of Mid/High EQ 1	-18...+18dB
h	Mid2 Cutoff [Hz] Sets the center frequency for Mid/High EQ 2 (peaking type)	500...20.00kHz
	Q Sets the band width of Mid/High EQ 2	0.5...10.0 F _{3dB}
	Gain [dB] Sets the gain of Mid/High EQ 2	-18...+18dB
i	Direct Mix Sets the amount of the dry sound mixed to the distortion	0...50
	Speaker Simulation Switches the speaker simulation on/off	Off, On
j	Wet/Dry Table , "Sets the balance between the effect and dry sounds," on page 175 D ^{mod}	Dry, 1:99...99:1, Wet
	Src Table , "Selects the modulation source of the effect balance," on page 175	Off...Tempo
	Amt Table , "Sets the modulation amount of the effect balance," on page 175	-100...+100

a: Wah

The Wah parameter switches the wah effect on/off.

a: Sw

This parameter sets how the wah effect is switched on and off via the modulation source.

When "Sw" = **Moment**, the wah effect is usually turned off. It is turned on only when you press the pedal or operate the joystick.

MIDI When a value for the modulation source is less than 64, "off" speed is selected, and when the value is 64 or higher, "on" is selected.

When "Sw" = **Toggle**, the wah effect is switched between on and off each time you press the pedal or operate the joystick.

MIDI The switch will be turned on/off each time the value of the modulation source exceeds 64.

b: Wah Sweep Range, b: Wah Sweep Src

This parameter sets the sweep range of the wah center frequency. A negative value will reverse the direction of sweep. The wah center frequency can be controlled by the modulation source specified in the "Wah Sweep Src" parameter.

d: Drive, e: Output Level

The degree of distortion is determined by the level of input signal and the setting of "Drive". Raising the "Drive" setting will cause the entire volume level to increase. Use the "Output Level" parameter to adjust the volume level. The "Output Level" parameter uses the signal level input to the 3-Band EQ. If clipping occurs at the 3-Band EQ, adjust the "Output Level" parameter.

d: Pre Low-cut

Cutting the signal in the low range before it is input to the Distortion will create a sharp distortion.

g: Q, h: Q

These parameters set the bandwidth of each equalizer. The higher the value, the narrower the band becomes.

007: Param.4B Eq

(Stereo Parametric 4-Band EQ)

This is a stereo 4-band parametric equalizer. You can select peaking type or shelving type for Band 1 and 4. The gain of Band 2 can be controlled by dynamic modulation.

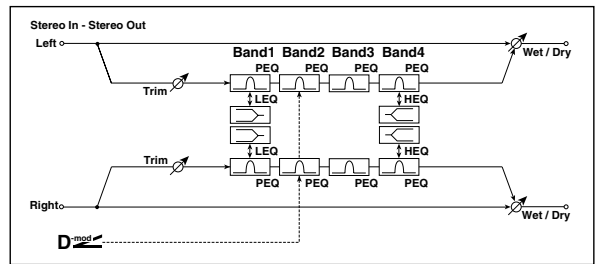

a	Trim Sets the input level	0...100
b	Band1 Type Selects the type of Band 1	Peaking, Shelving-Low F _{3dB}
c	Band4 Type Selects the type of Band 4	Peaking, Shelving-High F _{3dB}
d	Band2 Dynamic Gain Src Selects the modulation source of the Band 2 gain	Off...Tempo F _{3dB}
	Amt [dB] Sets the modulation amount of Band 2 gain	-18...+18dB F _{3dB}
e	Band1 Cutoff [Hz] Sets the center frequency of Band 1	20...1.00kHz
	Q Sets the bandwidth of Band 1	0.5...10.0 F _{3dB} Fx:006
	Gain [dB] Sets the gain of Band 1	-18.0...+18.0dB
f	Band2 Cutoff [Hz] Sets the center frequency of Band 2	50...10.00kHz
	Q Sets the bandwidth of Band 2	0.5...10.0 F _{3dB} Fx:006
	Gain [dB] Sets the gain of Band 2	-18.0...+18.0dB F _{3dB} , D ^{mod}
g	Band3 Cutoff [Hz] Sets the center frequency of Band 3	300...10.00kHz
	Q Sets the bandwidth of Band 3	0.5...10.0 F _{3dB} Fx:006
	Gain [dB] Sets the gain of Band 3	-18.0...+18.0dB
h	Band4 Cutoff [Hz] Sets the center frequency of Band 4	500...20.00kHz
	Q Sets the bandwidth of Band 4	0.5...10.0 F _{3dB} Fx:006
	Gain [dB] Sets the gain of Band 4	-18.0...+18.0dB
i	Wet/Dry Table , "Sets the balance between the effect and dry sounds," on page 175 D ^{mod}	Dry, 1:99...99:1, Wet
	Src Table , "Selects the modulation source of the effect balance," on page 175	Off...Tempo
	Amt Table , "Sets the modulation amount of the effect balance," on page 175	-100...+100

b: Band1 Type, c: Band4 Type

Selects a filter type for Band 1 and 4.

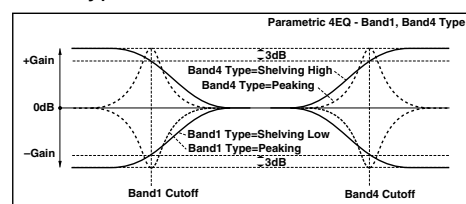

d: Band2 Dynamic Gain Src, d: Amt [dB], f: Gain [dB]

You can control the gain of Band 2 using the modulation source.

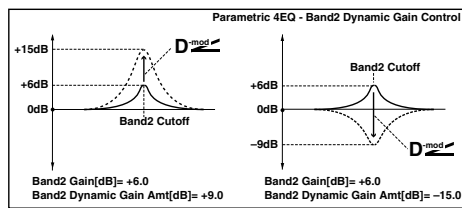

008: Graph.7B Eq

(Stereo Graphic 7 Band EQ)

This is a stereo 7-band graphic equalizer. The bar graph of the gain setting for each band gives you a clear, visual idea of frequency responses. You can select a center frequency setting for each band from twelve types, according to the sound.

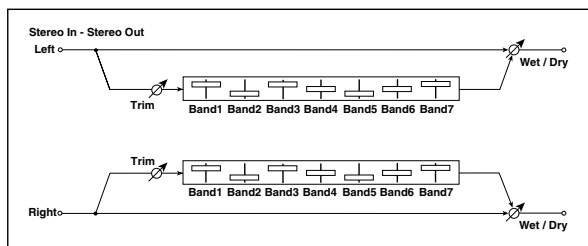

a	Type1:Wide 1, 2:Wide 2, 3:Wide 3, 4:Half Wide 1, 5:Half Wide 2, 6:Half Wide 3, 7:Low, 8:Wide Low, 9:Mid, 10:Wide Mid, 11:High, 12:Wide High Selects a combination of center frequencies for each band	
b	Trim Sets the input level	0...100
c	Band1 [dB] Sets the gain of Band 1	-18.0...+18.0dB
d	Band2 [dB] Sets the gain of Band 2	-18.0...+18.0dB
e	Band3 [dB] Sets the gain of Band 3	-18.0...+18.0dB
f	Band4 [dB] Sets the gain of Band 4	-18.0...+18.0dB
g	Band5 [dB] Sets the gain of Band 5	-18.0...+18.0dB
h	Band6 [dB] Sets the gain of Band 6	-18.0...+18.0dB
i	Band7 [dB] Sets the gain of Band 7	-18.0...+18.0dB
j	Wet/Dry Table , "Sets the balance between the effect and dry sounds," on page 175 D-mod	Dry, 1:99...99:1, Wet
	Src Table , "Selects the modulation source of the effect balance," on page 175	Off...Tempo
	Amt Table , "Sets the modulation amount of the effect balance," on page 175	-100...+100

a: Type

This parameter selects a combination of center frequencies for each band. Each center frequency is shown on the right edge of the LCD.

You can configure a 21-Band Graphic EQ ranging from 80Hz to 18kHz if you route three Graphic 7Band EQ effects in series, with a setting of **7:Low**, **9:Mid**, and **11:High** for each EQ.

**009: Wah/AutoWah
(Stereo Wah/Auto Wah)**

This stereo wah effect allows you to create sounds from vintage wah pedal simulation to auto-wah simulation, and much broader range settings.

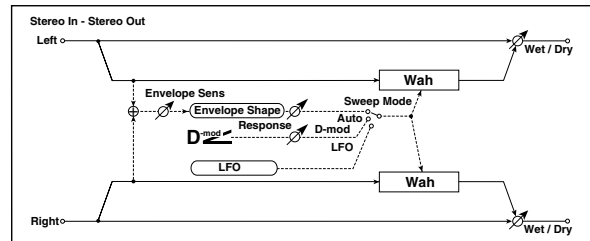

a	Frequency Bottom Sets the lower limit of the wah center frequency	0...100 E3
	Frequency Top Sets the upper limit of the wah center frequency	0...100 E3
b	Sweep Mode Selects the control from auto-wah, modulation source, and LFO	Auto, D-mod, LFO E3, D-mod
	Src Selects the modulation source for the wah when Sweep Mode=D-mod	Off...Tempo
c	Response Sets the response speed when Sweep Mode = Auto or D-mod	0...100
	Envelope Sens (Envelope Sensitivity) Sets the sensitivity of auto-wah	0...100 E3
d	Envelope Shape Sets the sweep curve of auto-wah	-100...+100 E3
	LFO Frequency [Hz] Sets the LFO speed	0.02...20.00Hz E3, D-mod
e	Src Selects the modulation source of LFO speed	Off...Tempo
	Amt Sets the modulation amount of LFO speed	-20.00...+20.00Hz
	BPM/MIDI Sync Switches between using the frequency of the LFO speed and using the tempo and notes	Off, On E3, Sync
f	BPM Selects MIDI Clock and assigns tempo	MIDI, 40...240 E3
	Base Note Selects the type of notes that specify the LFO speed	♩, ♪, ♫, ♮, ♯, ♭, ♮, ♯, ♭, ♮ E3
	Times Sets the number of notes that specify the LFO speed	x1...x16 E3
g	Resonance Sets the resonance amount	0...100
	Low Pass Filter Switches the Wah Low Pass Filter on and off	Off, On
9	Wet/Dry Table , "Sets the balance between the effect and dry sounds," on page 175 D-mod	Dry, 1:99...99:1, Wet
	Src Table , "Selects the modulation source of the effect balance," on page 175	Off...Tempo
	Amt Table , "Sets the modulation amount of the effect balance," on page 175	-100...+100

a: Frequency Bottom, a: Frequency Top

The sweep width and direction of the wah filter are determined by the "Frequency Top" and "Frequency Bottom" settings.

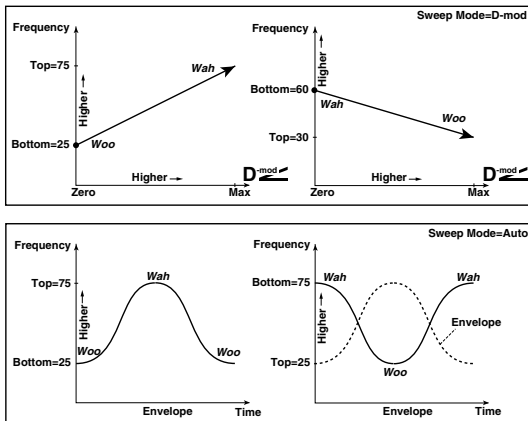

b: Sweep Mode

This parameter changes the wah control mode. Setting "Sweep Mode" to **Auto** will select an auto-wah that sweeps according to envelope changes in the input signal level. Auto-wah is frequently used for funk guitar parts and clav sounds.

When "Sweep Mode" is set to **D-mod**, you can control the filter directly via the modulation source in the same way as a wah pedal.

When "Sweep Mode" is set to **LFO**, the effect uses LFO to sweep in cycle.

c: Envelope Sens (Envelope Sensitivity)

This parameter sets the sensitivity of auto-wah. Increase the value if the input signal is too low to sweep. Reduce the value if the input signal is so high that the filter is stopped temporarily.

c: Envelope Shape

This parameter determines the sweep curve for auto-wah.

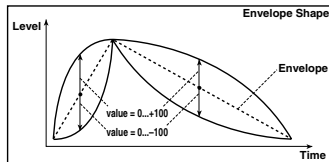

d: LFO Frequency [Hz], e: BPM/MIDI Sync

When "BPM/MIDI Sync"=Off, the LFO speed uses the LFO Frequency parameter setting. When "BPM/MIDI Sync"=On, the LFO speed follows the "BPM", "Base Note", and "Times" settings.

e: BPM, e: Base Note, e: Times

One cycle of LFO sweep is obtained by multiplying the length of a note (♪...♪) (selected for "Base Note", in relation to the tempo specified in ("BPM", or the MIDI Clock tempo if "BPM" is set to **MIDI**) by the number specified in the Times parameter.

010: Random Filt

(Stereo Random Filter)

This stereo band pass filter uses a step-shape waveform and random LFO for modulation. You can create a special effect from filter oscillation.

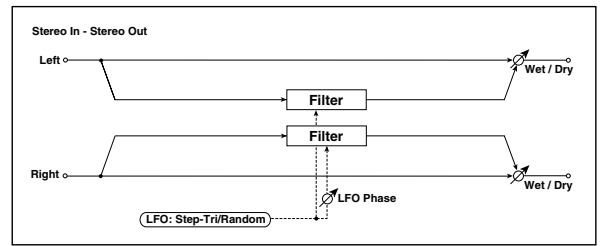

a	LFO Waveform Selects LFO Waveform	Step-Tri, Random ES
b	LFO Phase [degree] Sets the LFO phase difference between the left and right	-180...+180 ES
c	LFO Frequency [Hz] Sets the LFO speed	0.02...20.00Hz ES, D-mod
	Src Selects the modulation source used for both LFO speed and step speed	Off...Tempo
d	Amt Sets the modulation amount of LFO speed	-20.00...+20.00Hz
	LFO Step Freq (Frequency) [Hz] Sets the LFO step speed (speed that changes in steps)	0.05...50.00Hz ES, D-mod
e	Amt Sets the modulation amount of LFO step speed	-50.00...+50.00Hz
	BPM/MIDI Sync Switches between using the frequency of the LFO speed and using the tempo and notes	Off, On ES Fx:009, Sync
f	BPM Selects MIDI Clock and assigns tempo	MIDI, 40...240 ES Fx:009, ES
	Base Note Selects the type of notes that specify the LFO speed	♪, ♪, ♫, ♬, ♮, ♯, ♭, ♮, ♯, ♭, ♮ ES Fx:009
	Times Sets the number of notes that specify the LFO speed	x1...x16 ES Fx:009
g	Step Base Note Selects the type of notes to specify the LFO step speed	♪, ♪, ♫, ♬, ♮, ♯, ♭, ♮, ♯, ♭, ♮ ES, Sync
	Times Sets the number of notes to specify the LFO step speed	x1...x32 ES
h	Manual Sets the filter center frequency	0...100
i	Depth Sets the modulation depth of filter center frequency	0...100
	Src Selects the modulation source of filter modulation	Off...Tempo
j	Amt Sets the modulation amount of filter modulation	-100...+100
	Resonance Sets the resonance amount	0...100
k	Wet/Dry Sets the balance between the effect and dry sounds, on page 175	-Wet...-1:99, Dry, 1:99...Wet ES, D-mod
	Src Table, "Selects the modulation source of the effect balance," on page 175	Off...Tempo
	Amt Table, "Sets the modulation amount of the effect balance," on page 175	-100...+100

a: LFO Waveform, c: LFO Frequency [Hz],

d: LFO Step Freq (Frequency) [Hz]

When "LFO Waveform" is set to **Step-Tri**, LFO is a step-shape, triangle waveform. The "LFO Frequency" parameter sets the original triangle waveform speed. Changing the "LFO Step Freq" parameter enables you to adjust the width of the steps.

When "LFO Waveform" is set to **Random**, the "LFO Step Freq" parameter uses a random LFO cycle.

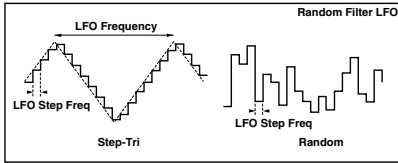

b: LFO Phase [degree]

Offsetting the left and right phases alters how modulation is applied to the left and right channels, creating a swelling affect.

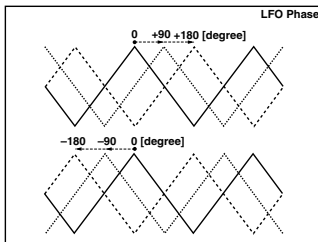

e: BPM, f: Step Base Note, f: Times

The width of an LFO step, or a cycle of random LFO, is obtained by multiplying the length of a note (♩...) (selected for "Step Base Note", in relation to the tempo specified in "BPM," or the MIDI Clock tempo if "BPM" is set to MIDI) by the number specified in the "Times" parameter.

j: Wet/Dry

The effect sound's phase will be reversed when you set this parameter in the range of values from **-Wet to -1:99**.

**011: Excit/Enhanc
(Stereo Exciter/Enhancer)**

This effect is a combination of the Exciter, which adds a punch to the sound and the Enhancer, which adds spread and presence.

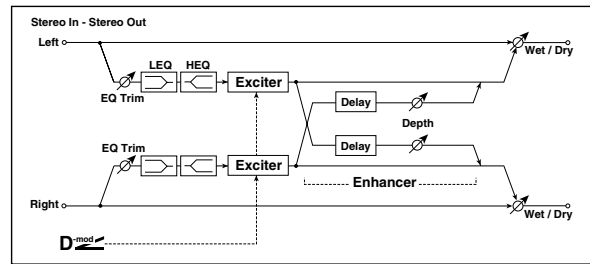

a	Exciter Blend Sets the intensity (depth) of the Exciter effect	-100...+100 ES ³ , D ^{mod}
	Src Selects the modulation source of the Exciter intensity	Off...Tempo
	Amt Sets the modulation amount of the Exciter intensity	-100...+100
b	Emphatic Point Sets the frequency to be emphasized	0...70 ES ³ , D ^{mod}
	Src Selects the modulation source of the frequency to be emphasized	Off...Tempo
	Amt Sets the amount of modulation of the frequency to be emphasized	-70...+70
c	Enhancer Dly L (Enhancer Delay L) [msec] Sets the delay time for the Enhancer left channel	0.0...50.0msec ES ³
d	Enhancer Dly R (Enhancer Delay R) [msec] Sets the delay time for the Enhancer right channel	0.0...50.0msec ES ³
e	Enhancer Depth Sets the determines to what degree the Enhancer effect is applied	0...100 D ^{mod}
	Src Selects the modulation source of the Enhancer width	Off...Tempo
	Amt Sets the modulation amount of the Enhancer width	-100...+100
f	EQ Trim Sets the 2-band EQ input level	0...100
g	Pre LEQ Gain [dB] Table, "Sets the gain of Low EQ," on page 176	-15.0...+15.0dB
	Pre HEQ Gain [dB] Table, "Sets the gain of High EQ," on page 176	-15.0...+15.0dB
h	Wet/Dry Dry, 1:99...99:1, Wet Table, "Sets the balance between the effect and dry sounds," on page 175 D ^{mod}	
	Src Table, "Selects the modulation source of the effect balance," on page 175	Off...Tempo
	Amt Table, "Sets the modulation amount of the effect balance," on page 175	-100...+100

a: Exciter Blend

This parameter sets the depth (intensity) of the Exciter effect. Positive values give a frequency pattern (to be emphasized) different from negative values.

b: Emphatic Point

This parameter sets the frequency to be emphasized. Higher values will emphasize lower frequencies.

c: Enhancer Dly L [msec], d: Enhancer Dly R [msec]

These parameters set the delay time for the Enhancer left and right channel. Specifying a slightly different delay time for the left and right channel will add a stereo image, depth, and width to the sound.

012: Sub Oscill (Stereo Sub Oscillator)

This effect adds very low frequencies to the input signal. It is very useful when simulating a roaring drum sound or emphasizing powerful low range. This effect is different from the equalizer in that you can add very low range harmonics. You can also adjust the oscillator frequency to match a particular note number, for use as an octaver.

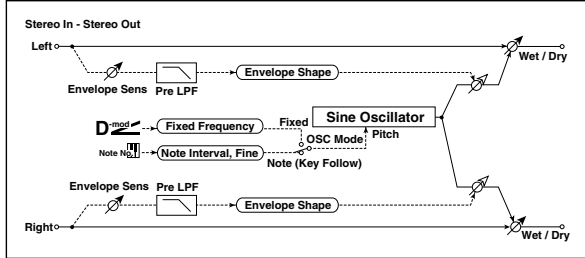

a	OSC Mode	Note (Key Follow), Fixed
	Determines whether the oscillator frequency follows the note number or whether it is fixed	
b	Note Interval	-48...0
	Sets the pitch difference from the note number when OSC Mode=Note (Key Follow)	
	Note Fine	-100...+100
	Fine adjustment of the oscillator frequency	
c	Fixed Frequency [Hz]	10.0...80.0Hz
	Sets the oscillator frequency when OSC Mode=Fixed	
	Src	Off...Tempo
	Selects the modulation source for the oscillator frequency when OSC Mode=Fixed	
	Amt	-80...+80Hz
	Sets the oscillator frequency modulation amount when OSC Mode=Fixed	
d	Envelope Pre LPF	1...100
	Sets the upper limit of the frequency range for which very low harmonics are added	
e	Envelope Sens (Envelope Sensitivity)	0...100
	Sets the sensitivity with which very low harmonics are added	
	Envelope Shape	-100...+100
	Sets the oscillator's volume envelope curve	
f	Wet/Dry	Dry, 1:99...99:1, Wet
	Table, "Sets the balance between the effect and dry sounds," on page 175	
	Src	Off...Tempo
	Table, "Selects the modulation source of the effect balance," on page 175	
	Amt	-100...+100
	Table, "Sets the modulation amount of the effect balance," on page 175	

a: OSC Mode, b: Note Interval, b: Note Fine
The "OSC Mode" parameter selects the oscillator operation mode. When **Note (Key Follow)** is selected, the oscillator's frequency is determined based on the note number, allowing you to use it as an octaver. The "Note Interval" parameter sets the pitch offset from the original note number by semitone steps. The "Note Fine" parameter allows you to fine-tune in steps of cents.

d: Envelope Pre LPF
This parameter sets the upper limit of the frequency range to which very low harmonics are added. Adjust this parameter if you do not want to add lower harmonics to the higher range.

013: Talking Mod (Talking Modulator)

This effect adds an unusual character, like a human voice, to the input signal. Modulating the tone via dynamic modulation, you can create an interesting effect that sounds as if the guitar or synthesizer is talking.

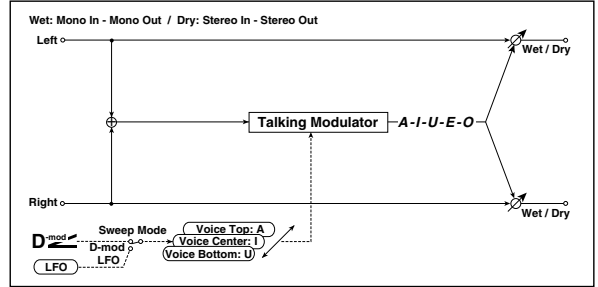

a	Sweep Mode	D-mod, LFO
	Switches between modulation source control and LFO control	
b	Manual Voice Control	Bottom, 1...49, Center, 51...99, Top
	Voice pattern control	
	Src	Off...Tempo
	Selects the modulation source that controls the voice pattern	
c	Voice Top	A, I, U, E, O
	Selects a vowel sound at the top end of control	
d	Voice Center	A, I, U, E, O
	Selects a vowel sound in the center of control	
e	Voice Bottom	A, I, U, E, O
	Selects a vowel sound at the bottom end of control	
f	LFO Frequency [Hz]	0.02...20.00Hz
	Sets the LFO speed	
	Src	Off...Tempo
	Selects the modulation source of LFO speed	
	Amt	-20.00...+20.00Hz
	Sets the modulation amount of LFO speed	
g	BPM/MIDI Sync	Off, On
	Switches between using the frequency of the LFO speed and using the tempo and notes	
	BPM	MIDI, 40...240
	Selects MIDI Clock and assigns tempo	
	Base Note	Fx:009
	Selects the type of notes that specify the LFO speed	
	Times	x1...x16
	Sets the number of notes that specify the LFO speed	
h	Formant Shift	-100...+100
	Sets the frequency to which the effect is applied	
	Resonance	0...100
	Sets the Level of resonance of the voice pattern	
i	Wet/Dry	Dry, 1:99...99:1, Wet
	Table, "Sets the balance between the effect and dry sounds," on page 175	
	Src	Off...Tempo
	Table, "Selects the modulation source of the effect balance," on page 175	
	Amt	-100...+100
	Table, "Sets the modulation amount of the effect balance," on page 175	

c: Voice Top, d: Voice Center, e: Voice Bottom
These parameters assign vowels to the top, center, and bottom position of the controller. E.g.: When "Voice Top"=A, "Voice Center"=I, and "Voice Bottom"=U:
If "Sweep Mode" is set to **D-mod** and **Ribbon** is selected as the modulation source, moving your finger from the right to left of the ribbon controller will change the sound from "a" to "i," then "u."

If Sweep Mode is set to LFO, the sound will change cyclically from "a" to "i," "u," "i," then "a."

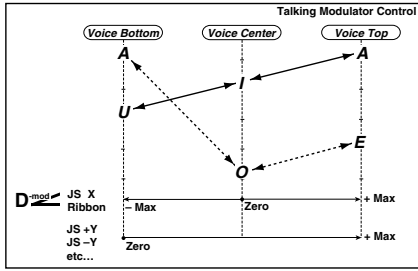

h: Formant Shift

This parameter adjusts the frequency level to which the effect is applied. If you wish to apply the effect to a higher-range sound, set this parameter to a higher value; to apply the effect to a lower-range sound, set this to a lower value.

h: Resonance

This parameter sets the intensity of resonance for the voice pattern. A larger value will add more character to the sound.

014: Decimator (Stereo Decimator)

This effect creates a rough sound like a cheap sampler by lowering the sampling frequency and data bit length. You can also simulate noise unique to a sampler (aliasing).

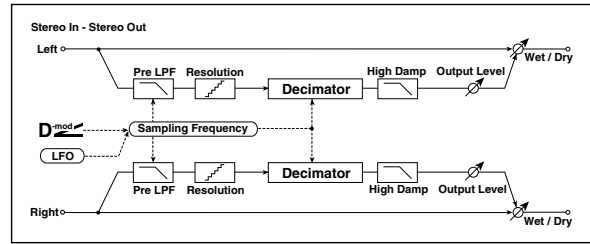

a	Pre LPF Selects whether the harmonic noise caused by a decrease in sampling frequency is generated or not	Off, On ES [®]
	High Damp [%] Sets the ratio of cut of the high range	0...100%
b	Sampling Freq (Sampling Frequency) [Hz] Sets the sampling frequency	1.00k...48.00kHz D-mod
	Src Selects the modulation source of the sampling frequency	Off...Tempo
	Amt Sets the modulation amount of the sampling frequency	-48.00k...+48.00kHz
c	LFO Frequency [Hz] Sets the LFO speed	0.02...20.00Hz D-mod
	Src Selects the modulation source of LFO speed	Off...Tempo
	Amt Sets the modulation amount of LFO speed	-20.00...+20.00Hz
d	Depth Sets the depth of the sampling frequency LFO modulation	0...100 D-mod
	Src Selects the LFO modulation source of the sampling frequency	Off...Tempo
	Amt Sets the LFO modulation amount of the sampling frequency	-100...+100
e	Resolution Sets the data bit length	4...24 ES [®]
	Output Level Sets the output level	0...100 ES [®] , D-mod
	Src Selects the modulation source for the output level	Off...Tempo
f	Amt Sets the modulation amount of the output level	-100...+100
	Wet/Dry Dry, 1:99...99:1, Wet Table, "Sets the balance between the effect and dry sounds," on page 175 D-mod	
	Src Table, "Selects the modulation source of the effect balance," on page 175	Off...Tempo
g	Amt Table, "Sets the modulation amount of the effect balance," on page 175	-100...+100

a: Pre LPF

If a sampler with a very low sampling frequency receives very high-pitched sound that could not be heard during playback, it could generate pitch noise that is unrelated to the original sound. Set "Pre LPF" to ON to prevent this noise from being generated.

If you set the "Sampling Freq" to about 3kHz and set "Pre LPF" to OFF, you can create a sound like a ring modulator.

e: Resolution, f: Output Level

If you set a smaller value for the "Resolution" parameter, the sound may be distorted. The volume level may also be changed. Use "Output Level" to adjust the level.

017: Harm.Chorus
(Stereo Harmonic Chorus)

This effect applies chorus only to higher frequencies. This can be used to apply a chorus effect to a bass sound without making the sound thinner. You can also use this chorus block with feedback as a flanger.

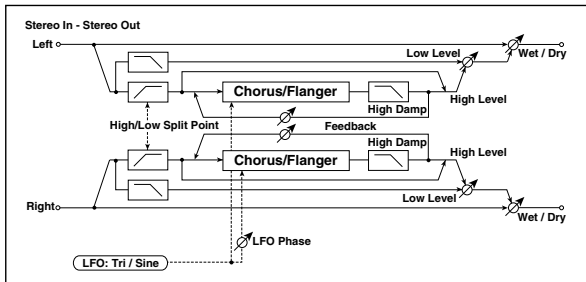

a	LFO Waveform Selects LFO Waveform	Triangle, Sine
b	LFO Phase [degree] Sets the LFO phase difference between the left and right	-180...+180 Fx:010
c	LFO Frequency [Hz] Sets the LFO speed	0.02...20.00Hz Fx:009, D ^{mod}
	Src Selects the modulation source of LFO speed	Off...Tempo
d	Amt Sets the modulation amount of LFO speed	-20.00...+20.00Hz
	BPM/MIDI Sync Switches between using the frequency of the LFO speed and using the tempo and notes	Off, On Fx:009, Sync
	BPM Selects MIDI Clock and assigns tempo	MIDI, 40...240 Fx:009
	Base Note Selects the type of notes that specify the LFO speed	Fx:009
e	Times Sets the number of notes that specify the LFO speed	x1...x16 Fx:009
	Pre Delay [msec] Sets the delay time from the original sound	0.0...50.0msec
f	Depth Sets the depth of LFO modulation	0...100 D ^{mod}
	Src Selects the modulation source of the LFO modulation depth	Off...Tempo
g	Amt Sets the modulation amount of the LFO modulation depth	-100...+100
	High/Low Split Point Sets the frequency split point between the low and high range	1...100 Fx:
h	Feedback Sets the feed back amount of the chorus block	-100...+100 Fx:
	High Damp [%] Sets the high range damping amount of the chorus block	0...100%
i	Low Level Sets the low range output level	0...100
	High Level Sets the high range (chorus) output level	0...100
j	Wet/Dry Table, "Sets the balance between the effect and dry sounds," on page 175	Dry, 1:99...99:1, Wet D ^{mod}
	Src Table, "Selects the modulation source of the effect balance," on page 175	Off...Tempo
	Amt Table, "Sets the modulation amount of the effect balance," on page 175	-100...+100

g: High/Low Split Point

This parameter sets the frequency that splits the high and low range. Only the high range will be sent to the chorus block.

h: Feedback

Sets the feedback amount of the chorus block. Increasing the feedback will allow you to use the effect as a flanger.

018: MTap Ch/Dly
(Multitap Chorus/Delay)

This effect has four chorus blocks with a different LFO phase. You can create a complex stereo image by setting each block's delay time, depth, output level, and pan individually. You can also fix some of the chorus blocks to combine the chorus and delay effects.

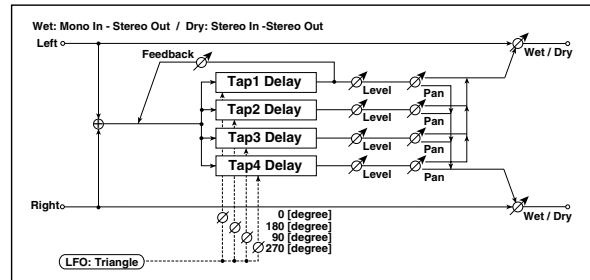

a	LFO Frequency [Hz] Sets the LFO speed	0.02...13.00Hz
b	Tap1(000) [msec] Sets the Tap1 (LFO phase=0 degrees) delay time	0...570msec
	Depth Sets the Tap1 chorus depth	0...30
	Level Sets the Tap1 output level	0...30
c	Pan Sets the Tap1 stereo image	L6...L1, C, R1...R6
	Tap2(180) [msec] Sets the Tap2 (LFO phase=180 degrees) delay time	0...570msec
	Depth Sets the Tap2 chorus depth	0...30
d	Level Sets the Tap2 output level	0...30
	Pan Sets the Tap2 stereo image	L6...L1, C, R1...R6
	Tap3(090) [msec] Sets the Tap3 (LFO phase=90 degrees) delay time	0...570msec
e	Depth Sets the Tap3 chorus depth	0...30
	Level Sets the Tap3 output level	0...30
	Pan Sets the Tap3 stereo image	L6...L1, C, R1...R6
f	Tap4(270) [msec] Sets the Tap4 (LFO phase=270 degrees) delay time	0...570msec
	Depth Sets the Tap4 chorus depth	0...30
	Level Sets the Tap4 output level	0...30
g	Pan Sets the Tap4 stereo image	L6...L1, C, R1...R6
	Tap1 Feedback Sets the Tap1 feedback amount	-100...+100 D ^{mod}
	Src Selects the modulation source of Tap1 feedback amount and effect balance	Off...Tempo
h	Amt Sets the Tap1 feedback amount and modulation amount	-100...+100
	Wet/Dry Table, "Sets the balance between the effect and dry sounds," on page 175	Dry, 1:99...99:1, Wet D ^{mod}
i	Amt Table, "Sets the modulation amount of the effect balance," on page 175	-100...+100

019: Ensemble

This Ensemble effect has three chorus blocks that use LFO to create subtle shimmering, and gives three dimensional depth and spread to the sound, because the signal is output from the left, right, and center.

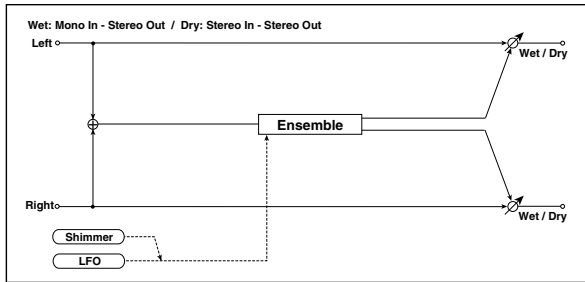

a	Speed Sets the LFO speed	1...100 D-mod
	Src Selects the modulation source of LFO speed	Off...Tempo
	Amt Sets the modulation amount of LFO speed	-100...+100
b	Depth Sets the depth of LFO modulation	0...100 D-mod
	Src Selects the modulation source of the LFO modulation depth	Off...Tempo
	Amt Sets the modulation amount of the LFO modulation depth	-100...+100
c	Shimmer Sets the amount of shimmering of the LFO waveform	0...100 E3
	Wet/Dry Dry, 1:99...99:1, Wet Table, "Sets the balance between the effect and dry sounds," on page 175 D-mod	
d	Src Table, "Selects the modulation source of the effect balance," on page 175	Off...Tempo
	Amt Table, "Sets the modulation amount of the effect balance," on page 175	-100...+100

c: Shimmer

This parameter sets the amount of shimmering of the LFO waveform. Increasing this value adds more shimmering, making the chorus effect more complex and richer.

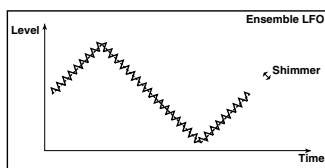

020: Flanger (Stereo Flanger)

This effect gives a significant swell and movement of pitch to the sound. It is more effective when applied to a sound with a lot of harmonics. This is a stereo flanger. You can add spread to the sound by offsetting the phase of the left and right LFOs from each other.

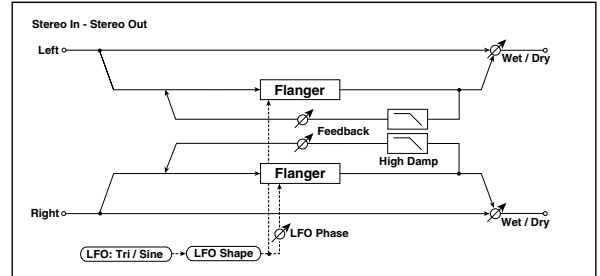

a	Delay Time [msec] Sets the delay time from the original sound	0.0...50.0msec
	LFO Waveform Selects LFO Waveform	Triangle, Sine
b	LFO Shape Determines how much the LFO waveform is changed	-100...+100 E3
	LFO Phase [degree] Sets the LFO phase difference between the left and right	-180...+180 E3 Fx:010
c	LFO Frequency [Hz] Sets the LFO speed	0.02...20.00Hz E3 Fx:009, D-mod
	Src Selects the modulation source of LFO speed	Off...Tempo
	Amt Sets the modulation amount of LFO speed	-20.00...+20.00Hz
d	BPM/MIDI Sync Switches between using the frequency of the LFO speed and using the tempo and notes	Off, On E3 Fx:009, Sync
	BPM Selects MIDI Clock and assigns tempo	MIDI, 40...240 E3 Fx:009
	Base Note Selects the type of notes that specify the LFO speed	E3 Fx:009
	Times Sets the number of notes that specify the LFO speed	x1...x16 E3 Fx:009
	Depth Sets the depth of LFO modulation	0...100
e	Feedback Sets the feedback amount	-100...+100 E3
	High Damp [%] Sets the feedback damping amount in the high range	0...100% E3
f	Wet/Dry -Wet...-1:99, Dry, 1:99...Wet Table, "Sets the balance between the effect and dry sounds," on page 175 E3 Fx:010, D-mod	
	Src Table, "Selects the modulation source of the effect balance," on page 175	Off...Tempo
	Amt Table, "Sets the modulation amount of the effect balance," on page 175	-100...+100

b: LFO Shape

Changing the LFO waveform shape controls the peak sweep of flanging effects.

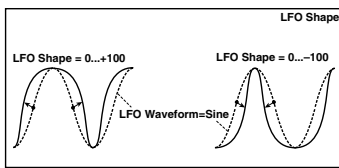

g: Feedback, h: Wet/Dry

The peak shape of the positive and negative “Feedback” value is different. The harmonics will be emphasized when the effect sound is mixed with the dry sound if you set a positive value for both “Feedback” and “Wet/Dry”, and if you set a negative value for both “Feedback” and “Wet/Dry”.

g: High Damp [%]

This parameter sets the amount of damping of the feedback in the high range. Increasing the value will cut high-range harmonics.

021: RandomFlang

(Stereo Random Flanger)

The stereo effect uses a step-shape waveform and random LFO for modulation, creating a unique flanging effect.

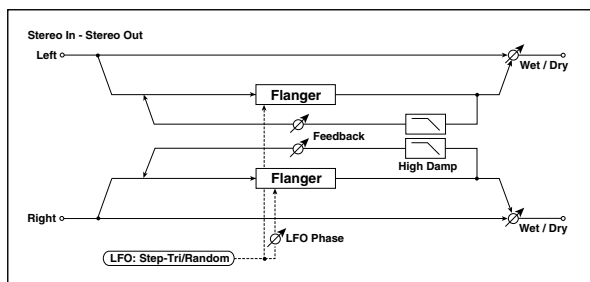

a	Delay Time [msec] Sets the delay time from the original sound	0.0...50.0msec
b	LFO Waveform Selects LFO Waveform	Step-Tri, Random Fx:010
c	LFO Phase [degree] Sets the LFO phase difference between the left and right	-180...+180 Fx:010
d	LFO Frequency [Hz] Sets the LFO speed	0.02...20.00Hz Fx:010, D-mod
	Src Selects the modulation source used for both LFO speed and step speed	Off...Tempo
	Amt Sets the modulation amount of LFO speed	-20.00...+20.00Hz
e	LFO Step Freq (Frequency) [Hz] Sets the LFO step speed (speed that changes in steps)	0.05...50.00Hz Fx:010, D-mod
	Amt Sets the modulation amount of LFO step speed	-50.00...+50.00Hz
f	BPM/MIDI Sync Switches between using the frequency of the LFO speed and using the tempo and notes	Off, On Fx:009, Sync
	BPM Selects MIDI Clock and assigns tempo	MIDI, 40...240 Fx:009, 010
	Base Note Selects the type of notes that specify the LFO speed	Fx:009
	Times Sets the number of notes that specify the LFO speed	x1...x16 Fx:009
g	Step Base Note Selects the type of notes to specify the LFO step speed	Fx:010, Sync
	Times Sets the number of notes to specify the LFO step speed	x1...x32 Fx:010
h	Depth Sets the depth of LFO modulation	0...100

i	Feedback Sets the feedback amount	-100...+100 Fx:020
	High Damp [%] Sets the feedback damping amount in the high range	0...100% Fx:020
j	Wet/Dry Table, “Sets the balance between the effect and dry sounds,” on page 175	-Wet...-1:99, Dry, 1:99...Wet Fx:010, 020, D-mod
	Src Table, “Selects the modulation source of the effect balance,” on page 175	Off...Tempo
	Amt Table, “Sets the modulation amount of the effect balance,” on page 175	-100...+100

022: Envel.Flans

(Stereo Envelope Flanger)

This Flanger uses an envelope generator for modulation. You will obtain the same pattern of flanging each time you play. You can also control the Flanger directly using the modulation source.

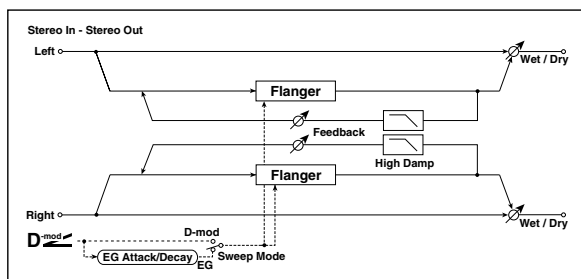

a	L Dly Bottom [msec] (L Delay Bottom)0.0...50.0msec Sets the lower limit of the delay time on the left channel	Fx:009
	L Dly Top [msec] (L Delay Top)0.0...50.0msec Sets the upper limit of the delay time on the left channel	Fx:009
b	R Dly Bottom [msec] (R Delay Bottom)0.0...50.0msec Sets the lower limit of the delay time on the right channel	Fx:009
	R Dly Top [msec] (R Delay Top)0.0...50.0msec Sets the upper limit of the delay time on the right channel	Fx:009
c	Sweep ModeEG, D-mod Determines whether the flanger is controlled by the envelope generator or by the modulation source	D-mod
	SrcOff...Tempo Selects the modulation source that triggers the EG (when EG is selected for Sweep Mode), or modulation source that causes the flanger to sweep (when D-mod is selected for Sweep Mode)	Fx:009
d	EG Attack Sets the EG attack speed	1...100 Fx:009
	EG Decay Sets the EG decay speed	1...100 Fx:009
e	Feedback Sets the feedback amount	-100...+100 Fx:020
f	High Damp [%]0...100% Sets the feedback damping amount in the high range	Fx:020
g	Wet/Dry-Wet...-1:99, Dry, 1:99...Wet Table, “Sets the balance between the effect and dry sounds,” on page 175	Fx:010, 020, D-mod
	SrcOff...Tempo Table, “Selects the modulation source of the effect balance,” on page 175	Fx:010, 020, D-mod
	Amt Table, “Sets the modulation amount of the effect balance,” on page 175	-100...+100

c: Sweep Mode, c: Src

This parameter switches the flanger control mode. With “Sweep Mode” = EG, the flanger will sweep using the envelope generator. This envelope generator is included in the envelope flanger, and not related to the Pitch EG, Filter EG, or Amp EG.

The "Src" parameter selects the source that starts the envelope generator. If you select, for example, **Gate**, the envelope generator will start when the note-on message is received.

When "Sweep Mode" = **D-mod**, the modulation source can control the flanger directly. Select the modulation source using the "Src" parameter.

MIDI The effect is off when a value for the modulation source specified for the "Src" parameter is smaller than 64, and the effect is on when the value is 64 or higher. The Envelope Generator is triggered when the value changes from 63 or smaller to 64 or higher.

d: EG Attack, d: EG Decay

Attack and Decay speed are the only adjustable parameters on this EG.

023: Phaser

(Stereo Phaser)

This effect creates a swell by shifting the phase. It is very effective on electric piano sounds. You can add spread to the sound by offsetting the phase of the left and right LFOs from each other.

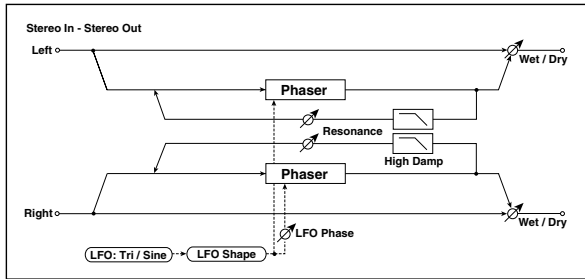

a	LFO Waveform Selects LFO Waveform	Triangle, Sine
	LFO Shape Determines how much the LFO waveform is changed	-100...+100 Fx:020
b	LFO Phase [degree] Sets the LFO phase difference between the left and right	-180...+180 Fx:010
c	LFO Frequency [Hz] Sets the LFO speed	0.02...20.00Hz Fx:009, D-mod
	Src Selects the modulation source of LFO speed	Off...Tempo
	Amt Sets the modulation amount of LFO speed	-20.00...+20.00Hz

d	BPM/MIDI Sync Switches between using the frequency of the LFO speed and using the tempo and notes	Off, On Fx:009, Sync
	BPM Selects MIDI Clock and assigns tempo	MIDI, 40...240 Fx:009
	Base Note Selects the type of notes that specify the LFO speed	♩, ♪, ♫, ♬, ♮, ♯, ♭, ♮, ♯, ♭, ♮ Fx:009
	Times Sets the number of notes that specify the LFO speed	x1...x16 Fx:009
e	Manual Sets the frequency to which the effect is applied	0...100
f	Depth Sets the depth of LFO modulation	0...100 D-mod
	Src Selects the modulation source for the LFO modulation depth	Off...Tempo
	Amt Sets the modulation amount of the LFO modulation depth	-100...+100
g	Resonance Sets the resonance amount	-100...+100 Fx
	High Damp [%] Sets the resonance damping amount in the high range	0...100% Fx
h	Wet/Dry Table, "Sets the balance between the effect and dry sounds," on page 175	-Wet...-1:99, Dry, 1:99...Wet Fx:010, D-mod
	Src Table, "Selects the modulation source of the effect balance," on page 175	Off...Tempo
	Amt Table, "Sets the modulation amount of the effect balance," on page 175	-100...+100

g: Resonance, h: Wet/Dry

The peak shape of the positive and negative Feedback value is different. The harmonics will be emphasized when the effect sound is mixed with the dry sound, if you set a positive value for both "Resonance" and "Wet/Dry", and if you set a negative value for both "Resonance" and "Wet/Dry".

g: High Damp [%]

This parameter sets the amount of damping of the resonance in the high range. Increasing the value will cut high-range harmonics.

024: RandomPhser
(Stereo Random Phaser)

This is a stereo phaser. The effect uses a step-shape waveform and random LFO for modulation, creating a unique phasing effect.

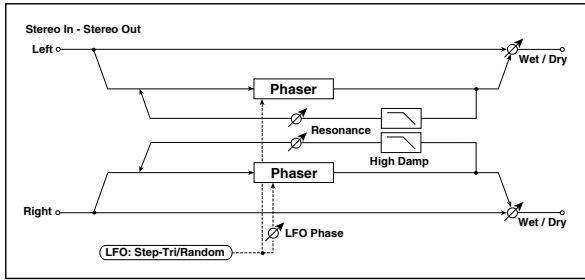

a	LFO Waveform Selects LFO Waveform	Step-Tri, Step-Sin, Random Fx:010
b	LFO Phase [degree] Sets the LFO phase difference between the left and right	-180...+180 Fx:010
c	LFO Frequency [Hz] Sets the LFO speed	0.02...20.00Hz Fx:010, D-mod
	Src Selects the modulation source commonly used for LFO speed and step speed	Off...Tempo
d	Amt Sets the modulation amount of LFO speed	-20.00...+20.00Hz
	LFO Step Freq (Frequency) [Hz] Sets the LFO step speed	0.05...50.00Hz Fx:010, D-mod
e	Amt Sets the modulation amount of LFO step speed	-50.00...+50.00Hz
	BPM/MIDI Sync Switches between using the frequency of the LFO speed and using the tempo and notes	Off, On Fx:009, Sync
f	BPM Selects MIDI Clock and assigns tempo	MIDI, 40...240 009, 010
	Base Note Selects the type of notes that specify the LFO speed	Fx:009
	Times Sets the number of notes that specify the LFO speed	x1...x16 Fx:009
g	Step Base Note Selects the type of notes to specify the LFO step speed	Fx:010, Sync
	Times Sets the number of notes to specify the LFO step speed	x1...x32 Fx:010
g	Manual Sets the frequency to which the effect is applied	0...100
h	Depth Sets the depth of LFO modulation	0...100
i	Resonance Sets the resonance amount	-100...+100 Fx:023
	High Damp [%] Sets the resonance damping amount in the high range	0...100% Fx:023
j	Wet/Dry Table , "Sets the balance between the effect and dry sounds," on page 175	-Wet...-1:99, Dry, 1:99...Wet Fx:010, 023, D-mod
	Src Table , "Selects the modulation source of the effect balance," on page 175	Off...Tempo
	Amt Table , "Sets the modulation amount of the effect balance," on page 175	-100...+100

025: Envel.Phser
(Stereo Envelope Phaser)

This stereo phaser uses an envelope generator for modulation. You will obtain the same pattern of phasing each time you play. You can also control the Phaser directly using the modulation source.

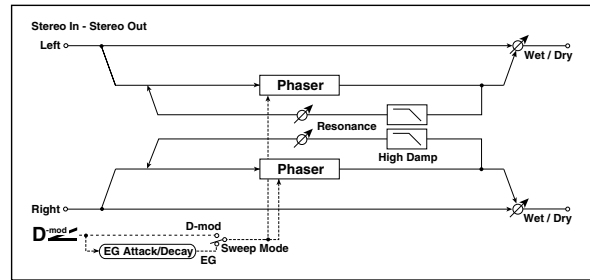

a	L Manu Bottom (L Manual Bottom) Sets the lower limit of the frequency range for the effect on the left channel	0...100 Fx:009
	L Manu Top (L Manual Top) Sets the upper limit of the frequency range for the effect on the left channel	0...100 Fx:009
b	R Manu Bottom (R Manual Bottom) Sets the lower limit of the frequency range for the effect on the right channel	0...100 Fx:009
	R Manu Top (R Manual Top) Sets the upper limit of the frequency range for the effect on the right channel	0...100 Fx:009
c	Sweep Mode Determines whether the flanger is controlled by the envelope generator or by the modulation source	EG, D-mod Fx:022, D-mod
	Src Selects the modulation source that triggers the EG (when EG is selected for Sweep Mode), or modulation source that causes the flanger to sweep (when D-mod is selected for Sweep Mode)	Off...Tempo
d	EG Attack Sets the EG attack speed	1...100 Fx:022
	EG Decay Sets the EG decay speed	1...100 Fx:022
e	Resonance Sets the resonance amount	-100...+100 Fx:023
f	High Damp [%] Sets the resonance damping amount in the high range	0...100% Fx:023
g	Wet/Dry Table , "Sets the balance between the effect and dry sounds," on page 175	-Wet...-1:99, Dry, 1:99...Wet Fx:010, 023, D-mod
	Src Table , "Selects the modulation source of the effect balance," on page 175	Off...Tempo
	Amt Table , "Sets the modulation amount of the effect balance," on page 175	-100...+100

026: BiphaseMod. (Stereo Biphase Modulation)

This stereo chorus effect adds two different LFOs together. You can set the Frequency and Depth parameters for each LFO individually. Depending on the setting of these LFOs, very complex waveforms will create an analog-type, unstable modulated sound.

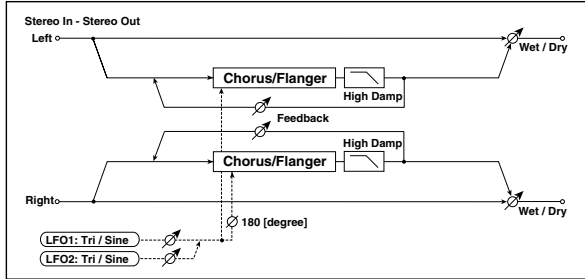

a	LFO1 Waveform Selects LFO1 waveform	Triangle, Sine
	LFO2 Waveform Selects LFO2 waveform	Triangle, Sine
b	LFO Phase Sw Switches the LFO phase difference between left and right	0 degree, 180 degree
c	LFO1 Frequency [Hz] Sets the LFO1 speed	0.02...30.00Hz D ^{mod}
	Src Selects the modulation source of LFO1&2 speed	Off...Tempo
	Amt Sets the modulation amount of LFO1 speed	-30.00...+30.00
d	LFO2 Frequency [Hz] Sets the LFO2 speed	0.02...30.00Hz D ^{mod}
	Amt Sets the modulation amount of LFO2 speed	-30.00...+30.00
e	Depth1 Sets the depth of LFO1 modulation	0...100 D ^{mod}
	Src Selects the modulation source of LFO1&2 modulation depth	Off...Tempo
	Amt Sets the modulation amount of LFO1 modulation depth	-100...+100
f	Depth2 Sets the depth of LFO2 modulation	0...100 D ^{mod}
	Amt Sets the modulation amount of LFO2 modulation depth	-100...+100
g	L Pre Delay [msec] Sets the delay time for the left channel	0.0...50.0msec Fx:016
h	R Pre Delay [msec] Sets the delay time for the right channel	0.0...50.0msec Fx:016
i	Feedback Sets the feedback amount	-100...+100 Fx:017
	High Damp [%] Sets the damping amount in the high range	0...100%
j	Wet/Dry Table, "Sets the balance between the effect and dry sounds," on page 175	-Wet...-1:99, Dry, 1:99...Wet Fx:010, D ^{mod}
	Src Table, "Selects the modulation source of the effect balance," on page 175	Off...Tempo
	Amt Table, "Sets the modulation amount of the effect balance," on page 175	-100...+100

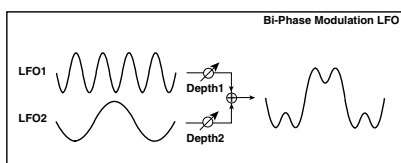

027: Vibrato (Stereo Vibrato)

This effect causes the pitch of the input signal to shimmer. Using the AutoFade allows you to increase or decrease the shimmering speed.

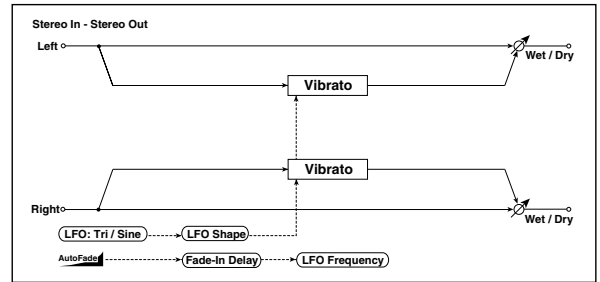

a	AUTOFADE Src Selects the modulation source that starts AutoFade	Off...Tempo Fx:009, D ^{mod}
	Fade-In Rate Sets the rate of fade-in	1...100 Fx:009
b	Fade-In Delay [msec] Sets the fade-in delay time	00...2000msec Fx:009
c	LFO Waveform Selects LFO Waveform	Triangle, Sine
	LFO Shape Determines how much the LFO waveform is changed	-100...+100 Fx:020
d	LFO Frequency Mod Switches between D-mod and AUTOFADE for the LFO frequency modulation	D-mod, AUTOFADE Fx:009
e	LFO Frequency [Hz] Sets the LFO speed	0.02...20.00Hz Fx:009, D ^{mod}
	Src Selects the modulation source of LFO speed	Off...Tempo
	Amt Sets the modulation amount of LFO speed	-20.00...+20.00Hz
f	BPM/MIDI Sync Switches between using the frequency of the LFO speed and using the tempo and notes	Off, On Fx:009, J ^{Sync}
	BPM Selects MIDI Clock and assigns tempo	MIDI, 40...240 Fx:009
	Base Note Selects the type of notes that specify the LFO speed	Fx:009
g	Times Sets the number of notes that specify the LFO speed	x1...x16 Fx:009
	Depth Sets the depth of LFO modulation	0...100 D ^{mod}
	Src Selects the modulation source of the LFO modulation depth	Off...Tempo
h	Amt Sets the modulation amount of the LFO modulation depth	-100...+100
	Wet/Dry Table, "Sets the balance between the effect and dry sounds," on page 175	Dry, 1:99...99:1, Wet D ^{mod}
	Src Table, "Selects the modulation source of the effect balance," on page 175	Off...Tempo
i	Amt Table, "Sets the modulation amount of the effect balance," on page 175	-100...+100

d: LFO Frequency Mod, a: AUTOFADE Src, a: Fade-In Rate b: Fade-In Delay [msec]

When "LFO Frequency Mod" is set to **AUTOFADE**, you can use the modulation source selected in "AUTO FADE Src" as a trigger to automatically fade in the modulation amount. When "BPM/MIDI Sync" is set to **On**, you cannot use this.

The "Fade-in Rate" parameter specifies the rate of fade-in. The "Fade-in Delay" parameter determines the time from AutoFade modulation source ON until the fade-in starts.

The following is an example of fade-in where the LFO speed is increased from "1.0Hz" to "4.0Hz" when a note-on message is received.

"AUTOFADE Src"=Gate1, "LFO Frequency [Hz]"=1.0
"LFO Frequency Mod"=AUTOFADE, "Amt"=3.0

MIDI The effect is off when a value for the dynamic modulation source specified for the "AUTOFADE Src" parameter is smaller than 64, and the effect is on when the value is 64 or higher. The AutoFade function is triggered when the value changes from 63 or smaller to 64 or higher.

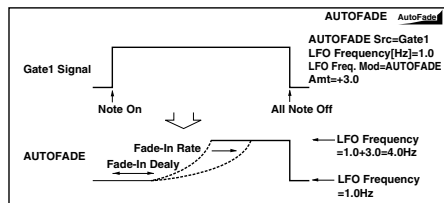

028: AutoFadeMod. (Stereo Auto Fade Modulation)

This stereo chorus/flanger effect enables you to control the LFO speed and effect balance using auto fade, and you can spread the sound by offsetting the phase of the left and right LFOs from each other.

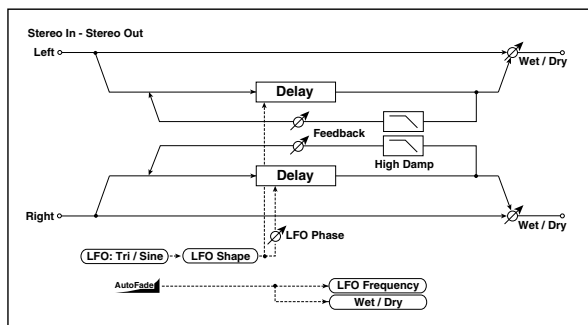

a	AUTOFADE Src Selects the modulation source that starts AutoFade	Off...Tempo Fx:027, D^{mod}
	Rate Sets the rate of fade-in	1...100 Fx:027
	Fade-In Delay (Fade-In Delay) [msec] Sets the fade-in delay time	00...2000msec Fx:027
b	LFO Waveform Selects LFO Waveform	Triangle, Sine
	LFO Shape Determines how much the LFO waveform is changed	-100...+100 Fx:020
c	LFO Phase [degree] Sets the LFO phase difference between the left and right	-180...+180 Fx:010
d	LFO Frequency Mod Switches between D-mod and AUTOFADE for the LFO frequency modulation	D-mod, AUTOFADE Fx:027
e	LFO Frequency [Hz] Sets the LFO speed	0.02...20.00Hz D^{mod}
	Src Selects the modulation source of LFO speed	Off...Tempo
f	Amt Sets the modulation amount of LFO speed	-20.00...+20.00Hz
	L Delay Time [msec] Sets the left channel delay time	0.0...500.0msec
	R Delay Time [msec] Sets the right channel delay time	0.0...500.0msec
g	Depth Sets the depth of LFO modulation	0...200
h	Feedback Sets the feedback amount	-100...+100 Fx:020
	High Damp [%] Sets the feedback damping amount in the high range	0...100% Fx:020

i	Wet/Dry Mod Switches between D-mod and AUTOFADE for the effect balance modulation Fx:027	D-mod, AUTOFADE
j	Wet/Dry Table, "Sets the balance between the effect and dry sounds," on page 175 Fx:010, 020, D^{mod}	-Wet...-1:99, Dry, 1:99...Wet
	Src Table, "Selects the modulation source of the effect balance," on page 175	Off...Tempo
	Amt Table, "Sets the modulation amount of the effect balance," on page 175	-100...+100

029: 2Voice Res

This effect resonates the input signal at a specified pitch. You can set the pitch, output level, and pan settings for two resonators individually. You can control the resonance intensity via an LFO.

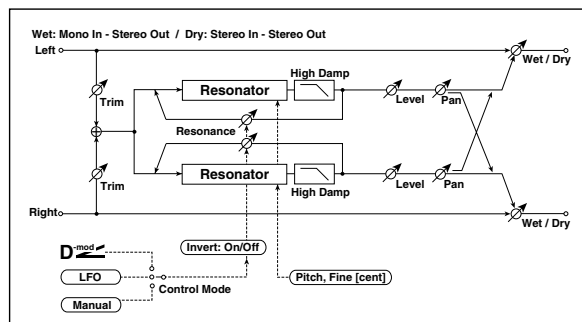

a	Control Mode Switches the controls of resonance intensity	Manual, LFO, D-mod Fx:027, D^{mod}
	LFO/D-mod Invert Reverses the Voice 1 and 2 control when LFO/D-mod is selected	Off, On Fx:027
b	LFO Frequency [Hz] Sets the LFO speed	0.02...20.00Hz
	D-mod Src Selects the modulation source that controls resonance intensity	Off...Tempo
c	Mod. Depth Sets the amount of resonance intensity control via LFO/D-mod	-100...+100
	Trim Sets the input level at the resonator	0...100
d	Voice1: Pitch Sets the voice1 Pitch for resonance	C0...B8
	Fine [cent] Fine-adjusts the voice 1 pitch for resonance	-50...+50
e	Voice1: Resonance Sets the intensity of resonance when Control Mode = Manual Fx:027	-100...+100
	High Damp [%] Sets the damping amount of resonant sound in the high range Fx:027	0...100%
f	Voice1: Level Sets the Voice1 output level	0...100
	Pan Sets the Voice1 stereo image	L6...R6
g	Voice2: Pitch Sets the Voice2 Pitch for resonance	C0...B8
	Fine [cent] Fine-adjusts the voice 2 pitch for resonance	-50...+50
h	Voice2: Resonance Sets the intensity of resonance when Control Mode = Manual Fx:027	-100...+100
	High Damp [%] Sets the damping amount of resonant sound in the high range Fx:027	0...100%
i	Voice2: Level Sets the Voice2 output level	0...100
	Pan Sets the Voice2 stereo image	L6...R6

j	Wet/Dry Table , "Sets the balance between the effect and dry sounds," on page 175 D^{mod}	Dry, 1:99...99:1, Wet
	Src Table , "Selects the modulation source of the effect balance," on page 175	Off...Tempo
	Amt Table , "Sets the modulation amount of the effect balance," on page 175	-100...+100

a: Control Mode, e: Voice1: Resonance, h: Voice2: Resonance

This parameter determines the resonance intensity. When "Control Mode" = **Manual**, the "Resonance" parameter sets the intensity of resonance. If the "Resonance" parameter has a negative value, harmonics will be changed, and resonance will occur at a pitch one octave lower.

When "Control Mode" = **LFO**, the intensity of resonance varies according to the LFO. The LFO sways between positive and negative values, causing resonance to occur between specified pitches an octave apart in turn.

When "Control Mode" = **D-mod**, the resonance is controlled by the dynamic modulation source. If **JS X** or **Ribbon** is assigned as the modulation source, the pitch an octave higher and lower can be controlled, similar to when LFO is selected for Control Mode.

a: LFO/D-mod Invert

When "Control Mode" = **LFO** or **D-mod**, the controlled phase of either Voice 1 or 2 will be reversed. When the resonance pitch is set for Voice 1 (Resonance has a positive value), Voice 2 will resonate at a pitch an octave below (Resonance has a negative value).

d: Voice1: Pitch, d: Fine [cent], g: Voice2: Pitch, g: Fine [cent]

The Pitch parameter specifies the pitch of resonance by note name. The "Fine" parameter allows for fine adjustment in steps of cents.

e: High Damp [%], h: High Damp [%]

This parameter sets the damping amount of resonant sound in the high range. Lower values will make a metallic sound with a higher range of harmonics.

030: Doppler

This effect simulates the "Doppler effect" of a moving sound with a changing pitch, similar to the siren of an passing ambulance. Mixing the effect sound with the dry sound will create a unique chorus effect.

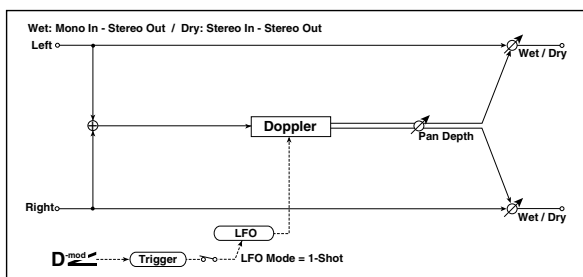

a	LFO Mode Switches LFO operation mode	Loop, 1-Shot L^{mod} , D^{mod}
	Src When LFO Mode is set to 1-Shot, this modulation source triggers the LFO	Off...Tempo L^{mod}
b	LFO Sync Switches between LFO reset on and off when LFO Mode is set to Loop	Off, On L^{mod}

c	LFO Frequency [Hz] Sets the LFO speed	0.02...20.00Hz L^{mod} Fx:009, D^{mod}
	Src Selects the modulation source of LFO speed	Off...Tempo
	Amt Sets the modulation amount of LFO speed	-20.00...+20.00Hz
d	BPM/MIDI Sync Switches between using the frequency of the LFO speed and using the tempo and notes	Off, On L^{mod} Fx:009, L^{mod}
	BPM Selects MIDI Clock and assigns tempo	MIDI, 40...240 L^{mod} Fx:009
	Base Note Selects the type of notes that specify the LFO speed	L^{mod} Fx:009
	Times Sets the number of notes that specify the LFO speed	x1...x16 L^{mod} Fx:009
e	Pitch Depth Sets the pitch variation of the moving sound	0...100 L^{mod} , D^{mod}
	Src Selects the modulation source of pitch variation	Off...Tempo
	Amt Sets the modulation amount of pitch variation	-100...+100
f	Pan Depth Sets the panning of the moving sound	-100...+100 L^{mod} , D^{mod}
	Src Selects the modulation source of panning	Off...Tempo
	Amt Sets the modulation amount of panning	-100...+100
g	Wet/Dry Table , "Sets the balance between the effect and dry sounds," on page 175 D^{mod}	Dry, 1:99...99:1, Wet
	Src Table , "Selects the modulation source of the effect balance," on page 175	Off...Tempo
	Amt Table , "Sets the modulation amount of the effect balance," on page 175	-100...+100

a: LFO Mode, a: Src, b: LFO Sync

The "LFO Mode" parameter switches LFO operation mode. When **Loop** is selected, the Doppler effect will be created repeatedly. If "LFO Sync" is set to **On**, the LFO will be reset when the modulation source specified with the "Src" parameter is turned on.

When "LFO Mode" is set to **1-Shot**, the Doppler effect is created only once when the modulation source specified in the "Src" field is turned on. At this time if you do not set the "Src" parameter, the Doppler effect will not be created, and no effect sound will be output.

MIDI The effect is off when a value for the modulation source specified for the "Src" parameter is smaller than 64, and the effect is on when the value is 64 or higher. The Doppler effect is triggered when the value changes from 63 or smaller to 64 or higher.

e: Pitch Depth

With the Doppler effect, the pitch is raised when the sound approaches, and the pitch is lowered when the sound goes away. This parameter sets this pitch variation.

f: Pan Depth

This parameter sets the width of the stereo image of the effect sound. With larger values, the sound seems to come and go from much further away. With positive values, the sound moves from left to right; with negative values, the sound moves from right to left.

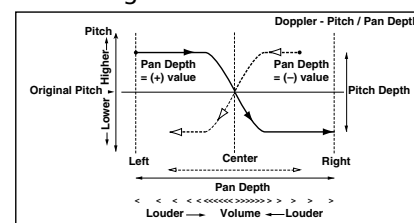

031: Scratch

This effect is applied by recording the input signal and moving the modulation source. It simulates the sound of scratches you can make using a turntable.

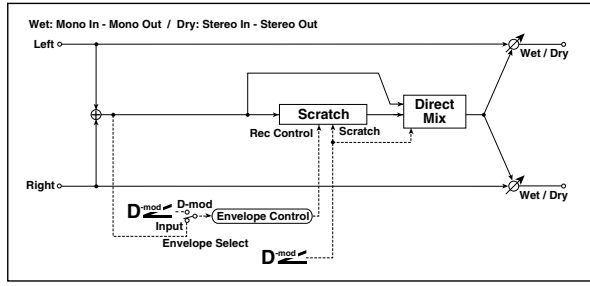

a: Scratch Source, b: Response

The Scratch Source parameter enables you to select the modulation source that controls simulation. The value of the modulation source corresponds to the playback position. The Response parameter enables you to set the speed of the response to the modulation source.

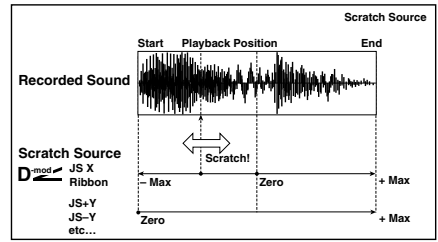

c: Envelope Select, c: Src, d: Threshold

When "Envelope Select" is set to **D-mod**, the input signal will be recorded only when the modulation source value is 64 or higher.

When "Envelope Select" is set to **Input**, the input signal will be recorded only when its level is over the Threshold value.

The maximum recording time is 1365msec. If this is exceeded, the recorded data will start being erased from the top.

e: Response

This parameter enables you to set the speed of the response to the end of recording. Set a smaller value when you are recording a phrase or rhythm pattern, and set a higher value if you are recording only one note.

f: Direct Mix

With **Always On**, a dry sound is usually output. With **Always Off**, dry sounds are not output. With **Cross Fade**, a dry sound is usually output, and it is muted only when scratching.

Set Wet/Dry to **Wet** to use this parameter effectively.

a	Scratch Source Selects the modulation source for simulation control	Off...Tempo E ³ , D ^{mod}
b	Response Sets the speed of the response to the Scratch Source	0...100 E ³
c	Envelope Select Selects whether the start and end of recording is controlled via the modulation source or the input signal level	D-mod, Input E ³ , D ^{mod}
	Src Selects the modulation source that controls recording when Envelope Select is set to D-mod	Off...Tempo E ³
d	Threshold Sets the recording start level when Envelope Select is set to Input	0...100 E ³
e	Response Sets the speed of the response to the end of recording	0...100 E ³
f	Direct Mix Selects how a dry sound is mixed	Always On, Always Off, Cross Fade E ³
g	Wet/Dry Table , "Sets the balance between the effect and dry sounds," on page 175	Dry, 1:99...99:1, Wet D ^{mod}
	Src Table , "Selects the modulation source of the effect balance," on page 175	Off...Tempo
	Amt Table , "Sets the modulation amount of the effect balance," on page 175	-100...+100

MOD./P.SHIFT

Other modulation and pitch shift effects

032: Tremolo

(Stereo Tremolo)

This effect modulates the volume level of the input signal. The effect is stereo, and offsetting the LFO of the left and right phases from each other produces a tremolo effect between left and right.

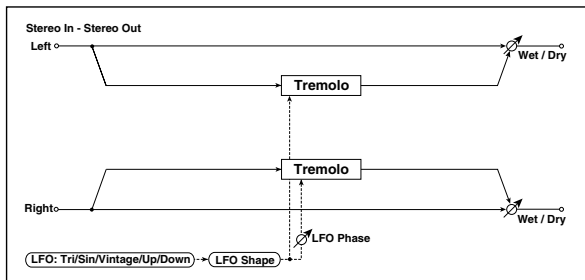

a	LFO Waveform Selects LFO Waveform	Triangle, Sine, Vintage, Up, Down	
	LFO Shape Determines how much the LFO waveform is changed	-100...+100	Fx:020
b	LFO Phase [degree] Sets the LFO phase difference between the left and right	-180...+180	Fx:
	LFO Frequency [Hz] Sets the LFO speed	0.02...20.00Hz	Fx:009, D ^{mod}
c	Src Selects the modulation source of LFO speed	Off...Tempo	
	Amt Sets the modulation amount of LFO speed	-20.00...+20.00Hz	
d	BPM/MIDI Sync Switches between using the frequency of the LFO speed and using the tempo and notes	Off, On	Fx:009, Sync
	BPM Selects MIDI Clock and assigns tempo	MIDI, 40...240	Fx:009
	Base Note Selects the type of notes that specify the LFO speed	♪, ♪, ♫, ♬, ♮, ♯, ♭, ♭♭, ♮	Fx:009
	Times Sets the number of notes that specify the LFO speed	x1...x16	Fx:009
e	Depth Sets the depth of LFO modulation	0...100	D ^{mod}
	Src Selects the modulation source of the depth of modulation	Off...Tempo	
	Amt Sets the modulation amount of the depth of modulation	-100...+100	
f	Wet/Dry Sets the balance between the effect and dry sounds," on page 175	Dry, 1:99...99:1, Wet	D ^{mod}
	Src Table , "Selects the modulation source of the effect balance," on page 175	Off...Tempo	
	Amt Table , "Sets the modulation amount of the effect balance," on page 175	-100...+100	

a:LFO Waveform

This parameter selects the LFO waveform. **Vintage** wave simulates the characteristics of the tremolo created on a guitar amplifier. Combining this effect with the Amp Simulation will make a realistic, vintage tremolo amplifier sound.

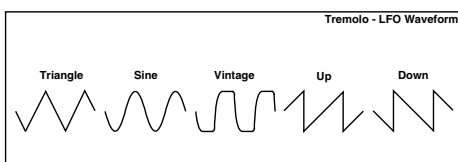

b: LFO Phase [degree]

This parameter determines the difference between the left and right LFO phases. A higher value will simulate the auto-pan effect in which the sound is panned between left and right.

033: EnvelTremol

(Stereo Envelope Tremolo)

This effect uses the input signal level to modulate a stereo tremolo. You can simulate a tremolo effect that becomes deeper as it fades out while the level gets lower.

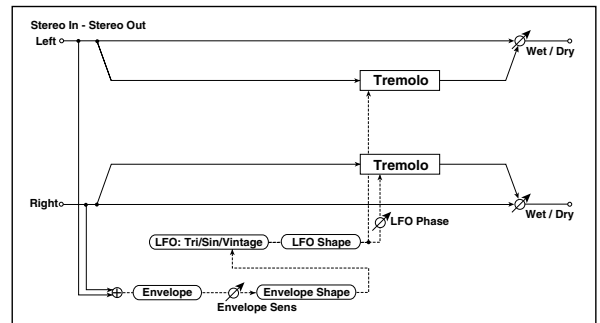

a	Envelope Sens (Envelope Sensitivity) Sets the envelope sensitivity of the input signal	0...100	
	Envelope Shape Sets the envelope curve shape of the input signal	-100...+100	
b	LFO Waveform Selects LFO Waveform	Triangle, Sine, Vintage	
	LFO Shape Determines how much the LFO waveform is changed	-100...+100	Fx:020
c	LFO Phase [degree] Sets the LFO phase difference between the left and right	-180...+180	Fx:032
	LFO Frequency [Hz] Sets the LFO speed	0.02...20.00Hz	Fx:
d	Envelope Amount [Hz] Sets the changes of the LFO speed according to the input signal level	-20.00...+20.00Hz	Fx:
	Depth Sets the depth of LFO modulation	0...100	Fx:
e	Envelope Amount Sets the changes of the modulation depth according to the input signal level	-100...+100	Fx:
	Wet/Dry Table , "Sets the balance between the effect and dry sounds," on page 175	Dry, 1:99...99:1, Wet	D ^{mod}
	Src Table , "Selects the modulation source of the effect balance," on page 175	Off...Tempo	
f	Amt Table , "Sets the modulation amount of the effect balance," on page 175	-100...+100	

d: LFO Frequency [Hz], d: Envelope Amount [Hz],

e: Depth, e: Envelope Amount

These parameters set the modulation via an envelope (input signal level).

The "LFO speed" is obtained by adding the "LFO Frequency" value to the "Envelope Amount" value multiplied by the input signal. The LFO modulation depth is obtained by adding the Depth value to the "Envelope Amount" value multiplied by the input signal level.

- The following example indicates that the "Depth" is 0 with an LFO Frequency of 1.0Hz and the maximum input, and that the "Depth" is 100 with a Frequency of 8.0Hz with zero input. "LFO Frequency [Hz]"=8.0, "Envelope Amount [Hz]"=-7.0

"Depth"=100, "Envelope Amount"=-100

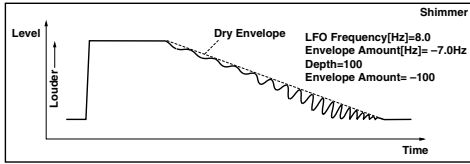

034: Auto-Pan (Stereo Auto Pan)

This Auto Pan effect pans sound between left and right. It is stereo, and shifting the left and right LFO phases from each other will simulate the sound of the left and right channels crossing over each other by turns, or chasing each other.

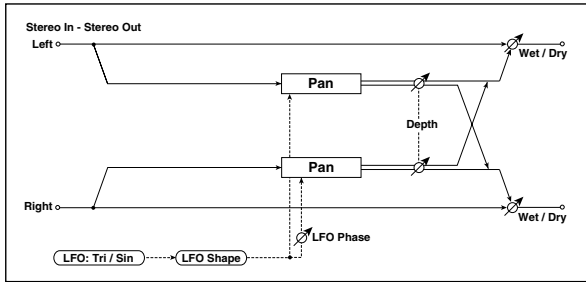

a	LFO Waveform Selects LFO Waveform	Triangle, Sine
	LFO Shape Determines how much the LFO waveform is changed	-100...+100
b	LFO Phase [degree] Sets the LFO phase difference between the left and right	-180...+180
c	LFO Frequency [Hz] Sets the LFO speed	0.02...20.00Hz
	Src Selects the modulation source of LFO speed	Off...Tempo
	Amt Sets the modulation amount of LFO speed	-20.00...+20.00Hz
d	BPM/MIDI Sync Switches between using the frequency of the LFO speed and using the tempo and notes	Off, On
	BPM Selects MIDI Clock and assigns tempo	MIDI, 40...240
	Base Note Selects the type of notes that specify the LFO speed	Fx:009
	Times Sets the number of notes that specify the LFO speed	x1...x16

e	Depth Sets the depth of LFO modulation	0...100
	Src Selects the modulation source of the depth of modulation	Off...Tempo
	Amt Sets the modulation amount of the depth of modulation	-100...+100
f	Wet/Dry Table, "Sets the balance between the effect and dry sounds," on page 175	Dry, 1:99...99:1, Wet
	Src Table, "Selects the modulation source of the effect balance," on page 175	Off...Tempo
	Amt Table, "Sets the modulation amount of the effect balance," on page 175	-100...+100

a: LFO Shape

You can change the panning curve by modifying the LFO waveform.

b: LFO Phase

This parameter determines the difference in the left and right LFO phases. When you change the value gradually from 0, the sound from the left and right channels will chase each other around. If you set the parameter to +180 or -180, the sound from each channel will cross over each other.

You need to input different sounds to each channel in order for this parameter to be effective.

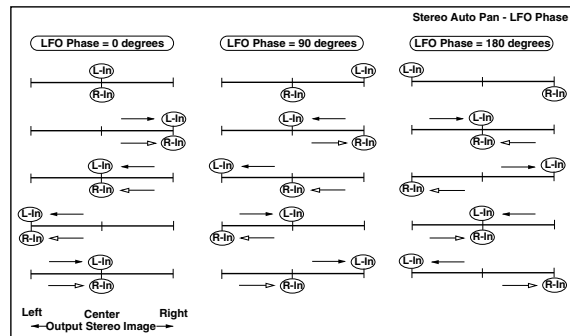

035: Phaser/Trem

(Stereo Phaser + Tremolo)

This effect has a stereo phaser and tremolo LFOs linked together. Swelling phaser modulation and tremolo effects synchronize with each other, creating a soothing modulation effect. It is suitable for electric piano type sounds.

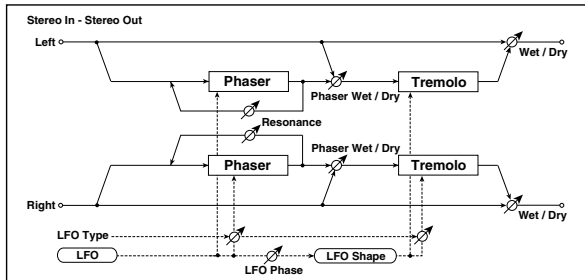

a	Type: Phs - Trml...Phs LR - Trml LR Selects the type of the tremolo and phaser LFOs	
	LFO Phase [degree] Sets the phase difference between the tremolo and phaser LFOs	-180...+180
b	LFO Frequency [Hz] Sets the LFO speed	0.02...20.00Hz
	Src Selects the modulation source of LFO speed	Off...Tempo
	Amt Sets the modulation amount of LFO speed	-20.00...+20.00Hz
c	BPM/MIDI Sync Switches between using the frequency of the LFO speed and using the tempo and notes	Off, On
	BPM Selects MIDI Clock and assigns tempo	MIDI, 40...240
	Base Note Selects the type of notes that specify the LFO speed	
	Times Sets the number of notes that specify the LFO speed	x1...x16
d	Phaser Manual Sets the phaser frequency range	0...100
	Resonance Sets the phaser resonance amount	-100...+100
e	Phaser Depth Sets the phaser modulation depth	0...100
	Src Selects the modulation source for the phaser modulation depth	Off...Tempo
	Amt Sets the modulation amount for the phaser modulation depth	-100...+100
f	Phaser Wet/Dry Sets the balance between the phaser effect and dry sounds	-Wet...-2:99, Dry, 2:99...Wet
g	Tremolo Shape Sets the degree of the tremolo LFO shaping	-100...+100
h	Tremolo Depth Sets the tremolo modulation depth	0...100
	Src Selects the modulation source for the tremolo modulation depth	Off...Tempo
	Amt Sets the modulation amount of the tremolo modulation depth	-100...+100
	Wet/Dry Table, "Sets the balance between the effect and dry sounds," on page 175	Dry, 1:99...99:1, Wet
i	Src Table, "Selects the modulation source of the effect balance," on page 175	Off...Tempo
	Amt Table, "Sets the modulation amount of the effect balance," on page 175	-100...+100

a: Type, a: LFO Phase [degree]

Select the type of phaser LFO and tremolo LFO for the "Type" parameter. How the effect sound moves or rotates depends on the type of LFO. Selecting "LFO Phase"

enables you to offset the timing of the phaser peak and control a subtle movement and rotation of the sound.

f: Phaser Wet/Dry, i: Wet/Dry

The "Phaser Wet/Dry" parameter sets the balance between the phaser output and the dry sound. The "Wet/Dry" parameter sets the balance between the final phaser and tremolo output level and the dry sound.

036: RingModulat

(Stereo Ring Modulator)

This effect creates a metallic sound by applying the oscillators to the input signal. Use the LFO or Dynamic Modulation to modulate the oscillator to create a radical modulation. Matching the oscillator frequency with a note number will produce a ring modulation effect in specific key ranges.

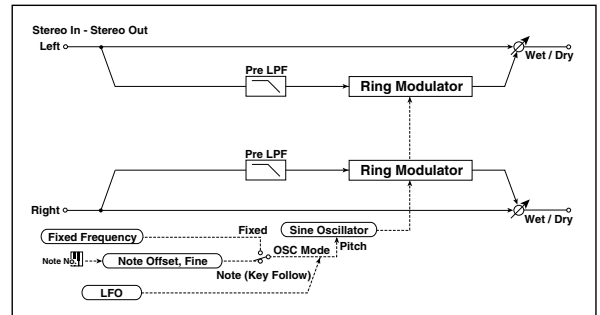

a	Pre LPF Sets the damping amount of the high range input to the ring modulator	0...100
	OSC Mode Switching between specifying the oscillator frequency and using a note number	Fixed, Note (Key Follow)
b	Fixed Frequency [Hz] Sets the oscillator frequency when OSC Mode is set to Fixed	0...12.00kHz
	Src Selects the modulation source for the oscillator frequency when OSC Mode is set to Fixed	Off...Tempo
	Amt Sets the modulation amount of the oscillator frequency when OSC Mode is set to Fixed	-12.00...+12.00kHz
c	Note Offset Sets the pitch difference from the original note when OSC Mode is set to Note (Key Follow)	-48...+48
	Note Fine Fine-adjusts the oscillator frequency	-100...+100
d	LFO Frequency [Hz] Sets the LFO speed of the oscillator frequency modulation	0.02...20.00Hz
	Src Selects the modulation source of LFO speed	Off...Tempo
	Amt Sets the modulation amount of LFO speed	-20.00...+20.00Hz
	BPM/MIDI Sync Switches between using the frequency of the LFO speed and using the tempo and notes	Off, On
e	BPM Selects MIDI Clock and assigns tempo	MIDI, 40...240
	Base Note Selects the type of notes that specify the LFO speed	
	Times Sets the number of notes that specify the LFO speed	x1...x16
	LFO Depth Sets the depth of LFO modulation for the oscillator frequency	0...100
f	Src Selects the modulation source of the depth of modulation	Off...Tempo
	Amt Sets the modulation amount of the depth of modulation	-100...+100

h	Wet/Dry Table , "Sets the balance between the effect and dry sounds," on page 175 D^{mod}	Dry, 1:99...99:1, Wet
	Src Table , "Selects the modulation source of the effect balance," on page 175	Off...Tempo
	Amt Table , "Sets the modulation amount of the effect balance," on page 175	-100...+100

a: Pre LPF

This parameter enables you to set the damping amount of the high range sound input to the ring modulator. If the input sound contains lots of harmonics, the effect may sound dirty. In this case, cut a certain amount of high range.

b: OSC Mode

This parameter determines whether or not the oscillator frequency follows the note number.

c: Fixed Frequency [Hz]

This parameter sets the oscillator frequency when "OSC Mode" is set to **Fixed**.

d: Note Offset, d: Note Fine

These parameters for the oscillator are used when "OSC Mode" is set to **Note (Key Follow)**. The "Note Offset" sets the pitch difference from the original note in semitone steps. The "Note Fine" parameter fine-adjusts the pitch in cent steps. Matching the oscillator frequency with the note number produces a ring modulation effect in the correct key.

037: Detune

Using this effect, you can obtain a detune effect that offsets the pitch of the effect sound slightly from the pitch of the input signal. Compared to the chorus effect, a more natural sound thickness will be created.

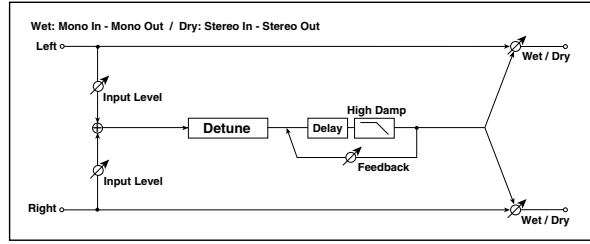

a	Pitch Shift [cent] Sets the pitch difference from the input signal	-100...+100cent D^{mod}
	Src Selects the modulation source of the pitch shift	Off...Tempo
	Amt Sets the modulation amount of the pitch shift	-100...+100cent
b	Delay Time [msec] Sets the delay time	0...1000msec
c	Feedback Sets the feedback amount	-100...+100
	High Damp [%] Sets the damping amount in the high range	0...100%
d	Input Level Dmod [%] Sets the modulation amount of the input level	-100...+100 D^{mod}
	Src Selects the modulation source for the input level	Off...Tempo
	Wet/Dry Table , "Sets the balance between the effect and dry sounds," on page 175 D^{mod}	Dry, 1:99...99:1, Wet
e	Src Table , "Selects the modulation source of the effect balance," on page 175	Off...Tempo
	Amt Table , "Sets the modulation amount of the effect balance," on page 175	-100...+100

d: Input Level Dmod [%], d: Src

This parameter sets the dynamic modulation of the input level.

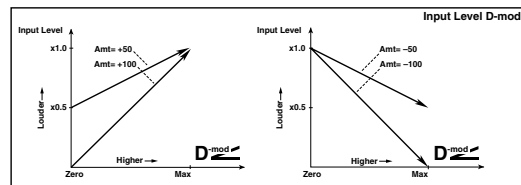

038: PitchShift (Pitch Shifter)

This effect changes the pitch of the input signal. You can select from three types: Fast (quick response), Medium, and Slow (preserves tonal quality). You can also create an effect in which the pitch is gradually raised (or dropped) using the delay with feedback.

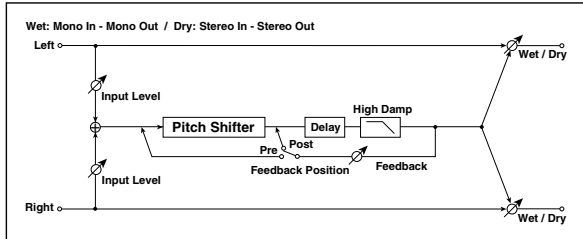

a	Mode	Slow, Medium, Fast
	Switches Pitch Shifter mode	
b	Pitch Shift [1/2tone]	-24...+24
	Sets the pitch shift amount by steps of a semitone	
	Src	Off...Tempo
c	Fine [cent]	-100...+100cent
	Sets the pitch shift amount by steps of a cent	
d	Amt	-24...+24
	Sets the modulation amount of pitch shift amount	
e	Delay Time [msec]	0...1000msec
	Sets the delay time	
f	Feedback Position	Pre, Post
	Switches the feedback connection.	
	Feedback	-100...+100
g	High Damp [%]	0...100%
	Sets the damping amount in the high range	

g	Input Level Dmod [%]	-100...+100
	Sets the modulation amount of the input level	
h	Src	Off...Tempo
	Selects the modulation source for the input level	
	Wet/Dry	Dry, 1:99...99:1, Wet
i	Table, "Sets the balance between the effect and dry sounds," on page 175	
	Src	Off...Tempo
j	Table, "Selects the modulation source of the effect balance," on page 175	
	Amt	-100...+100
k	Table, "Sets the modulation amount of the effect balance," on page 175	

a: Mode

This parameter switches the pitch shifter operating mode. With **Slow**, tonal quality will not be changed too much. With **Fast**, the effect becomes a Pitch Shifter that has a quick response, but may change the tone. **Medium** is in between these two. If you do not need to set too much pitch shift amount, set this parameter to **Slow**. If you wish to change the pitch significantly, use **Fast**.

b: Pitch Shift [1/2tone], b: Src, b: Amt, c: Fine [cent], c: Amt
The amount of pitch shift will use the value of the "Pitch Shift" plus the "Fine" value. The amount of modulation will use the c: Amt value plus d: "Amt."

Modulation Source is used both for "Pitch Shift" and "Fine."

e: Feedback Position, f: Feedback

When "Feedback Position" is set to **Pre**, the pitch shifter output is again input to the pitch shifter. Therefore, if you specify a higher value for the Feedback parameter, the pitch will be raised (or lowered) more and more each time feedback is repeated.

If "Feedback Position" is set to **Post**, the feedback signal will not pass through the pitch shifter again. Even if you specify a higher value for the Feedback parameter, the pitch-shifted sound will be repeated at the same pitch.

039: PitShiftMod. (Pitch Shift Modulation)

This effect modulates the detuned pitch shift amount using an LFO, adding a clear spread and width to the sound by panning the effect sound and dry sound to the left and right. This is especially effective when the effect sound and dry sound output from stereo speakers are mixed.

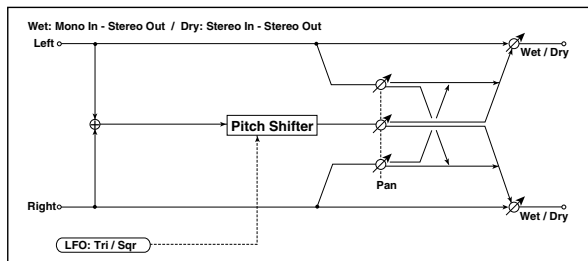

a	Pitch Shift [cent] Sets the pitch difference from the input signal	-100...+100cent E ^{SP}
b	LFO Waveform Selects LFO Waveform	Triangle, Square
c	LFO Frequency [Hz] Sets the LFO speed	0.02...20.00Hz E ^{SP} Fx:009, D ^{mod}
	Src Selects the modulation source of LFO speed	Off...Tempo
	Amt Sets the modulation amount of LFO speed	-20.00...+20.00Hz
d	BPM/MIDI Sync Switches between using the frequency of the LFO speed and using the tempo and notes	Off, On E ^{SP} Fx:009,
	BPM Selects MIDI Clock and assigns tempo	MIDI, 40...240 E ^{SP} Fx:009
	Base Note Selects the type of notes that specify the LFO speed	E ^{SP} Fx:009
	Times Sets the number of notes that specify the LFO speed	x1...x16 E ^{SP} Fx:009
e	Depth Sets the LFO modulation depth for pitch shift amount	-100...+100 E ^{SP} , D ^{mod}
	Src Selects the modulation source of the depth of modulation	Off...Tempo
	Amt Sets the modulation amount of the depth of modulation	-100...+100
f	Pan Sets the panning effect sound and dry sound separately	L, 1:99...99:1, R E ^{SP}
g	Wet/Dry Table, "Sets the balance between the effect and dry sounds," on page 175	Dry, 1:99...99:1, Wet E ^{SP} , D ^{mod}
	Src Table, "Selects the modulation source of the effect balance," on page 175	Off...Tempo
	Amt Table, "Sets the modulation amount of the effect balance," on page 175	-100...+100

a: Pitch Shift [cent], e: Depth

These parameters set the amount of pitch shift and amount of modulation by means of the LFO.

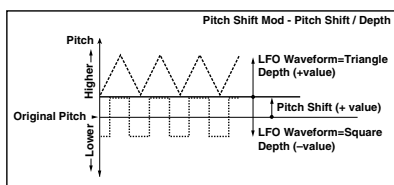

f: Pan, g: Wet/Dry

The Pan parameter pans the effect sound and dry sound to the left and right. With L, the effect sound is panned left, and the dry sound is panned right. With a Wet/Dry = Wet setting, the effect and dry sound will be output in a proportion of 1:1.

040: RotarySpeak (Rotary Speaker)

This effect simulates a rotary speaker, and obtains a more realistic sound by simulating the rotor in the low range and the horn in the high range separately. The effect also simulates the stereo microphone settings.

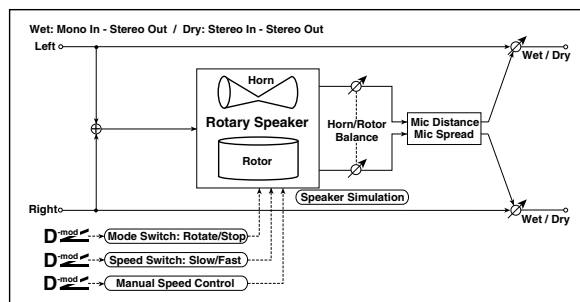

	Mode Switch Switches between speaker rotation and stop	Rotate, Stop D ^{mod}
a	Src Selects the modulation source that toggles between rotation and stop	Off...Tempo
	Sw Selects switching mode of the modulation source that toggles between rotation and stop	Toggle, Moment E ^{SP}
b	Speed Switch Switches the speaker rotation speed between slow and fast	Slow, Fast D ^{mod}
	Src Selects the modulation source that toggles between slow and fast	Off...Tempo
	Sw Selects switching mode of the modulation source that toggles between slow and fast	Toggle, Moment E ^{SP}
c	Manual Speed Ctrl (Manual Speed Control) Selects the modulation source in case the rotation speed is changed directly	Off...Tempo E ^{SP} , D ^{mod}
d	Horn Acceleration How quickly the horn rotation speed in the high range is switched	0...100 E ^{SP}
	Horn Ratio Adjusts the (high-range side) horn rotation speed. Standard value is 1.00. Selecting "Stop" will stop the rotation	Stop, 0.50...2.00
e	Rotor Acceleration Determines how quickly the rotor rotation speed in the low range is switched	0...100 E ^{SP}
	Rotor Ratio Adjusts the (low-range side) rotor rotation speed. Standard value is 1.00. Selecting "Stop" will stop the rotation	Stop, 0.50...2.00
f	Horn/Rotor Balance Sets the level balance between the high-range horn and low-range rotor	Rotor, 1...99, Horn
g	Mic Distance Sets the distance between the microphone and rotary speaker	0...100 E ^{SP}
	Mic Spread Sets the angle of left and right microphones	0...100 E ^{SP}
h	Wet/Dry Table, "Sets the balance between the effect and dry sounds," on page 175	Dry, 1:99...99:1, Wet D ^{mod}
	Src Table, "Selects the modulation source of the effect balance," on page 175	Off...Tempo
	Amt Table, "Sets the modulation amount of the effect balance," on page 175	-100...+100

a: Sw

This parameter sets how the modulation source switches between rotation and stop.

When "Sw" = Toggle, the speaker rotates or stops alternately each time you press the pedal or operate the joystick.



Each time the value for the modulation source exceeds 64, the speaker rotates or stops alternately.

When “Sw” = **Moment**, the speaker is rotating. It stops only when you press the pedal or operate the joystick.

MIDI Rotation will occur when the value of the modulation source is less than 64, and will stop when the value is 64 or greater.

b: Sw

This parameter sets how the rotation speed (slow and fast) is switched via the modulation source.

When “Sw” = **Toggle**, the speed is switched between slow and fast each time you press the pedal or operate the joystick.

MIDI Slow/fast will alternate each time the value of the modulation source exceeds 64.

When “Sw” = **Moment**, the speed is usually slow. It becomes fast only when you press the pedal or operate the joystick.

MIDI When a value for the modulation source is less than 64, “slow” speed is selected, and when the value is 64 or higher, “fast” is selected.

c: Manual Speed Ctrl

If you wish to control the speaker rotation speed manually, not switching between Slow and Fast, select the modulation source in the “Manual Speed Ctrl” field. If manual control is not necessary, set this field to **Off**.

d: Horn Acceleration, e: Rotor Acceleration

On a real rotary speaker, the rotation speed is accelerated or decelerated gradually after you switch the speed. The “Horn Acceleration” parameter sets the speed at which the rotation is accelerated or decelerated.

g: Mic Distance, g: Mic Spread

This is a simulation of stereo microphone settings.

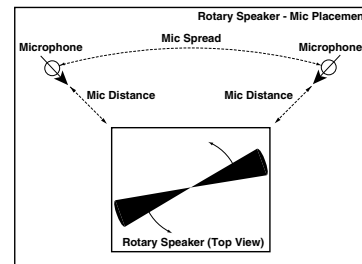

ER/DELAY

Early reflection and delay effects

041: Early Refl
(Early Reflections)

This effect is only the early reflection part of a reverberation sound, and adds presence to the sound. You can select one of the four decay curves.

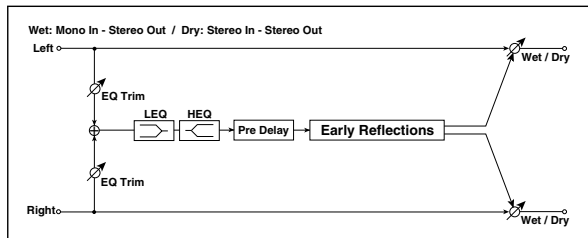

a	Type Selects the decay curve for the early reflection	Sharp, Loose, Modulated, Reverse
b	ER Time [msec] Sets the time length of early reflection	10...800msec
c	Pre Delay [msec] Sets the time taken from the original sound to the first early reflection	0...200msec
d	EQ Trim Sets the input level of EQ applied to the effect sound	0...100
e	Pre LEQ Gain [dB] Table, "Sets the gain of Low EQ," on page 176	-15.0...+15.0dB
	Pre HEQ Gain [dB] Table, "Sets the gain of High EQ," on page 176	-15.0...+15.0dB
f	Wet/Dry Table, "Sets the balance between the effect and dry sounds," on page 175	Dry, 1:99...99:1, Wet
	Src Table, "Selects the modulation source of the effect balance," on page 175	Off...Tempo
	Amt Table, "Sets the modulation amount of the effect balance," on page 175	-100...+100

a: Type
This parameter selects the decay curve for the early reflection.

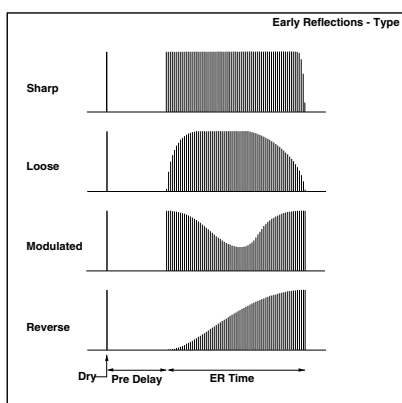

042: AutoReverse
(Auto Reverse)

This effect records the input signal and automatically plays it in reverse (the effect is similar to a tape reverse sound).

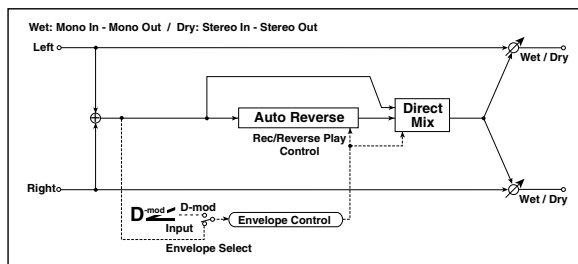

a	Rec Mode Sets the recording mode	Single, Multi
b	Reverse Time [msec] Sets the maximum duration of the reverse playback	20...1320msec
c	Envelope Select Selects whether the start and end of recording is controlled via the modulation source or the input signal level	D-mod, Input
	Src Selects the modulation source that controls recording when Envelope Select is set to D-mod	Off...Tempo
d	Threshold Sets the recording start level when Envelope Select is set to Input	0...100
e	Response Sets the speed of the response to the end of recording	0...100 Fx:031
f	Direct Mix Selects how a dry sound is mixed	Always On, Always Off, Cross Fade Fx:031
g	Wet/Dry Table, "Sets the balance between the effect and dry sounds," on page 175	Dry, 1:99...99:1, Wet
	Src Table, "Selects the modulation source of the effect balance," on page 175	Off...Tempo
	Amt Table, "Sets the modulation amount of the effect balance," on page 175	-100...+100

a: Rec Mode, b: Reverse Time

When "Rec Mode" is set to **Single**, you can set up to 1320msec for "Reverse Time." If recording starts during the reverse playback, the playback will be interrupted. When "Rec Mode" is set to **Multi**, you can make another recording during the reverse playback. However, the maximum Reverse Time is limited to 660msec.

If you wish to record a phrase or rhythm pattern, set "Rec Mode" to **Single**. If you record only one note, set "Rec Mode" to **Multi**.

The "Reverse Time" parameter specifies the maximum duration of the reverse playback. The part in excess of this limit will not be played in reverse. If you wish to add short pieces of the reverse playback of single notes, make the "Reverse Time" shorter.

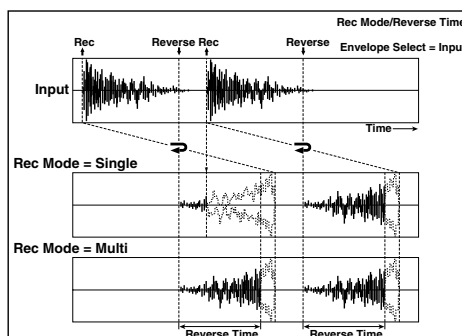

c: Envelope Select, c: Src, d: Threshold

These parameters select the source to control the start and end of recording.

When "Envelope Select" is set to **D-mod**, the input signal will be recorded only when the value of the modulation source selected by the Src parameter is 64 or higher.

When "Envelope Select" is set to **Input**, the input signal will be recorded only when its level exceeds the Threshold level.

When recording is completed, reverse playback starts immediately.

043: L/C/R Delay

This multitap delay outputs three Tap signals to the left, right, and center respectively. You can also adjust the left and right spread of the delay sound.

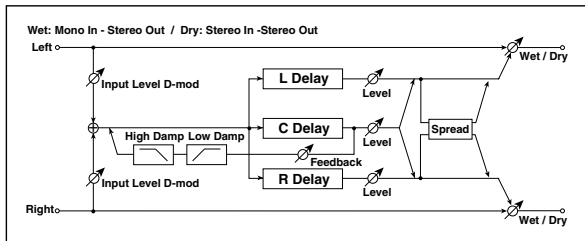

a	L Delay Time [msec] Sets the delay time of TapL	0...1360msec
	Level Sets the output level of TapL	0...50
b	C Delay Time [msec] Sets the delay time of TapC	0...1360msec
	Level Sets the output level of TapC	0...50
c	R Delay Time [msec] Sets the delay time of TapR	0...1360msec
	Level Sets the output level of TapR	0...50
d	Feedback (C Delay) Sets the feedback amount of TapC	-100...+100 D ^{mod}
	Src Selects the modulation source of the TapC feedback amount	Off...Tempo
	Amt Sets the modulation amount of the TapC feedback amount	-100...+100
e	High Damp [%] Sets the damping amount in the high range	0...100% Fx:043
	Low Damp [%] Sets the damping amount in the low range	0...100% Fx:043
f	Input Level Dmod [%] Sets the modulation amount of the input level	-100...+100 Fx:037, D ^{mod}
	Src Selects the modulation source for the input level	Off...Tempo Fx:037
g	Spread Sets the width of the stereo image of the effect sound	0...50 Fx:043
h	Wet/Dry Dry, 1:99...99:1, Wet Table, "Sets the balance between the effect and dry sounds," on page 175	D ^{mod}
	Src Table, "Selects the modulation source of the effect balance," on page 175	Off...Tempo
	Amt Table, "Sets the modulation amount of the effect balance," on page 175	-100...+100

e: High Damp [%], e: Low Damp [%]

These parameters set the damping amount of high range and low range. The tone of the delayed sound becomes darker and lighter as it feeds back.

g: Spread

This parameter sets the pan width of the effect sound. The stereo image is widest with a value of **50**, and the effect sound of both channels is output from the center with a value of **0**.

044: Cross Delay

(Stereo/Cross Delay)

This is a stereo delay, and can be used as a cross-feedback effect in which the delay sounds cross over between the left and right by changing the feedback routing.

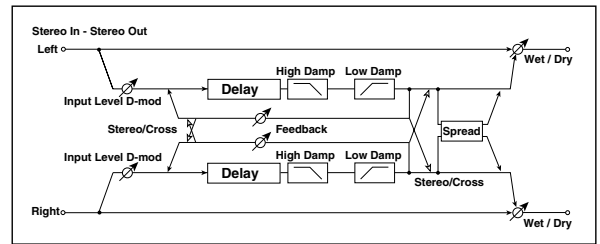

a	Stereo/Cross Switches between stereo delay and cross-feedback delay	Stereo, Cross
b	L Delay Time [msec] Sets the delay time for the left channel	0.0...680.0msec
c	R Delay Time [msec] Sets the delay time for the right channel	0.0...680.0msec
d	L Feedback Sets the feedback amount for the left channel	-100...+100 D ^{mod}
	Src Selects the modulation source of feedback amount	Off...Tempo
	Amt L Sets the modulation amount of the left channel feedback	-100...+100
e	R Feedback Sets the feedback amount for the right channel	-100...+100 D ^{mod}
	Amt R Sets the modulation amount of the right channel feedback	-100...+100
f	High Damp [%] Sets the damping amount in the high range	0...100% Fx:043
g	Low Damp [%] Sets the damping amount in the low range	0...100% Fx:043
h	Input Level Dmod [%] Sets the modulation amount of the input level	-100...+100 Fx:037, D ^{mod}
	Src Selects the modulation source for the input level	Off...Tempo Fx:037
i	Spread Sets the width of the stereo image of the effect sound	-50...+50 Fx:043
j	Wet/Dry Dry, 1:99...99:1, Wet Table, "Sets the balance between the effect and dry sounds," on page 175	D ^{mod}
	Src Table, "Selects the modulation source of the effect balance," on page 175	Off...Tempo
	Amt Table, "Sets the modulation amount of the effect balance," on page 175	-100...+100

045: M.Tap Delay
(Stereo Multitap Delay)

The left and right Multitap Delays have two taps respectively. Changing the routing of feedback and tap output allows you to create various patterns of complex effect sounds.

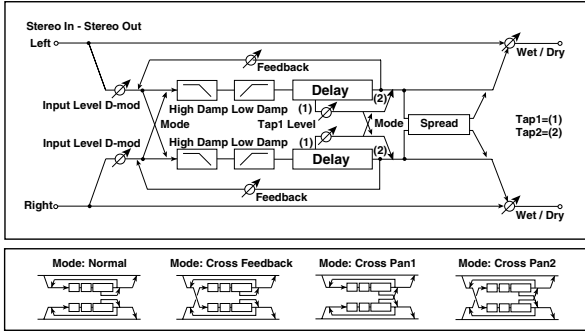

a	Mode Switches the left and right delay routing	Normal, Cross Feedback, Cross Pan1, Cross Pan2
b	Tap1 Time [msec] Sets the Tap1 delay time	0.0...680.0msec
c	Tap2 Time [msec] Sets the Tap2 delay time	0.0...680.0msec
d	Tap1 Level Sets the Tap1 output level	0...100
e	Feedback (Tap2) Sets the Tap2 feedback amount	-100...+100
	Src Selects the modulation source of the Tap2 feedback amount	Off...Tempo
f	Amt Sets the modulation amount of the Tap2 feedback amount	-100...+100
	High Damp [%] Sets the damping amount in the high range	0...100% Fx:043
g	Low Damp [%] Sets the damping amount in the low range	0...100% Fx:043
	Input Level Dmod [%] Sets the modulation amount of the input level	-100...+100 Fx:037, D-mod
h	Src Selects the modulation source for the input level	Off...Tempo Fx:037
	Spread Sets the width of the stereo image of the effect sound	-100...+100 Fx:043, D-mod
i	Src Selects the modulation source of the effect sound's stereo image width	Off...Tempo
	Amt Sets the modulation amount of the effect sound's stereo image width	-100...+100
j	Wet/Dry Table, "Sets the balance between the effect and dry sounds," on page 175	Dry, 1:99...99:1, Wet
	Src Table, "Selects the modulation source of the effect balance," on page 175	Off...Tempo
	Amt Table, "Sets the modulation amount of the effect balance," on page 175	-100...+100

a: Mode

You can change how the left and right delay signals are panned by modifying the routing of the left and right delay as shown in the figure above. You need to input different sounds to each channel in order for this parameter to be effective.

d: Tap1 Level

This parameter sets the output level of Tap1. Setting a different level from Tap2 will add a unique touch to a monotonous delay and feedback.

046: Modul.Delay
(Stereo Modulation Delay)

This stereo delay uses an LFO to sweep the delay time. The pitch also varies. You will obtain a delay sound with swell and shimmering. You can also control the delay time using a modulation source.

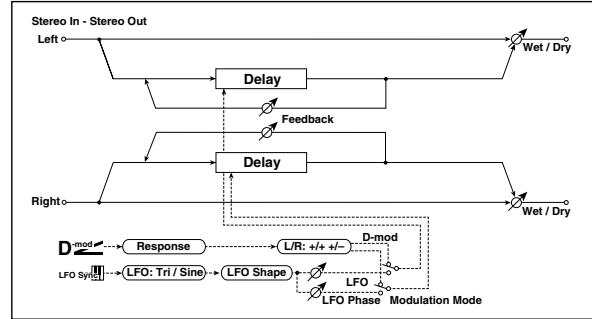

a	Modulation Mode Switches between LFO modulation control and modulation source control	LFO, D-mod L/R: +/+, L/R: +/-
b	D-mod Modulation Reversed L/R control by modulation source	L/R: +/+, L/R: +/- D-mod
	Src Selects the modulation source that controls delay time	Off...Tempo
c	Response Sets the rate of response to the modulation source	0...30
	LFO Waveform Selects LFO Waveform	Triangle, Sine
d	LFO Shape Determines how much the LFO waveform is changed	-100...+100 Fx:020
	LFO Frequency [Hz] Sets the LFO speed	0.02...20.00Hz
e	LFO Sync Switches LFO reset off/on	Off, On D-mod
	Src Selects the modulation source that resets the LFO	Off...Tempo
f	L LFO Phase [degree] Sets the phase obtained when the left LFO is reset	-180...+180 Fx
	R LFO Phase [degree] Sets the phase obtained when the right LFO is reset	-180...+180 Fx
g	L Depth Sets the depth of the left LFO modulation	0...200
	R Depth Sets the depth of the right LFO modulation	0...200
h	L Delay Time [msec] Sets the left delay time	0.0...500.0
	R Delay Time [msec] Sets the right delay time	0.0...500.0
i	L Feedback Sets the feedback amount of left delay	-100...+100
	R Feedback Sets the feedback amount of right delay	-100...+100
j	Wet/Dry Table, "Sets the balance between the effect and dry sounds," on page 175	-Wet...-1:99, Dry, 1:99...Wet Fx:010, D-mod
	Src Table, "Selects the modulation source of the effect balance," on page 175	Off...Tempo
	Amt Table, "Sets the modulation amount of the effect balance," on page 175	-100...+100

b: D-mod Modulation

When the modulation source is used for control, this parameter reverses the left and right modulation direction.

e: LFO Sync, e: Src,

f: L LFO Phase [degree], f: R LFO Phase [degree]

The LFO can be reset via a modulation source.

The "Src" parameter sets the modulation source that resets the LFO. For example, you can assign Gate as a modulation source so that the sweep always starts from the specified point.

"L LFO Phase" and "R LFO Phase" set the phase obtained when the left and right LFOs are reset. In this way, you can create changes in pitch sweep for the left and right channels individually.

MDI The effect is off when a value of the modulation source specified in the "Src" parameter is 63 or smaller, and the effect is on when the value is 64 or higher. The LFO is triggered and reset to the "L LFO Phase" and "R LFO Phase" settings when the value changes from 63 or smaller to 64 or higher.

047: Dynam.Delay (Stereo Dynamic Delay)

This stereo delay controls the level of delay according to the input signal level. You can use this as a ducking delay that applies delay to the sound only when you play keys at a high velocity or only when the volume level is low.

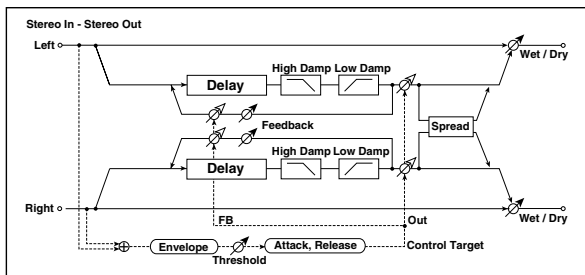

a	Control Target Selects from no control, output, and feedback	None, Out, FB Fx:043
	Polarity Reverses level control	+, - Fx:043
b	Threshold Sets the level to which the effect is applied	0...100 Fx:043
	Offset Sets the offset of level control	0...100 Fx:043
c	Attack Sets the attack time of level control	1...100 Fx:043
d	Release Sets the release time of level control	1...100 Fx:043
e	L Delay Time [msec] Sets the delay time for the left channel	0.0...680.0msec
f	R Delay Time [msec] Sets the delay time for the right channel	0.0...680.0msec
g	Feedback Sets the feedback amount	-100...+100

h	High Damp [%] Sets the damping amount in the high range	0...100% Fx:043
	Low Damp [%] Sets the damping amount in the low range	0...100% Fx:043
i	Spread Sets the width of the stereo image of the effect sound	-100...+100 Fx:043
j	Wet/Dry Table, "Sets the balance between the effect and dry sounds," on page 175	Dry, 1:99...99:1, Wet
	Src Table, "Selects the modulation source of the effect balance," on page 175	Off...Tempo
	Amt Table, "Sets the modulation amount of the effect balance," on page 175	-100...+100

a: Control Target

This parameter selects no level control, delay output control (effect balance), or feedback amount control.

a: Polarity, b: Threshold, b: Offset, c: Attack, d: Release

The "Offset" parameter specifies the value for the "Control Target" parameter (that is set to None), expressed as the ratio relative to the parameter value (the "Wet/Dry" value with "Control Target"=Out, or the "Feedback" value with "Control Target"=FB).

When "Polarity" is **positive**, the "Control Target" value is obtained by multiplying the parameter value by the "Offset" value (if the input level is below the threshold), or equals the parameter value if the input level exceeds the threshold.

When "Polarity" is **negative**, Control Target value equals the parameter value if the input level is below the threshold, or is obtained by multiplying the parameter value by the "Offset" value if the level exceeds the threshold.

The "Attack" and "Release" parameters specify attack time and release time of delay level control.

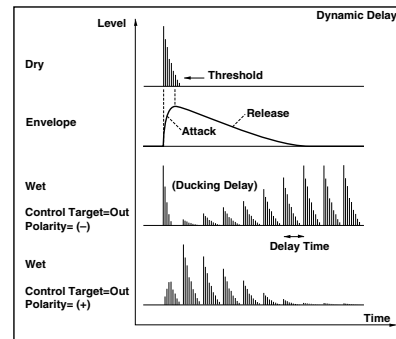

048: AutoPan Dly
(Stereo Auto Panning Delay)

This stereo delay effect pans the delay sound left and right using the LFO.

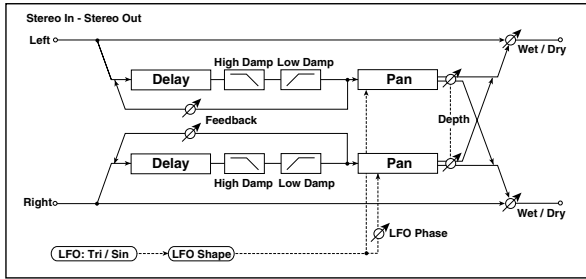

a	L Delay Time [msec] Sets the delay time for the left channel	0.0...680.0msec
	L Feedback Sets the feedback amount for the left channel	-100...+100
b	R Delay Time [msec] Sets the delay time for the right channel	0.0...680.0msec
	R Feedback Sets the feedback amount for the right channel	-100...+100
c	High Damp [%] Sets the damping amount in the high range	0...100% Fx:043
	Low Damp [%] Sets the damping amount in the low range	0...100% Fx:043
d	LFO Waveform Selects LFO Waveform	Triangle, Sine
	LFO Shape Determines how much the LFO waveform is changed	-100...+100 Fx:020
e	LFO Phase [degree] Sets the LFO phase difference between the left and right	-180...+180 Fx:034
f	Panning Frequency [Hz] Sets the panning speed	0.02...20.00Hz
g	Panning Depth Sets the panning width	0...100 D ^{mod}
	Src Selects the modulation source for the panning width	Off...Tempo
	Amt Set the modulation amount of the panning width	-100...+100
h	Wet/Dry Dry, 1:99...99:1, Wet Table, "Sets the balance between the effect and dry sounds," on page 175 D ^{mod}	
	Src Table, "Selects the modulation source of the effect balance," on page 175	Off...Tempo
	Amt Table, "Sets the modulation amount of the effect balance," on page 175	-100...+100

049: LCR BPM Dly

The L/C/R delay enables you to match the delay time with the song tempo. You can also synchronize the delay time with the arpeggiator or sequencer. If you program the tempo before performance, you can achieve a delay effect that synchronizes with the song in real-time. Delay time is set by notes.

Note: With extreme values, the sync may be lost.

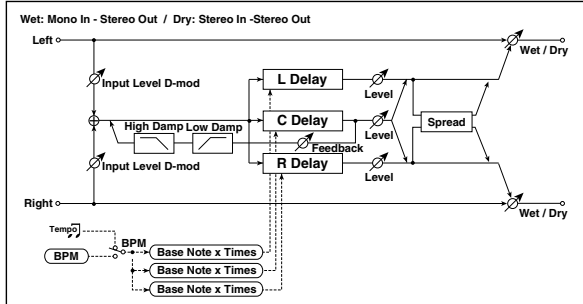

a	BPM Selects MIDI Clock and assigns tempo	MIDI, 40...240 ES Sync
b	L Delay Base Note Selects the type of notes to specify the delay time for TapL	ES Sync
	Times Sets the number of notes to specify the delay time for TapL	x1...x16 ES
c	C Delay Base Note Selects the type of notes to specify the delay time for TapC	ES Sync
	Times Sets the number of notes to specify the delay time for TapC	x1...x16 ES
d	R Delay Base Note Selects the type of notes to specify the delay time for TapR	ES Sync
	Times Sets the number of notes to specify the delay time for TapR	x1...x16 ES
e	Feedback (C Delay) Sets the feedback amount of TapC	-100...+100 D-mod
	Src Selects the modulation source for the TapC feedback	Off...Tempo
	Amt Sets the modulation amount of the TapC feedback	-100...+100
f	High Damp [%] Sets the damping amount in the high range	0...100% ES Fx:043
	Low Damp [%] Sets the damping amount in the low range	0...100% ES Fx:043
g	Input Level Dmod [%] Sets the modulation amount of the input level	-100...+100 ES Fx:037, D-mod
	Src Selects the modulation source for the input level	Off...Tempo ES Fx:037
h	Spread Sets the width of the stereo image of the effect sound	0...50 ES Fx:043
i	Wet/Dry Dry, 1:99...99:1, Wet Table, "Sets the balance between the effect and dry sounds," on page 175	D-mod
	Src Table, "Selects the modulation source of the effect balance," on page 175	Off...Tempo
	Amt Table, "Sets the modulation amount of the effect balance," on page 175	-100...+100

a: BPM, b: L Delay Base Note, b: Times, c: C Delay Base Note,

c: Times, d: R Delay Base Note, d: Times

The delay time is the length of the note obtained by multiplying the "Base Note" parameter by the Times value, in relation to the tempo specified by the "BPM" parameter (or the MIDI Clock tempo if "BPM" is set to MIDI).

050: BPM Delay

(Stereo BPM Delay)

This stereo delay enables you to set the delay time to match the song tempo.

Note: With extreme values, the sync may be lost.

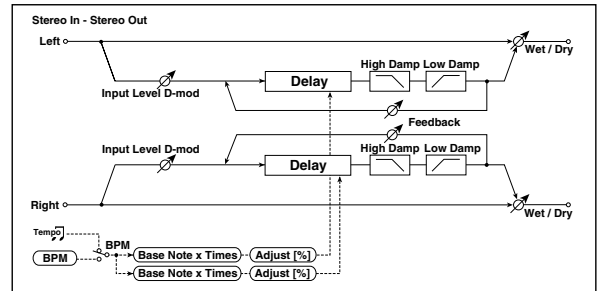

a	BPM Selects MIDI Clock and assigns tempo	MIDI, 40...240 ES Sync
b	L Delay Base Note Selects the type of notes to specify the left channel delay time	ES Sync
	Times Sets the number of notes to specify the left channel delay time	x1...x16 ES Fx:049
c	R Delay Base Note Selects the type of notes to specify the right channel delay time	ES Sync
	Times Sets the number of notes to specify the right channel delay time	x1...x16 ES Fx:049
d	Adjust [%] Fine-adjust the left channel delay time	-2.50...+2.50%
	Adjust [%] Fine-adjust the right channel delay time	-2.50...+2.50%
e	R Feedback Sets the feedback amount for the right channel	-100...+100 D-mod
	Amt R Sets the modulation amount of the right channel feedback	-100...+100
f	L Feedback Sets the feedback amount for the left channel	-100...+100 D-mod
	Amt L Sets the modulation amount of the left channel feedback	-100...+100
g	High Damp [%] Sets the damping amount in the high range	0...100% ES Fx:043
	Low Damp [%] Sets the damping amount in the low range	0...100% ES Fx:043
h	Input Level Dmod [%] Sets the modulation amount of the input level	-100...+100 ES Fx:037, D-mod
	Src Selects the modulation source for the input level	Off...Tempo ES Fx:037
i	Wet/Dry Dry, 1:99...99:1, Wet Table, "Sets the balance between the effect and dry sounds," on page 175	D-mod
	Src Table, "Selects the modulation source of the effect balance," on page 175	Off...Tempo
	Amt Table, "Sets the modulation amount of the effect balance," on page 175	-100...+100

051: Seq. Delay (Sequential Delay)

This four-tap delay enables you to select a tempo and rhythm pattern to set up each tap.

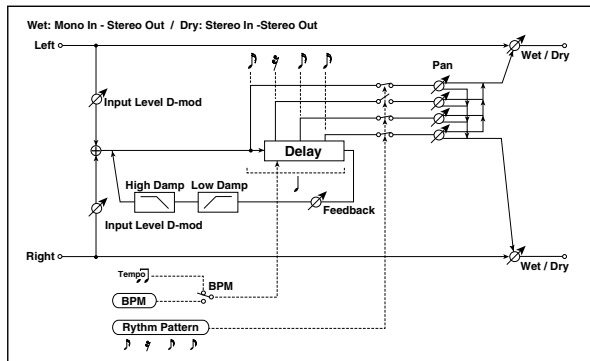

a	BPM Selects MIDI Clock and assigns tempo	MIDI, 44...240 Sync
b	Rhythm Pattern Selects a rhythm pattern	3 Sync
c	Tap1 Pan Sets the panning of Tap1	L, 1...99, R
	Tap2 Pan Sets the panning of Tap2	L, 1...99, R
	Tap3 Pan Sets the panning of Tap3	L, 1...99, R
	Tap4 Pan Sets the panning of Tap4	L, 1...99, R
d	Feedback Sets the feedback amount	-100...+100 D-mod
	Src Selects the modulation source of feedback amount	Off...Tempo
	Amt Sets the modulation amount of the feedback	-100...+100
e	High Damp [%] Sets the damping amount in the high range	0...100% Fx:043
	Low Damp [%] Sets the damping amount in the low range	0...100% Fx:043
f	Input Level Dmod [%] Sets the modulation amount of the input level	-100...+100 Fx:037, D-mod
	Src Selects the modulation source for the input level	Off...Tempo Fx:037
	Wet/Dry Table, "Sets the balance between the effect and dry sounds," on page 175 D-mod	Dry, 1:99...99:1, Wet
g	Src Table, "Selects the modulation source of the effect balance," on page 175	Off...Tempo
	Amt Table, "Sets the modulation amount of the effect balance," on page 175	-100...+100

a: BPM, b: Rhythm Pattern

With the tempo specified by the "BPM" parameter (or the MIDI Clock tempo if "BPM" is set to MIDI), the length of one beat equals the feedback delay time, and the interval between taps becomes equal. Selecting a rhythm pattern will automatically turn the tap outputs on and off. When "BPM" is set to MIDI, the lower limit of the "BPM" is 44.

REVERB

Reverb effects

These effects simulate the ambience of reverberation in concert halls.

052: Rev. Hall

This hall-type reverb simulates the reverberation of mid-size concert halls or ensemble halls.

053: RevSmthHall (Smooth Hall)

This hall-type reverb simulates the reverberation of larger halls and stadiums, and creates a smooth release.

054: RevWetPlate

This plate reverb simulates warm (dense) reverberation.

055: RevDryPlate

This plate reverb simulates dry (light) reverberation.

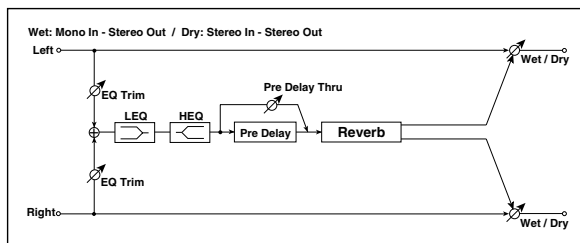

a	Reverb Time [sec] Sets the reverberation time	0.1...10.0sec
	High Damp [%] Sets the damping amount in the high range	0...100%
b	Pre Delay [msec] Sets the delay time from the dry sound	0...200msec Sync
	Pre Delay Thru [%] Sets the mix ratio of non-delay sound	0...100% Sync
c	EQ Trim Table, "Sets the EQ input level," on page 176	0...100
d	Pre LEQ Gain [dB] Table, "Sets the gain of Low EQ," on page 176	-15...+15dB
	Pre HEQ Gain [dB] Table, "Sets the gain of High EQ," on page 176	-15...+15dB
e	Wet/Dry Table, "Sets the balance between the effect and dry sounds," on page 175 D-mod	Dry, 1:99...99:1, Wet
	Src Table, "Selects the modulation source of the effect balance," on page 175	Off...Tempo
	Amt Table, "Sets the modulation amount of the effect balance," on page 175	-100...+100

b: Pre Delay [msec], b: Pre Delay Thru [%]

The "Pre Delay" sets the delay time to the reverb input, allowing you to control spaciousness. Using the "Pre Delay Thru" parameter, you can mix the dry sound without delay, emphasizing the attack of the sound.

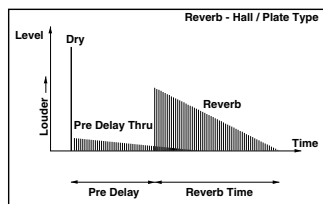

056: Rev. Room

This room-type reverb emphasizes the early reflections that make the sound tighter. Changing the balance between the early reflections and reverb sound allows you to simulate nuances, such as the type of walls of a room.

057: R.BriteRoom

This room-type reverb emphasizes the early reflections that make the sound brighter. See 056: Reverb Room.

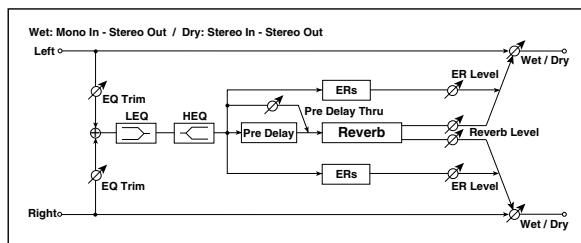

a	Reverb Time [sec] Sets the reverberation time	0.1...3.0sec
	High Damp [%] Sets the damping amount in the high range	0...100%
b	Pre Delay [msec] Sets the delay time from the dry sound	0...200msec Fx:052
	Pre Delay Thru [%] Sets the mix ratio of non-delay sound	0...100% Fx:052
c	ER Level Sets the level of early reflections	0...100 Fx:052
d	Reverb Level Sets the reverberation level	0...100 Fx:052
e	EQ Trim Table, "Sets the EQ input level," on page 176	0...100
f	Pre LEQ Gain [dB] Table, "Sets the gain of Low EQ," on page 176	-15...+15dB
	Pre HEQ Gain [dB] Table, "Sets the gain of High EQ," on page 176	-15...+15dB
g	Wet/Dry Dry, 1:99...99:1, Wet Table, "Sets the balance between the effect and dry sounds," on page 175	
	Src Table, "Selects the modulation source of the effect balance," on page 175	Off...Tempo
	Amt Table, "Sets the modulation amount of the effect balance," on page 175	-100...+100

c: ER Level, d: Reverb Level

These parameters set the early reflection level and reverb level.

Changing these parameter values allows you to simulate the type of walls in the room. That is, a larger "ER Level" simulates a hard wall, and a larger "Reverb Level" simulates a soft wall.

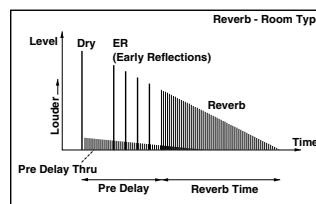

MONO - MONO CHAIN

Effects that combine two mono effects connected in series

058: Par4Eq-Exc

(Parametric 4-Band EQ - Exciter)

This effect combines a mono-type four-band parametric equalizer and an exciter.

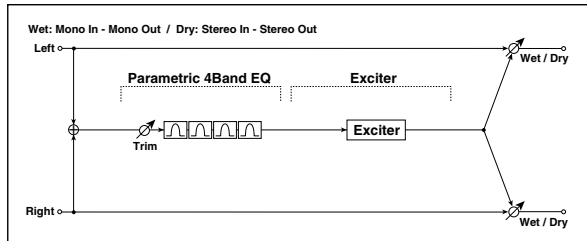

a	[E] Trim Sets the parametric EQ input level	0...100
b	[E] Band1 Cutoff [Hz] Sets the center frequency of Band 1	20...1.00kHz
	Q Sets the bandwidth of Band 1	0.5...10.0 Fx:006
	Gain [dB] Sets the gain of Band 1	-18...+18dB
c	[E] Band2 Cutoff [Hz] Sets the center frequency of Band 2	50...5.00kHz
	Q Sets the bandwidth of Band 2	0.5...10.0 Fx:006
	Gain [dB] Sets the gain of Band 2	-18...+18dB
d	[E] Band3 Cutoff [Hz] Sets the center frequency for Band 3	300...10.00kHz
	Q Sets the bandwidth of Band 3	0.5...10.0 Fx:006
	Gain [dB] Sets the gain of Band 3	-18...+18dB
e	[E] Band4 Cutoff [Hz] Sets the center frequency for Band 4	500...20.00kHz
	Q Sets the bandwidth of Band 4	0.5...10.0 Fx:006
	Gain [dB] Sets the gain of Band 4	-18...+18dB
f	[X] Exciter Blend Sets the intensity (depth) of the Exciter effect	-100...+100 Fx:011
g	[X] Emphatic Point Sets the frequency range to be emphasized	0...70 Fx:011
h	Wet/Dry Dry, 1:99...99:1, Wet Table , "Sets the balance between the effect and dry sounds," on page 175	
	Src Off...Tempo Table , "Selects the modulation source of the effect balance," on page 175	
	Amt -100...+100 Table , "Sets the modulation amount of the effect balance," on page 175	

059: Par4Eq-Wah

(Parametric 4-Band EQ - Wah/Auto Wah)

This effect combines a mono-type four-band parametric equalizer and a wah. You can change the order of the connection.

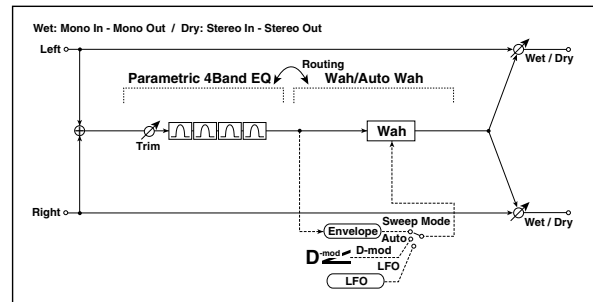

a	[E] Trim Sets the parametric EQ input level	0...100
b	[E] Band1 Cutoff [Hz] Sets the center frequency of Band 1	20...1.00kHz
	Q Sets the bandwidth of Band 1	0.5...10.0 Fx:006
	Gain [dB] Sets the gain of Band 1	-18...+18dB
c	[E] Band2 Cutoff [Hz] Sets the center frequency of Band 2	50...5.00kHz
	Q Sets the bandwidth of Band 2	0.5...10.0 Fx:006
	Gain [dB] Sets the gain of Band 2	-18...+18dB
d	[E] Band3 Cutoff [Hz] Sets the center frequency for Band 3	300...10.00kHz
	Q Sets the bandwidth of Band 3	0.5...10.0 Fx:006
	Gain [dB] Sets the gain of Band 3	-18...+18dB
e	[E] Band4 Cutoff [Hz] Sets the center frequency for Band 4	500...20.00kHz
	Q Sets the bandwidth of Band 4	0.5...10.0 Fx:006
	Gain [dB] Sets the gain of Band 4	-18...+18dB
f	[W] Frequency Bottom Sets the lower limit of the wah center frequency	0...100 Fx:009
	Frequency Top Sets the upper limit of the wah center frequency	0...100 Fx:009
g	[W] Sweep Mode Auto, D-mod, LFO Selects the control from auto-wah, modulation source, and LFO	Fx:009, D-mod
	Src Off...Tempo Selects the modulation source for the wah when Sweep Mode=D-mod	
h	[W] LFO Frequency [Hz] Sets the LFO speed	0.02...20.00Hz
	Resonance Sets the resonance amount	0...100
	LPF Switches the wah low pass filter on and off	Off, On
i	Routing PEQ → WAH, WAH → PEQ Changes the order of the parametric equalizer and wah connection	
j	Wet/Dry Dry, 1:99...99:1, Wet Table , "Sets the balance between the effect and dry sounds," on page 175	
	Src Off...Tempo Table , "Selects the modulation source of the effect balance," on page 175	
	Amt -100...+100 Table , "Sets the modulation amount of the effect balance," on page 175	

060: 4EqPhsrChFI (Parametric 4-Band EQ – Chorus/Flanger)

This effect combines a mono-type four-band parametric equalizer and a chorus/flanger.

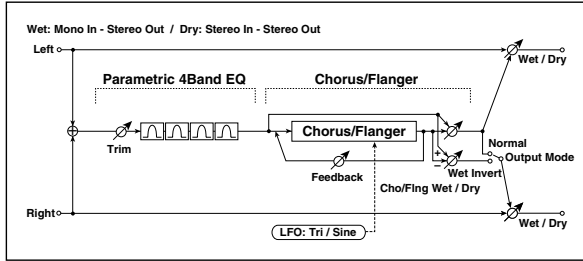

a	[E] Trim Sets the parametric EQ input level	0...100
b	[E] Band1 Cutoff [Hz] Sets the center frequency of Band 1	20...1.00kHz
	Q Sets the bandwidth of Band 1	0.5...10.0 Fx:006
	Gain [dB] Sets the gain of Band 1	-18...+18dB
c	[E] Band2 Cutoff [Hz] Sets the center frequency of Band 2	50...5.00kHz
	Q Sets the bandwidth of Band 2	0.5...10.0 Fx:006
	Gain [dB] Sets the gain of Band 2	-18...+18dB
d	[E] Band3 Cutoff [Hz] Sets the center frequency for Band 3	300...10.00kHz
	Q Sets the bandwidth of Band 3	0.5...10.0 Fx:006
	Gain [dB] Sets the gain of Band 3	-18...+18dB
e	[E] Band4 Cutoff [Hz] Sets the center frequency for Band 4	500...20.00kHz
	Q Sets the bandwidth of Band 4	0.5...10.0 Fx:006
	Gain [dB] Sets the gain of Band 4	-18...+18dB
f	[F] Delay Time [msec] Sets the delay time	0.0...50.0msec
g	[F] LFO Frequency [Hz] Sets the LFO speed	0.02...20.00Hz
	LFO Waveform Selects LFO Waveform	Triangle, Sine
h	[F] Depth Sets the depth of LFO modulation	0...100
	Feedback Sets the feedback amount	-100...+100 Fx:020
i	[F] Cho/Flng Wet/Dry Sets the effect balance of the chorus/flanger	-Wet...-2:98, Dry, 2:98...Wet Fx:010, 020
	Output Mode Selects the output mode for the chorus/flanger	Normal, Wet Invert Fx:
j	Wet/Dry Dry, 1:99...99:1, Wet Table, "Sets the balance between the effect and dry sounds," on page 175	
	Src Off...Tempo Table, "Selects the modulation source of the effect balance," on page 175	
	Amt -100...+100 Table, "Sets the modulation amount of the effect balance," on page 175	

i: Output Mode

When **Wet Invert** is selected, the right channel phase of the chorus/flanger effect sound is inverted. This creates pseudo-stereo effects and adds spread.

However, if a mono-input type effect is connected after this effect, the left and right sounds may cancel each other, eliminating the chorus/flanger effects.

061: Par4Eq-Phsr (Parametric 4-Band EQ – Phaser)

This effect combines a mono-type four-band parametric equalizer and a phaser.

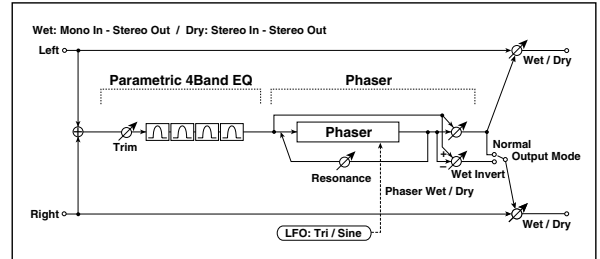

a	[E] Trim Sets the parametric EQ input level	0...100
b	[E] Band1 Cutoff [Hz] Sets the center frequency of Band 1	20...1.00kHz
	Q Sets the bandwidth of Band 1	0.5...10.0 Fx:006
	Gain [dB] Sets the gain of Band 1	-18...+18dB
c	[E] Band2 Cutoff [Hz] Sets the center frequency of Band 2	50...5.00kHz
	Q Sets the bandwidth of Band 2	0.5...10.0 Fx:006
	Gain [dB] Sets the gain of Band 2	-18...+18dB
d	[E] Band3 Cutoff [Hz] Sets the center frequency for Band 3	300...10.00kHz
	Q Sets the bandwidth of Band 3	0.5...10.0 Fx:006
	Gain [dB] Sets the gain of Band 3	-18...+18dB
e	[E] Band4 Cutoff [Hz] Sets the center frequency for Band 4	500...20.00kHz
	Q Sets the bandwidth of Band 4	0.5...10.0 Fx:006
	Gain [dB] Sets the gain of Band 4	-18...+18dB
f	[P] LFO Frequency [Hz] Sets the LFO speed	0.02...20.00Hz
	LFO Waveform Selects LFO Waveform	Triangle, Sine
g	[P] Manual Sets the frequency to which the effect is applied	0...100
h	[P] Depth Sets the depth of LFO modulation	0...100
	Resonance Sets the resonance amount	-100...+100 Fx:023
i	[P] Phaser Wet/Dry Sets the phaser effect balance	-Wet...-2:98, Dry, 2:98...Wet Fx:010, 023
	Output Mode Selects the phaser output mode	Normal, Wet Invert Fx:060
j	Wet/Dry Dry, 1:99...99:1, Wet Table, "Sets the balance between the effect and dry sounds," on page 175	
	Src Off...Tempo Table, "Selects the modulation source of the effect balance," on page 175	
	Amt -100...+100 Table, "Sets the modulation amount of the effect balance," on page 175	

062: P4Eq-TapDly
(Parametric 4-Band EQ – Multitap Delay)

This effect combines a mono-type four-band parametric equalizer and a multitap delay.

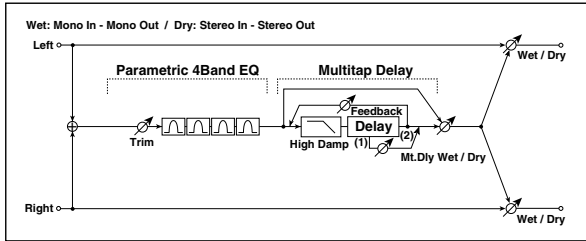

a	[E] Trim Sets the parametric EQ input level	0...100
b	[E] Band1 Cutoff [Hz] Sets the center frequency of Band 1	20...1.00kHz
	Q Sets the bandwidth of Band 1	0.5...10.0 Fx:006
	Gain [dB] Sets the gain of Band 1	-18...+18dB
c	[E] Band2 Cutoff [Hz] Sets the center frequency of Band 2	50...5.00kHz
	Q Sets the bandwidth of Band 2	0.5...10.0 Fx:006
	Gain [dB] Sets the gain of Band 2	-18...+18dB
d	[E] Band3 Cutoff [Hz] Sets the center frequency for Band 3	300...10.00kHz
	Q Sets the bandwidth of Band 3	0.5...10.0 Fx:006
	Gain [dB] Sets the gain of Band 3	-18...+18dB
e	[E] Band4 Cutoff [Hz] Sets the center frequency for Band 4	500...20.00kHz
	Q Sets the bandwidth of Band 4	0.5...10.0 Fx:006
	Gain [dB] Sets the gain of Band 4	-18...+18dB
f	[D] Tap1 Time [msec] Sets the Tap1 delay time	0...680msec
	Tap1 Level Sets the Tap1 output level	0...100 Fx:045
g	[D] Tap2 Time [msec] Sets the Tap2 delay time	0...680msec
	Feedback Sets the Tap2 feedback amount	-100...+100
h	[D] Mt.Delay Wet/DryDry, 2:98...98:2, Wet Sets the multitap delay effect balance	
	High Damp [%] Sets the damping amount in the high range	0...100% Fx:043
i	Wet/DryDry, 1:99...99:1, Wet Table , "Sets the balance between the effect and dry sounds," on page 175	
	SrcOff...Tempo Table , "Selects the modulation source of the effect balance," on page 175	
	Amt Table , "Sets the modulation amount of the effect balance," on page 175	-100...+100

063: Cmp-AutoWah
(Compressor – Wah/Auto Wah)

This effect combines a mono-type compressor and a wah. You can change the order of the connection.

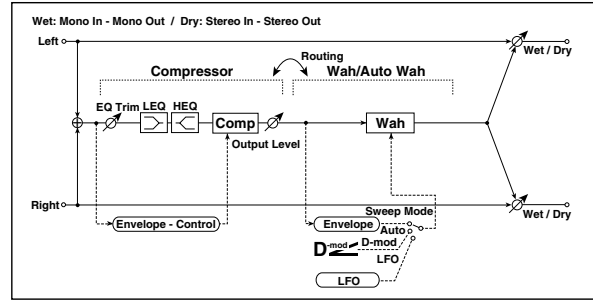

a	[C] Sensitivity Sets the sensitivity	1...100 Fx:002
b	[C] Attack Table , "Sets the attack level," on page 176	1...100 Fx:002
	Output Level Sets the compressor output level	0...100 Fx:002
c	[C] EQ Trim Table , "Sets the EQ input level," on page 176	0...100
d	[C] Pre LEQ Gain [dB] Table , "Sets the gain of Low EQ," on page 176	-15...+15dB
	Pre HEQ Gain [dB] Table , "Sets the gain of High EQ," on page 176	-15...+15dB
e	[W] Frequency Bottom Sets the lower limit of the wah center frequency	0...100 Fx:009
	Frequency Top Sets the upper limit of the wah center frequency	0...100 Fx:009
f	[W] Sweep Mode Selects the control from auto-wah, modulation source, and LFO	Auto, D-mod, LFO Fx:009, D-mod
	Src Selects the modulation source for the wah when Sweep Mode=D-mod	Off...Tempo
g	[W] LFO Frequency [Hz] Sets the LFO speed	0.02...20.00Hz
h	[W] Resonance Sets the resonance amount	0...100
	Low Pass Filter Switches the wah low pass filter on and off	Off, On
i	Routing Switches the order of the compressor and wah connection	CMP → WAH, WAH → CMP
j	Wet/Dry Table , "Sets the balance between the effect and dry sounds," on page 175	Dry, 1:99...99:1, Wet Fx:009, D-mod
	Src Table , "Selects the modulation source of the effect balance," on page 175	Off...Tempo
	Amt Table , "Sets the modulation amount of the effect balance," on page 175	-100...+100

064: Cmp-AmpSim (Compressor – Amp Simulation)

This effect combines a mono-type compressor and an amp simulation. You can change the order of the effect connection.

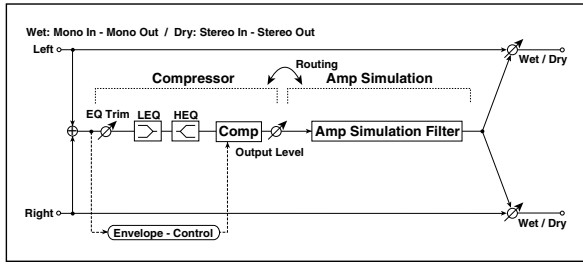

a	[C] Sensitivity Sets the sensitivity	1...100 Fx:002
b	[C] Attack Table, "Sets the attack level," on page 176	1...100 Fx:002
	Output Level Sets the compressor output level	0...100 Fx:002
c	[C] EQ Trim Table, "Sets the EQ input level," on page 176	0...100
d	[C] Pre LEQ Gain [dB] Table, "Sets the gain of Low EQ," on page 176	-15...+15dB
	Pre HEQ Gain [dB] Table, "Sets the gain of High EQ," on page 176	-15...+15dB
e	[A] Amplifier Type Selects the type of guitar amplifier	SS, EL84, 6L6
f	Routing Switches the order of the compressor and amp simulation connection	CMP → AMP, AMP → CMP
g	Wet/Dry Table, "Sets the balance between the effect and dry sounds," on page 175	Dry, 1:99...99:1, Wet D ^{mod}
	Src Table, "Selects the modulation source of the effect balance," on page 175	Off...Tempo
	Amt Table, "Sets the modulation amount of the effect balance," on page 175	-100...+100

065: Cmp-OD/HiG (Compressor – Overdrive/Hi.Gain)

This effect combines a mono-type compressor and an overdrive/high-gain distortion. You can change the order of the effect connection.

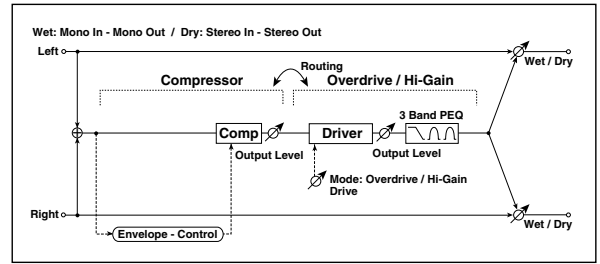

a	[C] Sensitivity Sets the sensitivity	1...100 Fx:002
b	[C] Attack Table, "Sets the attack level," on page 176	1...100 Fx:002
	Output Level Sets the compressor output level	0...100 Fx:002
c	[O] Drive Mode Switches between overdrive and high-gain distortion	Overdrive, Hi-Gain
	Drive Sets the degree of distortion	1...100 Fx:006
d	[O] Output Level Sets the overdrive output level	0...50 Fx:006, D ^{mod}
	Src Selects the modulation source for the overdrive output level	Off...Tempo
	Amt Sets the modulation amount of the overdrive output level	-50...+50
e	[O] Low Cutoff [Hz] Sets the center frequency for Low EQ (shelving type)	20...1.00kHz
	Gain [dB] Table, "Sets the gain of Low EQ," on page 176	-18...+18dB
f	[O] Mid1 Cutoff [Hz] Sets the center frequency for Mid/High EQ 1 (peaking type)	300...10.00kHz
	Q Sets the band width of Mid/High EQ 1	0.5...10.0 Fx:006
	Gain [dB] Sets the gain of Mid/High EQ 1	-18...+18dB
g	[O] Mid2 Cutoff [Hz] Sets the center frequency for Mid/High EQ 2 (peaking type)	500...20.00kHz
	Q Sets the band width of Mid/High EQ 2	0.5...10.0 Fx:006
	Gain [dB] Sets the gain of Mid/High EQ 2	-18...+18dB
h	Routing Switches the order of the compressor and overdrive connection	CMP → OD, OD → CMP
i	Wet/Dry Table, "Sets the balance between the effect and dry sounds," on page 175	Dry, 1:99...99:1, Wet D ^{mod}
	Src Table, "Selects the modulation source of the effect balance," on page 175	Off...Tempo
	Amt Table, "Sets the modulation amount of the effect balance," on page 175	-100...+100

066: Cmp-Par.4Eq
(Compressor - Parametric 4-Band EQ)

This effect combines a mono-type compressor and a four-band parametric equalizer. You can change the order of the effect connection.

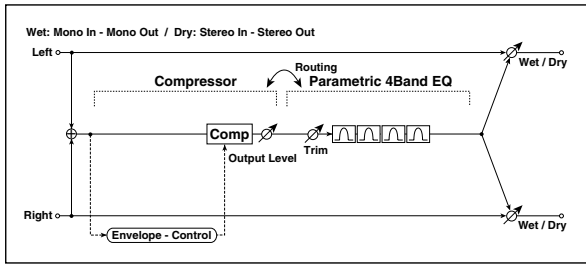

a	[C] Sensitivity Sets the sensitivity	1...100 Fx:002
b	[C] Attack Table, "Sets the attack level," on page 176	1...100 Fx:002
	Output Level Sets the compressor output level	0...100 Fx:002
c	[E] Trim Sets the parametric EQ input level	0...100
d	[E] Band1 Cutoff [Hz] Sets the center frequency of Band 1	20...1.00kHz
	Q Sets the bandwidth of Band 1	0.5...10.0 Fx:006
	Gain [dB] Sets the gain of Band 1	-18...+18dB
e	[E] Band2 Cutoff [Hz] Sets the center frequency of Band 2	50...5.00kHz
	Q Sets the bandwidth of Band 2	0.5...10.0 Fx:006
	Gain [dB] Sets the gain of Band 2	-18...+18dB
f	[E] Band3 Cutoff [Hz] Sets the center frequency for Band 3	300...10.00kHz
	Q Sets the bandwidth of Band 3	0.5...10.0 Fx:006
	Gain [dB] Sets the gain of Band 3	-18...+18dB
g	[E] Band4 Cutoff [Hz] Sets the center frequency for Band 4	500...20.00kHz
	Q Sets the bandwidth of Band 4	0.5...10.0 Fx:006
	Gain [dB] Sets the gain of Band 4	-18...+18dB
h	Routing Switches the order of the compressor and parametric EQ connection	CMP → PEQ, PEQ → CMP
i	Wet/Dry Table, "Sets the balance between the effect and dry sounds," on page 175 D ^{mod}	Dry, 1:99...99:1, Wet
	Src Table, "Selects the modulation source of the effect balance," on page 175	Off...Tempo
	Amt Table, "Sets the modulation amount of the effect balance," on page 175	-100...+100

067: Cmp-ChorFlg
(Compressor - Chorus/Flanger)

This effect combines a mono-type compressor and a chorus/flanger. You can change the order of the effect connection.

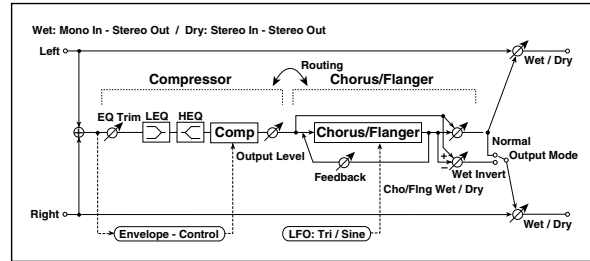

a	[C] Sensitivity Sets the sensitivity	1...100 Fx:002
b	[C] Attack Table, "Sets the attack level," on page 176	1...100 Fx:002
	Output Level Sets the compressor output level	0...100 Fx:002
c	[C] EQ Trim Table, "Sets the EQ input level," on page 176	0...100
d	[C] Pre LEQ Gain [dB] Table, "Sets the gain of Low EQ," on page 176	-15...+15dB
	Pre HEQ Gain [dB] Table, "Sets the gain of High EQ," on page 176	-15...+15dB
e	[F] Delay Time [msec] Sets the delay time	0.0...50.0msec
f	[F] LFO Frequency [Hz] Sets the LFO speed	0.02...20.00Hz
	LFO Waveform Selects LFO Waveform	Triangle, Sine
g	[F] Depth Sets the depth of LFO modulation	0...100
	Feedback Sets the feedback amount	-100...+100 Fx:020
h	[F] Cho/Fing Wet/Dry Sets the effect balance of the chorus/flanger	-Wet...-2:98, Dry, 2:98...Wet Fx:010, 020
	Output Mode Selects the output mode for the chorus/flanger	Normal, Wet Invert Fx:
i	Routing Switches the order of the compressor and chorus/flanger connection	CMP → FLNG, FLNG → CMP Fx:
j	Wet/Dry Table, "Sets the balance between the effect and dry sounds," on page 175 D ^{mod}	Dry, 1:99...99:1, Wet
	Src Table, "Selects the modulation source of the effect balance," on page 175	Off...Tempo
	Amt Table, "Sets the modulation amount of the effect balance," on page 175	-100...+100

h: Output Mode, i: Routing

When **Wet Invert** is selected, the right channel phase of the chorus/flanger effect sound is inverted. This creates pseudo-stereo effects and adds spread.

However, if a mono-input type effect is connected after this effect, the left and right sounds may cancel each other, eliminating the chorus/flanger effects.

When "Routing" is set to **FLNG→CMP**, "Output Mode" will be set to **Normal**.

068: Cmp-Phaser (Compressor – Phaser)

This effect combines a mono-type compressor and a phaser. You can change the order of the effect connection.

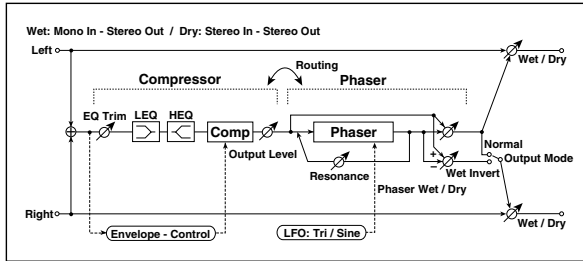

a	[C] Sensitivity Sets the sensitivity	1...100 Fx:002
b	[C] Attack Table, "Sets the attack level," on page 176	1...100 Fx:002
	Output Level Sets the compressor output level	0...100 Fx:002
c	[C] EQ Trim Table, "Sets the EQ input level," on page 176	0...100
d	[C] Pre LEQ Gain [dB] Table, "Sets the gain of Low EQ," on page 176	-15...+15dB
	Pre HEQ Gain [dB] Table, "Sets the gain of High EQ," on page 176	-15...+15dB
e	[P] LFO Frequency [Hz] Sets the LFO speed	0.02...20.00Hz
	LFO Waveform Selects LFO Waveform	Triangle, Sine
f	[P] Manual Sets the frequency to which the effect is applied	0...100
g	[P] Depth Sets the depth of LFO modulation	0...100
	Resonance Sets the resonance amount	-100...+100 Fx:023
h	[P] Phaser Wet/Dry Sets the phaser effect balance	-Wet...-2:98, Dry, 2:98...Wet Fx:010, 023
	Output Mode Selects the phaser output mode	Normal, Wet Invert Fx:067
i	Routing Switches the order of the compressor and phaser connection	CMP→PHS, PHS→CMP Fx:067

j	Wet/Dry Table, "Sets the balance between the effect and dry sounds," on page 175	Dry, 1:99...99:1, Wet D ^{mod}
	Src Table, "Selects the modulation source of the effect balance," on page 175	Off...Tempo
	Amt Table, "Sets the modulation amount of the effect balance," on page 175	-100...+100

069: Cmp-MTapDly (Compressor – Multitap Delay)

This effect combines a mono-type compressor and a multitap delay. You can change the order of the effect connection.

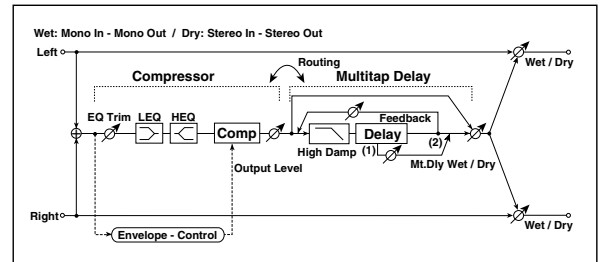

a	[C] Sensitivity Sets the sensitivity	1...100 Fx:002
b	[C] Attack Table, "Sets the attack level," on page 176	1...100 Fx:002
	Output Level Sets the compressor output level	0...100 Fx:002
c	[C] EQ Trim Table, "Sets the EQ input level," on page 176	0...100
d	[C] Pre LEQ Gain [dB] Table, "Sets the gain of Low EQ," on page 176	-15...+15dB
	Pre HEQ Gain [dB] Table, "Sets the gain of High EQ," on page 176	-15...+15dB
e	[D] Tap1 Time [msec] Sets the Tap1 delay time	0...680msec
	Tap1 Level Sets the Tap1 output level	0...100 Fx:045
f	[D] Tap2 Time [msec] Sets the Tap2 delay time	0...680msec
	Feedback Sets the Tap2 feedback amount	-100...+100
g	[D] High Damp [%] Sets the damping amount in the high range	0...100% Fx:043
h	[D] Mt.Delay Wet/Dry Sets the multitap delay effect balance	Dry, 1:99...99:1, Wet
i	Routing Switches the order of the compressor and multitap delay connection	CMP→DLY, DLY→CMP
j	Wet/Dry Table, "Sets the balance between the effect and dry sounds," on page 175	Dry, 1:99...99:1, Wet D ^{mod}

070: Lim-Par.4Eq
(Limiter - Parametric 4-Band EQ)

This effect combines a mono-type limiter and a four-band parametric equalizer. You can change the order of the effect connection.

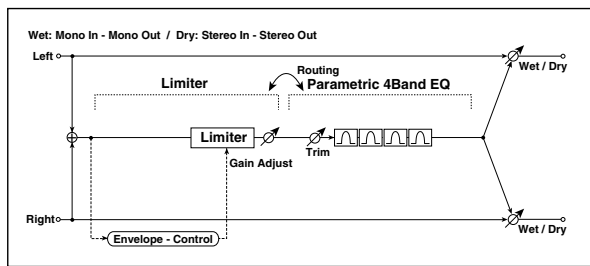

a	[L] Ratio Sets the signal compression ratio	1.0:1...50.0:1, Inf:1 Fx:003
	Threshold [dB] Sets the level above which the compressor is applied	-40...0dB Fx:003
b	[L] Attack Sets the attack time	1...100 Fx:003
	Release Sets the release time	1...100 Fx:003
c	[L] Gain Adjust [dB] Sets the limiter output gain	-Inf, -38...+24dB Fx:003
d	[E] Trim Sets the parametric EQ input level	0...100
e	[E] Band1 Cutoff [Hz] Sets the center frequency of Band 1	20...1.00kHz
	Q Sets the bandwidth of Band 1	0.5...10.0 Fx:006
	Gain [dB] Sets the gain of Band 1	-18...+18dB
f	[E] Band2 Cutoff [Hz] Sets the center frequency of Band 2	50...5.00kHz
	Q Sets the bandwidth of Band 2	0.5...10.0 Fx:006
	Gain [dB] Sets the gain of Band 2	-18...+18dB
g	[E] Band3 Cutoff [Hz] Sets the center frequency for Band 3	300...10.00kHz
	Q Sets the bandwidth of Band 3	0.5...10.0 Fx:006
	Gain [dB] Sets the gain of Band 3	-18...+18dB
h	[E] Band4 Cutoff [Hz] Sets the center frequency for Band 4	500...20.00kHz
	Q Sets the bandwidth of Band 4	0.5...10.0 Fx:006
	Gain [dB] Sets the gain of Band 4	-18...+18dB
i	Routing Switches the order of the limiter and parametric EQ connection	LMT→PEQ, PEQ→LMT
j	Wet/Dry Table, "Sets the balance between the effect and dry sounds," on page 175 D ^{mod}	Dry, 1:99...99:1, Wet
	Src Table, "Selects the modulation source of the effect balance," on page 175	Off...Tempo
	Amt Table, "Sets the modulation amount of the effect balance," on page 175	-100...+100

071: Lim-ChorFlg
(Limiter - Chorus/Flanger)

This effect combines a mono-type limiter and a chorus/flanger. You can change the order of the effect connection.

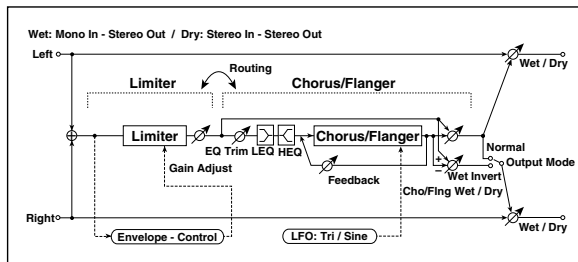

a	[L] Ratio Sets the signal compression ratio	1.0:1...50.0:1, Inf:1 Fx:003
	Threshold [dB] Sets the level above which the compressor is applied	-40...0dB Fx:003
b	[L] Attack Sets the attack time	1...100 Fx:003
	Release Sets the release time	1...100 Fx:003
c	[L] Gain Adjust [dB] Sets the limiter output gain	-Inf, -38...+24dB Fx:003
d	[F] LFO Frequency [Hz] Sets the LFO speed	0.02...20.00Hz
	LFO Waveform Selects LFO Waveform	Triangle, Sine
e	[F] Delay Time [msec] Sets the delay time	0.0...50.0msec
	Depth Sets the depth of LFO modulation	0...100
	Feedback Sets the feedback amount	-100...+100 Fx:020
f	[F] EQ Trim Table, "Sets the EQ input level," on page 176	0...100
g	[F] Pre LEQ Gain [dB] Table, "Sets the gain of Low EQ," on page 176	-15...+15dB
	Pre HEQ Gain [dB] Table, "Sets the gain of High EQ," on page 176	-15...+15dB
h	[F] Cho/Fing Wet/Dry Sets the effect balance of the chorus/flanger Fx:010, 020	-Wet...-2:98, Dry, 2:98...Wet
	Output Mode Selects the output mode for the chorus/flanger Fx:067	Normal, Wet Invert
i	Routing Switches the order of the limiter and chorus/flanger connection Fx:067	LMT→FLNG, FLNG→LMT
j	Wet/Dry Table, "Sets the balance between the effect and dry sounds," on page 175 D ^{mod}	Dry, 1:99...99:1, Wet
	Src Table, "Selects the modulation source of the effect balance," on page 175	Off...Tempo
	Amt Table, "Sets the modulation amount of the effect balance," on page 175	-100...+100

072: Lim-Phaser

This effect combines a mono-type limiter and a phaser. You can change the order of the effect connection.

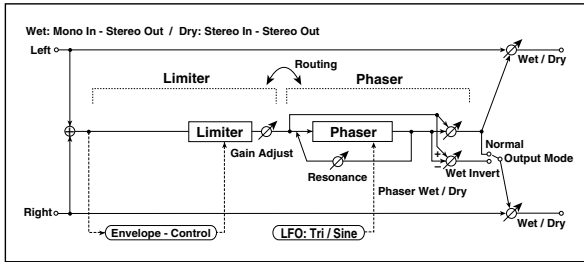

a	[L] Ratio Sets the signal compression ratio	1.0:1...50.0:1, Inf:1 Fx:003
	Threshold [dB] Sets the level above which the compressor is applied	-40...0dB Fx:003
b	[L] Attack Sets the attack time	1...100 Fx:003
	Release Sets the release time	1...100 Fx:003
c	[L] Gain Adjust [dB] Sets the limiter output gain	-Inf, -38...+24dB Fx:003
d	[P] LFO Frequency [Hz] Sets the LFO speed	0.02...20.00Hz
	LFO Waveform Selects LFO Waveform	Triangle, Sine
e	[P] Manual Sets the frequency to which the effect is applied	0...100
f	[P] Depth Sets the depth of LFO modulation	0...100
	Resonance Sets the resonance amount	-100...+100 Fx:023
g	[P] Phaser Wet/Dry Sets the phaser effect balance	-Wet...-2:98, Dry, 2:98...Wet Fx:010, 023
	Output Mode Selects the phaser output mode	Normal, Wet Invert Fx:067
h	Routing Switches the order of the limiter and phaser connection	LMT→PHS, PHS→LMT Fx:067
i	Wet/Dry Table, "Sets the balance between the effect and dry sounds," on page 175	Dry, 1:99...99:1, Wet D ^{mod}
	Src Table, "Selects the modulation source of the effect balance," on page 175	Off...Tempo
	Amt Table, "Sets the modulation amount of the effect balance," on page 175	-100...+100

073: Lim-MTapDly

(Limiter – Multitap Delay)

This effect combines a mono-type limiter and a multitap delay. You can change the order of the effect connection.

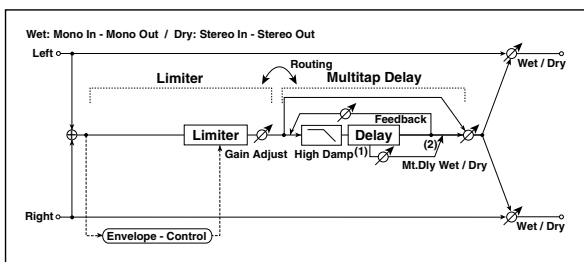

a	[L] Ratio Sets the signal compression ratio	1.0:1...50.0:1, Inf:1 Fx:003
	Threshold [dB] Sets the level above which the compressor is applied	-40...0dB Fx:003

b	[L] Attack Sets the attack time	1...100 Fx:003
	Release Sets the release time	1...100 Fx:003
c	[L] Gain Adjust [dB] Sets the limiter output gain	-Inf, -38...+24dB Fx:003
d	[D] Tap1 Time [msec] Sets the Tap1 delay time	0...680msec
	Tap1 Level Sets the Tap1 output level	0...100 Fx:045
e	[D] Tap2 Time [msec] Sets the Tap2 delay time	0...680msec
	Feedback (Tap2) Sets the Tap2 feedback amount	-100...+100
f	[D] Mt.Delay Wet/Dry Sets the multitap delay effect balance	Dry, 1:99...99:1, Wet
	High Damp [%] Sets the damping amount in the high range	0...100% Fx:043
g	Routing Switches the order of the limiter and multitap delay connection	LMT→DLY, DLY→LMT
h	Wet/Dry Table, "Sets the balance between the effect and dry sounds," on page 175	Dry, 1:99...99:1, Wet D ^{mod}
	Src Table, "Selects the modulation source of the effect balance," on page 175	Off...Tempo
	Amt Table, "Sets the modulation amount of the effect balance," on page 175	-100...+100

074: Exc-Compr

(Exciter – Compressor)

This effect combines a mono-type exciter and a compressor. You can change the order of the effect connection.

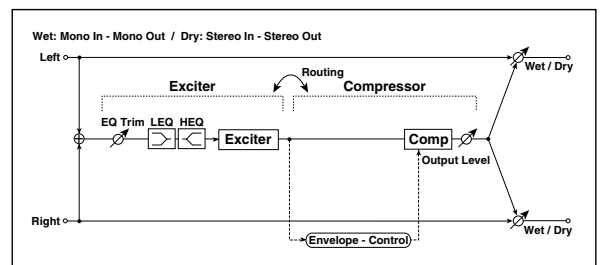

a	[X] Exciter Blend Sets the intensity (depth) of the Exciter effect	-100...+100 Fx:011
b	[X] Emphatic Point Sets the frequency range to be emphasized	0...70 Fx:011
c	[X] EQ Trim Table, "Sets the EQ input level," on page 176	0...100
d	[X] Pre LEQ Gain [dB] Table, "Sets the gain of Low EQ," on page 176	-15...+15dB
	Pre HEQ Gain [dB] Table, "Sets the gain of High EQ," on page 176	-15...+15dB
e	[C] Sensitivity Sets the sensitivity	1...100 Fx:002
f	[C] Attack Table, "Sets the attack level," on page 176	1...100 Fx:002
	Output Level Sets the compressor output level	0...100 Fx:002
g	Routing Switches the order of the exciter and compressor connection	XCT→CMP, CMP→XCT
h	Wet/Dry Table, "Sets the balance between the effect and dry sounds," on page 175	Dry, 1:99...99:1, Wet D ^{mod}
	Src Table, "Selects the modulation source of the effect balance," on page 175	Off...Tempo
	Amt Table, "Sets the modulation amount of the effect balance," on page 175	-100...+100

**075: Exc-Limiter
(Exciter - Limiter)**

This effect combines a mono-type exciter and a limiter. You can change the order of the effect connection.

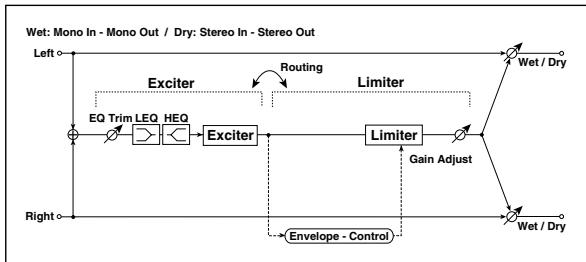

a	[X] Exciter Blend Sets the intensity (depth) of the Exciter effect	-100...+100 Fx:011
b	[X] Emphatic Point Sets the frequency range to be emphasized	0...70 Fx:011
c	[X] EQ Trim Table, "Sets the EQ input level," on page 176	0...100
d	[X] Pre LEQ Gain [dB] Table, "Sets the gain of Low EQ," on page 176	-15...+15dB
	Pre HEQ Gain [dB] Table, "Sets the gain of High EQ," on page 176	-15...+15dB
e	[L] Ratio Sets the signal compression ratio	1.0:1...50.0:1, Inf:1 Fx:003
f	[L] Threshold [dB] Sets the level above which the compressor is applied	-40...0dB Fx:003
g	[L] Attack Sets the attack time	1...100 Fx:003
	Release Sets the release time	1...100 Fx:003
h	[L] Gain Adjust [dB] Sets the limiter output gain	-Inf, -38...+24dB Fx:003
i	Routin Switches the order of the exciter and limiter connection	XCT→LMT, LMT→XCT
j	Wet/Dry Table, "Sets the balance between the effect and dry sounds," on page 175	Dry, 1:99...99:1, Wet D ^{mod}
	Src Table, "Selects the modulation source of the effect balance," on page 175	Off...Tempo
	Amt Table, "Sets the modulation amount of the effect balance," on page 175	-100...+100

**076: Exc-ChorFlg
(Exciter - Chorus/Flanger)**

This effect combines a mono-type limiter and a chorus/flanger.

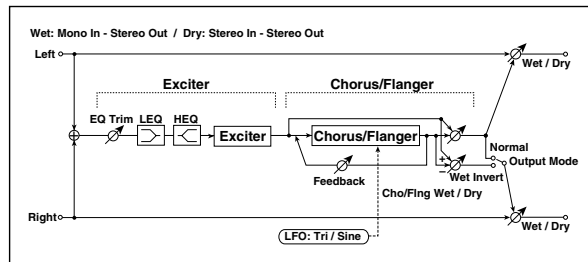

a	[X] Exciter Blend Sets the intensity (depth) of the Exciter effect	-100...+100 Fx:011
b	[X] Emphatic Point Sets the frequency range to be emphasized	0...70 Fx:011
c	[X] EQ Trim Table, "Sets the EQ input level," on page 176	0...100
d	[X] Pre LEQ Gain [dB] Table, "Sets the gain of Low EQ," on page 176	-15...+15dB
	Pre HEQ Gain [dB] Table, "Sets the gain of High EQ," on page 176	-15...+15dB
e	[F] Delay Time [msec] Sets the delay time	0.0...50.0msec
f	[F] LFO Frequency [Hz] Sets the LFO speed	0.02...20.00Hz
	LFO Waveform Selects LFO Waveform	Triangle, Sine
g	[F] Depth Sets the depth of LFO modulation	0...100
	Feedback Sets the feedback amount	-100...+100 Fx:020
h	[F] Cho/Flng Wet/Dry Sets the effect balance of the chorus/flanger	-Wet...-2:98, Dry, 2:98...Wet Fx:010, 020
	Output Mode Selects the output mode for the chorus/flanger	Normal, Wet Invert Fx:060
i	Wet/Dry Table, "Sets the balance between the effect and dry sounds," on page 175	Dry, 1:99...99:1, Wet D ^{mod}
	Src Table, "Selects the modulation source of the effect balance," on page 175	Off...Tempo
	Amt Table, "Sets the modulation amount of the effect balance," on page 175	-100...+100

077: Exc-Phaser
(Exciter – Phaser)

This effect combines a mono-type limiter and a phaser.

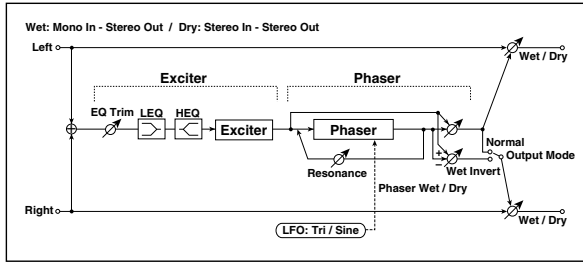

a	[X] Exciter Blend Sets the intensity (depth) of the Exciter effect	-100...+100 Fx:011
b	[X] Emphatic Point Sets the frequency range to be emphasized	0...70 Fx:011
c	[X] EQ Trim Table, "Sets the EQ input level," on page 176	0...100
d	[X] Pre LEQ Gain [dB] Table, "Sets the gain of Low EQ," on page 176	-15...+15dB
	Pre HEQ Gain [dB] Table, "Sets the gain of High EQ," on page 176	-15...+15dB
e	[P] LFO Frequency [Hz] Sets the LFO speed	0.02...20.00Hz
	LFO Waveform Selects LFO Waveform	Triangle, Sine
f	[P] Manual Sets the frequency to which the effect is applied	0...100
g	[P] Depth Sets the depth of LFO modulation	0...100
	Resonance Sets the resonance amount	-100...+100 Fx:023
h	[P] Phaser Wet/Dry Sets the phaser effect balance	-Wet...-2:98, Dry, 2:98...Wet Fx:010, 023
	Output Mode Selects the phaser output mode	Normal, Wet Invert Fx:060
i	Wet/Dry Table, "Sets the balance between the effect and dry sounds," on page 175	Dry, 1:99...99:1, Wet D-mod
	Src Table, "Selects the modulation source of the effect balance," on page 175	Off...Tempo
	Amt Table, "Sets the modulation amount of the effect balance," on page 175	-100...+100

078: Exc-MTapDly
(Exciter – Multitap Delay)

This effect combines a mono-type exciter and a multitap delay.

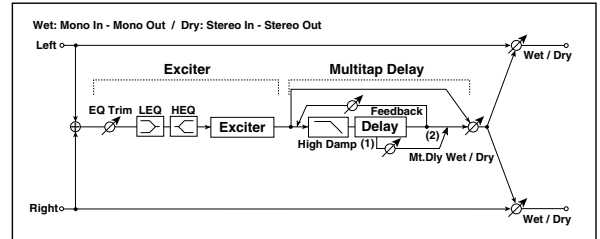

a	[X] Exciter Blend Sets the intensity (depth) of the Exciter effect	-100...+100 Fx:011
b	[X] Emphatic Point Sets the frequency range to be emphasized	0...70 Fx:011
c	[X] EQ Trim Table, "Sets the EQ input level," on page 176	0...100
d	[X] Pre LEQ Gain [dB] Table, "Sets the gain of Low EQ," on page 176	-15...+15dB
	Pre HEQ Gain [dB] Table, "Sets the gain of High EQ," on page 176	-15...+15dB
e	[D] Tap1 Time [msec] Sets the Tap1 delay time	0...680msec
	Tap1 Level Sets the Tap1 output level	0...100 Fx:045
f	[D] Tap2 Time [msec] Sets the Tap2 delay time	0...680msec
	Feedback (Tap2) Sets the Tap2 feedback amount	-100...+100
g	[D] High Damp [%] Sets the damping amount in the high range	0...100% Fx:043
h	[D] Mt.Delay Wet/Dry Sets the multitap delay effect balance	Dry, 1:99...99:1, Wet
i	Wet/Dry Table, "Sets the balance between the effect and dry sounds," on page 175	Dry, 1:99...99:1, Wet D-mod
	Src Table, "Selects the modulation source of the effect balance," on page 175	Off...Tempo
	Amt Table, "Sets the modulation amount of the effect balance," on page 175	-100...+100

079: OD/HG-Amp S
(Overdrive/Hi.Gain – Amp Simulation)

This effect combines a mono-type overdrive/high-gain distortion and an amp simulation. You can change the order of the effect connection.

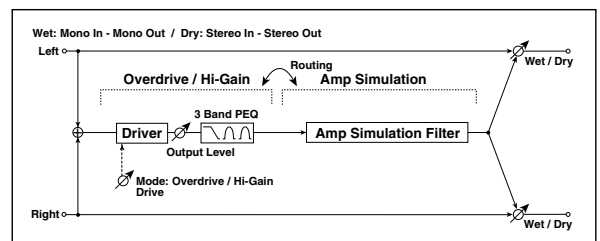

a	[O] Drive Mode Switches between overdrive and high-gain distortion	Overdrive, Hi-Gain
	Drive Sets the degree of distortion	1...100 Fx:006

b	[O] Output Level Sets the overdrive output level	0...50 Fx:006,
	Src Selects the modulation source for the overdrive output level	Off...Tempo
	Amt Sets the modulation amount of the overdrive output level	-50...+50
c	[O] Low Cutoff [Hz] Sets the center frequency for Low EQ (shelving type)	20...1.00kHz
	Gain [dB] Table, "Sets the gain of Low EQ," on page 176	-18...+18dB
d	[O] Mid1 Cutoff [Hz] Sets the center frequency for Mid/High EQ 1 (peaking type)	300...10.00kHz
	Q Sets the band width of Mid/High EQ 1	0.5...10.0 Fx:006
	Gain [dB] Sets the gain of Mid/High EQ 1	-18...+18dB
e	[O] Mid2 Cutoff [Hz] Sets the center frequency for Mid/High EQ 2 (peaking type)	500...20.00kHz
	Q Sets the band width of Mid/High EQ 2	0.5...10.0 Fx:006
	Gain [dB] Sets the gain of Mid/High EQ 2	-18...+18dB
f	[A] Amplifier Type Selects the type of guitar amplifier	SS, EL84, 6L6
g	Routing Switches the order of the overdrive and amp simulation connection	OD→AMP, AMP→OD
h	Wet/Dry Table, "Sets the balance between the effect and dry sounds," on page 175 	Dry, 1:99...99:1, Wet
	Src Table, "Selects the modulation source of the effect balance," on page 175	Off...Tempo
	Amt Table, "Sets the modulation amount of the effect balance," on page 175	-100...+100

080: OD/HG-ChoFI
(Overdrive/Hi-Gain - Chorus/Flanger)

This effect combines a mono-type overdrive/high-gain distortion and a chorus/flanger. You can change the order of the effect connection.

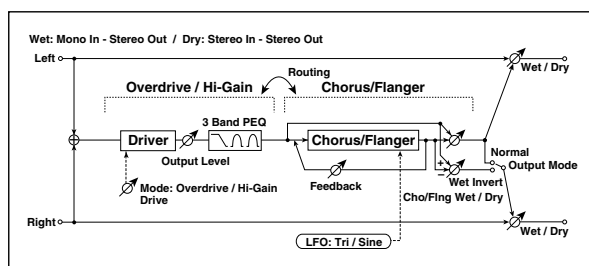

a	[O] Drive Mode Switches between overdrive and high-gain distortion	Overdrive, Hi-Gain
	Drive Sets the degree of distortion	1...100 Fx:006

b	[O] Output Level Sets the overdrive output level	0...50 Fx:006,
	Src Selects the modulation source for the overdrive output level	Off...Tempo
	Amt Sets the modulation amount of the overdrive output level	-50...+50
c	[O] Low Cutoff [Hz] Sets the center frequency for Low EQ (shelving type)	20...1.00kHz
	Gain [dB] Table, "Sets the gain of Low EQ," on page 176	-18...+18dB
d	[O] Mid1 Cutoff [Hz] Sets the center frequency for Mid/High EQ 1 (peaking type)	300...10.00kHz
	Q Sets the band width of Mid/High EQ 1	0.5...10.0 Fx:006
	Gain [dB] Sets the gain of Mid/High EQ 1	-18...+18dB
e	[O] Mid2 Cutoff [Hz] Sets the center frequency for Mid/High EQ 2 (peaking type)	500...20.00kHz
	Q Sets the band width of Mid/High EQ 2	0.5...10.0 Fx:006
	Gain [dB] Sets the gain of Mid/High EQ 2	-18...+18dB
f	[F] LFO Frequency [Hz] Sets the LFO speed	0.02...20.00Hz
	LFO Waveform Selects LFO Waveform	Triangle, Sine
g	[F] Delay Time [msec] Sets the delay time	0.0...50.0msec
	Depth Sets the depth of LFO modulation	0...100
	Feedback Sets the feedback amount	-100...+100 Fx:020
h	[F] Cho/Fing Wet/Dry Sets the effect balance of the chorus/flanger Fx:010, 020	-Wet...-2:98, Dry, 2:98...Wet
	Output Mode Selects the output mode for the chorus/flanger Fx:067	Normal, Wet Invert
i	Routing Switches the order of the overdrive and chorus/flanger connection Fx:067	OD → FLNG, FLNG → OD
j	Wet/Dry Table, "Sets the balance between the effect and dry sounds," on page 175 	Dry, 1:99...99:1, Wet
	Src Table, "Selects the modulation source of the effect balance," on page 175	Off...Tempo
	Amt Table, "Sets the modulation amount of the effect balance," on page 175	-100...+100

081: OD/HG-Phser (Overdrive/Hi.Gain – Phaser)

This effect combines a mono-type overdrive/high-gain distortion and a phaser. You can change the order of the effect connection.

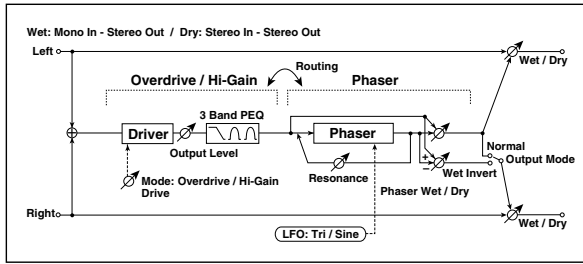

a	[O] Drive Mode Switches between overdrive and high-gain distortion	Overdrive, Hi-Gain
	Drive Sets the degree of distortion	1...100 Fx:006
b	[O] Output Level Sets the overdrive output level	0...50 Fx:006, D ^{mod}
	Src Selects the modulation source for the overdrive output level	Off...Tempo
	Amt Sets the modulation amount of the overdrive output level	-50...+50
c	[O] Low Cutoff [Hz] Sets the center frequency for Low EQ (shelving type)	20...1.00kHz
	Gain [dB] Table, "Sets the gain of Low EQ," on page 176	-18...+18dB
d	[O] Mid1 Cutoff [Hz] Sets the center frequency for Mid/High EQ 1 (peaking type)	300...10.00kHz
	Q Sets the band width of Mid/High EQ 1	0.5...10.0 Fx:006
	Gain [dB] Sets the gain of Mid/High EQ 1	-18...+18dB
e	[O] Mid2 Cutoff [Hz] Sets the center frequency for Mid/High EQ 2 (peaking type)	500...20.00kHz
	Q Sets the band width of Mid/High EQ 2	0.5...10.0 Fx:006
	Gain [dB] Sets the gain of Mid/High EQ 2	-18...+18dB
f	[P] LFO Frequency [Hz] Sets the LFO speed	0.02...20.00Hz
	LFO Waveform Selects LFO Waveform	Triangle, Sine
g	[P] Manual Sets the frequency to which the effect is applied	0...100
	Depth Sets the depth of LFO modulation	0...100
	Resonance Sets the resonance amount	-100...+100 Fx:023
h	[P] Phaser Wet/Dry Sets the phaser effect balance	-Wet...-2:98, Dry, 2:98...Wet Fx:010, 023
	Output Mode Selects the phaser output mode	Normal, Wet Invert Fx:067
i	Routing Switches the order of the overdrive and phaser connection	OD → PHS, PHS → OD Fx:067

j	Wet/Dry Table, "Sets the balance between the effect and dry sounds," on page 175 D ^{mod}	Dry, 1:99...99:1, Wet
	Src Table, "Selects the modulation source of the effect balance," on page 175	Off...Tempo
	Amt Table, "Sets the modulation amount of the effect balance," on page 175	-100...+100

082: OD/HG-MTDIy (Overdrive/Hi.Gain – Multitap Delay)

This effect combines a mono-type overdrive/high-gain distortion and a multitap delay.

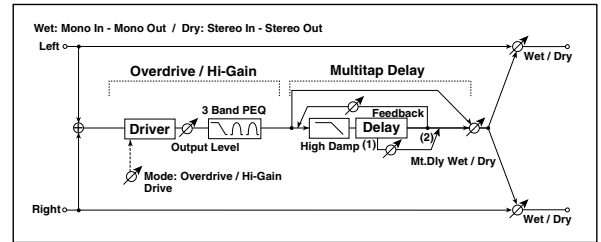

a	[O] Drive Mode Switches between overdrive and high-gain distortion	Overdrive, Hi-Gain
	Drive Sets the degree of distortion	1...100 Fx:006
b	[O] Output Level Sets the overdrive output level	0...50 Fx:006, D ^{mod}
	Src Selects the modulation source for the overdrive output level	Off...Tempo
	Amt Sets the modulation amount of the overdrive output level	-50...+50
c	[O] Low Cutoff [Hz] Sets the center frequency for Low EQ (shelving type)	20...1.00kHz
	Gain [dB] Table, "Sets the gain of Low EQ," on page 176	-18...+18dB
d	[O] Mid1 Cutoff [Hz] Sets the center frequency for Mid/High EQ 1 (peaking type)	300...10.00kHz
	Q Sets the band width of Mid/High EQ 1	0.5...10.0 Fx:006
	Gain [dB] Sets the gain of Mid/High EQ 1	-18...+18dB
e	[O] Mid2 Cutoff [Hz] Sets the center frequency for Mid/High EQ 2 (peaking type)	500...20.00kHz
	Q Sets the band width of Mid/High EQ 2	0.5...10.0 Fx:006
	Gain [dB] Sets the gain of Mid/High EQ 2	-18...+18dB
f	[D] Tap1 Time [msec] Sets the Tap1 delay time	0...680msec
	Tap1 Level Sets the Tap1 output level	0...100 Fx:045
g	[D] Tap2 Time [msec] Sets the Tap2 delay time	0...680msec
	Feedback Sets the Tap2 feedback amount	-100...+100
h	[D] Mt.Delay Wet/Dry Sets the multitap delay effect balance	Dry, 2:98...98:2, Wet
	High Damp [%] Sets the damping amount in the high range	0...100% Fx:043
i	Wet/Dry Table, "Sets the balance between the effect and dry sounds," on page 175 D ^{mod}	Dry, 1:99...99:1, Wet

083: Wah-AmpSim (Wah/Auto Wah - Amp Simulation)

This effect combines a mono-type wah and an amp simulation. You can change the order of the effect connection.

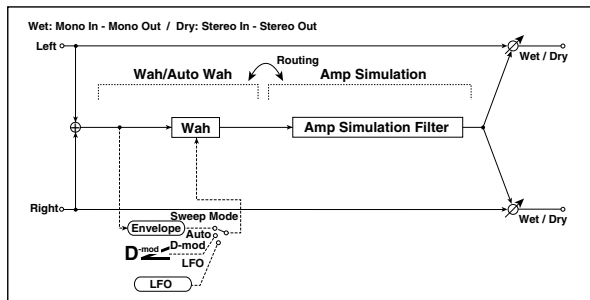

a	[W] Frequency Bottom Sets the lower limit of the wah center frequency	0...100 Fx:009
	Frequency Top Sets the upper limit of the wah center frequency	0...100 Fx:009
b	[W] Sweep Mode Selects the control from auto-wah, modulation source, and LFO	Auto, D-mod, LFO Fx:009, D-mod
	Src Selects the modulation source for the wah when Sweep Mode=D-mod	Off...Tempo
c	[W] LFO Frequency [Hz] Sets the LFO speed	0.02...20.00Hz
d	[W] Resonance Sets the resonance amount	0...100
	Low Pass Filter Switches the wah low pass filter on and off	Off, On
e	[A] Amplifier Type Selects the type of guitar amplifier	SS, EL84, 6L6
f	Routing Switches the order of the wah and amp simulation connection	WAH → AMP, AMP → WAH
g	Wet/Dry Table, "Sets the balance between the effect and dry sounds," on page 175	Dry, 1:99...99:1, Wet D-mod
	Src Table, "Selects the modulation source of the effect balance," on page 175	Off...Tempo
	Amt Table, "Sets the modulation amount of the effect balance," on page 175	-100...+100

084: Decim-Amp S (Decimator - Amp Simulation)

This effect combines a mono-type decimator and an amp simulation. You can change the order of the effect connection.

a	[D] Pre LPFOff, On Turn the harmonic noise caused by lowered sampling on and off	Off, On Fx:014
	High Damp [%] Sets the ratio of high-range damping	0...100%
b	[D] Sampling Freq [Hz] (Sampling Frequency) Sets the sampling frequency	1.00k...48.00kHz
	Resolution Sets the data bit length	4...24 Fx:014
c	[D] Output Level Sets the decimator output level	0...100 Fx:014
d	[A] Amplifier Type Selects the type of guitar amplifier	SS, EL84, 6L6
e	RoutingDECI→AMP, AMP→DECI Switches the order of the wah and amp simulation connection	
f	Wet/DryDry, 1:99...99:1, Wet Table, "Sets the balance between the effect and dry sounds," on page 175	D-mod
	SrcOff...Tempo Table, "Selects the modulation source of the effect balance," on page 175	
	Amt Table, "Sets the modulation amount of the effect balance," on page 175	-100...+100

085: Decim-Cmp (Decimator - Compressor)

This effect combines a mono-type decimator and a compressor. You can change the order of the effect connection.

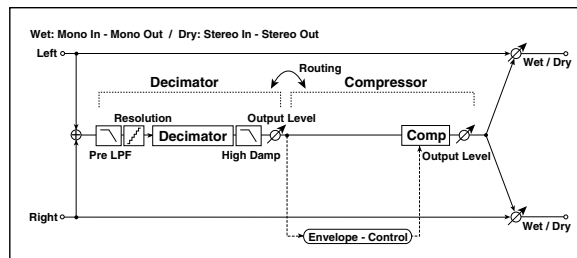

a	[D] Pre LPFOff, On Turn the harmonic noise caused by lowered sampling on and off	Off, On Fx:014
	High Damp [%] Sets the ratio of high-range damping	0...100%
b	[D] Sampling Freq [Hz] (Sampling Frequency) Sets the sampling frequency	1.00k...48.00kHz
	Resolution Sets the data bit length	4...24 Fx:014
c	[D] Output Level Sets the decimator output level	0...100 Fx:014
d	[C] Sensitivity Sets the sensitivity	1...100 Fx:002
e	[C] Attack Table, "Sets the attack level," on page 176	1...100 Fx:002
	Output Level Sets the compressor output level	0...100 Fx:002
f	Routing Switches the order of the decimator and compressor connection	DECI→CMP, CMP→DECI

g	Wet/Dry Table , "Sets the balance between the effect and dry sounds," on page 175 D^{mod}	Dry, 1:99...99:1, Wet
	Src Table , "Selects the modulation source of the effect balance," on page 175	Off...Tempo
	Amt Table , "Sets the modulation amount of the effect balance," on page 175	-100...+100

086: AmpS-Tremol (Amp Simulation – Tremolo)

This effect combines a mono-type amp simulation and a tremolo.

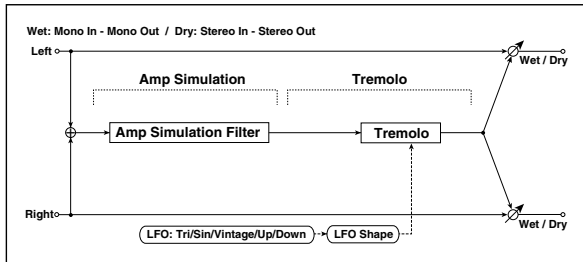

a	[A] Amplifier Type Selects the type of guitar amplifier	SS, EL84, 6L6
b	[T] LFO Waveform Selects LFO Waveform	Triangle, Sine, Vintage, Up, Down Fx:032
	LFO Shape Determines how much the LFO waveform is changed	-100...+100 Fx:020
c	[T] LFO Frequency [Hz] Sets the LFO speed	0.02...20.00Hz
d	[T] Depth Sets the depth of LFO modulation	0...100
e	Wet/Dry Table , "Sets the balance between the effect and dry sounds," on page 175 D^{mod}	Dry, 1:99...99:1, Wet
	Src Table , "Selects the modulation source of the effect balance," on page 175	Off...Tempo
	Amt Table , "Sets the modulation amount of the effect balance," on page 175	-100...+100

087: Ch/FI-MTDly (Chorus/Flanger – Multitap Delay)

This effect combines a mono-type chorus/flanger and a multitap delay.

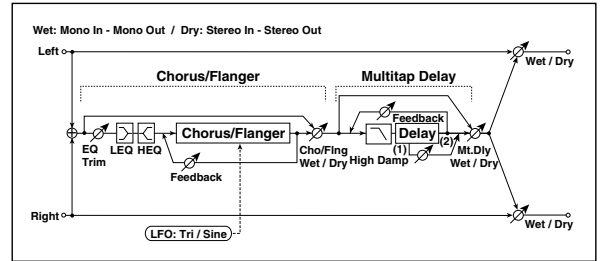

a	[F] Delay Time [msec] Sets the delay time	0.0...50.0msec
b	[F] LFO Frequency [Hz] Sets the LFO speed	0.02...20.00Hz
	LFO Waveform Selects LFO Waveform	Triangle, Sine
c	[F] Depth Sets the depth of LFO modulation	0...100
	Feedback Sets the feedback amount	-100...+100 Fx:020
d	[F] EQ Trim Table , "Sets the EQ input level," on page 176	0...100
e	[F] Pre LEQ Gain [dB] Table , "Sets the gain of Low EQ," on page 176	-15...+15dB
	Pre HEQ Gain [dB] Table , "Sets the gain of High EQ," on page 176	-15...+15dB
f	[F] Cho/Fing Wet/Dry Sets the effect balance of the chorus/flanger	-Wet...-2:98, Dry, 2:98...Wet Fx:010, 020
g	[D] Tap1 Time [msec] Sets the Tap1 delay time	0...680msec
	Tap1 Level Sets the Tap1 output level	0...100 Fx:045
h	[D] Tap2 Time [msec] Sets the Tap2 delay time	0...680msec
	Feedback (Tap2) Sets the Tap2 feedback amount	-100...+100
i	[D] Mt.Delay Wet/Dry Sets the multitap delay effect balance	Dry, 1:99...99:1, Wet
	High Damp [%] Sets the damping amount in the high range	0...100% Fx:043
j	Wet/Dry Table , "Sets the balance between the effect and dry sounds," on page 175 D^{mod}	Dry, 1:99...99:1, Wet
	Src Table , "Selects the modulation source of the effect balance," on page 175	Off...Tempo
	Amt Table , "Sets the modulation amount of the effect balance," on page 175	-100...+100

088: Phser-ChoFI
(Phaser - Chorus/Flanger)

This effect combines a mono-type phaser and a chorus/flanger.

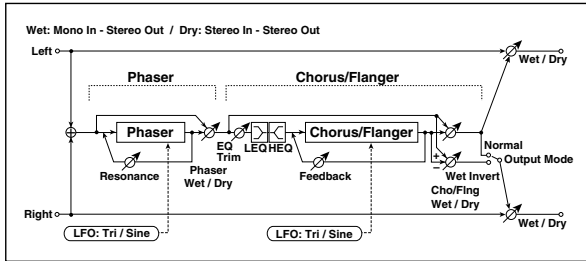

a	[P] LFO Frequency [Hz] Sets the LFO speed	0.02...20.00Hz
	LFO Waveform Selects LFO Waveform	Triangle, Sine
b	[P] Manual Sets the frequency to which the effect is applied	0...100
	Depth Sets the depth of LFO modulation	0...100
	Resonance Sets the resonance amount	-100...+100 Fx:023
c	[P] Phaser Wet/Dry Sets the phaser effect balance	-Wet...-2:98, Dry, 2:98...Wet Fx:010, 023
d	[F] LFO Frequency [Hz] Sets the LFO speed	0.02...20.00Hz
	LFO Waveform Selects LFO Waveform	Triangle, Sine
e	[F] Delay Time [msec] Sets the delay time	0.0...50.0msec
	Depth Sets the depth of LFO modulation	0...100
	Feedback Sets the feedback amount	-100...+100 Fx:020
f	[F] EQ Trim Table, "Sets the EQ input level," on page 176	0...100
g	[F] Pre LEQ Gain [dB] Table, "Sets the gain of Low EQ," on page 176	-15...+15dB
	Pre HEQ Gain [dB] Table, "Sets the gain of High EQ," on page 176	-15...+15dB
h	[F] Cho/Fing Wet/Dry Sets the effect balance of the chorus/flanger	-Wet...-2:98, Dry, 2:98...Wet Fx:010, 020
	Output Mode Selects the output mode for the chorus/flanger	Normal, Wet Invert Fx:060
i	Wet/Dry Table, "Sets the balance between the effect and dry sounds," on page 175	Dry, 1:99...99:1, Wet
	Src Table, "Selects the modulation source of the effect balance," on page 175	Off...Tempo
	Amt Table, "Sets the modulation amount of the effect balance," on page 175	-100...+100

089: Rev-Gate
(Reverb - Gate)

This effect combines a mono-type reverb and a gate.

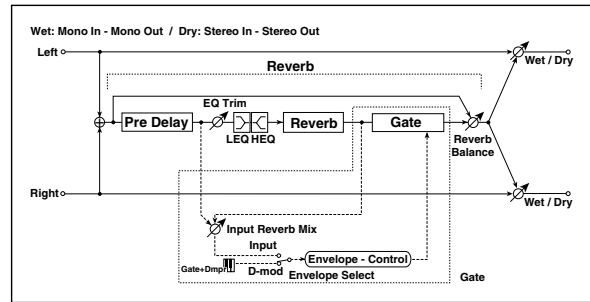

a	[R] Reverb Time [sec] Sets the reverberation time	0.1...10.0sec
	High Damp [%] Sets the damping amount in the high range	0...100%
b	[R] Pre Delay [msec] Sets the delay time of the reverb sound and gate control signal	0...200msec
c	[R] EQ Trim Table, "Sets the EQ input level," on page 176	0...100
d	[R] Pre LEQ Gain [dB] Table, "Sets the gain of Low EQ," on page 176	-15...+15dB
	Pre HEQ Gain [dB] Table, "Sets the gain of High EQ," on page 176	-15...+15dB
e	[R] Reverb Balance Sets the reverb effect balance	Dry, 1:99...99:1, Wet
f	[G] Envelope Select Switches between modulation source control and input signal control	D-mod, Input Fx:058
	Src Selects the modulation source that controls the gate when Envelope Select is set to D-mod	Off...Gate2+Dmpr Fx:058
g	[G] Input Reverb Mix Sets the balance between the dry and reverb sounds of the gate control signal.	Dry, 1:99...99:1, Wet Fx:058
	Threshold Sets the gate threshold level	0...100 Fx:058
h	[G] Polarity Switches between non-invert and invert of the gate on/off state	+, - Fx:005
i	[G] Attack Sets the attack time	1...100 Fx:005
	Release Sets the release time	1...100 Fx:005
j	Wet/Dry Table, "Sets the balance between the effect and dry sounds," on page 175	Dry, 1:99...99:1, Wet
	Src Table, "Selects the modulation source of the effect balance," on page 175	Off...Tempo
	Amt Table, "Sets the modulation amount of the effect balance," on page 175	-100...+100

f: Envelope Select, f: Src, g: Input Reverb Mix, g: Threshold

The "Envelope Select" parameter enables you to select whether turning the gate on and off is triggered by the input signal level or controlled directly by the modulation source. You can select from **Off** to **Gate2+Dmpr** for the Src parameter to specify the modulation source.

When "Envelope Select" is set to **Input**, the gate is controlled by the level of signals that are the combination of the dry sound and the reverb sound. When the signal level exceeds the threshold, the gate opens and the reverb sound is output.

Normally, set "Input Reverb Mix" to **Dry** (the gate is controlled only by the dry sound). If you wish to extend the gate time, set the "Input Reverb Mix" value higher and adjust the "Threshold" value.

19. ASSIGNABLE PARAMETERS

LIST OF FUNCTIONS ASSIGNABLE TO THE FOOTSWITCH

The following functions can be assigned to a footswitch.

Function	Meaning
Off	No function assigned
Start/stop	Same functions of the control panel buttons with the same name
Play/Stop Seq1	
Play Stop Seq2	
Synchro	
Tap tempo/Rst	
Tempo lock	
Intro 1	
Ending 1	
Intro 2	
Ending 2	
Fill 1	
Fill 2	
C.In / Break	
Variation 1	
Variation 2	
Variation 3	
Variation 4	
Variation up	
Variation down	
Fade in/out	
Memory	
Bass inversion	
Manual Bass	
Upper 1 Mute	
Upper 2 Mute	Mute of the Upper 2 track
Upper 3 Mute	Mute of the Upper 3 track
Lower Mute	Mute of the Lower track
Song Melody Mute	Mute of the Song's track 4 (usually, the Melody track)
Song Drum&Bass	Mute of all tracks, apart for track 2 (usually Bass) and 10 (usually Drum)
Style Change	Same functions of the control panel buttons with the same name
Single Touch	

Function	Meaning
Style Up	Selects the next Style
Style Down	Selects the previous Style
Perform. Up	Selects the next Performance
Perform. Down	Selects the previous Performance
Program Up	Selects the next Program
Program Down	Selects the previous Program
STS Up	Selects the next STS
STS Down	Selects the previous STS
STS1	Selects the STS #1
STS2	Selects the STS #2
STS3	Selects the STS #3
STS4	Selects the STS #4
Punch In/Out	Turns the Punch Recording on/off
FX CC12 Sw.	Standard FX controllers
FX CC13 Sw.	
Fx A mute	Mute of the Internal FX A
Fx B mute	Mute of the Internal FX B
Fx C mute	Mute of the Internal FX C
Fx D mute	Mute of the Internal FX D
All Fx mute	Mute of all Internal FXs
Drum mute	Mute of the Drum track
Perc mute	Mute of the Percussion track
Bass mute	Mute of the Bass track
Acc1 mute	Mute of the Acc1 track
Acc2 mute	Mute of the Acc2 track
Acc3 mute	Mute of the Acc3 track
Acc4 mute	Mute of the Acc4 track
Acc5 mute	Mute of the Acc5 track
Acc 1/5 mute	Mute of all Acc tracks
Ens. on/off	Ensemble on/off
Quarter tone	Quarter Tone on/off
Chord Latch	Holds the recognized chord until the pedal is released
Chord Latch+Damper	Holds the recognized chord until the pedal is released, and sustains tracks where the Damper has been turned on

LIST OF FUNCTIONS ASSIGNABLE TO THE PEDAL OR ASSIGNABLE SLIDER

The following functions can be assigned to a continuous pedal or to the Assignable Slider.

Function	Meaning
Master volume	Master Volume
Accomp.Volume	Accompaniment Volume
Kb Expression	Keyboard Expression

Function	Meaning
Joystick +X	Joystick right
Joystick -X	Joystick left
Joystick +Y	Joystick forward
Joystick -Y	Joystick backward
Vdf cutoff (RT tracks)	Filter cutoff (on the Programs assigned to the Realtime tracks)
FX CC12 Ctl	Standard FX controllers
FX CC13 Ctl	

LIST OF SOUNDS ASSIGNABLE TO THE PADS

You can assign the following sounds to the Pads.

	SOUND NAME		SOUND NAME		SOUND NAME		SOUND NAME
1	ChinaGong	36	DistSlid2	71	Darbuka1	106	HeartBeat
2	Crash 1	37	Sticks	72	Darbuka2	107	Footstep1
3	Crash 2	38	Cowbell	73	Darbuka3	108	Footstep2
4	88 Crash	39	Agogo 1	74	Darbuka4	109	Stadium
5	Ride 1	40	Agogo 2	75	Darbuka5	110	DoorCreak
6	Ride 2	41	Whistle 1	76	Darbuka6	111	DoorSlam
7	China	42	Whistle 2	77	Darbuka7	112	CarEngine
8	Ride Bell	43	Sh. Guiro	78	Darbuka8	113	Car Stop
9	Splash	44	LongGuiro	79	DoufRimAk	114	Car Pass
10	RevCymbal	45	Cuica 1	80	Tef 1	115	Car Crash
11	DragonGng	46	Cuica 2	81	Tef 2	116	Crickets
12	OrchCymb1	47	Triangle1	82	Tef 3	117	Train
13	OrchCymb2	48	Triangle2	83	Tef 4	118	Helicopt
14	OrcSdRoll	49	88Cowbell	84	Tef 5	119	Gun Shot
15	OrchSnare	50	TimbLow	85	Tef 6	120	MachinGun
16	Timpani 1	51	TimbHi	86	Rik 1	121	Laser Gun
17	Timpani 2	52	TimbRim1	87	Rik 2	122	Explosion
18	Timpani 3	53	TimbRim2	88	Rik 3	123	Dog
19	Timpani 4	54	CongaLow	89	RekDomAk	124	H. Gallop
20	Orch. Hit	55	CongaHi	90	OpenBells	125	Birds 1
21	BrassFall	56	CongaSlap	91	Sagat 1	126	Birds 2
22	Ch. Bell	57	CongaMute	92	Sagat 2	127	Thunder
23	JingleBel	58	Tamb.Acc1	93	Davul	128	Sea Shore
24	WindChim1	59	Tamb.Acc2	94	Ramazan 1	129	River
25	WindChim2	60	Tamb.Push	95	Ramazan 2	130	Bubble
26	WindChim3	61	TambOpen	96	Ramazan 3	131	Cat
27	VibraSlap	62	Castanet1	97	Kup 1	132	Lion
28	RainStick	63	Castanet2	98	Kup 2	133	PhoneRing
29	Scratch 1	64	Aah !	99	Kup 3	134	Applause
30	Scratch 2	65	Uuh !	100	Kup 4	135	Wind
31	Scratch 3	66	Yeah ! 1	101	Baya 1	136	Starship
32	Scratch 4	67	Yeah ! 2	102	Baya 2	137	Jetplane
33	Scratch 5	68	Hit It !	103	Laughing	138	Siren
34	Scratch 6	69	Hollo 1	104	Scream	139	Cosmic
35	DistSlid1	70	Hollo 2	105	Punch		

LIST OF FUNCTIONS ASSIGNABLE TO THE PADS

You can assign the following functions to the Pads, and use them as switch controls.

Function	Meaning
StyleUp	Selects the next Style
StylDown	Selects the previous Style
PerfUp	Selects the next Performance
PerfDown	Selects the previous Performance
ProgUp	Selects the next Program
ProgDown	Selects the previous Program
PunchI/O	Turns the Punch Recording on/off
FxA Mute	Mute of the Internal FX A
FxB Mute	Mute of the Internal FX B
FxC Mute	Mute of the Internal FX C
FxD Mute	Mute of the Internal FX D
Fx Mute	Mute of all Internal FXs
Upp1Mute	Mute of the Upper 1 track
Upp2Mute	Mute of the Upper 2 track
Upp3Mute	Mute of the Upper 3 track
Low Mute	Mute of the Lower track
DrumMute	Mute of the Drum track
PercMute	Mute of the Percussion track
BassMute	Mute of the Bass track
Acc1Mute	Mute of the Acc1 track
Acc2Mute	Mute of the Acc2 track
Acc3Mute	Mute of the Acc3 track
Acc4Mute	Mute of the Acc4 track
Acc5Mute	Mute of the Acc5 track
Acc Mute	Mute of all Acc tracks
Mel.Mute	Mute of the Song's track 4 (usually, the Melody track)
Drum&Bas	Mute of all tracks, apart for track 2 (usually Bass) and 10 (usually Drum)
QuarterT	Quarter Tone on/off
Fx CC12	Standard FX controllers
Fx CC13	

SCALES

The following is a list of scales (or tunings) you can select in Style Play ("Scale" on page 44) and Global ("Scale" on page 125) modes.

- Equal** Equal tuning, the standard scale for modern Western music. It is made of 12 identical semi-tones.
- Pure Major** Major chords in the selected key are perfectly tuned.
- Pure Minor** Minor chords in the selected key are perfected tuned.
- Arabic** An arabic scale, using quarters of tone. Set the Key parameter as follow:
 C - for the "rast C/bayati D" scale
 D - for the "rast D/bayati E" scale
 F - for the "rast F/bayati G" scale
 G - for the "rast G/bayati A" scale
 A# - for the "rast Bb/bayati C" scale
- Pythagorean** Pythagorean scale, based on the music theories of the great Greek philosopher and mathematician. It is most suitable for melodies.
- Werckmeister** Late Baroque/Classic Age scale. Very suitable for XVIII Century music.
- Kirnberger** Harpsichord scale, very common during the XVIII Century.
- Slendro** Scale of the Indonesian Gamelan. The octave is divided in 5 notes (C, D, F, G, A). The remaining notes are tuned as in the Equal tuning.
- Pelog** Scale of the Indonesian Gamelan. The octave is divided in 7 notes (all white keys, when Key is = C). The black keys are tuned as in the Equal tuning.
- Stretch** Simulates the "stretched" tuning of an acoustic piano. Basically an equal tuning, the lowest notes are slightly lower, while the highest notes are slightly higher than the standard.
- User** User scale, i.e. scale programmed by the user for the Style Play, Backing Sequence and Song Play modes. The user scale can be saved to a Performance, Style Performance, STS or Song. You can't select a User scale in Global mode.

20. MIDI CONTROLLERS

The following is a table including all Control Change messages, and their effect on various Pa50 functions.

CC#	CC Name	Pa50 Function
0	Bank Select	Program selection
1	Mod1 (Y+)	Joystick forward
2	Mod2 (Y-)	Joystick backward
3	Undef. ctl	
4	Foot ctl	
5	Port.time	
6	Data ent.	
7	Volume	Track volume
8	Balance	
9	Undef. ctl	
10	Pan Pot	Track panning
11	Expression	Expression
12	Fx Ctl 1	
13	Fx Ctl 2	
14-15	Undef. ctl	
16	Gen.pc.1	
17	Gen.pc.2	
18	Slider	
19	Gen.pc.4	
20-31	Undef. ctl	
Control Change #32-63 are the LSB (Least Significant Byte) of Control Change #0-31, i.e. the MSB (Most Significant Byte), and are changed according to their MSB counterparts.		
64	Damper	Damper pedal
65	Portamento	
66	Sostenuto	Sostenuto pedal
67	Soft pedal	Soft pedal
68	Legato	
69	Hold 2	
70	Sustin level	
71	F.Res.Hp	Filter resonance
72	Release	Release time

CC#	CC Name	Pa50 Function
73	Attack	Attack time
74	F.CutOff	Filter cutoff (Brilliance)
75	Decay T.	Decay time
76	Lfo1 Sp.	Vibrato speed
77	Lfo1 Dpt	Vibrato depth
78	Lfo1 Dly	Vibrato initial delay
79	FilterEg	
80	Gen.pc.5	
81	Gen.pc.6	
82	Gen.pc.7	
83	Gen.pc.8	
84	Port.ctl	
85-90	Undef. ctl	
91	Fx A/C	A/C (reverb) send level
92	Fx 2 ctl	
93	Fx B/D	B/D (modul.) send level
94	Fx 4 ctl	
95	Fx 5 ctl	
96	Data Inc	
97	Data Dec	
98	NRPN Lsb	
99	NRPN Msb	
100	RPN Lsb	
101	RPN Msb	
102-119	Undefined ctl	
120	AllSOff	
121	Res Ctl	Reset All Controllers
122	LocalCt	
123	NoteOff	
124	OmniOff	
125	Omni On	
126	Mono On	
127	Poly On	

MIDI IMPLEMENTATION CHART

KORG Pa50
OS Version 1.0 - Mar. 15, 2003

Function		Transmitted	Recognized	Remarks
Basic Channel	Default	1-16	1-16	Memorized
	Changed	1-16	1-16	
Mode	Default		3	
	Messages	X	X	
	Altered	*****		
Note Number:		0-127	0-127	
	True Voice	*****	0-127	
Velocity	Note On	O 9n, V=1-127	O 9n, V=1-127	
	Note Off	X V=64	X	
Aftertouch	Poly (Key)	O	O	Sequencer data only *A
	Mono (Channel)	O	O	Sequencer data only *A
Pitch Bend		O	O	
Control Change	0, 32	O	O	Bank Select (MSB, LSB) *A
	1, 2	O	O	Modulations *A
	64	O	O	Damper *A
	6	O	O	Data Entry MSB *A
	38	X	O	Data Entry LSB *A
	7, 11	O	O	Volume, Expression *A
	10, 91, 93	O	O	Panpot, A/B or C/D FX Block Send *A
	71, 72, 73	O	O	Harmonic Content, EG time (Release, Attack) *A
	74, 75	O	O	Brightness, Decay Time *A
	76, 77, 78	O	O	Vibrato Rate, Depth, Delay *A
	98, 99	O	O	NRPN (LSB, MSB) *A,
	100, 101	O	O	RPN (LSB, MSB) *A, 1
	120, 121	X	O	All sounds off, Reset all controllers *A
Program Change		O 0-127	O 0-127	*A
	True #	*****	0-127	
System Exclusive		O	O	*2
System Common	Song Position	X	X	
	Song Select	X	X	
	Tune	X	X	
System Real Time	Clock	O	O	*3
	Commands	O	O	*3
Aux Messages	Local On/Off	X	X	
	All Notes Off	X	O (123-127)	
	Active Sense	O	O	
	Reset	X	X	
Notes	*A: Sent and received when MIDI Filters In and Out are set to Off in Global mode. *1: LSB, MSB = 00,00: Pitch Bend range, =01,00: Fine Tune, =02,00: Course Tune. *2: Includes Inquiry and Master Volume messages. *3: Transmitted only when the Clock Send parameter (Global page 6) is set to Midi.			

Mode 1: OMNI ON, POLY
Mode 3: OMNI OFF, POLY

Mode 2: OMNI ON, MONO
Mode 4: OMNI OFF, MONO

O: Yes
X: No

21. PARAMETERS

Control panel and operating modes parameters

The following table shows the parameters you can save to memory when pressing the WRITE button in the various operating modes and edit environments.

Page	Parameter	Performance	Single Touch Setting (STS)	Style Performance	Global	Seq1+Seq2 Setup	Note
Control Panel							
-	Master Volume (Slider)	-	-	-	-	-	
	Acc./Seq Volume (Slider)	-	-	-	-	-	
	Assignable Slider	-	-	-	√ (function)	-	
	Selected Mode	-	-	-	-	-	
	Memory	-	-	-	-	-	
	Bass Inversion	-	-	-	-	-	
	Manual Bass	-	-	-	-	-	
	Split Point	-	-	-	√	-	Not saved to disk
	Groove Quantize	-	-	-	-	-	
	Tempo Lock	-	-	-	-	-	
	Single Touch	-	-	-	-	-	
	Selected Style Number	√	-	-	-	-	General parameter
	Synchro Start/Stop	-	-	-	-	-	
	Fade In/Out	-	-	-	-	-	
	Style Element (V1, V2, V3, V4, Fill 1/2, Count In, Intro 1/2, Ending 1/2)	√	-	√	-	-	General parameters
	Ensemble On/Off	√	√	-	-	-	General parameters
	Chord Scanning	√	√	-	-	-	
	Keyboard Mode	√	√	-	-	-	
	Style Change	-	-	-	-	-	
	Perf./Program	-	-	-	-	-	
	Program Change	√	√	√	-	-	Separate tracks
	Octave Transpose	√	√	√	-	-	
	Master Transpose	√	-	√	-	-	General parameters
	Tempo	√	-	√	-	-	
	Display Hold	-	-	-	-	-	
Style Play Mode							
Main	Program	√	√	√	-	-	
	Play/Mute status	√	√	√	-	-	
1	Volume	√	√	√	-	-	Separate tracks
2	Pan	√	√	√	-	-	
3	FX Send Level	√	√	√	-	-	
4	Detune	√	√	√	-	-	
5	Scale	√	√	-	-	-	General parameters
	Key	√	√	-	-	-	
	Note	√	√	-	-	-	
	Detune	√	√	-	-	-	
6	Pitchbend Sensitivity	√	√	√	-	-	Separate tracks
7-8	FX Select (A, B, C, D)	√ (A, B, C, D)	√ (C, D)	√ (A, B)	-	-	General parameters
	Modulating Track	√ (A/B, C/D)	√ (C/D)	√ (A/B)	-	-	
	B>A (or D>C) Send	√ (A/B, C/D)	√ (C/D)	√ (A/B)	-	-	
9-12	FX Parameters (A, B, C, D)	√ (A/B, C/D)	√ (C/D)	√ (A/B)	-	-	
13	Easy Program Edit	√	√	√	-	-	Separate tracks
14	Track Mode	√	√	√	-	-	
15	Track Internal/External	√	√	√	-	-	
16	Damper	√	√	√	-	-	
	Expression	√	√	-	-	-	
17	Joystick X	√	√	-	-	-	Only Realtime tracks
	Joystick Y	√	√	-	-	-	
18	Dynamic Range	√	√	-	-	-	
19	Ensemble Track	√	√	-	-	-	General parameters
	Ensemble Type	√	√	-	-	-	
	Dynamic	√	√	-	-	-	
	Tempo	√	√	-	-	-	
	Feedback	√	√	-	-	-	
20	V1-V4 Drum Map	√	-	√	-	-	
	Kick Designation	√	-	√	-	-	
	Snare Designation	√	-	√	-	-	
	Fill 1/2	√	-	√	-	-	
21	Program (Original/On)	√	-	√	-	-	Only Style tracks, globally
	Wrap Around	√	-	√	-	-	Only Style tracks
	Keyboard Range (Original/Off)	√	-	√	-	-	

Page	Parameter	Performance	Single Touch Setting (STS)	Style Performance	Global	Seq1+Seq2 Setup	Note	
22	Pad 1-4 Volume Pan C Send Level D Send Level	√ √ √ √ √	√ √ √ √ √	- - - - -	- - - - -	- - - - -	General parameters	
23	Pad Lock Scale Lock Auto Octave Lock Master Transpose Lock	- - - -	- - - -	- - - -	√ √ √ √	- - - -		
24	Chord Recognition Mode Scale Mode Memory Mode Velocity Control	- - - -	- - - -	- - - -	√ √ √ √	- - - -		
Song Play Mode								
Main	Program Play/Mute status	- -	- -	- -	- -	- √		Separate tracks
1	Volume	-	-	-	-	-		
2	Pan	-	-	-	-	-		
3	FX Send Level	-	-	-	-	-		General parameters
4	FX Select (A, B, C, D) Modulating Track B>A (or D>C) Send	- - -	- - -	- - -	- - -	√ √ √		
5-6	FX Parameters (A, B, C, D)	-	-	-	-	√		
7	Track Mode	-	-	-	-	-		
8	Track Internal/External	-	-	-	-	√	Separate tracks	
9	Jukebox	-	-	-	-	-	List saved to disk	
10	Link Mode S2 FX Mode Performance FX Mode	- - -	- - -	- - -	√ √ √	- - -	General parameters	
Song Mode								
	Song data	See table "Style and Song parameters"						
Global Edit Environment								
1	Velocity Curve Master Tune Scale Key Speakers On/Off Metronome Volume	- - - - - -	- - - - - -	- - - - - -	√ √ √ √ - √	- - - - - -	General parameters Set to "On" at startup	
2	Master Transpose onStyle/Realtime tracks ...Seq 1/2 ...Midi In Scale Transpose Position	- - - - -	- - - - -	- - - - -	√ √ √ √ √	- - - - -	General parameters	
3	Pedal/Switch Function Assignable Slider Function Damper Polarity Footswitch Polarity	- - - -	- - - -	- - - -	√ √ √ √	- - - -		
4	MIDI Setup Preset	-	-	-	-	-		
5	Local On/Off Clock Clock Send	- - -	- - -	- - -	- - √	- - -	Set to "On" at startup Set to "Int" at startup General parameters	
6	Midi In Channels (1...16)	-	-	-	√	-	Separate tracks	
7	Chord 1 Channel Chord 2 Channel Velocity Input	- - -	- - -	- - -	√ √ √	- - -	General parameters	
8	Upper Octave Lower Octave Octave Transp. on the Midi In Mute In	- - - -	- - - -	- - - -	√ √ √ √	- - - -		
9	Midi In Filters (1...8)	-	-	-	√	-		
10	Midi Out Channels (1...16)	-	-	-	√	-		
11	Midi Out Filters (1...8)	-	-	-	√	-	General parameters	
Disk Edit Environment								
	Global Protect Factory Styles Protect	- -	- -	- -	√ -	- -	Not saved to disk Set to "On" at startup	

Style and Song parameters

The following table is a list of data saved (to memory or disk) when editing a Style or a Song.

Note: When saving a Song to disk as a Standard MIDI File (SMF), all parameters are converted to ordinary track parameters. Pa80 exclusive data are converted to SysEx or Meta-Events, that will be ignored when reading the SMF on a different keyboard or sequencer.

Parameter	Style			Song		
	Header	Tracks	Master Track	Header	Tracks	Master Track
Volume (GM Master Volume) ^(a)	-	-	-	√	-	√
Tempo	-	-	-	√	-	√
Meter (Time Signature)	√	-	-	√	-	√
Programs ^(b)	√	-	-	√	√	-
Note On/Off	-	√	-	-	√	-
Pitch Bend	-	√	-	-	√	-
After Touch	-	-	-	-	√	-
Control Change ^(c)	-	√	-	-	√	-
Quarter Tone ^(a)	-	-	-	-	-	√
Quarter Tone Reset ^(a)	-	-	-	-	-	√
Chord Variation Length	√	-	-	-	-	-
Original Key/Chord	√	-	-	-	-	-
NTT	√	-	-	-	-	-
Expression	√	√	-	√	√	-
Keyboard Range	√	-	-	-	-	-
Chord Variation Table	√	-	-	-	-	-
Retrigger Mode	√	-	-	-	-	-
Tension	√	-	-	-	-	-
Play/Mute status ^(a)	-	-	-	√	-	-
Master Transpose ^(a)	-	-	-	√	-	-
Volume	-	-	-	√	√	-
Pan	-	-	-	√	√	-
FX Block ^(a)	-	-	-	√	-	-
FX Send	-	-	-	√	√	-
Detune	-	-	-	√	√	-
Scale ^(a)	-	-	-	√	-	√
Key	-	-	-	√	-	√
Note	-	-	-	√	-	√
Detune	-	-	-	√	-	√
Scale Yes/No ^(a)	-	-	-	√	-	-
Pitch Bend Range	-	-	-	√	√	-
FX Select (A, B, C, D) ^(a)	-	-	-	√	-	√
Modulation Track ^(a)	-	-	-	√	-	-
FX Feedback Send (B>A or D>C) ^(a)	-	-	-	√	-	√
FX Parameters (A, B, C, D)	-	-	-	√	-	-
Easy Program Edit	-	-	-	√	√	-
Track Mode ^(a)	-	-	-	√	-	-
Internal/External Mode	-	-	-	-	-	-

(a) Saved as SysEx data.

(b) For this Program to be used in a Style, the "Prog" parameter should be set to "Orig" in the Style Play mode. See "Prog (Program)" on page 49.

(c) Not all Control Change messages are allowed in Styles. Please see "List of recorded events" on page 54 for more information.

22. RECOGNIZED CHORDS

The following pages show the most important chords recognized by the Korg Pa80, when the selected Chord Recognition mode is Fingered 2 (see “Chord Recognition Mode” on page 50). Recognized chords may vary with a different Chord Recognition modes.

Major

3-note

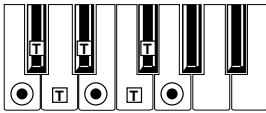

2-note

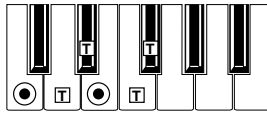

Major 6th

4-note

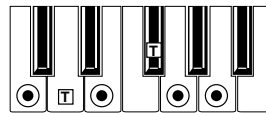

2-note



Major 7th

4-note

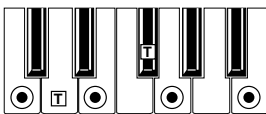

3-note

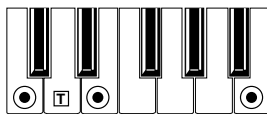

2-note



Sus 4

3-note

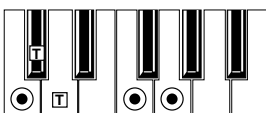

2-note

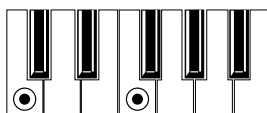

Sus 2

3-note

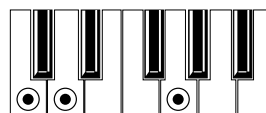

Dominant 7th

4-note

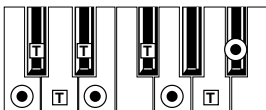

3-note

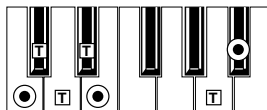

2-note

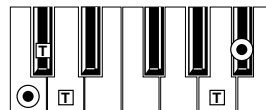

Dominant 7th Sus 4

4-note

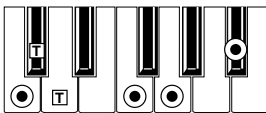

3-note

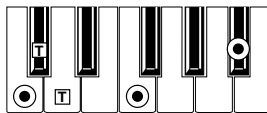

Dominant 7th b5

4-note

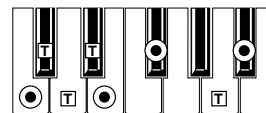

Major 7th b5

4-note

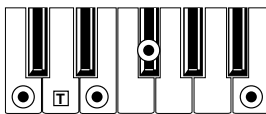

Major 7th Sus 4

4-note

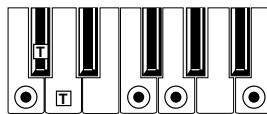

● = constituent notes of the chord

□ = can be used as tension

Minor

3-note

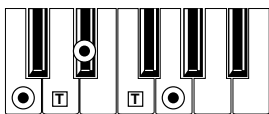

2-note

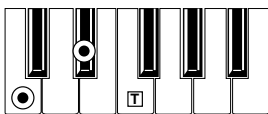

Minor 6th

4-note

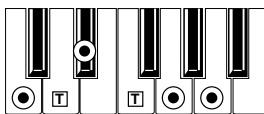

Minor 7th

4-note

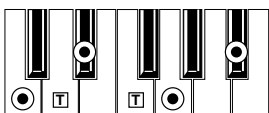

3-note



Minor-Major 7th

4-note

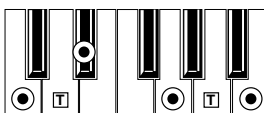

3-note

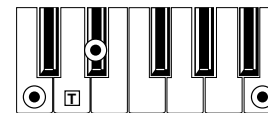

Diminished

3-note

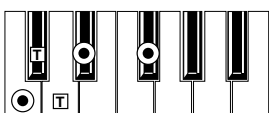

Diminished Major 7th

4-note

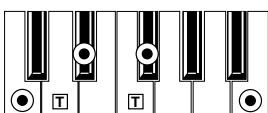

Minor 7th ^b5

4-note

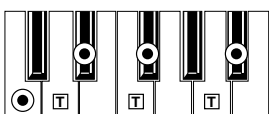

Augmented

3-note

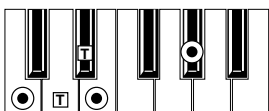

Augmented 7th

4-note

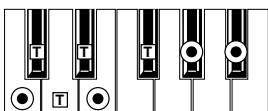

Augmented Major 7th

4-note

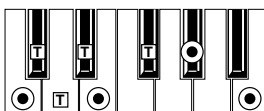

No 3rd

2-note

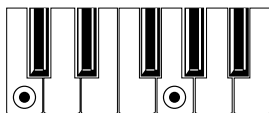

No 3rd, no 5th

1-note



● = constituent notes of the chord

⊠ = can be used as tension

23. ERROR MESSAGES & TROUBLESHOOTING

ERROR MESSAGES

Your Pa50 can communicate with you using various messages. Here is the list of these messages.

Messages can be of two different types:

- Waiting for your confirmation (Yes – No). Press ENTER/YES to go on, EXIT/NO to stop.
- Revealing an error or failure. Press any button on the front panel.

General

Another Command Is Running (Press Exit)

You can't execute a command until the one that is running is completed.

Are you sure? (Enter/Exit)

This is a confirmation request before many operations. Press ENTER/YES to confirm, EXIT/NO to abort.

Generic error

Some undefined error has happened.

Record Aborted

There is not enough memory to enter the Style Record, Song Record, or Backing Sequencer Record mode.

Style Play

Corrupted Style Perform. – Save It Again

The Style Performance was damaged. Press WRITE, and select the Current Style option, to save it to memory again.

Style Select Fails

Pa50 was not able to complete the operation.

Style Record

Arranger is Running! (Press Exit)

While in Style Record mode, this message may appear when you try to select a different track, or execute an edit operation, while the Arranger is running.

Low memory!

The space in the SSD (the space where User Styles are stored) is going low. Exit Record, then load some banks of smaller Styles before entering Record again.

Style Copy Failed (Press Exit)

Pa50 was not able to complete the Copy operation.

Style Delete Failed (Press Exit)

Pa50 was not able to complete the Delete operation.

Style Save Failed (Press Exit)

Pa50 was not able to complete the Save operation.

Style Select Failed (Press Exit)

Pa50 was not able to complete the selection.

SMF Import Failed! (Press Exit)

There was an error while reading the Standard MIDI File with the Import SMF function. The file may be corrupted.

Backing Sequence Mode

Too Many Styles! (Press Exit)

You have recorded the maximum number of Styles allowed (depending on the memory, 10 to 15 Style changes).

Song Play

Cannot Load JBX File to Seq 2 (Press Exit)

You can't load a Jukebox (JBX) file to Sequencer 2. Jukebox files can only be loaded to Sequencer 1.

Juke Box List Empty! (Press Exit)

You are trying to start playing back a Jukebox list, but the list is empty. Please add some Songs to the list.

Juke Box List Full! (Press Exit)

A Jukebox list may contain up to 127 Songs. You were trying to add one Song more.

Save Song List: Insert Disk and Press Enter

You are saving a list of Songs. Please insert a disk and press ENTER.

Save JBX List: Insert Disk and Press Enter

You are saving a list of Songs as a JBX file. Please insert a disk and press ENTER.

Wait Please

You were trying to load a file, while Pa50 is still loading another one.

Song

Too Many Events

You have tried to copy too many events on the same tick.

Out of Memory!

The memory limit for a Song (300KB) has been reached.

Incompatible Meter

You were trying to copy a track on a track with a different meter.

Sequencer is Running! (Press Exit)

While in Song Record mode, this message may appear when you try to select a different track, or execute an edit operation, while the Sequencer is running.

Song Play and Song mode

Cannot load Jukebox file on Seq.2

You can load a Jukebox file only on Sequencer 1.

Damaged Standard Midi File

The Standard MIDI File you are trying to load is damaged, and cannot be played back.

Jukebox list is empty

You tried to delete a Song in an empty Jukebox list, or to save an empty Jukebox list.

Jukebox list is full

The Jukebox list already contains 127 Songs.

Not a Standard Midi File

The selected file is not a Standard MIDI File, and cannot be played back. Select a ".MID" or ".KAR" file. Pa50 can play back Standard MIDI Files in 0- and 1-format.

Standard Midi File format 2

You have tried to read a Format 2 Standard MIDI File. Pa50 can't play this kind of file. Select a Standard MIDI Files in 0- and 1-format.

Program**Overwrite Program? (Enter/Exit)**

You are trying to store a Program to a memory location already occupied by a Program. Press ENTER to overwrite it, or EXIT to abort.

Disk mode**Can't Erase Old Korg Resource (Press Exit)**

You can't erase a single Style from a Korg i-series disk. You can only delete a whole file.

Can't Read Disk! (Press Exit)

The disk is probably damaged. Try again. If the message appears again, try with a different disk.

Can't Read File! (Press Exit)

The file you are trying to load, copy, erase or rename is damaged, or has a null size (0 kb), thus can't be read. This message during a New Dir operation means there are problems on the disk. Try loading the file from a different disk.

Copy Failed! (Press Exit)

An error occurred during Copy. Copy operation aborted.

Copy: Invalid Destination (Press Exit)

You tried to copy an ordinary file or folder into a ".SET" folder.

Corrupted Style Perf. Save it again

The Style Performance is damaged. Save it again by pressing WRITE, and selecting the "Current Style" option.

Delete all data. Continue? (Enter/Exit)

Formatting will delete all data on the disk you are ready to format. Be sure you have a copy of all data you wish to preserve.

Delete Destin. Files Failed! (Press Exit)

The file you were trying to overwrite could not be deleted.

Destination File Exists (Press Exit)

The file you are trying to copy already exists on target.

Directory Full (Press Exit)

You reached the maximum folder number for the root of the selected medium:

- 720 kb floppy disk: max 112 folders
 - 1.44 Mb floppy disk: max 224 folders
- Delete some files, or replace the disk.

Directory Not Empty (Press Exit)

You were trying to delete a directory still containing files. Delete these files, then delete the directory.

Directory not found (Press Exit)

The directory is not in the current medium. The disk has probably been replaced before finishing the disk operation. Insert the disk again, and try again.

Disk Full (Press Exit)

The selected medium (disk) is full. Delete files you are not interested to keep, or replace the disk with an empty one. Then, try again.

Disk not empty! (Sh+Enter to Format)

During a Backup, you inserted a disk containing some data. Please replace it with an empty one, or press SHIFT+ENTER to start formatting the disk.

Disk write-protected

The floppy disk is write-protected. Move the protection tab to close the hole, and try again. Be sure there aren't data you don't want to overwrite. Otherwise, replace the disk with an empty one.

Erase Failed! (Press Exit)

An error occurred during Erase. Erase operation aborted.

Error while converting (Press Exit)

While trying to load Korg i-series data, some errors occurred. The original file is probably corrupted, or its structure is too different from Pa-series data.

Error while formatting medium

An error was reported when formatting the medium (disk). The format procedure has been aborted. Try again. If formatting a floppy disk, replace the disk and try again.

Error while Writing! (Press Exit)

An error was reported while writing on the medium (disk). The procedure has been canceled. Select a different medium, and try again.

Existing Files Not Copied (Press Exit)

After a Copy procedure (no Overwrite selected), all files sharing the same name have not been copied.

Factory Styles Protected! (Press Exit)

The ".SET" file you just loaded included some banks of Factory Styles. Since the Factory Style Protect flag was switched on, Factory Style banks were not loaded. (See "Factory Style Protect" on page 142).

Fast Format Failed. Full Format? (Enter/Exit)

The Fast Format procedure failed. Press ENTER to go on with a Full Format procedure (slower).

File is protected

You have tried to write over a read-only or system file. Pa50 can't write over this kind of files. Should you need to write over one of these file, use a personal computer to change the file's properties, then try again. Read your computer's user's manual.

File/Dir Already Existing (Press Exit)

During a Rename or New Dir operation, you were trying to use an existing name. Use a different name.

File in Use (Press Exit)

The file you tried to delete is in use by another procedure. Wait for the procedure to be completed, then try again.

Files in Use Not Deleted (Press Exit)

This message may appear during an Erase operation. Files used by other procedures have not been erased.

Files in use have not been overwritten

This message may appear during a Copy with Overwrite operation. Files used by other procedures have not been copied.

File Is Protected (Press Exit)

You were trying to overwrite a protected file.

File Not Found (Press Exit)

The file is not in the current medium. The disk has probably been replaced before finishing the disk operation. Insert the disk again, and try again.

Format Completed (Press Exit)

Formatting has been successfully completed.

Format aborted (Press Exit)

Format operation aborted.

Format failed! (Press Exit)

An error occurred during Format. Format operation aborted.

Illegal name (Press Exit)

The name is not allowed on Pa-series instruments.

Insert 1.4MB FD and press Enter

While saving the operating system, Pa50 asks for a floppy disk (1.44 Mbyte, High Density).

Insert 1.4MB FD #[n] and press Enter

While executing a Backup procedure (see "Backup Data" on page 141), Pa50 asks for the first floppy disk (1.44 Mbyte, High Density). After filling this disk, the following disks will be asked for.

Place the label on the disks, and write their progressive number on it. You will use these numbers when restoring data (see "Restore Data" on page 142).

Insert Backup FD n.[n] and Press Enter

During a Restore operation (see "Restore Data" on page 142), you are prompted to insert Backup disks. Insert the disk with the shown number.

Invalid Copy Parameter (Press Exit)

The copy operation was not possible. Maybe you were trying to copy a file over itself, or copying nested folders.

Load Failed! (Press Exit)

The Load procedure has not been executed. Try again, or try with different files.

Make New Dir Failed! (Press Exit)

While trying to create a new directory, an error occurred.

Media Write-Protected (Press Exit)

The disk is physically protected. Remove the protection, and try again.

Memory full

This message appears in Backing Sequence mode, when the memory for recording a Song is full.

No Disk/Unformatted. (Sh+Enter to Format)

Either there is no floppy disk in the drive, or the disk is unformatted. Insert a disk, and try again, or press SHIFT+ENTER to start formatting the disk.

Not a Pa-series or Corrupted File

The file you are trying to load is not compatible with Pa-series instruments.

Not Enough Space on Media

There is no more space to load, save or copy data. The disk operation will be aborted. Replace the disk, and use an empty disk to save your data. Should this message appear during loading, the SSD (Solid State Disk)-based internal memory is full.

Nothing to Rename (Press Exit)

There are no items to rename.

Overwrite Existing File? (Yes/No)

You are writing data on an existing ".SET" folder, or on a file of type ".MID" or ".JBX".

Overwrite on Backup? (Enter/Exit)

Press ENTER/YES to overwrite files carrying the same name on the target device, or EXIT/NO to avoid overwriting any file.

Overwrite on Copy? (Enter/Exit)

Press ENTER/YES to overwrite files carrying the same name on the target device (Press Exit)/NO to avoid overwriting any file. File that are not yet on disk are always copied.

Overwrite Protected Files? (Enter/Exit)

Protected files cannot usually be overwritten. By pressing ENTER, you can overwrite them during the current operation.

Rename: Invalid Name (Press Exit)

You can't use the name you entered. Please retry and select a different name.

Rename: New Name Must Be a \".SET\"

You can't modify a ".SET" folder extension.

Rename Failed! (Press Exit)

An error occurred during Rename. Rename operation aborted.

Save Failed! (Press Exit)

An error occurred during Save. Save operation aborted.

Some Files Missing (Press Exit)

This message may appear at the end of a Restore operation. Some User file may be missing. This is not a problem for the Factory Data integrity.

Unit Not Found (Press Exit)

You were trying to access a storage device not available on your instrument.

Unformatted medium

You have selected a medium (disk) that is not yet formatted, or is in a format that Pa50 can't recognize. Format the medium using the Format procedure (see "Page 5 - Format" on page 140).

Wait

Pa50 is busy with a disk operation.

TROUBLESHOOTING

Problem	Solution	Page	
General problems			
Power does not turn on	Make sure that (1) the power cable is plugged into the outlet, (2) the cable is plugged into the connector on the back of the instrument, (3) and is not damaged, (4) there are no problems with the mains.		
	Is the power switch turned ON?		
	If the power still does not turn on, contact your dealer or the nearest KORG Service Center.		
No sound	Is a jack connected to the HEADPHONES connector? This would disable the internal speakers.	22	
	Check the connections of your amp or mixer.	22	
	Make sure that all the components of the amplifying system are turned on.		
	Are the MASTER VOLUME or ASSIGN.SLIDER sliders of the Pa50 set to a position other than "0"?	13	
	Is the Local parameter set to Off? Turn it On.	127	
	Is the Speaker parameter set to Off? Turn it On.	125	
Lowest note are not played	Is the Attack parameter value too high? Set it to a lower value, to let the sound start faster. Is the Volume parameter too low? Set it to a higher value.	43 45	
	When the SPLIT button is lit up, the keyboard will be divided into the Lower part (low notes, below the split point) and the Upper part (high notes, above the split point). Is the Lower track muted? Unmute it.	24	
Wrong sounds	Do the USER banks contain modified data? Load the appropriate data for the Song or the Style you wish to playback.	133	
	Has one of the USER Drum Kits been modified? Load the appropriate Drum Kits.	133	
	Have the Styles or Performances been modified? Load the appropriate data (Styles or Performances).	133	
Sound does not stop	Make sure that the damper switch polarity parameter is set correctly.	126	
The selected Style or Song cannot start	Make sure that the Clock parameter is set to Int. If you are using the MIDI Clock of another device, you must set the MIDI Clock parameter to MIDI, and make sure that the external device transmits MIDI Clock data.	127	
Does not respond to MIDI messages	Make sure that all MIDI cables are connected correctly.	22	
	Make sure that the external device is transmitting through MIDI channels enabled to receive in the Pa50.	46 78	
	Make sure that the MIDI IN Filters of the Pa50 do not prevent the reception of messages.	129	
Percussive instruments are not played correctly	Make sure that the Percussion and Drum Track is set to Drum Mode and the external device has not transposition applied.	46 78	
Some "clicks" can be heard when playing a percussive instrument	This is part of the sound, and not a problem.		
A background noise can be heard after selecting a Performance, Style or STS	The selected Performance, Style or STS recalled the effect "15 Analog Record", simulating the noise of a old vinyl recording.		
Disk related problems			
Cannot format a floppy disk	Are you using a 3.5 inch 2DD or 2HD floppy disk? You must use one of these types.		
	Is the disk inserted correctly?		130
	Is the write protect tab of the disk in the protect position?		130
Cannot save data to a floppy disk	Is the disk formatted?	140	
	Is the disk inserted correctly?	130	
	Is the write protect tab of the disk in the protect position?	130	
Cannot load data from a floppy disk	Is the disk inserted correctly?	130	
	Does the disk contain data compatible with the Pa50?	132	

24. TECHNICAL SPECIFICATIONS

Model: KORG Pa50	
Keyboard	61 keys, with velocity.
Operating System	KORG OPOS (Objective Portable Operating System). Multitasking, Load-While-Play feature. SSD (Solid State Disk)-resident. Upgradable from floppy disk.
Display	Backlit custom LCD
Data storage	8MB (>20MB equivalent) Internal Solid State Disk (SSD), 1.44MB Floppy Disk Driver (MS-DOS® compatible).
Sound generation system	KORG HI - Hyper Integrated.
Polyphony	62 voices, 62 oscillators. Filters with resonance.
Multitimbricity	40 tracks (2 x 16 Sequencer, 4 Realtime, 4 Pads)
Sound memory	32 Mbyte of PCM ROM, with Stereo Piano.
Programs	>660 (Single Oscillator, Double Oscillator), including a Stereo Piano and GM Level 2-compatible Programs. 32 Drum Kits, 128 User Programs, 64 User Drum Kits. Easy and Full Program Editing.
Effects	4 stereo digital multi-effect systems (with 89 effect types each).
Performances	160 Realtime Performance memories. Up to 304 Styles Performances with 4 Single Touch Setting each.
Styles	Up to 304 Styles, Solid State Disk-resident, freely reconfigurable. 8 Style tracks, 4 Single Touch Settings per-Style, 48 User Styles, programmable Style Performances and Single Touch Settings. Direct Disk reading feature. Compatible with old i-Series Styles. Style Record with Edit functions, Step Edit, Event Edit.
Single Touch Settings (STS)	4 x 304 (memorize Realtime tracks)
Style controls	4 Variations, 2 Fills, 2 Intros, 2 Endings, Counter In/ Break, Synchro Start/Stop, Tap Tempo/Reset, Fade In/Out, Bass Inversion, Manual Bass, Tempo Lock, Memory, Accompaniment Volume, Accompaniment Mute, Drum Mapping, Snare & Kick Designation, Single Touch.
General controls	Master Volume, Ensemble, Octave Transpose, Master Transpose, Split Point, Style Change, Tracks Volume, Quarter of Tone, Assignable Slider, Joystick, Dial.
Pads	4 Assignable Pads + Stop button
Song Play	XDS* Crossfade Dual Sequencer player - 2 Sequencers with separate Start/Stop, Pause, << (Rewind) and >> (Fast Forward) controls. Balance control. Lyrics data are displayed on-screen. Jukebox function. SMF Direct Player (formats 0 and 1).
Song / Backing Sequence	Easy Record function. Full featured sequencer. 16 tracks. SMF native format.
Pedals	Damper, Assignable (continuous, footswitch)
Realtime controllers	Joystick (pitch + modulation), Assignable slider, Pads
MIDI	IN, OUT, THRU. Individual track assignment. Auto-setup functions (MIDI Setup)
Audio Inputs	2 x In, Line impedance
Audio Outputs	2 Main (Left/Mono, Right)
Main Amplifier	2 x 15 Watt Amplifier
Speakers	2 x 10 double-cone speakers (bass-reflex box).
Power Consumption	26 Watt
Dimensions	W: 41.5" / 1054mm, D: 15.5" / 393mm, H: 5.9" / 150mm (without music stand)
Weight	24.8 lbs (11.25 kg)
Accessories	User's Manual, AC Power Adapter, Music Stand
Options	EXP-2 (Foot Controller), XVP-10 (Exp/Volume Pedal), PS-1 (Footswitch), DS-1H (Damper Pedal)

* Patent Pending

25. ALPHABETICAL INDEX

A

Acc/Seq Volume 10, 13
 AMS(Alternate Modulation Source)
 Resonance 112
 Arabic Scale 34
 Assignable Slider 126
 Attack 119
 Attack Level
 Amp EG 119
 Attack Time
 Filter EG 116
 Audio Inputs 10, 22
 Audio Outputs 10, 22

B

Backing Sequence mode 31, 82–87
 Backup 8, 141
 Balance 10, 18, 27, 30
 Bank Select 37
 BPM
 MIDI/Tempo Sync., LFO 121

C

Chord Recognition Mode 50
 Chord Scanning 17
 Cutoff Frequency 113

D

Damper 11, 47
 Polarity 126
 Decay Time
 Filter EG 116
 Delay
 LFO 120
 Demo 11
 Direct FD 40
 Disk 130–142
 Backup 141
 Format 140
 Write protection 130
 Display 19–21
 F1-F4 buttons 16, 19
 Page buttons 19
 Volume/Value buttons 16, 19
 Display Hold 17
 Double Sequencer 27, 70
 Drum mode 78
 Drum tracks 45, 99

E

Edit Environment 21

Effects

 Song mode 96, 97
 Song Play mode 71, 76
 Style Play mode 43, 44

Ending 14

Ensemble 47

F

F1-F4 buttons 16, 19

Fade

 LFO 120

Fill 14

Filter

 Cutoff Frequency 113
 Filter Type 112
 Low Pass & High Pass 112
 Low Pass Resonance 112

Footswitch 126

 Polarity 126

Format 140

G

General MIDI 35
 Global 125–129
 Global channel 35
 Groove Quantize 71

I

Inputs 10, 22

Intro 15

J

Joystick 47
 Jukebox 74, 79

K

Keyboard Mode 17
 Keyboard settings 24

L

Level

 Program
 Trim 112

LFO

 Waveform, LFO waveform 120

Local Off 37, 127

Lock 49

Low Pass & High Pass 112

Low Pass Resonance 112

Lyrics 73, 74

M

- Master Transpose 18, 126
- Master Tune 125
- Master Volume 10, 13
- Menu 15
- Message window 21
- MIDI
 - Chord channels 128
 - Clock 70, 127
 - General MIDI 35
 - Global channel 35
 - IN channels 127
 - Interface 22, 37
 - OUT channels 129
 - Setting a track for MIDI 78, 99
 - Setup 36, 126
 - Standard MIDI File 70, 88
- MIDI interface 22, 37
- MIDI Setup 36, 126
- Midifile 35, 70, 88
- Mode
 - Backing Sequence 82–87
 - Program 105–124
 - Song Play 70–81
 - Style Play 40–51
- Mute 16, 24

O

- Octave Transpose 18
- Offset
 - Offset, LFO 120
- Operating Modes 13, 20
- OS (Operating System)
 - Backup 8, 141
 - Update 9
- Outputs 10, 22

P

- Pads 18, 49
 - Lock 49
- Page 15, 19
- Pedal 126
- Performance 40
 - Selecting 17, 25
- Pitch Bend 44, 97
- Portamento
 - AMS 123
- Program
 - Editing 45, 98
 - Selecting 17, 26
- Program Change 37
- Program mode 105–124

R

- Resonance 112

S

- Scale
 - Lock 50
 - Main scale 125
 - Selecting in realtime 34
- Select
 - MFX Effect Select 121
- Selecting Windows 21
- Sequencer
 - Link mode 79
 - Selecting and switching 73
 - Sequencer 1 73
 - Sequencer 2 73
 - Sequencer 2 effects mode 80
 - Transport controls 18
- Shift 16
- Single Touch 14, 16, 26
- Single Touch Settings (STS) 16
 - Selecting 27
- Song
 - Editing 32
 - Playback from disk 27, 28, 73, 84, 89
 - Recording 31, 82
 - Selecting 73, 84, 89
 - Standard MIDI File 35
- Song Play mode 70–81
- Speakers On/Off 125
- Split Point 14, 36
- Standard MIDI File 35, 70, 88
- Style
 - Ending 14
 - Fill 14
 - Intro 15
 - Recording 52–69
 - Selecting 14, 26
 - Style Performance 40
 - Variation 14
- Style Change 25
- Style Play mode 40–51
- Sync.
 - Key Sync., LFO 120
 - MIDI/Tempo, LFO 121
- Synchro Start/Stop 15

T

- Tap Tempo 15
- Tempo 40
- Tempo/Value section 16
- Track Select 16, 73
- Tracks
 - Drum mode 78
 - Drum/Percussion 45, 99
 - Keyboard/Realtime tracks 24, 40, 70
 - Octave Transpose 18
 - Programs 17
 - Selecting 16, 24, 73
 - Volume 19, 43
- Transpose 18

Tune
Tune, Program 108

U

User Interface 20
Edit Environments 21
Operating Modes 20
Selecting Windows 21

V

VALUE slider
AMS 123
Variation 14
Velocity
AMS 123

Velocity Intensity, Amp Mod. 118

Velocity, Filter EG 114

Velocity Curve 125

Volume

Acc/Seq 10, 13, 71, 88

Balance 10

Individual tracks (Song Play) 75

Individual tracks (Song) 95

Individual tracks (Style Play) 43

Master 10, 13, 71, 88

Volume/Value section 16, 19

W

Write 15

Global 125

Style Play mode 42

KORG

Address

KORG ITALY Spa
Via Cagiata, 85
I-60027 Osimo (An)
Italy

Web servers

www.korg.co.jp
www.korg.com
www.korg.co.uk
www.jam-ind.com
www.korgfr.net
www.korg.de
www.korg.it
www.letusa.es