

## USER'S GUIDE

### Initial Setup



Preparing a Power Supply



Turning Power On or Off



Using Pedals



Using Commercially Available Headphones

### Playing the Digital Piano



Playing Notes with Different Tones



Sounding Two Different Tones at the Same Time (Layer)

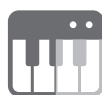

Splitting the Keyboard Between Two Tones (Split)



Using the Metronome

### Changing Sound Reverberation and Ambiance



Using the Sound Mode Effects (Hall Simulator/ Reverb and Surround)



Using Chorus (Chorus, Flanger, Short Delay)



Using Microphone Effects



Adjusting Acoustic Piano Sound Characteristics (Acoustic Simulator)

### Using the Mixer



Adjusting the Volume Level, Stereo Pan and Effects for Each Part

### Registering a Setup



Saving and Recalling Performance Setups (Registration)

### Recording Performances in Real-Time



Using the MIDI Recorder to Record Performances



Recording a Performance with the Audio Recorder

### Changing the Pitch



Changing the Pitch in Semitone Steps (Transpose)

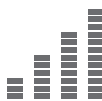

Fine Tuning a Pitch (Master Tuning)

### Connecting with a Smart Device



Using the Dedicated App

- When the Digital Piano is being operated on battery power only, notes may sound distorted when performing or playing back a song at maximum volume. This is due to the difference between AC adaptor power and battery power, and does not indicate Digital Piano malfunction. If you notice distortion, switch to AC adaptor power or lower the volume level.

- Any reproduction of the contents of this manual, either in part or its entirety, is prohibited. Except for your own, personal use, any other use of the contents of this manual without the consent of CASIO is prohibited under copyright laws.
- IN NO EVENT SHALL CASIO BE LIABLE FOR ANY DAMAGES WHATSOEVER (INCLUDING, WITHOUT LIMITATION, DAMAGES FOR LOSS OF PROFITS, BUSINESS INTERRUPTION, LOSS OF INFORMATION) ARISING OUT OF THE USE OF OR INABILITY TO USE THIS MANUAL OR PRODUCT, EVEN IF CASIO HAS BEEN ADVISED OF THE POSSIBILITY OF SUCH DAMAGES.
- The contents of this manual are subject to change without notice.
- The actual appearance of the product may be different from that shown in the illustrations in this User's Guide.
- The Bluetooth® word mark and logos are registered trademarks owned by Bluetooth SIG, Inc. and any use of such marks by CASIO COMPUTER CO., LTD. is under license. Other trademarks and trade names are those of their respective owners.
- Company and product names used in this manual may be registered trademarks of others.

## **Included and Optional Accessories**

Use only accessories that are specified for use with this Digital Piano.

Use of unauthorized accessories creates the risk of fire, electric shock, and personal injury.



- You can get information about accessories that are sold separately for this product from the CASIO catalog available from your retailer, and from the CASIO website.

<https://support.casio.com/global/en/emi/manual/PX-S7000/>



# Contents

<b>Overview and Setup</b>	<b>EN-6</b>
General Guide . . . . .	EN-6
Touch Operation and Notation Used in this Guide . . . . .	EN-9
Preparing a Power Supply . . . . .	EN-10
Using an AC Adaptor . . . . .	EN-10
Using Batteries . . . . .	EN-12
Turning Power On or Off . . . . .	EN-16
Auto Resume . . . . .	EN-17
Auto Power Off . . . . .	EN-17
Disabling Auto Power Off . . . . .	EN-17
Power On Alert and Illumination Effect . . . . .	EN-18
Using the Power On Alert Function . . . . .	EN-18
Panel Lights Off . . . . .	EN-19
Adjusting Display Contrast . . . . .	EN-19
Adjusting the Volume . . . . .	EN-19
Using Commercially Available Headphones . . . . .	EN-20
Outputting From the Speakers While Headphones are Connected . . . . .	EN-20
Headphone Mode . . . . .	EN-21
Using a Commercially Available Microphone . . . . .	EN-21
Operation Lock . . . . .	EN-22
Options for Connecting to Smart Devices, Computers, and External Audio Devices . . . . .	EN-23
Using the Included Wireless MIDI & Audio Adaptor . . . . .	EN-24
Returning to Initial Factory Defaults . . . . .	EN-24
<b>Operations Common to All Modes</b>	<b>EN-25</b>
Using the Touch Buttons and Touch Ring . . . . .	EN-25
Touch Ring Basic Operation . . . . .	EN-25
Setting the Sensitivity of the Touch Buttons and Touch Ring . . . . .	EN-26
Setting the Volume of the Sound Made When the Touch Ring is Used (Operation Click Volume) . . . . .	EN-26
Basic Operation for Contents of the Display . . . . .	EN-27
Selecting Operation Items . . . . .	EN-27
Navigating the Hierarchy of Setting Items . . . . .	EN-30
The F Button Menu and FUNCTION Menu . . . . .	EN-31
Using the F Button Menu . . . . .	EN-31
Using the FUNCTION Menu . . . . .	EN-33
Text Character Input . . . . .	EN-35
<b>Acoustic Settings for the Digital Piano and Playback of the Demo Songs</b>	<b>EN-38</b>
Selecting the Piano Position Setting . . . . .	EN-38
Listening to the Demo Songs . . . . .	EN-39

<b>Playing Notes with Different Tones</b>	<b>EN-41</b>
Selecting a Single Tone . . . . .	EN-41
Selecting a Tone by Number . . . . .	EN-41
Selecting a Tone by Category . . . . .	EN-42
Selecting a Tone with the Touch Buttons . . . . .	EN-42
Selecting a Tone with the F Buttons . . . . .	EN-43
Guitar and Bass Tones . . . . .	EN-43
Sounding Two Different Tones at the Same Time (Layer) . . . . .	EN-44
Layering Two Tones . . . . .	EN-44
Unlayering the Keyboard . . . . .	EN-45
Splitting the Keyboard Between Two Tones (Split) . . . . .	EN-46
Splitting the Keyboard Between Two Different Tones . . . . .	EN-46
Changing the Split Point . . . . .	EN-47
Unsplitting the Keyboard . . . . .	EN-47
Changing Part Settings (Volume Level, Octave Shift, Tuning, etc.) . . . . .	EN-48
<b>Applying Effects</b>	<b>EN-49</b>
Using the Sound Mode Effects (Hall Simulator/Reverb and Surround) . . . . .	EN-49
Enabling or Disabling the Hall Simulator/Reverb and Surround Effects . . . . .	EN-49
Specifying the Hall Simulator/Reverb Type . . . . .	EN-50
Adjusting the Depth of the Hall Simulator/Reverb Effect . . . . .	EN-51
Specifying the Surround Type . . . . .	EN-51
Using Chorus (Chorus, Flanger, Short Delay) . . . . .	EN-52
Changing the Chorus Type . . . . .	EN-52
Adjusting the Depth of the Chorus Effect . . . . .	EN-52
Adjusting Brilliance . . . . .	EN-53
Adjusting Acoustic Piano Sound Characteristics (Acoustic Simulator) . . . . .	EN-54
List of Acoustic Piano Sound Setting Items . . . . .	EN-55
Using Microphone Effects . . . . .	EN-56
Enabling or Disabling the Microphone Effect . . . . .	EN-56
Specifying the Microphone Effect Type . . . . .	EN-57
Changing Microphone Effect Settings . . . . .	EN-58
<b>Using the Mixer</b>	<b>EN-60</b>
Adjusting the Volume Level, Stereo Pan and Effects for Each Part . . . . .	EN-60
List of Mixer Setting Items . . . . .	EN-61
<b>Changing the Sound During a Performance</b>	<b>EN-62</b>
Using Pedals . . . . .	EN-62
PEDAL UNIT jack . . . . .	EN-62
EXPRESSION/ASSIGNABLE jack . . . . .	EN-63
Enabling/Disabling the Pedal Operation for Each Part (Upper 1/Upper 2/Lower) . . . . .	EN-66
Using the EX Buttons . . . . .	EN-67
Selecting the Functions Assigned to the EX Buttons . . . . .	EN-67
Using the CONTROL Button . . . . .	EN-69
Selecting the Function Assigned to the CONTROL Button . . . . .	EN-69
Specifying the Portamento Time . . . . .	EN-71

Using the Pitch Bend Wheel . . . . .	EN-72
Changing the Pitch Bend Range . . . . .	EN-72
Enabling/Disabling the Pitch Bend Wheel Operation for Each Part (Upper 1/Upper 2/Lower) . . . . .	EN-73
Changing the Pitch Bend Wheel Illumination Settings . . . . .	EN-73
<b>Using the Metronome</b>	<b>EN-74</b>
Starting or Stopping the Metronome . . . . .	EN-74
Changing the Metronome Settings (Tempo, Beat, Pattern, etc.) . . . . .	EN-74
<b>Using the Arpeggiator</b>	<b>EN-77</b>
Enabling or Disabling the Arpeggiator . . . . .	EN-77
Changing the Arpeggiator Pattern and Other Settings . . . . .	EN-77
<b>Saving and Recalling Performance Setups (Registration)</b>	<b>EN-79</b>
Saving a Setup Registration . . . . .	EN-80
Changing a Registration Bank Name . . . . .	EN-81
Recalling a Setup Registration . . . . .	EN-82
Freeze Function . . . . .	EN-83
Using a Pedal or an EX button to Cycle Through Multiple Setup Registrations (Sequential Recall) . . . . .	EN-84
Registration Memory Data . . . . .	EN-86
Saving to an External Device . . . . .	EN-87
<b>Using the F Button Set</b>	<b>EN-88</b>
Preset F Button Set List . . . . .	EN-88
Editing an F Button Set . . . . .	EN-89
Assigning a Function to an F Button (Creating a User F Button Set) . . . . .	EN-89
Changing the Name of an F Button Set . . . . .	EN-94
Erasing an F Button Set . . . . .	EN-96
F Button Function List . . . . .	EN-97
<b>Listening to Songs (SONG Mode)</b>	<b>EN-100</b>
Data Types of Playable Songs . . . . .	EN-100
Playing Back MIDI Data or Audio Data . . . . .	EN-101
Operations While Playing Back MIDI Data . . . . .	EN-103
Sounding Metronome While Playing Back MIDI Data . . . . .	EN-103
Adjusting the Volume Level of MIDI Data Playback (MIXER Settings) . . . . .	EN-103
Deleting a User Song . . . . .	EN-103
Operations While Playing Back Audio Data . . . . .	EN-104
Audio Center Cancel (Vocal Cut) . . . . .	EN-104
Adjusting the Volume Level or Effect Depth of Audio Data Playback (MIXER Settings) . . . . .	EN-104

<b>Recording Performances</b>	<b>EN-105</b>
MIDI Recorder and Audio Recorder Features . . . . .	EN-105
Using the MIDI Recorder to Record Performances . . . . .	EN-107
Recording with the MIDI Recorder . . . . .	EN-107
Recording a Second Track Over the First (System Track + Solo Track) . . . . .	EN-111
Playing Back MIDI Recorder Songs . . . . .	EN-112
Deleting a MIDI Recorder Song (Entire Song/Individual Tracks) . . . . .	EN-113
Items Reflected in Contents When Recording to the MIDI Recorder Song . . . . .	EN-114
Recording a Performance with the Audio Recorder . . . . .	EN-116
Recording Using the Audio Recorder . . . . .	EN-116
Playing Back a Song from the Audio Recorder . . . . .	EN-119
Deleting a Song from the Audio Recorder . . . . .	EN-120
<b>Adjusting Keyboard Sensitivity</b>	<b>EN-121</b>
Changing Keyboard Response to Key Velocity (Touch Response) . . . . .	EN-121
Changing Touch Response Sensitivity . . . . .	EN-121
Adjusting the Timing of Key Press to Sound (Hammer Response) . . . . .	EN-122
Adjusting the Hammer Response . . . . .	EN-122
Adjusting the Timing of Key Release to Sound Damping (Key-off Response) . . . . .	EN-123
Adjusting the Key-off Response . . . . .	EN-123
<b>Changing the Pitch</b>	<b>EN-124</b>
Changing the Pitch in Semitone Steps (Transpose) . . . . .	EN-124
Changing the Transpose Setting . . . . .	EN-124
Fine Tuning a Pitch (Master Tuning) . . . . .	EN-124
Adjusting the Tuning Separately for Each Part (Upper 1/Upper 2/Lower) (Part Fine Tune) . . . . .	EN-125
Changing the Pitch in Octave Units (Octave Shift) . . . . .	EN-126
Using Octave Shift Separately for Each Part (Upper 1/Upper 2/Lower) . . . . .	EN-126
Changing the Scale Tuning (Temperament) of the Keyboard . . . . .	EN-127
Changing the Scale . . . . .	EN-127
Enabling or Disabling Piano Stretch Tuning . . . . .	EN-128
<b>Splitting the Keyboard for Duet Play</b>	<b>EN-129</b>
Using the Duet . . . . .	EN-129
Configuring Duet Settings . . . . .	EN-131
<b>USB Flash Drive</b>	<b>EN-132</b>
Preparing a USB Flash Drive . . . . .	EN-132
Supported USB Flash Drives . . . . .	EN-132
Data Types Supported by the Digital Piano . . . . .	EN-133
Connecting a USB Flash Drive to and Detaching It from the Digital Piano . . . . .	EN-135
Formatting a USB Flash Drive . . . . .	EN-136
Saving MIDI Files or Audio Files for Playback on your Digital Piano to a USB Flash Drive . . . . .	EN-137
Saving Digital Piano Data to a USB Flash Drive . . . . .	EN-137
Loading USB Flash Drive Data into the Digital Piano's Internal Memory . . . . .	EN-139
Deleting a USB Flash Drive File . . . . .	EN-140
Renaming a USB Flash Drive File . . . . .	EN-141

<b>Configuring MIDI Settings</b>	<b>EN-142</b>
<b>Wireless Connections</b>	<b>EN-143</b>
Configuring Wireless (Bluetooth) Connection Settings . . . . .	EN-143
Checking the Wireless Connection Status . . . . .	EN-143
Enabling and Disabling the Digital Piano's Wireless Function . . . . .	EN-143
Notification Tones . . . . .	EN-144
Connecting the Digital Piano with a Bluetooth Low Energy MIDI Device . . . . .	EN-145
Connecting the Digital Piano with a Bluetooth Audio Device . . . . .	EN-146
Pairing the Digital Piano with a Bluetooth Audio Device . . . . .	EN-146
Deleting Bluetooth Audio Device Pairing Registration . . . . .	EN-147
<b>Using the Dedicated App</b>	<b>EN-149</b>
About the App for Smart Devices (CASIO MUSIC SPACE) . . . . .	EN-149
<b>Connecting with External Devices</b>	<b>EN-151</b>
Playing Sound from a Smart Device on This Digital Piano (Bluetooth Audio Connection) . . . . .	EN-151
Playing Audio from a Smart Device or Other Bluetooth-compatible Device on this Digital Piano . . .	EN-151
Adjusting the Volume Level or Effect Depth of Bluetooth Audio (MIXER Settings) . . . . .	EN-151
Bluetooth Audio Center Cancel (Vocal Cut) . . . . .	EN-152
Using MIDI with a Connected Computer or Smart Device . . . . .	EN-153
Connecting the Digital Piano with a Computer via USB MIDI . . . . .	EN-153
Connecting the Digital Piano with a Smart Device via USB MIDI . . . . .	EN-155
Outputting Digital Piano Notes Through an Amplifier or Audio Equipment (LINE OUT jacks) . . . . .	EN-157
Connecting to Audio Equipment . . . . .	EN-157
Connecting to a Musical Instrument Amplifier . . . . .	EN-158
<b>Deleting All Data in the Digital Piano's Internal Memory</b>	<b>EN-159</b>
<b>Troubleshooting</b>	<b>EN-160</b>
Error Messages . . . . .	EN-162
<b>Reference</b>	<b>EN-164</b>
Product Specifications . . . . .	EN-164
Operating Precautions . . . . .	EN-167
FUNCTION Menu Items . . . . .	EN-169
Microphone Effects List . . . . .	EN-177
Microphone Effect Type List . . . . .	EN-177
List of Effects in the Microphone Effects Module . . . . .	EN-178
Parameter List of Module Effects . . . . .	EN-179
Arpeggiator List . . . . .	EN-184
<b>MIDI Implementation Chart</b>	



# Overview and Setup

## General Guide

### ■ Front Panel

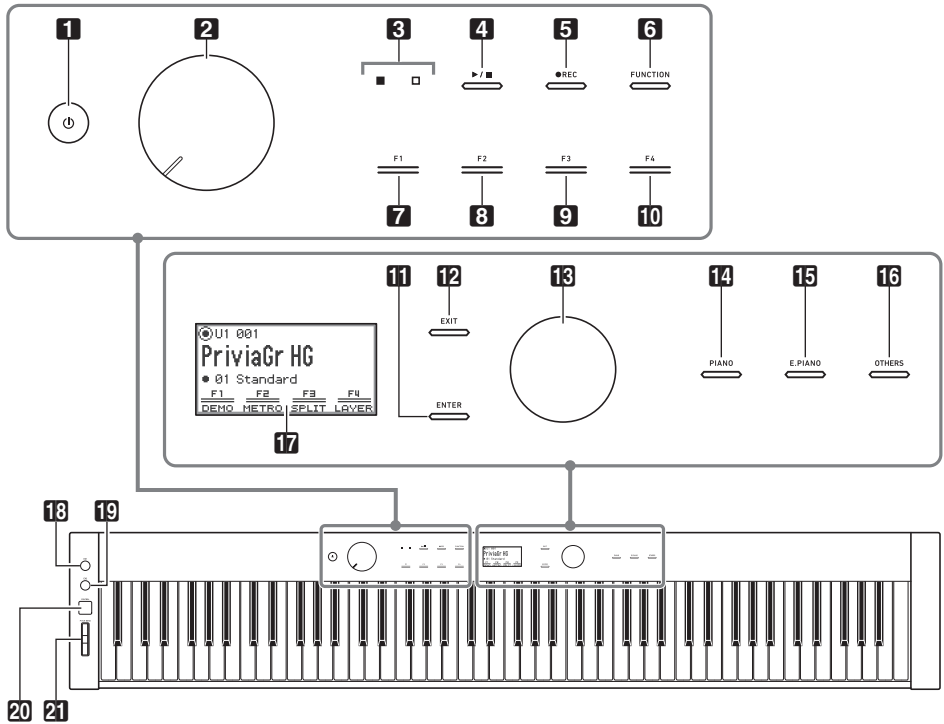

**1** (Power) button

**2** Volume knob

**3** LED (Red, White)

**4** button

**5** **REC** button

**6** **FUNCTION** button

**7** **F1** button

**8** **F2** button

**9** **F3** button

**10** **F4** button

**11** **ENTER** button

**12** **EXIT** button

**13** Touch ring

**14** **PIANO** button

**15** **E. PIANO** button

**16** **OTHERS** button

**17** Display

**18** **EX1** button

**19** **EX2** button

**20** **CONTROL** button

**21** **PITCH BEND** wheel

## Touch Buttons and Touch Ring

Turning on Digital Piano power causes all of the touch buttons (14 to 12, 14 to 13) and the touch ring (13) to light. The above illustration shows when all buttons are lit. During actual operation, only the buttons that are currently enabled are lit or flashing.

## Keyboard note names and pitches

The keyboard note names and pitches used in this manual follow the international standard. Middle C is C4, the lowest C is C1, and the highest C is C8. The illustration below shows keyboard key note names from C4 through C5.



## ■ Front

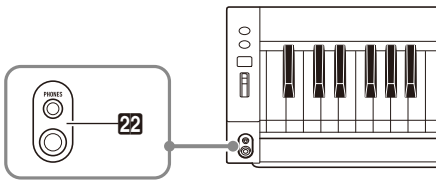

## 22 PHONES jacks

Top: stereo mini phone jack  
(Mini TRS phone)

Bottom: stereo standard phone jack  
(TRS phone)

## ■ Back

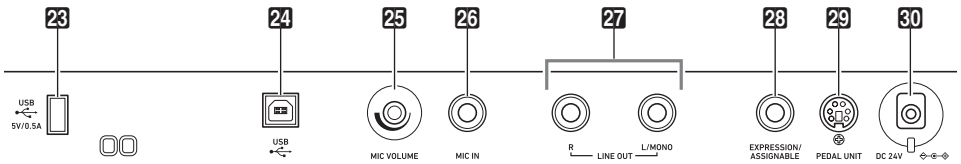

**23** **USB** Type A port

**24** **USB** Type B port

**25** **MIC VOLUME** knob

**26** **MIC IN** jack

**27** **LINE OUT R, L/MONO** jacks

**28** **EXPRESSION/ASSIGNABLE** jack

**29** **PEDAL UNIT** jack

**30** **DC 24V** terminal

## ■ Display (Top Screen)

The top screen is the screen that appears on the display when the Digital Piano is turned on.

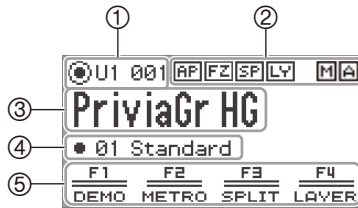

- ① Part name, Tone number
- ② Indicators
- ③ Tone name
- ④ F Button Set name
- ⑤ F Button Menu

### Inverted screens

The display of this Digital Piano shows screens white on a black background; however, this guide depicts them as black on a white background.

## ■ Preparing the Music Stand

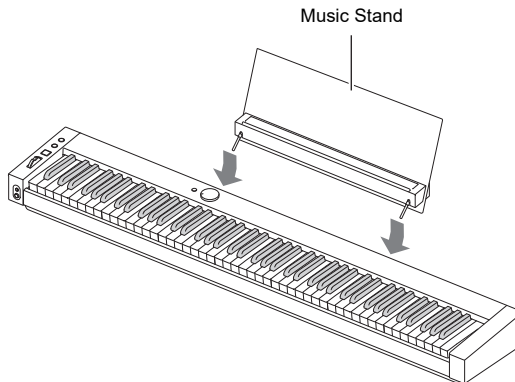

## Touch Operation and Notation Used in this Guide

### ■ Touch Ring Operation and Notation

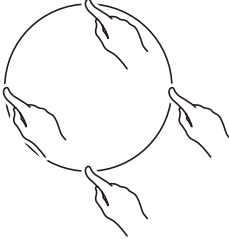
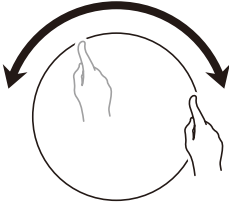
This operation	is shown like this
Touch and immediately release the top, bottom, left or right edge of the touch ring 	Touch top, bottom, left or right on the touch ring.  It is also written as follows: <ul style="list-style-type: none"> <li>• Use the touch ring to change the value.</li> <li>• Use the touch ring to select “___”.</li> </ul>
Trace the circumference of the touch ring with your finger in a counterclockwise or clockwise direction  (Acts as a controller to change settings.)	Trace on the touch ring.  It is also written as follows: <ul style="list-style-type: none"> <li>• Use the touch ring to change the value.</li> <li>• Use the touch ring to select “___”.</li> </ul>

### ■ Touch Button Operation and Notation

This operation	is shown like this
Touch and immediately release the <b>EXIT</b> button	Touch the <b>EXIT</b> button.
Hold the <b>EXIT</b> button down for about 2 seconds and then release it	Touch and hold the <b>EXIT</b> button.

### ■ F Buttons (F1 to F4) Operation and Notation

This operation	is shown like this
Touch and immediately release the <b>F1</b> button F Button Menu on the display: 	Touch the <b>F1</b> button (DEMO).  It is also written as follows: <ul style="list-style-type: none"> <li>• Touch the F button to which “DEMO” is assigned.</li> </ul>

## Preparing a Power Supply

The Digital Piano can be powered by an AC adaptor or AA batteries (alkaline or rechargeable nickel-metal-hydride).

### Using an AC Adaptor

Use only the AC adaptor (JEITA Standard, with unified polarity plug) that comes with this Digital Piano. Use of a different type of AC adaptor can cause malfunction of the Digital Piano.

#### <Specified AC Adaptor: AD-E24250LW>

Use the supplied power cord to connect the AC adaptor.

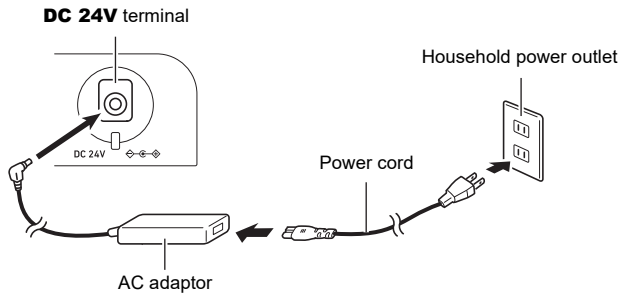

The AC adaptor cannot be repaired.

AC Adaptor Usage Environment Temperature: 0 to 40°C

Humidity: 10% to 90%RH

Output Polarity: 

### IMPORTANT!

- **Never connect the AC adaptor that comes with this Digital Piano to any other device besides this Digital Piano. Doing so creates the risk of malfunction.**
- **Make sure the Digital Piano is turned off before plugging in or unplugging the AC adaptor.**
- **The AC adaptor will become warm to the touch after very long use. This is normal and does not indicate malfunction.**
- **Unplug the AC adaptor from the power outlet if you do not plan to use the Digital Piano for a long time.**

## ■ Disconnect Protection Precautions

- (1) Never pull on the cord with excessive force.
- (2) Never repeatedly pull on the cord.
- (3) Never twist the cord at the base of the plug or connector.

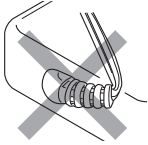

- (4) Loop and bundle the power cord, but never wind it around the AC adaptor.

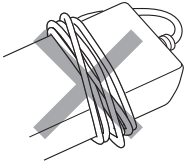

- (5) Before moving the Digital Piano, be sure to unplug the AC adaptor from the power outlet.

## ■ Locating the AC Adaptor for Use

- When using the AC adaptor, put in a location that satisfies the conditions below.
  - A location free of splashing liquids.  
The AC adaptor is designed for indoor use only. Do not put it in a location where it may become wet and do not place a vase or any other container of liquid on top of it.
  - A location that is not humid.
  - A roomy, well ventilated location.  
Do not cover the AC adaptor with newspaper, table cloth, curtain, or any other type of fabric.
  - Use a power outlet that is located near the Digital Piano.  
This will let you immediately unplug from the power outlet should any problem occur.
- When using the AC adaptor, place it on the floor with its label surface downwards. The AC adaptor becomes prone to emitting electromagnetic waves when the label surface is facing upwards.

---

## Using Batteries

---

### IMPORTANT!

---

- Be sure to turn off power before loading batteries.
- Use commercially available AA-size alkaline batteries or AA-size eneloop rechargeable batteries.
- Low battery power can cause abnormal operation. If this happens, replace batteries with new ones. If you are using rechargeable batteries, charge them.
- Note the precautions below while the Digital Piano is turned upside down to load batteries.
  - Take care to avoid injury due to pinching your fingers under the Digital Piano.
  - Do not allow the Digital Piano to tip over or otherwise be subjected to strong impact. Impact can damage the volume knob and keyboard keys.
- Be sure to replace batteries at least once a year, even if there is no indication of low battery power. Dead rechargeable batteries in particular may deteriorate if they are left in the product. Remove rechargeable batteries from the product as soon as possible after they go dead.

### ■ Rechargeable Batteries

Note the precautions below when using rechargeable batteries.

- Use Panasonic Group AA-size eneloop rechargeable batteries. Do not use any other type of batteries.
- Use only the specified charger to charge batteries.
- Rechargeable batteries must be removed from the product for charging.
- Dead rechargeable batteries may deteriorate if they are left in the product. Remove rechargeable batteries from the product as soon as possible after they go dead.
- For information about using rechargeable batteries or their specified charger, be sure to read the user documentation and precautions that come with each item, and use them only as directed.

**■ To load batteries**

- 1. Open the battery cover on the bottom of the Digital Piano.**

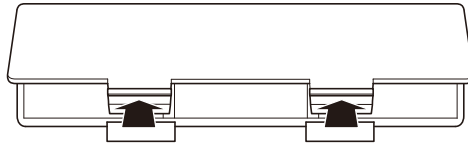

- 2. Load eight AA-size batteries into the battery compartment.**

- Load batteries with their positive ⊕ and negative ⊖ ends facing correctly.

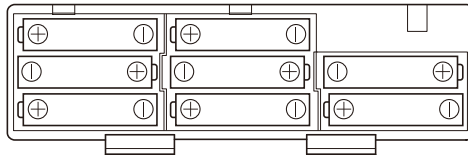

- 3. Insert the tabs of the battery cover into the holes along the side of the battery compartment, and close the cover.**

- Configure the setting below to specify the type of batteries you loaded.

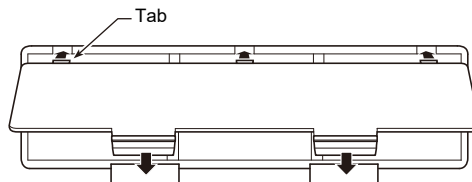



**■ To select the Battery Type**

Select the battery type that matches the battery installed in this Digital Piano's battery case.

- 1. Touch the **FUNCTION** button.**  
The **FUNCTION** menu appears.
- 2. Touch the top or bottom of the touch ring to select “SYSTEM” and then touch the **ENTER** button.**
- 3. Touch the top or bottom of the touch ring to select “Battery Type” and then touch the **ENTER** button.**  
The “Battery Type” screen appears.
- 4. Touch the top or bottom of the touch ring to select the battery type.**



Alkaline: Alkaline batteries

Ni-MH: Rechargeable nickel metal hydride batteries

## ■ Low Battery and Replace Battery Notifications

A battery icon appears on the display to let you know when battery power is getting low.

### Low Battery Indicator

Low battery icon (not flashing)



### Replace Battery Indicator

Replace battery icon (flashing)



## ⚠ IMPORTANT!

- To avoid possible injury, close the cover of the battery compartment before using the Digital Piano.
- Note that the battery compartment on the bottom of the Digital Piano may become hot in use.
- Using the Digital Piano while batteries are very low can cause it to turn off suddenly. This can cause data stored in the Digital Piano's internal memory to be corrupted or lost.

## Turning Power On or Off

1. Before turning on the power, turn the volume knob to the position shown below.

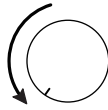

2. Press the **⏻** (Power) button to turn on the Digital Piano.

When the power is turned on, “Welcome” appears on the display.

- When the display changes to the top screen, the Digital Piano is ready to use.
- The time it takes for the Digital Piano to become ready to use depends on the internal memory usage.



Top screen

- Do not touch the pitch bend wheel when turning on the power.
- After pressing the **⏻** (Power) button, do not step on any pedals until the top screen appears.
- The Digital Piano may not turn on if the **⏻** (Power) button is pressed lightly, but this is not a malfunction. If this happens, firmly press the **⏻** (Power) button again.

3. Use the volume knob to adjust the volume.

4. To turn off the Digital Piano, press and hold the **⏻** (Power) button for a moment.

- The light of the touch ring goes around once and goes out, and the message “Bye” appears on the display.

### NOTE

- In its initial state, when the Digital Piano is turned on without the Wireless MIDI & Audio Adaptor installed, the **[M]** **[A]** indicator flashes briefly in the upper-right corner of the top screen to indicate that the Wireless MIDI & Audio Adaptor is not installed.
- Even after the power is turned off using the **⏻** (Power) button, the Digital Piano remains in standby mode with a small current flowing through it. Always disconnect the AC adaptor from the power outlet when the Digital Piano will not be used for an extended period or when there is a risk of lightning.
- When Auto Resume (page [EN-17](#)) is set to “Off”, turning off the power will reset various settings, but the Digital Piano still retains the following settings.

Tuning, LCD Contrast, pairing information (Bluetooth connection history), expression pedal type, expression pedal calibration, Touch Button Sensitivity, Touch Ring Sensitivity, Operation Click Volume, Auto Power Off, Wireless Notification Volume, Battery Type

## Auto Resume

When the Digital Piano is turned off, various settings such as tone numbers are reset. If “SYSTEM” > “Auto Resume” is set to “On” in the FUNCTION menu (page EN-33), most settings will be retained even when the power is turned off.

## Auto Power Off

This Digital Piano is designed to turn off automatically to avoid wasting power after no operation is performed for a preset amount of time. The Auto Power Off trigger time is about four hours when power is being supplied by the AC adaptor, or six minutes under battery power.

### Disabling Auto Power Off

You can disable Auto Power Off to ensure that power does not turn off automatically during a concert, etc.

#### NOTE

- The Auto Power Off function does not work when there is any input from a smart device that is wirelessly connected to the Digital Piano.

- 1. Touch the **FUNCTION** button.**  
The FUNCTION menu appears.
- 2. Touch the top or bottom of the touch ring to select “SYSTEM” and then touch the **ENTER** button.**
- 3. Touch the top or bottom of the touch ring to select “Auto Power Off” and then touch the **ENTER** button.**  
The “Auto Power Off” screen appears.
- 4. Touch the top or bottom of the touch ring and select “Off”.**



## Power On Alert and Illumination Effect

The “Power On Alert” function is a feature of the Digital Piano that is activated when the power is on but the Digital Piano has not been used for approximately six minutes. The “illumination effect” is an effect that is activated when the Power On Alert is active. The Power On Alert works only when the Digital Piano is being powered by the AC adaptor.



### Using the Power On Alert Function

The Power On Alert works as follows in accordance with audio input from a smart device (page [EN-146](#)) connected to the Digital Piano via Bluetooth®.

- If audio input is present (illumination effect is activated):  
The LEDs on the front panel of the Digital Piano illuminate in time with the song.
- No audio input (illumination effect is deactivated):  
The display and all LEDs on the front panel of the Digital Piano will be off, and only the pitch bend wheel will be lit.

When you perform any operation, such as touching a button or pressing a keyboard key, the Digital Piano will return to its normal state. If you forgot to turn off the power, press and hold the  (Power) button until “Bye” appears on the display to turn off the power.

#### NOTE

- When the Digital Piano is used with the AC adaptor and is turned on, briefly pressing the  (Power) button causes it to immediately enter the same state as when the Power On Alert function is active. If there is any audio input, the illumination effect is activated.  
If the  (Power) button is pressed briefly while the Digital Piano is being powered by batteries, the touch buttons will be lit and unlit in turn (the illumination effect is not activated).
- If “SYSTEM” > “Power On Alert” is set to “Off” in the FUNCTION menu (page [EN-33](#)), the “Power On Alert” function will not work.

## Panel Lights Off

While the top screen (the screen that appears immediately after the power is turned on) is displayed, touching and holding the **EXIT** button until the light of the touch ring goes around once and then goes out will turn off most of the lights on the front panel, except the **FUNCTION** button and touch ring (the state the panel lights off). The front panel gives off a small amount of light, conserving power and making it easier to concentrate on playing the keyboard.

The Digital Piano maintains the state the panel lights off even when you play the keyboard or operate the pedals, pitch bend wheel, **EX** buttons, or **CONTROL** button. Touch the **FUNCTION** button or press the  (Power) button briefly to deactivate it.

### NOTE

- When the battery is used as the power source for the Digital Piano, it will automatically enter the “panel lights off” state to conserve power if the front panel (touch buttons, touch ring, etc.) is not used for about one minute.
- Even when using the AC adaptor, the lights can be set to turn off automatically after a set period to conserve power when no buttons are pressed for a certain amount of time (the light does not turn off automatically under initial default settings). Use “SYSTEM” > “Panel Light” in the FUNCTION menu (page [EN-33](#)) to specify the time (5, 30, 60, or 120 seconds) before the lights turn off.
- The panel light does not turn off during song playback or recording, or while there is an input from a smart device.

## Adjusting Display Contrast

To adjust the contrast of the display, use “SYSTEM” > “LCD Contrast” in the FUNCTION menu (page [EN-33](#)).

## Adjusting the Volume

Control the master volume of the Digital Piano using the volume knob.

### NOTE

- The mixer function (page [EN-60](#)) allows you to individually adjust the volume of the keyboard, song playback volume, and input volume from the **MIC IN** jack.

## Using Commercially Available Headphones

Using headphones cuts off output from the built-in speakers, which means you can practice playing even late at night without disturbing others.

- Be sure to turn down the volume level before connecting headphones to the **PHONES** jack.

### PHONES jacks

(Top: stereo mini phone jack (Mini TRS phone)/

Bottom: stereo standard phone jack (TRS phone))

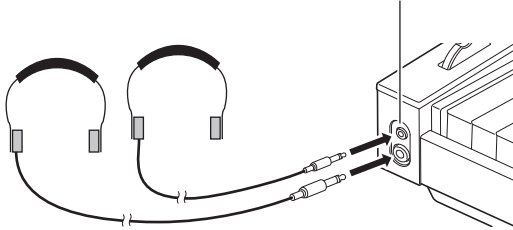

## IMPORTANT!

- Do not listen to very high volume output over headphones for long periods. Doing so creates the risk of hearing damage.
- When connecting headphones to the stereo mini phone jack, be sure to use a stereo mini phone plug (Mini TRS phone). Use of other types of plugs is not supported.
- If you are using headphones that require an adaptor plug, make sure you do not leave the adaptor plugged in when you unplug the headphones. If you do, nothing will sound from the speakers when you play.
- Use commercially available headphones that meet the following conditions.
  - Maximum input: 150mW or greater
  - Impedance: 32Ω or greater
- Use of the optional CP-16 headphones is not recommended.

## Outputting From the Speakers While Headphones are Connected

If “SYSTEM” > “Speaker Out” in the FUNCTION menu (page EN-33) is set to “On”, sound will come out of the speakers even if headphones are plugged into either **PHONES** jack.

- The setting values and details for this are as follows:

Setting value	Description
Off	The speakers do not output sound regardless of whether a plug is inserted into the <b>PHONES</b> jack.
On	The speakers output sound regardless of whether a plug is inserted into the <b>PHONES</b> jack.
Auto	When a plug is inserted into the <b>PHONES</b> jack, the Digital Piano’s speakers do not output sound; when a plug is not inserted, the speakers output sound.

## Headphone Mode

When “SYSTEM” > “Headphone Mode” in the FUNCTION menu (page [EN-33](#)) is set to “On” (the initial default setting) and headphones are used, the sound quality is automatically corrected to reproduce how an acoustic piano would sound when it naturally reaches the ears of a listener.

### NOTE

- The Headphone Mode setting is enabled when a plug is inserted into either **PHONES** jack.
- Regardless of the Headphone Mode setting, the sound output from the **PHONES** jacks and the **LINE OUT** jacks are the same.

## Using a Commercially Available Microphone

You can connect a commercially available dynamic microphone to the **MIC IN** jack and sound audio from the microphone with the Digital Piano.

You can adjust the volume level of microphone input with the **MIC VOLUME** knob. Microphone volume control is independent from overall Digital Piano volume.

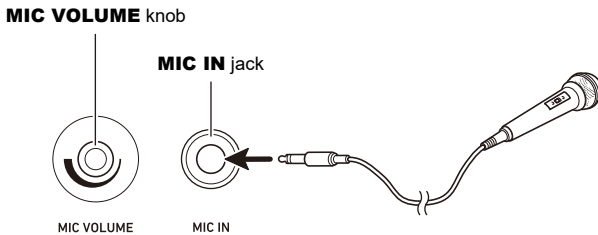

### IMPORTANT!

- Before connecting a microphone, make sure that the Digital Piano and microphone are turned off.
- Before connecting, set both overall Digital Piano volume and mic volume to their lowest levels. Adjust volume settings to appropriate levels after connecting the microphone.

### NOTE

- When connecting a microphone to the **MIC IN** jack, be sure to use a standard phone plug (TS phone). Use of other types of plugs is not supported.
- Various effects can be applied to the microphone input. For more information, see “Using Microphone Effects” (page [EN-56](#)).
- The mixer function allows you to independently adjust the volume of the microphone input audio and the send value to the Hall Simulator/Reverb. For more information, see “Using the Mixer” (page [EN-60](#)).



## Operation Lock

When Operation Lock is enabled (“On” or “Auto”), all button operations except the  (Power) button and the Operation Lock release operation are disabled to prevent accidental operation during a performance.

1. Touch the **FUNCTION** button.  
The FUNCTION menu appears.
2. Touch the top or bottom of the touch ring to select “SYSTEM” and then touch the **ENTER** button.
3. Touch the top or bottom of the touch ring to select “Operation Lock” and then touch the **ENTER** button.  
The “Operation Lock” screen appears.



4. Touch the top or bottom of the touch ring to change the setting value.

Setting value	Description
Off	Disables the Operation Lock.
On	The lights of all buttons except the <b>FUNCTION</b> button turn off, and all button operations except the  (Power) button and the <b>FUNCTION</b> button are disabled.
Auto	All button operations are disabled while playing. When you stop playing, it will return to the normal state (the same state as when “Operation Lock” is “Off”) after about one second.

5. Touch and hold the **EXIT** button to exit settings.  
When “On” is selected, all buttons except the **FUNCTION** button are disabled.

## Options for Connecting to Smart Devices, Computers, and External Audio Devices

The connection method for an external device depends on what you want to do. Refer to the section indicated for “Connection method” that matches “What you want to do” in the table below.

### NOTE

- “Smart devices” in the table below means smartphones (iPhone, Android) or tablets (iPad, Android).
- For details about “CASIO’s dedicated app” mentioned in the table below, see “[About the App for Smart Devices \(CASIO MUSIC SPACE\)](#)” (page EN-149).

What you want to do	Connect via <u>Wireless Connection</u> * <sup>1</sup>		Connect via <u>Cable</u>	
	Bluetooth audio	Bluetooth Low Energy MIDI	USB cable	Audio cable
I want to use CASIO’s dedicated app on my <u>smart device</u>	“Using the Dedicated App” (page EN-149)			—
I want to play the sound output by a <u>smart device</u> from this Digital Piano using Bluetooth audio	“Playing Sound from a Smart Device on This Digital Piano (Bluetooth Audio Connection)” (page EN-151)	—	—	—
I want to connect my <u>PC or smart device</u> to the Digital Piano and use MIDI	—	* <sup>2</sup>	“Using MIDI with a Connected Computer or Smart Device” (page EN-153)	—
I want to output the sound from this Digital Piano through <u>external speakers or audio equipment</u>	—	—	—	“Outputting Digital Piano Notes Through an Amplifier or Audio Equipment (LINE OUT jacks)” (page EN-157)

\*<sup>1</sup> Using the included Wireless MIDI & Audio Adaptor.

\*<sup>2</sup> Use with apps other than CASIO’s dedicated app is not guaranteed to work.

## Using the Included Wireless MIDI & Audio Adaptor

To pair this Digital Piano with a Bluetooth® wireless technology-capable external device, you need to plug the Wireless MIDI & Audio Adaptor into the Digital Piano's USB Type A port.

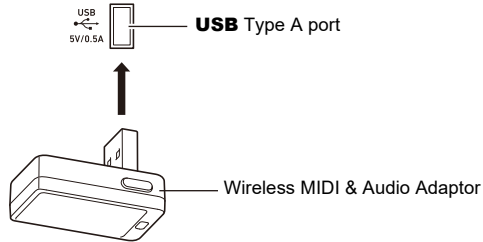

### **!** IMPORTANT!

- Turn off the Digital Piano before disconnecting the Wireless MIDI & Audio Adaptor.

## Returning to Initial Factory Defaults

You can use Factory Reset to return the Digital Piano's stored data and settings to their initial factory defaults any time you want. For more information, see "[To return all Digital Piano settings and data to their initial factory defaults \(Factory Reset\)](#)" (page [EN-159](#)).

# Operations Common to All Modes

## IMPORTANT!

- Unless otherwise specifically noted, all of the procedures in this manual assume that the Digital Piano is in its initial power on state (immediately after you turn on power). If you run into problems with a procedure, turn Digital Piano power off and back on, and then try performing the procedure again.
- Note that turning off Digital Piano power during a procedure causes any pending unsaved data to be deleted.

## Using the Touch Buttons and Touch Ring

Turning on Digital Piano power causes the touch buttons and touch ring to light.

### Touch Ring Basic Operation

The touch ring is used to move the cursor between items on a list and to change values.

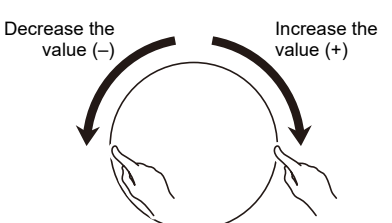
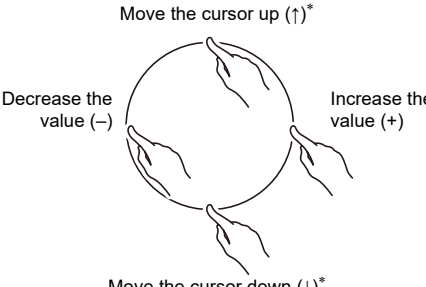
<ul style="list-style-type: none"><li>• Trace along the touch ring to continuously change the value of the currently selected item on the screen.</li></ul>	<ul style="list-style-type: none"><li>• Touch the left or right of the touch ring to change the value one unit at a time. Touch the top or bottom of the touch ring to move the cursor between items*.</li></ul>
	
<p>Tracing clockwise (+) along the touch ring until the value becomes its maximum value, it will stop at that value. Likewise, tracing counterclockwise (-) along the touch ring until the value becomes its minimum value, it will stop at that value.</p>	<p>Touching the left of the touch ring (-) after the minimum value is reached sets the maximum value. Likewise, touching the right of the touch ring (+) after the maximum value is reached sets the minimum value.</p>

\* While the close-up screen (page EN-29) or the value list screen (page EN-30) is being displayed, touching the top or bottom of the touch ring changes values.

## NOTE

- For an example of a specific operation using the touch ring, see “Basic Operation for Contents of the Display” (page EN-27).
- To reset the value of the item currently selected on the screen to its initial default value, touch and hold the **FUNCTION** button and touch the top, bottom, left, or right of the touch ring.

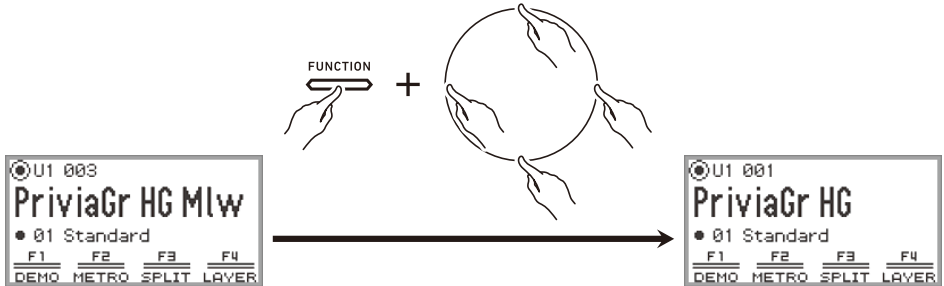



## Setting the Sensitivity of the Touch Buttons and Touch Ring

The sensitivity of the touch buttons can be adjusted using “SYSTEM” > “Touch Btn Sense” in the FUNCTION menu (page EN-33). You can also adjust the sensitivity of the touch ring using “SYSTEM” > “Touch Ring Sense”.

### ■ If Operation Becomes Difficult Due to Low Sensitivity Settings

If operation becomes difficult or impossible after using the FUNCTION menu to lower the touch button and touch ring sensitivity, you can set the touch button and touch ring sensitivity to a higher level than normal using the procedure below.

1. Turn off the Digital Piano.
2. While pressing the C8 key (rightmost key), press the  (Power) button.
  - You can release the  (Power) button immediately, but do not release the C8 key until “Welcome” appears on the display.

## Setting the Volume of the Sound Made When the Touch Ring is Used (Operation Click Volume)

The “SYSTEM” > “Op. Click Volume” in the FUNCTION menu (page EN-33) can be used to adjust the volume of the click sound made when the touch ring is used.

## Basic Operation for Contents of the Display

### Selecting Operation Items

The dots (●) shown on the display of the Digital Piano indicate items that can be used with the touch ring or **ENTER** button.

- When the cursor is on a dot (●), you can change the value of that item by tracing along the touch ring.
- When the cursor is on a dot (●), touch the **ENTER** button to display the list screen (category list screen or value list screen) corresponding to that item\*.
- Move the cursor (○) by touching the top or bottom of the touch ring.

\* Operations after touching the **ENTER** button are described in a later section.



Select the item to adjust and use the touch ring to change its value. Try out the following operations.

### 1. Turn on the Digital Piano.

The top screen appears.



## 2. Touch the top or bottom of the touch ring.

Each touch of the touch ring moves the cursor (○) between the dots.



## 3. Move the cursor (○) to the item whose value you want to change.

For example, move the cursor (○) to "Part name and tone number".

Part name and tone number



## 4. Touch the left or right or trace along the touch ring.

The value at the cursor position (tone number in this example) changes.



- Instead of touching the left or right or tracing along the touch ring, you can use the value list that appears when you touch the **ENTER** button. Refer to the following to use this method.
  - “Navigating the Hierarchy of Setting Items” (page EN-30)
  - “Using the F Button Menu” (page EN-31)
  - “Using the FUNCTION Menu” (page EN-33)

## ■ Close-Up Screen

If the setting of "SYSTEM" > "Close-up" in the FUNCTION menu (page [EN-33](#)) is changed from "Off" (default value) to "On", the display will show a "close-up screen" that magnifies the value whenever you trace along the touch ring to change a value. For example, in Step 4 above, the following screen will appear.



- While the close-up screen is displayed, you can also change values by touching the top, bottom, left, or right of the touch ring.
- The display returns to the original screen after about 5 seconds once you remove your finger from the touch ring.
- To immediately return to the previous screen, touch the **EXIT** button.



## Navigating the Hierarchy of Setting Items

Use the settings list screen to select from many options for tones, functions, or specific settings. The following is a schematic for navigating the hierarchy of setting items and for the sequence of operations when selecting categories, setting values, etc.

- A** Touch left or right or trace along the touch ring to directly select the setting value of the item highlighted by the cursor (○).
- B** Touching the **ENTER** button brings up a list of options for the item highlighted by the cursor (○), allowing you to select a setting value using the touch ring while viewing the list.

Try out using the **ENTER** button, **EXIT** button, and touch ring while referring to the following.

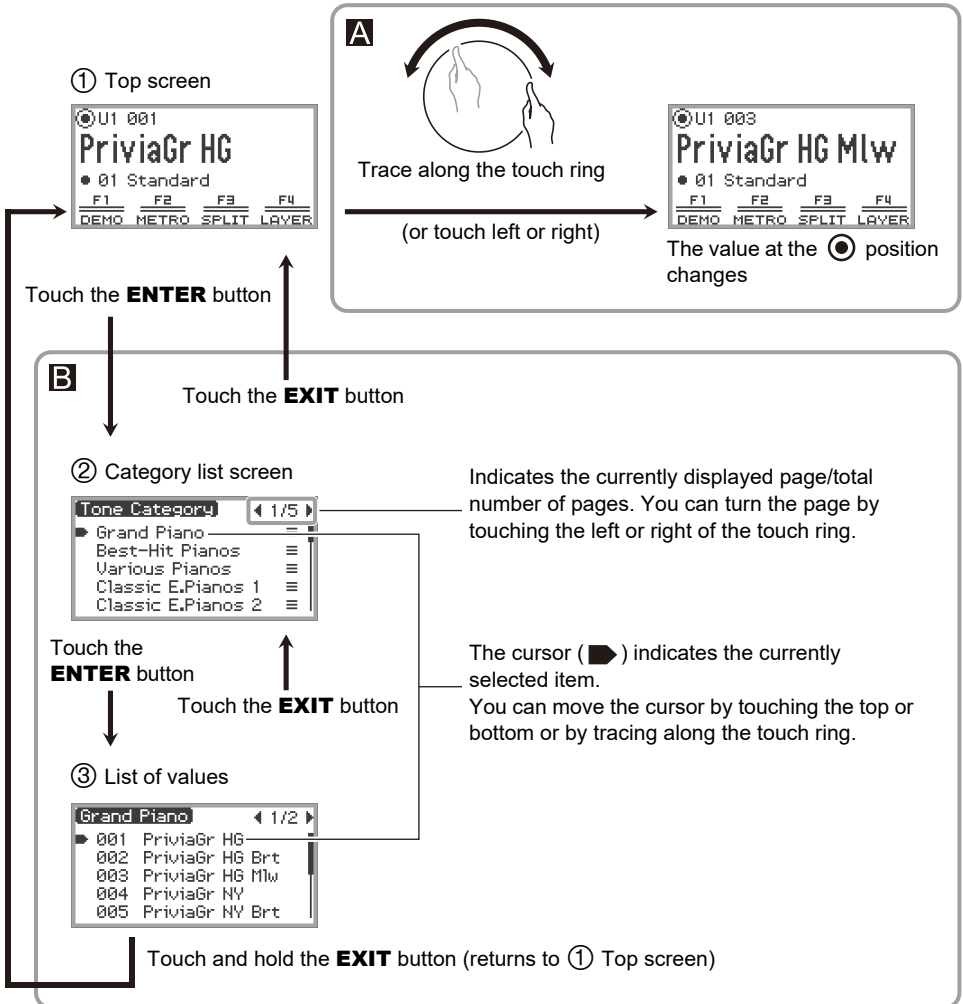

## NOTE

- Touch and hold the **EXIT** button to return to the top screen.
- The description of each operating procedure in this manual omits the step of returning to the first screen using the **EXIT** button at the end of each procedure.

## The F Button Menu and FUNCTION Menu

### Using the F Button Menu

The F button menu shown at the bottom of the display represents the functions that will be activated when you touch the F buttons (**F1** to **F4**).

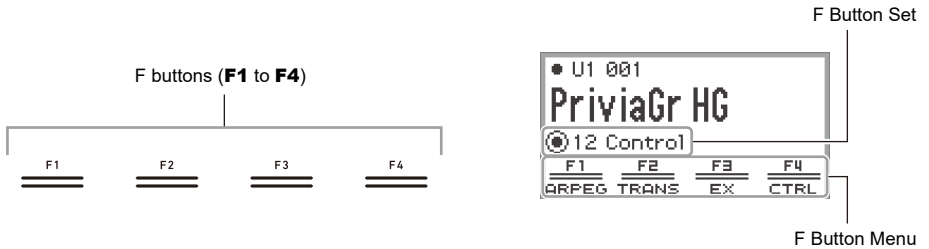

The functions displayed in the F button menu are switched by changing the F Button Set (01 to 30).

## ■ To change the F Button Set

1. Touch the top or bottom of the touch ring on the top screen to move the cursor (○) to the F Button Set row.

2. Touch the left or right or trace along the touch ring.

The F Button Set changes and the content of the F button menu changes, as well.



### NOTE

- You can also change the F Button Set using the F Button Set list screen that appears when you touch the **ENTER** button in Step 2.



- The 30 F Button Sets include 14 presets (fixed F button functions and set names) and 16 open slots where users can freely assign functions and set names (user F Button Sets). For more information, see “Using the F Button Set” (page EN-88).

## ■ Significance of [ ] in the F Button Menu

If an F button is assigned a function that is toggled on and off each time the button is touched, the F button name appears in brackets [ ] when the function is on. When off, the brackets [ ] will disappear.

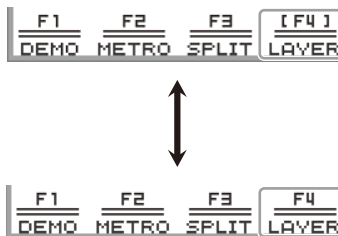

## Using the FUNCTION Menu

Touch the **FUNCTION** button to display the FUNCTION menu. This menu can be used to access most of the functions and settings of the Digital Piano.

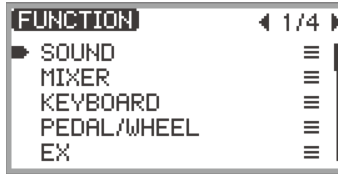

### FUNCTION Menu Operation Example

As an example, this section describes how to change the “Hammer Response” setting.

#### 1. Touch the **FUNCTION** button.

The FUNCTION menu appears.

#### 2. Use the touch ring to select “KEYBOARD” > “KBD SETTING” > “Hammer Response”, in that order.

• In this manual, menu operations are written as shown above. Specific operations are as follows.

- (1) Trace the touch ring to move the cursor (▀) to “KEYBOARD”, and then touch the **ENTER** button.

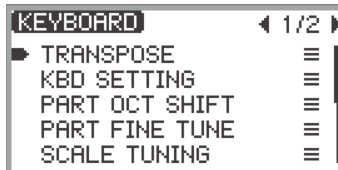
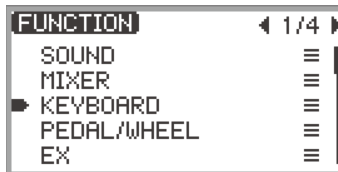

- (2) Trace the touch ring to move the cursor (▀) to “KBD SETTING”, and then touch the **ENTER** button.

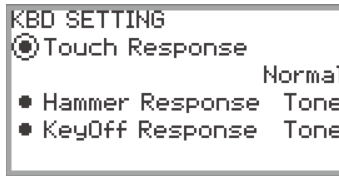

- (3) Move the cursor (○) to “Hammer Response” by touching the top or bottom of the touch ring. (This time, it is not necessary to touch the **ENTER** button.)

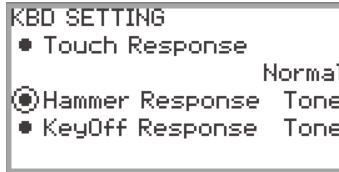

### 3. Change the value.

- Touch the left or right or trace along the touch ring.

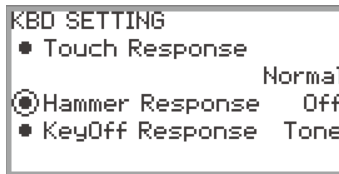

- You can also touch the **ENTER** button to display the value list screen and change the value there.

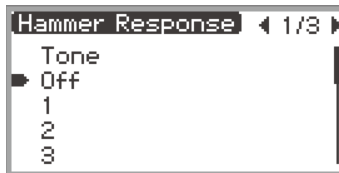

- While touching and holding the **FUNCTION** button, touching the top, bottom, left, or right of the touch ring will return it to the initial default value.

#### **NOTE**

- In the FUNCTION menu, each touch of the **EXIT** button moves one level up from the currently displayed level. Touch and hold the **EXIT** button to return to the top screen from any level.
- For details on all FUNCTION menu items, see “FUNCTION Menu Items” (page EN-169).

## Text Character Input

Use the procedure below when you need to change the name of Registration Bank (page EN-81), F Button Set (page EN-94), data saved on a USB flash drive or to input or edit other text (page EN-137).

### NOTE

- USB flash drive (page EN-132) file names can be up to 231 characters long.
- Up to 8 characters can appear on the display at a time.

### ■ To change a character

1. Touch the left or right of the touch ring on the text editing screen to move the cursor to the character you want to change.

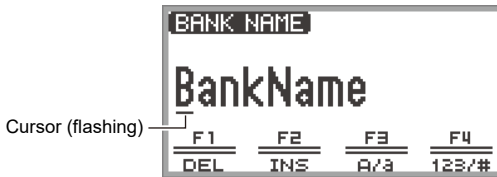

2. Trace the touch ring to change the character.

- Touching the **F3** button (A/a) switches between uppercase and lowercase letters when the cursor is located at a letter of the alphabet. When the cursor is located at a number or symbol, it switches to "A".
- Touching the **F4** button (123/#) switches between numbers and symbols when the cursor is located at a number or symbol. If the cursor is located at a letter of the alphabet, it switches to "0".
- The characters that can be used in the names of F Button Sets and Registration Banks are listed in the table below.

	0	1	2	3	4	5	6	7	8	9
A	B	C	D	E	F	G	H	I	J	K
L	M	N	O	P	Q	R	S	T	U	V
W	X	Y	Z	a	b	c	d	e	f	g
h	i	j	k	l	m	n	o	p	q	r
s	t	u	v	w	x	y	z	!	"	#
\$	%	&	'	(	)	*	+	,	-	.
/	:	;	<	>	=	?	@	[	]	\
^	_	`	{	}						

(First cell in the above table is blank.)

- The characters shown in the table below are supported for file names on an exFAT formatted USB flash drive.

	0	1	2	3	4	5	6	7	8	9
A	B	C	D	E	F	G	H	I	J	K
L	M	N	O	P	Q	R	S	T	U	V
W	X	Y	Z	a	b	c	d	e	f	g
h	i	j	k	l	m	n	o	p	q	r
s	t	u	v	w	x	y	z	!	#	\$
%	&	'	(	)	+	,	-	.	;	=
@	[	]	^	_	`	{	}	~		

(First cell in the above table is blank.)

- The characters shown in the table below are supported for file names on a FAT 32 formatted USB flash drive.

0	1	2	3	4	5	6	7	8	9
A	B	C	D	E	F	G	H	I	J
K	L	M	N	O	P	Q	R	S	T
U	V	W	X	Y	Z	\$	&	'	(
)	-	@	^	_	`	{	}	~	

### 3. Repeat steps 1 and 2 as many times as necessary.

#### ■ To insert a character

#### 1. Touch the left or right of the touch ring on the text editing screen to move the cursor to the position where you want to insert characters.

- To insert a character at the end of a string (append), move the cursor to the rightmost character and then touch the right of the touch ring again.

#### 2. Touch the **F2** button (INS).

An "A" is inserted at the cursor position.

- In this state, the inserted "A" can be changed to another character. Perform Step 2 onward of "To change a character" above.

#### ■ To delete a character

#### 1. Touch the left or right of the touch ring on the text editing screen to move the cursor to the character you want to delete.

#### 2. Touch the **F1** button (DEL).

**■ To save edited text****1. Touch the **ENTER** button on the text editing screen.**

A confirmation screen appears. To return to the text editing screen and continue editing, touch the left (NO) of the touch ring.

**2. To save your edits, touch the right (YES) of the touch ring.**

"Complete" appears, and the display returns to the screen that preceded the text editing screen.

**■ To discard edited text****1. Touch the **EXIT** button on the text editing screen.**

A confirmation screen appears. To return to the text editing screen and continue editing, touch the left (NO) of the touch ring.

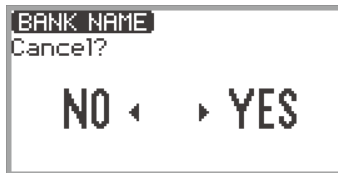
**2. To discard the edits, touch the right (YES) of the touch ring.**

Returns to the screen used before editing started.



# Acoustic Settings for the Digital Piano and Playback of the Demo Songs

## Selecting the Piano Position Setting

You can select the acoustic settings appropriate for the Digital Piano's location.

1. Select "04 Listening" of the F Button Set. See "To change the F Button Set" (page EN-32).



2. Touch the **F3** button (PPOSI).

The "PIANO POSITION" screen appears.

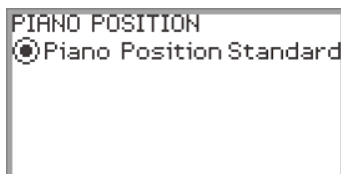

3. Trace the touch ring to select the setting that fits the location of the Digital Piano.

Setting value	Description
Standard	Standard setting when the Digital Piano is on a stand and is against (or near) a wall.
Wall	Assumed when the back of this Digital Piano is against a wall.
Center	Assumed when this Digital Piano is in the center of a room.
Table	Standard setting when the Digital Piano is placed on top of a table.

Select a setting you like in accordance with the Digital Piano's actual positioning.

## Listening to the Demo Songs

Follow the steps below to play back the built-in demo songs in sequence.

1. Select the “01 Standard” of the F button set. See “To change the F Button Set” (page EN-32).



2. Touch the **F1** button (DEMO).

The ►/■ button flashes and the demo song is waiting to start.

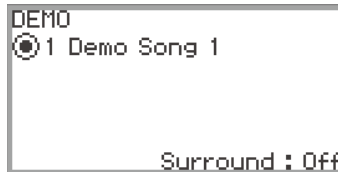

3. To select a song, trace the touch ring.

- You can also select a song as follows.
- (1) Touch the **ENTER** button to display the song list screen.

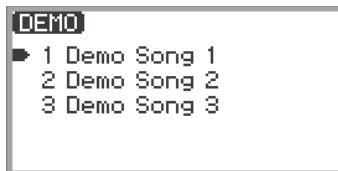

- (2) Trace the touch ring or touch the top or bottom of the touch ring to move the cursor to the song you want to select.
  - (3) Touch the **EXIT** button to return to the screen displayed in step 2.
- The steps to select a song can also be performed during demo song playback.

**4. To start the demo song, touch the ►/■ button.**

- Each time the ►/■ button is touched after this, the demo song is stopped or resumed.

**5. To return to the top screen, touch the EXIT button.** **NOTE**

- If Auto Power Off (page EN-17) is enabled, power will turn off automatically at the applicable trigger time after a period of non-use, even if a demo song is being played back.
- You can play along with the demo song on the keyboard. The keyboard tone will be the melody tone of the song being played (the tone cannot be changed).
- During the demo song, the following functions are assigned to the **CONTROL**, **EX1**, and **EX2** buttons, respectively (the functions cannot be changed).

**CONTROL** button: Modulation

**EX1** button: Arpeg On/Off

**EX2** button: Arpeg Hold

# Playing Notes with Different Tones

## Selecting a Single Tone

This Digital Piano has many tones available. Choose your favorite tone and play it.

### NOTE

- For details about tone categories and the names of tones included in each category, refer to the separate “Built-in Music Data Lists”.

## Selecting a Tone by Number

1. Touch the top or bottom of the touch ring on the top screen to move the cursor (○) to the part name and tone number.

Part name: U1 (Upper 1)

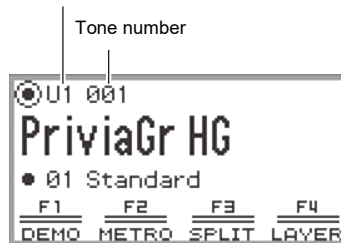

- When “U1” is displayed as the part name, the tone of the “Upper 1” part sounds when you play a keyboard key. For more information about parts, see “[Sounding Two Different Tones at the Same Time \(Layer\)](#)” (page EN-44) and “[Splitting the Keyboard Between Two Tones \(Split\)](#)” (page EN-46).

2. Trace the touch ring.

Tones are switched in numerical order.



3. When the desired tone name appears, take your finger off the touch ring.

## Selecting a Tone by Category

1. Touch the top or bottom of the touch ring on the top screen to move the cursor (○) to the part name and tone number.
2. Touch the **ENTER** button.  
A list of tone category names is displayed.



3. Use the touch ring to select a tone category then touch the **ENTER** button.  
A list of tone names is displayed.

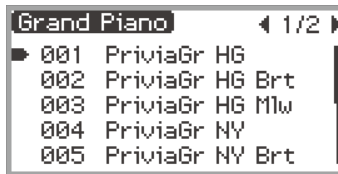

4. Use the touch ring to select a tone.
5. After selecting the desired tone, touch and hold the **EXIT** button.  
Return to the top screen.

## Selecting a Tone with the Touch Buttons



With each touch of the tone buttons, the first tone of each tone category is selected in turn.

## Selecting a Tone with the F Buttons

1. Select the “07 Piano Collect” or “08 E.PianoCollect” of the F button set. See “To change the F Button Set” (page EN-32).



2. Touch one of the **F1** to **F4** buttons, to select the tone you want.

- The tones in the table below can be selected with a single touch.

	07 Piano Collect	08 E.PianoCollect
<b>F1</b> button	001 Privia GRAND HG	049 SPACE BOY EP
<b>F2</b> button	004 Privia GRAND NY	044 JUST THE WAY EP
<b>F3</b> button	007 Privia GRAND BN	056 INDESTRUCTIBLE EP
<b>F4</b> button	011 CLOCK PIANO	059 WHERE IT IS EP

### NOTE

- You can assign your own favorite tones to each F button using the F button set for which functions have not yet been assigned. For more information, see “Using the F Button Set” (page EN-88).

## Guitar and Bass Tones

The built-in guitar and bass tones may contain strum noise, ghost notes, or other sound effects depending on the sound (pitch and intensity). For more information, refer to the separate “Built-in Music Data Lists”.

## Sounding Two Different Tones at the Same Time (Layer)

As shown in the figure below, by assigning different tones to the “Upper 1” and “Upper 2” parts, two tones can be played simultaneously when the keyboard is played. This feature is called “Layer”. When Layer is turned on, both the Upper 1 and Upper 2 parts sound simultaneously.

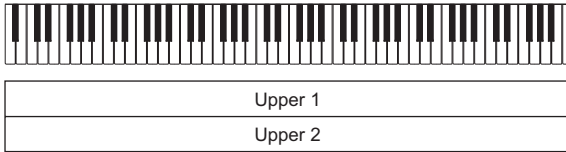

Layer: On, Split: Off\*

\* For details on Split, see “[Splitting the Keyboard Between Two Tones \(Split\)](#)” (page [EN-46](#)).

### NOTE

- If you play the keyboard when both Layer and Split are off, only the Upper 1 part will sound.

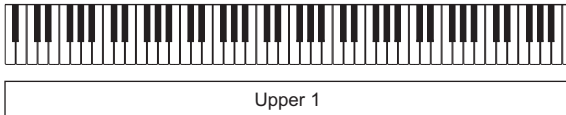

Layer: Off, Split: Off

## Layering Two Tones

1. Perform the operation described in “[Selecting a Single Tone](#)” (page [EN-41](#)) operation to select the Upper 1 tone.
2. Select the “01 Standard” of the F button set. See “[To change the F Button Set](#)” (page [EN-32](#)).



### 3. Touch the **F4** button (LAYER).

Layer is turned ON and the **LY** indicator appears on the display.

Part name: U2 (Upper 2)

Displayed when Layer is on



4. Perform the operation described in “[Selecting a Single Tone](#)” (page [EN-41](#)) operation to select the Upper 2 tone.

## Unlayering the Keyboard

1. Select the “01 Standard” of the F button set. See “[To change the F Button Set](#)” (page [EN-32](#)).
2. Touch the **F4** button (LAYER) to turn off the **LY** indicator on the display.



## Splitting the Keyboard Between Two Tones (Split)

By assigning a “Lower” part to the lower range of the keyboard (as shown in the figure below), the lower range and upper range of the keyboard can play different tones. This function is called “Split”. With Split turned on, you can do the following.

- The lower (left side) range of the keyboard sounds the tone of the Lower part while the upper (right side) range of the keyboard sounds the tone of the Upper 1 part (when Layer is off\*).



- The lower (left side) range of the keyboard sounds the tone of the Lower part while the upper (right side) range of the keyboard sounds the tone of the Upper 1 and Upper 2 parts (when Layer is on\*).

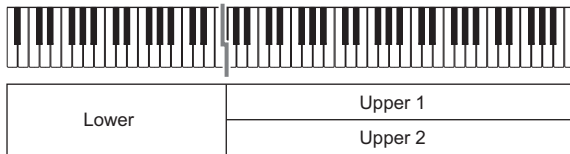

\* For details on layering, see “[Sounding Two Different Tones at the Same Time \(Layer\)](#)” (page EN-44).

## Splitting the Keyboard Between Two Different Tones

1. Perform the operation described in “[Selecting a Single Tone](#)” (page EN-41) operation to select the upper range tone (Upper 1 tone).
2. Select the “01 Standard” of the F button set. See “[To change the F Button Set](#)” (page EN-32).
3. Touch the **F3** button (SPLIT).  
SPLIT is enabled and the **SP** indicator appears on the display.

Part name: L (Lower)

Displayed when SPLIT is on



4. Perform the operation described in “[Selecting a Single Tone](#)” (page EN-41) operation to select the lower range tone (Lower tone).

#### NOTE

- To use both SPLIT and LAYER at the same time, perform steps 3 to 4 of the above operation following the operation described in “[Layering Two Tones](#)” (page EN-44).

## Changing the Split Point

Under initial default settings, the lowest note of the upper range (called the split point) is F#3.

1. Select the “01 Standard” of the F button set. See “[To change the F Button Set](#)” (page EN-32).
2. Touch and hold the **F3** button (SPLIT).  
The “SPLIT POINT” screen appears.

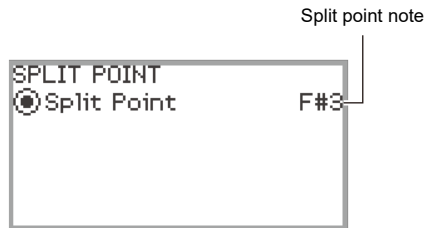

3. Press the keyboard key you want to be the split point (lowest note of the upper range).  
The note of the split point is changed to that of the key pressed.
  - You can also change the split point using the touch ring or touching the **ENTER** button to display a list of note names.
4. Touch the **EXIT** button to exit the setup.

## Unsplitting the Keyboard

1. Select the “01 Standard” of the F button set. See “[To change the F Button Set](#)” (page EN-32).
2. Touch the **F3** button (SPLIT) to turn off the SP indicator on the display.

## Changing Part Settings (Volume Level, Octave Shift, Tuning, etc.)

You can change the volume, octave shift, tuning, and other settings for the Upper 1 and Upper 2 parts when using Layer (page [EN-44](#)), and the Lower part when using Split (page [EN-46](#)), individually for each part. For more information, see the references in the table below.

Configuration items	Reference
Volume of each part, stereo pan, Hall Simulator/Reverb, Chorus	<a href="#">“Using the Mixer”</a> (page <a href="#">EN-60</a> )
Octave shift for each part	<a href="#">“Changing the Pitch in Octave Units (Octave Shift)”</a> (page <a href="#">EN-126</a> )
Fine tuning of each part	<a href="#">“Adjusting the Tuning Separately for Each Part (Upper 1/Upper 2/Lower) (Part Fine Tune)”</a> (page <a href="#">EN-125</a> )
Enable/disable pedal operation for each part	<a href="#">“Enabling/Disabling the Pedal Operation for Each Part (Upper 1/Upper 2/Lower)”</a> (page <a href="#">EN-66</a> )
Enable/disable pitch bend wheel operation for each part	<a href="#">“Enabling/Disabling the Pitch Bend Wheel Operation for Each Part (Upper 1/Upper 2/Lower)”</a> (page <a href="#">EN-73</a> )

# Applying Effects

## Using the Sound Mode Effects (Hall Simulator/Reverb and Surround)

The “Sound Mode” of this Digital Piano includes the following effects.

### • Hall Simulator/Reverb

Hall Simulator and Reverb are both effects that change the reverberation of the sound.

Hall Simulator	The hall simulator effect simulates the rich clarity, unconstrained brilliance, and other distinctive acoustic characteristics of world-famous concert halls and structures.
Reverb	Reverb simulates ambient spaces, such as a room or hall.

### • Surround

A surround effect (an effect that adds breadth to the sound) is applied to the sound output from the built-in speakers.

#### NOTE

- The Surround effect is not applied to the output from the Digital Piano's **PHONES** jacks or **LINE OUT R, L/MONO** jacks.

## Enabling or Disabling the Hall Simulator/Reverb and Surround Effects

Under initial default settings, the Hall Simulator/Reverb is on and Surround is off. Each can be turned on and off as follows.

1. Select the “04 Listening” of the F button set. See “To change the F Button Set” (page EN-32).
2. Touch the **F2** button (SMODE).  
The “Sound Mode” screen appears.



3. Touch the top or bottom of the touch ring to change the setting value.

Setting value	Description
Off	Disables both effects
Hall/Rev.	Enables Hall Simulator/Reverb only
Surround	Enables Surround only
Hall/Rev. + Srnd	Enables both effects

## Specifying the Hall Simulator/Reverb Type

Before selecting a Hall Simulator/Reverb type, make sure to enable the Hall Simulator/Reverb. For details, see “[Enabling or Disabling the Hall Simulator/Reverb and Surround Effects](#)” (page EN-49).

### NOTE

- The “SOUND MODE” screen shown in step 2 can also be displayed by touch and hold the F button to which “SMODE “ is assigned.

1. Touch the **FUNCTION** button to display the **FUNCTION** menu.
2. Use the touch ring to select “**SOUND**” > “**SOUND MODE**” > “**Hall/Rev. Type**”.

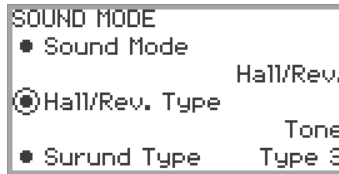

3. Trace the touch ring to change the setting value.

Setting value	Description
Tone	The type is automatically set to match the selected tone.
Salon N.Y. Club Scoring Stage Opera Hall Viennese Hall L.A. Hall Berlin Hall BritishStadium	Various types of hall simulator. For example, “N.Y. Club” simulates the acoustics of a music club in Manhattan, while “Berlin Hall” simulates a classical arena-style concert hall in Berlin.
Room 1 Room 2 Room 3 Large Room	Simulates the reverberation of a room.
Hall 1 Hall 2 Hall 3	Simulates the reverberation of a small hall.
Stadium	Simulates the reverberation of a stadium.

## Adjusting the Depth of the Hall Simulator/Reverb Effect

The mixer can be used to individually adjust the Hall Simulator/Reverb for each part (Upper 1/Upper 2/Lower), audio input from the **MIC IN** jack, etc. For more information, see “Using the Mixer” (page EN-60).

## Specifying the Surround Type

Before selecting the Surround type, make sure to enable Surround. For details, see “Enabling or Disabling the Hall Simulator/Reverb and Surround Effects” (page EN-49).

### NOTE

- The “SOUND MODE” screen shown in step 2 can also be displayed by touch and hold the F button to which “SMODE” is assigned.

1. Touch the **FUNCTION** button to display the **FUNCTION** menu.
2. Use the touch ring to select “SOUND” > “SOUND MODE” > “Surund Type”.

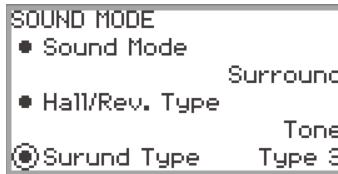

3. Trace the touch ring to change the desired setting value.
  - You can choose from Type 1 (small effect), Type 2 (medium effect), and Type 3 (large effect).\*
  - \* Depending on the tone selected and the characteristics of the audio being played back, the effect may not be obvious.

## Using Chorus (Chorus, Flanger, Short Delay)

The chorus effect thickens the sound.

### Changing the Chorus Type

This Digital Piano has a preset chorus effect assigned to each tone, but you can select a different type by following the operation below.

**1. Select the “09 Favorite Piano” of the F button set. See “To change the F Button Set” (page EN-32).**

**2. Touch the F2 button (EFFECT).**

The “EFFECT” screen appears.

- Check that the cursor (○) is on the “Chorus Type”.

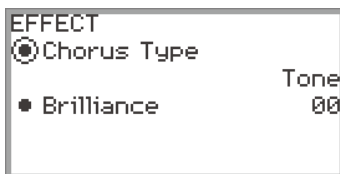

**3. Change the value of the “Chorus Type” setting.**

Setting value	Description
Tone	The chorus type is automatically set to match the selected tone.
Chorus 1 to 4	Four chorus types with different characteristics.
FB Chorus	Chorus with feedback.
Deep Chorus	Chorus with the deepest, thickest sound.
Flanger 1 to 4	Four types of flanger with different sound undulations and fluctuations.
Short Delay 1, 2	Short delay. There are two types to choose from.

- Use the touch ring to change the desired setting value.

### Adjusting the Depth of the Chorus Effect

The mixer can be used to adjust the chorus applied to each part (Upper 1/Upper 2/Lower) separately. For more information, see “Using the Mixer” (page EN-60).

## Adjusting Brilliance

Brilliance is an effect that adjusts the brightness of a sound.

### NOTE

- The brilliance effect is applied to the entire sound output from the Digital Piano.

1. Select the “09 Favorite Piano” of the F button set. See “[To change the F Button Set](#)” (page EN-32).
2. Touch the **F2** button (EFFECT).  
The “EFFECT” screen appears.
3. Touch the top or bottom of the touch ring to select “Brilliance”.

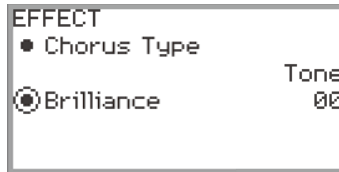

4. Change the “Brilliance” setting.

- Use the touch ring to change the desired setting.
- You can adjust the setting between  $-12$  and  $+12$ . When  $+1$  or higher, the sound is brighter; when  $-1$  or lower, the sound is darker.



## Adjusting Acoustic Piano Sound Characteristics (Acoustic Simulator)

The piano tones of this Digital Piano include elements characteristic of the sound of an acoustic piano. Follow the procedure below to adjust them.

1. Select the “09 Favorite Piano” of the F button set. See “[To change the F Button Set](#)” (page EN-32).
2. Touch the **F1** button (ACSIM).  
The “ACOUSTIC SIM.” screen will appear.

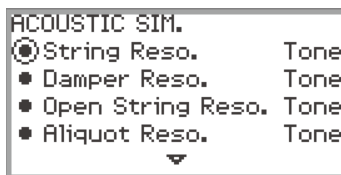

3. Touch the top or bottom of the touch ring to select the item whose settings you want to change.
  - For more information on each setting item, see “[List of Acoustic Piano Sound Setting Items](#)” (page EN-55).
4. Changes the setting value of the selected item.
  - The setting value of each item can be changed within the following range.

Setting value	Description
Tone	A value appropriate for the selected tone is automatically set.
Off	Turn off the effect.
1 to 10	The higher the number, the stronger the effect.

- Trace the touch ring to change the desired setting value.

5. Repeat steps 3 and 4 as necessary.

## List of Acoustic Piano Sound Setting Items

Setting Items	Description
String Reso.	String Resonance. Playing on an acoustic piano causes the strings that are harmonics of the played strings to resonate. You can use this setting item to adjust the level of resonance.
Damper Reso.	Damper Resonance. Pressing the damper pedal on an acoustic piano opens all the strings of 88 keys, causing all of the strings that are harmonics of the keys that are played to resonate. You can use this setting item to adjust the level of resonance.
Open String Reso.	Open String Resonance. The dampers are not applied to the high range notes of an acoustic piano and are always open (open strings), so they produce characteristic resonance. You can use this setting item to adjust the level of resonance.
Aliquot Reso.	Aliquot Resonance. Aliquot resonance is employed on an acoustic piano by using the resonance of sections of the middle and high range strings. This system is sometimes called "duplex scaling". You can use this setting item to adjust the level of resonance.
Damper Noise	Damper Noise. Damper noise is a slight metallic ringing sound that is generated as the damper of an acoustic piano separates from the strings when the damper pedal is pressed. You can use this setting item to adjust the volume level of the noise.
Key On Noise	Key On Action Noise. When the keys of an acoustic piano are tapped with extremely light pressure, piano mechanism operation sound (noise) is produced without the hammers reaching the strings. You can use this setting item to adjust the volume level of the noise.
Key Off Noise	Key Off Action Noise. Releasing the keyboard keys of acoustic piano generates piano mechanism operation sound (noise). You can use this setting item to adjust the volume level of the noise.

## Using Microphone Effects

Various effects can be applied to the audio from a microphone connected to the **MIC IN** jack. In addition to the 25 preset types, you can change the effect settings to your liking.

### NOTE

- You can also adjust settings for the volume, stereo pan, and Hall Simulator/Reverb applied to audio input from the **MIC IN** jack. For more information, see “Using the Mixer” (page EN-60).

### Enabling or Disabling the Microphone Effect

- Select the “05 Song Play” of the F button set. See “To change the F Button Set” (page EN-32).
- Touch the **F4** button (MICFX).  
The microphone effect is enabled and the F button menu F4 appears enclosed in brackets [ ].

Displayed when the microphone effect is enabled



- To disable the microphone effect, touch the **F4** button (MICFX). The enclosing brackets [ ] disappear.

## Specifying the Microphone Effect Type

1. Select the “05 Song Play” of the F button set. See “[To change the F Button Set](#)” (page [EN-32](#)).
2. Touch and hold the **F4** button (MICFX).  
The “MIC FX” screen appears.



3. Touch the **ENTER** button to display the “MIC FX TYPE” screen.



4. Use the touch ring to select the type of microphone effect.
  - There are 25 effect types to choose from. For more information, see “[Microphone Effect Type List](#)” (page [EN-177](#)).

## Changing Microphone Effect Settings

The microphone effect is made up of three modules (M1 to M3) as shown in the figure below.



- Each module contains different effects (equalizer, delay, limiter, etc.).
- Each type of microphone effect has a specific set of effects in each module. For more information, see “Microphone Effect Type List” (page EN-177).

To change microphone effect settings, adjust the parameters of the effect inside each module.

### IMPORTANT!

- Settings changed by the following operations will be erased when the Digital Piano is turned off. If you want to save the modified settings, use the registration function (page EN-79) to save them.

1. Select the “05 Song Play” of the F button set. See “To change the F Button Set” (page EN-32).
2. Touch and hold the **F4** button (MICFX).  
The “MIC FX” screen appears.

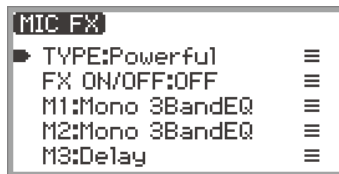

3. Touch the **ENTER** button to display the “MIC FX TYPE” screen.
4. Use the touch ring to select the type of microphone effect for which you want to change the settings.
  - After making your selection, touch the **EXIT** button to return to the “MIC FX” screen.
5. If “FX ON/OFF:OFF” is displayed, switch it to ON by the following operation.
  - (1) Use the touch ring to select “FX ON/OFF:OFF” and touch the **ENTER** button.
  - (2) Use the touch ring to set the value to “On”.
  - (3) Touch the **EXIT** button to return to the “MIC FX” screen.

## 6. Use the touch ring to select the module (from “M1” to “M3”) whose settings you want to change, and touch the **ENTER** button.

A list of parameters for the effect in the selected module is displayed.



- “Bypass” is common to all modules. Set to “On” if you do not want to use the effect in the currently displayed module.

## 7. Change the parameter settings.

- (1) Touch the top or bottom of the touch ring to select the parameter you want to change.
- (2) Use the touch ring to change the value of the selected parameter.  
For parameters and values, see “[Parameter List of Module Effects](#)” (page EN-179).
- (3) Repeat steps (1) and (2) as many times as necessary.
- (4) Touch the **EXIT** button to return to the “MIC FX” screen.

## 8. If necessary, adjust other parameters in the other modules in the same way following steps 6 to 7.

## 9. When all necessary settings have been made, touch and hold the **EXIT** button to return to the top screen.

## 10. If you want to save the modified settings, follow the operation described in “[Saving a Setup Registration](#)” (page EN-80) to save the registration.

# Using the Mixer

The mixer allows you to individually adjust the volume, stereo pan, and effects for each part (Upper 1/ Upper 2/Lower) and audio input from the **MIC IN** jack.

## Adjusting the Volume Level, Stereo Pan and Effects for Each Part

1. Select the “04 Listening” of the F button set. See “[To change the F Button Set](#)” (page [EN-32](#)).

2. Touch the **F4** button (**MIXER**).

The “MIXER” screen appears. This screen contains four parameter categories.

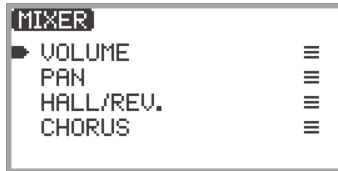

VOLUME: Adjust volume

PAN: Adjust stereo pan (pan)

HALL/REV.: Adjust the depth of the Hall Simulator/Reverb effect

CHORUS: Adjust the depth of the chorus effect

3. Use the touch ring to select the parameter category you want to adjust then touch the **ENTER** button.

- For example, if you select “VOLUME” and touch the **ENTER** button, the following screen will appear.

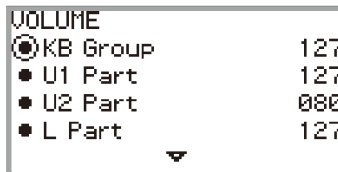

4. Touch the top or bottom of the touch ring to select the item whose value you want to change.

5. Change the value of the selected item.

- Trace the touch ring to change the value.
- For more information on items and values, see “[List of Mixer Setting Items](#)” (page [EN-61](#)).

6. When done, touch the **EXIT** button to return to the “MIXER” screen.

7. Repeat steps 3 to 6 as necessary.

## List of Mixer Setting Items

Parameter Category	Setting items	Description	Range of values
VOLUME	KB Group	Adjusts the overall volume of the Upper 1, Upper 2, and Lower parts while maintaining their relative volumes.	000 to 127
	U1 Part U2 Part L Part	Adjusts the individual volume of the Upper 1, Upper 2, and Lower parts.	
	Audio Song	Adjusts the volume of audio data played in SONG mode (page EN-100).	
	Wireless Audio	Adjusts the volume of input audio from wirelessly connected external devices.	
	Mic In	Adjusts the volume of the input audio from the <b>MIC IN</b> jack.	
	MIDI Song	Adjusts the volume of MIDI data played in SONG mode (page EN-100).	
PAN	U1 Part U2 Part L Part	Adjusts the stereo pan of the Upper 1, Upper 2, and Lower parts.	-64 to 00 to +63 -64: Left-most 00: Central +63: Right-most
	Mic In	Adjusts the stereo pan of input audio from the <b>MIC IN</b> jack.	
HALL/REV.	Hall/Rev. Return	Adjusts the overall depth (Return value) while maintaining the balance of the currently set Hall Simulator/Reverb depth (Send value) for each part of the following items (U1 Part Send - Mic In Send).	000 to 127
	U1 Part Send U2 Part Send L Part Send	Adjusts the Send value to the Hall Simulator/Reverb for the Upper 1, Upper 2, and Lower parts.	
	AudioSongSend	Adjusts the Send value to the Hall Simulator/Reverb for audio data played in SONG mode (page EN-100).	
	Wireless A Send	Adjusts the Send value of input audio from a wirelessly connected external device to the Hall Simulator/Reverb.	
	Mic In Send	Adjusts the Send value of the input audio from the <b>MIC IN</b> jack to the Hall Simulator/Reverb.	
CHORUS	U1 Part Send U2 Part Send L Part Send	Adjusts the Send value to the chorus for the Upper 1, Upper 2, and Lower parts.	000 to 127



# Changing the Sound During a Performance

## Using Pedals

This Digital Piano is equipped with two jacks for pedal connections. Pedals can be connected to both jacks and used at the same time.

Jack	Connectable Pedal
PEDAL UNIT	Included or separately available pedal unit (three pedals: damper, soft, and sostenuto)
EXPRESSION/ASSIGNABLE	Commercially available expression pedal, separately available sustain pedal

### PEDAL UNIT jack

Use the **PEDAL UNIT** jack to connect the included pedal unit or a separately available pedal unit. You can then use the pedals for expression that is similar to that available on an acoustic piano.

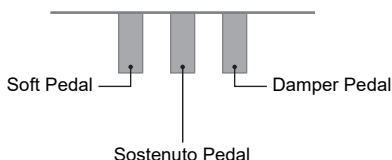

#### Damper Pedal

Pressing the damper pedal while playing will cause the notes you play to be sustained.

- When Grand Piano is selected as the tone, using this pedal generates harmonic and other resonance, just like the damper pedal on an acoustic grand piano. The strength of the pedal's effect varies continuously with the depth to which you depress the pedal.

#### Soft Pedal

Pressing this pedal while playing suppresses notes played on the keyboard after the pedal was pressed, and makes them sound softer. Half-pedal operation is supported with the included pedal unit.

#### Sostenuto Pedal

Only the notes of the keys that are depressed when this pedal is pressed are sustained, even if the keyboard keys are released, until the pedal is released.

## EXPRESSION/ASSIGNABLE jack

Use the **EXPRESSION/ASSIGNABLE** jack to connect a commercially available expression pedal or a separately available sustain pedal.

### ■ Connectable Expression Pedals

- Maximum resistance value: 10kΩ±20% to 50kΩ±20%
- Use of a pedal whose operation has been confirmed (see below) is recommended.

#### Operation Confirmed Pedals (Polarity Type 2\*)

Roland EV-5 (Set minimum volume to 0.)

KURZWEIL CC-1

FATAR VP-25, VP-26

\* Use the procedure under “To specify the pedal type” (page EN-63) to select “Exp.Type2”.

### ■ To specify the pedal type

**1.** Select the “13 KB Setting” of the F button set. See “To change the F Button Set” (page EN-32).

**2.** Touch the **F3** button (PEDAL).

The “EXP/ASGN. PEDAL” screen appears.

- Confirm that the cursor (○) is on “Pedal Type”.

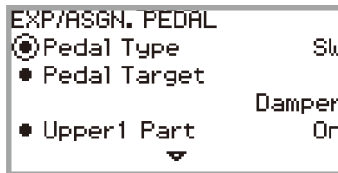

**3.** Use the touch ring to change the desired setting.

- The polarity of expression pedals varies by manufacturer. When connecting an expression pedal, select “Exp.Type1” or “Exp.Type2” according to the polarity of the pedal.

Setting value	Description
Exp.Type1	Polarity Type 1 (see the illustration below) expression pedal 
Exp.Type2	Polarity Type 2 (see the illustration below) expression pedal 
SW	Separately available sustain pedal

## ■ To specify the pedal function

Display the “EXP/ASGN. PEDAL” screen by performing the procedure under “[To specify the pedal type](#)” (page [EN-63](#)) and change the value of the “Pedal Target” setting. The following setting values are for the expression pedal only: “Expression”, “Master Vol”, “Tempo”, and “LY Balance”.

### NOTE

- The “EXP/ASGN. PEDAL” screen can also be displayed by touching and holding the **FUNCTION** button and depressing a pedal connected to the **EXPRESSION/ASSIGNABLE** jack (if the connected pedal matches the currently selected pedal type).

Setting value	Description
Expression	Controls Expression (MIDI Control Change 11).
Master Vol	Controls overall Digital Piano volume level.
Tempo	Controls tempo.
LY Balance	Controls Upper 1 part and Upper 2 part volume level balance.
Damper	Sustains notes played while the pedal is depressed, even if the keys are subsequently released. Organ and other tones that are sustained as long as keys are depressed continue to sound as long as the pedal is depressed.
Sostenuto	Sustains only the notes of the keys that are depressed when the pedal is pressed until the pedal is released, even if the keyboard keys are released first.
Soft	While the pedal is depressed, slightly lowers the volume of notes played and also softens them.
Arpeggio Hold	When the Arpeggiator (page <a href="#">EN-77</a> ) is enabled, Arpeggio Hold can be enabled or disabled when the pedal is depressed.
Start/Stop	Performs the same operations as the  button.
Seq Recall Inc Seq Recall Dec	Each press of a pedal scrolls through and selects setups you registered with the registration function. For more information, see “ <a href="#">Using a Pedal or an EX button to Cycle Through Multiple Setup Registrations (Sequential Recall)</a> ” (page <a href="#">EN-84</a> ).

## ■ Expression Pedal Calibration

When connecting an expression pedal to the **EXPRESSION/ASSIGNABLE** jack for the first time, perform calibration (adjustment) as follows.

1. Connect an expression pedal to the **EXPRESSION/ASSIGNABLE** jack.
2. Select the “13 KB Setting” of the F button set. See “[To change the F Button Set](#)” (page [EN-32](#)).
3. Touch the **F3** button (PEDAL).  
The “EXP/ASGN. PEDAL” screen appears.
4. Touch the top or bottom of the touch ring to select “Exp Calibration” then touch the **ENTER** button.  
A confirmation screen will appear. To cancel the operation, touch the left (NO) of the touch ring.



5. To start calibration, touch the right (YES) of the touch ring.
6. When “Highest” is displayed, press the toe end of the pedal down as far as it will go, then touch the **ENTER** button.
7. When “Lowest” is displayed, press the heel end of the pedal down as far as it will go, then touch the **ENTER** button.  
When calibration has successfully completed, “Complete” is displayed.

## Enabling/Disabling the Pedal Operation for Each Part (Upper 1/Upper 2/Lower)

1. Touch the **FUNCTION** button to display the **FUNCTION** menu.
2. Use the touch ring to select “PEDAL/WHEEL” then touch the **ENTER** button.
3. Select from the menu the jack to which the pedal whose settings you want to change is connected.
  - To change the settings of the pedal connected to the **PEDAL UNIT** jack:  
Use the touch ring to select “PEDAL UNIT” then touch the **ENTER** button.

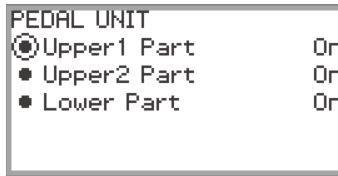

- To change the settings of the pedal connected to the **EXPRESSION/ASSIGNABLE** jack:  
Use the touch ring to select “EXP/ASGN. PEDAL” then touch the **ENTER** button.

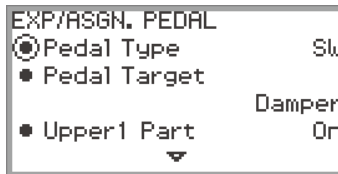

4. Touch the top or bottom of the touch ring to select “Upper 1 Part”, “Upper 2 Part”, or “Lower Part”
5. Use the touch ring to change the desired setting.
  - Select “On” to enable pedal operation for the part selected in step 4 or “Off” to disable it.
6. Repeat steps 4 and 5 as necessary.

## Using the EX Buttons

Each of the two **EX** buttons can be assigned a function of your choice. This allows you to perform the action at any time during a performance.



Each press of the **EX1** button toggles the arpeggiator (page [EN-77](#)) on and off.

Press the **EX2** button to call up the functions of the “CASIO MUSIC SPACE” (page [EN-149](#)) application for smart devices.

The above functions are the initial default settings for the **EX1** and **EX2** buttons. Various other functions (such as switching Layer and Split on and off, recalling registrations, etc.) can be assigned to either button.

## Selecting the Functions Assigned to the EX Buttons

### NOTE

- Instead of steps 1 and 2 below, the “EX” screen can also be displayed by pressing the **EX1** or **EX2** button while touching the **FUNCTION** button. (If the **EX1** button is pressed, “EX1 Assign” is selected; if the **EX2** button is pressed, “EX2 Assign” is selected.)

1. Select the “12 Control” of the F button set. See “[To change the F Button Set](#)” (page [EN-32](#)).
2. Touch the **F3** button (EX).  
The “EX” screen appears.

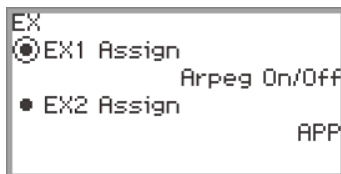

3. Touch the top or bottom of the touch ring to select the item whose settings you want to change.
  - Select “EX1 Assign” to change the function of the **EX1** button or “EX2 Assign” to change the function of the **EX2** button.

#### 4. Use the touch ring to change the setting value.

Setting value	Description
Arpeg On/Off	Toggles the arpeggiator (page <a href="#">EN-77</a> ) on/off.
APP	Calls up the functions of the app for smart devices “CASIO MUSIC SPACE” (page <a href="#">EN-149</a> ). For more information on what functions can be assigned to the EX buttons, refer to the user manual for the app.
Layer	Turns Layer (page <a href="#">EN-44</a> ) on/off.
Split	Turns Split (page <a href="#">EN-46</a> ) on/off.
Arpeg Hold	Toggles Arpeggio Hold (page <a href="#">EN-77</a> ) on/off.
Start/Stop	Same functionality as the ►/■ button.
Sustain	Toggles Sustain (the effect of sustaining notes) on/off.
REG 1, REG 2, REG 3, REG 4	Recalls the registration (page <a href="#">EN-79</a> ) for the currently selected bank.
Seq Recall Inc Seq Recall Dec	Each time the <b>EX</b> button is pressed, the registration (page <a href="#">EN-79</a> ) is recalled in sequence. For more information, see “ <a href="#">Using a Pedal or an EX button to Cycle Through Multiple Setup Registrations (Sequential Recall)</a> ” (page <a href="#">EN-84</a> ).

#### 5. Repeat steps 3 and 4 as necessary.

## Using the CONTROL Button

This button is used to control the sound while playing.



Under initial default settings, modulation is applied while the **CONTROL** button is held down. By changing the setting, other functions can be assigned, such as switching portamento (an effect that smoothly glides between notes) on and off.

### Selecting the Function Assigned to the CONTROL Button

1. Select the “12 Control” of the F button set. See “To change the F Button Set” (page EN-32).

2. Touch the **F4** button (CTRL).

The “CONTROL” screen appears.

- Confirm that the cursor (○) is on “Control Assign”.

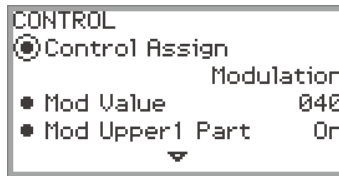

3. Use the touch ring to change the setting value.

Setting value	Description
Modulation	Modulation is applied while the <b>CONTROL</b> button is held down.
Portamento	Each press of the <b>CONTROL</b> button toggles the portamento of the Upper 1 part on/off.
Rotary	When a DSP tone* that uses the rotary effect is selected, each press of the <b>CONTROL</b> button toggles the rotary speaker setting between Slow and Fast.
Arpeg Note Len	Each press of the <b>CONTROL</b> button toggles the arpeggiator note lengths between normal and half.

\* A “DSP tone” is a tone that includes a preset DSP effect. Please refer to the separate “Built-in Music Data Lists” for a list of tones with built-in DSP effects.

The DSP tones that include the rotary effect are organ tones numbered 105, 106, 109, 110, 111, 115, 116, 117, 118, 119, 120, 123, 124, 125.



#### 4. If “Control Assign” is set to “Modulation”, change the modulation settings as necessary.

- Touch the top or bottom of the touch ring to set each item, such as “Mod Value”. For more information, see [“To change the Modulation settings”](#) (page EN-71).

#### NOTE

- The “CONTROL” screen can also be displayed by pressing the **CONTROL** button while touching the **FUNCTION** button instead of steps 1 and 2 above.
- For the portamento time setting when “Control Assign” is set to “Portamento”, see [“Specifying the Portamento Time”](#) (page EN-71).

## ■ To change the Modulation settings

The settings shown in the table below, which appear in the “CONTROL” screen of “[Selecting the Function Assigned to the CONTROL Button](#)” (page EN-69), can be used to change the settings when modulation is assigned to the **CONTROL** button.

Setting item	Values	Description
Mod Value	000 to 127	Sets the intensity at which modulation is applied.
Mod Upper1 Part Mod Upper2 Part Mod Lower Part	On, Off	Selects whether to apply modulation to the Upper 1/Upper 2/Lower parts (On) or not (Off).

## Specifying the Portamento Time

1. Touch the **FUNCTION** button to display the **FUNCTION** menu.
2. Use the touch ring to select “SOUND” > “PORTAMENTO” > “Portamento Time”.



3. Use the touch ring to change the “Portamento Time” setting.
  - This can be set between 000 and 127. The higher the value, the slower the pitch changes.

## Using the Pitch Bend Wheel

By moving the pitch bend wheel up and down, the pitch of the currently sounding notes can be smoothly raised or lowered, producing an effect similar to saxophone or electric guitar pitch bending techniques.

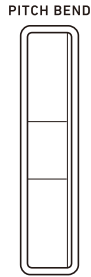

### NOTE

- The pitch of the sound changes with the amount the wheel is moved.
- Do not touch the wheel when turning on the Digital Piano.

## Changing the Pitch Bend Range

You can adjust the amount of pitch change that happens when the wheel is moved to the upper or lower limit in semitone steps. For example, when set to “2”, the pitch rises 2 semitones when the wheel is moved to the upper limit and falls 2 semitones at the lower limit.

1. Select the “13 KB Setting” of the F button set. See “[To change the F Button Set](#)” (page [EN-32](#)).
2. Touch the **F2** button (**WHEEL**).  
The “WHEEL” screen appears.
  - Confirm that the cursor (○) is on “P Bend Range”.

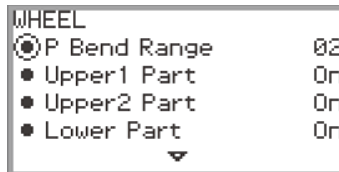

3. Change the value of the “P Bend Range” setting.
  - Set between 0 and 24.

## Enabling/Disabling the Pitch Bend Wheel Operation for Each Part (Upper 1/Upper 2/Lower)

Display the “WHEEL” screen by performing the operation under “[Changing the Pitch Bend Range](#)” (page [EN-72](#)) then adjust the settings below.

Setting item	Values	Description
Upper1 Part Upper2 Part Lower Part	On, Off	Enables (On) or disables (Off) the pitch bend wheel operation for the Upper 1/Upper 2/Lower parts.

## Changing the Pitch Bend Wheel Illumination Settings

You can set how the pitch bend wheel is illuminated when in use and not in use.

Display the “WHEEL” screen by performing the operation under “[Changing the Pitch Bend Range](#)” (page [EN-72](#)), then set according to the table below.

Setting item	Values	Description
Wheel Illum	Cool, Colorful, Active	Selects how the pitch bend wheel is illuminated when the pitch bend wheel is not being used and there is no wireless connection (page <a href="#">EN-143</a> ).
Up/Down Color	On, Off	Selects whether the illumination color will change (On) or not (Off) when the pitch bend wheel is used.

### NOTE

- The pitch bend wheel is not illuminated when the Digital Piano is being used with batteries or when the panel lights are off (page [EN-19](#)).

# Using the Metronome

The Digital Piano's metronome can play a variety of drum patterns in addition to a standard metronome sound.

## Starting or Stopping the Metronome

### 1. While touching the **FUNCTION** button, touch the ►/■ button.

The metronome starts.

- The red and white LEDs to the left of the ►/■ button will flash in time with the metronome beat (first beat: red; remaining beats: white).

### 2. To stop the metronome, while touching the **FUNCTION** button touch the ►/■ button.

## Changing the Metronome Settings (Tempo, Beat, Pattern, etc.)

### 1. Select the “01 Standard” of the F Button Set. See “[To change the F Button Set](#)” (page [EN-32](#)).

### 2. Touch the **F2** button (**METRO**).

The “METRONOME” screen appears.

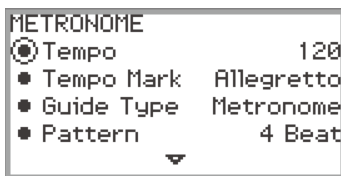

### 3. Touch the top or bottom of the touch ring to select the setting you want to change.

- The table below shows the available settings and values.
- The Tempo setting and Tempo Mark setting are linked to each other.

Setting item	Setting value and description
Tempo	Sets the tempo between 20 and 255 (BPM).
Tempo Mark	Sets the tempo from a tempo marking such as “Andante” or “Allegro”. For more information, see “ <a href="#">Tempo Markings</a> ” (page <a href="#">EN-75</a> ).
Guide Type	Choose from one of the following: Metronome: Plays a metronome tone. Drum: Plays a drum pattern.

Setting item	Setting value and description						
Pattern	If “Guide Type” is “Metronome”: Sets the metronome’s beat.						
	<table border="1"> <tr> <td>Bell Off</td> <td>Plays a click sound on every beat.</td> </tr> <tr> <td>1 Beat</td> <td>Plays a bell sound on every beat.</td> </tr> <tr> <td>2 Beat to 9 Beat</td> <td>Sets the number of beats between 2 and 9. Plays a bell sound on the first beat and a click sound on the remaining beats.</td> </tr> </table>	Bell Off	Plays a click sound on every beat.	1 Beat	Plays a bell sound on every beat.	2 Beat to 9 Beat	Sets the number of beats between 2 and 9. Plays a bell sound on the first beat and a click sound on the remaining beats.
	Bell Off	Plays a click sound on every beat.					
	1 Beat	Plays a bell sound on every beat.					
2 Beat to 9 Beat	Sets the number of beats between 2 and 9. Plays a bell sound on the first beat and a click sound on the remaining beats.						
If the “Guide Type” is “Drum”: You can choose any pattern from the list of drum patterns displayed. For more information, see “ <a href="#">Drum Pattern List</a> ” (page <a href="#">EN-76</a> ).							
Volume	Sets the metronome volume relative to the overall volume of the Digital Piano as a number between 0 (silent) and 127 (maximum volume).						
While Playing	Sets whether the metronome will play a sound (On) or not (Off) during playback of MIDI data songs in SONG mode (page <a href="#">EN-100</a> ).						
While Recording	Sets whether the metronome will play a sound (On) or not (Off) while recording with the MIDI recorder (page <a href="#">EN-107</a> ).						

#### 4. Change the value of the selected setting.

- Trace the touch ring to change the desired setting.

#### 5. Repeat Steps 3 and 4 as necessary.

#### ■ Tempo Markings

Selecting this setting:	Sets this tempo (BPM)
Largo	46
Lento	52
Adagio	56
Andante	72
Moderato	96
Allegretto	108
Allegro	132
Vivace	160
Presto	184

## ■ Drum Pattern List

Drum Pattern Name	Beat	Description
8 Beat 1	4	Simple 8-beat rhythm
8 Beat 2	4	Simple 8-beat rhythm
8 Beat Shuffle	4	8-beat shuffle rhythm
Triplet8Beat 1	4	Triplet 8-beat rhythm
Triplet8Beat 2	4	Triplet 8-beat rhythm
6/8 Pop	6	6-beat rhythm for slow tempo
16 Beat	4	Simple 16-beat rhythm
16 Beat Shuffle	4	16-beat shuffle rhythm
Ballad 8 Beat	4	8-beat rhythm for slow tempo
Ballad 16 Beat	4	16-beat rhythm for slow tempo
Dance Beat	4	Simple dance beat
Dance Shuffle	4	Dance beat shuffle
Waltz	3	Waltz rhythm
March	2	2-beat march rhythm
Bossa Nova	4	Bossa nova rhythm
Salsa	4	Salsa rhythm with percussion
Swing	4	Swing rhythm for jazz
Slow Swing	4	Swing rhythm for slow jazz
Jazz Waltz	3	Jazz waltz rhythm
5/4 Jazz	5	5-beat jazz rhythm

## ■ To set the tempo by tapping a beat with the keyboard keys

### 1. While touching the **FUNCTION** button, touch the **ENTER** button.

The "TAP TEMPO" screen appears.



### 2. Press a keyboard key two or more times in succession.

- This sets the tempo according to the interval between key presses. The display shows the set tempo value.

# Using the Arpeggiator

The Arpeggiator automatically plays arpeggios (broken chords) and various other patterns with a single press of the keys. There are many types to choose from, including patterns that play arpeggios from chords being played and many more.

## Enabling or Disabling the Arpeggiator

**1.** Select the “12 Control” of the F button set. See “[To change the F Button Set](#)” (page [EN-32](#)).

**2.** Touch the **F1** button (ARPEG).

The Arpeggiator turns on and **AP** appears on the display.

Appears when the Arpeggiator is on



- When a chord or single note is pressed on the keyboard, the Digital Piano plays an arpeggio of the currently selected type.

**3.** To turn off the Arpeggiator, touch the **F1** button (ARPEG) so **AP** is not displayed.

## Changing the Arpeggiator Pattern and Other Settings

**1.** Select the “12 Control” of the F button set. See “[To change the F Button Set](#)” (page [EN-32](#)).

**2.** Touch and hold the **F1** button (ARPEG).

The “ARPEGGIATOR” screen appears.

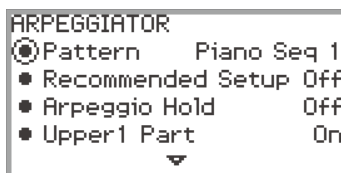



### 3. Touch the top or bottom of the touch ring to select the setting you want to change.

- The table below shows the setting items, values and descriptions of each.

Setting item	Values	Description
Pattern	*1	Selects the pattern the Arpeggiator will play.
Recommended Setup	On, Off *2	When "On", the Digital Piano automatically applies the recommended tones and settings for the Arpeggiator's pattern whenever you switch the Arpeggiator from Off to On or whenever you switch to "Pattern" while the Arpeggiator is on.
Arpeggio Hold	On, Off *3	Toggles Arpeggio Hold On/Off. When "On", the arpeggio will continue to play even after you lift your finger from the keys.
Upper1 Part Upper2 Part Lower Part	On, Off *3	Selects whether the Arpeggiator will play (On) or not play (Off) in the Upper 1, Upper 2, or Lower Parts.

\*1 See "Arpeggiator List" (page EN-184).

\*2 Items that are automatically set when this setting is "On" include the following:

- The key range (the Split Point between Upper and Lower Parts) in which the Arpeggiator plays is set automatically. For this reason, depending on the keys pressed, the Arpeggiator may not play.
- Enabling/disabling the use of the pedal for each part (Upper 1/Upper 2/Lower) is set automatically. The applicable pedals are those connected to the **PEDAL UNIT** jack and those connected to the **EXPRESSION/ASSIGNABLE** jack (only when "Damper" is selected as the pedal's function).

\*3 Even if these settings are "Off", if "Recommended Setup" is "On", the recommended settings are given priority and applied. For details on recommended settings for each pattern, see "Arpeggiator List" (page EN-184).

### 4. Change the value of the selected item.

- Trace the touch ring to change the desired value.

### 5. Repeat Steps 3 and 4 as necessary.

#### NOTE

- The arpeggio speed depends on the tempo setting. For more information, see "Changing the Metronome Settings (Tempo, Beat, Pattern, etc.)" (page EN-74).
- You can assign turning the Arpeggiator on/off to an **EX** button and turning the Arpeggio Hold on/off to an **EX** button or a pedal connected to the **EXPRESSION/ASSIGNABLE** jack. For more information, see "Using the EX Buttons" (page EN-67) and "Using Pedals" (page EN-62).
- Assigning "Arpeg Note Len" to the **CONTROL** button allows you to change the length of notes in some Arpeggiator patterns. For more information, see "Selecting the Function Assigned to the CONTROL Button" (page EN-69).

# Saving and Recalling Performance Setups (Registration)

The state of various settings such as tone selection, Layers, Splits, and effects can be registered as a performance setup. Registered settings can also be recalled\* together simultaneously. This function is called “Registration”.

\* By using it with the Freeze function (page EN-83), it is possible to recall only a portion of the registered settings.

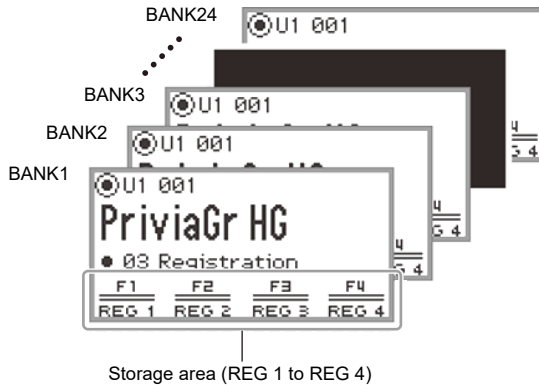

There are four registration areas, REG 1 to REG 4, corresponding to the **F1** (REG 1) to **F4** (REG 4) buttons, respectively. A set of REG 1 to REG 4 is called a “bank”, and there are 24 banks in total, meaning you can register up to 96 setting states.

## NOTE

- Registration is not available during demo song playback (page EN-39), SONG mode (page EN-100), or during various setting operations.

## Saving a Setup Registration

1. Set as many tones, effects, and other registrable items (page [EN-86](#)) as you need.
2. Select the “02 Regist Setting” of the F Button Set. See “[To change the F Button Set](#)” (page [EN-32](#)).



3. Touch the **F1** button (**BANK**).

The “REGIST BANK” screen appears.



4. Trace the touch ring to select the destination bank, then touch the **EXIT** button.

5. Touch the **F2** button (**STORE**).

The “REGIST STORE” screen appears.



- 6. Touch one of the F buttons (F1 to F4) to select the destination (REG 1 to REG 4).**  
A confirmation screen appears. To exit the operation without saving, touch the left of the touch ring (NO).



- 7. Touch the right of the touch ring (YES) to save the registration.**  
“Complete” appears, and the display returns to the screen shown in Step 5.
- 8. Touch the EXIT button to return to the top screen.**

## Changing a Registration Bank Name

- 1. Select the bank you want to rename using Steps 2 through 4 of “Saving a Setup Registration” (page EN-80).**
- 2. Touch the F4 button (BNAME).**  
The bank name editing screen appears.



- 3. Change the bank name to the desired name.**
- For details on the subsequent steps, see “Text Character Input” (page EN-35).

## Recalling a Setup Registration

1. Select the bank of the setup you want to recall by performing Steps 2 through 4 of **“Saving a Setup Registration”** (page EN-80).
  - This procedure is not necessary if you want to recall the registration from the currently selected bank.
2. Turn the Freeze function on or off as needed.
  - For more information, see **“Freeze Function”** (page EN-83).
3. Select the **“03 Registration”** of the F Button Set. See **“To change the F Button Set”** (page EN-32).



4. Touch one of the F buttons (**F1 to F4**).

The corresponding registration (REG 1 to REG 4) is recalled.

The [ ] indicates that registration was recalled



## Freeze Function

By turning on the Freeze function, you can prevent certain setting items from being changed when the registration is recalled. Use the following procedure to select which setting item to freeze.

### ■ To select freeze items

1. Select “02 Regist Setting” as the F Button Set. See “To change the F Button Set” (page EN-32).
2. Touch and hold the **F3** button (FREEZ).  
The “FREEZE” screen appears.

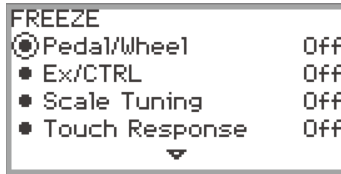

3. Touch the top or bottom of the touch ring to select the setting item you want to change.
  - For details on the setting items, see “Registration Memory Data” (page EN-86).
4. Switch the setting value of the selected item between “On” (freeze) and “Off” (do not freeze).
5. Repeat Steps 3 and 4 as necessary.

### ■ To enable or disable freeze

1. Select the “02 Regist Setting” of the F Button Set. See “To change the F Button Set” (page EN-32).
2. Touch the **F3** button (FREEZ).  
The Freeze function is turned on, and **FZ** appears on the display.

Appears when Freeze is on



3. To turn off the Freeze function, touch the **F3** button (FREEZ) so **FZ** is not displayed.

## Using a Pedal or an EX button to Cycle Through Multiple Setup Registrations (Sequential Recall)

Registrations can be sequentially recalled using a pedal connected to the **EXPRESSION/ASSIGNABLE** jack or one of the **EX** buttons.

### ■ To use a pedal to cycle through multiple setup registrations

- 1. Connect a pedal to the **EXPRESSION/ASSIGNABLE** jack.**
  - Make sure the pedal type corresponds to the connected pedal (see [“To specify the pedal type”](#) (page EN-63)).
- 2. Refer to [“To select freeze items”](#) (page EN-83) to switch the “Pedal/Wheel” setting to “On”.**
- 3. Refer to [“To enable or disable freeze”](#) (page EN-83) to turn on the Freeze function.**
- 4. Refer to [“To specify the pedal function”](#) (page EN-64) to change the value of “Pedal Target” to “Seq Recall Inc” or “Seq Recall Dec”.**
- 5. Step on the pedal to recall a registration.**
  - When the set value is “Seq Recall Inc”:  
Briefly stepping on the pedal recalls registrations in ascending order of “bank number – registration number” (i.e., 1-1, 1-2, 1-3, 1-4, 2-1, 2-2...). Stepping on the pedal and holding it recalls registrations in reverse order (i.e., 2-2, 2-1, 1-4, 1-3...).
  - When the set value is “Seq Recall Dec”:  
Briefly stepping on the pedal recalls registrations in descending order of “bank number - registration number” (i.e., 24-4, 24-3, 24-2, 24-1, 23-4, 23-3...). Stepping on the pedal and holding it recalls registrations in reverse order (i.e., 23-3, 23-4, 24-1, 24-2...).

**■ To use an EX button to cycle through multiple setup registrations**

- 1.** Refer to [“To select freeze items”](#) (page EN-83) to switch the “EX/CTRL” setting to “On”.
- 2.** Refer to [“To enable or disable freeze”](#) (page EN-83) to turn on the Freeze function.
- 3.** Refer to [“Selecting the Functions Assigned to the EX Buttons”](#) (page EN-67) to configure the settings as follows:
  - (1) Select “EX1 Assign” to use the **EX1** button for recall or “EX2 Assign” to use the **EX2** button.
  - (2) Change the setting value to “Seq Recall Inc” or “Seq Recall Dec”.
- 4.** Press one of the EX buttons to recall a registration.
  - When the setting value is “Seq Recall Inc”:  
Pressing the appropriate **EX** button recalls registration in ascending order of “bank number - registration number” (i.e., 1-1, 1-2, 1-3, 1-4, 2-1, 2-2...).
  - When the setting value is “Seq Recall Dec”:  
Pressing the appropriate **EX** button recalls registration in descending order of “bank number - registration number” (i.e., 24-4, 24-3, 24-2, 24-1, 23-4, 23-3...).

 **NOTE**

- The **EX** buttons can also be used to recall a specific registration area of the currently selected registration bank. For more information, see [“Selecting the Functions Assigned to the EX Buttons”](#) (page EN-67).



## Registration Memory Data

Setting Items	Freeze*
<ul style="list-style-type: none"> <li>Pedal unit, EXPRESSION/ASSIGNABLE pedal, and pitch bend wheel Part On/Off settings</li> <li>EXPRESSION/ASSIGNABLE pedal functions</li> <li>Pitch Bend Range</li> </ul>	Pedal/Wheel
<ul style="list-style-type: none"> <li>EX Button settings</li> <li>Sustain setting by EX button operations</li> <li>CONTROL Button settings</li> <li>Portamento On/Off, Rotary Slow/Fast, and Modulation (value, Part On/Off) settings by CONTROL button operations</li> </ul>	EX/CTRL
<ul style="list-style-type: none"> <li>Scale settings (type, base note, stretch tuning)</li> </ul>	Scale Tuning
<ul style="list-style-type: none"> <li>Touch Response settings</li> </ul>	Touch Response
<ul style="list-style-type: none"> <li>Hall Simulator/Reverb (On/Off, Type)</li> <li>Surround (On/Off, Type)</li> </ul>	Sound Mode
<ul style="list-style-type: none"> <li>Chorus type</li> <li>Brilliance setting</li> <li>Microphone Effect (Type, Effect On/Off, M1 to M3 settings)</li> </ul>	Effect
<ul style="list-style-type: none"> <li>Transpose setting</li> </ul>	Transpose
<ul style="list-style-type: none"> <li>Split Point setting</li> </ul>	Split Point
<ul style="list-style-type: none"> <li>Arpeggiator (On/Off, Type, and other settings)</li> <li>Arpeggio On/Off setting by EX button operations</li> <li>Arpeggio Hold On/Off setting by a pedal connected to the EXPRESSION/ASSIGNABLE jack, or by EX button operations</li> <li>Arpeggio Note Length settings by CONTROL button operations</li> </ul>	Arpeggiator
<ul style="list-style-type: none"> <li>Metronome settings (Tempo, Tempo Mark, Guide Type, Pattern)</li> <li>Tempo setting by a pedal connected to the EXPRESSION/ASSIGNABLE jack</li> </ul>	Tempo
<ul style="list-style-type: none"> <li>Tone number (Upper 1, Upper 2, Lower)</li> <li>Layer On/Off, Split On/Off</li> <li>Portamento Time</li> <li>Hammer Response, Key Off Response</li> <li>Octave Shift</li> <li>Part Fine Tune</li> <li>Duet settings</li> <li>Layer and Split settings by EX button operations</li> </ul>	Tone
<ul style="list-style-type: none"> <li>Mixer settings</li> <li>Layer Balance setting by a pedal connected to the EXPRESSION/ASSIGNABLE jack</li> </ul>	Mixer

\* The "Freeze" column shows the names of parameters included in the "FREEZE" screen. For more information, see "[To select freeze items](#)" (page [EN-83](#)).

## Saving to an External Device

Registration data can be saved to a USB flash drive as banks. For more information, see “[Saving Digital Piano Data to a USB Flash Drive](#)” (page [EN-137](#)).

# Using the F Button Set

A set of four F buttons, each assigned a function, is called an F Button Set. There are 14 preset F Button Sets that have predefined names and functions and 16 user F Button Sets that the user can freely assign names and functions to.

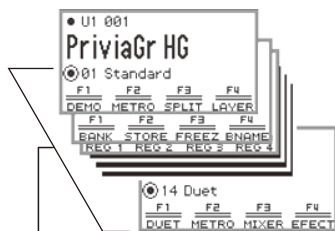

Preset F Button Sets (01–14)

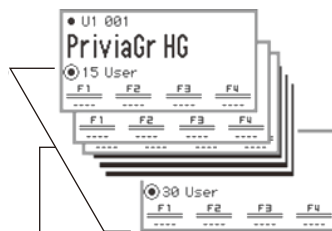

User F Button Sets (15–30)

Assign frequently used tones, functions, etc. to a user F Button Set according to the song you are playing.

## Preset F Button Set List

The names of F Button Sets 01 to 14 and the functions assigned to each F button are shown in the table below.

No.	F Button Set Name		F1	F2	F3	F4
01	Standard	(Standard)	DEMO	METRO	SPLIT	LAYER
02	Regist Setting	(Registration Setting)	BANK	STORE	FREEZ	BNAME
03	Registration	(Registration)	REG 1	REG 2	REG 3	REG 4
04	Listening	(Listening)	ADPTR	SMODE	PPOSI	MIXER
05	Song Play	(Song Play)	SONG	SMODE	PPOSI	MICFX
06	Song Lesson	(Song Lesson)	SONG	◀◀	▶▶	METRO
07	Piano Collect	(Piano Collection)	001PR	004PR	007PR	011CL
08	E.PianoCollect	(Electric Piano Collection)	049SP	044JU	056IN	059WH
09	Favorite Piano	(Favorite Piano)	ACSIM	EFFECT	SMODE	PPOSI
10	Effect	(Effect)	SMODE	PPOSI	EFFECT	MICFX
11	Vocal	(Vocal)	ADPTR	MICFX	SMODE	MIXER
12	Control	(Control)	ARPEG	TRANS	EX	CTRL
13	KB Setting	(Keyboard Setting)	KEYBD	WHEEL	PEDAL	CTRL
14	Duet	(Duet)	DUET	METRO	MIXER	EFFECT

This function can only be used with an F button (not included in the FUNCTION menu).

Recalls a dedicated screen.

## Editing an F Button Set

### Assigning a Function to an F Button (Creating a User F Button Set)

There are two ways to assign desired functions to F buttons, creating a user F Button Set:

- Edit the preset F Button Set (or a user F Button Set that has already been assigned functions) and save it as a user F Button Set (see [Example 1]).
- Assign new functions to an empty user F Button Set and save it (see [Example 2]).

#### [Example 1]: Editing the “01 Standard” preset F Button Set and saving it as a user F Button Set

1. Select the “01 Standard” of the F Button Set. See “[To change the F Button Set](#)” (page [EN-32](#)).



2. While touching the **FUNCTION** button, touch the **F1** button.

The “F BUTTON EDIT” screen appears.

- Since you touched the **F1** button, the **F1** button is selected as the target for assigning a different function.

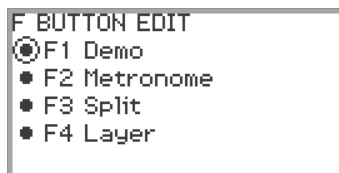

### 3. Trace the touch ring to change the setting value for the F1 button.

- For details on the displayed settings and the corresponding functions, see “F Button Function List” (page EN-97).
- To assign a tone to an F button, you must change the setting value to “Tone Category” and touch the **ENTER** button to select a tone. For more information, see “Assigning a tone to an F button” (page EN-93).

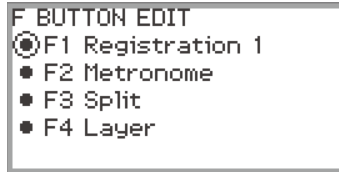

- To change the function assignments of other F buttons, touch the top or bottom of the touch ring while the “F BUTTON EDIT” screen is displayed to select “F2”, “F3”, or “F4”, then change the setting of the selected button.

### 4. When you are done making the necessary changes, touch the EXIT button.

A screen appears to confirm whether you want to save the F Button Set. To exit the operation without saving, touch the left of the touch ring (NO).



### 5. Touch the right of the touch ring (YES) to save.

A screen appears to select which user F Button Set to use as the save destination.

- The user F Button Sets that have already been assigned functions and saved are marked with a “\*” to the right of their numbers. Selecting a set marked with “\*” will overwrite it.



**6. Trace the touch ring to select a user F Button Set as the save destination then touch the **ENTER** button.**

After “Complete” appears, the display returns to the top screen.



[Example 2]: Assigning new functions to an empty user F Button Set and saving it

1. Select an empty user F Button Set. See [“To change the F Button Set”](#) (page EN-32).
2. Touch the **FUNCTION** button to display the FUNCTION menu.
3. Use the touch ring to select “F BUTTON SETTING” > “F BUTTON EDIT”.

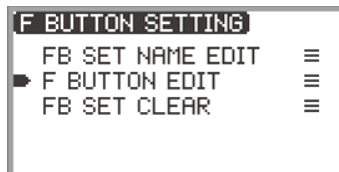

**4. Touch the **ENTER** button.**

The “F BUTTON EDIT” screen appears.

- The **F1** button is now selected as the target that will be assigned a different function.
- “----” appears to the right of the F buttons that do not have an assigned function.

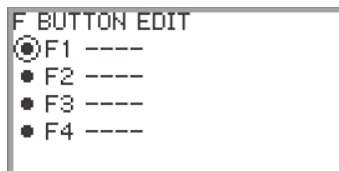

## 5. Trace the touch ring to change the desired setting.

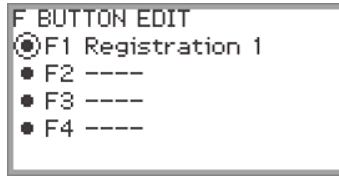

- For more information on the displayed settings and the assignable F button functions corresponding to those settings, see “[F Button Function List](#)” (page [EN-97](#)).
- To assign a tone to the F button, you must change the setting value to “Tone Category” and touch the **ENTER** button to select a tone. For more information, see “[Assigning a tone to an F button](#)” (page [EN-93](#)).

## 6. Touch the top or bottom of the touch ring while the “F BUTTON EDIT” screen is displayed to select “F2”, “F3”, or “F4”, and then change the setting of the selected button.

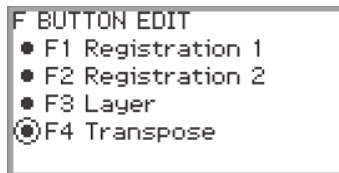

## 7. When you are done making the necessary changes, touch the **EXIT** button.

A screen appears to confirm whether you want to save the F Button Set. To exit the operation without saving, touch the left of the touch ring (NO).



## 8. Touch the right of the touch ring (YES) to save.

A screen appears to select which user F Button Set to use as the save destination.

- User F Button Sets that have already been assigned functions and saved are marked with a “\*” to the right of their numbers. Selecting a set marked with “\*” will overwrite it.



## 9. Trace the touch ring to select the user F Button Set to use as the save destination then touch the **ENTER** button.

After “Complete” appears, the display returns to the “F BUTTON SETTING” screen.

## 10. Touch and hold the **EXIT** button to return to the top screen.

### ■ Assigning a tone to an F button

Perform the following during Step 3 of [Example 1] (page [EN-89](#)) or Step 4 of [Example 2] (page [EN-91](#)).

## 1. Touch the **ENTER** button to display the list of settings and select “Tone Category”.

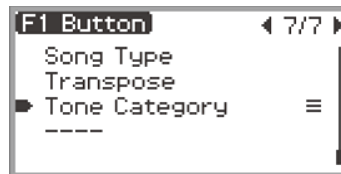

## 2. Touch the **ENTER** button.

A list of tone categories is displayed.

## 3. Use the touch ring to select a tone category, then touch the **ENTER** button.

A list of tone names is displayed.

## 4. Use the touch ring to select a tone.



## 5. Touch the **EXIT** button three times to return to the “F BUTTON EDIT” screen.

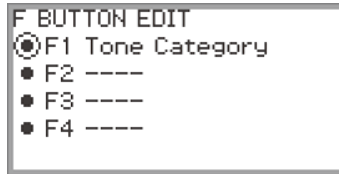

### NOTE

- Regardless of the tone selected in Step 4 above, the “F BUTTON EDIT” screen will display “Tone Category” as the setting value. When you return to the top screen after saving the F Button Set, the tone number and the first two letters of the tone name appear in the F button menu, as shown below.



## Changing the Name of an F Button Set

- Select the F Button Set you want to rename. See “[To change the F Button Set](#)” (page [EN-32](#)).
- Touch the **FUNCTION** button to display the FUNCTION menu.
- Use the touch ring to select “F BUTTON SETTING” > “FB SET NAME EDIT”.

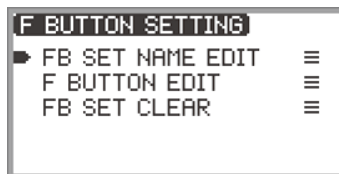

#### 4. Touch the **ENTER** button.

The F Button Set name editing screen appears.



#### 5. Change the F Button Set name to the desired name.

- For more information on operations, see “[To change a character](#)” (page EN-35), “[To insert a character](#)” (page EN-36), and “[To delete a character](#)” (page EN-36).

#### 6. When you are done making your changes, touch the **ENTER** button.

A screen appears to confirm whether you want to save the name of the F Button Set. To return to the editing screen without saving, touch the left of the touch ring (NO).



#### 7. Touch the right of the touch ring (**YES**).

A screen appears to select which user F Button Set to use as the save destination.

#### 8. Trace the touch ring to select the user F Button Set to use as the save destination, then touch the **ENTER** button.

After “Complete” appears, the display returns to the “F BUTTON SETTING” screen.

#### 9. Touch and hold the **EXIT** button to return to the top screen.

## Erasing an F Button Set

1. Touch the **FUNCTION** button to display the FUNCTION menu.
2. Use the touch ring to select “F BUTTON SETTING” > “FB SET CLEAR”.

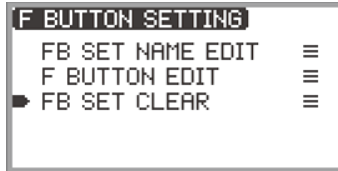

3. Touch the **ENTER** button.  
A screen appears to select the F button set to erase.



4. Touch the top or bottom of the touch ring to select the F button set to erase, then touch the **ENTER** button.

A screen appears to confirm whether you want to erase the F Button Set. To cancel, touch the left of the touch ring (NO).

5. Touch the right of the touch ring (**YES**) to erase.  
After “Complete” appears, the display returns to the “F BUTTON SETTING” screen.
6. Touch and hold the **EXIT** button to return to the top screen.

## F Button Function List

- The “Function Name” column indicates the value displayed on the “F BUTTON EDIT” screen.
- The “F Button Display” column is the text that appears in the F button menu.
- The “Function” column indicates the function to be performed when the F button is touched.
  - ◆ indicates the function to be performed when the F button is pressed and held.

Function Name	F Button Display	Function	Reference
Demo	DEMO	The Digital Piano will wait for the demo song to start.	<a href="#">“Listening to the Demo Songs”</a> (page EN-39)
Metronome	METRO	Displays the metronome setting screen.	<a href="#">“Using the Metronome”</a> (page EN-74)
Split	SPLIT	Turns Split on and off. ◆Displays the Split Point setting screen.	<a href="#">“Splitting the Keyboard Between Two Tones (Split)”</a> (page EN-46)
Layer	LAYER	Turns Layer on and off.	<a href="#">“Sounding Two Different Tones at the Same Time (Layer)”</a> (page EN-44)
Bank	BANK	Displays the Registration Bank selection screen.	<a href="#">“Saving a Setup Registration”</a> (page EN-80)
Bank Name	BNAME	Displays the Registration Bank name edit screen.	<a href="#">“Changing a Registration Bank Name”</a> (page EN-81)
Store	STORE	Displays the “REGIST STORE” screen (for saving a setup registration).	<a href="#">“Saving a Setup Registration”</a> (page EN-80)
Freeze	FREEZ	Turns Freeze function on/off. ◆Displays the Freeze function setting screen.	<a href="#">“Freeze Function”</a> (page EN-83)
Registration 1	REG 1	Recalls registration area numbers 1 through 4.	<a href="#">“Recalling a Setup Registration”</a> (page EN-82)
Registration 2	REG 2		
Registration 3	REG 3		
Registration 4	REG 4		
Adaptor	ADPTR	Turns the Wireless MIDI & Audio Adaptor on and off. ◆Displays the wireless setup screen.	<a href="#">“Enabling and Disabling the Digital Piano’s Wireless Function”</a> (page EN-143)
Sound Mode	SMODE	Displays the Sound Mode selection screen. ◆Displays the Sound Mode setting screen.	<a href="#">“Enabling or Disabling the Hall Simulator/Reverb and Surround Effects”</a> (page EN-49)
Piano Position	PPOSI	Displays the Piano Position setting screen.	<a href="#">“Selecting the Piano Position Setting”</a> (page EN-38)

Function Name	F Button Display	Function	Reference
Effect	EFFECT	Displays the "EFFECT" screen where you can select the Chorus Type and adjust the Brilliance.	"Using Chorus (Chorus, Flanger, Short Delay)" (page EN-52), "Adjusting Brilliance" (page EN-53)
Mic Effect	MICFX	Turns the Microphone Effect on and off. ◆Displays the Microphone Effect setting screen.	"Using Microphone Effects" (page EN-56)
Acoustic Sim.	ACSIM	Displays the Acoustic Simulator settings screen.	"Adjusting Acoustic Piano Sound Characteristics (Acoustic Simulator)" (page EN-54)
Mixer	MIXER	Displays the Mixer settings screen.	"Using the Mixer" (page EN-60)
Song	SONG	Displays the SONG mode screen for song playback.	"Playing Back MIDI Data or Audio Data" (page EN-101)
Arpeggiator	ARPEG	Turns the Arpeggiator on and off. ◆Displays the Arpeggiator setting screen.	"Using the Arpeggiator" (page EN-77)
Duet	DUET	Turns the Duet function on and off. ◆Displays the Duet function setting screen.	"Splitting the Keyboard for Duet Play" (page EN-129)
Keyboard	KEYBD	Displays the "KEYBOARD" screen in the FUNCTION menu.	"Using the FUNCTION Menu" (page EN-33)
EX	EX	Displays the <b>EX</b> button setting screen.	"Using the EX Buttons" (page EN-67)
Control	CTRL	Displays the <b>CONTROL</b> button setting screen.	"Using the CONTROL Button" (page EN-69)
Pedal	PEDAL	Displays the setting screen for the pedal connected to the <b>EXPRESSION/ ASSIGNABLE</b> jack.	"EXPRESSION/ ASSIGNABLE jack" (page EN-63)
Wheel	WHEEL	Displays the pitch bend wheel setting screen.	"Using the Pitch Bend Wheel" (page EN-72)

Function Name	F Button Display	Function	Reference
◀◀	◀◀	Backs up the song a little. ◆Rewinds the song.	“Playing Back MIDI Data or Audio Data” (page EN-101)
▶▶	▶▶	Advances the song a little. ◆Fast-forwards the song.	“Playing Back MIDI Data or Audio Data” (page EN-101)
⏸	⏸	Pauses the currently playing song.	“Playing Back MIDI Data or Audio Data” (page EN-101)
Song Type	STYPE	Displays the song setting screen.	“Playing Back MIDI Data or Audio Data” (page EN-101)
Transpose	TRANS	Displays the Transpose setting screen.	“Changing the Pitch in Semitone Steps (Transpose)” (page EN-124)
Tone Category	*	Recalls the specified tone.	“Assigning a tone to an F button” (page EN-93)
----	----	No function assigned to the F button.	–

\* The tone number (3 digits) of the specified tone followed by the first two letters of the tone name are displayed.

# Listening to Songs (SONG Mode)

MIDI and audio data can be played back in the SONG mode screen that appears when you touch the  button.

## Data Types of Playable Songs

### NOTE

- For details on saving MIDI and audio data that can be played back on this Digital Piano to a USB flash drive, see “[Saving MIDI Files or Audio Files for Playback on your Digital Piano to a USB Flash Drive](#)” (page EN-137).

### ■ MIDI Data

The table below shows the types of MIDI data saved in either the Digital Piano’s internal memory or USB flash drive that can be played back.

Song Number* <sup>1</sup>	Type of Song	File Extension* <sup>2</sup>
001 to 010	User songs: Up to 10 of your favorite songs can be stored in the Digital Piano’s internal memory. The data can be transferred to the Digital Piano from a USB flash drive or smart device. For more information, see “ <a href="#">Loading USB Flash Drive Data into the Digital Piano’s Internal Memory</a> ” (page EN-139) and “ <a href="#">Using the Dedicated App</a> ” (page EN-149).	MID, CMF
011 to 015	MIDI recorder songs: Songs recorded by the Digital Piano’s MIDI recorder. For more information, see “ <a href="#">Using the MIDI Recorder to Record Performances</a> ” (page EN-107).	MRF
016 to 999	USB flash drive songs: Standard MIDI files (SMF format 0/1) or CASIO MIDI files (CMF format) stored on a USB flash drive can be played back without having to transfer them to the Digital Piano.	MID, CMF

\*<sup>1</sup> The song number is displayed to the left of the song data name in the SONG mode screen. You can identify the type of MIDI song by the song number.

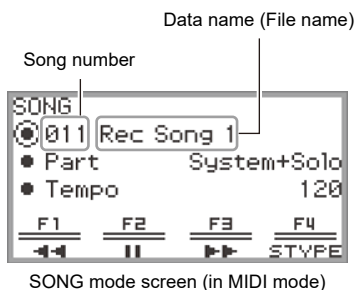

\*<sup>2</sup> The extension is displayed when the file is viewed on a computer or other device. It does not appear in the SONG mode screen.

MID: Standard MIDI file (SMF format 0/1)

CMF: CASIO MIDI file (CASIO’s proprietary extended MIDI format)

MRF: Dedicated format for MIDI recorder songs recorded with this Digital Piano

## ■ Audio Data

The following audio data stored in the Digital Piano's internal memory or in a USB flash drive can be played back.

- WAV file (Linear PCM, 16-bit, 44.1kHz, stereo, file name extension: .WAV)
- MP3 file (MPEG-1 Audio Layer3, 44.1kHz/48kHz, 32 to 320kbps variable bit rate (VBR), monaural/stereo, file name extension: .MP3)

Audio recorder songs recorded with this Digital Piano are WAV files (file names "TAKE01.wav" to "TAKE99.wav").

## Playing Back MIDI Data or Audio Data

To play back songs stored on a USB flash drive, plug the USB flash drive into the **USB** Type A port of the Digital Piano in advance.

- When a USB flash drive is inserted, "MOUNTING" will be displayed briefly. It may take a minute or so for the message to disappear.
- For information on handling USB flash drives and plugging/unplugging them from the Digital Piano, see "[Preparing a USB Flash Drive](#)" (page EN-132).

### NOTE

- For details on saving MIDI data and audio data to a USB flash drive for playback on this Digital Piano, see "[Saving MIDI Files or Audio Files for Playback on your Digital Piano to a USB Flash Drive](#)" (page EN-137).
- For details on loading MIDI data (user songs) and audio data from a USB flash drive to the internal memory of this Digital Piano, see "[Loading USB Flash Drive Data into the Digital Piano's Internal Memory](#)" (page EN-139).
- The metronome can be used during MIDI data playback. For more information, see "[Changing the Metronome Settings \(Tempo, Beat, Pattern, etc.\)](#)" (page EN-74). In the "METRONOME" screen, set "While Playing" to "On".

## 1. Touch the ►/■ button.

The SONG mode screen appears.

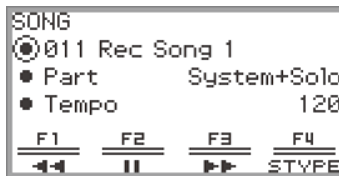

- If a song has been recorded (or played) since the Digital Piano was turned on, the last song recorded (or played) will be played. To stop playback, touch the ►/■ button.

### NOTE

- The SONG mode screen can also be displayed by performing the following operations.
  - (1) Select the "05 Song Play" of the F button set. See "[To change the F Button Set](#)" (page EN-32).
  - (2) Touch the **F1** button (SONG).



## 2. Select “Song Type” according to the song you want to play.

(1) Touch the **F4** button (STYPE).

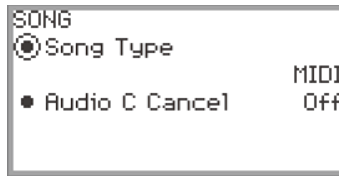

- (2) Trace the touch ring to select the “Song Type” setting from the following:
- “MIDI” ... Play MIDI data from the internal memory or a USB flash drive (MIDI Mode)
  - “Audio(USB Drv)” ... Play audio data from a USB flash drive (Audio Mode)
  - “Audio(Internal)” ... Play audio data from the internal memory (Audio Mode)
- (3) Touch the **EXIT** button to return to the SONG mode screen.

## 3. Trace the touch ring to select the song you want to play.

- For MIDI data and audio data for each song, see “Data Types of Playable Songs” (page EN-100).

## 4. When playing back MIDI data, set the part and tempo to be played back as needed.

- Touch the top or bottom of the touch ring to select the item whose setting you want to change.

Setting item	Setting values and descriptions
Part	<b>For user songs and USB flash drive songs</b> L+R: Plays both parts L: Plays only the left-hand part R: Plays only the right-hand part
	<b>For MIDI recorder songs</b> System + Solo: Plays both tracks System: Plays only the system track Solo: Plays only the solo track
Tempo	Sets the tempo of the song between 20 and 255 (beats/minute)

## 5. To start playback, touch the ►/■ button.

- During playback, the following operations are available:
  - Touch the **F1** button (◀◀): Backs up the song a little.
  - Touch and hold the **F1** button (◀◀): While held down, the song will rewind.
  - Touch the **F2** button (■): Pauses the currently playing song. Touch while paused to resume playback.
  - Touch the **F3** button (▶▶): Advances the song a little.
  - Touch and hold the **F3** button (▶▶): While held down, the song will fast-forward.
- When the song reaches the end, playback will stop. Touch the ►/■ button to stop midway.

## Operations While Playing Back MIDI Data

### Sounding Metronome While Playing Back MIDI Data

In the “METRONOME” screen, turn “While Playing” to “On” to have the Metronome sound during MIDI data playback.

For more information, see “[Changing the Metronome Settings \(Tempo, Beat, Pattern, etc.\)](#)” (page EN-74).

### Adjusting the Volume Level of MIDI Data Playback (MIXER Settings)

Use “MIXER” > “VOLUME” > “MIDI Song” to adjust the playback volume of MIDI data relative to the overall volume.

For more information, see “[Adjusting the Volume Level, Stereo Pan and Effects for Each Part](#)” (page EN-60).

### Deleting a User Song

1. Follow steps 1 through 3 of “[Playing Back MIDI Data or Audio Data](#)” (page EN-101) to select the user song (song numbers 001 to 010) you want to delete.

2. Touch and hold the **●REC** button.

A confirmation screen will appear. To cancel the operation, touch the left of the touch ring (NO) at this point.



3. Touch the right of the touch ring (YES) to delete.

“Complete” is displayed and the display returns to the SONG mode screen.

#### **NOTE**

- For details on deleting a MIDI recorder song, see “[Deleting a MIDI Recorder Song \(Entire Song/ Individual Tracks\)](#)” (page EN-113).

## Operations While Playing Back Audio Data

### Audio Center Cancel (Vocal Cut)

Audio Center Cancel cuts (eliminates or reduces) vocals in the playback audio. Since this function cancels the center-localized sound, sounds other than vocals may also be cut. The degree of the effect depends on the audio data being played.

#### ■ Enabling or Disabling Audio Center Cancel

1. Touch the **▶/■** button to display the SONG mode screen.
2. Touch the **F4** button (STYPE).
3. Touch the top or bottom of the touch ring to select “Audio C Cancel”.

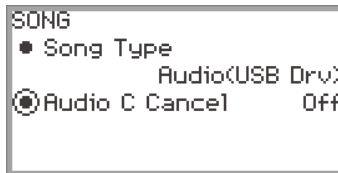

4. Trace the touch ring to toggle the setting between “On” and “Off”.
5. Touch the **EXIT** button to return to the SONG mode screen.

### Adjusting the Volume Level or Effect Depth of Audio Data Playback (MIXER Settings)

See “[Adjusting the Volume Level, Stereo Pan and Effects for Each Part](#)” (page EN-60).

- Use “MIXER” > “VOLUME” > “Audio Song” to adjust the playback volume of audio data relative to the overall volume.
- Use “MIXER” > “HALL/REV.” > “AudioSongSend” to adjust the send value of audio data to the Hall Simulator/Reverb by changing the value of the “HALL/REV.” > “AudioSongSend” setting.

# Recording Performances

Your Digital Piano can record what you play on the keyboard and play it back when you want. The Digital Piano has two recording functions: a MIDI Recorder and an Audio Recorder. Select the function that suits the needs for the type of recording you want to make.

## IMPORTANT!

- **CASIO COMPUTER CO., LTD.** takes no responsibility for any damages, lost profits, or claims by third parties arising from the deletion of recorded data due to malfunction, repair, or for any other reason.
- Should power fail during recording, all of the data in the song you are recording will be deleted.

## MIDI Recorder and Audio Recorder Features

### Recording Features

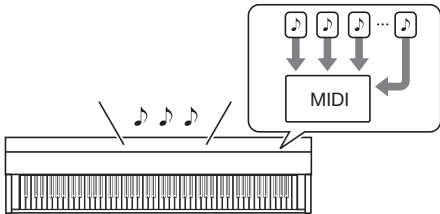
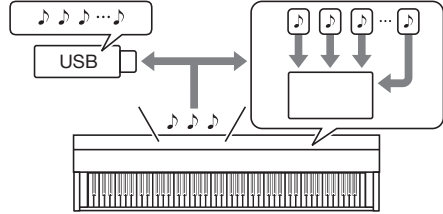
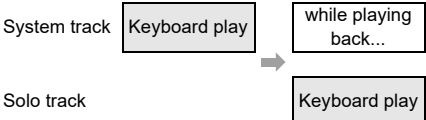
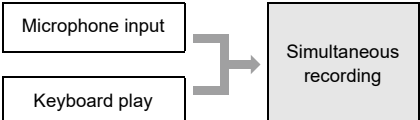
MIDI Recorder	Audio Recorder
<p>Keyboard performance information is recorded to the <u>Digital Piano's internal memory as MIDI data</u>*1 to two tracks (storage areas for keyboard performance data).</p>  <ul style="list-style-type: none"> <li>• Keyboard performance information (keyboard keys press/ release, key velocity, etc.) is recorded as MIDI data.</li> <li>• The size of MIDI data is much smaller when compared with audio data, making it easier to edit later on a computer, etc.</li> <li>• Supported recording capacity: Up to five songs, each song up to approximately 30,000 notes (total of system track and solo track)</li> </ul>	<p>Keyboard performance information is recorded to the <u>Digital Piano's internal memory</u> or a <u>USB flash drive as audio data</u>*2.</p>  <ul style="list-style-type: none"> <li>• Like a portable music player or tape recorder, notes are recorded as audio data.</li> <li>• Audio data files are much larger compared to MIDI data files. The advantage of audio data files is that they can be easily played back on a computer, portable music player, etc.</li> <li>• Supported recording capacity: Up to 99 files <ul style="list-style-type: none"> <li>– When recording to USB flash drive: Each song up to a maximum length of approximately 25 minutes</li> <li>– When recording to the internal memory: Up to a maximum length of approximately 18 minutes (total of all songs)</li> </ul> </li> </ul>
<p><u>What you can do...</u></p> <p>⇒ Record to one track while playing back from the other track</p> 	<p><u>What you can do...</u></p> <p>⇒ Connect a microphone to record vocals and the keyboard at the same time</p> 

## ■ Playback Features

MIDI Recorder	Audio Recorder						
<p>Plays back system track and solo track (simultaneously or individually).</p> <ul style="list-style-type: none"> <li>With the MIDI Recorder, the Digital Piano automatically performs playback using its internal sound source in accordance with the performance information recorded as MIDI data.</li> </ul> <div style="border: 1px solid black; padding: 5px; margin-top: 10px;"> <p><u>What you can do...</u></p> <p>⇒ Play on the keyboard along with playback of system track and solo track</p> <table style="width: 100%; border-collapse: collapse;"> <tr> <td style="width: 20%;">System track</td> <td style="border: 1px solid black; padding: 2px;">While playing back...</td> </tr> <tr> <td>Solo track</td> <td style="border: 1px solid black; padding: 2px;">While playing back...</td> </tr> <tr> <td></td> <td style="border: 1px solid black; padding: 2px; text-align: center;">Keyboard play</td> </tr> </table> <p>⇒ After recording, change the tempo For example, you can record at a slow tempo and then play back at a faster tempo.</p> </div>	System track	While playing back...	Solo track	While playing back...		Keyboard play	<p>You can play back audio data from the internal memory or a USB flash drive.</p> <ul style="list-style-type: none"> <li>The Audio Recorder plays back the waveform of sound recorded as audio data.</li> </ul> <div style="border: 1px solid black; padding: 5px; margin-top: 10px;"> <p><u>What you can do...</u></p> <p>⇒ Play along on the keyboard while the audio data is playing</p> <div style="display: flex; align-items: center; justify-content: center; margin-top: 10px;"> <div style="border: 1px solid black; padding: 5px; margin-right: 10px;">Playback of audio data</div> <div style="font-size: 2em; margin-right: 10px;">+</div> <div style="border: 1px solid black; padding: 5px; margin-left: 10px;">Keyboard play</div> </div> </div>
System track	While playing back...						
Solo track	While playing back...						
	Keyboard play						

### \*1 MIDI

MIDI is short for “Musical Instrument Digital Interface”. It is a universal standard that makes it possible for musical instruments, computers, and other devices to exchange performance information (keyboard key press/release, key velocity, etc.) regardless of manufacturer. Performance data in this case is called “MIDI data”.

### \*2 Audio data

Audio data recorded with this Digital Piano is saved in WAV file format (linear PCM, 16bit, 44.1kHz, stereo).

### NOTE

- For details about the file formats of data supported by this Digital Piano, see “[Data Types Supported by the Digital Piano](#)” (page EN-133).
- Data recorded on the Digital Piano can be saved to a USB flash drive. For more information, see “[Saving Digital Piano Data to a USB Flash Drive](#)” (page EN-137).

## Using the MIDI Recorder to Record Performances

The MIDI recorder records keyboard performances and pedal operations as MIDI data.

### Recording with the MIDI Recorder

#### 1. Put the Digital Piano into MIDI Mode.

- Under the initial default settings, the Digital Piano is in MIDI Mode. In this case, proceed to step 2.
- (1) Touch the **FUNCTION** button to display the FUNCTION menu.
  - (2) Use the touch ring to select “SONG” and touch the **ENTER** button.

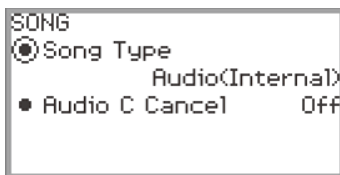

- (3) Trace the touch ring to set the “Song Type” to “MIDI” (MIDI Mode).
- (4) Touch and hold the **EXIT** button to exit the setup screen.

#### 2. If necessary, set tones, effects, tempo, etc. for recording.

- See “[Changing the Metronome Settings \(Tempo, Beat, Pattern, etc.\)](#)” (page EN-74) for beat and tempo settings, and whether the metronome should sound during recording. To have the Metronome sound while recording, set “While Recording” to “On” in the “METRONOME” screen.
- A MIDI recorder song has two recording tracks (a system track and a solo track), and some settings (such as effects) are recorded only on the system track. For what’s recorded on each track, see “[Items Reflected in Contents When Recording to the MIDI Recorder Song](#)” (page EN-114).

#### 3. If necessary, select the song number to record to before recording.

- This operation may be omitted.
- If you select a song number that has already been recorded, the previous recording will be overwritten. Only when you want to intentionally overwrite or select a specific song number, perform the following operation.

- (1) Touch the **▶/■** button to display the SONG mode screen.



(2) Trace the touch ring to select one of the song numbers 011 to 015.

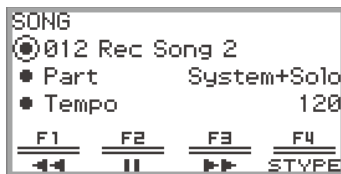

- See “NOTE” on page [EN-109](#) for the song number of the MIDI recorder song.

#### 4. Touch the **●REC** button.

The **●REC** button flashes red and the Digital Piano is ready to record.



- Touching the **●REC** button again here exits record standby.
- Touch and hold the **●REC** button to select the recording track and pre-count settings. For more information, see “MIDI Recorder Recording Settings” (page [EN-110](#)).

#### 5. To start recording, touch the **▶/■** button.

When recording starts, the **●REC** button lights up red.

- Recording can also be started automatically by pressing a keyboard key and starting to play. Recording can also be started with any of the following operations:
  - Pressing down on the pedal
  - Recalling a registration (page [EN-82](#))
  - Pressing either of the **EX** button or the **CONTROL** button
  - Moving the pitch bend wheel up or down
- When the remaining available capacity is low during recording, the **●REC** button will flash. When no more capacity is available, the **●REC** button light will turn off and recording will stop.
- If you want to redo the recording due to a mistake while playing, touch and hold the **●REC** button during recording. The recorded data will be discarded, and the Digital Piano will return to recording standby.

## 6. To end recording, touch the **●REC** button.

The **●REC** button will show a white light once again and the SONG mode screen will appear.

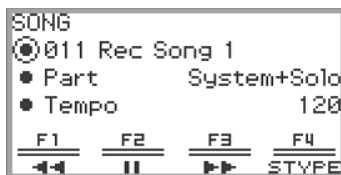

- If you want to immediately play back the recorded MIDI recorder song, touch the **▶/■** button.
- For more information on playback operations, see “[Playing Back MIDI Recorder Songs](#)” (page EN-112).

### **NOTE**

- MIDI recorder songs are stored in song numbers 011 to 015, “011 Rec Song 1” to “015 Rec Song 5” in the internal memory. Up to five songs can be recorded. Each time you record, the lowest song number that has not yet been recorded is automatically selected. However, please note the following:
  - When the SONG mode screen is displayed in step 3 or step 6, and a song number between 011 and 015 is selected, touching the **●REC** button to start recording will overwrite the selected song number.
  - If all five songs have been recorded and step 3 is omitted, when the **●REC** button is touched in step 4, “Data Full” will be displayed and recording will not begin. See “[Deleting a MIDI Recorder Song \(Entire Song/Individual Tracks\)](#)” (page EN-113) to erase songs so that you can record again.
- The **FUNCTION** button is inoperative during recording. In addition, the function names of the functions in the F Button Menu that cannot be used are displayed as “----”.



## ■ MIDI Recorder Recording Settings

A MIDI recorder song has two recording tracks (system track and solo track), and you can choose which track to record to. A precount can also be set to indicate when recording will begin.

### 1. Perform the operation described in steps 1 through 4 of “Recording with the MIDI Recorder” (page EN-107).

The ●REC button flashes red and the Digital Piano is ready to record.

### 2. Touch and hold the ●REC button.

The “RECORD SETTING” screen appears (record standby is maintained).

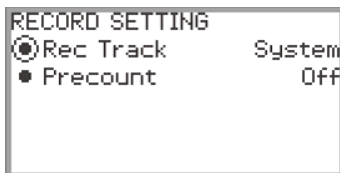

### 3. Touch the top or bottom of the touch ring to select the setting you want to change.

- The table below shows the setting values and settings for each setting item.

Setting item	Setting values and descriptions
Rec Track	System: Records to the system track. Solo: Records to the solo track. For the recording content of each track see “Items Reflected in Contents When Recording to the MIDI Recorder Song” (page EN-114).
Precount	Sets the pre-count before recording begins Off: Pre-count is not sounded 1 Measure: One-bar measure pre-count 2 Measures: Two-bar measure pre-count

### 4. Change the setting of the selected item.

- Trace the touch ring to change the desired setting.

### 5. Repeat steps 3 and 4 as necessary.

### 6. To start recording with the changed settings, resume operation from step 5 of “Recording with the MIDI Recorder” (page EN-107).

- To stop recording at this point, touch the ●REC button. The ●REC button will light up white again.

## Recording a Second Track Over the First (System Track + Solo Track)

You can record to one track while playing back a pre-recorded track of a MIDI recorder song.

### NOTE

- If you make a mistake while overdub recording, you can erase and re-record the overdubbed track. For more information, see “[Deleting a MIDI Recorder Song \(Entire Song/Individual Tracks\)](#)” (page [EN-113](#)).

1. See “[Playing Back MIDI Recorder Songs](#)” (page [EN-112](#)) to select a pre-recorded MIDI recorder song.
  - Play the selected song to check the recording and the tracks that have already been recorded.
2. Touch the **●REC** button.  
The **●REC** button flashes red and the Digital Piano is ready to record.
3. Touch and hold the **●REC** button to display the “RECORD SETTING” screen.
4. Trace the touch ring to set the “Rec Track” to “System” or “Solo”.
  - Select “Solo” to record the solo track while playing the pre-recorded system track, or “System” to record the system track while playing the pre-recorded solo track.

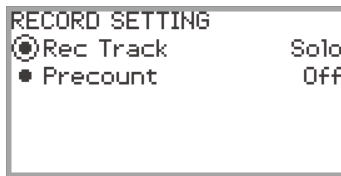

5. Start and stop recording as shown in step 5 and after in “[Recording with the MIDI Recorder](#)” (page [EN-107](#)).

## Playing Back MIDI Recorder Songs

### 1. Touch the ►/■ button.

The SONG mode screen appears.

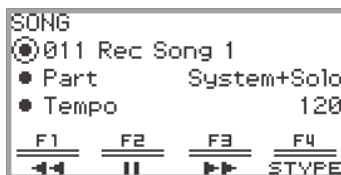

- If any songs have been recorded (or played) since the Digital Piano was turned on, the last song recorded (or played) will be played. To stop playback, touch the ►/■ button.
- From the SONG mode screen, you can play MIDI recorder songs as well as MIDI and audio data in various formats. For more information, see “[Listening to Songs \(SONG Mode\)](#)” (page EN-100).

### 2. If in Audio Mode, change to MIDI Mode.

- If “Part” and “Tempo” are not displayed in the SONG mode screen, the Digital Piano is in Audio Mode. Perform the following operation to change it to MIDI Mode.
  - (1) Touch the **F4** button (STYPE).
  - (2) Trace the touch ring to change the “Song Type” setting to “MIDI”.
  - (3) Touch the **EXIT** button to return to the SONG mode screen.

### 3. Trace the touch ring to select the MIDI recorder song you want to play.

The five MIDI recorder songs are named “011 Rec Song 1” to “015 Rec Song 5”. Select the number of a song that has already been recorded.

### 4. If necessary, set the part and tempo to be played.

Touch the top or bottom of the touch ring to select the setting you want to change.

Setting item	Setting values and descriptions
Part	System + Solo: Plays both tracks System: Plays only the system track Solo: Plays only the solo track
Tempo	Sets the playback tempo from 20 to 255 (beats/minute).

### 5. To start playback, touch the ►/■ button.

- During playback, the following operations are available.
  - Touch the **F1** button (◀◀): Backs up the song a little.
  - Touch and hold the **F1** button (◀◀): While held down, the song will rewind.
  - Touch the **F2** button (||): Pauses the currently playing song. Touch while paused to resume playback.
  - Touch the **F3** button (▶▶): Advances the song a little.
  - Touch and hold the **F3** button (▶▶): While held down, the song will fast-forward.
- When the song reaches the end, playback will stop. Touch the ►/■ button to stop midway.

## Deleting a MIDI Recorder Song (Entire Song/Individual Tracks)

1. “**Playing Back MIDI Recorder Songs**” (page EN-112) operation to select the MIDI recorder song you want to erase.
2. Touch and hold the **●REC** button.  
The “CLEAR” screen appears.

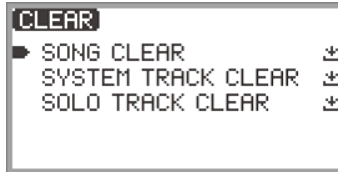

3. Touch the top or bottom of the touch ring to select the target (the entire song or a track) you want to erase.

Menu item	What will be erased
SONG CLEAR	Erases the entire song
SYSTEM TRACK CLEAR	Erases the system track only
SOLO TRACK CLEAR	Erases the solo track only

4. Touch the **ENTER** button.

A confirmation screen will appear. To cancel the operation, touch the left of the touch ring (NO) here.



5. To erase, touch the right of the touch ring (YES).  
“Complete” is displayed and the display returns to the SONG mode screen.

## Items Reflected in Contents When Recording to the MIDI Recorder Song

The symbols below are used in the “System” column to indicate items that can be recorded to the system track, and in the “Solo” column to indicate items that can be recorded to the solo track.

✓... Recorded    — ... Not recorded

Operation or Setting	System	Solo
Keyboard operations	✓	✓
Pedal operations*1	✓*2	✓*2
Pitch Bend Wheel operations	✓	✓
Pitch bend range	✓	✓
EX button operations	✓	✓*3
CONTROL button operations	✓	✓
Acoustic Simulator settings	✓	—
Chorus type	✓	—
Brilliance setting	✓	—
Hall Simulator/Reverb settings		
On/Off	✓	—
Type	✓	—
Surround settings	✓	—
Portamento		
Portamento On/Off	✓	✓*4
Portamento Time	✓	✓*4
Tone number	✓	✓*4
Layer, Split	✓	—
Mixer		
Volume		
Keyboard overall volume	✓	—
Upper1, Upper2, Lower part volume	✓	✓*4
Pan		
Upper1, Upper2, Lower part pan	✓	✓*4
Hall Simulator/Reverb		
Overall reverb depth (reverb return)	✓	—
Upper1, Upper2, Lower part send	✓	✓*4
Chorus		
Upper1, Upper2, Lower part send	✓	✓*4
Octave Shift	✓*5	✓*4 *5

Operation or Setting	System	Solo
Part Fine Tune	✓	✓*4
Scale settings	✓	—
Duet settings	✓	—
Metronome		
Tempo	✓	—
Beat	✓	—

\*1 Operation of pedals connected to this Digital Piano

\*2 Not recorded depending on the function assigned to the pedal that is connected to the **EXPRESSION/ASSIGNABLE** jack.

\*3 Not recorded depending on the function assigned to the **EX** button.

\*4 Upper 1 only

\*5 Octave-shifted notes are recorded.

## Recording a Performance with the Audio Recorder

The audio recorder records the sound output from the Digital Piano as audio data, as shown below.

- Keyboard playing
- Audio input from a smart device connected via Bluetooth audio (only when recording to the internal memory)
- Audio input from microphone, etc.

### Recording Using the Audio Recorder

#### 1. Put the Digital Piano into Audio Mode.

- (1) Touch the **FUNCTION** button to display the FUNCTION menu.
- (2) Use the touch ring to select “SONG” then touch the **ENTER** button.

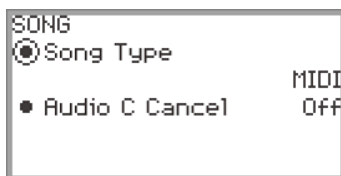

- (3) Trace the touch ring to select the “Song Type” setting from the following:
  - “Audio(USB Drv)” .....Records to a USB flash drive in Audio Mode
  - “Audio(Internal)” .....Records to the internal memory in Audio Mode
- (4) Touch and hold the **EXIT** button to exit the setup.

#### 2. If you selected “Audio(USB Drv)” in step 1, plug a USB flash drive into the **USB Type A** port on this Digital Piano.

- When a USB flash drive is plugged in, “MOUNTING” will be displayed for a while. It may take a minute or so for the display to disappear.
- For information on handling USB flash drives and installing and removing them from the Digital Piano, see “[Connecting a USB Flash Drive to and Detaching It from the Digital Piano](#)” (page EN-135).

#### 3. Touch the **REC** button.

The **REC** button flashes red and the Digital Piano is ready to record.

- Touching the **REC** button again here cancels record standby.
- When recording to the internal memory, the remaining capacity of the internal memory is displayed.

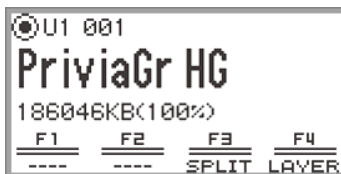

- When recording to the internal memory, “Wait...” may be displayed for a while, depending on the status of the Digital Piano. In this case, wait until the display disappears.

#### 4. To start recording, touch the ►/■ button.

When recording starts, the ●REC button lights up red.

- Recording can also be started automatically by pressing a keyboard key and starting to play. Recording can also be started with any of the following operations:
  - Pressing down on a foot pedal
  - Recalling a registration (page EN-82)
  - Pressing either of the **EX** button or the **CONTROL** button
  - Moving the pitch bend wheel up or down
- When the remaining available capacity is low during recording, the ●REC button will flash. When no more capacity is available, the ●REC button light will turn off and recording will stop.
- If you want to redo the recording due to a mistake while playing, touch and hold the ●REC button during recording. The recorded data will be discarded, and the Digital Piano will return to recording standby.

#### 5. To stop recording, touch the ●REC button.

The ●REC button will show a white light once again and the SONG mode screen will appear.



- If you want to play the recorded audio recorder song immediately, touch the ►/■ button.
- For more information on playback operations, see “Playing Back a Song from the Audio Recorder” (page EN-119).

#### NOTE

- Audio recorder songs are saved with the file name “TAKE\*\*.wav” (where \*\* is 01 to 99). Up to 99 songs can be recorded to the internal memory and USB flash drive, respectively. Each time a recording is made, a file is automatically created with the next number in sequence in the destination memory (internal or USB). For information on what to do if you get a “Too Many Files” message and cannot start recording, see “Error Messages” (page EN-162).
- The **FUNCTION** button is inoperative during recording. In addition, the function names of the functions in the F Button Menu that cannot be used are displayed as “----”.
- The Digital Piano’s audio recorder records in WAV format. Recording in MP3 format is not supported.
- The table below lists the audio data that can be recorded and played back on the Digital Piano.

WAV format (Record and playback)	USB flash drive	<ul style="list-style-type: none"> <li>The maximum recorded length of a file is approximately 25 minutes, and up to 99 files can be recorded (however, this depends on the available capacity of the USB flash drive used).</li> <li>There is no limit to the playback time of a single file (depends on the available capacity of the USB flash drive).</li> </ul>
	Internal memory:	<ul style="list-style-type: none"> <li>If there is no existing data in the internal memory, it is possible to record for up to approximately 18 minutes. Up to 99 files can be recorded within a total recording time of approximately 18 minutes.</li> <li>The maximum playback time for a single file is approximately 18 minutes.</li> </ul>



MP3 format (Playback only)	USB flash drive	There is no limit to the playback time of a single file (depends on the available capacity of the USB flash drive).
	Internal memory:	MP3 files of 186,046 KB or less can be played. The maximum playback time depends on the bit rate of the MP3 file.

- Audio data in WAV and MP3 formats can be loaded from a USB flash drive to the internal memory or saved from the internal memory to a USB flash drive. For more information, see “[USB Flash Drive](#)” (page [EN-132](#)).
- The formats of audio data that can be played on this Digital Piano are shown below. (For playback operations, see “[Playing Back a Song from the Audio Recorder](#)” (page [EN-119](#)).

#### WAV format audio data

File name extension	.WAV
Format	Linear PCM
Sampling frequency	44.1 kHz
Bit depth	16bit
Channel	Stereo

#### MP3 format audio data

File name extension	.MP3
Format	MPEG-1 Audio Layer3
Sampling frequency	44.1 kHz/48 kHz
Bit rate	32 to 320 kbps variable bit rate (VBR)
Channel	Monaural/Stereo

## Playing Back a Song from the Audio Recorder

### 1. Touch the ►/■ button.

The SONG mode screen appears.



- If any songs have been recorded (or played) since the Digital Piano was turned on, the last song recorded (or played) will be played. To stop playback, touch the ►/■ button.
- The SONG mode screen allows playback of MIDI data and audio data in various formats as well as audio recorder songs. For more information, see “[Listening to Songs \(SONG Mode\)](#)” (page EN-100).

### 2. If the Digital Piano is in MIDI Mode, change to Audio Mode.

- When “Part” or “Tempo” is displayed on the SONG mode screen, the Digital Piano is in MIDI Mode. Use the following operation to change to Audio Mode.
  - (1) Touch the **F4** (STYPE) button.
  - (2) Trace the touch ring to change the “Song Type” setting to “Audio(USB Drv)” (to play a song from the USB flash drive) or “Audio(Internal)” (to playback songs from the internal memory).
  - (3) Touch the **EXIT** button to return to the SONG mode screen.

### 3. Trace the touch ring to select the audio recorder song you want to play.

### 4. To start playback, touch the ►/■ button.

- During playback, the following operations are available.
  - Touch the **F1** button (◀◀): Backs up the song a little.
  - Touch and hold the **F1** button (◀◀): While held down, the song will rewind.
  - Touch the **F2** button (||): Pauses the currently playing song. Touch while paused to resume playback.
  - Touch the **F3** button (▶▶): Advances the song a little.
  - Touch and hold the **F3** button (▶▶): While held down, the song will fast-forward.
- When the song reaches the end, playback will stop. Touch the ►/■ button to stop midway.

## Deleting a Song from the Audio Recorder

1. See “[Playing Back a Song from the Audio Recorder](#)” (page [EN-119](#)) to select the audio recorder song you want to erase.

2. Touch and hold the **●REC** button.

A confirmation screen will appear. To cancel the operation, touch the left of the touch ring (NO) at this point.



3. To erase, touch the right of the touch ring (YES).

“Wait...” is displayed during the erase process. When done, “Complete” is displayed and the display returns to the SONG mode screen.

# Adjusting Keyboard Sensitivity

## Changing Keyboard Response to Key Velocity (Touch Response)

Touch Response alters tone volume in accordance with keyboard velocity (speed). This provides you some of the same expressivity you get on an acoustic piano.



Pressing fast produces louder notes.

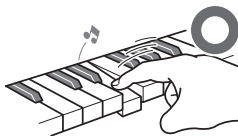

Pressing slowly produces softer notes.



Do not try to use too much pressure.

## Changing Touch Response Sensitivity

1. Touch the **FUNCTION** button to display the **FUNCTION** menu.
2. Use the touch ring to select “**KEYBOARD**” > “**KBD SETTING**” then touch the **ENTER** button.

The “KBD SETTING” screen appears.

- Confirm that the cursor (○) is on “Touch Response”.

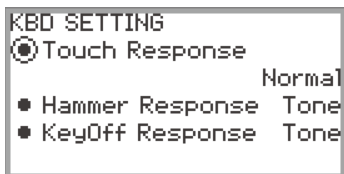

### 3. Change the value of the “Touch Response” setting.

Setting value	Description
Off	Disables Touch Response. Sound volume is fixed, regardless of key press speed.
Light 2 Light 1	Makes production of a louder sound easier, so touch feels lighter than “Normal”. “Light 2” is lighter to the touch than “Light 1”.
Normal	Specifies normal sensitivity.
Heavy 1 Heavy 2	Makes production of a louder sound more difficult, so touch Heavy feels heavier than “Normal”. “Heavy 2” is heavier to the touch than “Heavy 1”.

- Trace the touch ring to change the desired setting value.

## Adjusting the Timing of Key Press to Sound (Hammer Response)

An acoustic piano has hammers of different sizes that strike the strings in different key ranges, so the timing of the sound is different for each key range. “Hammer Response” in the FUNCTION menu can be used to select the timing of the sound.

### Adjusting the Hammer Response

1. Touch the **FUNCTION** button to display the FUNCTION menu.
2. Use the touch ring to select “KEYBOARD” > “KBD SETTING” > “Hammer Response”.

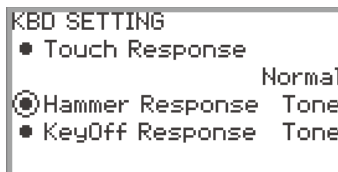

### 3. Change the “Hammer Response” setting.

Setting value	Description
Tone	A value appropriate for the selected tone is automatically set.
Off	Fastest response in all key ranges.
1 to 10	The higher the value, the slower the timing of the sound.

- Use the touch ring to change the desired value.

## Adjusting the Timing of Key Release to Sound Damping (Key-off Response)

On a grand piano, when a key is released, the damper comes down on the strings and the note is damped. The Digital Piano's Key-off Response function simulates digitally the timing of the note damping based on how the key is released.

Using this function, you can set it to allow subsequent key strikes to sound even if the key is not fully released during a series of same-note hits – just like a grand piano. This makes possible detailed touch expressions such as whether notes are connected or cut off, allowing for a natural playing feel.

The “KeyOff Response” in the FUNCTION menu can be used to adjust the timing of the damping.

### Adjusting the Key-off Response

1. Touch the **FUNCTION** button to display the FUNCTION menu.
2. Use the touch ring to select “KEYBOARD” > “KBD SETTING” > “KeyOff Response”.

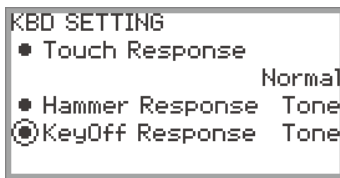

3. Change the “KeyOff Response” setting.

Setting value	Description
Tone	A value appropriate for the selected tone is automatically set.
1 to 3	The higher the value, the slower the timing of the sound.

- Use the touch ring to change the desired setting value.

# Changing the Pitch

## Changing the Pitch in Semitone Steps (Transpose)

Use the transpose feature to raise or lower the pitch of all notes in semitone steps. This allows you to transpose the key of your playing to another key.

### Changing the Transpose Setting

1. Select the “12 Control” of the F Button Set. See “[To change the F Button Set](#)” (page [EN-32](#)).

2. Touch the **F2** button (TRANS).

The “TRANPOSE” screen appears.

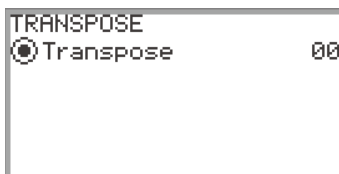

3. Trace the touch ring to change the setting value.

- It can be changed to a value between -12 and +12 semitones.

## Fine Tuning a Pitch (Master Tuning)

Use the tuning feature when you need to adjust the overall pitch of the Digital Piano.

- The tuning feature specifies the frequency of the A4 note. You can set a frequency within the range of 415.5 to 465.9 Hz. The initial default setting is 440.0 Hz.
- You can change the frequency in 0.1 Hz steps.

1. Touch the **FUNCTION** button to display the **FUNCTION** Menu.

2. Touch the top or bottom of the touch ring to select “SYSTEM”, then touch the **ENTER** button.

The “SYSTEM” screen appears.

- Confirm that the cursor (○) is on “Master Tuning”.

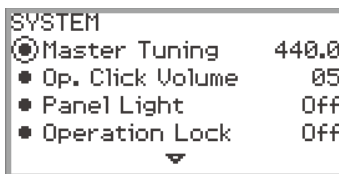

3. Change the value of the “Master Tuning” setting.

- Trace the touch ring to change the desired setting value.

## Adjusting the Tuning Separately for Each Part (Upper 1/Upper 2/Lower) (Part Fine Tune)

Each part can be individually fine-tuned between -99 and +99 cents (100 cents = 1 semitone) relative to the tuning of the entire instrument. By shifting the tuning of each part slightly, you can create a full-bodied ensemble feel.

### NOTE

- For details on parts, see “[Sounding Two Different Tones at the Same Time \(Layer\)](#)” (page EN-44) and “[Splitting the Keyboard Between Two Tones \(Split\)](#)” (page EN-46).

1. Touch the **FUNCTION** button to display the **FUNCTION** Menu.
2. Use the touch ring to select “**KEYBOARD**” > “**PART FINE TUNE**”, then touch the **ENTER** button.

The “PART FINE TUNE” screen appears.

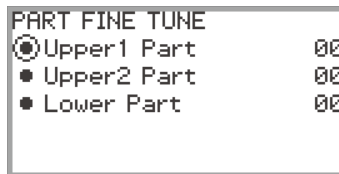

3. Touch the top or bottom of the touch ring to select the part you want to fine-tune.
4. Change the setting value of the selected part.
  - Trace the touch ring to change the desired setting value.
5. Repeat Steps 3 and 4 as necessary.



## Changing the Pitch in Octave Units (Octave Shift)

Use the Octave Shift feature to raise or lower the pitch of all notes in octave units. Each part (Upper 1, Upper 2, Lower) can be set individually when using the Layer or Split functions.

### NOTE

- For details on parts, see “[Sounding Two Different Tones at the Same Time \(Layer\)](#)” (page EN-44) and “[Splitting the Keyboard Between Two Tones \(Split\)](#)” (page EN-46).

### Using Octave Shift Separately for Each Part (Upper 1/Upper 2/Lower)

1. Touch the **FUNCTION** button to display the FUNCTION Menu.
2. Use the touch ring to select “**KEYBOARD**” > “**PART OCT SHIFT**”, then touch the **ENTER** button.

The “PART OCT SHIFT” screen appears.

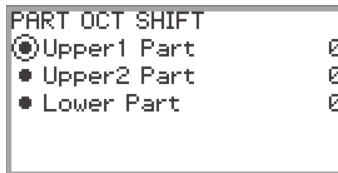

3. Touch the top or bottom of the touch ring to select the part to octave shift.
4. Change the setting value of the selected part.
  - Trace the touch ring to change the desired setting value.
5. Repeat Steps 3 and 4 as necessary.

## Changing the Scale Tuning (Temperament) of the Keyboard

You can change the scale of the keyboard from the standard equal temperament to another scale that is more suitable for playing Indian music, Arabic music, classical music, etc. You can select from among the 17 preset scales described below.

### Changing the Scale

1. Touch the **FUNCTION** button to display the **FUNCTION** Menu.
2. Use the touch ring to select “**KEYBOARD**” > “**SCALE TUNING**”, then touch the **ENTER** button.

The “**SCALE TUNING**” screen appears.

- Confirm that the cursor (○) is on “Scale Type”.

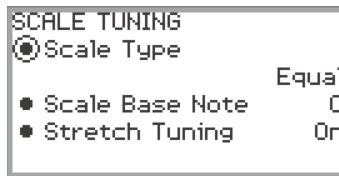

3. Change the “**Scale Type**” setting value.

- Trace the touch ring to change the desired setting value.
- You can choose from the temperaments in the table below.

Setting Value	Scale (Temperament) Name
Equal	Equal Temperament
Pure Major	Pure Major Temperament
Pure Minor	Pure Minor Temperament
Pythagorean	Pythagorean Temperament
Kirnberger 3	Kirnberger 3 Temperament
Werckmeister	Werckmeister Temperament
Mean-Tone	Mean-Tone Temperament
Rast	Rast
Bayati	Bayati
Hijaz	Hijaz
Saba	Saba
Dashti	Dashti
Chahargah	Chahargah
Segah	Segah
Gurjari Todi	Gurjari Todi
Chandrakauns	Chandrakauns
Charukeshi	Charukeshi

#### 4. If necessary, change the base note of the scale.

- (1) In the “SCALE TUNING” screen, touch the top or bottom of the touch ring to select the “Scale Base Note”.
- (2) Trace the touch ring to change the desired base note.

### Enabling or Disabling Piano Stretch Tuning

Generally, a piano is tuned so high notes are relatively higher and low notes are relatively lower. This type of tuning is called “stretch tuning”. You can disable Stretch Tuning, if you want.

1. Touch the **FUNCTION** button to display the **FUNCTION** Menu.
2. Use the touch ring to select “**KEYBOARD**” > “**SCALE TUNING**” > “**Stretch Tuning**”.

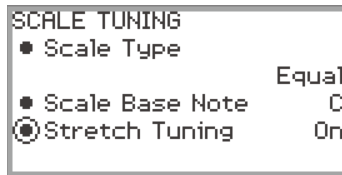

3. Trace the touch ring to toggle the setting value between “On” and “Off”.

# Splitting the Keyboard for Duet Play

You can split the keyboard in the center for duet play so the left and right sides have the same ranges. The Duet function is the perfect way to conduct lessons, with the teacher playing on the left side as the student plays the same song on the right side. You can also change the ranges of the left and right keyboards in octave units from their initial default settings.

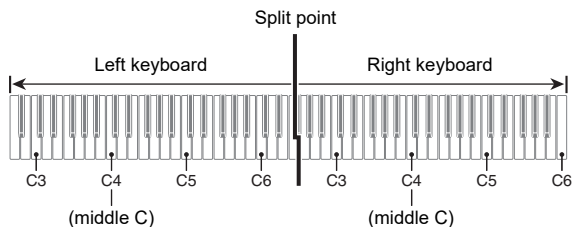

## Using the Duet

1. Select the "14 Duet" of the F Button Set. See "[To change the F Button Set](#)" (page [EN-32](#)).
2. Touch the **F1** button (DUET).  
Duet is turned on, and the **DM** indicator appears on the display.

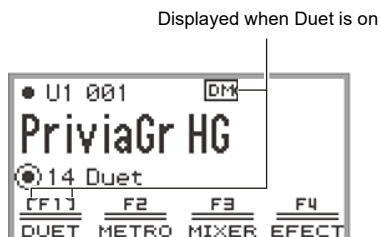

3. If necessary, change the settings for the Duet function.
  - The keyboard range can be changed in octave units, and the sound output by the left and right side of the keyboard can be split between the left and right speakers. For more information, see "[Configuring Duet Settings](#)" (page [EN-131](#)).

#### 4. Play duets using the left and right sides of the keyboard.

- When Duet is active, the left and right pedals serve as damper pedals for the left and right-side of the keyboard, respectively, and the center pedal serves a damper pedal for both left and right. The strength of the pedal's effect varies continuously with the depth to which you depress the pedal (when using the included pedal unit).

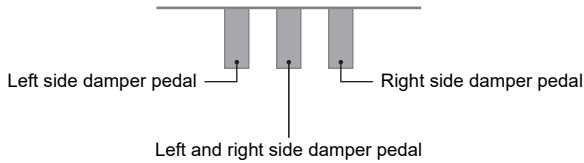

#### 5. To turn off Duet, touch the **F1** button (DUET). The **DM** indicator disappears.

##### **NOTE**

- A sustain pedal (sold separately) can be connected to the **EXPRESSION/ASSIGNABLE** jack and used as a shared (left and right) damper pedal. Half-pedal operation is not supported.
- Some settings cannot be changed while Duet is active.
- The following functions are assigned to the **CONTROL**, **EX1**, and **EX2** buttons, respectively, while Duet is active (they cannot be changed).

**CONTROL** button: Modulation

**EX1** button: Sustain

**EX2** button: Start/Stop

## Configuring Duet Settings

1. Select the “14 Duet” of the F Button Set. See “[To change the F Button Set](#)” (page [EN-32](#)).
2. Touch and hold the **F1** button (DUET).  
The “DUET” screen appears.

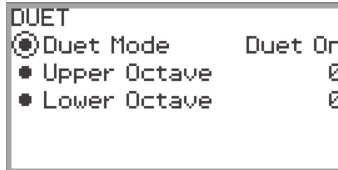

3. Touch the top or bottom of the touch ring to select the item whose setting value you want to change.
  - The table below shows the setting values and details for each setting item.

Setting Item	Setting Value	Description
Duet Mode	Duet On	Both speakers output sound from both the left and right sides of the keyboard.
	Duet Pan	The left speaker outputs sound from the left side of the keyboard only, and the right speaker outputs sound from the right side of the keyboard only.
Upper Octave, Lower Octave	-2, -1, 0, +1, +2	“Upper Octave” raises or lowers the range of the right side of the keyboard, while “Lower Octave” raises or lowers the range of the left side of the keyboard, both in octave units. Increasing the setting value by one raises the keys one octave. Decreasing it by one lowers the keys one octave (initial default setting: 0).

4. Change the setting value of the selected item.
  - Trace the touch ring to change the desired setting value.

5. Repeat Steps 3 and 4 as necessary.

### NOTE

- When “Duet Mode” is set to “Duet Pan”, the Hall Simulator/Reverb (page [EN-49](#)), Surround (page [EN-49](#)), Chorus (page [EN-52](#)), and Acoustic Simulator (page [EN-54](#)) functions and some Mixer settings (page [EN-60](#)) are not available.

# USB Flash Drive

Your Digital Piano supports the following USB flash drive operations.

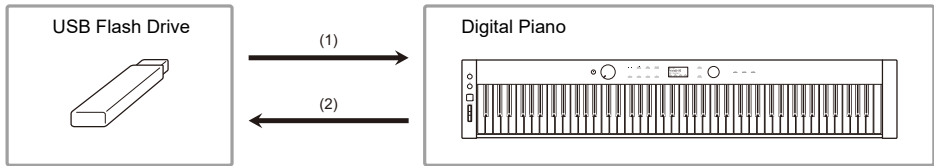

## (1) USB Flash Drive on the Digital Piano

- Playing back audio data on a USB flash drive  
“[Listening to Songs \(SONG Mode\)](#)” (page [EN-100](#))
- Playing back MIDI files on a USB flash drive  
“[Listening to Songs \(SONG Mode\)](#)” (page [EN-100](#))
- Loading compatible files on a USB flash drive into the Digital Piano’s Internal Memory  
“[Loading USB Flash Drive Data into the Digital Piano’s Internal Memory](#)” (page [EN-139](#))
- Deleting USB flash drive files  
“[Deleting a USB Flash Drive File](#)” (page [EN-140](#))
- Renaming USB flash drive files  
“[Renaming a USB Flash Drive File](#)” (page [EN-141](#))

## (2) Saving Digital Piano Data to a USB Flash Drive

Saving the following data recorded by this Digital Piano to a USB flash drive allows you to load and use the data in the future.

- Audio recorder songs
- MIDI recorder songs
- Registration data
- All user data  
“[Saving Digital Piano Data to a USB Flash Drive](#)” (page [EN-137](#))

## Preparing a USB Flash Drive

This section explains the information below.

- USB flash drive supported for use with the Digital Piano
- Data types supported by the Digital Piano using a USB flash drive
- Connecting a USB flash drive to and detach it from the Digital Piano
- Formatting a USB flash drive

## Supported USB Flash Drives

Capacity: 32GB or less recommended

### IMPORTANT!

- Use a FAT (FAT32 or exFAT) format USB flash drive.
- You may not be able to use a USB flash drive that is recognized as multiple drives on your computer.
- A USB flash drive that is recognized as a CD-ROM on your computer is not supported.
- A USB flash drive with an anti-virus function and/or security functions is not supported.

## Data Types Supported by the Digital Piano

Data from a USB flash drive that can be read by the Digital Piano includes song data (MIDI and audio data), registration data, and all user data stored in the Digital Piano.

### ■ Song Data

#### Audio Data

- WAV format:

This is a standard audio file format used primarily by Windows. The Digital Piano supports the following WAV file format:

Linear PCM, 16-bit, 44.1kHz, stereo, file name extension: .WAV

- MP3 format:

This is a common audio file format used widely in online music distribution, etc. This Digital Piano supports the following MP3 file formats:

MPEG-1 Audio Layer3, 44.1kHz/48kHz, 32 to 320kbps variable bit rate (VBR), monaural/stereo, file name extension: .MP3

#### MIDI Data

- MRF format (CASIO original file format):

MIDI data recorded with the Digital Piano's MIDI Recorder. (file name extension: .MRF)

- CMF format (CASIO original file format):

This file format adds CASIO proprietary data to MIDI data. (file name extension: .CMF)

- SMF (Standard MIDI File) Format 0/1:

Standard MIDI file format that can be exchanged with a compatible device from another manufacturer. (File name extension: .MID)

Data Type		File Name Extension	Save (Digital Piano → USB Flash Drive)	Load (USB Flash Drive → Digital Piano)	Direct Recording to USB Flash Drive	Direct USB Flash Drive Playback
Audio Data	Audio Recorder song file (page EN-116)	.WAV	Yes	Yes	Yes	Yes
	General audio file	.WAV	Yes*1		—	
		.MP3				
MIDI Data	MIDI Recorder song files (page EN-107)	.MRF	Yes*2	Yes	—	—
	CASIO MIDI file*3	.CMF	—	Yes*4	—	Yes
	Standard MIDI file (SMF format)	.MID				

\*1 WAV and MP3 files loaded from a USB flash drive to the Digital Piano's internal memory can be saved as is from the internal memory to a USB flash drive.

\*2 Can be converted to Standard MIDI file (SMF format 0, File name extension: .MID) for save.

- Saving as a MRF format file

In addition to performance information, model-specific settings (such as Acoustic Simulator) are also saved to the file, so you can reproduce the original performance in its entirety after reloading the data.

Note, however, that MRF file data is not compatible with other musical instrument types and models.



– Saving as an SMF format file

Performance information is saved, but models specific-settings are not saved. Because of this, playback of a reloaded file will be in accordance with the current Digital Piano setup, which may be different from the original setup. If you want to play with the original setup, you will need to configure it manually. Since this is an SMF file, it can be used on another musical instrument that supports SMF. Of course, playback will be somewhat different when played on another musical instrument.

\*3 Songs downloaded from the CASIO website, etc.

\*4 The song is loaded as a user song (song number 001 to 010). See “Data Types of Playable Songs” (page EN-100).

### Copyrights

The rights of creators and copyright holders of music, images, computer programs, databases, and other data are protected by copyright laws. You are allowed to reproduce such works for personal or noncommercial use only. For any other purpose, all reproduction (including data format conversion), modification, transfer of reproductions, distribution over a network, or any other use without permission of the copyright holder exposes you to claims for damages and criminal prosecution for copyright infringement and violation of the author's personal rights. Be sure to reproduce and otherwise use copyrighted works only in accordance with applicable copyright laws.

### ■ Registration Data

Registration data from the Digital Piano can be saved to a USB flash drive as banks (extension: .RBK). RBK files can be loaded into the Digital Piano from a USB flash drive.

For details on registration, see “Saving and Recalling Performance Setups (Registration)” (page EN-79).

### ■ All User Data

All user data stored in the Digital Piano can be saved as a single file to a USB flash drive (extension: .DAL). Saved DAL files can be loaded into the Digital Piano from a USB flash drive.

## Connecting a USB Flash Drive to and Detaching It from the Digital Piano

- Be sure to observe the precautions provided in the documentation that comes with the USB flash drive.
- Avoid using a USB flash drive under the following conditions. Such conditions can corrupt data stored on the USB flash drive.
  - Areas subjected to high temperature, high humidity, or corrosive gas
  - Areas subjected to strong electrostatic charge and electrical noise
- Never remove the USB flash drive while data is being written to or loaded from it. Doing so can corrupt the data on the USB flash drive and damage the **USB** Type A port.
- Never insert anything besides a USB flash drive into the **USB** Type A port. Doing so creates the risk of malfunction.
- When you perform a USB flash drive operation while a USB flash drive is plugged in, the Digital Piano initially needs to perform a “mounting” sequence to prepare for data exchange with the USB flash drive. Digital Piano operations may be momentarily difficult while a mounting sequence is being performed. The message “MOUNTING” is displayed while the USB flash drive is being mounted. It may take up to 10 or 20 seconds or even longer for a USB flash drive to be mounted. We recommend that you do not attempt to perform any operation on the Digital Piano while a mounting sequence is in progress. A USB flash drive needs to be mounted each time it is connected to the Digital Piano.

### ■ To insert a USB flash drive

#### 1. As shown in the illustration below, insert the USB flash drive into the Digital Piano’s **USB** Type A port.

- Carefully push the USB flash drive in as far as it will go. Do not use undue force when inserting the USB flash drive.

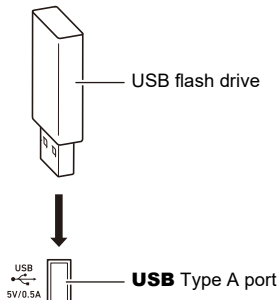

- Static electricity conducted to the **USB** Type A port from your hand or from a USB flash drive can cause malfunction of the Digital Piano. If this happens, turn the Digital Piano off and then back on again.

### ■ To remove a USB flash drive

#### 1. Check to confirm that no data read/write operation is in progress.

- Do not proceed to step 2 if data is being read or written, as in the following cases:
  - If “MOUNTING” or “Wait...” is displayed on screen
  - If the USB flash drive is in use by the audio recorder or SONG mode.

#### 2. Pull the USB flash drive straight out.

- A USB flash drive can become warm after very long use. This is normal and does not indicate malfunction.

## Formatting a USB Flash Drive

Formatting a USB flash drive on the Digital Piano will create a folder named MUSICDAT in the drive's root directory if a MUSICDAT folder does not already exist there. Use this folder when exchanging data between the Digital Piano and USB flash drive.

### IMPORTANT!

- Be sure to format a USB flash drive on the Digital Piano before using it for the first time.
- Formatting a USB flash drive deletes all data currently stored on it. Before formatting a USB flash drive, make sure it does not have any valuable data stored on it.
- The format operation performed by this Digital Piano is a “quick format”. If you want to completely delete all of the data in the USB flash drive, format it on your computer or some other device before formatting it with this Digital Piano.
- In the case of an exFAT format USB flash drive, the number of importable files may be limited if long file names are used.

1. Insert the USB flash drive you want to format into the **USB Type A** port on the Digital Piano.
2. Touch the **FUNCTION** button to display the FUNCTION Menu.
3. Use the touch ring to select “**MEDIA**” > “**FORMAT**”, then touch the **ENTER** button.

A confirmation screen appears. To cancel the operation, touch the left of the touch ring (NO).



4. To confirm the formatting, touch the right of the touch ring (**YES**).
  - Formatting begins and “Wait...” appears. Do not perform any action using the Digital Piano during this period. Formatting a large-capacity USB flash drive may take several minutes.
  - When formatting is complete, “Complete” appears.

## Saving MIDI Files or Audio Files for Playback on your Digital Piano to a USB Flash Drive

The procedure below can be used to save MIDI files (SMF or CMF) and audio files (WAV or MP3) to a USB flash drive and play them back on the Digital Piano.

1. **Connect the USB flash drive to your computer.**
2. **Create a folder named MUSICDAT in the root directory of the USB flash drive.**
  - This step is not required if there is already a MUSICDAT folder in the USB flash drive's root directory.
3. **Move the MIDI files or audio files you want to play back to the MUSICDAT folder on the USB flash drive.**
  - For information about playback see "[Listening to Songs \(SONG Mode\)](#)" (page [EN-100](#)).

### Copyrights

You are allowed to use recordings for your personal use. Any reproduction of an audio or music format file without the permission of its copyright holder is strictly prohibited under copyright laws and international treaties. Also, making such files available on the Internet or distributing them to third parties, regardless of whether such activities are conducted with or without compensation, is strictly prohibited under copyright laws and international treaties. CASIO COMPUTER CO., LTD. shall not be held in any way liable for any use of this Digital Piano that is illegal under copyright laws.

## Saving Digital Piano Data to a USB Flash Drive

1. Touch the **FUNCTION** button to display the **FUNCTION** Menu.
2. Use the touch ring to select "**MEDIA**" > "**SAVE**", then touch the **ENTER** button.  
The "MEDIA SAVE" screen displays a menu for selecting the type of data that can be saved.

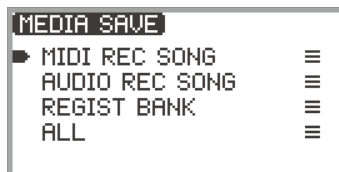

"MIDI REC SONG" ... MIDI recorder songs

"AUDIO REC SONG" ... Audio recorder songs, general audio files

"REGIST BANK" ... Registration Bank

"ALL" ... All user data in the Digital Piano's internal memory

### 3. Touch the top or bottom of the touch ring to select the type of data to save, then touch the **ENTER** button.

- If you choose “ALL”, after touching the **ENTER** button the file name edit screen will be displayed so proceed to Step 5. Otherwise, the screen for selecting the type of data to save will be displayed so proceed to Step 4.

### 4. Perform the following actions depending on the type of data you selected.

#### ■ If you selected “MIDI REC SONG”:

- (1) Touch the top or bottom of the touch ring to select the data to save, then touch the **ENTER** button.

A screen appears for selecting the file format (MRF or MID) to save the data in.

- (2) Touch the top or bottom of the touch ring to select “MRF” (dedicated format for this Digital Piano) or “MID” (SMF format), then touch the **ENTER** button.

The file name editing screen appears.

#### ■ If you selected “AUDIO REC SONG” or “REGIST BANK”:

- (1) Touch the top or bottom of the touch ring to select the data to save, then touch the **ENTER** button.

The file name editing screen appears.

### 5. Rename the file if necessary.

- For details, see “[To change a character](#)” (page EN-35), “[To insert a character](#)” (page EN-36), and “[To delete a character](#)” (page EN-36).

### 6. To confirm the file name, touch the **ENTER** button.

“Sure?” or “Replace?” appears in the screen confirming whether you want to save the file.

“Sure?” ..... Appears when there are no files with the same name on the destination USB flash drive.

“Replace?” ..... Confirms whether you want to overwrite an existing file with the same name on the destination USB flash drive.

- To exit the operation without saving, touch the left of the touch ring (NO).

### 7. To save, touch the right of the touch ring (YES).

“Wait...” is displayed during the save process. Do not perform any action on the Digital Piano while this is happening. When saving is complete, “Complete” appears.

- It may take several minutes to save audio recorder songs or all user data, depending on the size of the data.

## Loading USB Flash Drive Data into the Digital Piano's Internal Memory

1. Touch the **FUNCTION** button to display the **FUNCTION** Menu.
2. Use the touch ring to select **"MEDIA"** > **"LOAD"**, then touch the **ENTER** button.  
The **"MEDIA LOAD"** screen displays a menu for selecting the type of data you want to load.

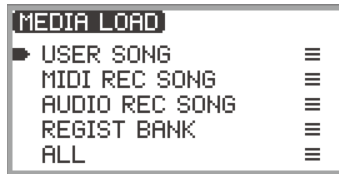

"USER SONG" ... User songs

"MIDI REC SONG" ... MIDI recorder songs

"AUDIO REC SONG" ... Audio recorder songs, general audio file

"REGIST BANK" ... Registration Bank

"ALL" ... All user data in the Digital Piano's internal memory

3. Touch the top or bottom of the touch ring to select the type of data, a file to load, then touch the **ENTER** button.

A screen appears to select which area of the Digital Piano to load.

- If **"ALL"** is selected, touching the **ENTER** button immediately displays the confirmation screen in Step 4 (**"Replace?"**).

4. Touch the top or bottom of the touch ring to select the area to load from, then touch the **ENTER** button.

The **"Sure?"** or **"Replace?"** message appears in the screen confirming whether you want to load the file.

**"Sure?"** ..... Appears when there is no data in the load destination.

**"Replace?"** ..... Checks whether you want to overwrite the data, since there is data in the load destination.

- To exit the operation without loading any data, touch the left of the touch ring (**NO**).

5. To load a file into the Digital Piano, touch the right of the touch ring (**YES**).

**"Wait..."** is displayed during the loading process. Do not perform any action on the Digital Piano while this is happening. When loading is complete, **"Complete"** appears.

- It may take several minutes to load audio recorder songs or all user data, depending on the size of the data.

## Deleting a USB Flash Drive File

1. Touch the **FUNCTION** button to display the **FUNCTION** Menu.
2. Use the touch ring to select “**MEDIA**” > “**DELETE**”, then touch the **ENTER** button.

The “**MEDIA DELETE**” screen displays a menu for selecting the types of files that can be deleted.



“**USER SONG**” ... User songs

“**MIDI REC SONG**” ... MIDI recorder songs

“**AUDIO REC SONG**” ... Audio recorder songs, general audio file

“**REGIST BANK**” ... Registration Bank

“**ALL**” ... All user data in the Digital Piano’s internal memory

3. Touch the top or bottom of the touch ring to select the type of file to delete, then touch the **ENTER** button.
4. Touch the top or bottom of the touch ring to select the file you want to delete.
5. Touch the **ENTER** button.  
A screen (“**Sure?**”) appears to confirm whether you want to delete it.
  - To exit the operation without deleting it, touch the left of the touch ring (**NO**).
6. To delete it, touch the right of the touch ring (**YES**).

“**Wait...**” is displayed during the delete process. Do not perform any action on the Digital Piano while this is happening. When deletion is complete, “**Complete**” appears.

- It may take several minutes to delete audio recorder songs or all user data, depending on the size of the data.

## Renaming a USB Flash Drive File

1. Touch the **FUNCTION** button to display the **FUNCTION** Menu.
2. Use the touch ring to select “**MEDIA**” > “**RENAME**”, then touch the **ENTER** button.

“MEDIA RENAME” screen appears with a menu to select the types of files that can be renamed.



“USER SONG” ... User songs

“MIDI REC SONG” ... MIDI recorder songs

“AUDIO REC SONG” ... Audio recorder songs, general audio file

“REGIST BANK” ... Registration Bank

“ALL” ... All user data in the Digital Piano’s internal memory

3. Touch the top or bottom of the touch ring to select the type of file to rename, then touch the **ENTER** button.
4. Touch the top or bottom of the touch ring to select the file to rename.
5. Touch the **ENTER** button.  
The file name editing screen appears.
6. **Rename the file.**
  - For details of the procedure, see “[To change a character](#)” (page EN-35), “[To insert a character](#)” (page EN-36), and “[To delete a character](#)” (page EN-36).
7. **To confirm the file name, touch the ENTER button.**  
The confirmation screen displays “Sure?” or “Replace?”.  
“Sure?” ..... Appears when there are no files with the same name on the destination USB flash drive.  
“Replace?” ..... Confirms whether you want to overwrite a file with the same file name on the destination USB flash drive.
  - To exit the operation without renaming (or without overwriting a file with the same name), touch the left of the touch ring (NO).
8. **To rename (or to overwrite a file with the same name), touch the right of the touch ring (YES).**

“Wait...” appears during the process. Do not perform any action on the Digital Piano while this is happening. When the process is complete, “Complete” appears.



# Configuring MIDI Settings

To change the MIDI settings of the Digital Piano, use the setting items of the FUNCTION Menu (page EN-33) listed in the table below.

Setting Item	Setting Values and Descriptions
"MIDI" > "Keyboard Ch"	The keyboard channel is the MIDI channel that performance data of the Digital Piano is transmitted on to external devices. Set between 01 (default) and 16.
"MIDI" > "Local Control"	Using the Local Control setting, you can disconnect the Digital Piano's keyboard from the internal 'local' sound source so that MIDI data is only output to an external instrument. The initial default setting is "On". When set to "Off", the Digital Piano outputs performance data (MIDI data), but the Digital Piano itself does not produce any sound.
"MIDI" > "Hi-Reso MIDI Out"	Switches High Resolution Velocity MIDI Out on/off. Sets whether the key-on and key-off velocities are output as high-resolution MIDI output. <ul style="list-style-type: none"><li>• When set to on, high-resolution velocity information compatible with the high-resolution velocity MIDI standard is sent to the MIDI OUT port.</li><li>• When set to off, high-resolution velocity data is not sent to the MIDI OUT port. (Standard 127-step velocity data is sent to the MIDI OUT port.)</li><li>• Turning this setting on/off only affects the data sent to the MIDI OUT port. The Digital Piano's built-in sound source always uses high-resolution velocity data.</li></ul>

# Wireless Connections

The included Wireless MIDI & Audio Adaptor can be used to wirelessly connect the Digital Piano to external devices. This connection uses Bluetooth® wireless technology, and the following two types of connections are possible:

- Bluetooth Low Energy MIDI connection ... Transmits MIDI data between the Digital Piano and a smart device.\*
- Bluetooth audio connection ... The Digital Piano produces the sound for playback of audio from the external device.

\* This requires the dedicated app (page [EN-149](#)) to be installed.

## Configuring Wireless (Bluetooth) Connection Settings

### Checking the Wireless Connection Status

You can check the wireless connection status by referring to the indicator in the upper right corner of the top screen.



**M** ....Lights while connected to a Bluetooth Low Energy MIDI-compatible device.

**A** ....Lights while connected to a Bluetooth audio-compatible device.

### Enabling and Disabling the Digital Piano's Wireless Function

The wireless functionality of this Digital Piano is turned on under the initial default settings. The wireless functionality can be turned off when necessary, such as when you do not want the Digital Piano to send out a signal.

**1.** Select the “04 Listening” of the F button set. See “[To change the F Button Set](#)” (page [EN-32](#)).

- When the wireless functionality is on, the **F1** button (ADPTR) in the F button menu is surrounded by brackets [ ]. In addition, the indicator lights according to the status of the wireless connection. For more information, see “[Checking the Wireless Connection Status](#)” (page [EN-143](#)).



## 2. Touch the **F1** button (ADPTR).

The wireless functionality turns off.



- Touching the **F1** button (ADPTR) toggles the wireless functionality on and off.

## Notification Tones

A change in the Bluetooth connection causes a notification tone to sound.

This type of connection:	Sounds this notification tone:
Connection with a Bluetooth audio device	Rising piano tone melody
Disconnection from a Bluetooth audio device	Falling piano tone melody
Connection with a Bluetooth Low Energy MIDI device	Rising vibraphone tone melody
Disconnection from a Bluetooth Low Energy MIDI device	Falling vibraphone tone melody

### ■ To adjust the notification tone volume level

1. Select the “04 Listening” of the F button set. See “[To change the F Button Set](#)” (page [EN-32](#)).

2. Touch and hold the **F1** button (ADPTR).

The “WIRELESS” screen appears.

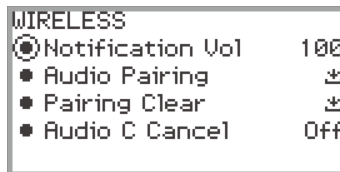

3. Trace the touch ring to change the “Notification Vol” setting value.

- The volume can be changed to a value between 0 and 127.

## Connecting the Digital Piano with a Bluetooth Low Energy MIDI Device

Connecting the Digital Piano and a smart device over a Bluetooth Low Energy MIDI connection enables various actions using the dedicated app. For details about the dedicated app, see “[About the App for Smart Devices \(CASIO MUSIC SPACE\)](#)” (page EN-149).

1. If the Digital Piano’s wireless functionality is turned off, turn it on.
  - For more information, see “[Enabling and Disabling the Digital Piano’s Wireless Function](#)” (page EN-143).
2. Plug the included Wireless MIDI & Audio Adaptor into the Digital Piano’s **USB Type A port**.

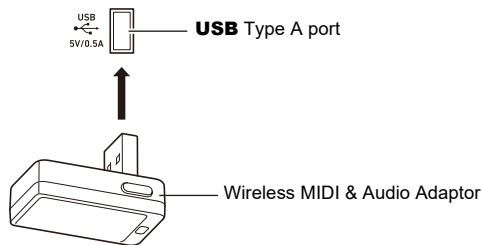

3. Open the settings screen of the smart device and turn on the **Bluetooth function** if it is off.
4. In the settings screen of the dedicated app installed on your smart device, select “**WU-BT10 MIDI**”.
  - Do not operate the Digital Piano while it is connecting to a smart device.
  - When connected, the **[M]** indicator appears in the upper right corner of the Digital Piano’s top screen and a notification tone sounds.

### **NOTE**

- The procedure in Step 4 above is necessary every time you use the dedicated app.
- When this Digital Piano and an external device are connected via Bluetooth Low Energy MIDI and Bluetooth audio simultaneously, MIDI functionality may become unstable depending on the type of connected device, its OS version, etc. If this occurs, terminate the Bluetooth audio connection using the external device.

## Connecting the Digital Piano with a Bluetooth Audio Device

Connecting this Digital Piano and an external device\* over Bluetooth audio allows playback from the external device over the Digital Piano's speakers. To connect via Bluetooth audio, you must first perform a procedure called "audio pairing" between the Digital Piano and the external device.

\* External devices include Bluetooth audio-compatible smart devices (e.g., iPhones, iPads, Android smartphones), iPods, MP3 players, etc.

### Pairing the Digital Piano with a Bluetooth Audio Device

1. Plug the included Wireless MIDI & Audio Adaptor into the Digital Piano's **USB Type A** port.

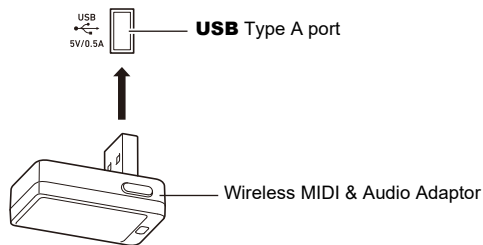

2. Open the settings screen of the external device and turn on the Bluetooth function if it is off.
3. Select the "04 Listening" of the F button set. See "[To change the F Button Set](#)" (page [EN-32](#)).
4. Touch and hold the **F1** button (ADPTR).  
The "WIRELESS" screen appears.

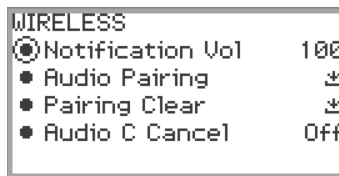

5. Use the touch ring to select "Audio Pairing" then touch the **ENTER** button.  
"Pairing..." appears on the display of the Digital Piano, and it waits for the connection to be established.
  - If the Digital Piano's wireless functionality is off, it will automatically turn on.

## 6. Select “WU-BT10 AUDIO” on the Bluetooth settings screen of the external device.

- When pairing is complete, the  indicator appears in the upper right corner of the Digital Piano's top screen and a notification tone sounds.

### NOTE

- Information regarding the external device connected over Bluetooth audio is registered in the Wireless MIDI & Audio Adaptor. After the first time, the Bluetooth audio connection will be established automatically without the above procedure.
- If the Bluetooth audio connection cannot be established, try the following:
  - (1) Perform the operation described in “[Deleting Bluetooth Audio Device Pairing Registration](#)” (page [EN-147](#)).
  - (2) If the pairing registration information with this Digital Piano remains on the external device, delete it.  
To do so, delete “WU-BT10 AUDIO” from the Bluetooth settings screen on the external device. For details on how to do this, see the instruction manual of the external device.
  - (3) Redo the procedure described in “[Pairing the Digital Piano with a Bluetooth Audio Device](#)” (page [EN-146](#)).

## Deleting Bluetooth Audio Device Pairing Registration

The following procedure will delete the pairing registration between this Digital Piano and the external device connected over the Bluetooth audio connection.

### NOTE

- After performing the procedure below, you should also delete the Digital Piano pairing registration information from external devices that have been connected to this Digital Piano via Bluetooth audio. To do this, delete “WU-BT10 AUDIO” from the Bluetooth settings screen of the external device. For details on how to do this, see the instruction manual of the external device.

- 1. Plug the included Wireless MIDI & Audio Adaptor into the **USB Type A** port.**
  - Bluetooth audio pairing registration information cannot be deleted unless connected.
- 2. Select the “04 Listening” of the F button set. See “[To change the F Button Set](#)” (page [EN-32](#)).**
- 3. Touch and hold the **F1** button (ADPTR).**  
The “WIRELESS” screen appears.
- 4. Use the touch ring to select “Pairing Clear”, then touch the **ENTER** button.**  
A confirmation screen appears. To cancel the operation, touch the left of the touch ring (NO).



- 5. To delete the pairing registration information, touch the right of the touch ring (YES).**

“Complete” appears, and the display returns to the “WIRELESS” screen.

# Using the Dedicated App

This section describes the “CASIO MUSIC SPACE” dedicated app, which provides additional ways to enjoy your Digital Piano.

## About the App for Smart Devices (CASIO MUSIC SPACE)

You can use the following functions on the Digital Piano when linked with the “CASIO MUSIC SPACE” dedicated app.

- Piano Roll
- Score Viewer
- Music Player
- Live Concert Simulator
- Piano Remote Controller
- Data Center

For details on each function, see the user’s manual of the dedicated app.

Follow the procedure below to use the dedicated app.

### 1. Install CASIO MUSIC SPACE on your smart device

- See the “Downloads” section of the website below.  
<https://support.casio.com/global/en/emi/manual/PX-S7000/>





## 2. Connect this Digital Piano to your smart device

The available features depends on the connection method.

Never connect the Digital Piano with a Bluetooth Low Energy MIDI device and a USB MIDI device at the same time.

Available features	Wireless connection		Cable connection
	Bluetooth Low Energy MIDI connection <sup>*2</sup>	Bluetooth audio connection <sup>*3</sup>	USB MIDI connection <sup>*4</sup>
Piano Roll <sup>*1</sup>	✓	—	✓
Score Viewer	✓ (when using the pedal to turn the page)	✓	✓ (when using the pedal to turn the page)
Music Player	—	✓	—
Live Concert Simulator	✓	✓	✓
Piano Remote Controller	✓	—	✓
Data Center	✓	—	✓

\*1 Use this function to transfer user songs (page [EN-100](#)) to the Digital Piano.

\*2 See “[Connecting the Digital Piano with a Bluetooth Low Energy MIDI Device](#)” (page [EN-145](#)).

\*3 See “[Connecting the Digital Piano with a Bluetooth Audio Device](#)” (page [EN-146](#)).

\*4 See “[Connecting the Digital Piano with a Smart Device via USB MIDI](#)” (page [EN-155](#)).

# Connecting with External Devices

This section describes the connection methods that can be used without using the dedicated app (page [EN-149](#)):

- Play sound from a smart device (Bluetooth audio connection)  
Audio playback from a smart device or other Bluetooth audio-compatible device is played through the Digital Piano's speakers.
- Connect to a computer or smart device and use MIDI  
MIDI data is transmitted between this Digital Piano and a computer or smart device.
- Output the sound of the Digital Piano to an amplifier or other audio equipment (**LINE OUT** jacks)  
Sound from the Digital Piano is played through external equipment via the **LINE OUT** jacks using cables.

## Playing Sound from a Smart Device on This Digital Piano (Bluetooth Audio Connection)

Connecting this Digital Piano and a smart device\* over Bluetooth audio allows playback from the smart device over the Digital Piano's speakers.

\* In addition to smart devices, many Bluetooth audio-compatible devices (iPods, MP3 players, etc.) can also be connected to this Digital Piano.

### Playing Audio from a Smart Device or Other Bluetooth-compatible Device on this Digital Piano

1. Perform audio pairing between this Digital Piano and a smart device (or other Bluetooth audio-compatible device).
  - See "[Pairing the Digital Piano with a Bluetooth Audio Device](#)" (page [EN-146](#)).
2. Play the song on the audio paired device.

### Adjusting the Volume Level or Effect Depth of Bluetooth Audio (MIXER Settings)

See "[Adjusting the Volume Level, Stereo Pan and Effects for Each Part](#)" (page [EN-60](#)).

- By changing the setting value of "MIXER" > "VOLUME" > "Wireless Audio", you can adjust the playback volume of audio data relative to the overall volume.
- By changing the setting value of "MIXER" > "HALL/REV." > "Wireless A Send", you can adjust the send value of the Hall Simulator/Reverb of the audio data.

## Bluetooth Audio Center Cancel (Vocal Cut)

Turning on Audio Center Cancel cuts (reduces or eliminates) vocals in the playback sound. Since this function cancels the central sound, it may also cut sounds other than vocals. Its effectiveness depends on the input sound.

### NOTE

- The Audio Center Cancel (page [EN-104](#)) when playing back audio data in SONG mode on this Digital Piano and the Center Cancel in this section differ in terms of settings.

### ■ To enable or disable Bluetooth audio center cancel

1. Select “04 Listening” from the F button set. See “[To change the F Button Set](#)” (page [EN-32](#)).
2. Touch and hold the **F1** button (ADPTR).  
The “WIRELESS” screen appears.
3. Touch the top or bottom of the touch ring to select “Audio C Cancel”.

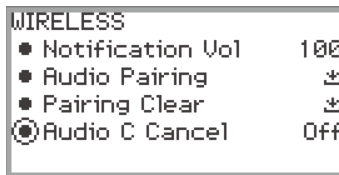

4. Trace the touch ring to toggle the setting value between “On” and “Off”.

## Using MIDI with a Connected Computer or Smart Device

You can send and receive performance information (MIDI data) by connecting the Digital Piano to a computer or smart device. You can use music software on your computer or a smart device app to record your performance, or to send MIDI data from your computer or a smart device to the Digital Piano and play notes on the Digital Piano.

### NOTE

- For detailed MIDI specifications relating to this Digital Piano and the latest support information, visit the CASIO website below.  
<https://support.casio.com/global/en/emi/manual/PX-S7000/>



- For MIDI-related settings, see “Configuring MIDI Settings” (page EN-142).

## Connecting the Digital Piano with a Computer via USB MIDI

### ■ Minimum Computer System Requirements

The minimum computer system requirements for sending and receiving MIDI data are shown below. Check to make sure that your computer complies with these requirements before connecting the Digital Piano to it.

- USB port
- Operating System
  - Windows 8.1\*<sup>1</sup>
  - Windows 10\*<sup>2</sup>
  - Windows 11
  - macOS 10.13, 10.14, 10.15, 11, 12

\*1 Windows 8.1 (32-bit, 64-bit)

\*2 Windows 10 (32-bit, 64-bit)

### NOTE

- For the latest OS support information, please see the “Operating System Compatibility (Windows/macOS)” section on our website below.  
<https://support.casio.com/global/en/emi/manual/PX-S7000/>



## ■ To connect the Digital Piano with your computer

### IMPORTANT!





- Make sure you follow the steps of the procedure below exactly. Connecting incorrectly can make data send and receive impossible.
- Be sure to turn on the Digital Piano first before starting up your computer's music software.
- USB send and receive is disabled during playback of a song.

### 1. Turn off the Digital Piano and start up the computer.

- Do not start any music software yet on your computer.

### 2. Connect the **USB Type B** port of the Digital Piano to your computer using a commercially available USB cable.

- Use a USB 2.0 or 1.1 A-B connector type cable.

Computer port	Connection cable	Digital Piano port
USB Type A 		USB Type B  

### 3. Turn on the Digital Piano.

- When connecting for the first time, the driver required to send and receive data is automatically installed on the computer.

### 4. Start the (commercially available) music software on your computer.

### 5. Select "CASIO USB-MIDI" as the MIDI device in the settings of your computer's music software.

- Refer to the user manual of the music software for information on how to select a MIDI device.

### NOTE

- After one successful connection, the USB cable can be left connected and the computer or the Digital Piano can be turned on again.

## Connecting the Digital Piano with a Smart Device via USB MIDI

### Smart Device Operating Environment

You can use MIDI standard apps when the Digital Piano is connected with a smart device.

For a list of devices that can be used, please see the “Operating System Compatibility (iOS/Android)” section on the CASIO website below.

<https://support.casio.com/global/en/emi/manual/PX-S7000/>









- We recommend using devices listed in the “Tested devices (USB-MIDI connection)” section.
- Please note that listed devices are not guaranteed to work with all MIDI apps running on the device.
- Depending on the operating environment, it may not be possible to connect correctly.
- Even if the device has been tested, it may not work properly due to device or OS version upgrades, etc.

### To connect the Digital Piano with your smart device

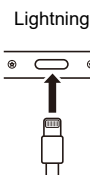



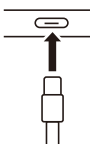

- Be sure to use a USB cable that supports data transfer.
- A USB cable exclusively for charging cannot be used for data transfer.

1. Turn on the Digital Piano and the smart device.
2. Connect the smart device to the **USB Type B** port of the Digital Piano using a connection cable.

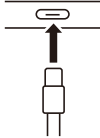
#### iPhone/iPad users

Device port	Connection cable	Digital Piano port
 <p>Lightning</p>	 <p>Apple Lightning - USB camera adaptor</p> <p>USB cable (A-B type)</p>	 <p>USB Type B</p>  <p>USB</p>
 <p>USB Type C</p>	 <p>Apple USB Type C - USB adaptor</p> <p>USB cable (A-B type)</p>	

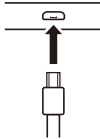
**Android users**

Device port	Connection cable	Digital Piano port
<p>USB Type C</p> 	 <p>USB cable (C-B type)</p> <p>or</p>  <p>USB Type C - USB adaptor      USB cable (A-B type)</p>	<p>USB Type B</p> 
<p>USB Micro-B</p> 	 <p>USB OTG cable (micro B-A type)      USB cable (A-B type)</p>	

**3. Launch the MIDI-compatible app on your smart device.**

- If you are using CASIO's dedicated app, the smart device screen will display "Connecting...". When a successful connection is made, the message "Connected" will be displayed.

## Outputting Digital Piano Notes Through an Amplifier or Audio Equipment (LINE OUT jacks)

You can connect audio equipment or a music amplifier to the Digital Piano and then play through external speakers for more powerful volume and better sound quality. Use commercially available cable for connection.

### ! IMPORTANT!

- Turn off the external device when making connections. After connecting, turn down the Digital Piano and external device volume levels to their minimum whenever turning power on or off.
- After connecting, turn on the Digital Piano and then the external device.
- If keyboard notes are distorted when they are sounded from external audio equipment, lower the Digital Piano's volume setting.

### Connecting to Audio Equipment

**LINE OUT R** jack output is right channel sound, while **LINE OUT L/MONO** jack output is left channel sound. Use commercially available cables to connect the external audio equipment to the Digital Piano's **LINE OUT** jacks as shown in the figure below. Normally in this configuration you must set the audio equipment's input selector to the setting that specifies the terminal (such as AUX IN) to which the Digital Piano is connected.

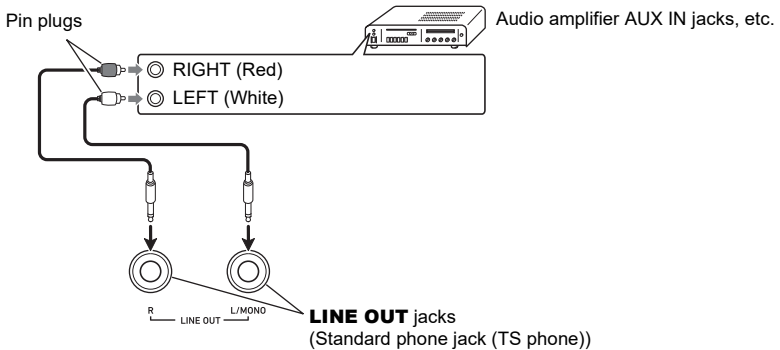



## Connecting to a Musical Instrument Amplifier

Connecting to the **LINE OUT L/MONO** jack only outputs a mixture of both channels. Use commercially available cable to connect the amplifier to the Digital Piano's **LINE OUT L/MONO** jack as shown in the figure below.

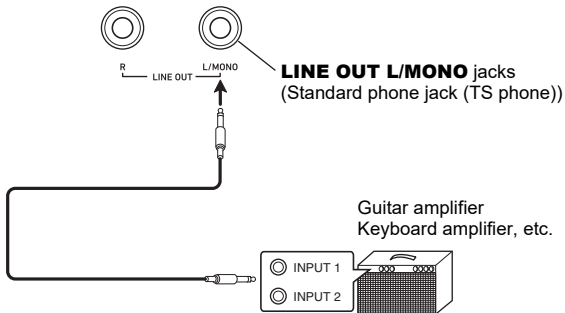

# Deleting All Data in the Digital Piano's Internal Memory

All system contents, including data and settings, can be reset to their initial factory defaults.

## ■ To return all Digital Piano settings and data to their initial factory defaults (Factory Reset)

### ⚠ IMPORTANT!

- Performing the following will also delete user songs, MIDI recorder songs, audio recorder songs recorded to the internal memory, registration data and user F button sets. We recommend saving important data on a USB flash drive (page [EN-137](#)).

1. Touch the **FUNCTION** button to display the **FUNCTION** menu.
2. Using the touch ring, select “SYSTEM” > “Factory Reset”.

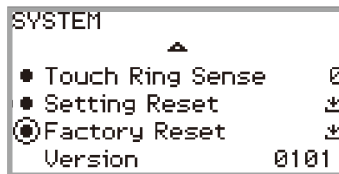

3. Touch the **ENTER** button.

A confirmation screen will appear. To cancel the operation, touch the left of the touch ring (NO).



4. To restore the Digital Piano to its initial factory defaults, touch the right of the touch ring (YES).

This restarts the Digital Piano, and then the display returns to the top screen.

## ■ To return all Digital Piano settings to their initial factory defaults (Setting Reset)

This function allows you to restore all settings of the Digital Piano to the initial factory defaults. This operation resets only the settings and does not delete user songs, MIDI recorder songs, audio recorder songs recorded to the internal memory or registration data.

In step 2 of “[To return all Digital Piano settings and data to their initial factory defaults \(Factory Reset\)](#)” (page [EN-159](#)), select “Setting Reset” instead of “Factory Reset”.

# Troubleshooting

## ● The touch button does not respond.

- Reason:**
- The buttons were touched with a fingernail or stylus.  
The button was touched by a user wearing a glove that is not suitable for use with touch buttons.
  - The sensitivity of the touch buttons is set too low.

- Solution:**
- Touch the buttons firmly with bare fingers.
  - Change the sensitivity setting of the touch buttons. See “[Setting the Sensitivity of the Touch Buttons and Touch Ring](#)” (page EN-26).

## ● No sound is produced when the keyboard keys are pressed.

- Reason:**
- The volume has been turned down with the volume knob.
  - Headphones are connected. A headphone conversion plug has been left in the **PHONES** jack.
  - “Speaker Out” (page EN-20) is set to “Off”.
  - Local control setting is off.
  - The position of the expression pedal connected to the Digital Piano is at the position where it stops when depressed toward the heel (the minimum value).

- Solution:**
- Turn the volume knob.
  - Unplug the headphones or conversion plug from the **PHONES** jack.
  - Set “Speaker Out” to “Auto” or “On”.
  - Turn on the Local Control (page EN-142) setting.
  - If the “Expression” or “Master Vol” function is assigned to the expression pedal, sound will not be produced when the pedal is in the minimum value heel position. Press the pedal down toward the toe to increase the volume.

## ● The pitch sounds wrong.

- Reason:**
- The keyboard transpose setting has been changed from its initial value.
  - The master tuning setting is set to a frequency other than 440.0 Hz.
  - Octave Shift is enabled.
  - The Scale Tuning is set to something other than equal temperament.
  - The pitch bend wheel is not centered.

- Solution:**
- Reset transpose (page EN-124) to its initial value or turn the power off and then on again.
  - Set tuning (page EN-124) to 440.0 Hz. Or turn the power off and then on again.
  - Set octave shift (page EN-126) to “0”.
  - Set the Scale Tuning (page EN-127) to “equal temperament”.
  - Make sure nothing is touching the pitch bend wheel.

---

**● The pedal has no effect.**

- Reason:**
- The pedal cable is not properly plugged into the **PEDAL UNIT** or **EXPRESSION/ASSIGNABLE** jack. Or the plug is incompletely plugged in.
  - The pedal type assignment or function assignment to the jack to which the pedal is connected is incorrect.

- Solution:**
- Check that the pedal cable is properly connected and that the plug is firmly inserted into the jack.
  - Change to the correct settings. See “[EXPRESSION/ASSIGNABLE jack](#)” (page [EN-63](#)).
- 

**● The sound does not become louder or softer depending on how I play (touch).**

- Reason:** “Touch Response” (page [EN-122](#)) is set to “Off”.

- Solution:** Set “Touch Response” to a setting other than “Off”.
- 

**● The sound tone, effects, etc. do not change even after turning the power off and then back on (the Digital Piano does not return to its initial default settings).**

- Reason:** “Auto Resume” (page [EN-17](#)) is set to “On”.

- Solution:** Turn “Auto Resume” to “Off” and turn the power off and then back on.
- 

**● When connected to a computer, MIDI cannot be sent or received.**

- Solution:**
- Check that the Digital Piano is properly connected to the computer with a USB cable and that the Digital Piano is correctly selected in the settings of the computer’s music software.
  - Try turning off the Digital Piano and closing the music software on the computer, then turn on the Digital Piano and restart the music software on the computer.
- 

**● Some tones are the same but have slightly different sound quality and volume depending on the keyboard position.**

- Reason:** This is not a malfunction, but a result of an electronic process called digital sampling\*.
- \* A process whereby several tone registers (low, mid, high, etc.) of the original instrument are recorded to capture the sound quality in each of the original instrument sound registers. The samples are then processed to create a single tone.
- 

**● When the buttons are pressed, the sound that is being played is temporarily interrupted or the sound quality becomes slightly different.**

- Reason:** When using the Layer function, Duet function, song playback, or recording function, multiple parts sound at the same time. Pressing the buttons in such cases will automatically change the internal effect settings specific to the tone and may cause this phenomenon to occur in some parts, but it is not a malfunction.
-

## Error Messages

Display	Cause	Action
Limit	Recording of 1,000 measures or over was attempted with the MIDI recorder.	Use the MIDI recorder to record up to bar 999.
	The recording time limit was reached with the audio recorder.	Use the audio recorder to record up to approximately 18 minutes* <sup>1</sup> (when using the internal memory) or 25 minutes (when using a USB flash drive).
Memory Full	The per-song capacity (320KB) of the MIDI recorder was reached.	Record within the per-song capacity.
Data Full	The five-song limit was reached with the MIDI recorder.	Delete a song (page <a href="#">EN-113</a> ).
No Media	The USB flash drive is not properly plugged into the <b>USB</b> Type A port on the Digital Piano.	Plug the USB flash drive correctly into the <b>USB</b> Type A port.
	The USB flash drive was removed or inserted during the operation.	Do not touch the USB flash drive during operation of the Digital Piano.
	The USB flash drive is protected.	Unprotect the USB flash drive.
	The USB flash drive contains antivirus software.	Use a USB flash drive that does not contain antivirus software.
No File	There are no loadable/playable files in the "MUSICDAT" folder.	Move the file you want to load or play to the "MUSICDAT" folder (page <a href="#">EN-137</a> ).
No Data	An attempt was made to save a song number to the USB flash drive for which there was no recorded data.	Select a song number that has already been recorded.
Read Only	An attempt was made to save different data with the same name as a read-only file on the USB flash drive.	<ul style="list-style-type: none"> <li>• Change the name to something else and save it.</li> <li>• Remove the read-only attribute from the file on the USB flash drive and overwrite the file.</li> <li>• Use a different USB flash drive.</li> </ul>
Not Enough Memory	If this error is displayed when recording or saving to the internal memory, there is not enough free space in the internal memory.	Erase the data in the internal memory to increase the free space.
	If this error appears when recording or saving to a USB flash drive, there is not enough free space on the USB flash drive.	Either delete the files stored on the USB flash drive to free up more space or use a different USB flash drive.

Display	Cause	Action
Too Many Files	<p>When recording with the audio recorder, an attempt was made to start recording beyond the maximum number of songs (99), or the following conditions were present.</p> <ul style="list-style-type: none"> <li>• <u>When recording to a USB flash drive:</u> In the "MUSICDAT" folder of the USB flash drive, there is a file called TAKE99.WAV.</li> <li>• <u>When recording to the internal memory:</u> "TAKE99" is marked with an asterisk (*) and there is already recorded data in TAKE99.</li> </ul>	<p><u>When recording to a USB flash drive:</u> Use a computer to delete all or some of TAKE01.WAV to TAKE99.WAV in the "MUSICDAT" folder or move them to another folder or drive. When deleting or moving only some files, give priority to files with higher numbers*<sup>2</sup>.</p> <p><u>When recording to the internal memory:</u> Delete some or all of TAKE01 to TAKE99 in the internal memory. When deleting only some data, give priority to files with higher numbers*<sup>2</sup>.</p>
Not SMF 0/1	An attempt was made to read or play a file in SMF format 2.	The SMF format that can be read and played back by the Digital Piano is "0" or "1".
Large Size	The size of the SMF file on the USB flash drive is too large to play on this Digital Piano.	The Digital Piano can play back SMF files up to a maximum size of approximately 320 KB.
Wrong Data	Data on the USB flash drive is corrupted.	—
Version	The version of the file on the USB flash drive is not the version supported by this Digital Piano.	Use a version of the file that is supported by the Digital Piano.
Format	The format of the USB flash drive is not compatible with this Digital Piano.	Use a computer or other device to change the USB flash drive to a format compatible with this Digital Piano (page <a href="#">EN-136</a> ). Use another USB flash drive.
	The USB flash drive is corrupted.	Use another USB flash drive.
No Wireless Adptr	The Wireless MIDI & Audio Adaptor is not plugged into the <b>USB</b> Type A port.	Plug the Wireless MIDI & Audio Adaptor into the <b>USB</b> Type A port.

\*1 The total recording time when using the internal memory is approximately 18 minutes for all files in the internal memory. If a file has already been recorded to the internal memory, the amount of time that can be recorded to the internal memory is reduced by that amount.

\*2 Audio recorder songs are saved with the name "TAKE\*\*" (\*\* is 01 to 99). Whenever recording, data is automatically created by adding 1 to the highest number of \*\* in the USB flash drive or internal memory. Therefore, if "TAKE99" in the SONG mode screen is marked with "\*" (data of "TAKE99" exists), recording will not be able to start.

## Product Specifications

<b>Model</b>	PX-S7000BK/PX-S7000WE/PX-S7000HM
<b>Keyboard</b>	88-key piano keyboard
Settings	Hammer Response, Key Off Response
Duet	Adjustable tone range (-2 to +2 octaves)
Transpose	-12 to 0 to +12 semitones
Octave Shift	-2 to 0 to +2 octaves
<b>Sound Source</b>	
Number of Tones	400, Layer, Split
Maximum Polyphony	256 notes
Touch Response	5 sensitivity levels, Off
Tuning	415.5Hz to 440.0Hz to 465.9Hz (0.1Hz units)
Temperament	Equal temperament plus 16 other types
<b>Piano Position</b>	4 types
<b>Acoustic Simulator</b>	Key Off Simulator, String Resonance, Damper Resonance, Open String Resonance, Aliquot Resonance, Damper Noise, Key On Action Noise, Key Off Action Noise
<b>Sound Mode</b>	Hall simulator (8 types), Reverb (8 types), Surround (3 types)
<b>Effects</b>	Chorus (12 types), Brilliance (-12 to 0 to +12)
<b>Microphone Effect</b>	25 types, editable effect parameter settings
<b>Mixer</b>	Volume, Pan, Hall Simulator/Reverb Send, Hall Simulator/Reverb Return, Chorus Send
<b>Demo Song</b>	3
<b>Playback Function (SONG Mode)</b>	
In the MIDI Mode	Playable songs: User song* <sup>1</sup> (SMF* <sup>2</sup> , CMF* <sup>3</sup> ), MIDI recorder song (MRF* <sup>4</sup> ), song data stored on USB flash drive (SMF* <sup>2</sup> , CMF* <sup>3</sup> ) Playback parts: L+R, L, R (playback of both tracks at the same time or each track independently)
In the Audio Mode	Playable songs: audio recorder song (WAV* <sup>5</sup> ), general audio file (WAV* <sup>5</sup> , MP3* <sup>6</sup> ) Playback functions: Center cancel
Song Volume	Adjustable (MIDI Mode and Audio Mode individually)
<b>MIDI Recorder</b>	Real-time recording and playback as MIDI data
Number of Songs	5
File Format	MRF* <sup>4</sup>
Number of Tracks	2
Capacity	Approximately 30,000 notes per song (total of two tracks)
Recording Medium	Internal memory (built-in flash memory)

<b>Audio Recorder</b>	Real-time recording and playback as audio data
Number of Songs	99 (files)
File Format	WAV*5
Maximum Recording Time	When recording to USB flash drive: Approximately 25 minutes per file When recording to the internal memory: Approximately 18 minutes (total of all songs)
Recording Medium	Internal memory (built-in flash memory) or USB flash drive
<b>Arpeggiator</b>	50 types
<b>Metronome</b>	
Beat Bell	Off, 1 to 9 (beats)
Drum Patterns	20 types
Tempo Range	20 to 255
Tempo Markings	9 types
Metronome Volume Level	Adjustable
<b>Registration Function</b>	96 sets maximum (4 sets, 24 banks)
<b>Pedals</b>	
PEDAL UNIT jack	For connection of the included pedal unit or a separately available pedal unit Damper (continuously variable), sostenuto (off, on), soft (the included pedal unit: off, half, on ; a separately available pedal unit: off, on)
EXPRESSION/ ASSIGNABLE jack	For connection of a commercially available expression pedal or a separately available CASIO sustain pedal, selectable function (expression, master volume, tempo, layer balance, damper (off, on), sostenuto (off, on), soft (off, on), arpeggio hold (off, on), play/stop, sequential recall of setup registrations)
<b>Other Functions</b>	Auto Resume, Operation Lock
<b>MIDI</b>	MIDI 16-channel multi-timbre receive; GM Level 1 standard
<b>Pitch Bend Wheel</b>	Pitch bend range: 0 to 24 semitones
<b>EX Buttons</b>	2 (function-assignable buttons)
<b>CONTROL Button</b>	1 (function-assignable button)
<b>Inputs/Outputs</b>	
PHONES jack	Stereo standard phone jack (TRS phone) × 1, Stereo mini phone jack (Mini TRS phone) × 1
Power	24V DC
LINE OUT R, L/MONO jacks	Standard phone jack (TS phone) × 2 (Output impedance: 470 Ω, Output voltage: 1.7 V (RMS) MAX)
MIC IN jack	Standard phone jack (TS phone) (Input impedance: 3 kΩ, Input voltage: 10 mV)
USB Ports	Type A, Type B
EXPRESSION/ ASSIGNABLE jack	Stereo standard phone jack (TRS phone)
PEDAL UNIT jack	Proprietary jack



<b>Acoustics</b>	
Amp output	8 W × 2 + 8 W × 2 (3 W × 2 + 3 W × 2 under battery power)
Speakers	16 cm × 8 cm (oval) × 2 + 16 cm × 8 cm (oval) × 2
<b>Power Supply</b>	2-way
Batteries	8 AA-size alkaline batteries or AA-size rechargeable nickel metal hydride batteries
Battery Continuous Operation	Approximately 4 hours (alkaline batteries), approximately 4 hours (rechargeable nickel metal hydride batteries)*7 Actual continuous operation time may be shorter due to battery type and performance type.
AC Adaptor	AD-E24250LW
Auto Power Off	Approximately four hours (under AC adaptor power) or six minutes (under battery power) after last operation, can be disabled.
<b>Power Consumption</b>	24V --- 20W
<b>Dimensions</b>	Piano, Stand and Music Stand: 134.0 (W) × 44.9 (D) × 90.3 (H) cm (52 3/4 × 17 11/16 × 35 9/16 inch)
<b>Weight</b>	Piano, Stand and Music Stand: Approximately 29.1 kg (64.2 lbs) (Excluding batteries)
<b>Pedal cord</b>	70 cm (27 9/16 inch)

\*1 Storage of up to 10 songs in the internal memory, up to approximately 320KB per song (Based on 1KB = 1024 bytes, 1MB = 1024<sup>2</sup> bytes)

\*2 Standard MIDI file (SMF format 0/1, file name extension: .MID)

\*3 CASIO original file format. This file format adds CASIO proprietary data to MIDI data. (file name extension: .CMF)

\*4 MIDI Recorder song file (file name extension: .MRF)

\*5 WAV format audio file (Linear PCM, 16-bit, 44.1kHz, stereo, file name extension: .WAV)

\*6 MP3 format audio file (MPEG-1 Audio Layer3, 44.1kHz/48kHz, 32-320kbps variable bit rate (VBR), monaural/stereo, file name extension: .MP3)

\*7 Measured values while using eneloop batteries.  
eneloop is a registered trademark of Panasonic Group.

• Specifications and designs are subject to change without notice.

## Operating Precautions

### ■ Environment

- Place the Digital Piano onto a stable and flat surface. If you want to place the Digital Piano on a table or other surface instead of the supplied stand, place it on a stable and flat surface where the entire bottom of the Digital Piano fits within that surface.
- To prevent the formation of mold, set up the product in a well-ventilated location where the temperature and humidity ranges shown below are maintained.
  - Recommended temperature range: 15 to 25°C
  - Recommended humidity range: 40 to 60% RH
- Do not set up the product in locations subject to extreme variations in temperature and/or humidity. Doing so can cause metal components to rust, coatings to degrade, and components to warp and split.

### ■ User Maintenance

- Wipe the product with a soft, dry cloth. Do not use a tissue, which can cause scratching.
- When soiling is more serious, moisten a soft cloth with a weak solution of water and a mild neutral detergent, wring out all excess moisture from the cloth, and then wipe the product. After that, wipe again with a separate soft dry cloth.
- Do not use any cleaning agents, chlorine disinfectants, sanitizing wipes, or other items that include benzene, organic solvents, alcohol, or other solvents for cleaning. Doing so can cause discoloration, deformation, paint peeling, cracking, etc.

### ■ Sterilization and Disinfection

- After wiping the product two or three times with a non-alcohol sanitizing wipe, use a soft, dry cloth to wipe it dry.
- Note that failure to wipe the product dry can cause streaks to remain.
- If the product is used by multiple parties, hand disinfection before each use is recommended.

### ■ Included and Optional Accessories

Use only accessories that are specified for use with this product. Use of unauthorized accessories creates the risk of fire, electric shock, and personal injury.

### ■ Weld Lines

Lines may be visible on the exterior of the product. These are “weld lines” that result from the plastic molding process. They are not cracks or scratches.

### ■ AC Adaptor Handling Precautions

- Never connect the AC adaptor (JEITA Standard, with unified polarity plug) that is specified with this Digital Piano to any other device besides this Digital Piano. Doing so creates the risk of malfunction.
- The AC adaptor cannot be repaired. If your AC adaptor malfunctions or becomes damaged, contact your original retailer or a CASIO Service Center.
- AC adaptor operating environment: Temperature: 0 to 40°C  
Humidity: 10% to 90% RH
- Output polarity: 
- Use of a different type AC adaptor can cause smoking or malfunction.

## ■ Using Batteries



- **Close the battery case lid before using the Digital Piano. Failing to do so may cause injury.**
- **Note that the rear of the Digital Piano around the battery compartment may become hot in use.**

## ■ Rechargeable Batteries

Note the precautions below when using rechargeable batteries.

(Models that support use of rechargeable batteries only)

- Use Panasonic Group AA-size eneloop rechargeable batteries.  
Do not use any other type of batteries.
- Use only the specified charger to charge batteries.
- Rechargeable batteries must be removed from the product for charging.
- For information about using eneloop batteries or their specified charger, be sure to read the user documentation and precautions that come with each item, and use them only as directed.

Be sure to replace batteries at least once a year, even if there is no indication of low battery power.

Dead rechargeable batteries (eneloop) in particular may deteriorate if they are left in the product.

Remove rechargeable batteries from the product as soon as possible after they go dead.

## ■ About the front panel

Operating the front panel when it is dusty or dirty may scratch it.

Gently wipe the panel with a soft, clean cloth to remove dust and dirt before use.

Use your fingers to operate the front panel. Using fingernails or sharp objects may scratch the surface.

## ■ About the supplied piano cover

Due to the nature of the material, threads may be mixed on the surface of the cover, but this does not indicate any issue with quality or function.

## FUNCTION Menu Items

Listed below are all FUNCTION menu item names and setting values and references in this manual. Some menu items can be called up directly at the touch of a button. The following information is provided in the "Reference" column of the table below, in the following manner.

- Items below that start with "◆" indicate a button operation.
- Names enclosed in brackets [ ], such as "[WHEEL]", are the display name of the F button (page EN-88).
- "FUNCTION + F1" indicates "while touching the **FUNCTION** button, touch the **F1** button".

While touching the **FUNCTION** button, touch either up, down, left, or right of the touch ring to recall the initial value of each menu item.

Menu Item	Setting Values	Reference
<b>SOUND</b>		"Applying Effects" (page EN-49)
<b>ACOUSTIC SIM.</b>		"Adjusting Acoustic Piano Sound Characteristics (Acoustic Simulator)" (page EN-54) (◆[ACSIM])
String Reso.	Tone, Off, 1 - 10	"List of Acoustic Piano Sound Setting Items" (page EN-55)
Damper Reso.		
Open String Reso.		
Aliquot Reso.		
Damper Noise		
Key On Noise		
Key Off Noise		
<b>EFFECT</b>		(◆[EFFECT])
Chorus Type	Tone, other options*1	"Using Chorus (Chorus, Flanger, Short Delay)" (page EN-52)
Brilliance	-12 - 0 - +12	"Adjusting Brilliance" (page EN-53)
<b>SOUND MODE</b>		"Using the Sound Mode Effects (Hall Simulator/Reverb and Surround)" (page EN-49) (◆Touch and hold [SMODE])
Sound Mode	Off, Hall/Rev., Surround, Hall/Rev. + Srnd	"Enabling or Disabling the Hall Simulator/Reverb and Surround Effects" (page EN-49) (◆[SMODE])
Hall/Rev. Type	Options*1	"Specifying the Hall Simulator/Reverb Type" (page EN-50)
Surund Type	Type 1 - Type 3	"Specifying the Surround Type" (page EN-51)
<b>PIANO POSITION</b>		(◆[PPOS])
Piano Position	Standard, Wall, Center, Table	"Selecting the Piano Position Setting" (page EN-38)

Menu Item	Setting Values	Reference
<b>MIC FX</b>		(◆Touch and hold [MICFX])
Mic Fx Type	Options*2	"Specifying the Microphone Effect Type" (page EN-57)
Fx On/Off	On, Off	"Changing Microphone Effect Settings" (page EN-58)
M1 – M3	Options*3	
<b>PORTAMENTO</b>		—
Portamento Time	0 - 127*4	"Specifying the Portamento Time" (page EN-71)
<b>MIXER</b>		"Using the Mixer" (page EN-60) (◆[MIXER])
<b>VOLUME</b>		"Adjusting the Volume Level, Stereo Pan and Effects for Each Part" (page EN-60)
KB Group	0 - 127	"List of Mixer Setting Items" (page EN-61)
U1 Part		
U2 Part		
L Part		
Audio Song		
Wireless Audio		
Mic In		
MIDI Song		
<b>PAN</b>		"Adjusting the Volume Level, Stereo Pan and Effects for Each Part" (page EN-60)
U1 Part	-64 - 0 - +63	"List of Mixer Setting Items" (page EN-61)
U2 Part		
L Part		
Mic In		
<b>HALL/REV.</b>		"Adjusting the Volume Level, Stereo Pan and Effects for Each Part" (page EN-60)
Hall/Rev. Return	0 - 127	"List of Mixer Setting Items" (page EN-61)
U1 Part Send		
U2 Part Send		
L Part Send		
AudioSongSend	0 - 127	
Wireless A Send		
Mic In Send		

Menu Item	Setting Values	Reference
<b>CHORUS</b>		"Adjusting the Volume Level, Stereo Pan and Effects for Each Part" (page EN-60)
U1 Part Send	0 - 127	"List of Mixer Setting Items" (page EN-61)
U2 Part Send		
L Part Send		
<b>KEYBOARD</b>		(◆[KEYBD])
<b>TRANSPOSE</b>		—
Transpose	-12 - 0 - +12	"Changing the Pitch in Semitone Steps (Transpose)" (page EN-124) (◆[TRANS])
<b>KBD SETTING</b>		—
Touch Response	Off, Light 2, Light 1, Normal, Heavy 1, Heavy 2	"Changing Touch Response Sensitivity" (page EN-121)
Hammer Response	Tone, Off, 1 - 10	"Adjusting the Hammer Response" (page EN-122)
KeyOff Response	Tone, 1 - 3	"Adjusting the Key-off Response" (page EN-123)
<b>PART OCT SHIFT</b>		—
Upper1 Part	-2 - 0 - +2	"Using Octave Shift Separately for Each Part (Upper 1/Upper 2/Lower)" (page EN-126)
Upper2 Part		
Lower Part		
<b>PART FINE TUNE</b>		—
Upper1 Part	-99 - 0 - +99	"Adjusting the Tuning Separately for Each Part (Upper 1/Upper 2/Lower) (Part Fine Tune)" (page EN-125)
Upper2 Part		
Lower Part		
<b>SCALE TUNING</b>		"Changing the Scale Tuning (Temperament) of the Keyboard" (page EN-127)
Scale Type	Options*1	"Changing the Scale" (page EN-127)
Scale Base Note	C, C#, ... , Bb, B	
Stretch Tuning	Off, On	"Enabling or Disabling Piano Stretch Tuning" (page EN-128)
<b>SPLIT POINT</b>		"Changing the Split Point" (page EN-47)
Split Point	A0 - C8	(◆Touch and hold [SPLIT])

Menu Item	Setting Values	Reference
<b>PEDAL/WHEEL</b>		“Changing the Sound During a Performance” (page EN-62)
<b>EXP/ASGN. PEDAL</b>		“EXPRESSION/ASSIGNABLE jack” (page EN-63) (◆[PEDAL])
Pedal Type	SW, Exp.Type1, Exp.Type2	“To specify the pedal type” (page EN-63)
Pedal Target	Options*1	“To specify the pedal function” (page EN-64)
Upper1 Part	Off, On	“Enabling/Disabling the Pedal Operation for Each Part (Upper 1/Upper 2/Lower)” (page EN-66)
Upper2 Part		
Lower Part		
Exp Calibration	—	“Expression Pedal Calibration” (page EN-65)
<b>PEDAL UNIT</b>		“PEDAL UNIT jack” (page EN-62)
Upper1 Part	Off, On	“Enabling/Disabling the Pedal Operation for Each Part (Upper 1/Upper 2/Lower)” (page EN-66)
Upper2 Part		
Lower Part		
<b>WHEEL</b>		“Using the Pitch Bend Wheel” (page EN-72) (◆[WHEEL])
P Bend Range	0 - 24	“Changing the Pitch Bend Range” (page EN-72)
Upper1 Part	Off, On	“Enabling/Disabling the Pitch Bend Wheel Operation for Each Part (Upper 1/Upper 2/Lower)” (page EN-73)
Upper2 Part		
Lower Part		
Wheel Illum	Cool, Colorful, Active	“Changing the Pitch Bend Wheel Illumination Settings” (page EN-73)
Up/Down Color	Off, On	
<b>EX</b>		“Selecting the Functions Assigned to the EX Buttons” (page EN-67) (◆[EX])
EX1 Assign	Options*1	(◆FUNCTION + EX1)
EX2 Assign		(◆FUNCTION + EX2)

Menu Item	Setting Values	Reference	
<b>CONTROL</b>		"Selecting the Function Assigned to the CONTROL Button" (page EN-69) (◆[CTRL])	
Control Assign	Options* <sup>1</sup>	"Selecting the Function Assigned to the CONTROL Button" (page EN-69) (◆FUNCTION + CONTROL)	
Mod Value	0 - 127		
Mod Upper1 Part	Off, On	"To change the Modulation settings" (page EN-71)	
Mod Upper2 Part			
Mod Lower Part			
<b>F BUTTON SETTING</b>		"Editing an F Button Set" (page EN-89)	
<b>FB SET NAME EDIT</b>		"Changing the Name of an F Button Set" (page EN-94)	
<b>F BUTTON EDIT</b>			
F1 {function}	Options* <sup>1</sup>	(◆FUNCTION + F1)	"Assigning a Function to an F Button (Creating a User F Button Set)" (page EN-89)
F2 {function}		(◆FUNCTION + F2)	
F3 {function}		(◆FUNCTION + F3)	
F4 {function}		(◆FUNCTION + F4)	
<b>FB SET CLEAR</b>		"Erasing an F Button Set" (page EN-96)	
<b>DUET</b>		"Splitting the Keyboard for Duet Play" (page EN-129) (◆Touch and hold [DUET])	
Duet Mode	Duet On, Duet Pan		
Upper Octave	-2 - 0 - +2	"Configuring Duet Settings" (page EN-131)	
Lower Octave			
<b>ARPEGGIATOR</b>		—	
Pattern	Options* <sup>1</sup>		
Recommended Setup	Off, On		
Arpeggio Hold	Off, On	"Changing the Arpeggiator Pattern and Other Settings" (page EN-77) (◆Touch and hold [ARPEG])	
Upper1 Part	Off, On		
Upper2 Part	Off, On		
Lower Part	Off, On		



Menu Item	Setting Values	Reference
<b>REGISTRATION</b>		"Saving and Recalling Performance Setups (Registration)" (page EN-79)
<b>FREEZE</b>		"Freeze Function" (page EN-83) (◆Touch and hold [FREEZ])
Pedal/Wheel	Off, On	"Registration Memory Data" (page EN-86)
EX/CTRL		
Scale Tuning		
Touch Response		
Sound Mode		
Effect		
Transpose		
Split Point		
Arpeggiator		
Tempo		
Tone		
Mixer		
<b>BANK NAME EDIT</b>		"Changing a Registration Bank Name" (page EN-81)
<b>SONG</b>		"Listening to Songs (SONG Mode)" (page EN-100)
Song Type	MIDI, Audio (USB Drv), Audio (Internal)	"Playing Back MIDI Data or Audio Data" (page EN-101) (◆[STYPE])
Audio C Cancel	Off, On	"Audio Center Cancel (Vocal Cut)" (page EN-104) (◆[STYPE])
<b>METRONOME</b>		(◆[METRO])
Tempo	20 - 255	"Changing the Metronome Settings (Tempo, Beat, Pattern, etc.)" (page EN-74)
Tempo Mark	Options* <sup>1</sup>	
Guide Type	Metronome, Drum	
Pattern	Bell Off, 1 Beat - 9 Beat / Options* <sup>1</sup>	
Volume	0 - 127	
While Playing	Off, On	
While Recording	Off, On	

Menu Item	Setting Values	Reference
<b>MEDIA</b>		"USB Flash Drive" (page EN-132)
<b>WIRELESS</b>		(◆Touch and hold [ADPTR])
Notification Vol	0 - 127	"Notification Tones" (page EN-144)
Audio Pairing	—	"Pairing the Digital Piano with a Bluetooth Audio Device" (page EN-146)
Pairing Clear	—	"Deleting Bluetooth Audio Device Pairing Registration" (page EN-147)
Audio C Cancel	Off, On	"Bluetooth Audio Center Cancel (Vocal Cut)" (page EN-152)
<b>MIDI</b>		—
Keyboard Ch	1 - 16	"Configuring MIDI Settings" (page EN-142)
Local Control	Off, On	
Hi-Reso MIDI Out	Off, On	
<b>SYSTEM</b>		—
Master Tuning	415.5 - 465.9	"Fine Tuning a Pitch (Master Tuning)" (page EN-124)
Op. Click Volume	0 - 10	"Setting the Volume of the Sound Made When the Touch Ring is Used (Operation Click Volume)" (page EN-26)
Panel Light	Off, 5, 30, 60, 120	"Panel Lights Off" (page EN-19)
Operation Lock	Off, On, Auto	"Operation Lock" (page EN-22)
Speaker Out	Off, On, Auto	"Outputting From the Speakers While Headphones are Connected" (page EN-20)
Headphone Mode	Off, On	"Headphone Mode" (page EN-21)
Auto Resume	Off, On	"Auto Resume" (page EN-17)
Auto Power Off	Off, On	"Auto Power Off" (page EN-17)
Power On Alert	Off, On	"Power On Alert and Illumination Effect" (page EN-18)
Battery Type	Alkaline, Ni-MH	"To select the Battery Type" (page EN-14)
Close-up	Off, On	"Close-Up Screen" (page EN-29)
LCD Contrast	1 - 17	"Adjusting Display Contrast" (page EN-19)

Menu Item	Setting Values	Reference
Touch Btn Sense	-1, 0, +1	"Setting the Sensitivity of the Touch Buttons and Touch Ring" (page EN-26)
Touch Ring Sense	-3 - 0 - +3	"Setting the Sensitivity of the Touch Buttons and Touch Ring" (page EN-26)
Setting Reset	—	"To return all Digital Piano settings to their initial factory defaults (Setting Reset)" (page EN-159)
Factory Reset	—	"To return all Digital Piano settings and data to their initial factory defaults (Factory Reset)" (page EN-159)
Version*4	—	—

\*1 For a list of options, see the "Reference" listed to the right of each item.

\*2 See "[Microphone Effect Type List](#)" (page EN-177).

\*3 See "[List of Effects in the Microphone Effects Module](#)" (page EN-178).

\*4 The software version of the device is displayed.

## Microphone Effects List

### Microphone Effect Type List

Listed below are the types of microphone effects and the effects contained in each module from M1 to M3 for each type.

For more information on the effects listed in the M1 to M3 columns, see “[List of Effects in the Microphone Effects Module](#)” (page EN-178).

No.	Microphone Effect Type Name (Displayed)	M1	M2	M3
1	Powerful	Mono 3-Band EQ	Mono 3-Band EQ	Delay
2	Presence	Mono 3-Band EQ	Mono 3-Band EQ	Delay
3	Clear	Mono 3-Band EQ	Mono 3-Band EQ	Delay
4	Soft	Limiter	Mono 3-Band EQ	Delay
5	Rock	Limiter	Mono 3-Band EQ	Delay
6	Bright Enh	Enhancer	Mono 3-Band EQ	Delay
7	Presence Enh	Enhancer	Mono 3-Band EQ	Delay
8	AmbientDelay	Mono 3-Band EQ	Mono 3-Band EQ	Delay
9	Short Delay	Mono 3-Band EQ	Mono 3-Band EQ	Delay
10	Echo	Mono 3-Band EQ	Mono 3-Band EQ	Delay
11	Middle Delay	Mono 3-Band EQ	Mono 3-Band EQ	Delay
12	Long Delay	Mono 3-Band EQ	Mono 3-Band EQ	Delay
13	Pan Delay	Mono 3-Band EQ	Auto Pan	Delay
14	Chorus	Mono 3-Band EQ	Chorus	Delay
15	Phaser	Mono 3-Band EQ	Phaser	Delay
16	Deep Phaser	Mono 3-Band EQ	Phaser	Delay
17	PhaserChorus	Mono 3-Band EQ	Phaser	Chorus
18	FlangerDelay	Mono 3-Band EQ	Flanger	Delay
19	FlangerPhase	Mono 3-Band EQ	Flanger	Phaser
20	Upper Octave	Mono 3-Band EQ	PitchShifter	Delay
21	Lower Octave	Mono 3-Band EQ	PitchShifter	Delay
22	Tremolo	Mono 3-Band EQ	Tremolo	Delay
23	Vibrato	Mono 3-Band EQ	Chorus	Delay
24	Distortion	Drive	Mono 3-Band EQ	Mono 3-Band EQ
25	RingMod LoFi	Drive	Ring Modulator	Mono 3-Band EQ

## List of Effects in the Microphone Effects Module

Listed below are all the effects included in the Microphone Effects module.

For details on the parameters and setting ranges that can be set for each effect, see “[Parameter List of Module Effects](#)” (page EN-179).

No.	Display	Name	Description
①	Mono 3BandEQ	Mono 3-Band EQ	This is a three-band monaural equalizer.
②	Tremolo	Tremolo	Shifts the volume of the input signal using an LFO.
③	Auto Pan	Auto Pan	Shifts the continual left-right panning of the input signal using an LFO.
④	Limiter	Limiter	Limits the input signal level so it does not rise above a preset level.
⑤	Enhancer	Enhancer	Enhances the profiles of the low range and high range of the input signal.
⑥	Phaser	Phaser	Produces a distinctive pulsating, broad sound by using an LFO to change the phase of the input signal and then mixes it with the original input signal.
⑦	Chorus	Chorus	Gives notes depth and breadth.
⑧	Flanger	Flanger	Applies wildly pulsating and metallic reverberation to notes. Selects the LFO waveform.
⑨	Pitch	PitchShifter	This effect transforms the pitch of the input signal.
⑩	Ring Mod	Ring Modulator	Multiplies the input signal with an internal oscillator signal to create a metallic sound.
⑪	Delay	Delay	Delays the input signal and feeds it back to create a repeating effect.
⑫	Drive	Drive	Simulates the drive of a musical instrument amplifier.

## Parameter List of Module Effects

Effect		Description	Settings
Display	Parameter Name		
① Mono 3-Band EQ		This is a three-band monaural equalizer.	
EQ1 Freq	EQ1 Frequency	Adjusts the center frequency of Equalizer 1.	*1
EQ1 Gain	EQ1 Gain	Adjusts the gain of Equalizer 1.	-12 - 00 - 12
EQ2 Freq	EQ2 Frequency	Adjusts the center frequency of Equalizer 2.	*1
EQ2 Gain	EQ2 Gain	Adjusts the gain of Equalizer 2.	-12 - 00 - 12
EQ3 Freq	EQ3 Frequency	Adjusts the center frequency of Equalizer 3.	*1
EQ3 Gain	EQ3 Gain	Adjusts the gain of Equalizer 3.	-12 - 00 - 12
Input Level	Input Level	Adjusts the input level.	000 - 127
Wet Level	Wet Level	Adjusts the level of the effect sound.	000 - 127
Dry Level	Dry Level	Adjusts the level of the direct sound.	000 - 127
② Tremolo		Shifts the volume of the input signal using an LFO.	
Rate	LFO Rate	Adjusts the LFO rate.	000 - 127
Depth	LFO Depth	Adjusts the LFO depth.	000 - 127
Waveform	LFO Waveform	Selects the LFO waveform.	Sine, Triangle, Trapezoid
Wet Level	Wet Level	Adjusts the level of the effect sound.	000 - 127
Dry Level	Dry Level	Adjusts the level of the direct sound.	000 - 127
③ Auto Pan		Shifts the continual left-right panning of the input signal using an LFO.	
Rate	LFO Rate	Adjusts the LFO rate.	000 - 127
Depth	LFO Depth	Adjusts the LFO depth.	000 - 127
Waveform	LFO Waveform	Selects the LFO waveform.	Sine, Triangle, Trapezoid 1, Trapezoid 2, Trapezoid 3, Trapezoid 4
Manual	Manual	Adjusts the pan (stereo position). -64 is full left, 0 is center, and +63 is full right.	-64 - 00 - 63
Wet Level	Wet Level	Adjusts the level of the effect sound.	000 - 127
Dry Level	Dry Level	Adjusts the level of the direct sound.	000 - 127

Effect		Description	Settings
Display	Parameter Name		
④ Limiter		Limits the input signal level so it does not rise above a preset level.	
Limit	Limit	Adjusts the volume level of the limit at which limiting is applied.	000 - 127
Attack	Attack	Adjusts the time until the compression effect starts. A smaller value causes prompt limiter operation, which suppresses the attack of the input signal. A larger values delays limiter operation, which causes the attack of the input signal to be output as-is.	000 - 127
Release	Release	Adjusts the time until compression is released after the input signal drops below a prescribed level.	000 - 127
Wet Level	Wet Level	Adjusts the level of the effect sound. Output volume changes in accordance with the Limit setting and the characteristics of the input tone. Use this parameter to correct for such changes.	000 - 127
Dry Level	Dry Level	Adjusts the level of the direct sound.	000 - 127
⑤ Enhancer		Enhances the profiles of the low range and high range of the input signal.	
Low Freq	Low Frequency	Adjusts the low range enhancer frequency.	000 - 127
Low Gain	Low Gain	Adjusts the low range enhancer gain.	000 - 127
High Freq	High Frequency	Adjusts the high range enhancer frequency.	000 - 127
High Gain	High Gain	Adjusts the high range enhancer gain.	000 - 127
Input Level	Input Level	Adjusts the input level.	000 - 127
Wet Level	Wet Level	Adjusts the level of the effect sound.	000 - 127
Dry Level	Dry Level	Adjusts the level of the direct sound.	000 - 127
⑥ Phaser		Produces a distinctive pulsating, broad sound by using an LFO to change the phase of the input signal and then mixes it with the original input signal.	
Resonance	Resonance	Adjusts the strength of feedback.	000 - 127
Manual	Manual	Adjusts the reference phaser shift amount.	-64 - 00 - 63
Rate	LFO Rate	Adjusts the LFO rate.	000 - 127
Depth	LFO Depth	Adjusts the LFO depth.	000 - 127
Waveform	LFO Waveform	Selects the LFO waveform.	Sine, Triangle, Random
Input Level	Input Level	Adjusts the input level.	000 - 127
Wet Level	Wet Level	Adjusts the level of the effect sound.	000 - 127
Dry Level	Dry Level	Adjusts the level of the direct sound.	000 - 127

Effect		Description	Settings
Display	Parameter Name		
⑦ Chorus		Gives notes depth and breadth.	
Rate	LFO Rate	Adjusts the LFO rate.	000 - 127
Depth	LFO Depth	Adjusts the LFO depth.	000 - 127
Waveform	LFO Waveform	Selects the LFO waveform.	Sine, Triangle
Feedback	Feedback	Adjusts the strength of feedback.	-64 - 00 - 63
Wet Level	Wet Level	Adjusts the level of the effect sound.	000 - 127
Polarity	Polarity	Inverts the LFO of one channel.	Negative, Positive
Input Level	Input Level	Adjusts the input level.	000 - 127
Dry Level	Dry Level	Adjusts the level of the direct sound.	000 - 127
⑧ Flanger		Applies wildly pulsating and metallic reverberation to notes. Selects the LFO waveform.	
Rate	LFO Rate	Adjusts the LFO rate.	000 - 127
Depth	LFO Depth	Adjusts the LFO depth.	000 - 127
Waveform	LFO Waveform	Selects the LFO waveform.	Sine, Triangle, Random
Feedback	Feedback	Adjusts the strength of feedback.	-64 - 00 - 63
Wet Level	Wet Level	Adjusts the level of the effect sound.	000 - 127
Input Level	Input Level	Adjusts the input level.	000 - 127
Dry Level	Dry Level	Adjusts the level of the direct sound.	000 - 127
⑨ PitchShifter		This effect transforms the pitch of the input signal.	
PitchQuarter	PitchQuarter	Adjusts the pitch shift amount in quarter tone steps.	-24 - 00 - 24
High Damp	High Damp	Adjusts the high-range damp. A smaller number increases damping.	000 - 127
Feedback	Feedback	Adjusts the feedback amount.	000 - 127
Input Level	Input Level	Adjusts the input level.	000 - 127
Wet Level	Wet Level	Adjusts the level of the effect sound.	000 - 127
Dry Level	Dry Level	Adjusts the level of the direct sound.	000 - 127
Pitch Fine	Pitch Fine	Adjusts the pitch shift amount. -50 is a quarter note decrease, while +50 is a quarter note increase.	-50 - 00 - 50



Effect		Description	Settings
Display	Parameter Name		
⑩ Ring Modulator		Multiplies the input signal with an internal oscillator signal to create a metallic sound.	
OSC Freq	OSC Frequency	Sets the reference frequency of the internal oscillator.	000 - 127
Rate	LFO Rate	Adjusts the LFO rate.	000 - 127
Depth	LFO Depth	Adjusts the LFO depth.	000 - 127
Tone	Tone	Adjusts the timbre of the ring modulator input sound.	000 - 127
Wet Level	Wet Level	Adjusts the level of the effect sound.	000 - 127
Dry Level	Dry Level	Adjusts the level of the direct sound.	000 - 127
⑪ Delay		Delays the input signal and feeds it back to create a repeating effect.	
Time	Delay Time	Adjusts the total delay time in 1 ms units.	0001 - 1099
L.Time Ratio	Delay Ratio L	Adjusts the ratio of the left channel relative to the total delay time.	000 - 127
R.Time Ratio	Delay Ratio R	Adjusts the ratio of the right channel relative to the total delay time.	000 - 127
L.Level	Delay Level L	Adjusts the level of the left channel.	000 - 127
R.Level	Delay Level R	Adjusts the level of the right channel.	000 - 127
FeedbackType	Feedback Type	Selects the feedback type. Stereo: Stereo feedback Cross: Cross feedback	Stereo, Cross
Feedback Lvl	Feedback	Adjusts the feedback amount.	000 - 127
High Damp	High Damp	Adjusts the high-range damp. A smaller number increases damping.	000 - 127
Tmpo Sync	Delay Tempo Sync	Specifies how the actual total delay time is synced with tempo. Off: Uses Delay Time value. 1/4 to 1: Uses value in accordance with number of beats.	Off, 1/4, 1/3, 3/8, 1/2, 2/3, 3/4, 1
Input Level	Input Level	Adjusts the input level.	000 - 127
Dry Level	Dry Level	Adjusts the level of the direct sound.	000 - 127
Wet Level	Wet Level	Adjusts the level of the effect sound.	000 - 127

Effect		Description	Settings
Display	Parameter Name		
⑫ Drive		Simulates the drive of a musical instrument amplifier.	
Type	Drive Type	Selects the drive type.*2	1 - 20
Gain	Gain	Adjusts the driver input signal gain.	000 - 127
Output Level	Level	Adjusts the drive output level.	000 - 127
Wet Level	Wet Level	Adjusts the level of the effect sound.	000 - 127
Dry Level	Dry Level	Adjusts the level of the direct sound.	000 - 127

\*1 100Hz, 125Hz, 160Hz, 200Hz, 250Hz, 315Hz, 400Hz, 500Hz, 630Hz, 800Hz, 1.0kHz, 1.3kHz, 1.6kHz, 2.0kHz, 2.5kHz, 3.2kHz, 4.0kHz, 5.0kHz, 6.3kHz, 8.0kHz

\*2

Settings	Drive Type	Display	Description
1 - 4	Clean1 - 4	Clean 1 - 4	Simulates a clean sound with little distortion.
5 - 8	Crunch1 - 4	Crunch 1 - 4	Simulates a crisp crunch sound with little distortion.
9 - 12	Overdrive1 - 4	Overdrive 1 - 4	Simulates an overdrive sound with mellow distortion.
13 - 16	Distortion1 - 4	Distort 1 - 4	Simulates a hard, straight distortion sound.
17 - 20	Metal1 - 4	Metal 1 - 4	Simulates an extreme and weighty distortion sound that is suitable for heavy metal music.

## Arpeggiator List

Listed below are the Arpeggiator patterns. When the “Recommended Setup” is “On”, when the Arpeggiator is switched from off to on, or when “Pattern” is switched while the Arpeggiator is on, the “Recommended Setup” listed are automatically applied.

No.	Pattern Name (Pattern)	Recommended Setup					Remarks
		The Arpeggiator's target part			Split Point sound name*1	Arpeggio Hold	
		Upper 1	Upper 2	Lower			
01	Piano Sequence 1	✓			F#3		*2
02	Piano Sequence 2			✓	C5	✓	*2
03	Piano Sequence 3		✓		F#3	✓	*2
04	Piano Sequence 4		✓		F#3	✓	*2
05	Piano Sequence 5	✓			F#3		
06	Piano Triplet Sequence	✓			F#3		*2
07	Piano Odd Sequence	✓			F#3	✓	*2
08	Chordal Phrase 1	✓			F#3	✓	
09	Chordal Phrase 2		✓		F#3	✓	*2
10	Chordal Phrase 3		✓		F#3	✓	*2
11	Ambient FX 1	✓			F#3	✓	*2
12	Ambient FX 2	✓			F#3	✓	*2
13	Single Note Sequence		✓		F#3		
14	Lower EP Phrase			✓	C3	✓	
15	Layered EP Phrase		✓		F#3	✓	
16	Layered EP Arpeggio		✓		F#3	✓	
17	Layered Arpeggio 1		✓		F#3	✓	
18	Layered Arpeggio 2		✓		F#3	✓	*2
19	Layered Arpeggio 3		✓		F#3	✓	*2
20	Layered Arpeggio 4		✓		F#3	✓	
21	Synth Sequence	✓			F#2	✓	
22	Lower Strings Phrase			✓	C3	✓	
23	Walking Bass			✓	C3	✓	
24	Simple Bass			✓	C3	✓	
25	Odd Phrase Bass			✓	C3	✓	
26	Latin Piano	✓	✓		F#3	✓	
27	Screw Up	✓	✓		F#3		
28	Screw Down	✓	✓		F#3		
29	Skip Up	✓	✓		F#3		
30	Skip Down	✓	✓		F#3		

No.	Pattern Name (Pattern)	Recommended Setup					Remarks
		The Arpeggiator's target part			Split Point sound name* <sup>1</sup>	Arpeggio Hold	
		Upper 1	Upper 2	Lower			
31	Up Up Down	✓	✓		F#3		
32	Down Down Up	✓	✓		F#3		
33	Sequence Line 1	✓	✓		F#3		
34	Sequence Line 2	✓	✓		F#3		
35	Sequence Line 3	✓	✓		F#3		
36	Arpeggio 2Octave	✓	✓		F#3		*2
37	9th Arpeggio	✓	✓		F#3		
38	Ragtime	✓	✓		F#3		
39	8 Beat	✓			F#3		
40	12/8	✓	✓		F#3		
41	Waltz	✓	✓		F#3		
42	Shuffle Pop	✓			F#3	✓	*2
43	Up 1Octave 1	✓	✓		F#3		
44	Up 2Octave 1	✓	✓		F#3		
45	Up 1Octave 2	✓	✓		F#3		
46	Up 2Octave 2	✓	✓		F#3		
47	Down 1Octave 1	✓	✓		F#3		
48	Down 2Octave 1	✓	✓		F#3		
49	Down 1Octave 2	✓	✓		F#3		
50	Down 2Octave 2	✓	✓		F#3		

\*1 When "Recommended Setup" is "On", the Split Point is automatically set to the keyboard key in this row when switching patterns. Therefore, the key range in which the Arpeggiator is reproduced varies with the pattern.

\*2 These patterns have the appropriate sustain effect added to the notes played by the Arpeggiator.

# MIDI Implementation Chart

Function		Transmitted	Recognized	Remarks
<b>Basic Channel</b>	Default	1	1 - 16	
	Changed	1 - 16	1 - 16	
<b>Mode</b>	Default Messages	Mode 3 X	Mode 3 X	
	Altered	*****	*****	
<b>Note Number</b>	True voice	0 - 127 *****	0 - 127 0 - 127*1	
	Note ON Note OFF	O 9nH v = 1 - 127 O 8nH v = 0 - 127	O 9nH v = 1 - 127 O 9nH v = 0, 8nH v = 0 - 127	
<b>After Touch</b>	Key's	X	X	
	Ch's	X	O	
<b>Pitch Bender</b>		O	O	
<b>Control Change</b>	0, 32	O	O	Bank select LSB/MSB Modulation Portamento time Data entry LSB/MSB Volume Pan Expression Hold 1 Portamento switch Sostenuto Soft pedal Filter resonance Release time Attack time Brightness Vibrato rate Vibrato depth Vibrato delay Portamento control High resolution velocity prefix Reverb send level Chorus send level Delay send level RPN LSB/MSB
	1	O *4	O	
5	O	O *3		
6, 38	O *3	O		
7	O *2	O		
10	O	O		
11	O	O		
64	O *2	O		
65	O *4	O		
66	O *2	O		
67	O	O		
71	O X	O		
72	O X	O		
73	O X	O		
74	O X	O		
76	O X	O		
77	O X	O		
78	O X	O		
84	O X	O		
88	O X	O		
91	O X	O		
93	O X	O		
94	O X	O		
100, 101	O *3	O *3		
<b>Program Change</b>	True #	O *****	O 0 - 127	
	<b>Exclusive</b>	O *3	O *3	
<b>System Common</b>	Song Pos	X	X	
	Song Sel	X	X	
	Tune	X	X	
<b>System Real Time</b>	Clock	X	X	
	Commands	X	X	
<b>Aux Messages</b>	All sound off	X	O	
	Reset all controller	X	O	
	Local ON/OFF	X	X	
	All notes OFF	X	O	
	Active Sense	X	O	
	System Reset	X	X	
<b>Remarks</b>		*1: Depends on tone. *2: Depends on the setup of the pedal connected to the EXPRESSION/ASSIGNABLE jack. *3: For details about RPN and system exclusive messages, see MIDI Implementation at <a href="https://support.casio.com/global/en/emi/manual/PX-S7000/">https://support.casio.com/global/en/emi/manual/PX-S7000/</a> *4: Depends on the EX button settings. • The MIDI messages marked with "x" in the "Transmitted" column of the above chart may be output along with certain operations.		

**CASIO®**

**CASIO COMPUTER CO., LTD.**

6-2, Hon-machi 1-chome  
Shibuya-ku, Tokyo 151-8543, Japan

PXS7000-E-2A

MA2209-A

© 2022 CASIO COMPUTER CO., LTD.