

PMH2000

EUROPOWER

User's Manual

Version 1.3 July 2004

ENGLISH



www.behringer.com



EUROPOWER PMH2000

IMPORTANT SAFETY INSTRUCTIONS



CAUTION: To reduce the risk of electric shock, do not remove the top cover (or the rear section). No user serviceable parts inside; refer servicing to qualified personnel.

WARNING: To reduce the risk of fire or electric shock, do not expose this appliance to rain and moisture. The apparatus shall not be exposed to dripping or splashing and no objects filled with liquids, such as vases, shall be placed on the apparatus.



This symbol, wherever it appears, alerts you to the presence of uninsulated dangerous voltage inside the enclosure—voltage that may be sufficient to constitute a risk of shock.



This symbol, wherever it appears, alerts you to important operating and maintenance instructions in the accompanying literature. Please read the manual.

DETAILED SAFETY INSTRUCTIONS:

- 1) Read these instructions.
 - 2) Keep these instructions.
 - 3) Heed all warnings.
 - 4) Follow all instructions.
 - 5) Do not use this apparatus near water.
 - 6) Clean only with dry cloth.
 - 7) Do not block any ventilation openings. Install in accordance with the manufacturer's instructions.
 - 8) Do not install near any heat sources such as radiators, heat registers, stoves, or other apparatus (including amplifiers) that produce heat.
 - 9) Do not defeat the safety purpose of the polarized or grounding-type plug. A polarized plug has two blades with one wider than the other. A grounding type plug has two blades and a third grounding prong. The wide blade or the third prong are provided for your safety. If the provided plug does not fit into your outlet, consult an electrician for replacement of the obsolete outlet.
 - 10) Protect the power cord from being walked on or pinched particularly at plugs, convenience receptacles, and the point where they exit from the apparatus.
 - 11) Only use attachments/accessories specified by the manufacturer.
 - 12) Use only with the cart, stand, tripod, bracket, or table specified by the manufacturer, or sold with the apparatus. When a cart is used, use caution when moving the cart/apparatus combination to avoid injury from tip-over.
- 
- 13) Unplug this apparatus during lightning storms or when unused for long periods of time.
 - 14) Refer all servicing to qualified service personnel. Servicing is required when the apparatus has been damaged in any way, such as power supply cord or plug is damaged, liquid has been spilled or objects have fallen into the apparatus, the apparatus has been exposed to rain or moisture, does not operate normally, or has been dropped.
 - 15) **CAUTION** - These service instructions are for use by qualified service personnel only. To reduce the risk of electric shock do not perform any servicing other than that contained in the operation instructions unless you are qualified to do so.

FOREWORD



Dear Customer,

Welcome to the team of EUROPOWER users and thank you very much for expressing your confidence in BEHRINGER products by purchasing the BEHRINGER PMH2000.

It is one of my most pleasant tasks to write this letter to you, because it is the culmination of many months of hard work delivered by our engineering team to reach a very ambitious goal: to present you with an outstanding power mixer that gives you maximum flexibility and perfor-

mance with its unique sound character and broad range of functions. The task to design the new PMH2000 certainly meant a great deal of responsibility, which we assumed by focusing on you, the discerning user and musician. It also meant a lot of work and night shifts to accomplish this goal. But it was fun, too. Developing a product usually brings a lot of people together, and what a great feeling it is when everybody who participated in such a project can be proud of what we've achieved.

It is our philosophy to share our joy with you, because you are the most important member of the BEHRINGER team. With your highly competent suggestions for new products you've greatly contributed to shaping our company and making it successful. In return, we guarantee you uncompromising quality as well as excellent technical and audio properties at an extremely favorable price. All of this will enable you to fully unfold your creativity without being hampered by budget constraints.

We are often asked how we can make it to produce such high-grade devices at such unbelievably low prices. The answer is quite simple: it's you, our customers! Many satisfied customers means large sales volumes enabling us to get better conditions of purchase for components, etc. Isn't it only fair to pass this benefit back to you? Because we know that your success is our success, too!

I would like to thank all people whose help on "Project PMH2000" has made it all possible. Everybody has made very personal contributions, starting from the designers of the unit to the many staff members in our company and finally to you, the user of BEHRINGER products.

My friends, it's been worth the trouble!

Thank you very much,

Uli Behringer

TABLE OF CONTENTS

1. INTRODUCTION	4
1.1 Before you get started	4
1.1.1 Shipment	4
1.1.2 Initial operation	4
1.1.3 Warranty	4
2. CONTROL ELEMENTS	4
2.1 Front panel	4
2.2 Rear panel	5
3. EFFECTS PROCESSOR	6
4. INSTALLATION	7
4.1 Mains voltage	7
4.2 Mains connection	7
4.3 Audio connections	7
4.4 Loudspeaker connections	7
5. WIRING EXAMPLES	8
6. SPECIFICATIONS	9
7. WARRANTY	10

CAUTION!

 Please note that high volume levels may cause permanent damage to your hearing and/or your headphones. Turn all LEVEL controls to the left before you switch on the unit. Be sure to keep the volume at an appropriate level.

EUROPOWER PMH2000

1. INTRODUCTION

Congratulations! With the PMH2000 you have acquired a state-of-the-art 10-channel power mixer that sets new standards. Right from the start, our goal has been to design a revolutionary device that can be used for a great variety of applications. And indeed, this overwhelming power mixer gives you plenty of functionality and a broad range of connection and expansion options.

BEHRINGER is a company with its roots in professional recording studio technology. For many years now we have been successful in developing products for studio and live use. These include microphones and 19" devices of all kinds (compressors, enhancers, noise gates, tube processors, headphone amplifiers, digital effects devices, DI boxes, etc.), monitor and P.A. speakers and professional live and recording mixers. Our entire technical know-how has gone into your PMH2000.

 **This manual first describes the terminology used, so that you fully understand the PMH2000 and its functions. Please read the manual carefully and keep it for future reference.**

1.1 Before you get started

1.1.1 Shipment

Your PMH2000 was carefully packed at the factory and the packaging is designed to protect the unit from rough handling. Nevertheless, we recommend that you carefully examine the packaging and its contents for any signs of physical damage which may have occurred during transit.

 **If the unit is damaged, please do NOT return it to BEHRINGER, but notify your dealer and the shipping company immediately. Otherwise, claims for damage or replacement may not be granted.**

1.1.2 Initial operation

Be sure that there is enough space around the unit for cooling and, to avoid overheating, please do not place the PMH2000 near radiators etc.

 **Before you connect the PMH2000 to the mains, please make sure that the voltage setting on the unit matches the local voltage!**

 **If you set the unit to a different mains voltage, be sure to use a fuse of the correct type and rating. Please refer to the "SPECIFICATIONS" for details.**

 **Blown fuses must be replaced by fuses of the same type and rating! Please refer to the "SPECIFICATIONS" for details.**

The mains connection is made using the enclosed power cord and a standard IEC receptacle. It meets all of the international safety certification requirements.

 **Please make sure that all units have a proper ground connection. For your own safety, never remove or disable the ground conductor from the unit or of the AC power cord. The unit shall always be connected to the mains socket outlet with a protective earthing connection.**





















1.1.3 Warranty

The EUROPOWER's serial number is located on the rear. Please take the time to fill in and return the warranty card within 14 days after the date of purchase, so as to benefit from our extended warranty. Or register online at www.behringer.com.

2. CONTROL ELEMENTS

2.1 Front panel

Your EUROPOWER PMH2000 comes with ten input channels, which only differ in terms of pad switch, peak LED and interface panel. Since the EQ, effect, monitor and level controls are identical on all channels, they will be described only once on the enclosed sheet.

-  The *FX* control determines the signal level that is routed from the respective channel to the built-in effects processor.
-  **Please note that the effects processor is muted as long as the *FX TO MAIN* control ( 22) is set fully counter-clockwise.**
-  The *HI* control in the EQ section governs the high frequencies of the respective channel.
-  Use the *MID* control to boost/cut the mid range.
-  The *LOW* control allows you to raise or lower the bass frequencies.
-  The *MON* control determines the channel's volume assigned to the monitor mix.
-  Use the *LEVEL* control to set the volume level of the respective channel.
-  Use the *PEAK* LED to ensure that the input gain is set properly. The *PEAK* LED should light up only with peak signals, but never all the time.
-  The *PAD* button reduces the channel input sensitivity by 25 dB. Thus, you can also connect high-level line signals to the respective channel input.
-  This *HI-Z/LINE* input can be used to connect line level signal sources, such as keyboards, electric and bass guitars.
-  This is the channel's balanced XLR microphone input.
-  The stereo line input of channels 7 - 9 can be used to connect, for example, keyboards with stereo outputs or a stereo drum computer.
-  **Please remember to use either the microphone or the line input on a specific channel. Never use both at the same time. This rule applies to channels 1 - 9.**
-  **When you connect a mono line signal to channels 7 - 9, please always use the left input. The mono signal will then be reproduced on both stereo sides.**
-  The *TAPE/LINE IN* RCA input of channel 10 allows you to feed in external stereo signals from your CD player or tape deck, for example.
-  The *TAPE/LINE OUT* RCA output provides the stereo main mix signal of your PMH2000 and can be routed to, say, a recording machine.
-  **When the *TAPE OUT* signal is connected to a tape deck whose output signal is routed back to the *TAPE IN* on the PMH2000, feedback can be produced as soon as you start recording. Be sure to interrupt the connection to the *TAPE IN* before recording!**
-  The phantom power supply provides the voltage necessary for the operation of condenser microphones. Use the *PHANTOM POWER* switch to activate the supply together for channels 1 - 9 (XLR connector). The LED above the switch is lit when phantom power is on.
-  This is the PMH2000's graphic stereo equalizer, which comprises two units and can be used to adapt the sound to the room acoustics.

- ▲ The stereo equalizer is effective on the main mix when both units have been activated with the EQ IN buttons [16] and the MODE switch [21] is set to its upper position ("LEFT/RIGHT").
- ▲ The stereo equalizer uses one unit each to process the main and monitor mix signals, if both units are on and the MODE switch [21] is set to its lower position ("MON/MAIN").
- [16] Use the EQ IN buttons to switch the two equalizer units on or off.
- [17] Press the RUMBLE FILTER button to activate the low-cut filter of channels 1 - 6. This filter eliminates unpleasant bass frequencies (e.g. microphone pop noise).
- [18] The FX TO MON control determines the effects intensity of the multi-effects processor as part of the monitor mix. Turn the control fully counter-clockwise to add no effect to the monitor mix.
- [19] The MONITOR LEVEL control adjusts the volume of the monitor mix.
- [20] Use the MONITOR LEVEL display to control the monitor signal level. The upper LED (LIM) lights up when the built-in limiter is activated, thus protecting against overload.
- [21] With this MODE switch you can determine whether the PMH2000 works as a stereo amplifier ("LEFT/RIGHT") or as a dual mono amplifier ("MON/MAIN"). Please note that the equalizer function also depends on this switch setting (see [15]).
- [22] The FX TO MAIN control functions as FX return for the built-in effects processor. Use this control to add the desired effect signal to the main mix. No effect signal is added when the FX TO MAIN is set fully counter-clockwise.
- [23] The MAIN LEVEL control governs the overall volume of the PMH2000.
- [24] The MAIN LEVEL display reads the output level of the PMH2000. The upper LED (LIM) lights up when the built-in limiter is activated, thus protecting against signal peaks.
- [25] Use the FX FOOTSWITCH jack to connect any commercially available foot controller. It allows you to bypass the effects unit.
- [26] This is the balanced MONITOR output of your PMH2000. Use it to feed an external monitor amp or active wedge.
- [27] These two 1/4" TS jacks allow you to route the output signal to an external amplifier. This allows you to, say, use only the mixing and effect section of the PMH2000. The signal is taken pre-power amp. Of course, you can also use only the left jack as a mono output.
- [28] These two 1/4" TS jacks can be used to connect external signals, such as the main mix signal from an additional mixing console (pre-power amp).
- [29] Here, you will find a list of all multi-effect presets available.
- [30] This is the LED level meter of the effects processor. Please make sure that the clip LED lights up with signal peaks only. If it is lit constantly, this indicates that the effects processor is overdriven, which can lead to unpleasant distortion.
- [31] The EFFECT display reads the currently selected preset.
- [32] Turn the PROGRAM control to select the effect presets. Press the control briefly to confirm your selection.

2.2 Rear panel

- [33] The mains connection is on a standard IEC receptacle. An appropriate power cord is supplied with the unit.
- [34] FUSE HOLDER. Before connecting the unit to the mains, ensure that the voltage setting matches your local voltage. Blown fuses should only be replaced by fuses of the same type and rating.
- [35] Use the POWER switch to put your PMH2000 into operation. The POWER switch should always be in the "Off" position when you are about to connect your unit to the mains.
- ☞ **Attention: The POWER switch does not fully disconnect the unit from the mains. Unplug the power cord completely when the unit is not used for prolonged periods of time.**
- [36] This is the RIGHT/MONO MAIN Speakon® loudspeaker output of your PMH2000, where you can connect the right loudspeaker of a stereo system. For this purpose, switch [21] must be set to its upper position. If, however, you run a mono main mix (switch [21] set to its lower position), this loudspeaker output provides the main mix signal in mono.
- ☞ **The impedance of the loudspeaker connected here must not fall below 4 Ω.**
- [37] The BRIDGE loudspeaker output allows you to combine the left and right stereo channel in one mono output, which is useful for applications that require the use of one loudspeaker only. To use the BRIDGE output, switch [21] must be set to "LEFT/RIGHT".
- ☞ **Always connect the BRIDGE jack to a loudspeaker with a minimum impedance of 8 Ω!**
- ☞ **Please note that the power delivered to the speaker connected to the BRIDGE output is considerably higher than the power provided to the speakers wired to the parallel speaker outputs. Please read the information given on the rear panel of your PMH2000.**
- ☞ **When using the BRIDGE loudspeaker output, NEVER use any of the other two connectors (RIGHT/MONO MAIN and LEFT/MONITOR) at the same time!**
- [38] This is the LEFT/MONITOR Speakon® loudspeaker output of your PMH2000, to which you can connect the left loudspeaker of a stereo system (switch [21] set to its upper position). If you do a main mix in mono (switch [21] set to its lower position), this loudspeaker output provides the monitor signal in mono.
- ☞ **The impedance of the loudspeaker connected here must not fall below 4 Ω.**
- ☞ **Information on how to properly connect your speaker with regard to polarity can be found on the rear of the unit (PIN assignment).**
- [39] SERIAL NUMBER. Please take the time to fill in and return the warranty card within 14 days after the date of purchase, so as to benefit from our extended warranty. Or register online at www.behringer.com.

3. EFFECTS PROCESSOR

A special feature of your PMH2000 is its built-in multi-effects processor that features the same audio quality as our renowned 19" effects device VIRTUALIZER PRO DSP2024P. The processor comes with 99 different standard effects such as reverb, chorus, flanger, delay, vocal distortion as well as various effects combinations.

EUROPOWER PMH2000



Cathedral: Simulates the dense, long reverberation of a large cathedral, which is appropriate for solo instruments or vocals in slow pieces. Please choose between two variations.

Plate: Simulates the sound of plate reverberators and hence is a classic for drums (snare) and vocals. In comparison with the first variation, the second one features more high-end sparkle.

Concert: Here, you can select between a small theater and a large hall. Although this program is similar to studio (see below) it features more presence which adds to its "lively" character.

Stage: Is well suited to dissipating the sound of a keyboard or an acoustic guitar.

Room: You can clearly hear the walls of the room. A useful program for reverb that isn't directly noticeable (rap, hip hop vocals) or to make dry recordings of instruments sound natural again.

Studio: This simulation of a middle to large-sized room is also available in two variations. Both variations sound very natural. Very all-round effect.

Small Hall: Simulates a small, lively (strongly reflecting) hall and is perfect for processing drums.

Ambience: Reproduces a middle-sized room without late reflections.

Early Reflections: The initial reflections of this room are clearly audible. This effect is a classic for dynamic signals (drums, percussion, slap bass etc.).

Spring Reverb: Simulates a classic spring reverberation.

Gated Reverb: This effect synthetically cuts off reverberation after a period of time. It is famous in the song "In the Air Tonight" by Phil Collins. The variations differ in the reverb length.

Reverse Reverb: This is a reverberation in which the envelope is reversed—it slowly gets louder.



Chorus: This effect slightly detunes the original signal. A very pleasant detune effect is created in connection with the pitch variation. The chorus effect is quite often and extensively used for dispersing signals—in such a variety of applications that any recommendation would mean a limitation of their use. The variations available here range from slow to fast chorus effects.

Symphonic: This effect creates the sound of an eight-person (!) vocal chorus.

Flanger: The word "flange" means "tape spool", and this explains the characteristics of the effect. Originally the flanger effect was generated with two tape recorders which ran synchronously. The same audio signal was recorded on both machines. If you put a finger on the left spool of one of the machines, the spool and the playback speed are slowed down. The generated delay results in phase shifting of the signals. Please choose either "medium flanger" or one of the "bright flanger" programs, which feature an increase in presence.

Phaser: With the phaser, a second, phase-shifted signal is added to the original audio signal. The resulting sound is thicker and above all livelier. This effect is often used for guitar sounds and keyboards. In the '70s, it was also extensively used for other instruments like electric pianos. The PMH2000 offers you four different phaser variations.

Rotary Speaker: The simulation of a classic effect that is normally generated with a very heavy enclosure comprising (slow or fast) rotating speakers.



Delay: A delay of the input signal with various repetitions. Different tempo settings (ten variations in total) allow interesting delay effects.

Echo: Similar to the stereo delay, with the difference being that the repetitions have less presence. This simulates the character of the original tape echo that was used before the digital era and can be thought of as a "Vintage Sound".

Multi Tap: A delay effect with changing stereo positioning. Four variations are available.



Chorus & Reverb: This algorithm combines the popular chorus with a reverb effect. Taking all variations into account, they differ in the length of reverb.

Flanger & Reverb: The combination of flanger and reverb effects.

Phaser & Reverb: The combination of a classic stereo phaser and a reverb effect. Here, too, the phaser is combined with different reverb types.

Rotary Speaker & Reverb: A real classic, the rotary speaker effect, is processed with a reverb effect. This effect works especially well with keyboards and guitars.

Delay & Reverb: Delay and reverb is the most common combination for vocals, solo guitars, etc.

Pitch & Reverb: The pitch shifter slightly detunes the audio signal, while the reverb adds ambience to the signal.

Delay & Chorus: While the chorus can contribute to a wideness of the signal, interesting repetition effects can be adjusted with the delay. Vocals can be given a distinctive effect without making the voice sounding blurred.

Delay & Flanger: This effect is just right for creating a modern, slightly "spacey" vocal sound.

Delay & Pitch: A repetition of the audio signal, with an oscillatory effect added by the pitch shifter.



3-Voice Pitch: The pitch effect can be used to produce a cartoon-character type voice effect.

LFO Bandpass: Filters, in general, influence the frequency response of a signal. A low-pass filter allows low frequencies to pass and suppresses high frequencies, while a high pass filter allows high frequencies to pass and suppresses low frequencies. This LFO bandpass effect is complemented by modulation due to a LFO (Low Frequency Oscillator).

Vocal Distortion: This effect is very hip when used on vocals and drum loops.

Vinylizer: This effect adds clicks and noise to your audio signal, simulating old vinyl records.

Space Radio: Here, the typical sound of scanning an FM tuner is simulated. This can be a very interesting effect when sound-tracking radio plays.

Test Tone: Use this 1 kHz test tone to facilitate P.A. level setting.

4. INSTALLATION

4.1 Mains voltage

Before connecting the PMH2000 to the mains, please carefully check that your equipment is set to the correct voltage! Blown fuses must be replaced by fuses of the same type and rating!

4.2 Mains connection

The mains connection is made using the enclosed power cord and a standard IEC receptacle. It meets all of the international safety certification requirements.

 Please make sure that all units have a proper ground connection. For your own safety, never remove or disable the ground conductor from the unit or of the AC power cord.

4.3 Audio connections

The in and outputs of your BEHRINGER PMH2000 are designed as unbalanced 1/4" mono jacks—except for the mono channel line inputs, which come as balanced 1/4" stereo jacks. Of course, all in and outputs work with both balanced and unbalanced connectors. The tape ins and outs are on stereo RCA connectors.

 Please ensure that only qualified personnel install and operate the PMH2000. During installation and operation, the user must have sufficient electrical contact to earth. Electrostatic charges might affect the operation of the unit.

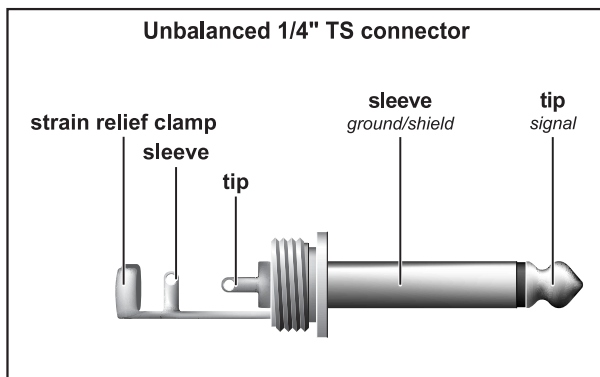
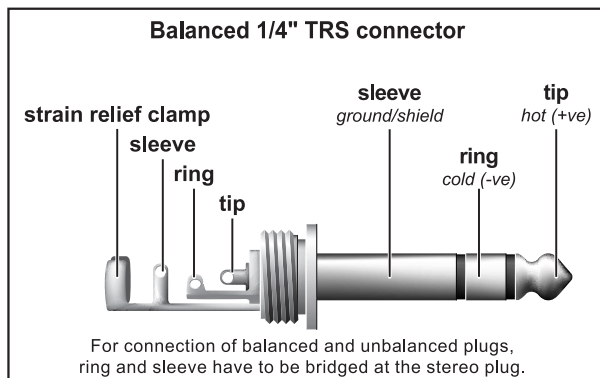

Fig. 4.1: 1/4" mono plug



For connection of balanced and unbalanced plugs, ring and sleeve have to be bridged at the stereo plug.

Fig. 4.2: 1/4" stereo plug

Balanced XLR connectors

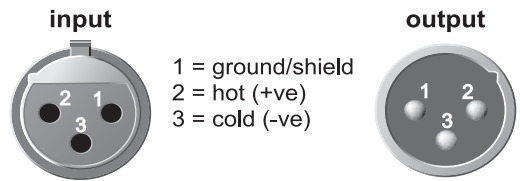

For unbalanced use pin 1 and pin 3 have to be bridged

Fig. 4.3: XLR connectors

1/4" TS footswitch connector

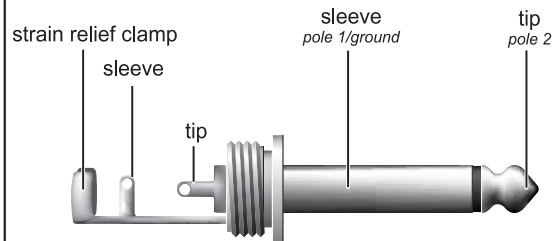

The footswitch connects both poles momentarily

Fig. 4.4: 1/4" TS connector for footswitch

4.4 Loudspeaker connections

Your EUROPOWER is equipped with high-quality NEUTRIK® SPEAKON®-compatible loudspeaker connectors, which ensure safe and trouble-free operation. The SPEAKON® connector was especially developed for high-power loudspeakers. Once it is plugged in, it safely locks into position and cannot be accidentally disengaged. It prevents the occurrence of electrical shock and ensures the correct polarity. Each of the connectors carries only the assigned single signal (see tab. 4.1/fig. 4.6 and the information on the rear panel of the power mixer).

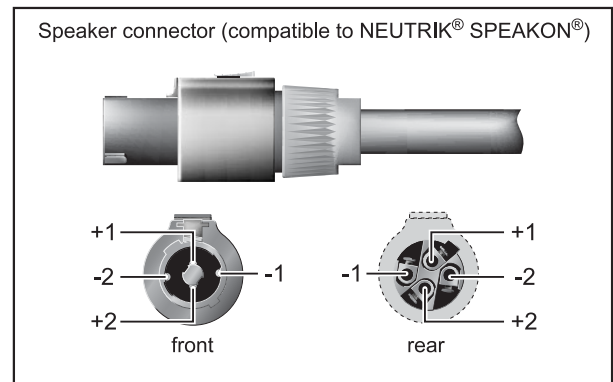

Fig. 4.5: Loudspeaker connector

Please be sure to only use commercial SPEAKON® cables (type NL4FC) for connecting your loudspeakers to the PMH2000. Please check the pin assignment of your loudspeakers and cables dependent on the PMH2000 speaker output you choose.

	1+	1-	2+	2-
RIGHT/MONO MAIN	POS	NEG	-	-
LEFT/MONITOR	POS	NEG	-	-
BRIDGE	POS	NEG	-	-

Tab. 4.1: Polarity configuration of speaker connectors

EUROPOWER PMH2000

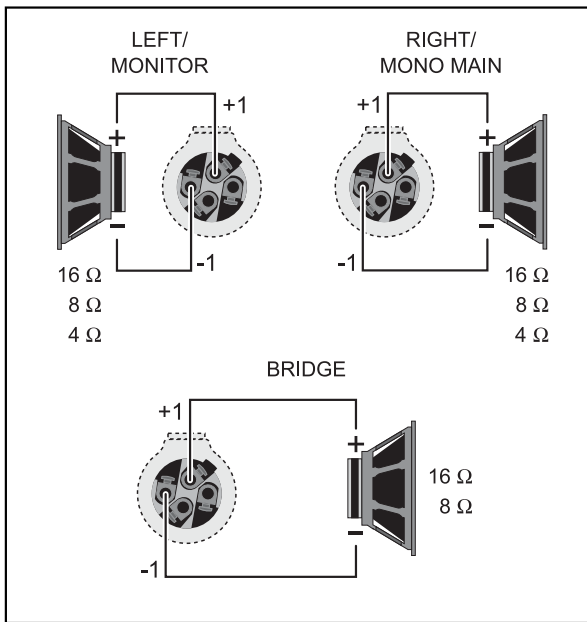

Fig. 4.6: PMH2000 loudspeaker connector assignment

5. WIRING EXAMPLES

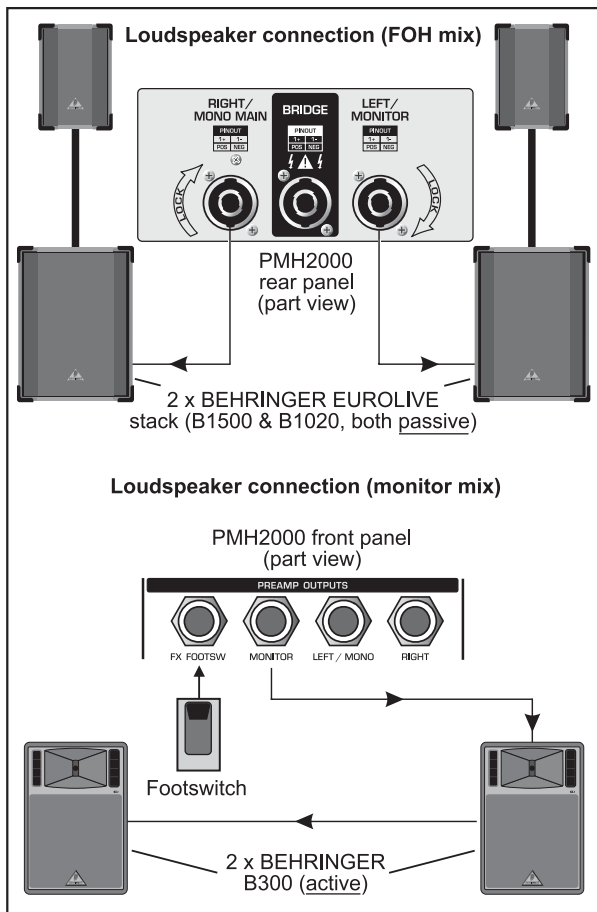

Fig. 5.1: PMH2000 as stereo amplifier (example)

⚠ Please set the MODE switch [21] to "LEFT/RIGHT" for this application!

Loudspeaker connection enabling both mono FOH and mono monitor mixes

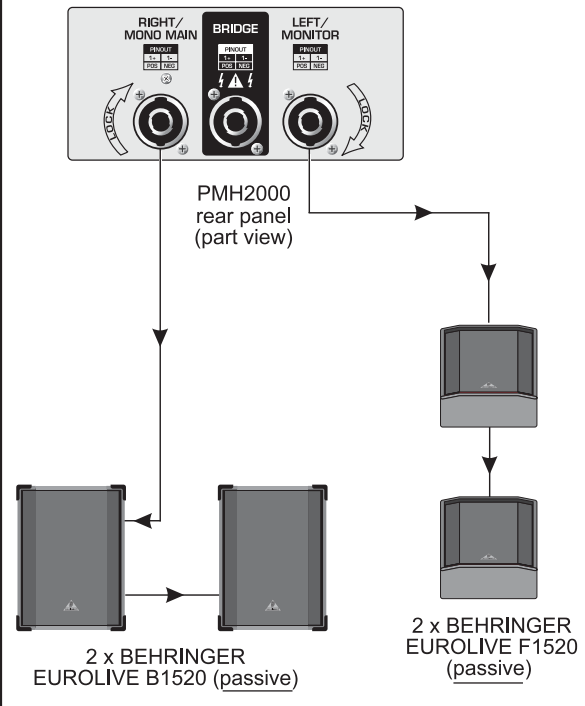

Fig. 5.2: PMH2000 as double mono amplifier (example)

⚠ For this application, however, please set the MODE switch [21] to "MON/MAIN"!

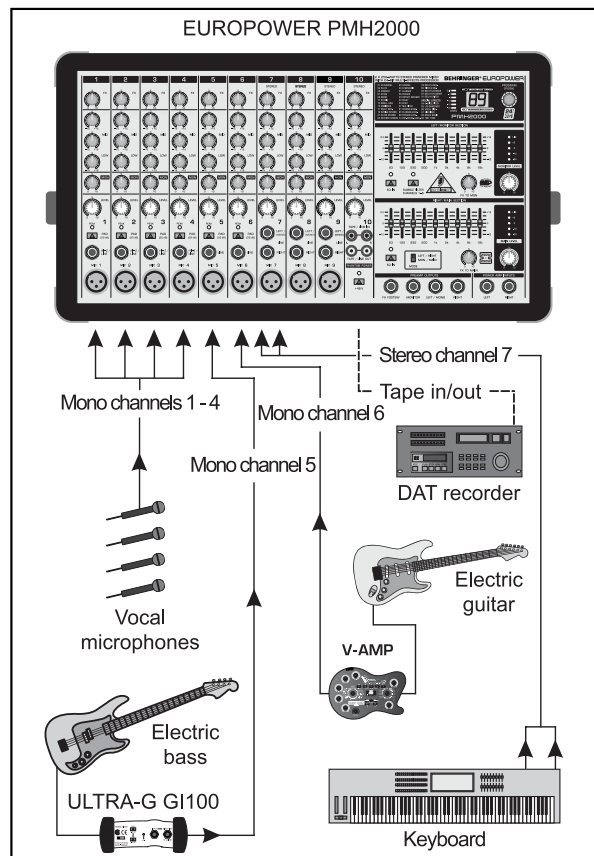

Fig. 5.3: Standard setup (example)

6. SPECIFICATIONS

Mono inputs

Microphone inputs

Type XLR, electronically balanced, discrete input circuit

Mic E.I.N. (20 Hz - 20 kHz)
 @ 0 Ω source resistance -122 dB / 125 dB A-weighted
 @ 50 Ω source resistance -122 dB / 125 dB A-weighted
 @ 150 Ω source resistance -121 dB / 124 dB A-weighted

Frequency response <10 Hz - 100 kHz (-1 dB), <10 Hz - >200 kHz (-3 dB)

Gain +33 dB, +8 dB with pad
 Max. input level +12 dBu @ +8 dB gain
 Impedance approx. 2.2 k Ω balanced / 1.1 k Ω unbalanced
 Signal-to-noise ratio 110 dB / 114 dB A-weighted (-11 dBu In @ +33 dB gain)

Distortion (THD+N) 0.001% / 0.0008% A-weighted

Mono line inputs

Type 1/4" TRS connector, balanced
 Impedance approx. 80 k Ω balanced, 40 k Ω unbalanced

Max. input level 30 dBu

Stereo line inputs

Type 1/4" TRS connector, unbalanced
 Impedance approx. 40 k Ω unbalanced
 Max. input level +28 dBu

EQ

Low 60 Hz / ± 15 dB
 Mid 700 Hz / ± 15 dB
 High 6 kHz / ± 15 dB

Preamp outputs left/mono & right

Type 1/4" TRS connector, unbalanced
 Impedance approx. 1.5 k Ω
 Max. output level +21 dBu

Power amp inputs

Type 1/4" TRS connector, unbalanced
 Impedance approx. 47 k Ω
 Max. input level +21 dBu

Monitor output

Type 1/4" TRS connector, unbalanced
 Impedance 1.5 k Ω
 Max. output level +21 dBu

DSP

Converter 24-bit Texas Instruments™
 24-bit Sigma-Delta,
 64/128-times oversampling
 Sampling rate 46.875 kHz

Main mix system data¹

Noise
 Main mix @ - ∞ ,
 Channel fader - ∞ -76 dB / -80 dB A-weighted
 Main mix @ 0 dB,
 Channel fader - ∞ -72 dB / -76 dB A-weighted
 Main Mix @ 0 dB,
 Channel fader @ 0 dB -71 dB / -75 dB A-weighted

Power amp specifications

Power amp output (Sine @ 1 % THD)
 Stereo mode 250 W into 4 Ω
 180 W into 8 Ω
 Bridge mode 500 W into 8 Ω

Loudspeaker connections

Loudspeaker connector Professional speaker connectors (compatible to NEUTRIK® SPEAKON®)

Load impedance
 Left/monitor 4/8/16 Ω
 Right/mono main 4/8/16 Ω
 Bridge 8/16 Ω

Power supply

Voltage
 USA/Canada 120 V~, 60 Hz
 Europe/U.K./Australia 230 V~, 50 Hz
 Japan 100 V~, 50 - 60 Hz
 General export model 120/230 V~, 50 - 60 Hz
 Power consumption max. 1 kW
 Fuse 100 - 120 V~: **T 10 A H 250 V**
 200 - 240 V~: **T 6.3 A H 250 V**
 Mains connection Standard IEC receptacle

Physical/weight

Dimensions (H x W x D) approx. 11" (280 mm) x 18 1/8" (460 mm) x 10 5/8" (270 mm)
 Weight (net) approx. 14 kg (30.9 lbs)

Measuring conditions:

1: 20 Hz - 20kHz; measured at preamp output. All channels: level controls in center position; EQ flat. Reference = 0 dBu.

BEHRINGER is constantly striving to maintain the highest professional standards. As a result of these efforts, modifications may be made from time to time to existing products without prior notice. Specifications and appearance may differ from those listed or illustrated.

7. WARRANTY

§ 1 WARRANTY CARD/ONLINE REGISTRATION

To be protected by the extended warranty, the buyer must complete and return the enclosed warranty card within 14 days of the date of purchase to BEHRINGER Spezielle Studiotechnik GmbH, in accordance with the conditions stipulated in § 3. Failure to return the card in due time (date as per postmark) will void any extended warranty claims. Based on the conditions herein, the buyer may also choose to use the online registration option via the Internet (www.behringer.com or www.behringer.de).

§ 2 WARRANTY

1. BEHRINGER (BEHRINGER Spezielle Studiotechnik GmbH including all BEHRINGER subsidiaries listed on the enclosed page, except BEHRINGER Japan) warrants the mechanical and electronic components of this product to be free of defects in material and workmanship for a period of one (1) year* from the original date of purchase, in accordance with the warranty regulations described below. If the product shows any defects within the specified warranty period that are not excluded from this warranty as described under § 4, BEHRINGER shall, at its discretion, either replace or repair the product using suitable new or reconditioned parts. In the case that other parts are used which constitute an improvement, BEHRINGER may, at its discretion, charge the customer for the additional cost of these parts.

2. If the warranty claim proves to be justified, the product will be returned to the user freight prepaid.

3. Warranty claims other than those indicated above are expressly excluded.

§ 3 RETURN AUTHORIZATION NUMBER

1. To obtain warranty service, the buyer (or his authorized dealer) must call BEHRINGER (see enclosed list) during normal business hours **BEFORE** returning the product. All inquiries must be accompanied by a description of the problem. BEHRINGER will then issue a return authorization number.

2. Subsequently, the product must be returned in its original shipping carton, together with the return authorization number to the address indicated by BEHRINGER.

3. Shipments without freight prepaid will not be accepted.

§ 4 WARRANTY REGULATIONS

1. Warranty services will be furnished only if the product is accompanied by a copy of the original retail dealer's invoice. Any product deemed eligible for repair or replacement under the terms of this warranty will be repaired or replaced.

2. If the product needs to be modified or adapted in order to comply with applicable technical or safety standards on a national or local level, in any country which is not the country for which the product was originally developed and manufactured, this modification/adaptation shall not be considered a defect in materials or workmanship. The warranty does not cover any such modification/adaptation, irrespective of whether it was carried out properly or not. Under the terms of this warranty, BEHRINGER shall not be held responsible for any cost resulting from such a modification/adaptation.

3. Free inspections and maintenance/repair work are expressly excluded from this warranty, in particular, if caused by improper handling of the product by the user. This also applies to defects caused by normal wear and tear, in particular, of faders, crossfaders, potentiometers, keys/buttons, tubes, guitar strings, illuminants and similar parts.

4. Damages/defects caused by the following conditions are not covered by this warranty:

▲ improper handling, neglect or failure to operate the unit in compliance with the instructions given in BEHRINGER user or service manuals.

▲ connection or operation of the unit in any way that does not comply with the technical or safety regulations applicable in the country where the product is used.

▲ damages/defects caused by force majeure or any other condition that is beyond the control of BEHRINGER.

5. Any repair or opening of the unit carried out by unauthorized personnel (user included) will void the warranty.

6. If an inspection of the product by BEHRINGER shows that the defect in question is not covered by the warranty, the inspection costs are payable by the customer.

7. Products which do not meet the terms of this warranty will be repaired exclusively at the buyer's expense. BEHRINGER will inform the buyer of any such circumstance. If the buyer fails to submit a written repair order within 6 weeks after notification, BEHRINGER will return the unit C.O.D. with a separate invoice for freight and packing. Such costs will also be invoiced separately when the buyer has sent in a written repair order.

§ 5 WARRANTY TRANSFERABILITY

This warranty is extended exclusively to the original buyer (customer of retail dealer) and is not transferable to anyone who may subsequently purchase this product. No other person (retail dealer, etc.) shall be entitled to give any warranty promise on behalf of BEHRINGER.

§ 6 CLAIM FOR DAMAGES

Failure of BEHRINGER to provide proper warranty service shall not entitle the buyer to claim (consequential) damages. In no event shall the liability of BEHRINGER exceed the invoiced value of the product.

§ 7 OTHER WARRANTY RIGHTS AND NATIONAL LAW

1. This warranty does not exclude or limit the buyer's statutory rights provided by national law, in particular, any such rights against the seller that arise from a legally effective purchase contract.

2. The warranty regulations mentioned herein are applicable unless they constitute an infringement of national warranty law.

* Customers in the European Union please contact BEHRINGER Germany Support for further details.

Technical specifications and appearance subject to change without notice. The information contained herein is correct at the time of printing. The names of companies, institutions or publications pictured or mentioned and their respective logos are registered trademarks of their respective owners. Their use neither constitutes a claim of the trademarks by BEHRINGER® nor affiliation of the trademark owners with BEHRINGER®. BEHRINGER® accepts no liability for any loss which may be suffered by any person who relies either wholly or in part upon any description, photograph or statement contained herein. Colours and specification may vary slightly from product. Products are sold through our authorised dealers only. Distributors and dealers are not agents of BEHRINGER® and have absolutely no authority to bind BEHRINGER® by any express or implied undertaking or representation. No part of this manual may be reproduced or transmitted in any form or by any means, electronic or mechanical, including photocopying and recording of any kind, for any purpose, without the express written permission of BEHRINGER Spezielle Studiotechnik GmbH. BEHRINGER® is a registered trademark.

ALL RIGHTS RESERVED. © 2004 BEHRINGER Spezielle Studiotechnik GmbH,
Hanns-Martin-Schleyer-Str. 36-38, 47877 Willich-Münchheide II, Germany.
Tel. +49 2154 9206 0, Fax +49 2154 9206 4903