

ULTRA-Q[®] PRO PEQ2200

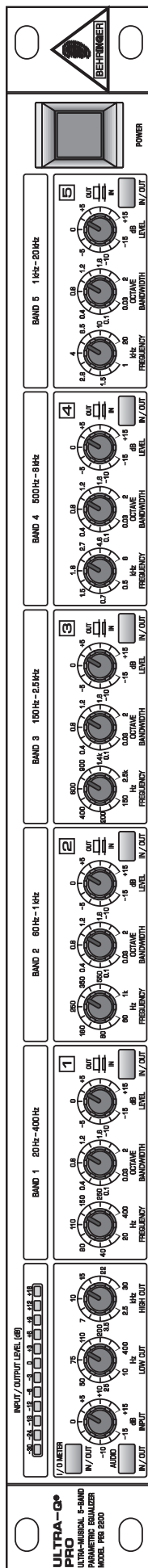

User's Manual

Version 1.2 September 2001

ENGLISH



www.behringer.com

SAFETY INSTRUCTIONS

CAUTION: To reduce the risk of electric shock, do not remove the cover (or back). No user serviceable parts inside; refer servicing to qualified personnel.



WARNING: To reduce the risk of fire or electric shock, do not expose this appliance to rain or moisture.



This symbol, wherever it appears, alerts you to the presence of uninsulated dangerous voltage inside the enclosure—voltage that may be sufficient to constitute a risk of shock.



This symbol, wherever it appears, alerts you to important operating and maintenance instructions in the accompanying literature. Read the manual.

DETAILED SAFETY INSTRUCTIONS:

All the safety and operation instructions should be read before the appliance is operated.

Retain Instructions:

The safety and operating instructions should be retained for future reference.

Heed Warnings:

All warnings on the appliance and in the operating instructions should be adhered to.

Follow instructions:

All operation and user instructions should be followed.

Water and Moisture:

The appliance should not be used near water (e.g. near a bathtub, washbowl, kitchen sink, laundry tub, in a wet basement, or near a swimming pool etc.).

Ventilation:

The appliance should be situated so that its location or position does not interfere with its proper ventilation. For example, the appliance should not be situated on a bed, sofa, rug, or similar surface that may block the ventilation openings, or placed in a built-in installation, such as a bookcase or cabinet that may impede the flow of air through the ventilation openings.

Heat:

The appliance should be situated away from heat sources such as radiators, heat registers, stoves, or other appliances (including amplifiers) that produce heat.

Power Source:

The appliance should be connected to a power supply only of the type described in the operating instructions or as marked on the appliance.

Grounding or Polarization:

Precautions should be taken so that the grounding or polarization means of an appliance is not defeated.

Power-Cord Protection:

Power supply cords should be routed so that they are not likely to be walked on or pinched by items placed upon or against them, paying particular attention to cords and plugs, convenience receptacles and the point where they exit from the appliance.

Cleaning:

The appliance should be cleaned only as recommended by the manufacturer.

Non-use Periods:

The power cord of the appliance should be unplugged from the outlet when left unused for a long period of time.

Debris and Liquid Entry:

Care should be taken that debris and/or liquids do not enter the enclosure through openings.

Damage Requiring Service:

The appliance should be serviced by qualified service personnel when:

- The power supply cord or the plug has been damaged; or
- Debris or liquid has entered the appliance; or
- The appliance has been exposed to rain; or
- The appliance does not appear to operate normally or exhibits a marked change in performance; or
- The appliance has been dropped, or the enclosure damaged.

Servicing:

The user should not attempt to service the appliance beyond that which is described in the operating instructions. All other servicing should be referred to qualified service personnel.

FOREWORD

Dear Customer,

Welcome to the team of ULTRA-Q PRO users and thank you very much for expressing your confidence in BEHRINGER products by purchasing this unit.

It is one of my most pleasant tasks to write this letter to you, because it is the culmination of many months of hard work delivered by our engineering team to reach a very ambitious goal: making an outstanding device better still. The ULTRA-Q PRO has for quite a long time been a standard tool used by numerous studios and PA rental companies. The task to improve one of our best-selling products certainly meant a great deal of responsibility, which we assumed by focusing on you, the discerning user and musician. It also meant a lot of work and night shifts to accomplish this goal. But it was fun, too. Developing a product usually brings a lot of people together, and what a great feeling it is when everybody who participated in such a project can be proud of what we've achieved.

It is our philosophy to share our joy with you, because you are the most important member of the BEHRINGER family. With your highly competent suggestions for new products you've greatly contributed to shaping our company and making it successful. In return, we guarantee you uncompromising quality (manufactured under ISO9000 certified management system) as well as excellent technical and audio properties at an extremely favorable price. All of this will enable you to fully unfold your creativity without being hampered by budget constraints.

We are often asked how we can make it to produce such high-grade devices at such unbelievably low prices. The answer is quite simple: it's you, our customers! Many satisfied customers means large sales volumes enabling us to get better conditions of purchase for components, etc. Isn't it only fair to pass this benefit back to you? Because we know that your success is our success, too!

I would like to thank all people whose help on "Project ULTRA-Q PRO" has made it all possible. Everybody has made very personal contributions, starting from the designers of the unit via the many staff members in our company to you, the user of BEHRINGER products.

My friends, it's been worth the trouble!

Thank you very much,

A handwritten signature in black ink, appearing to read 'U. Behringer', with a long horizontal flourish extending to the right.

Uli Behringer

ULTRA-Q PRO

Ultra-Musical 5-band Parametric Equalizer

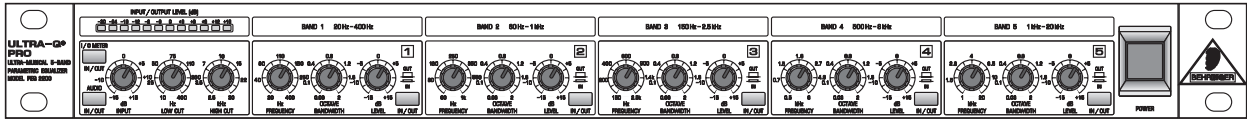

- ▲ Flexible equalization from gentle contouring to extreme correction to creative sound shaping for all recording, post-production or live applications
- ▲ High-precision state-variable filters with constant-Q characteristic
- ▲ Parallel filter architecture ensures minimal phase shifting
- ▲ Ultra low-noise 4580 audio operational amplifiers for outstanding audio performance
- ▲ Sweepable high- and low-pass filters remove unwanted frequencies
- ▲ In/out switch plus adjustable bandwidth per frequency band (bandwidth 0.03 octave – 2 octaves)
- ▲ Widely overlapping frequency bands allow extreme attenuation or boost
- ▲ Extremely accurate 12-segment LED input/output metering
- ▲ High-quality detented potentiometers and illuminated switches
- ▲ Power-up delay prevents dangerous “thumps”
- ▲ Relay-controlled hard bypass with auto bypass function in case of power failure
- ▲ High-quality components and exceptionally rugged construction for reliability and long life
- ▲ Servo-balanced inputs and outputs with gold-plated XLR and 1/4" TRS connectors
- ▲ High-performance BEHRINGER OT-1 output transformer retrofitable
- ▲ Manufactured under ISO9000 certified management system

TABLE OF CONTENTS

1. INTRODUCTION	6
2. THE DESIGN CONCEPT	7
2.1 High quality components and design	7
2.1.1 Failsafe relay	7
2.2 Inputs and outputs	7
2.2.1 Balanced inputs and outputs	7
2.2.2 Transformer balanced outputs (Optional)	7
3. INSTALLATION	7
3.1 Rack mounting	8
3.2 Mains voltage	8
3.3 Audio connections	8
4. CONTROLS	9
4.1 The front panel control elements	10
4.2 Rear panel control elements	11
5. TECHNICAL BACKGROUND	11
5.1 Introduction	11
5.2 The “Constant-Q” principle	12
5.3 The concept of parallel filters	12
5.4 Filter functions	12
5.4.1 The notch function	12
5.4.2 The roll-off function	13
6. APPLICATIONS	13
6.1 Introduction and basic settings	13
6.2 On phase shift and time delay	14
6.3 Using a frequency analyzer	14
6.4 Identifying problems by ear	15
7. EQUALIZERS AS CREATIVE AUDIO TOOLS	15
7.1 Effects of equalization on voice program	16
7.2 Effects of equalization on music program	17
8. SPECIAL APPLICATIONS	18
8.1 Equalizing a sound reinforcement system	18
8.2 Inserting an equalizer in the signal path	19
8.3 What equalizers can’t do	19
9. SPECIFICATIONS	20
10. WARRANTY	21

1. INTRODUCTION

With the BEHRINGER ULTRA-Q PRO you have purchased an extremely musical and flexible parametric equalizer. Our ULTRA-Q range of devices has been a hit ever since we introduced our first model about 5 years ago. This high-end equalizer is based on many years of experience and findings in filter technology and is used throughout the world in renowned studios, sound reinforcement systems as well as in broadcast and television studios. Improving the legendary ULTRA-Q even further was a real challenge, and we are proud of our success. The BEHRINGER ULTRA-Q PRO meets highest and no-compromise requirements in terms of operation, sound, specifications and workmanship.

Future-oriented BEHRINGER technology

Compared to its predecessor models, the ULTRA-Q PRO not only has additional features, but also comes with dramatically enhanced audio qualities. For example, it uses a refined filter concept and select components. The heart of the ULTRA-Q PRO is an extremely low-noise filter circuit based on our well-known state-variable filters that produce a highly transparent sound. In combination with the constant Q principle, the operational amplifiers 4580 and a sophisticated circuit topology, the ULTRA-Q PRO yields excellent noise and distortion properties!

State-of-the-art production processes

For the first time ever, the ULTRA-Q PRO is now manufactured with SMD components (Surface Mount Device). Using these sub-miniature components known from aeronautics does not only ensure extreme packing densities, but also improves the ULTRA-Q PRO's reliability.

Features of the BEHRINGER ULTRA-Q PRO

Parametric equalizers represent the most advanced form of equalization systems. Basically, the user has control over the three parameters that define the so-called Gaussian equalization curve: bandwidth, frequency and amplitude boost/cut. Unlike graphic equalizers which provide a series of adjacent frequency bands to approach a specific frequency, parametric equalizers allow for selecting a specific frequency directly. They can be used to realize complex frequency curves with highest precision. Although the acoustic results of specific equalizer settings cannot be predicted as easily as on graphic equalizers, parametric EQ's are professional audio tools of highest quality. It will certainly pay to invest some time to study their functioning principle and get a feel for the way in which they can be used to modify the program material.

The BEHRINGER ULTRA-Q PRO gives you a combination of all technical properties both of parametric equalizers and of narrow-band notch filters. With its excellent audio quality and outstanding specifications it is simply better than any conventional equalizer. The ULTRA-Q PRO can be used to make up for frequency response deficiencies and to creatively process any audio material, thus giving you undreamed-of equalization flexibility. It is a highly efficient and all-purpose tool both in creative audio processing in broadcast and television studios, in video post-production and on stage. Each of its five bands can be freely adjusted in quality: from extremely narrow to broad-band. The ULTRA-Q PRO is superior to graphic equalizers in all respects.

It also has two additional filters which enable you to adapt the entire frequency response to meet your specific application. These low and high-cut filters have a slope of 12 dB/oct. and can be varied in a wide frequency range. Practice has shown how important this feature is, as most acoustic problems are encountered in the extreme low and high frequency ranges. Typical frequency response, hum or feedback problems must be handled differently. The additional low and high-cut filters allow for a broad-band correction of the frequency curve, while the parametric filters can be used to process narrow frequency bands (mains hum, feedback, etc.).

The "Constant-Q" principle

One of the most important features any graphic or parametric equalizer has to offer is the independent control of the various filter parameters. The special state-variable filters of the ULTRA-Q PRO use the so-called "Constant Q" principle which prevents the parameters frequency, bandwidth and amplitude from influencing each other. In the same way, the mutual influence of the individual frequency bands is avoided, which is a fundamental requirement as it allows for clearly defined and repeatable filter settings.

The concept of parallel filters

Unlike conventional parametric equalizers the ULTRA-Q PRO features a parallel filter configuration, which offers a decisive advantage over series-type configurations: with parallel filters it is possible to reduce to a minimum the phase shifts and delays usually associated with filters.

Like all BEHRINGER devices, the ULTRA-Q PRO is based on a well thought-out concept and yields excellent technical data. Both signal-to-noise ratio, distortion products and, above all, its audio qualities have been optimized over long-term development and testing periods. The result is a parametric equalizer of the absolute high-end class.

 **The following operational manual will introduce you to the BEHRINGER ULTRA-Q PRO and its various functions. After reading the manual carefully, make sure it is always on hand for future reference.**

2. THE DESIGN CONCEPT

2.1 High quality components and design

The philosophy behind BEHRINGER products guarantees a no-compromise circuit design and employs the best choice of components. The operational amplifiers NJM4580 which are used in the ULTRA-Q PRO, are exceptional. They boast extreme linearity and very low distortion characteristics. To complement this design the choice of components includes high tolerance resistors and capacitors, detent potentiometers and several other stringently selected elements.

For the first time, the ULTRA-Q PRO PEQ2200 uses SMD technology (Surface Mounted Device). These sub-miniature components known from aerospace technology allow for an extreme packing density, plus the unit's reliability could be improved. Additionally, the unit is manufactured in compliance with a ISO9000 certified management system.

2.1.1 Failsafe relay

A failsafe relay has been incorporated into the design of the BEHRINGER ULTRA-Q, which automatically and silently bypasses the unit in the event of power supply disconnection or failure. This relay is also active at switch-on to isolate the ULTRA-Q PRO until the power rails have settled, thus preventing the possibility of a potentially damaging switch-on "thump".

2.2 Inputs and outputs

2.2.1 Balanced inputs and outputs

As standard, the BEHRINGER ULTRA-Q PRO is installed with electronically servo-balanced inputs and outputs. The new circuit design features automatic hum and noise reduction for balanced signals and thus allows for trouble-free operation, even at high operating levels. Externally induced mains hum etc. will be effectively suppressed. The automatic servo-function recognizes the presence of unbalanced connectors and adjusts the nominal level internally to avoid level differences between the input and output signals (correction 6 dB).

2.2.2 Transformer balanced outputs (Optional)

In contrast to electronic balancing, the use of transformer-balanced outputs offers the advantage of galvanic separation between units. Electrical potential differences and ground loops in audio installations do not therefore impair the performance of the units. The transformer-balanced outputs, commonly used in radio and TV engineering, can also be fitted retrospectively upon request. The BEHRINGER transformer OT-1 is designed to the highest exacting standards and is available as an accessory.

3. INSTALLATION

Your BEHRINGER ULTRA-Q PRO was carefully packed in the factory and the packaging was designed to protect the unit from rough handling. Nevertheless, we recommend that you carefully examine the packaging and its contents for any signs of physical damage, which may have occurred in transit.

👉 If the unit is damaged, please do not return it to us, but notify your dealer and the shipping company immediately, otherwise claims for damage or replacement may not be granted. Shipping claims must be made by the consignee.

3.1 Rack mounting

The BEHRINGER ULTRA-Q PRO fits into one standard 19" rack unit of space (1 3/4"). Please allow at least an additional 4" depth for the connectors on the back panel. Be sure that there is enough air space around the unit for cooling and please do not place the ULTRA-Q PRO on high temperature devices such as power amplifiers etc. to avoid overheating.

3.2 Mains voltage

Before you connect your ULTRA-Q PRO to the mains, please make sure that your local voltage matches the voltage required by the unit! The fuse holder on the female mains connector has 3 triangular markers, with two of these triangles opposing each other. Your ULTRA-Q PRO is set to the operating voltage printed next to these markers, and can be set to another voltage by turning the fuse holder by 180°. **CAUTION: this instruction does not apply to export models exclusively designed, e.g. for 115 V operation!**

👉 Please refer to the specifications for detailed information about specific voltage supplies!

3.3 Audio connections

The audio inputs and outputs on the BEHRINGER ULTRA-Q PRO are fully balanced. If possible, connect the unit to other devices in a balanced configuration to allow for maximum interference immunity.

👉 Please ensure that only qualified persons install and operate the ULTRA-Q PRO. During installation and operation the user must have sufficient electrical contact to earth. Electrostatic charges might affect the operation of the ULTRA-Q PRO!

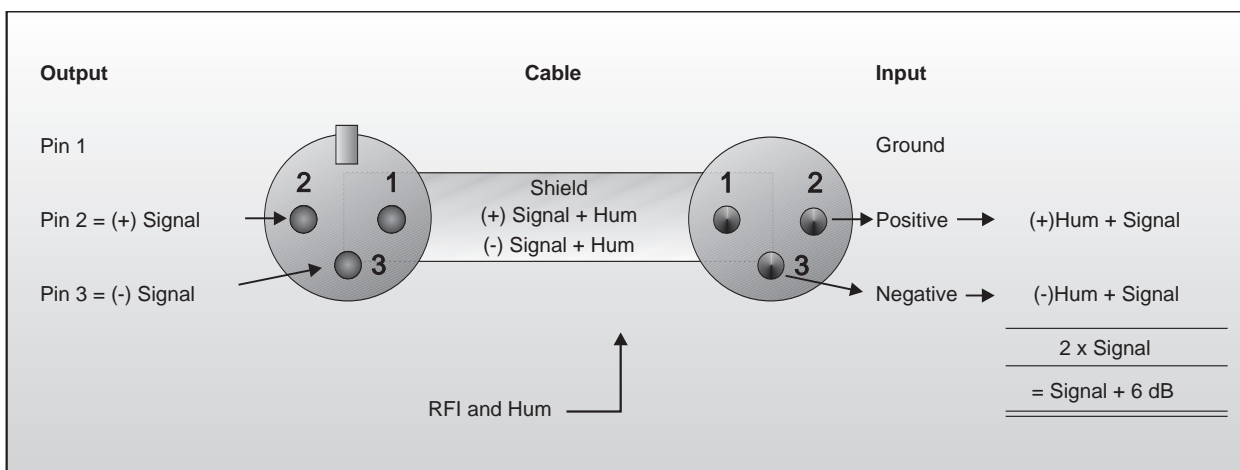

Fig. 3.1: Compensation of interference with balanced connections

Critical applications may require to build up a transformer-balanced configuration for the output signals, so as to avoid interference from ground loops or potential differences. For this purpose, we offer our high-quality output transformer OT-1 as a retrofit kit.

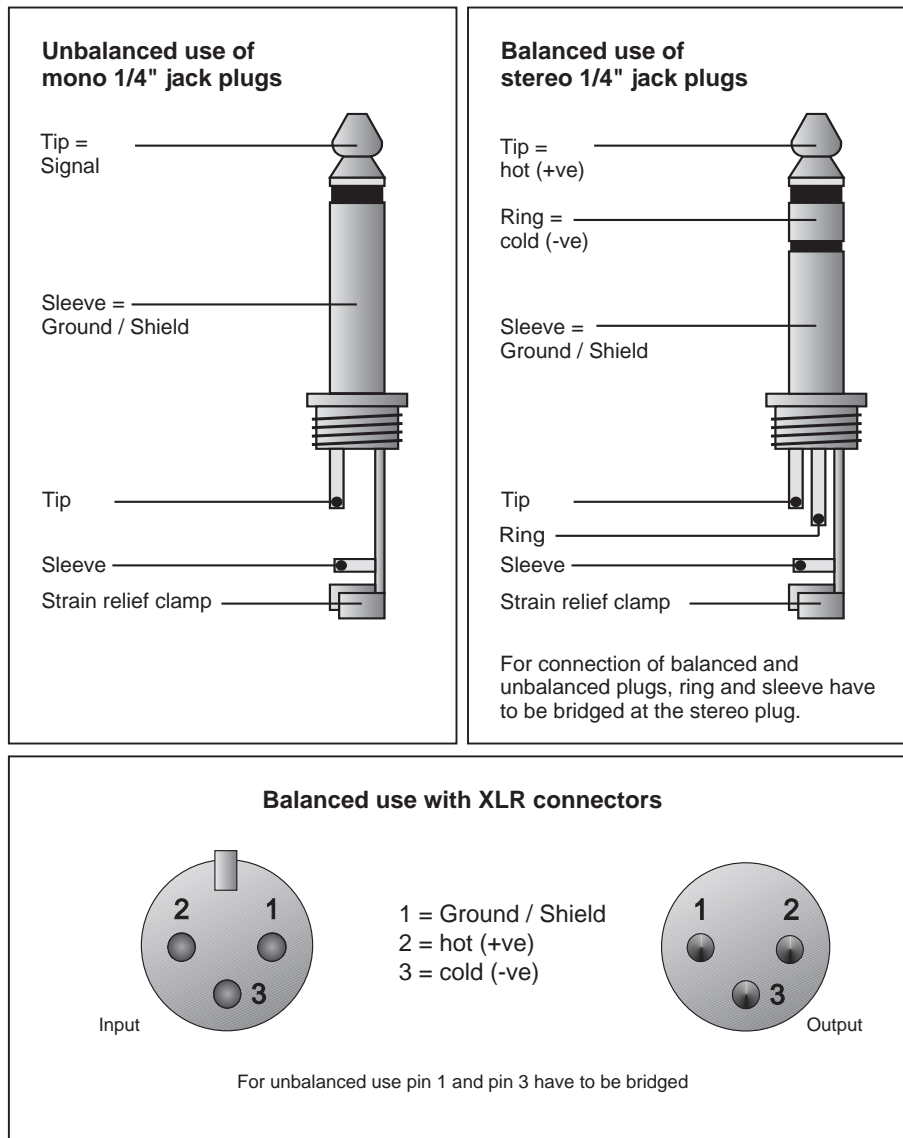

Fig. 3.2: Different plug types

 **Never use unbalanced XLR connections with microphone cables, as this would short-circuit any phantom power transmitted over these cables!**

4. CONTROLS

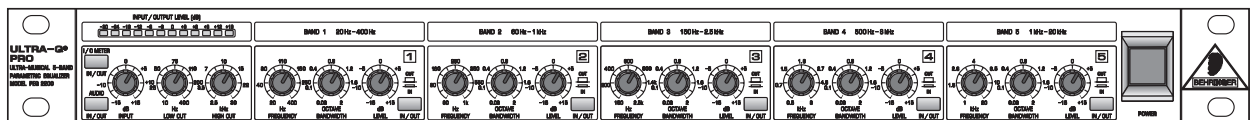

Fig. 4.1: ULTRA-Q PRO front panel

The BEHRINGER ULTRA-Q PRO has five parametric filters organized in 5 different frequency bands. In addition to that there are low cut and high cut filters. A 12-segment LED display shows the input or output level.

4.1 The front panel control elements

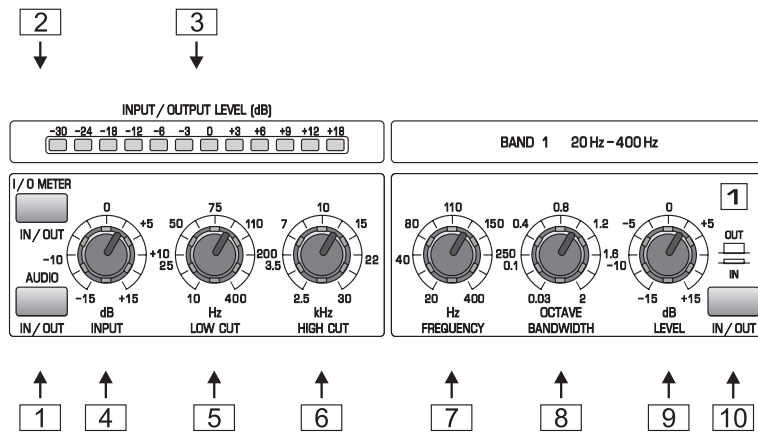

Fig. 4.2: Control elements on the front panel

- 1 The *AUDIO IN/OUT* switch is used to enable/disable the entire equalizer section in the audio path. The switch uses a relay-controlled hard-bypass function, i.e. as long as it is not pressed or if the unit is switched off, the inputs are directly connected to the outputs. The *AUDIO IN/OUT* switch allows for A/B comparisons between the processed and unprocessed signals.
 - 2 Use the *I/O METER IN/OUT* switch to select the input source. Press it to display the input level.
 - 3 The level meters are used to monitor the signal levels, so as to avoid distortion caused by overloading. Depending on the setting of the *I/O METER IN/OUT* switch, the display shows the input or output level (switch pressed). The upper red LED lights up as soon as a level of about +18 dBu (i.e. 3 dB below clipping) is reached.
- ⚠ Please note that extreme boost settings in combination with a high input level can overload the unit. In such a case, the input level must be reduced with the INPUT control.**
- 4 The *INPUT* control determines the input level applied to the device and can be set within a range from -15 to +15 dB.
 - 5 The *LOW CUT* control adjusts the lower cutoff frequency of the ULTRA-Q PRO. The high-pass filter can be tuned from 10 to 400 Hz. In the 10 Hz position the signal passes unchanged.
 - 6 The *HIGH CUT* control adjusts the upper cutoff frequency of the ULTRA-Q PRO. The low-pass filter can be tuned from 2.5 to 30 kHz. In the 30 kHz position the signal passes unchanged.
 - 7 The *FREQUENCY* control selects the filter's center frequency, which can be freely chosen from within the frequency range of the associated band.
 - 8 The *BANDWIDTH* control determines the slope or quality of the filter. Settings from 0.03 (Q=43) to 2 octaves (Q=0,67) are possible.
 - 9 The *LEVEL* control determines the amount of level boost/cut. The setting range is from -15 to +15 dB.
 - 10 The individual *IN/OUT* switches allow for enabling/disabling specific bands in the audio path.

4.2 Rear panel control elements

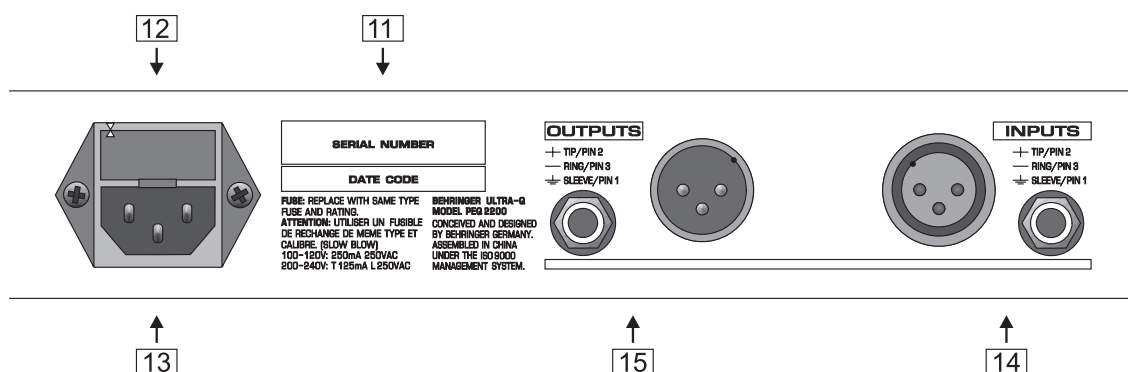

Fig. 4.3: Rear panel elements of the ULTRA-Q

- 11 **SERIAL NUMBER.** Please take the time to have the warranty card filled out completely by your specialized dealer and return it within 14 days after the date of purchase, so as to be entitled to benefit from our extended warranty. Or use our online registration option available on the Internet at www.behringer.com.
- 12 **FUSE HOLDER / VOLTAGE SELECTOR.** Please make sure that your local voltage matches the voltage indicated on the unit, before you attempt to connect and operate the ULTRA-Q PRO. Blown fuses may only be replaced by fuses of the same type and rating.
- 13 **MAINS CONNECTION.** Use the enclosed power cord to connect the unit to the mains. Please also note the instructions given in the “INSTALLATION” chapter.
- 14 **AUDIO IN.** These are the audio inputs of your ULTRA-Q PRO, available both as balanced 1/4" jack and XLR connectors.
- 15 **AUDIO OUT.** These are the audio outputs of your ULTRA-Q PRO. Matching phone jack and XLR connectors are wired in parallel.

5. TECHNICAL BACKGROUND

5.1 Introduction

The ULTRA-Q PRO combines the technical properties of both parametric equalizers and narrow-band notch filters. Owing to its variable bandwidth ranging from 0.03 to 2 octaves, it is much more flexible than conventional EQs. Its innovative circuit topology gives you the appropriate tools to solve acoustic problems of any kind.

The ULTRA-Q PRO also has two additional filters which enable you to adapt the entire frequency response to meet your specific application. These low and high-cut filters have a slope of 12 dB/oct. and can be varied in a wide frequency range. Practice has shown how important this feature is, as most acoustic problems are encountered in the extreme low and high frequency ranges. Typical frequency response, hum or feedback problems must be handled differently. The additional low and high-cut filters allow for a broad-band correction of the frequency curve, while the parametric filters can be used to process narrow frequency bands (mains hum, feedback, etc.).

The control elements are clearly and logically arranged. Turn the BANDWIDTH control counter-clockwise to adjust the minimum quality of 0.03 octaves, and clockwise to adjust the maximum bandwidth. Turn the LEVEL control clockwise to raise, or counter-clockwise to lower the filter amplitude. The FREQUENCY control works on the same principle.

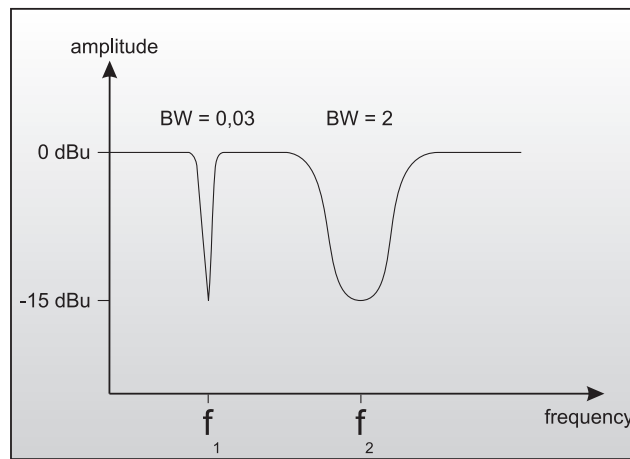

Fig. 5.1: Various filter qualities

During operation you can switch on and off the individual bands to make an A/B comparison between the equalizer effect and the unprocessed signal. Due to the complex and partly difficult settings of parametric equalizers such a facility is indispensable. Still, most parametric EQ's have no band-specific in/out switches which makes it difficult to keep track of what the various switches and controls do.

5.2 The “Constant-Q” principle

One of the most important features any graphic or parametric equalizer has to offer is the independent control of its various parameters. The special state-variable filters of the ULTRA-Q PROs use the so-called “Constant Q” principle which prevents the parameters “frequency”, “bandwidth” and “amplitude” from influencing each other. In the same way, the mutual influence of the individual frequency bands is avoided, which is a fundamental requirement as it allows for clearly defined and repeatable filter settings. When several filters are used simultaneously, the resulting overall filter curve can be calculated by adding/subtracting the single band-specific filter curves.

5.3 The concept of parallel filters

Unlike conventional parametric equalizers the ULTRA-Q PRO features a parallel filter configuration, which offers a decisive advantage over series-type configurations: with parallel filters it is possible to reduce to a minimum the phase shifts and delays usually associated with filters, which is the reason why the ULTRA-Q PRO is such a “musical” device.

Naturally, this concept, too, is subject to a few limitations: unlike series-type filter configurations the concept of parallel filters allows only to a limited extent for an extreme boost/cut of frequencies. However, as extreme settings are usually the result of an improperly adjusted sound image, it is imperative that deficiencies of this kind be identified and eliminated, before the actual “musical” fine-tuning of the sound image takes place. Still, extreme settings can be realized by overlapping the frequencies of the individual bands.

5.4 Filter functions

5.4.1 The notch function

With “notching” or “peaking” we describe the specific attenuation of single frequencies or frequency bands. A notch filter produces an effect that is the opposite to a band-pass filter.

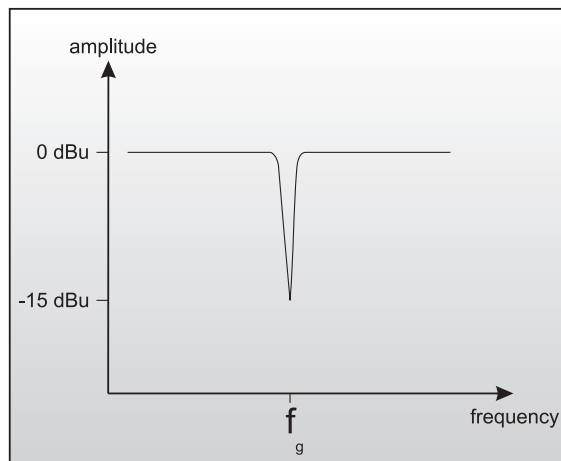

Fig. 5.2: Typical notch function

5.4.2 The roll-off function

With “roll-off” we usually refer to a limitation of frequency bands by means of high or low-pass filters. The low and high-cut filters on the ULTRA-Q PRO have a slope of 12 dB/oct. and can be varied within a wide frequency range.

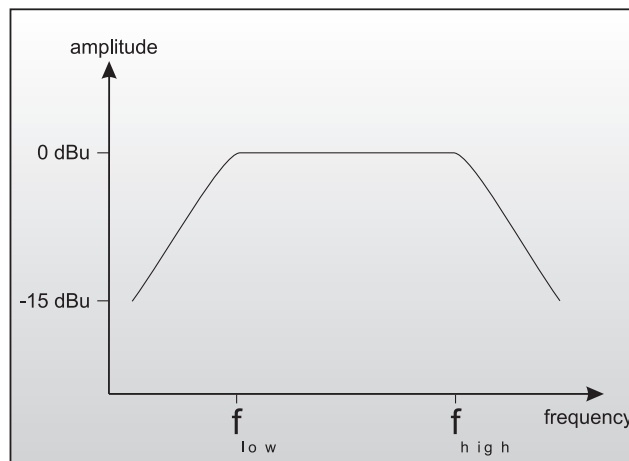

Fig. 5.3: Typical roll-off function

6. APPLICATIONS

6.1 Introduction and basic settings

In contrast to graphic equalizers with their fixed frequencies and qualities, parametric EQs allow for setting all filter parameters, such as center frequency, bandwidth and amplitude.

The possibility of determining both the bandwidth and center frequency as well as frequency boost/cut in five separate bands, adds a new dimension to equalization systems. The high precision of the filters used in the ULTRA-Q PRO enables you to fine-tune frequencies and process your audio material in a such a creative way that has been impossible up to now.

The frequency bands are grouped so as to cover the entire audio range from 20 Hz to 20 kHz, with the frequency ranges of the single bands overlapping each other. Thus, you can, for instance, set two bands to one center frequency.

Parametric equalizers can be used both as separate signal processors and in combination with conventional graphic 1/3-oct. equalizers, for example, in a sound reinforcement system: while the 1/3-oct. equalizer does the “rough” correction of the overall frequency response, the ULTRA-Q PRO could be used to fine-tune the sound.

“Notching out” specific interference frequencies and narrow-band resonances (uncontrolled frequency peaks) is one of the ULTRA-Q PRO’s major tasks: by tuning the EQ in to the precise trouble frequency, interference such as hum and noise caused by air conditioners, etc. can be eliminated without affecting adjacent frequency ranges. Basic acoustic problems usually encountered in studios and stage systems can be solved elegantly with the ULTRA-Q PRO.

Owing to the special parallel filter configuration, the filter functions of the BEHRINGER ULTRA-Q PRO can be combined to achieve a greater boost/cut of amplitudes than with one single filter. To do so, simply adjust two filters to the same center frequency and bandwidth. With both LEVEL controls set to their left or right stop position, the amount of amplitude cut or boost is doubled.

It has proven useful in practice to start with all controls set to mid-travel position and all IN/OUT switches OUT, so as to avoid even before powering up the system that applied input signals with high amplitudes are raised in level by the ULTRA-Q PRO and hence lead to distortion or damage in subsequent devices or speakers, or to annoying feedback in PA systems caused by improper basic settings.

Once the filter curve of your choice has been set, it can be necessary to correct the overall level. If the filter setting used raises the overall level, you can use the INPUT control to lower it again and avoid possible distortion.

When the overall level is lowered by the filter setting, the INPUT control allows for raising it by a maximum amount of +20 dB. Use the adjacent IN/OUT switch for a direct A/B comparison, so that you can estimate the required amount of level compensation.

6.2 On phase shift and time delay

Any analog filter, be it graphic or parametric, produces a certain amount of phase shift.

Particularly in narrow-band filters this phase shift leads to specific delay of the audio signal: the narrower the filter and the higher the gain, the greater the time delay. In certain applications, the effect on the sound image can be annoying.

Although the ULTRA-Q PRO, owing to its unique concept, produces considerably less phase shift and hence time delay than conventional parametric equalizers, this effect should nevertheless be taken into account.

 **Please also note that filters show a natural tendency to produce a “ringing” sound as their bandwidth is narrowed, an effect that is caused by system-intrinsic noise modulation that occurs with any kind of filter. It is therefore recommended that you set all filters not in use to a mid-travel position or simply switch them off to minimize these side effects as effectively as possible.**

6.3 Using a frequency analyzer

A frequency analyzer matching the ULTRA-Q PRO in that it provides the same narrow bandwidth (1/30 or 0.03 octaves) is a perfect tool to find optimum filter settings. If such a device is not available, a conventional 1/3-oct. analyzer will do the job. For example, to reduce the risk of feedback in a sound reinforcement system, while raising the overall level, you can use the 1/3-oct. frequency bands of the analyzer to identify the feedback resonance frequency. Now, select the same frequency on the ULTRA-Q PRO using the FREQUENCY control, set the BANDWIDTH control to its left stop position (minimum bandwidth) and cut the amplitude by 6-10 dB. Switch on the filter and fine-tune the center frequency until feedback disappears. Then, raise the amplitude just below the feedback-producing level. In this way, you can control the resonance frequency, while affecting adjacent frequencies (and hence the overall sound image) to the least extent possible.

If you have a spectrum analyzer available with a resolution better than 1/12-octave, you can identify the resonance frequency with much greater precision, which makes it easier to set up the ULTRA-Q PRO.

 **We would like to draw your attention to our ULTRA-CURVE, a device which combines a digital 31-band graphic equalizer with an on-board analyzer. Please ask your retailer for further information or contact BEHRINGER directly.**

Still, you can achieve satisfying results even without a frequency analyzer. In most cases, the sound image can be fine-tuned by ear—with a little bit of patience.

In general, feedback frequencies are narrow-band in their character. It is this fact that makes the ULTRA-Q PRO with its narrow-band filters the ideal audio tool. However, it should be noted that in most cases it is not necessary to cut the resonance frequency completely when feedback occurs. More importantly, it should be identified as precisely as possible.

The theoretical basics of feedback resonances are quite complex. Of particular importance are the bandwidth of the resonance frequencies, their phase characteristics and of course the room acoustics.

As already mentioned, any form of boost/cut of narrow frequency bands causes phase shift in the audio path. The feedback susceptibility depends both on the amplitude and on the phase characteristics of the feedback loop, a change in amplitude or in phase reduces the risk of feedback. So, if you use a narrow-band equalizer, the desired change in feedback behavior can be achieved not only by lowering the amplitude but also by modifying the phase position.

 **We would like to draw your attention to our FEEDBACK DESTROYER, a device that identifies and eliminates up to 24 frequencies automatically. Please ask your retailer for further information or contact BEHRINGER directly.**

In addition to narrow-band “notching” applications, the BEHRINGER ULTRA-Q PRO can also be used for broad-band corrections of the frequency response, for example, to simulate a simple tone control circuit, a frequency crossover network for speaker systems, the sound of specific speaker systems, or simply to modify sounds dramatically (telephone voice). All of these applications have been quite difficult to realize up to now.

In practice, broad-band frequency correction is the most common application in the field of sound reinforcement systems, for example, to enhance the low-range response and/or to make up for high-frequency loss caused by room acoustics. Simply use two or three broad-band parametric filters in combination with the two low and high-cut filters to achieve the desired frequency correction. Another two or three bands could then be used to minimize feedback or make up for room resonances.

Apart from solving problems of room acoustics, the ULTRA-Q PRO also helps you cope with the problems of microphone positioning and direction, or improve intelligibility by “tweaking” the response curve.

Since speaker systems usually have no flat response curve and need to be positioned in accordance with optical rather than acoustical criteria, the resulting additional problems of room acoustics make the equalizer an indispensable tool.

6.4 Identifying problems by ear

Maybe you think that frequencies causing problems can best be identified by tuning a narrow-band filter over a specific frequency range. However, practice has shown that it is easier to identify them by making them heard, rather than find out which frequencies are lacking. It is therefore useful not to lower the amplitude of the narrow-band filter, but to raise it first in order to identify the frequency that causes the trouble. Once this frequency has been identified, you simply reduce the filter in level.

7. EQUALIZERS AS CREATIVE AUDIO TOOLS

The ULTRA-Q PRO is an indispensable audio tool for application in recording studios, stage plays or radio dramas. You can use it to distort voices, create telephone sounds and filter instruments to make them fit into the mix-down.

The tables printed below give you some clues as to the acoustic significance of specific frequencies. Please use them as suggestions for your own experiments with the ULTRA-Q PRO.

7.1 Effects of equalization on voice program

Center frequency (Hz) 1/3 octave	Effect on voice
40 to 125	Sense of power in some outstanding bass singers.
160 to 250	Voice fundamentals.
315 to 500	Important for voice quality.
630 to 1k	Important for voice naturalness. Too much boost in the 315 to 1 kHz range produces a telephone-like quality.
1.25k to 4k	Voice fricatives-accentuation of vocals. Important to speech intelligibility. Too much boost between 2 and 4 kHz can mask certain speech sounds e.g. "m", "b", and "v" can become indistinguishable. Too much boost anywhere between 1 and 4 kHz can produce "listening fatigue". Vocals can be highlighted by slightly boosting the vocal at 3 kHz and at the same time slightly dipping the instruments at the same frequency.
5k to 8k	Accentuation of voice. The range from 1.25 to 8 kHz governs the clarity of voice.
10k to 16k	Too much boost causes sibilance.

Tab. 7.1: Effects of equalization on voice reproduction

7.2 Effects of equalization on music program

Center frequency (Hz) 1/3 octave	Effects on music
31 to 63	Fundamentals of bass drum, tuba, double bass and organ. These frequencies give music a sense of power. If over-emphasised they make the music "muddy". The 50 or 60 Hz band is also used to reject AC mains hum.
80 to 125	Fundamentals of lower tympani. Too much boost produces excessive "boom". 100 or 125 Hz are also used for hum rejection.
160 to 250	Drum and lower bass. Too much boost produces excessive "boom". Also useful for 3rd harmonic mains hum rejection.
315 to 500	Fundamentals of strings and percussion.
630 to 1k	Fundamentals and harmonics of strings, keyboards and percussion. Boosting the 600 to 1 kHz range can make instruments sound horn-like.
1.25k to 4k	Drums, guitar, accentuation of vocals, strings and bass. Too much boost in the 1 to 2 kHz range can make instruments sound tinny. Too much boost anywhere between 1 to 4 kHz can produce "listening fatigue".
5k to 8k	Accentuation of percussion, cymbals and snare drum. Reduction at 5 kHz makes overall sound more distant and transparent. Reduction of tape hiss and system noise. The 1.25 to 8 kHz governs clarity and definition.
10k to 16k	Cymbals and overall brightness. Too much boost causes sibilance. Reduction of tape hiss and system noise.

Tab. 7.2: Effects of equalization on music reproduction

8. SPECIAL APPLICATIONS

8.1 Equalizing a sound reinforcement system

Before you insert an equalizer in your sound reinforcement system, you should clearly define its tasks. If you fail to set up the EQ properly, it might deteriorate the sound image more than if you used no sound-processing device at all.

In a sound reinforcement system equalizers are used in three major areas of application:

1. Reducing the risk of feedback, while increasing the overall volume level.
2. Improving the natural sound of music.
3. Improving the intelligibility of speech.

It is quite obvious that compromises must be made to meet these requirements. In rooms with poor acoustics or a high level of background noise, both natural sound and acoustic power can usually not be realized simultaneously. Priority must be given to one of these quality-improving measures.

However, it should be noted that even a perfectly natural sound is useless if the audience has difficulties understanding what a speaker says, for example at an election campaign rally!

Before you start equalizing your system it will be useful to play back some music or speech program without equalization. If the sound is distorted you should first try to eliminate this problem. In order to get a feel for the room acoustics it might be helpful to “sweep” a sine tone generator over the entire audio range (i.e. the frequency range from 20 Hz to 20 kHz), which is better than playing back a signal consisting of pink noise, as it will enable you to identify “weak points” (room resonances, distortion, rattling noise) of both system and location. In particular, the critical range between 2 and 4 kHz should be tested (if required, use the BEHRINGER ULTRA-Q PRO as a band-pass filter to limit the frequency range). If you detect any problems, these are definitely caused by the system itself and should not be fixed with an equalizer!

Finally, use the ULTRA-Q PRO to fine-tune the system.

 **If extreme equalizer settings are necessary to achieve a usable frequency response, the alarm bell should start ringing!**

This does not mean that such settings should generally not be used, often enough they cannot be avoided if the room acoustics are poor. Nevertheless, you should always try to change the room acoustics before you start “tweaking” the response curve drastically.

Once the basic setting has been found, you can fine-tune the system using music and speech signals. If you own a so-called real-time analyzer (RTA) make sure that the measuring microphone is properly positioned. It should be placed directly within the dispersion field of the sound system without being disturbed by acoustic characteristics of the room. Avoid placing it behind curtains, less than 1 m away from the walls, or on an open balcony, as this would impair your measurements.

We recommend that you move the measuring mic on a circular line in front of the stage, so that you can compare the measured results. In this context it should be made sure that the frequency response diagrams do not differ excessively from each other. If you encounter any problems, change the position of the measuring mic or check the system for proper phase.

Please verify that any background noise is at least 6 dB (better 10 dB) lower in level than your operating level; otherwise you cannot trust your measurements!

Once the system has been adjusted as accurately as possible to yield the desired response curve, walk around in the audience area and listen to the sound produced at various places. Remember to give your hearing some pauses during the test and use different music or speech programs, so that you get a feel for the response characteristics of the sound system.

It takes a lot of time and patience to set up an equalizer properly!

Additionally, you could experiment with a stage or house microphones directly connected to the analyzer, as this will give you some clues as to local reflections, acoustic resonances and the lateral dispersion characteristics of the speakers. Once the overall adjustment of the sound system has been completed, any further corrections should not be made on the system itself but in the respective channels of the mixing console, in particular, when you find that certain microphones are susceptible to feedback.

8.2 Inserting an equalizer in the signal path

The best point to insert the ULTRA-Q PRO in the signal path depends on the task on hand: basically, it can be inserted in the line insert points of the mixing console, subgroup inserts, subgroup outputs, effect paths or between signal processor(s) and mixing console / power amp, etc.

If you use a delay line unit (e.g. used in sound systems with additional room speakers) to make up for run-time differences, the ULTRA-Q PRO can be inserted either before or after the delay line unit.

If several similar speaker systems are controlled simultaneously (e.g. in a conference room), and if these systems are positioned at different distances to the stage, you can use a delay line unit with multiple outputs providing different delay times. In such a case the ULTRA-Q PRO should be inserted before the delay line unit.

In complex sound reinforcement systems comprising different speakers located in varying acoustic environments (e.g. theaters with front speakers, various side-fill speakers and/or balcony speakers) each single time-delayed channel should be equipped with a separate ULTRA-Q PRO, as this is the only way to make provision for varying room acoustic and to adapt the speakers specifically.

8.3 What equalizers can't do

Equalizers are not a miracle cure for poor audio systems, but can be highly useful and efficient audio tools to musically fine-tune such a system. Fine-tuning often delivers astounding results in terms of acoustic power and overall sound quality. Equalizers are definitely the most important accessories of your audio system. They can work wonders when they are used properly, just as the old saying goes:

It's the tone that makes the music!

9. SPECIFICATIONS

AUDIO INPUT

Connectors	XLR and 1/4" jack
Type	RF filtered, servo-balanced input
Impedance	50 kOhm balanced, 25 kOhm unbalanced
Nominal operating level	+4 dBu/-10 dBV switchable
Max. input level	+21 dBu balanced and unbalanced
CMRR	typ. 40 dB, >55 dB @ 1 kHz

AUDIO OUTPUT

Connectors	XLR and 1/4" jack
Type	electronically servo-balanced output stage
Impedance	60 Ohm balanced, 30 Ohm unbalanced
Max. output level	+21 dBu, +20 dBm balanced and unbalanced

SYSTEM SPECIFICATIONS

Frequency response	18 Hz to 30 kHz, +/- 3 dB
Noise	>97 dBu, unweighted, 22 Hz to 22 kHz
THD	0.002 % typ. @ +4 dBu, 1 kHz, Gain 1
IMD	0.01 % typ. SMPTE

ROLL-OFF FILTER SECTION

Type	12 dB/oct., butterworth
Low cut	variable (10 Hz to 400 Hz)
High cut	variable (2.5 kHz to 30 kHz)

PARAMETRIC FILTER SECTION

Type	state-variable parametric filter
Level	variable (-15 dB to + 15 dB)
Frequency	band 1: 20 Hz to 400 kHz band 2: 60 Hz to 1 kHz band 3: 150 Hz to 2.5 kHz band 4: 500 Hz to 8 kHz band 5: 1 kHz to 20 kHz
Bandwidth	variable (0.03 to 2 octaves)

FUNCTION SWITCHES

Audio in/out	relay controlled hard-wire bypass
I/O meter in/out	switches the meter display from input to output
In/Out	activates each filter bank

INDICATORS

Input/output level	12-segment LED display: -30/-24/-18/-12/-6/-3/0/+3/+6/+9/+12/+18 dB
Function switch	LED indicator of every switch

POWER SUPPLY

Mains voltages	USA/Canada	120 V ~, 60 Hz
	U.K./Australia	240 V ~, 50 Hz
	Europe	230 V ~, 50 Hz
	General Export Model	100 - 120 V ~, 200 - 240 V ~, 50 - 60 Hz
Power consumption	max. 12 Watts	
Fuse	100 - 120 V ~: T 250 mA H	
	200 - 240 V ~: T 125 mA H	
Mains connection	standard IEC receptacle	

PHYSICAL

Dimension	1 3/4" (44.5 mm) x 19" (482.6 mm) x 8 1/2" (217 mm)
Net weight	3.0 kg
Shipping weight	4.2 kg

BEHRINGER is constantly striving to maintain the highest professional standards. As a result of these efforts, modifications may be made from time to time to existing products without prior notice. Specifications and appearance may differ from those listed or shown.

10. WARRANTY

§ 1 WARRANTY CARD/ONLINE REGISTRATION

To be protected by the extended warranty, the buyer must complete and return the enclosed warranty card within 14 days of the date of purchase to BEHRINGER Spezielle Studiotechnik GmbH, in accordance with the conditions stipulated in § 3. Failure to return the card in due time (date as per postmark) will void any extended warranty claims.

Based on the conditions herein, the buyer may also choose to use the online registration option via the Internet (www.behringer.com or www.behringer.de).

§ 2 WARRANTY

1. BEHRINGER (BEHRINGER Spezielle Studiotechnik GmbH including all BEHRINGER subsidiaries listed on the enclosed page, except BEHRINGER Japan) warrants the mechanical and electronic components of this product to be free of defects in material and workmanship for a period of one (1) year from the original date of purchase, in accordance with the warranty regulations described below. If the product shows any defects within the specified warranty period that are not due to normal wear and tear and/or improper handling by the user, BEHRINGER shall, at its sole discretion, either repair or replace the product.

2. If the warranty claim proves to be justified, the product will be returned to the user freight prepaid.

3. Warranty claims other than those indicated above are expressly excluded.

§ 3 RETURN AUTHORIZATION NUMBER

1. To obtain warranty service, the buyer (or his authorized dealer) must call BEHRINGER (see enclosed list) during normal business hours **BEFORE** returning the product. All inquiries must be accompanied by a description of the problem. BEHRINGER will then issue a return authorization number.

2. Subsequently, the product must be returned in its original shipping carton, together with the return authorization number to the address indicated by BEHRINGER.

3. Shipments without freight prepaid will not be accepted.

§ 4 WARRANTY REGULATIONS

1. Warranty services will be furnished only if the product is accompanied by a copy of the original retail dealer's invoice. Any product deemed eligible for repair or replacement by BEHRINGER under the terms of this warranty will be repaired or replaced within 30 days of receipt of the product at BEHRINGER.

2. If the product needs to be modified or adapted in order to comply with applicable technical or safety standards on a national or local level, in any country which is not the country for which the product was originally developed and manufactured, this modification/adaptation shall not be considered a defect in materials or workmanship. The warranty does not cover any such modification/adaptation, irrespective of whether it was carried out properly or not. Under the terms of this warranty, BEHRINGER shall not be held responsible for any cost resulting from such a modification/adaptation.

3. Free inspections and maintenance/repair work are expressly excluded from this warranty, in particular, if caused by improper handling of the product by the user.

This also applies to defects caused by normal wear and tear, in particular, of faders, potentiometers, keys/buttons and similar parts.

4. Damages/defects caused by the following conditions are not covered by this warranty:

- ▲ misuse, neglect or failure to operate the unit in compliance with the instructions given in BEHRINGER user or service manuals.
- ▲ connection or operation of the unit in any way that does not comply with the technical or safety regulations applicable in the country where the product is used.
- ▲ damages/defects caused by force majeure or any other condition that is beyond the control of BEHRINGER.

5. Any repair or opening of the unit carried out by unauthorized personnel (user included) will void the warranty.

6. If an inspection of the product by BEHRINGER shows that the defect in question is not covered by the warranty, the inspection costs are payable by the customer.

7. Products which do not meet the terms of this warranty will be repaired exclusively at the buyer's expense. BEHRINGER will inform the buyer of any such circumstance. If the buyer fails to submit a written repair order within 6 weeks after notification, BEHRINGER will return the unit C.O.D. with a separate invoice for freight and packing. Such costs will also be invoiced separately when the buyer has sent in a written repair order.

§ 5 WARRANTY TRANSFERABILITY

This warranty is extended exclusively to the original buyer (customer of retail dealer) and is not transferable to anyone who may subsequently purchase this product. No other person (retail dealer, etc.) shall be entitled to give any warranty promise on behalf of BEHRINGER.

§ 6 CLAIM FOR DAMAGES

Failure of BEHRINGER to provide proper warranty service shall not entitle the buyer to claim (consequential) damages. In no event shall the liability of BEHRINGER exceed the invoiced value of the product.

§ 7 OTHER WARRANTY RIGHTS AND NATIONAL LAW

1. This warranty does not exclude or limit the buyer's statutory rights provided by national law, in particular, any such rights against the seller that arise from a legally effective purchase contract.

2. The warranty regulations mentioned herein are applicable unless they constitute an infringement of national warranty law.

The information contained in this manual is subject to change without notice. No part of this manual may be reproduced or transmitted in any form or by any means, electronic or mechanical, including photocopying and recording of any kind, for any purpose, without the express written permission of BEHRINGER Spezielle Studiotechnik GmbH.

BEHRINGER, ULTRA-Q, ULTRA-CURVE and FEEDBACK DESTROYER are registered trademarks.

ALL RIGHTS RESERVED. © 2001 BEHRINGER Spezielle Studiotechnik GmbH.

BEHRINGER Spezielle Studiotechnik GmbH, Hanns-Martin-Schleyer-Str. 36-38, 47877 Willich-Münchheide II, Germany

Tel. +49 (0) 21 54 / 92 06-0, Fax +49 (0) 21 54 / 92 06-30