

*Operation
Manual*

PROTEUS 1000



PROTEUS 1000

Operation Manual

©2002, E-MU Systems, Inc. d.b.a. E-MU / ENSONIQ. All rights reserved.

FI12309 Rev. A

E-MU World Headquarters

E-MU / ENSONIQ

P.O. Box 660015

Scotts Valley, CA USA

95067-0015

Telephone: 831-438-1921

Fax: 831-438-8612

Internet: www.emu.com

Europe, Africa, Middle East

E-MU / ENSONIQ

Suite 6, Adam Ferguson House

Eskmills Industrial Park

Musselburgh, East Lothian

Scotland, EH21 7PQ

Tel: +44 (0) 131-653-6556

Fax: +44 (0) 131-665-0473

The following are registered worldwide trademarks owned and/or exclusively licensed by E-MU Systems, Inc.: E-MU® and E-MU Systems®. All other trademarks are the property of their respective holders.

Important Notice:

In order to obtain warranty service on your Proteus 1000 unit, the serial number sticker must be intact and you must have a sales receipt or other proof of purchase. If there is no serial number sticker on Proteus 1000, please contact E-MU Systems at once.

This product is covered under one or more of the following U.S. patents: 4,404,529; 4,506,579; 4,699,038; 4,987,600; 5,013,105; 5,072,645; 5,111,727; 5,144,676; 5,170,367; 5,248,845; 5,303,309; 5,317,104; 5,342,990; 5,430,244 and foreign patents and/or pending patents. All other trademarks belong to their respective companies. Specifications and features are subject to change without notice.

Table of Contents

Introduction	1
Product Description.....	1
Important Safety Instructions	3
Foreign Language Warnings - German	6
Foreign Language Warnings - French	9
Setup	13
Unpacking.....	13
Connection Instructions	14
Basic Setup	14
Studio Setup	15
Power Up!	16
Instant Gratification.....	17
Playing Demo Sequences	17
Auditioning Presets	17
Selecting and Quick Editing Presets	18
Basic Operations	21
Front Panel.....	21
Volume Control	21
Master Button	21
Edit Button	21
Control Button	21
Audition Button	22
Left/Right Cursor Buttons	22
Multisetup Button	22
Save/Copy Button	22
Home/Enter Button	23
Data Entry Control	23

Front Panel Controller Modes	23
Real-time Control	23
Quick Edit	24
Deep Edit Mode	24
Main Screen.....	26
MIDI Channel Selection	26
Preset Selection	26
Channel Volume	27
Channel Pan	28
Sound Navigator.....	29
Preset Category	29
Instrument Category	29
Multitimbral Operation	30
Multisetup Menu	31
Multisetups.....	31
Restoring Multisetups	32
Saving & Naming Multisetups	32
Multitimbral Sequencing.....	34
Master Menu	35
Defining Master Parameters	36
Transpose/Tune	36
Bend Range	36
Velocity Curve	37
Mix Output	37
Master Effects	39
Effects Mode	39
Effects Multi Mode Control	39
Master FXA Algorithm	40
A Effect Types	40
FXA Parameters: Decay/HF Damping FxB -> FxA	41
FXA Send Amounts	41
Master FXB Algorithm	41
B Effect Types	42
FXB Parameters: Feedback/LFO Rate Delay Time	42
FXB Send Amounts	42
MIDI Parameters	43
MIDI Mode	43
MIDI SysEx ID	43
MIDI Enable	44
MIDI Program Change -> Preset	44
Receive Program Change	45
Real-time Controller Assignment	45
MIDI Footswitch Assign	46
Tempo Controller	47

Knob Preset Quick-Edit	47
Knobs Deep Edit	48
Knobs/Riff MIDI Out	48
Preset Edit All Layers Enable	48
Front Panel Knob Calibration	49
MIDI SysEx Packet Delay	50
Send MIDI System Exclusive Data	50
User Key Tuning	52
Base Tempo	52
Screen Viewing Angle	53
Programming Basics	55
Modulation	56
Modulation Sources	57
Random Sources	58
Modulation PatchCords.....	58
Envelope Generators	59
Tempo-based Envelopes	60
Envelope Repeat	60
Low Frequency Oscillators (LFOs)	61
Clock Modulation.....	62
Modulation Destinations	64
Modulation Processors	65
Preset Modulation Processors	67
Using the Modulation Processors	69
More Examples	71
Dynamic Filters	73
What is a Filter?	74
Parametric Filters	77
The Z-Plane Filter	78
Signal Flow	79
MIDI Channels & Real-time Controls	80
Bank Select Commands	82
Stereo Mix Outputs.....	83
Edit Menu	85
Preset Name	86
Four Layer Architecture	87
Selecting Layers	87
Defining Layer Parameters.....	88
Selecting an Instrument	88
Sound Navigator	88
Defining Key Range	89

Defining the Velocity Crossfade Range	92
Defining the Real-time Crossfade Range	94
Transposing the Instrument	97
Tuning	98
Background: Transpose vs. Coarse Tuning	98
Amplifier	98
Volume Envelope	99
Selecting the Mode	99
Defining the Volume Envelope	100
Chorusing the Layer	101
Sound Start Offset and Delay	101
Non-Transpose Mode	102
Solo Mode	102
Assign Group	103
Glide	104
Z-Plane Filters	104
Proteus 1000 Filter Types	105
Filter Types	105
Filter Parameters	107
Filter Envelope	107
Defining the Filter Envelope	109
Auxiliary Envelope	109
Low Frequency Oscillators (LFOs)	109
Shape	110
Sync	111
Rate	111
Delay	112
Variation	113
PatchCords	114
Modulator Polarity	115
Pitch Bend Range	117
Mix Output	117
Common Preset Parameters	118
Preset Effects	118
FXA Algorithm	120
A Effect Types	120
FXA Parameters	121
FXA Send Amounts	121
FXB Algorithm	121
B Effect Types	121
FXB Parameters	122
FXB Send Amounts	122
Preset Patchcords	123
Initial Controller Amount	124
Keyboard Tuning	125
Preset Links	127
Preset Tempo Offset	128
Audition Riff Selection	128
Play Solo Layers	128

Programming Tutorial	129
Editing Presets.....	129
Changing the Instrument	129
Changing the Tuning of an Instrument	130
Chorus	131
Volume Envelope	131
Working with Filters	133
Adding the Filter Envelope	134
Changing Filter Types	136
Envelope Repeat	137
Practice Modulating	137
Troubleshooting	138
Linking Presets	139
Effects	141
Effects Overview.....	141
The Effects Sends	141
Effect Types.....	143
A Effect Types	143
B Effect Types	143
Effect Parameters	143
Decay	144
High Frequency Damping	144
Feedback	144
LFO Rate	144
Delay	144
Effects Programmed in the Preset.....	145
Master Effects.....	146
Effects Mode	148
Flexible Effects Control	148
Using the Effects Channel Settings in Multi Mode	150
Effect B Into Effect A	150
General Effect Descriptions.....	152
Reverb	152
Chorus	153
Doubling	153
Slapback	153
Stereo Flanger	153
Delay	154
Stereo Delay	154
Panning Delay	154
Dual Tap	154
Vibrato	154
Distortion	154

Save/Copy Menu	155
Saving a Preset.....	155
Copying Information	156
Copy Preset	156
Copy Layer	157
Copy PatchCords	158
Copy Preset PatchCords	158
Copy Preset Bank	159
Create Random Preset	159
Sound Authoring	160
Copy User Bank to Flash	160
Rename Flash SIMM	161
Duplicate Flash	162
 Appendix	 163
Front Panel Knob Functions	163
Proteus 1000 Preset Categories	164
Preset Listing.....	165
Instrument Listing.....	173
Riff Listing.....	182
Velocity Curves	185
PatchCord Amount Chart	187
MIDI	188
Received Channel Commands	190
Technical Specifications.....	191
Sound Design	192
Warranty.....	193
 Index	 195

Introduction

Product Description

Congratulations on your purchase of the E-mu Proteus 1000 – the composer’s dream machine. The power of Proteus 1000 begins with 64 voice polyphony, which means that 64 different instrument lines can be played at once! And there’s much more as you will soon discover.

Proteus 1000 contains two user-upgradable sound SIMM sockets, allowing you to mix and match sound sets according to your needs. New sounds can be added as easily as plugging in a new 16MB or 32MB SIMM module and up to 64MB of sounds can be added! Each sound set has been meticulously crafted to be the best of its kind. Samples are matched across the keyboard, perfectly looped, and rich in harmonic texture.

Proteus contains 512 user presets and can hold literally thousands of factory presets. *(ROM presets are automatically added when sound SIMMs are installed. As an example, a 32 MB SIMM may contain up to 1024 ROM presets.)* Proteus 1000’s Sound Navigator is a major improvement to the main screen that makes it easy to find the exact sound you want from the thousands available. It’s powerful, yet simple to use.

Of course the real power of Proteus 1000 becomes apparent when you synthesize your own sounds. The extremely flexible yet easy to use, 4-layer synthesizer voices make it easy to build sounds of any kind. Layers can be switched or crossfaded using key position, velocity, real-time controllers or any modulation source. Proteus 1000 also contains 50 different types of 2nd to 6th order resonant & modeling filters which are used to shape and modify the raw waveforms.

The 64 modulation sources include three multistage envelopes and two LFOs per layer, as well as full MIDI control over virtually every parameter. The digital patch bay, with 24 cords per layer, (and 12 more cords per preset) lets you connect modulation sources to 64 destinations in any imaginable way.

Four front panel real-time controllers give you control over 12 user-selectable parameters. The real-time knobs can adjust multiple parameters at once, allowing complex levels of control. For example, one knob can



The optional **Turbo** upgrade adds the following features to your Proteus 1000:

- 128 voice polyphony
- 4 submix analog outputs
- 32 MIDI channel operation
- 2 additional sound ROM slots
- S/PDIF stereo digital output

Overview

simultaneously turn up filter cutoff, while detuning one sample, and adjusting the release time of the volume envelope. Virtually every synth parameter in the Proteus 1000 is controllable using the real-time knobs or by any internal or external control source.

Once you have created your preset, you can add richness to your sound using Proteus 1000's 24-bit stereo effects. You can choose a different effects setup for each preset from over 60 algorithms. Proteus 1000's effects section is actually two separate effects processors with control over each wet/dry mix level on four effects sends. Effects Processor "A" contains primarily ambiance algorithms like reverb and delays, while effects processor "B" contains primarily spectral algorithms such as chorus, flange, phase, distortion, and delay. Effects can be linked to each preset or used globally to further enhance your sound.

Other features include multiple solo, voice assignment and performance modes for expressive control, 12 user-definable alternate tunings, and, of course, an extensive MIDI implementation.

This is the Getting Started Manual for setting up and playing Proteus 1000. The first part of the manual describes how to unpack and setup the hardware. The next chapters provide step-by-step instructions for the most common and widely used features of Proteus 1000. This section also defines each of the parameters and provides information on how to use them.

The complete operation manual is provided to you in pdf format on CD-ROM. The CD-ROM contains pdf files for both Mac and PC as well as the complete MIDI SysEx specification and a software downloading tool which allows you to retrieve the latest software and new features from the world wide web.

Important Safety Instructions

Grounding Instructions

Use in countries other than the U.S.A. may require the use of a different line cord or attachment plug, or both. To reduce the risk of fire or electric shock, refer all servicing to qualified service personnel. Do not expose this product to rain or moisture. There are no user serviceable parts or adjustments inside the unit.

This product must be grounded. If it should malfunction or break down, grounding provides a path of least resistance for electric current, reducing the risk of electric shock. This product is equipped with a cord having an equipment-grounding conductor and a grounding plug. The plug must be plugged into an appropriate outlet properly installed and grounded in accordance with all local codes and ordinances.

Danger!

Improper connection of the equipment's grounding conductor can result in the risk of electric shock. Check with a qualified electrician or service personnel if you are in doubt as to whether the product is properly grounded. Do not modify the plug provided with this product. If it will not fit the outlet, have a proper outlet installed by a qualified technician.

Caution!

If your Proteus 1000 (Model Number 9116-D) is rack mounted, you must use a standard 19 inch open frame rack. Screw-on rack mount ears are provided for this purpose.

User Maintenance Instructions



This symbol is intended to alert you to the presence of important operating and maintenance (servicing) instructions in the literature accompanying the unit.

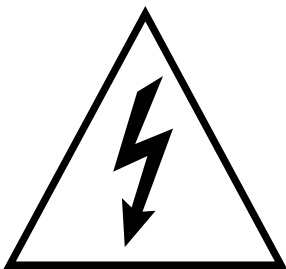

This symbol is intended to alert you to the presence of uninsulated dangerous voltage within the product's enclosure that may be of sufficient magnitude to constitute a risk of electric shock to persons.

1. The Proteus 1000 should be kept clean and dust free. Periodically wipe the unit with a clean, lint free cloth. Do not use solvents or cleaners.
2. There are no user lubrication or adjustment requirements.

Caution -. *These servicing instructions are for use by qualified personnel only. To reduce the risk of electric shock, do not perform any servicing other than that contained in these operating instructions unless you are qualified to do so. Refer all servicing to qualified service personnel.*

INSTRUCTIONS PERTAINING TO A RISK OF FIRE, ELECTRIC SHOCK, OR INJURY TO PERSONS.

READ THESE INSTRUCTIONS: When using electric products, basic precautions should always be adhered to, including the following:

1. Read all instructions before using Proteus 1000.
2. To reduce the risk of injury, close supervision is necessary when using Proteus 1000 near children.
3. Do not use Proteus 1000 near water — for example near a bathtub, washbowl, kitchen sink, in a wet basement, on a wet bar, or near or in a swimming pool. Do not expose the unit to drips or splashes.
4. The Proteus 1000 should be situated so that its location or position does not interfere with its proper ventilation.
5. The Proteus 1000 should be located away from heat sources such as radiators, heat registers, fireplaces, stoves, or ovens.
6. The Proteus 1000 should be connected only to a power supply of the type described in the operating instructions and marked on the product.
7. Care should be taken so that objects do not fall and liquids are not spilled into the enclosure of Proteus 1000 through openings.
8. This Proteus 1000 may be equipped with a polarized line plug (one blade wider than the other). This is a safety feature. If you are unable to insert this plug into the outlet, do not defeat the safety purpose of the plug. Contact an electrician to replace your obsolete outlet.
9. Protect the power cord from being walked on or pinched, particularly at plugs, convenience receptacles, and the point where they exit from the unit.
10. Unplug the Proteus 1000 from the power outlet during lightning storms or when left unused for a long period of time.
11. This product, in combination with an amplifier and headphones and speakers, may be capable of producing sound levels that could cause permanent hearing loss. Do not operate for a long period of time at a high volume level or at a level that is uncomfortable. If you experience any hearing loss or ringing in the ears, consult an audiologist.
12. Only use attachments and accessories specified by E-mu Systems.

13. The Proteus 1000 should be serviced by qualified service personnel when:
 - A. The power supply cord has been damaged; or
 - B. Objects have fallen, or liquid has been spilled into the unit; or
 - C. The unit has been exposed to rain; or
 - D. The unit has been dropped or the enclosure damaged; or
 - E. The Proteus 1000 does not operate normally or exhibits a marked change in performance.
14. All servicing should be referred to qualified service personnel.

Save These Instructions

The equipment described in this manual generates and uses radio-frequency energy. If it is not installed and used properly—that is, in strict accordance with our instructions—it may cause interference with radio and television reception.

This equipment has been tested and complies with the limits for a Class B computing device in accordance with the specifications in Subpart J of Part 15 of the FCC rules. These rules are designed to provide reasonable protection against such interference in a residential installation. However, there is no guarantee that the interference will not occur in a particular installation, especially if a “rabbit ear” TV antenna is used.

If Proteus 1000 does cause interference to radio or television reception, you can try to correct the interference by using one or more of the following measures:

- Turn the television or radio antenna until the interference stops.
- Move Proteus 1000 to one side or the other of the television or radio.
- Move Proteus 1000 farther away from the television or radio.
- Plug Proteus 1000 into an outlet on a different circuit than the television or radio.
- Consider installing a rooftop antenna with a coaxial lead-in between the antenna and television set.

It is the policy of E-MU / ENSONIQ to allow all users free, complete and unrestricted use to all of the presets, beats, riffs, patterns, and audition files contained in our products. However, we are unable to grant you a license to re-use, modify, create derivative works from, sell or redistribute the demonstration files (demos). In most cases, these compositions are copyright protected by their respective authors and are licensed to E-MU / ENSONIQ for product demonstration purposes only. Please contact E-MU / ENSONIQ with additional questions.

Radio and Television Interference

Copyright Information

Foreign Language Warnings - German

Wichtige Sicherheits- vorschriften

In Ländern ausserhalb den U.S.A. können andere Kabel oder Stecker notwendig werden. Zur Verminderung des Risikos von Feuer oder eines elektrischen Schlages übergebe man den Service an qualifizierte Fachleute. Das Gerät niemals Regen oder Nässe aussetzen.

Erdungs- instruktionen

Das Gerät muss geerdet sein. Bei einem Defekt oder Ausfall bietet Erdung dem elektrischen Strom den Weg des geringsten Widerstandes und reduziert das Risiko eines Schlages. Dieses Gerät ist mit einem geerdeten Kabel und Stecker ausgerüstet. Der Stecker muss in eine passende, einwandfrei montierte und geerdete Steckdose in Übereinstimmung mit den örtlichen Vorschriften eingeführt werden.

Gefahr

Unvorschriftsgemässer Anschluss des Gerätes kann zum Risiko eines elektrischen Schlages führen. Im Zweifelsfalle über die ordnungsgemässe Erdung soll ein qualifizierter Elektriker oder eine Serviceestelle beigezogen werden. Ändern Sie den mitgelieferten Stecker nicht. Sollte er nicht in die Steckdose passen, soll die einwandfreie Installation durch einen qualifizierten Techniker erfolgen.

Vorsicht

Wird der Proteus 1000 (Modell Nummer 9116-D) in einem Rackgestell montiert, muss ein offener 19-Zollrahmen verwendet werden.

Unterhaltsinstruktionen für anwender

Vorsicht



Dieses Symbol weist den Anwender auf wichtige Gebrauchs- und Servicevorschriften in den beiliegenden Drucksachen.

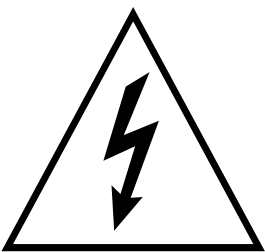

Dieses Symbol verweist auf nicht-isolierte Stromspannungen im Geräte-Innern, welche zu einem elektrischen Schlag führen könnten.

1. Proteus 1000 soll sauber und staubfrei gehalten werden. Das Gerät mit einem sauberen und säurefreien Tuch periodisch abreiben. Keine Lösungs- oder Reinigungsmittel anwenden.
2. Schmieren und Justieren sind nicht notwendig.
3. Bei weiteren Servicefragen wende man sich an eine qualifizierte Servicestelle.

Diese Gebrauchsanweisungen sind nur für qualifizierte Techniker beabsichtigt. Um die Gefahr eines elektrischen Schlages zu vermeiden, sollen Sie keine Arbeit unternehmen, die nicht in diesen Instruktionen vorgeschrieben ist. Wenden Sie sich bei weiteren Servicefragen an eine qualifizierte Servicestelle.

INSTRUKTIONEN BETR. FEUERRISIKO, ELEKTROSCHOCK ODER VERLETZUNG VON PERSONEN

WARNUNG; Beim Einsatz elektrischer Geräte sollten folgende Vorsichtsmaßnahmen stets beachtet werden:

1. Lesen Sie vor dem Einschalten des Proteus 1000 alle Instruktionen.
2. Zur Vermeidung von Verletzungsrisiken müssen Kinder bei eingeschaltetem Proteus 1000 sorgfältig überwacht werden.
3. Proteus 1000 nicht in der Nähe von Wasser in Betrieb nehmen -- z.B. in der Nähe von Badewannen, Waschschüsseln, auf nassen Gestellen oder am Swimmingpool.
4. Proteus 1000 stets so aufstellen, dass seine Belüftung nicht beeinträchtigt wird.
5. Proteus 1000 nicht in der Nähe von Hitze aufstellen, wie Heizkörper, offenem Feuer, Öfen oder von Backöfen.
6. Proteus 1000 ausschliesslich mit einem Netzgerät gemäss Bedienungsanleitung und Gerätemarkierung verwenden.
7. Dieses Gerät kann bei Verwendung von Kopfhörern und Verstärkern hohe Lautpegel erzeugen, welche zu bleibenden Gehörschäden führen. Arbeiten Sie nicht während längerer Zeit mit voller Lautstärke oder hohem Lautpegel. Stellen Sie Hörverlust oder Ohrenläuten fest, wenden Sie sich an einen Ohrenarzt.
8. Proteus 1000 kann mit einem polarisierten Kabelstecker (mit ungleichen Stiften) ausgerüstet sein. Das geschieht für Ihre Sicherheit. Können Sie den Stecker nicht in die Steckdose einführen, ändern Sie nicht den Stecker ab, sondern wenden Sie sich an einen Elektriker.
9. Das Netzkabel des Proteus 1000 bei längerem Nichtgebrauch aus der Steckdose ziehen.

10. Vermeiden Sie sorgfältig das Eindringen von Gegenständen oder Flüssigkeiten durch die Gehäuseöffnungen.
11. Das Gerät soll durch qualifizierte Serviceleute gewartet werden, falls:
 - A. das Netzkabel beschädigt wurde, oder
 - B. Gegenstände oder Flüssigkeit in das Gerät gelangten,
 - C. das Gerät Regen ausgesetzt war, oder
 - D. das Gerät nicht normal oder einwandfrei arbeitet, oder
 - E. das Gerät stürzte oder sein Gehäuse beschädigt wurde.
12. Servicearbeiten sollten nur qualifizierten Fachleuten anvertraut werden.

DIESE INSTRUKTIONEN AUFBEWAHREN

Foreign Language Warnings - French

Instructions de Sécurité Importantes

Une utilisation dans des pays autres que les U.S.A. peut nécessiter l'usage d'un cordon d'alimentation différent. Afin de réduire les risques d'incendie ou d'électrocution, référez-vous à un personnel de service qualifié, et n'exposez pas cet appareil à la pluie ou à l'humidité.

Instructions de Mise à la Terre

Cet appareil doit être relié à la terre. Dans le cas d'une malfonction éventuelle, la terre fournit un passage de moindre résistance pour le courant électrique, réduisant ainsi les risques d'électrocution. Le Proteus 1000 est équipé d'un cordon muni d'un conducteur et d'une fiche devant être branchée dans une prise appropriée et reliée à la terre en conformité avec les normes locales.

Danger

Une connexion incorrecte peut résulter en des risques d'électrocution. Vérifiez avec un technicien qualifié si vous avez des doutes quant à la connexion. Ne modifiez pas vous-même le cordon d'alimentation livré avec cet appareil; s'il ne rentre pas dans la prise, faites-en installer un autre par un technicien qualifié.

Attention

Si le Proteus 1000 (Model 9116-D) est installé dans un rack, utilisez un rack standard ouvert de 48.25cm.

Instructions de Maintenance

1. le Proteus 1000 doit être maintenu propre et sans poussière. Nettoyez-le périodiquement à l'aide d'un chiffon propre et non-pelucheux. N'utilisez pas de solvants, ou d'autres produits de nettoyage.
2. Aucune lubrification et aucun réglage ne sont nécessaires de votre part.
3. Pour tout autre service, référez-vous à un personnel qualifié.

Instructions Concernant les Risques d'Incendie, d'Électrocution, ou de Blessures Corporelles.

ATTENTION: Lorsque vous utilisez des appareils électriques, certaines précautions élémentaires doivent toujours être prises, incluant les suivantes:

Ces instructions de dépannage sont destinées uniquement aux personnes qualifiées. Afin d'éviter les risques d'électrocution, n'effectuez que les opérations décrites dans ce manuel, à moins que vous ne soyez qualifié pour cela. Faites effectuer toute réparation par une personne qualifiée.



Ce symbole vous alerte de la présence d'instructions importantes d'opération et de maintenance dans la notice accompagnant l'appareil.

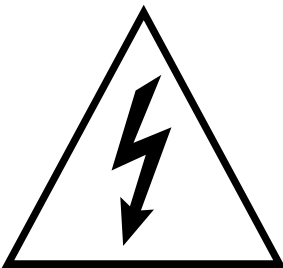

Ce symbole vous alerte de la présence d'un voltage non-isolé dangereux à l'intérieur de l'appareil, pouvant être d'une magnitude suffisante pour constituer un risque d'électrocution.

1. Lisez bien toutes les instructions avant d'utiliser le Proteus 1000.
2. Afin de réduire les risques de blessures, une attention particulière est nécessaire en la présence d'enfants en bas âge.
3. N'utilisez pas le Proteus 1000 dans ou près d'endroits humides - par exemple près d'une baignoire, d'un lavabo, dans les toilettes, dans une cave humide, sur un bar fréquenté, en présence d'un bull-dog en rut, ou dans une piscine pleine. Protégez cet appareil de tout liquide, éclaboussure ou fuite.
4. Le Proteus 1000 doit être placé de façon à ce que sa position n'interfère pas avec sa propre ventilation.
5. Le Proteus 1000 doit être placé loin de sources de chaleur telles que des radiateurs, cheminées, fours, ou groupies en chaleur.
6. Le Proteus 1000 doit uniquement être connecté à une alimentation du type décrit dans les instructions d'opération et tel qu'indiqué sur l'appareil.
7. Une attention particulière doit être observée quant aux objets pouvant tomber et aux liquides pouvant être versés sur et à l'intérieur de le Proteus 1000.
8. Le Proteus 1000 peut être équipé d'une fiche secteur polarisée (avec une broche plus large que l'autre). C'est une mesure de sécurité. Si vous ne pouvez pas brancher cette fiche dans une prise, ne neutralisez pas cette sécurité. Contactez plutôt un électricien pour remplacer la prise obsolète.
9. Evitez de marcher sur le cordon d'alimentation ou de le coincer, particulièrement près des prises de courant, des boîtiers électriques et du point de sortie de l'appareil.
10. Le cordon d'alimentation de le Proteus 1000 doit être débranché lorsque ce dernier n'est pas utilisé pendant une longue période.
11. Cet appareil, combiné avec un amplificateur, des haut-parleurs, et/ou un casque, est capable de générer des niveaux sonores pouvant occasionner une perte de l'ouïe permanente. Ne travaillez pas trop longtemps à un volume trop élevé ou même inconfortable. Si vous observez une perte de l'audition ou un bourdonnement dans les oreilles, consultez un O.R.L.
12. N'utilisez que les accessoires spécifiés par E-MU Systems.

13. Cet appareil doit être examiné par un personnel qualifié lorsque:
- A. Le cordon d'alimentation a été endommagé, ou
 - B. Des objets sont tombés, ou du liquide a été versé sur/à l'intérieur de l'appareil, ou
 - C. Le Proteus 1000 a été exposé à la pluie, ou
 - D. Le Proteus 1000 est tombé, ou
 - E. Le Proteus 1000 ne fonctionne pas normalement, ou affiche un changement radical de performance.
14. Tout service doit être effectué par un personnel qualifié.

SAUVEGARDEZ CES INSTRUCTIONS

Interférences Radio et Télévision

L'appareil décrit dans cette notice génère et utilise une énergie de fréquence-radio. S'il n'est pas installé et utilisé correctement - c'est à dire en suivant strictement nos instructions - il peut occasionner des interférences avec la réception d'une radio ou d'une télévision.

Cet appareil a été testé et est conforme aux normes de Classe A en accord avec les spécifications du paragraphe J de la section 15 des lois FCC. Ces lois sont désignées pour fournir une protection raisonnable contre de telles interférences dans une installation résidentielle. Toutefois, il n'est pas garanti qu'aucune interférence n'apparaisse dans des installations particulières, et plus spécialement lorsqu'une antenne de télévision en «oreilles de lapin» est utilisée.

Si le Proteus 1000 occasionne des interférences, vous pouvez essayer de les corriger en utilisant une ou plusieurs des mesures suivantes:

- Tournez l'antenne de la télé ou de la radio jusqu'à ce que les interférences disparaissent.
- Déplacez le Proteus 1000 d'un côté ou de l'autre de la télé ou de la radio.
- Eloignez le Proteus 1000 de la télé ou de la radio.
- Branchez le Proteus 1000 sur une prise différente que la télé ou la radio.
- Installez une antenne sur le toit munie d'une connexion coaxiale entre elle et le poste de télévision.

Declaration of Conformity



Manufacturer:

E-MU/Ensoniq
1600 Green Hills Road
Scotts Valley, CA 95067-0015 USA

We hereby declare that the equipment listed herein conforms to the harmonized standards of the following European Commission Directives: 89/336/EEC and 72/23/EEC.

Trade Name: Audio Sampler/Emulator System

Model Number: Proteus 1000 CR

Under 89/336/EEC as amended by 92/31/EEC, and 72/23/EEC

In accordance with EN 55103-1:1996, Emission Environments E1, E2, E3

In accordance with EN 55103-2:1996, Immunity Environments E1, E2, E3

Test information is contained in a report by Atlas Compliance and Engineering dated November 15, 1999.

Report No.: 9949EMU2KCR103

Under 73/23/EEC as amended by 93/68/EEC

In accordance with EN 60950 with amendments A1, A2, A3, A4, A11

This Declaration is made November 15, 1999

Setup

Unpacking

This section thoroughly describes how to set up your new Proteus 1000 for use. Setup includes unpacking instructions and how to connect the cables.

Carefully remove Proteus 1000 from the packaging material. Take care to save the packing materials in case you need to transport the unit. Check to make sure all components are included and in good condition. If there are missing or damaged components, contact E-MU Systems immediately for replacement or repair.

The Proteus 1000 box should include the following components:

- Proteus 1000 rack unit
- Power cable
- Rack mounting ears
- This operation manual
- Manuals CD-ROM

Connection Instructions

Basic Setup

 If Proteus 1000 does not seem to be responding correctly, make sure that both Proteus 1000 and your MIDI controller are set to the same MIDI channel.

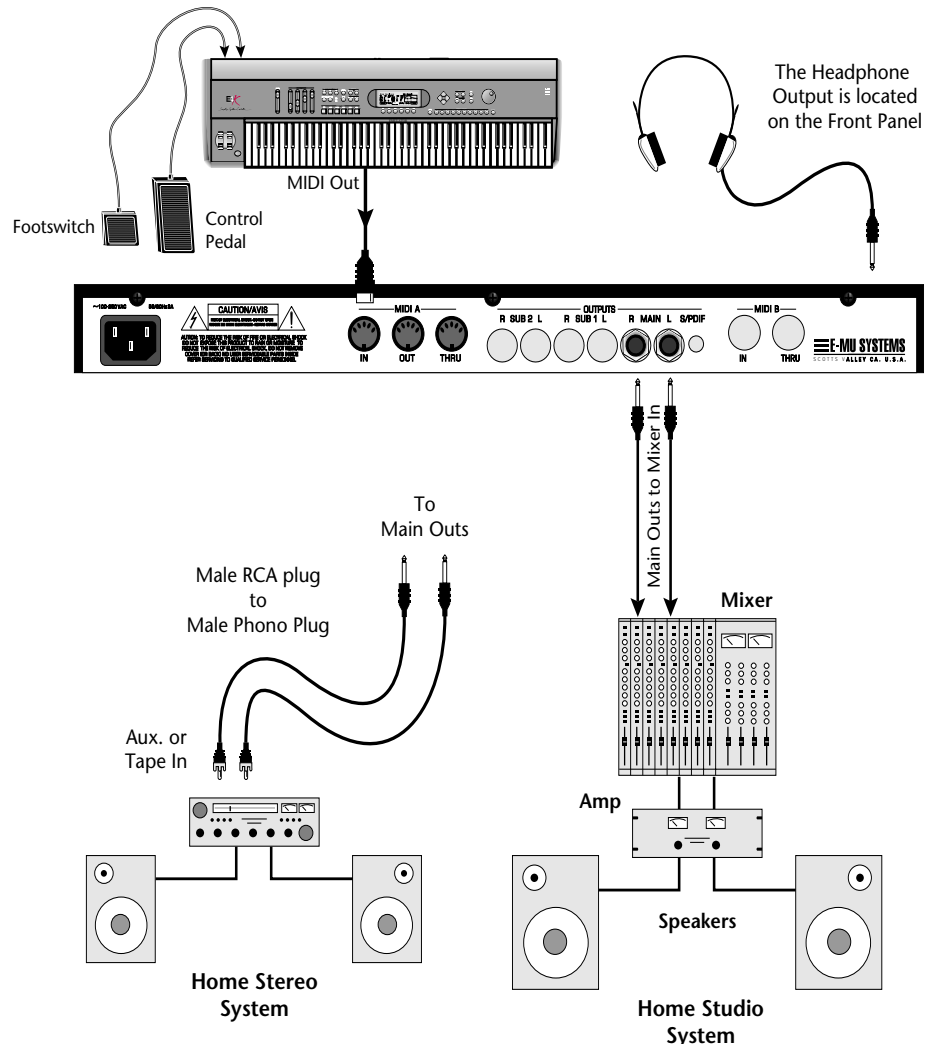

 The Right Main output jack carries a mono mix of the left and right channels when the Left Main plug is not plugged in.

The Left Main output jack is a stereo jack carrying both channels when the right output jack is empty.

MIDI In

The module is controlled by MIDI messages received at the MIDI In jack. Normally you will connect MIDI Out of a controller such as a MIDI keyboard to the MIDI In of Proteus 1000. Be sure to connect a Footswitch and/or Control Pedal to your MIDI keyboard. Many of the factory presets use MIDI controllers.

Outputs

In order to reproduce the widest dynamic range and frequency response, use a high quality amplification and speaker system such as a keyboard amplifier or home stereo system. A stereo setup is highly desirable because of the added realism of stereophonic sound. Headphones can be used if an amplifier and speaker system is not available. Plug stereo headphones into the headphone jack located on the left side of the front panel.

Studio Setup

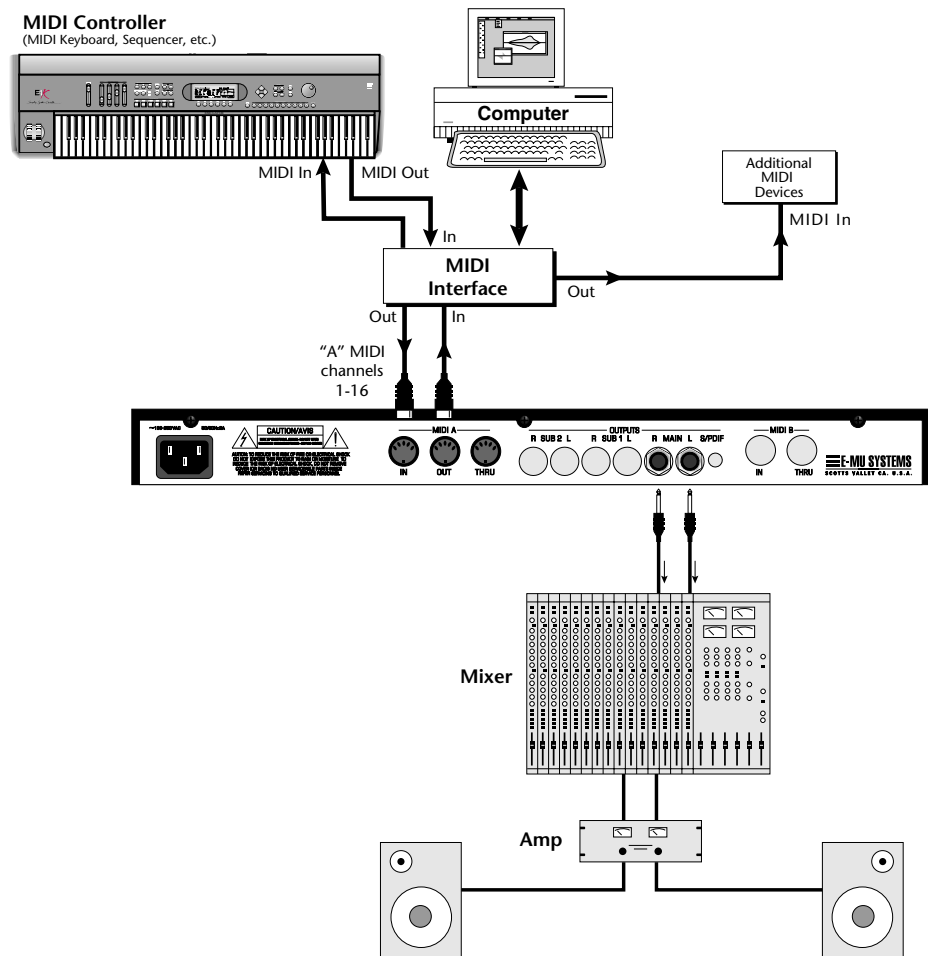

MIDI In

In this setup, Proteus 1000 is controlled by MIDI messages, received at the MIDI input, which are routed by the MIDI interface. The MIDI interface allows any MIDI controller, such as a MIDI keyboard or a computer, to control the module.

MIDI Out

The MIDI Out jack transmits program data to a computer or other device.

Outputs

A stereo connection is highly desirable because of the added realism of stereophonic sound. Plug stereo headphones into the headphone jack located on the left side of the front panel. The Right Main output jack serves as a mono output when the Left Main plug is not plugged in. The Left Main output jack is a stereo jack carrying both channels when the Right output jack is empty.

Power Up!

The power switch is located on the right side of the front panel. You can turn on Proteus 1000 and its MIDI controller in any order. When power is applied the liquid crystal display will light, indicating that Proteus 1000 is operating. You may have noticed that there is no 110/220 Volt power selector switch on Proteus 1000.

Proteus 1000 automatically switches itself to the proper line voltage.

Instant Gratification

Playing Demo Sequences

This section presents step-by-step instructions for the most fundamental operations to get you up and making sounds quickly.

Proteus 1000 has several factory demonstration sequences that let you hear what this incredible machine can do. The actual number of demo sequences depends on which ROM sounds sets are installed. You can play these demo sequences by accessing the Demo Sequence page.



► To Play a Demo Sequence

1. Press and hold the **Master** and **Edit** buttons at the same time to enter the Demo Sequence page. The screen shown above appears.
2. Select a sequence using the data entry control. The Enter LED will be flashing.
3. Press the Enter button to begin playing the selected sequence. The screen shown below appears.



4. Press the Enter button again to stop playing the sequence.
5. When a demo sequence plays to the end, the next demo will automatically begin playing. The screen will display the new demo name.
6. With the sequence stopped, press either the Master, Edit or Multi button to Exit the demo sequence mode.

Auditioning Presets

The front panel audition button allows you to hear any preset in Proteus 1000 without even hooking up a MIDI keyboard! When the Audition button is pressed, the LED next to the button will illuminate and a short "Riff" (programmed as part of the preset) will play. The Riff is latched on and plays continuously until the button is pressed again. Presets can be changed while Audition is latched on.

The top line of the display changes to show the MIDI Bank Select controller values needed to select the preset being auditioned. This is an extremely handy feature when sequencing.

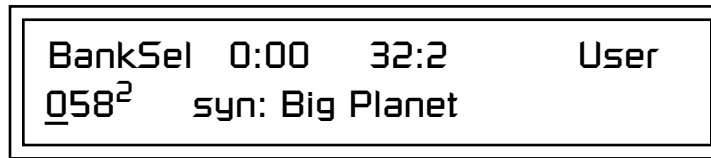

► **To Audition a Preset**

1. Select a preset by turning the data entry control while the cursor is anywhere on the lower line. The preset number field (shown above) is the normal position of the cursor and pressing the Enter button will return the cursor to this position.
2. Press the Audition button on the front panel. The Audition LED will illuminate and a short riff will play the selected preset.
3. Continue to select and audition presets.
4. Press the Audition button again to turn Audition mode off. The LED will extinguish.

Selecting and Quick Editing Presets

The first thing you'll do with the Proteus 1000 is select and play the factory provided presets. Proteus 1000 comes standard with 12 banks containing 128 presets each.

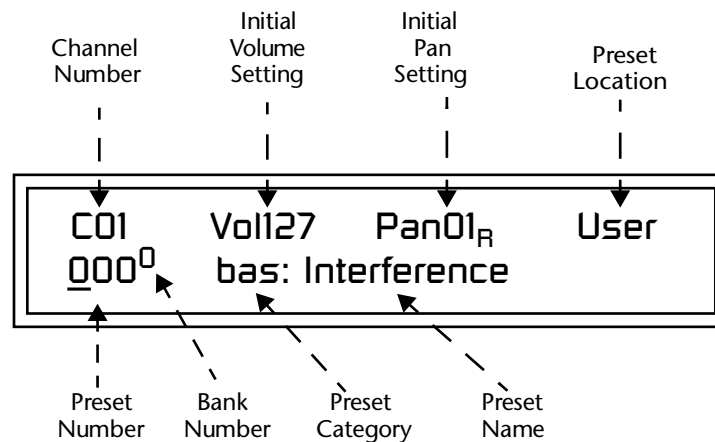

The first four banks are USER locations that can be overwritten and used to store your own presets. The presets that come stored in the USER presets are duplicated in banks 4-7 of the "CMPSR" ROM bank, so feel free to overwrite them with your own presets. You won't be losing anything.

The *ROM Card* identifier is shown in the top right of the display. The preset is identified in the bottom line of the main screen (the screen that appears when you first power up the unit).

Each bank of 128 presets is identified by a superscripted *Bank Number* to the right of the preset number. The bank numbers reset to 0 at the start of each ROM card you have installed. So with the composer ROM installed, the USER banks will go from 0-3, then start over from 0-7 for the CMPSR banks.

To the right of the preset number and bank is the preset *Category* name followed by the *Preset Name*.

► To Change the Preset

1. Place the cursor under the first character in the Preset Number field. This is the “Home” position which is selected instantly when you press the Home/Enter button. Pressing either of the two cursor buttons repeatedly also gets you there.
2. Turn the Data Entry Control knob on the front panel to select a new preset number. If you turn the knob slowly, the presets advance one number for each “click” of the knob. If you spin the knob quickly, the numbers advance much faster (more than one number per click).
3. Play the keyboard (or press the Audition button) and listen to the sounds made by your Proteus 1000!
4. **TURN THE FOUR KNOBS** on the front panel and note how they change the sound of each preset! The button to the left of the knobs changes the knob’s function. Don’t worry about ruining the sound, the values are automatically reset as soon as you select a new preset.

 You can select presets from the Preset Number, Bank Number, Preset Category or Preset Name fields.

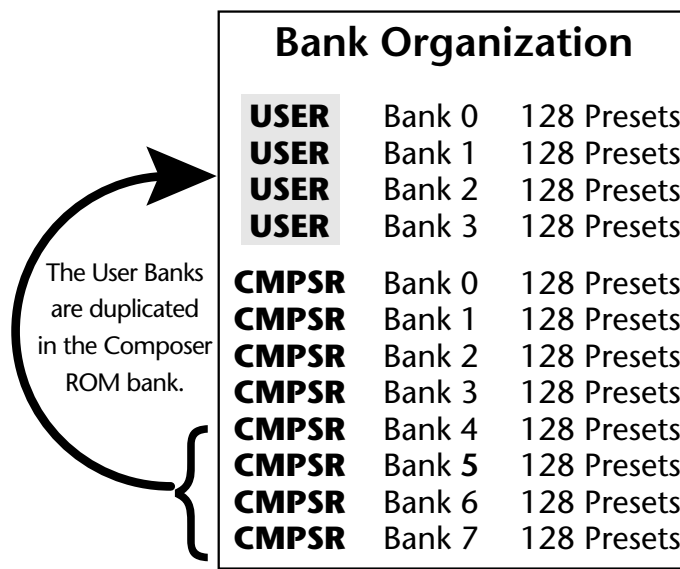

The four User Banks can hold 512 custom presets. Feel free to overwrite these since the factory user presets are duplicated in nonvolatile ROM.



Basic Operations

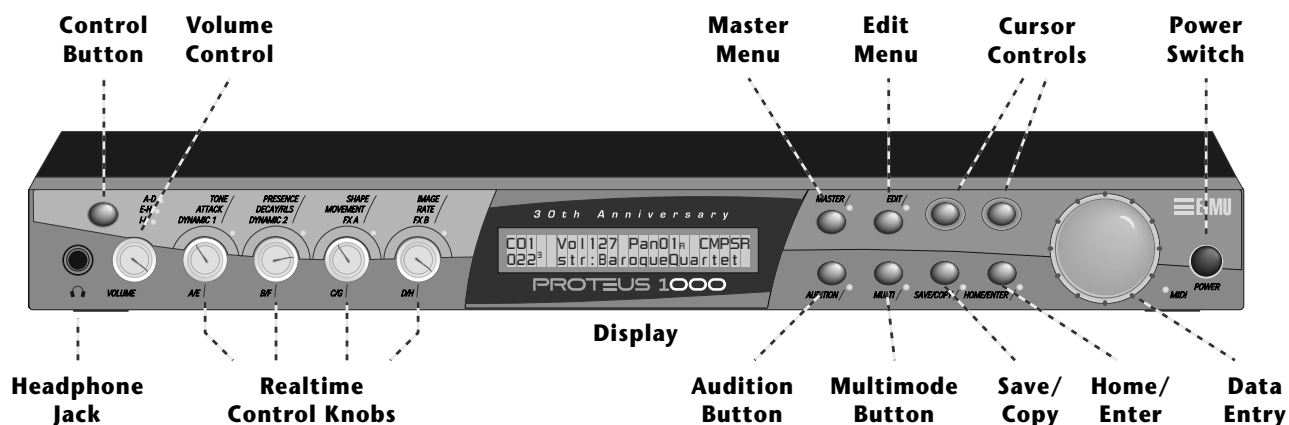

Front Panel

The Proteus 1000 front panel contains an LCD screen, nine buttons and four real-time controllers. Functions are grouped logically and the controls are arranged for ease of use. Precisely because Proteus 1000 is so simple to use, you might be tempted to skip this section. If you just can't help yourself, at least read the Real-time Controller information beginning page 23. There are several "power user" features in the interface which make programming even easier and we wouldn't want you to miss them.

Volume Control

This control is the master volume control for all audio outputs. The Volume Control does not affect any editing or user interface operations. For maximum dynamic range, turn this knob all the way up and control the volume from your mixer or amplifier.

Master Button

The Master menu contains parameters that affect the entire machine, not just certain presets. An illuminated LED to the right of the button indicates that you are in the Master menu.

Edit Button

Use the Edit menu when you want to create or modify a preset. An illuminated LED to the right of the button indicates that you are in the Edit menu.

Control Button

The Control button is used to change the function of the Controller knobs (see the next section). Each time you press the Control button, the Control Mode toggles to select only one of the three Control Rows. The currently

selected Control Row is indicated by one of the three LEDs to the right of the row's label.

Audition Button

The Audition button allows you to hear any preset without hooking up a MIDI keyboard. When the Audition button is pressed, the LED next to the button will illuminate and a short "Riff" (programmed as part of the preset) will play. The Riff is latched on and plays continuously until the button is pressed again. Presets can be changed while Audition is latched on. See "Bank Select Commands" on page 82 for more information on selecting banks via MIDI.

The top line of the display changes to show the MIDI Bank Select controller values needed to select the preset being auditioned. This handy feature lets you know the exact Bank and Preset number to enter into your sequencer.

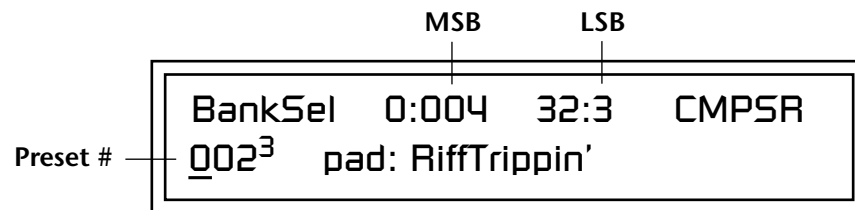

Left/Right Cursor Buttons

These buttons move the cursor to the next parameter on the display. (The cursor is a little flashing line underneath one of the parameters in the display.) Press either cursor button until the cursor is underneath the desired parameter. The cursor buttons have an auto-repeat feature which advances the cursor when the button is held continuously.

The cursor can be moved bidirectionally using the Data Entry Control while either cursor select button is held down (for example, press and hold the right cursor button and turn the Data Entry Control).

Multisetup Button

The Multisetup button allows you to select a Multi-setup. A Multi-setup is a group of parameters that you might associate with a particular sequence or song. It is like a "snapshot" of the current configuration of the module. There are 64 setups numbered 0-63.

A Multisetup includes all of the following parameters:

- The Preset/Volume/Pan assignments for each of the 16 MIDI channels.
- All Master menu parameters, except for the User Tuning Tables and the MIDI program change->preset map.
- The Multisetup name.

Save/Copy Button

The Save/Copy button is used to save or copy presets and to copy data. Selected groups of parameters, such as PatchCord settings, can be copied between Presets and/or between Layers using this menu.

The LED to the right of the button illuminates to indicate that you are in the Save/Copy menu. The LED also illuminates when any preset parameter has been changed in the Edit menu (or if the front panel knobs have been moved with Quick-Edit mode enabled).

Home/Enter Button

The Home/Enter button is dual purpose. In general, this button acts as the “Home” button. For example, when in an Edit menu, this button snaps the cursor to the page name field of the current screen. When viewing the Preset Select screen (we also call it the main screen), this button snaps the cursor to the preset number field. In these instances, the LED is not used.

Some screens and parameter fields use this button as the “Enter” button. In these cases, the LED blinks to indicate that the module is waiting for your response to initiate the operation.

Data Entry Control

The Data Entry Control is a stepped, variable control switch used to change parameter values. The wheel increments or decrements the current value one unit with each click. This control incorporates acceleration, which advances the value faster if the Data Entry Control is turned quickly.

Front Panel Controller Modes

The Real-time Controller Knobs serve three purposes:

1. Real-time control of synthesizer parameters
2. “Quick Editing” the initial settings of the real-time controllers
3. “Deep Editing” the parameters

This section describes each of the three uses.

Real-time Control

The Real-time controller knobs provide direct control of the Proteus 1000’s synthesizer parameters. They are always active when on the Preset Select (main) screen. They can optionally be used to transmit MIDI controller messages to other MIDI devices.

The Control button (left of the knobs) changes the function of the real-time controller knobs. Each time the button is pressed, the Control Mode toggles to select one of the three Control Row groups. The currently selected Control Row is indicated by the illuminated LED to the right of the button. The control knob functions are determined by the selected Control Row.

The three Control Rows generate MIDI data that can control the preset on the current MIDI channel (the channel showing on the Preset and main screen. The labels (Filter Cutoff, Filter Res, Shape, Image, etc.) printed on

these rows show how the factory ROM presets may be programmed to respond. (*The controls might not conform to the front panel labels depending on the preset.*) You can change the way a preset responds to MIDI A-L messages from the Edit menu (PatchCords).

There is an LED next to each of the control knobs which illuminates to indicate that the knob setting has been changed from the value programmed in the preset (when Quick Edit mode is enabled). If the knob position is returned to the original setting, the LED is extinguished.

If the “*Knobs MIDI Out*” parameter in the Master menu (see “*Knobs/Riff MIDI Out*” on page 48) is set to “transmit,” the system sends a MIDI controller message when you turn off the Control knob. The MIDI controller message is sent on the current MIDI channel (also called the basic channel) using the controller number assigned in the Master menu (see “*Real-time Controller Assignment*” on page 45).

The knobs only generate a message when you move a knob to a new value. The current value jumps to the new value.

Quick Edit

This mode uses the Controller knobs to “Quick-Edit” the currently selected preset without having to enter the Preset Edit menu. This mode is only active when on the Preset Select screen and when “*Quick-Edit*” is enabled in the Master menu (see “*Knob Preset Quick-Edit*” on page 47).

Initial controller values can be stored in every preset. When you move a knob with Quick-Edit enabled, the Initial Controller Value is updated with the knob’s new value. The knob’s LED lights indicating that the preset value has been changed. The three Control Rows’ MIDI A-L values are stored in the corresponding *Initial Controller Amount* parameter in the Edit menu (see “*Initial Controller Amount*” on page 124). The Save/Copy button LED illuminates to remind you that the preset has been edited. “Quick-Edits” made to a preset are lost if you select another preset before saving them.



Quick-Edit mode must be enabled in the Master menu.

► To Quick-Edit a Preset

1. Use the Control Knobs to change the sound of the current preset as desired.
2. Press the Save/Copy button. The display reads, “Save Preset to.”
3. Press the right cursor button to select the bottom row.
4. **Optional:** Select a new preset location if you don’t want to overwrite the current preset, or if the current preset is a ROM preset.
5. Press the Enter button to save the preset.

Deep Edit Mode

When in the Master, or Edit menus, you can use the Controller Knobs to edit parameters. Using the Controller Knobs is a faster method for entering data, but the Data Entry Control offers finer precision.

► **To Enable Deep Edit Mode:**

1. Press the Master button and use the Data Entry Control to advance to the “Knobs Deep Edit” screen as shown in the following illustration.



2. Press either Cursor key to move the cursor to the bottom line in the display.
3. Use the Data Entry Control to change the value to “enabled.”
4. Press the Master menu button to exit the Master menu.

When you enter any of the Edit menus:

1. The four Controller Knobs are used for editing.
2. All the Controller LEDs are off.
3. All the Control Row LEDs are off.

When you turn a knob, the field value jumps to the current knob value. You can still use the Data Entry Control for editing by moving the cursor to the desired field.

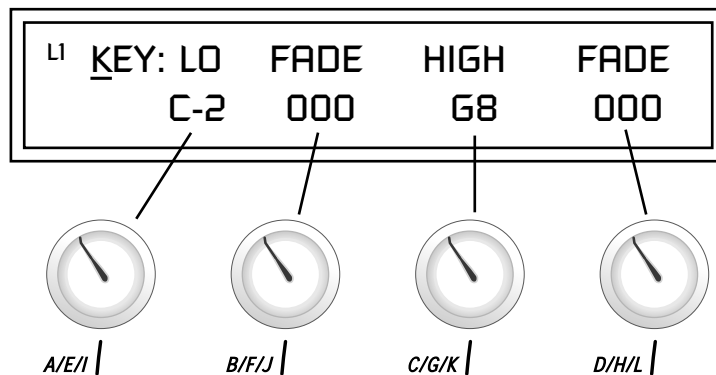

To move through menus horizontally, use the Data Entry Control (the page’s title field is the default cursor position). To move through menus vertically (preset layers), press the left cursor to get to the layer field, then change layers with the Data Entry Control.

- Use the Data Entry Control to move through menus (horizontally) or layers (vertically).
- Use the Controller Knobs to change parameter values within each page.

Main Screen

The Preset Select screen is Proteus 1000's default screen (also called the main screen) and is active when you have not selected any of the other button-activated menus. From this screen you can change or examine the Preset, Volume, Pan Position and Preset Location for each of the 16 MIDI channels.

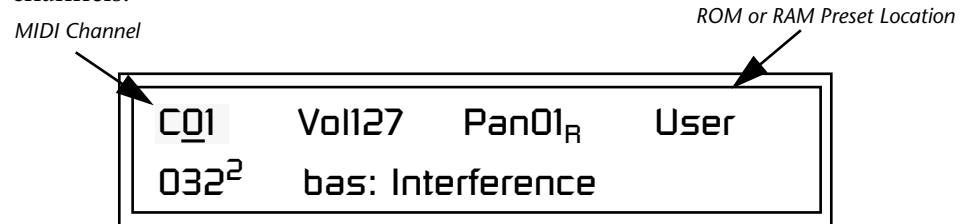

MIDI Channel Selection

 The channel number shown in the main screen is the "basic MIDI channel" when in Omni or Poly modes.

► To Change the MIDI Channel

1. Press either cursor button until the cursor is underneath the channel number. (The cursor is the little flashing line underneath one of the parameters in the display.)
2. Rotate the Data Entry Control to select a MIDI channel (01-16). As the channel number changes, the display changes to show the preset, volume, pan and preset location associated with the displayed channel.

Preset Selection

► To Change the Preset

1. Press either cursor key until the cursor is underneath the preset number. (The cursor is a little flashing line underneath one of the parameters in the display.) As you rotate the Data Entry Control, the preset number and name changes.
2. The displayed preset is assigned to the displayed MIDI channel. Presets are arranged into banks of 128, as shown in the diagram at left.

Bank	Contents
0	– 128 RAM Presets
1	– 128 RAM Presets
2	– 128 RAM Presets
3	– 128 RAM Presets
ROM 1	0 – 128 ROM Presets
	1 – 128 ROM Presets
	2 – 128 ROM Presets
	⋮
	⋮
??	Depending on ROM sets installed

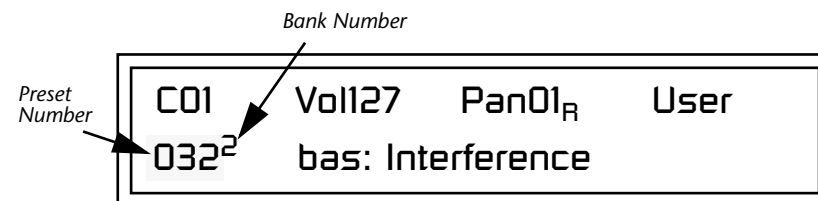

Using the screen above as an example, the superscripted number 2 in the second line of the display identifies the current bank number.

- Select banks independently of the of the preset number by locating the cursor on the Bank field and turning the Data Entry Control.

MIDI BANK SELECT			
	MSB	LSB	
	cc00	cc32	
USER	00	00	Bank 0
USER	00	01	Bank 1
USER	00	02	Bank 2
USER	00	03	Bank 3
CMPSR	04	00	Bank 0
CMPSR	04	01	Bank 1
CMPSR	04	02	Bank 2
CMPSR	04	03	Bank 3
CMPSR	04	04	Bank 4
CMPSR	04	05	Bank 5
CMPSR	04	06	Bank 6
CMPSR	04	07	Bank 7

This chart shows the MSB and LSB numbers needed to select preset banks over MIDI. Select a bank, then send the program change number. Without a bank select command, presets are selected from within the current bank.

Channel Volume

Channel Volume sets the volume of the selected MIDI channel in relation to the other channels. This is the same parameter as MIDI volume control #7, and changes made over MIDI are shown in the display.

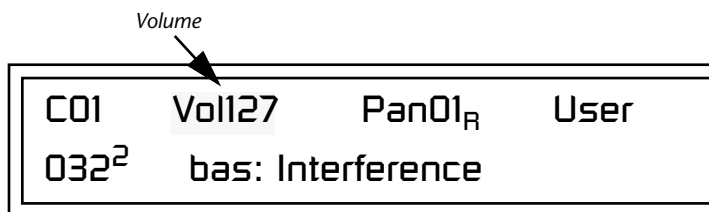

► To Change the Channel Volume

1. Press either cursor key until the cursor is underneath the volume value.
2. Rotate the Data Entry Control to select a volume level. The Channel Volume range is 000-127.

Channel Pan

Channel Pan sets the stereo position of the selected MIDI channel. This control operates like the balance control on your home stereo system. Channel Pan is the same parameter as MIDI pan controller #10, and changes made over MIDI are shown in the display.

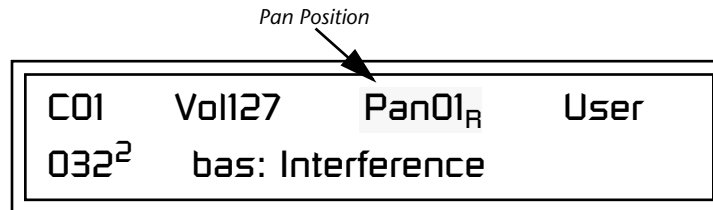

Note: Pan settings in the preset ADD algebraically with the Channel Pan setting. Therefore, if the pan setting in the preset were set to “63R,” moving the Channel Pan setting full left would return the sound to the center position.

► To Change the Channel Pan

1. Press either cursor key until the cursor is underneath the pan field.
2. Rotate the Data Entry Control to select a pan value. 64L indicates a hard left pan, 63R indicates a hard right pan. With a setting of “00,” the sound is centered in the stereo field.

Sound Navigator

Preset Category

Sound Navigator allows you to search through preset and instrument categories to find the type of sound you're looking for. Each preset and instrument has a name and a three letter preset category. You can create your own categories in order to group favorite presets. The preset category is assigned in the Edit menu (Preset Name). Instrument categories are fixed.

When you want to find presets in a particular category, you simply change the category field in the main screen, then move the cursor to the preset name field to scroll through all the presets in the selected category.

When the cursor is on the Preset Category field, turning the Data Entry Control selects different preset categories. The Name Field will change to show the first preset in each category.

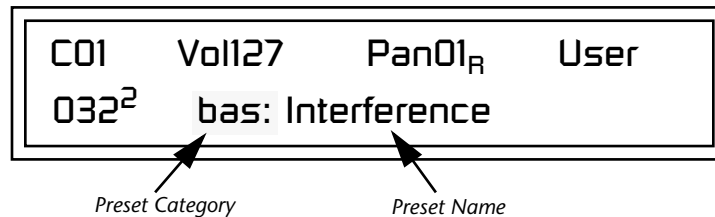

► To Change the Preset Category

1. Press either cursor key repeatedly until the cursor is underneath the preset category field.
2. Rotate the Data Entry Control to select one of the preset categories. Preset Categories are displayed in alphabetical order.

► To Select a Preset within a Category

1. After selecting a category, move the cursor to the Preset Name field.
2. Rotate the Data Entry Control to scroll through the presets in the selected category. Note that the preset numbers will no longer change sequentially.

Instrument Category

When the cursor is on the Instrument Category field (Edit menu), turning the Data Entry Control selects different instrument categories. The Name Field changes to show the first instrument in each category. Move the cursor back to the instrument name to select instruments in the selected category.



Multitimbral Operation

 See page 159 for detailed information on Multisetups.

Multitimbral operation means that Proteus 1000 can play more than one sound at the same time. Follow these instructions to access multiple presets on different MIDI channels simultaneously.

► To Set Up Proteus 1000 for Multitimbral Operation

1. Set the MIDI mode to “multi mode,” using the MIDI mode function in the Master menu.
2. Decide which MIDI channels you want the Proteus 1000 to receive (16 channels can be used simultaneously). You can turn any unused channels OFF using the MIDI Enable function in the Master menu.
3. Select the desired preset for each of the MIDI channels you want the Proteus 1000 to receive using the Main Screen. See “Main Screen” on page 26.
4. Save the Multisetup using the instructions provided in Chapter 9:Save/ Copy.
5. Proteus 1000 now responds multitimbrally on each of the MIDI channels you have specified. The volume and pan position parameters can be adjusted over MIDI (for each MIDI channel) or using the Cursor and Data Entry Control in the Preset Select screen.

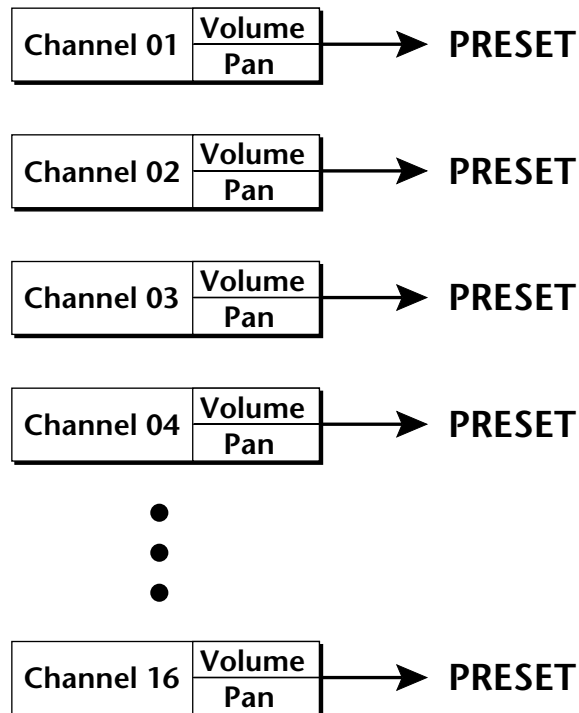

Each of the 16 MIDI channels can be assigned to play a specific Proteus 1000 preset.

Multisetup Menu

Multisetups

The Multisetup button allows you to save and restore Multisetups. A Multisetup is a group of parameters that you might associate with a particular sequence or song. It is like a “snapshot” of the current MIDI channel configuration of the module. There are 128 setups numbered 0-127. All Multisetups are user programmable.

A Multisetup includes ALL the following parameters:

- Preset/Volume/Pan assignments for each of the 32 MIDI channels.
 - Multisetup Name
 - ALL MASTER MENU PARAMETERS except...
- MIDI Program Change->Preset map
 - User Key Tuning Tables



Multisetups can also be restored (selected) via MIDI Bank and Program change commands. Select: cc00 = 80, cc32 = 00, (dec) then send a Program Change command corresponding to the Multisetup you wish to select.

► **To Enable the Multisetup Menu**

Press the Multi button, lighting the LED. The Multisetup screen displays the menu page most recently selected since powering up Proteus 1000. The cursor appears below the first character of the screen heading on line one.

► **To Select a New Screen**

Press the Home/Enter button or press the Cursor button repeatedly until the cursor is below the screen title heading. Rotate the Data Entry Control to select another screen.

Restoring Multisetups

► To Modify a Parameter

Press either Cursor button repeatedly (or hold down the left or right cursor button while turning the Data Entry Control) until the cursor is below the desired parameter value. Rotate the Data Entry Control to change the value.

► To Return to the Main Screen

Press the Multi button, turning off the LED.

Proteus 1000 contains 128 Multisetup locations. These are all User locations which you can use to store your own Multisetups.

Multisetups can also be restored using a MIDI Bank Select command. **Select: cc00 = 80, cc32 = 00, (dec)** then send a **Program Change** command corresponding to the Multisetup you wish to select.

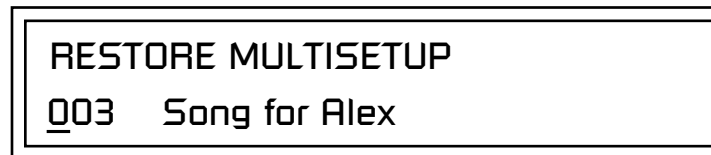

► To Restore (Select) a Multisetup:

1. Press the Multi menu button lighting the LED. The Multi menu screen displays the menu page most recently selected since powering up Proteus 1000. The cursor appears below the first character of the screen heading on line one.
2. Go to the "Restore Multisetup" screen (shown above) using the Data Entry Control. This is the first screen in the menu.
3. Press either cursor button to move the cursor to the bottom line of the screen.
4. Now, use the Data Entry Control to select a Multisetup. The Enter LED will be flashing.
5. Press the Enter button to load the selected Multisetup.

Saving & Naming Multisetups

► To Save a Multisetup:

1. Set the Preset, Volume, Pan settings the way you want them for all 32 channels. Set the Master menu parameters the way you want them.
2. Press the Multi menu button lighting the LED.

3. If you wish to Name your new Multisetup continue on, otherwise skip to step 8.
4. Scroll to the "Setup Name" screen (shown below) using the Data Entry Control.



SETUP NAME
020 User Setup 23

5. Press either cursor button to move the cursor to the bottom line of the screen.
6. Scroll to the "Save Multisetup" screen (shown below) using the Data Entry Control.



SAVE MULTIS SETUP to
020 Destination Multisetup

7. Press either cursor button to move the cursor to the bottom line of the screen.
8. Now, use the Data Entry Control to select the destination location. The Enter LED will be flashing.
9. Press the Enter button to save the Multisetup.

Multitimbral Sequencing

“Multitimbral” means that Proteus 1000 can play multiple sounds at the same time. For a multitimbral sequence to play back correctly, the proper preset must be selected for each MIDI channel. This could be done by inserting preset changes into each track of your sequence before the sequence starts. Proteus 1000 also provides another way to store this “pre-sequence setup” using the Multisetup menu.

Using Multisetups, you’ll set up the preset, volume and pan settings for each MIDI channel as you build your sequence, then save the Multisetup when it’s the way you want it. Sending one preset change command before the sequence starts selects the Multisetup and MIDI settings for all 32 channels.

► To Set up Proteus 1000 for Multitimbral Operation

1. Set the MIDI mode to “multi mode,” using the MIDI mode function in the Master menu.
2. Decide which MIDI channels you want Proteus 1000 to receive (32 channels can be used simultaneously). If you are using 16 MIDI channels or less, just use one of the MIDI ports. Use both MIDI ports if you need more than 16 MIDI channels. You can turn any unused channels OFF using the MIDI Enable function in the Master menu.
3. Select the desired preset for each of the MIDI channels you want the Proteus 1000 to receive using the MIDI Channel/Preset selection screen. You can also set the initial Volume and Pan settings for each channel.

1. Select Channel

2. Select Preset

C01	Vol127	Pan00 _R	User
032 ²	bas: Interference		

4. Proteus 1000 now responds multitimbrally on each of the MIDI channels you have specified. The volume and pan position parameters can be adjusted dynamically over MIDI (during the sequence).
5. Save the Multisetup.

► To Link a Multisetup with your Sequence

1. Insert a MIDI bank and program change in the lead-in measure of your sequence to select the proper Multisetup before the sequence starts.
2. The Multisetup will now be selected before the sequence starts.

Master Menu

The Master menu contains functions that affect the overall operation of Proteus 1000. For example, changing the Master Tune parameter changes the tuning of all the presets, not just the one currently displayed.

► To enable the Master menu

Press the Master button, lighting the LED. The Master Menu screen displays the menu page most recently selected since powering up Proteus 1000. The cursor appears below the first character of the screen heading on line one.



Warning: Master Menu changes are automatically saved when you exit the menu. If the power is turned off before you exit the menu any changes you have made will be lost.

► To select a new screen

Press the Home/Enter button or press the Cursor button repeatedly until the cursor is below the screen title heading. Rotate the Data Entry Control to select another screen.

► To modify a parameter

Press either Cursor button repeatedly (or hold down the right cursor button while turning the Data Entry Control) until the cursor is below the desired parameter value. Rotate the Data Entry Control to change the value.

► To return to the main screen

Press the Master button, turning off the LED.

Defining Master Parameters

Transpose/Tune

Master setup parameters affect overall performance, range, and global effects. This section describes the Master parameters and how to define them.

The Transpose parameter transposes the key of all presets, in semitone intervals. The transpose range is ± 24 semitones.

Master Tune adjusts the fine tuning of all presets so that you can tune Proteus 1000 to other instruments. The master tuning range is ± 1 semitone in 1/64th semitone increments (1.56 cents). A master tune setting of "+00" indicates that Proteus 1000 is perfectly tuned to concert pitch (A=440 Hz).

MASTER TRANSPOSE +00 semitones	TUNE +00
--	--------------------

Bend Range

The Bend Range parameter sets the range of the pitch wheel. This affects only presets that have their individual Pitch Bend range (defined in the Edit menu) set to Master. The maximum pitch bend range is ± 12 semitones or one octave in each direction.

MASTER BEND RANGE +/- 7 semitones

Velocity Curve

You can modify incoming velocity data by a velocity curve in order to provide different types of dynamics in response to your playing, or to better adapt to a MIDI controller. The Master Velocity Curve lets you select one of thirteen master velocity curves or to leave the data unaltered (linear).

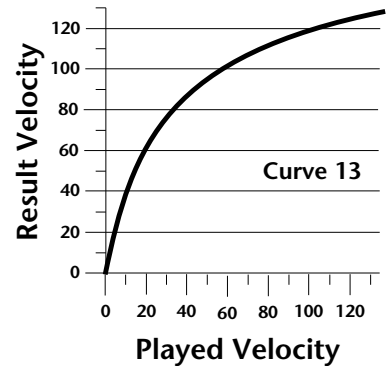
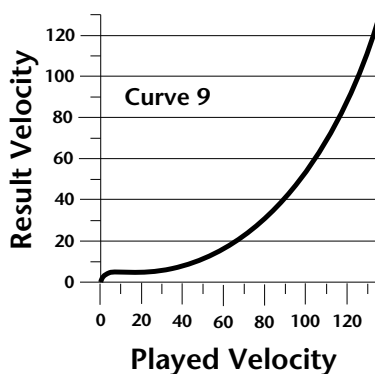
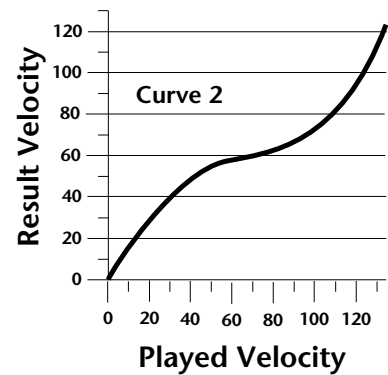
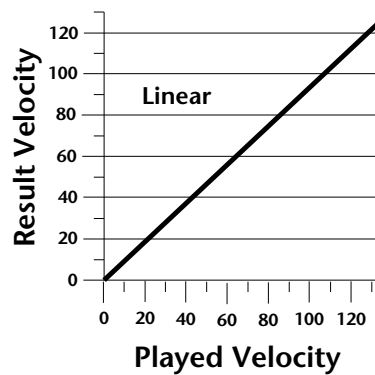
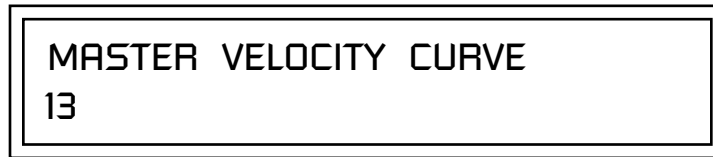

For a complete list of all available velocity curves, see "Velocity Curves" on page 186 of the Appendix.

Mix Output

The Mix Output parameter allows you to override the routing assignments made in each preset and instead assign the outputs according to MIDI channel. For each of the 16 MIDI channels, you can select Send 1-4, or Preset. When Preset is selected, the output assignment defined in the Preset Edit menu is used.

MIX OUTPUT
channel 16: use preset

MIX OUTPUT
channel 15: Send 1

The *Sends* function as effect processor inputs (effect sends). The four Effect Sends allow you to get the most out of the two effect processors. For example, with Effect B set to an echo algorithm, you could route one MIDI channel to Send 3 and set the effect amount to 80%. Another MIDI channel could be routed to Send 4 with an effect amount of only 5%. This is almost like having two different effects!

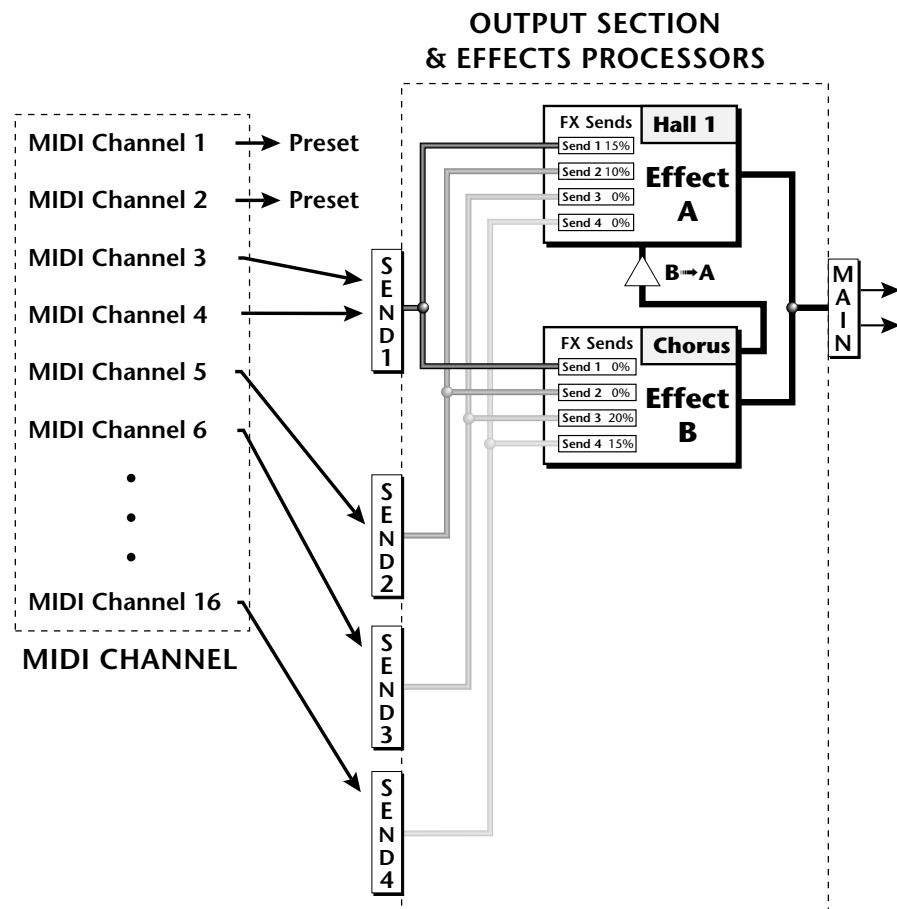

Master Effects

The digital effect processors can be programmed as part of the preset (using the Edit menu) so that effects will change along with the preset. However, there are only two effect processors, and so you cannot have a different effect on each preset when in Multi mode.

The Master Effects settings assign the effect processors “globally” for all presets to provide a way to use the effects in Multi mode. Detailed information is presented in the Effects chapter (see Effects on page 141).

Effects Mode

The FX Mode page enables or bypasses the effects. When the FX Mode is set to “bypass,” the effects are turned off on a global scale. This includes Effects programmed in the preset.

FX MODE
enabled

Effects Multi Mode Control

The routing scheme for the two stereo effects processors provides a lot of versatility. When in multi mode, you can “use master settings” which applies the Master menu effects settings to all 16 MIDI channels.

FX MULTIMODE CONTROL
use master settings

If you want more control, you can use the “channel” setting which applies the effects settings of the preset on a specified channel to all the other channels. Changing the preset on the specified channel changes the effect.

FX MULTIMODE CONTROL
preset on channel 1

If you are in Omni or Poly modes this parameter is disabled and the message in parentheses explains that Proteus 1000 is currently in Omni mode.

FX MULTIMODE CONTROL
(using Omni mode)

Master FXA Algorithm

This function selects the type of effect used for the “A” effect. The following effect types are available.

MASTER FXA ALGORITHM

Room 1

A Effect Types

- | | |
|---------------------|-----------------------|
| 1. Room 1 | 23. BBall Court |
| 2. Room 2 | 24. Gymnasium |
| 3. Room 3 | 25. Cavern |
| 4. Hall 1 | 26. Concert 9 |
| 5. Hall 2 | 27. Concert 10 Pan |
| 6. Plate | 28. Reverse Gate |
| 7. Delay | 29. Gate 2 |
| 8. Panning Delay | 30. Gate Pan |
| 9. Multitap 1 | 31. Concert 11 |
| 10. Multitap Pan | 32. Medium Concert |
| 11. 3 Tap | 33. Large Concert |
| 12. 3 Tap Pan | 34. Large Concert Pan |
| 13. Soft Room | 35. Canyon |
| 14. Warm Room | 36. DelayVerb 1 |
| 15. Perfect Room | 37. DelayVerb 2 |
| 16. Tiled Room | 38. DelayVerb 3 |
| 17. Hard Plate | 39. DelayVerb 4 Pan |
| 18. Warm Hall | 40. DelayVerb 5 Pan |
| 19. Spacious Hall | 41. DelayVerb 6 |
| 20. Bright Hall | 42. DelayVerb 7 |
| 21. Bright Hall Pan | 43. DelayVerb 8 |
| 22. Bright Plate | 44. DelayVerb 9 |

*FXA Parameters:
Decay/HF Damping
FxB -> FxA*

This page lets you define the parameters of the selected Effects algorithm. Use this page to setup the effect decay, high frequency damping amount and to route "B" effects through the "A" effects. See "Effect Parameters" on page 143 for more details.

FXA	DECAY	HFDAMP	FxB>FxA
	040	096	001

FXA Send Amounts

These parameters set the effects amounts for each of the four stereo effects busses. See "Master Effects" on page 146 for detailed information.

FXA SEND AMOUNTS	1:100%
2: 50%	3: 10%
	4: 0%

*Master FXB
Algorithm*

This parameter selects the type of effect used for the "B" effect. The following effect types are available.

MASTER FXB ALGORITHM
Chorus 1

B Effect Types

- | | |
|----------------|------------------------|
| 1. Chorus 1 | 17. Ensemble |
| 2. Chorus 2 | 18. Delay |
| 3. Chorus 3 | 19. Delay Stereo |
| 4. Chorus 4 | 20. Delay Stereo 2 |
| 5. Chorus 5 | 21. Panning Delay |
| 6. Doubling | 22. Delay Chorus |
| 7. Slapback | 23. Pan Delay Chorus 1 |
| 8. Flange 1 | 24. Pan Delay Chorus 2 |
| 9. Flange 2 | 25. Dual Tap 1/3 |
| 10. Flange 3 | 26. Dual Tap 1/4 |
| 11. Flange 4 | 27. Vibrato |
| 12. Flange 5 | 28. Distortion 1 |
| 13. Flange 6 | 29. Distortion 2 |
| 14. Flange 7 | 30. Distorted Flange |
| 15. Big Chorus | 31. Distorted Chorus |
| 16. Symphonic | 32. Distorted Double |

FXB Parameters: Feedback/LFO Rate Delay Time

The FXB parameters setup the characteristics of the effect. Use this page to define the feedback amount, the LFO rate and delay amount for the selected type “B” effect. See “Effect Parameters” on page 143 for details.

FXB	FEEDBK	LFORATE	DELAY
	000	003	0

FXB Send Amounts

These parameters set the effects amounts for each of the four stereo effects busses. See the Effects chapter for detailed information.

FXB SEND AMOUNTS	1:100%
2: 50%	3: 10%
	4: 0%

MIDI Parameters

MIDI Mode

MIDI parameters control how the Proteus 1000 sends and receives MIDI data.

MIDI Mode selects one of the three MIDI modes: Omni, Poly or Multi mode.

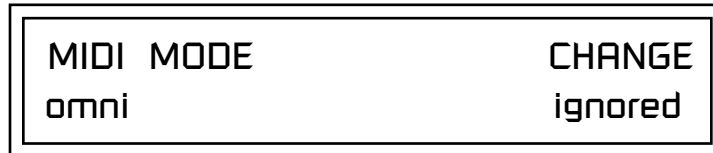

The **MIDI Mode Change** parameter specifies whether mode changes made through an external MIDI controller are accepted or ignored.

The MIDI modes are as follows:

Omni

Responds to note information on all MIDI channels and plays the preset currently displayed in the main screen.

Poly

Responds only to note information received on the currently selected MIDI channel (on the preset selection screen) and plays that channel's associated preset.

Multi

Responds to data on any combination of MIDI channels and plays the specific preset associated with each of the MIDI channels. You must select multi mode for multitimbral operation.

MIDI SysEx ID



WARNING: When transferring SysEx data from one Proteus 1000 to another, the ID numbers of both units must be the same.

This page defines the MIDI system exclusive (SysEx) device ID number. The SysEx ID lets an external programming unit to distinguish between multiple Proteus 1000 units connected to the same preset editor. In this case each unit must have a unique SysEx ID number.

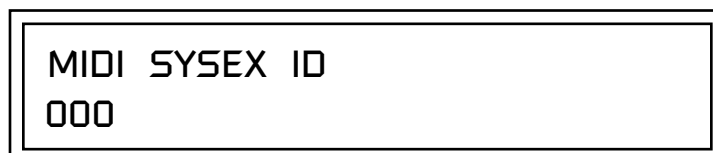

MIDI Enable

MIDI Enable lets you turn each MIDI channel on and off independently when in Multi mode. This feature is helpful when you have other devices connected to the same MIDI line and do not want the Proteus 1000 unit to respond to the MIDI channels reserved for the other devices.

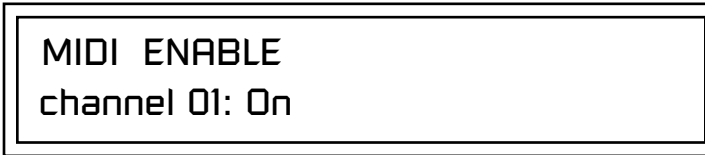

Because the MIDI Enable function only makes sense if you are in Multi mode, Proteus 1000 disables this feature when in Omni or Poly mode.

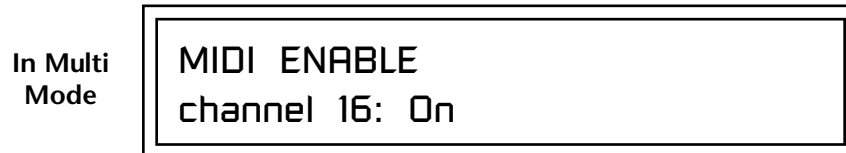

MIDI Program Change -> Preset

You can also remap incoming MIDI program changes to a different numbered preset. This is a handy feature when your master keyboard cannot send a bank change or you want to reorder preset numbers. Any preset can be mapped to any incoming MIDI program change number.

For example, you could set up the Program -> Preset map to call up preset #12 whenever Proteus 1000 receives MIDI program change #26.

The four fields shown below are editable.

 The Program->Preset Change only works for program changes received in Bank 0.

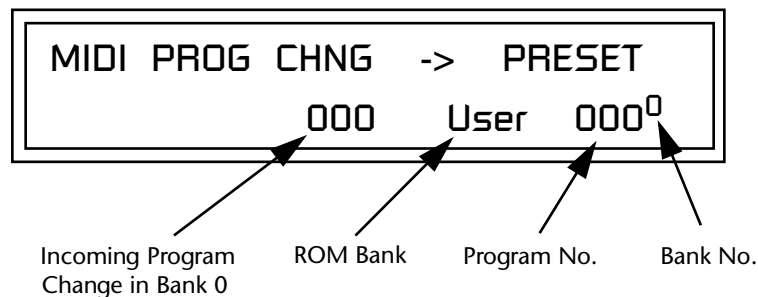

 Programs and presets are the same thing. "Preset" is E-MU's term for MIDI Program.

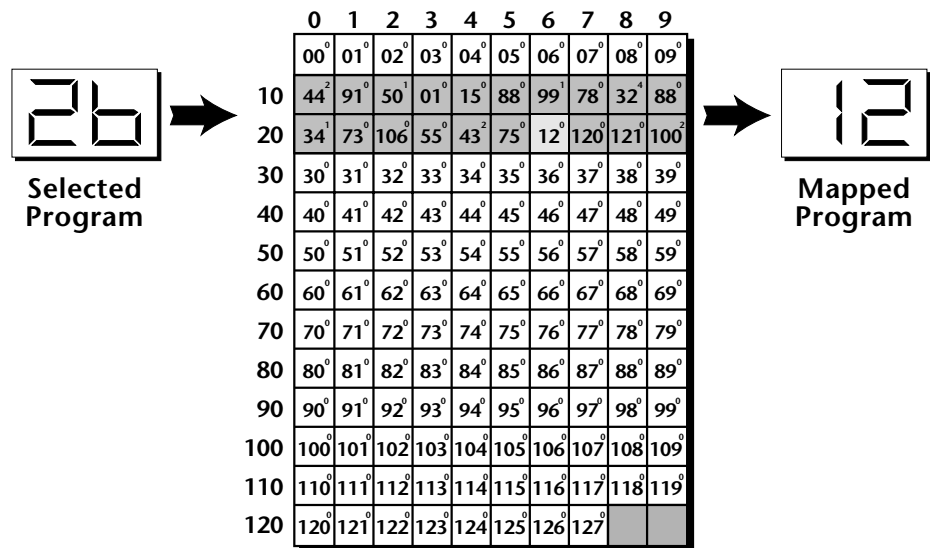

In this chart, program changes 10-29 have been remapped to new preset numbers. All other presets are selected normally.

Receive Program Change

Use this function to instruct the Proteus 1000 to utilize or ignore incoming MIDI preset changes or Bank Select commands for each channel. Use the cursor buttons to select the channel number field, then use the Data Entry Control to select a channel number. Use the cursor button again to select the On/Off field and the Data Entry Control to change the value.

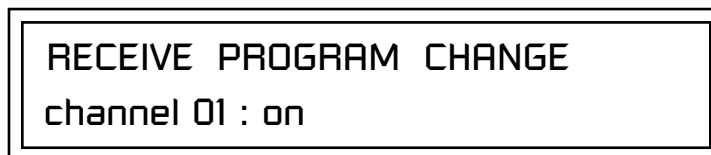

Real-time Controller Assignment

Use these three pages to assign twelve real-time control sources. Each MIDI Controller is assigned a letter (A - L). The front panel Controller Knobs and twelve MIDI controller numbers share the A-L controller routings. **These screens let you select which MIDI real-time controllers numbers will be received (from 1 to 31 and from 64 to 119) and which controller numbers will be transmitted over MIDI if the front panel controls are turned.** The PatchCord routing and amount in the Edit menu determine what effect the controller has on each preset. Real-time controllers are shown in the PatchCord menu as MIDI A through MIDI L.

 Proteus 1000 factory presets have certain synth parameters assigned to each controller letter and so these are "Global" controller assignments.

For example, assigning a MIDI controller to "A" in this screen would let you control filter Fc for all the factory presets. See "Front Panel Knob Functions" on page 163.

The Real-time Controller assignment also specifies which controller numbers are transmitted when the "Knobs MIDI Out" is enabled (see "Knobs/Riff MIDI Out" on page 48).

REALTIME CONTROLLER #			
A: 21	B: 22	C: 23	D: 24

REALTIME CONTROLLER #			
E: 25	F: 26	G: 27	H: 28

REALTIME CONTROLLER #			
I: 80	J: 81	K: 91	L: 93

Note: Controllers 7 and 10 are already assigned to Volume and Pan for each MIDI channel. Controllers 91 & 93 are the standard controller numbers for reverb and chorus send amounts.

Following are a few of the standardized MIDI Controller numbers as defined by the MIDI manufacturers association. The controllers shown in **Bold** are automatically routed to the destination (volume & pan) or have their own PatchCord source. Others, such as Portamento Time, can be routed using a PatchCord to have the desired effect.

- | | |
|-----------------------------|------------------------|
| 1 - Modulation Wheel | 7 - Volume |
| 2 - Breath Controller | 8 - Balance |
| 3 - Old DX7 Aftertouch | 9 - Undefined |
| 4 - Foot Pedal | 10 - Pan |
| 5 - Portamento Time | 11 - Expression |
| 6 - Data Entry | |

MIDI Footswitch Assign

Like the MIDI Controllers, you can assign three MIDI footswitches to MIDI footswitch numbers. Footswitches numbers are from 64-79. Destinations for the footswitch controllers are programmed in the PatchCord section of the Edit menu.

FOOTSWITCH CONTROLLER #		
1: 64	2: 65	3: 66

Following are a few of the standardized MIDI Switch numbers.

64 - Sustain Switch (on/off)	67 - Soft Pedal (on/off)
65 - Portamento (on/off)	69 - Hold Pedal 2 (on/off)
66 - Sostenuto (on/off)	

Tempo Controller

This function allows a MIDI controller to change the Base Tempo of the Master Clock. The Master Clock is used for the clock divisor PatchCords, tempo-based envelopes and synced LFOs. (See “Clock Modulation” on page 62.) You can assign any controller number from 0-31, mono key pressure, or the pitch wheel to change the Global Tempo.

A different controller can be used to change the tempo up or down. The Pitch Wheel can be assigned to both the up and down parameters to vary the tempo up and down from a single controller. If any other controller is assigned to both the up and down parameters, Proteus 1000 redefines the center of the controller’s range as zero (so it acts like a pitch wheel).

MIDI Controller values are added to the Base Tempo with a range of ± 64 . When the controller is set to “off” the tempo returns to its original setting. This control has no effect when using an external clock.

TEMPO CONTROLLER#	CHAN
Up: 03 Down: 09	16

Knob Preset Quick-Edit

 Quick Edit does not work while in the Edit menu with “Knobs Deep Edit” enabled.

“Quick-Edit” changes the initial controller setting in the preset whenever you move a Control Knob. This parameter selects whether or not the front panel Controller Knobs are used to Quick-Edit the currently selected preset. See “Real-time Control” on page 23 in the Operations chapter for more details.

<p>KNOBS PRESET QUICK-EDIT disabled</p>
--

Knobs Deep Edit

This parameter specifies whether or not the front panel controller knobs can be used to edit parameter values in the Master or Edit menus. This is called “Deep-Editing.” With Knob Deep Edit disabled, the front panel controller knobs retain their function as real-time controllers even when in the Master or Edit modes.

KNOBS DEEP EDIT
disabled

Knobs/Riff MIDI Out

This function allows you to select whether or not MIDI controller data is transmitted when you turn the front panel Controller knobs. The knobs transmit on the controller numbers defined by the Real-time Controller Assign parameter (see page 45). This function also enables or disables transmission of Riff note data over MIDI when the Audition button is pressed.

If Deep Edit is enabled, “Knobs MIDI Out” does not work while in any of the editing menus (Master, Edit, Save/Copy).

KNOBS/RIFF MIDI OUT
don't transmit

Preset Edit All Layers Enable

This function allows you to turn the Edit All Layers feature on or off. “Edit All Layers” is an Edit menu feature which allows you to select all layers (A) in order to edit all four layers simultaneously. Because this feature can be confusing to the beginning programmer, it can be disabled here in the Master menu. Check this feature out when you’re ready. It’s great!

PRESET EDIT ALL LAYERS
enabled

Front Panel Knob Calibration

This function calibrates the minimum and maximum values for the five front panel knobs. The controls should be calibrated periodically in order to compensate for normal wear and tear on the controls themselves or if the controls behave strangely. Before calibration, it's usually a good idea to let the unit warm up for about half an hour to ensure you have the maximum range on all the front panel controls.

► To Calibrate the Front Panel Control Knobs

1. Press the Master menu button and advance to the Calibrate Knobs page.

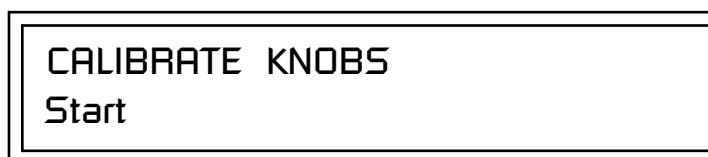

CALIBRATE KNOBS
Start

2. Press the Enter button to begin the calibration process. The following screen appears.

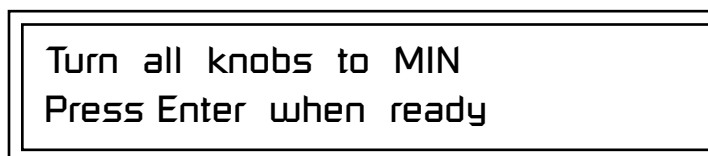

Turn all knobs to MIN
Press Enter when ready

3. Turn all knobs to their minimum value (which is pegged in the counter-clockwise direction), then press the Enter button. The screen briefly flashes, "Reading Values...", then displays:

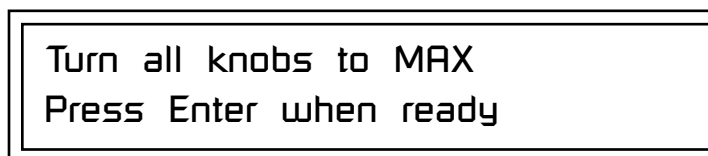

Turn all knobs to MAX
Press Enter when ready

4. Turn all knobs to their maximum value (pegged in the clockwise position), then press the Enter button. The display shows, "Reading Values... Done." Calibration is complete.

MIDI SysEx Packet Delay

Sometimes errors occur if the computer or sequencer to which you are sending MIDI SysEx data is faster or slower than the Proteus 1000. The MIDI SysEx Packet Delay command lets you specify the amount of delay between MIDI SysEx packets so the input buffer of your computer does not overflow, causing an error. The value range is from 0 through 8000 milliseconds. A delay value of zero allows full speed MIDI transfer. If you are experiencing data transmission errors, try increasing the delay value until the problem disappears.

MIDI SYSEX PACKET DELAY
300 milliseconds

Send MIDI System Exclusive Data

This command transmits MIDI System Exclusive (SysEx) data to the MIDI Out port of Proteus 1000. The MIDI data can be sent to a computer, sequencer or to another Proteus 1000. When transferring data between two Proteus 1000 units, make sure both have the same SysEx ID number! See "MIDI SysEx ID" on page 43 to learn how to change the SysEx ID.

Using the cursor key and the Data Entry Control, select the type of MIDI data you want to transmit. Following are descriptions of the types of MIDI data that can be transmitted.

Current Multisetup

Transmits all parameters in the Master menu except Tuning Tables, Program/Preset Map and Viewing Angle.

Program /Preset Map

Transmits the MIDI Program -> Preset Map.

All User Tuning Tables

Transmits all 12 user User Tuning Tables.

Multimode Map

Transmits the following parameters:

- Multimode Basic Channel
- Multimode Effects Control Channel
- Multimode Tempo Control Channel

and for each MIDI Channel...

- Preset, Volume, & Pan
- Mix Output
- Multimode Channel Enable
- Multimode Bank Map
- Multimode Receive Program Change

 The Preset, Volume, and Pan information for all 16 channels is included when the Multi mode Map settings are transmitted or received.



WARNING: When transferring SysEx data from one Proteus 1000 to another, the ID numbers of both units must match.

Bank 0 User Presets

Transmits all the user defined presets in Bank 0.

Bank 1 User Presets

Transmits all the user defined presets in Bank 1.

Bank 2 User Presets

Transmits all the user defined presets in Bank 2.

Bank 3 User Presets

Transmits all the user defined presets in Bank 3.

Any Individual Preset

Transmits only the selected preset.

All User Arp Patterns

Transmits all user arpeggiator patterns.

All User Data

Transmits ALL: user presets, user tuning tables, user arp patterns, and user multisetups.

The Enter LED will be flashing. Press the Enter button to confirm the operation. To receive MIDI data, simply send the MIDI data into Proteus 1000 from another Proteus 1000 or from a computer/sequencer.



► To Record MIDI SysEx Data into a Sequencer:

1. Setup the sequencer to receive system exclusive data.
2. Place the sequencer into record mode, then Send MIDI Data.

► To Receive MIDI SysEx Data from a Sequencer:

Simply play back the sequence containing the SysEx data into Proteus 1000.

User Key Tuning

 The user key tuning can be used to tune individual percussion instruments.

User Key Tuning lets you create and modify 12 user definable tuning tables. The initial frequency of every key can be individually tuned, facilitating the creation of alternate or microtonal scales.

Using the cursor keys and the Data Entry Control, select the user table number, the key name, the coarse tuning and the fine tuning. The key name is variable from C-2 to G8. Coarse Tuning is variable from 0 to 127 semitones. The fine tuning is variable from 00 to 63 in increments of 1/64 of a semitone (approx. 1.56 cents). For each preset, the specific tuning table is selected in the Edit menu.

USER KEY TUNING	Table: 1
Key: C1	Crs: 036
	Fine: 00

Base Tempo

Proteus 1000 contains an internal master clock which can be used to: synchronize the LFOs when in Tempo-based mode, control the times of Tempo-based envelopes or used as a modulation source in the PatchCords section. There are two tempo values shown in the display.

- **Base Tempo** - The base tempo is the value to which the MIDI controller specified in the Tempo Controller screen will be applied. (See “Tempo Controller” on page 47.)
- **Current Tempo** - The current tempo is equal to the base tempo modulated by the MIDI controller specified in the Tempo Controller screen. If no MIDI Tempo controller message has been received since the last Base Tempo change, the Current Tempo will be equal to the Base Tempo.

Current Tempo is NOT displayed when the Base Tempo is set to “MIDI Clock”.

► To Change the Master Tempo:

1. Move the cursor to the lower line of the display.
2. Adjust the Base Tempo using the Data Entry Control.

BASE TEMPO
120 bpm (current: 182)

The Master Tempo values range from 1 through 300 beats per minute (BPM) or you can select “use MIDI clock” to use an external MIDI clock source.

Screen Viewing Angle

This function changes the viewing angle of the display so that you can read it easily from either above or below the unit. The angle is adjustable from +7 to -8. Positive values will make the display easier to read when viewed from above. Negative values make the display easier to read from below.

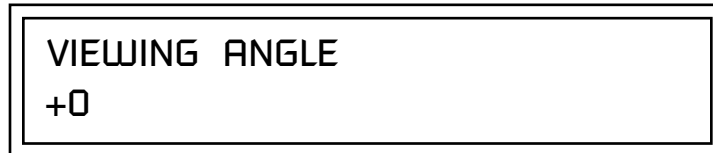



Programming Basics

This chapter explains how Proteus 1000 sounds are constructed and contains important background information on how to create your own custom presets.

Your initial involvement with Proteus 1000 will most likely be using the existing presets and selecting MIDI channels. While the factory presets are very good, there are some things you will probably want to change eventually, perhaps the LFO speed, the filter frequency or the attack time. You may also want to make your own custom presets using complex modulation routings. This module will do far more than you ever imagined and there are whole new classes of sound just waiting to be discovered.

Each preset can consist of up to four instrument layers. Each of the four layers can be placed anywhere on the keyboard and can be crossfaded or switched according to key position, velocity, or by using a real-time control such as a wheel, slider, pedal, LFO or envelope generator. A preset can also be “linked” with up to 2 more presets creating additional layering or splits.

Proteus 1000 has an extensive modulation implementation using two multi-wave LFO's (Low Frequency Oscillators), three multi-stage envelope generators and the ability to respond to multiple MIDI controllers. You can simultaneously route any combination of these control sources to multiple destinations.

There are 512 user locations (USER Banks 0-3) available to store your own creations or edited factory presets. It's easy and fun to edit or create your own unique presets.

Modulation

To modulate means to dynamically change a parameter, whether it be the volume (amplitude modulation), the pitch (frequency modulation), and so on. Turning the volume control on your home stereo rapidly back and forth is an example of amplitude modulation. To modulate something we need a modulation source and a modulation destination. In this case, the source is your hand turning the knob, and the destination is the volume control. If we had a device that could turn the volume control automatically, we would call that device a modulation source.

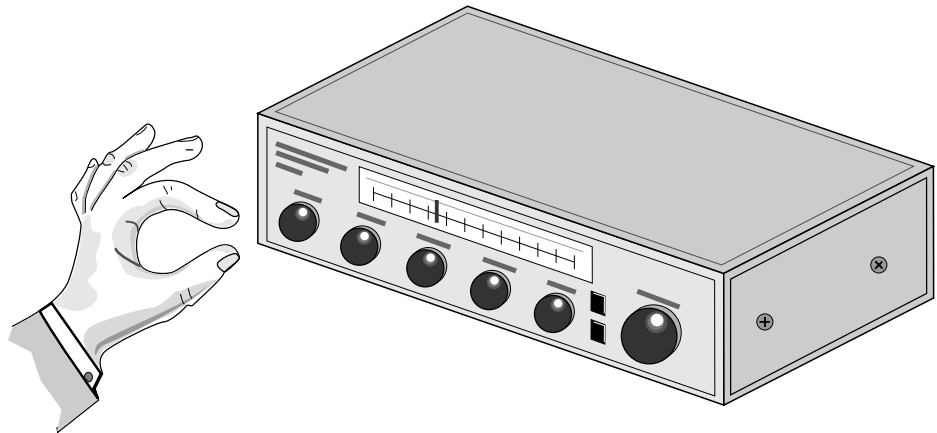

Turning the volume control back and forth on your home stereo is an example of Amplitude Modulation.

Proteus 1000 is designed so that each of the variable parameters, such as the volume, has an initial setting which is changed by a modulation source. Therefore in the case of volume, we have an initial volume that we can change or modulate with a modulation source.

Two main kinds of modulation sources on Proteus 1000 are *Envelope Generators* and *Low Frequency Oscillators*. In the example above, an envelope generator could be routed to automatically turn the volume control as programmed by the envelope. Or, a low frequency oscillator could be routed to turn the volume up and down in a repeating fashion.

Positive modulation adds to the initial amount. Negative modulation subtracts from the initial amount.

Summing Nodes

All the modulation inputs on Proteus 1000 are summing nodes. This means that you can connect as many modulation sources as you want to an input (such as *Pitch* or *AmpVol*). Modulation sources are simply added algebraically—connecting two knobs one set to -100 and the other set to +100 yields a net value of zero.

Modulation Sources



Tip: Try routing Key Glide to Filter Frequency if you want the filter to smoothly follow pitch in solo mode. Routing Key Glide to Pan creates another interesting effect.

Modulation sources include *Envelope Generators*, *Performance Controllers* and *Low Frequency Oscillators*. In the previous example, an envelope generator was routed to automatically turn the volume control as programmed by the envelope, or, a low frequency oscillator could be routed to turn the volume control up and down in a repeating fashion. The following is a list of the modulation sources used in Proteus 1000.

Keyboard Key

Which key is pressed.

Key Velocity

How fast the key is pressed.

Release Velocity

How fast the key is released.

Gate

High if the key is pressed, low when the key is released.

Key Glide

A smoothly changing control source based on the Glide Rate and the interval between the last two notes played.

Pitch and Mod Wheels

Synthesizer pitch bend and modulation wheels.

Keyboard Pressure (mono aftertouch)

Key Pressure applied after the key is initially pressed.

Pedal

A continuously variable pedal controller.

Miscellaneous Controllers A -L

Any type of MIDI continuous controller data.

Low Frequency Oscillators (2 per layer)

Generate repeating waves.

Envelope Generators (3 per layer)

Generate a programmable “contour” which changes over time when a key is pressed.

Noise & Random Generators

Generate spectrums of noise and random signals.

Footswitches

Change a parameter when the switch is pressed.

Clock Divisor

The master tempo clock can be divided and used as a modulation source.

Random Sources

Random modulation sources can be used when you want the timbre of the sound to be “animated” in a random or non-consistent manner.

- **Key Random 1 & 2** generate different random values for each layer which do not change during the note.
- The **White & Pink Noise** Generators produce varying random values. Both white and pink noise sources are low frequency noise designed for control purposes. Either noise source can be filtered even more by passing it through a lag processor.
- The **Crossfade Random** function generates the same random value for all layers in a preset. This source is designed to be used for cross-fading and cross-switching layers, although you may find other uses.

Modulation PatchCords

 The controller Knobs assignments printed on the front panel are the system defaults. You can change any of these assignments using the Real-time Controller Assignment page in the Master menu (see page 45 for details).

When setting up modulation with the Proteus 1000, you define a modulation source and a modulation destination. Then, you connect the source to the destination using “PatchCords.” Proteus 1000’s PatchCords are connected in the software. Proteus 1000 has 24 general purpose PatchCords for each layer.

You can connect the modulation sources in almost any possible way to the modulation destinations. You can even modulate other modulators. Each PatchCord also has an amount parameter which determines “how much” modulation is applied to the destination. The modulation amount can be positive or negative. Negative values invert the modulation source.

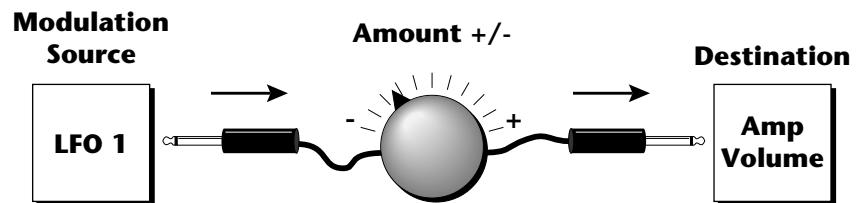

Envelope Generators



If two adjacent segments have the same level in a “time-based” envelope, the segment will be skipped. Adjacent segments must have different levels for the rate control to work.

An envelope can be described as a “contour” which is used to shape the sound over time in a pre-programmed manner. There are three envelope generators per layer and all of them are the rate/level type.

This is how the rate/level (*time based*) envelopes work: When a key is pressed, envelope starts from zero and moves toward the Attack 1 Level at the Attack 1 Rate. As soon as it reaches this first level, it immediately begins the next phase and moves toward the Attack 2 level at the Attack 2 rate. As long as the key is held down, the envelope continues on through the Decay 1 and Decay 2 stages. If the key is still held when the envelope reaches the end of Decay 2, it simply waits there for you to release the key. When you release the key, the envelope continues into the Release 1 and Release 2 stages, stopping at the end of the Release 2 stage. Proteus 1000’s envelope generators provide great flexibility for programming both complex and simple envelopes.

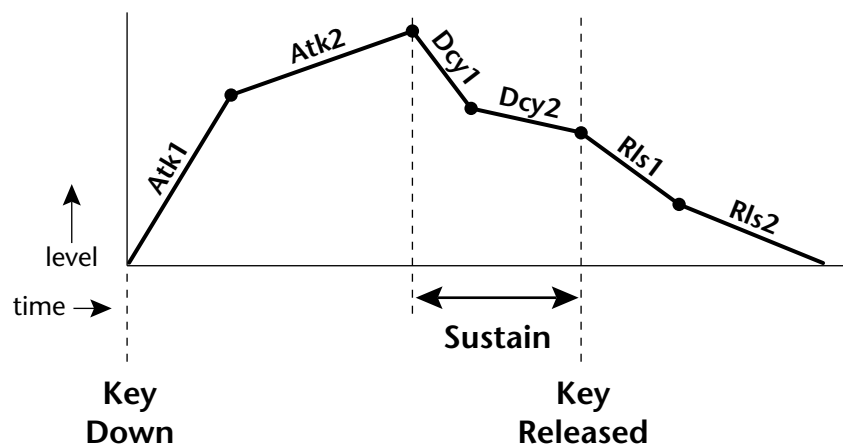

All three envelope generators have the six stages described above. The Volume Envelope generator controls the volume of the voice over time. The Filter Envelope generator is a general purpose envelope most often used to control the filter frequency. Unlike the Volume Envelope, however, the Filter Envelope can have a negative level value as well as a positive level. There is also an Auxiliary Envelope generator which is a general purpose envelope. The Auxiliary Envelope is identical to the Filter Envelope and can have negative as well as positive levels. You can adjust the time of each stage to create myriad envelope shapes, which in turn shape the sound over time.



By routing the Auxiliary or Filter Envelopes to control the pitch (PatchCords) you can easily hear the shape of the envelopes you are creating.

- Volume envelopes contour the way the volume of a sound changes over time determining how we perceive that sound. For example, a bell struck with a hammer is instantly at full volume, then slowly dies away. A bowed violin sound fades in more slowly and dies away slowly. Using Proteus 1000’s Volume Envelope, you can simulate the different types of natural instrument volume envelopes by programming them appropriately.

 See also "Base Tempo" on page 54 for a detailed explanation.

Tempo-based Envelopes

Tempo-based envelopes are based on *Time* which is controlled by the Base Tempo (located in the *Arp/Beats* menu). The Base Tempo rate scales the time of the Tempo-based envelope segments. The Base Tempo can also be set to use an external MIDI clock so that the envelope times can be synchronized to external sequencer or arpeggiator tempo changes.

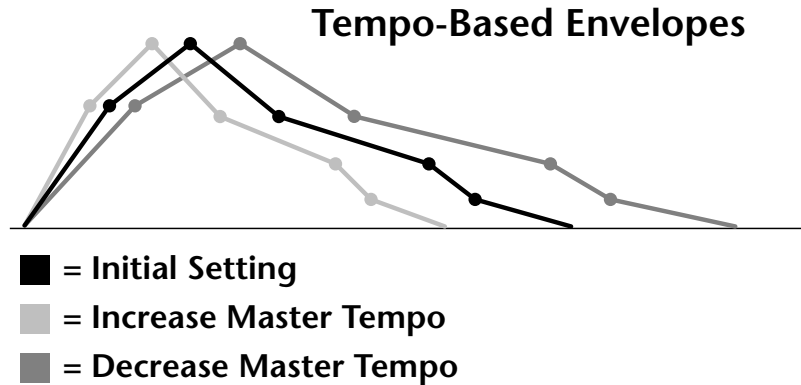

Envelope Repeat

The Envelope Generators can also be made to repeat. When the envelope repeat function is On, the Attack (1&2) and Decay (1&2) stages will continue to repeat as long as the key is held. As soon as the key is released, the envelope continues through its normal Release stages (1 & 2).

 Only the Filter and Auxiliary Envelopes have the repeating feature.

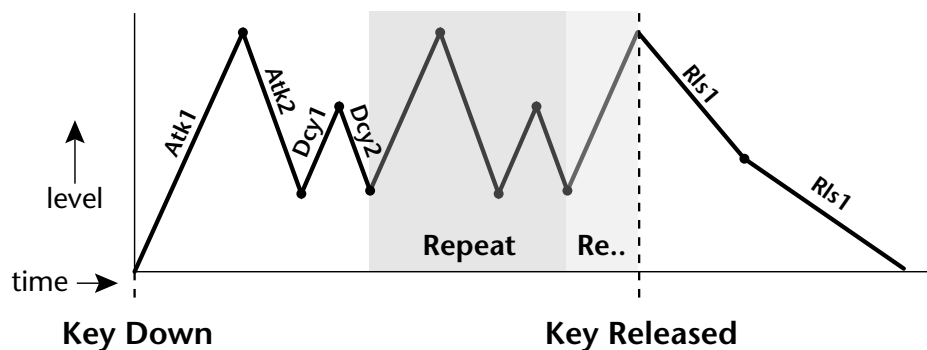

The diagram above show how the looping envelopes work. When the key is pressed the envelope goes through its regular Attack 1, Attack 2, Decay 1 and Decay 2 stages. In non-looping mode, the envelope would hold at the end of the Decay 2 stage until the key was released. In looping mode however, it jumps back to the Attack 1 stage and repeats the first four stages. It continues to loop through these four stages until the key is released where it immediately jumps to the Release 1 stage.

Low Frequency Oscillators (LFOs)

LFO Tricks & Tips:

- The Random LFO wave is truly random and is different for each voice and layer.
- The Pattern (Pat) waveforms will sound the same on different layers and voices.
- Sine + Noise is very useful for simulating trumpet and flute vibrato.

★ When routing Hemi-quaver to Pitch:

- +38 = major scale
- 38 = phrygian scale
- +76 = whole tone scale
- (+38) + (+76) = diminished (two cords)
- odd amount = S+H sound

Note: References to musical intervals in the pattern LFO shapes are with the LFO routed to pitch and a PatchCord amount of +38.

 Try combining the Pattern LFOs, or controlling the amount of one with another, or combining them with the clock divisors.

A Low Frequency Oscillator or LFO is simply a wave which repeats at a slow rate. The Proteus 1000 has two multi-wave LFOs for each channel. The LFO waveforms are shown in the following illustration.

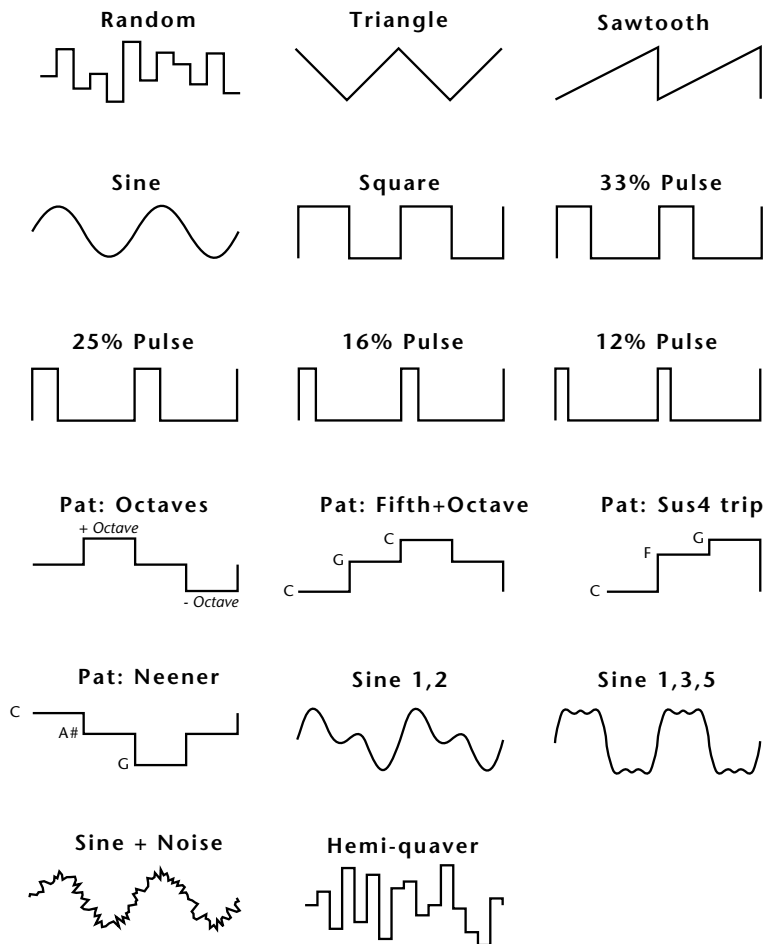

By examining the diagram of the LFO waveforms, you can see how an LFO affects a modulation destination. The shape of the waveform determines the result. Suppose we are modulating the pitch of an instrument. The sine wave looks smooth, and changes the pitch smoothly. The square wave changes abruptly and abruptly changes from one pitch to another. The sawtooth wave increases smoothly, then changes back abruptly. The sound's pitch follows the same course. Controlling the pitch of an instrument is an easy way to hear the effects of the LFO waves.

Like the Auxiliary Envelope, LFOs can be routed to control any real-time function such as Pitch, Filter, Panning, or Volume. A common use for the LFO is to control the pitch of the sound (LFO -> Pitch). This effect is called vibrato and is an important performance effect. Many presets use this routing with the modulation wheel controlling "how much" LFO modulation is applied. Another common effect, Tremolo, is created by controlling the volume of a sound with the LFO (LFO -> Volume).

You might use the LFOs to add a slight bit of animation to the sound by routing the LFO to control the filter. For this effect, set the LFO “amount” low for a subtle effect.

When a PatchCord amount is a negative value, the LFO shape is inverted. For example, inverting the sawtooth wave produces a wave that increases abruptly, then smoothly glides down.

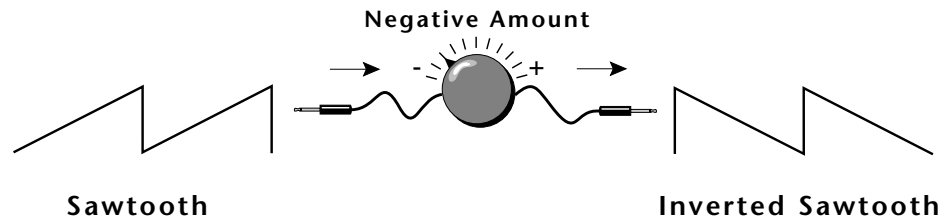

Clock Modulation

 Envelopes are triggered on the positive going edge of the clock. LFOs are triggered on the negative going edge of the clock.

 The tempo of the master clock is set in the Arp/Beats menu.

You can use the Master Clock as a modulation source, to trigger the Filter or Auxiliary Envelope generators, trigger Sample Start, synchronize the LFOs, or directly as a square wave modulation source. The Clock source is available in eight divisions (octal whole note, quad whole note, double whole note, whole note, half note, quarter note, eighth note, sixteenth note). You can use the different rates separately or in conjunction to create complex “synchro-sonic” rhythm patterns. You can also use a MIDI Clock as the Master Clock to synchronize to an external MIDI device such as a drum machine or sequencer. (See “Base Tempo” on page 54.)

Clocks are routed exactly like the other modulation sources using the PatchCords. The PatchCord Amount MUST be positive (+) for the clock to pass. By modulating the PatchCord Amount, you can route the divided clocks using real-time controllers or other modulation sources.

When an LFO is triggered by a clock, the LFO wave resets to zero every time the clock wave goes low. If the LFO rate is close to the clock rate, the LFO virtually synchronizes with the clock. If the two rates are far apart, the waveform of the LFO will be mildly or radically altered.

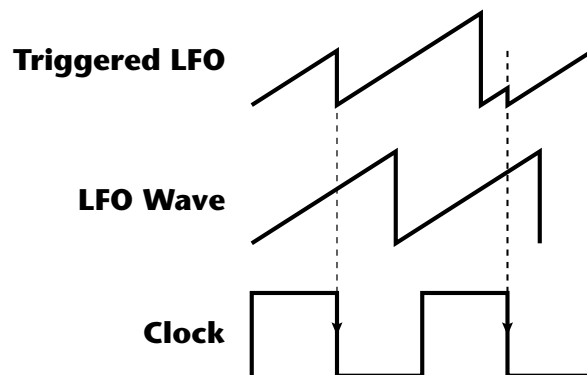

LFO Trigger causes the LFO to reset each time the clock waveform goes low.



LFO Synced to 1/4 Note Clock

LFOs can also be perfectly synchronized with the clock at any of 25 note divisions. This allows you to create very cool “synchro-sonic” effects that work perfectly at any tempo. Choosing one of the note divisors in the LFO rate screen selects the synced LFO function.

There are many possibilities for clock modulation and retrigger. For example, you can create a repeating six segment curve of any shape by triggering the Filter or Auxiliary Envelope generators with the clock. A few other possibilities are listed below.

- Turn different voice layers on and off using different clock divisors.
- Switch between Auxiliary and Filter Envelope retriggering using a slider or footswitch.
- Retrigger LFOs or Envelopes using noise or other LFOs to create random or semi random effects.
- Alter the LFO waveform by modulating the rate of a triggered LFO.
- Route multiple clocks with different divisors to the same destination (such as pitch) to create complex patterns. (*Hint: Adjust the PatchCord Amounts.*)

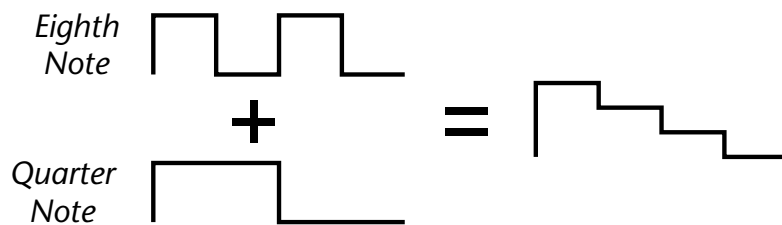

Adding these two clocks together in equal amounts produces a stairstep waveform.

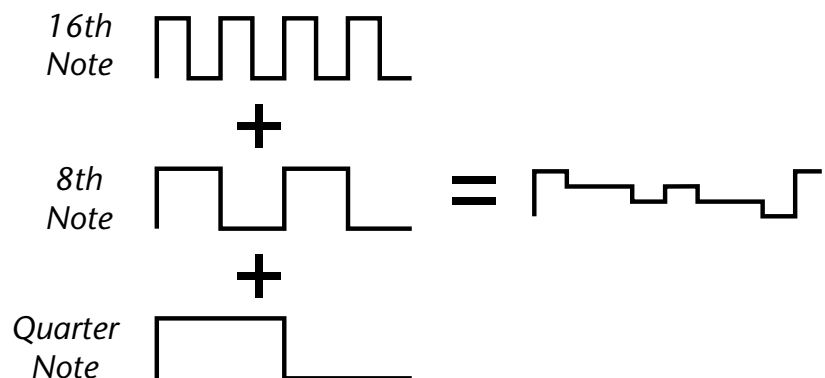

Adding multiple clocks with unequal amounts produces complex repeating patterns.

Modulation Destinations

The PatchCords section of the Edit menu is where you connect sources to destinations. Each PatchCord has an amount associated with it which controls how much modulation is applied.

L1	PATCHCORD	#01
	ModWhl ->	RTXfade +036

The PatchCords screen above and the diagram below show how modulation sources are connected to destinations. The modulation sources can control any of the destinations in the layer.

 All the modulation destinations are summing nodes. This means that you can connect as many modulation sources as you want to a destination. Modulation sources are simply added algebraically — connecting two sources, one with a value of -100 and the other with a value of +100 yields a net value of zero.

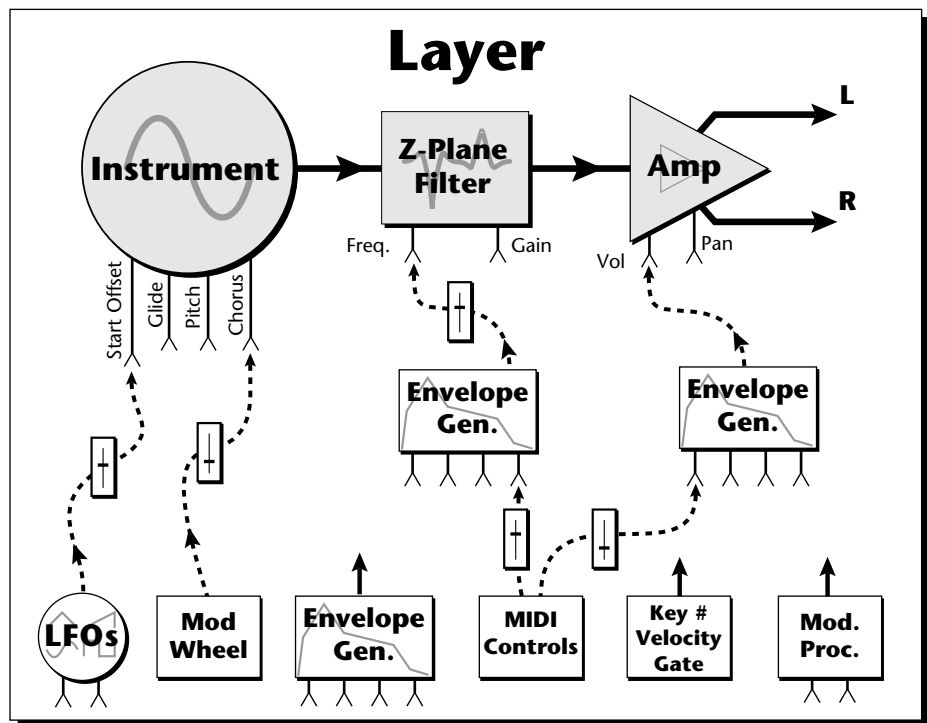

- Note-on modulation sources, such as key, velocity and gate output a single value at note-on time. Realtime modulation sources such as LFOs, envelope generators and modulation wheels output continuously changing values.

The possible modulation routings are completely flexible as shown in the diagram above. Multiple sources can control the same destination, or a single source can control multiple destinations.

Modulation Processors

Modulation processors are devices which can modify modulation sources such as LFOs and envelope generators before they are applied to a destination. Modulation processors let you create patches and do tricks which would not be possible otherwise. These modulation processors are independently programmable on each of the four layers.

Switch

Outputs a digital “1” when the input is greater than “0”.

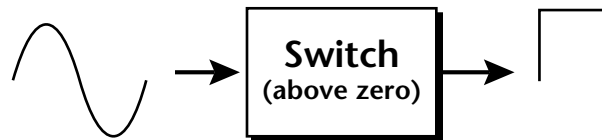

Summing Amp

Lets you add several modulation signals together before applying them to a destination. This processor can save PatchCords when routing the output to multiple destinations.

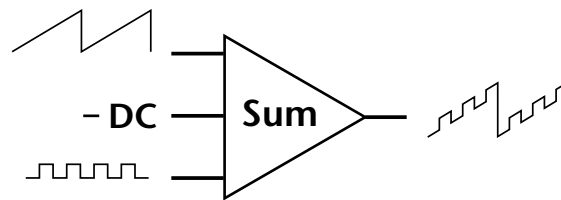

Lag Processors

Slows down rapid changes in the input signal. The output “lags” behind the input at a pre-programmed rate. There are two lag processors, Lag 0 and Lag 1. Lag 1 has a longer lag time than Lag 0.

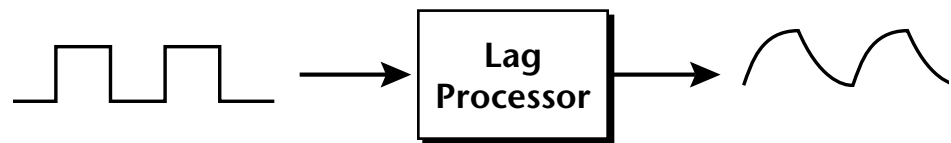

Absolute Value

This function inverts negative input values and outputs only positive values. This device is also called a full wave rectifier.

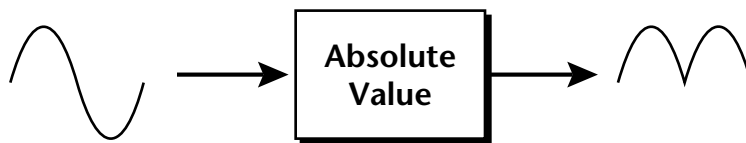

Diode

The diode blocks negative input values, passing only positive values.

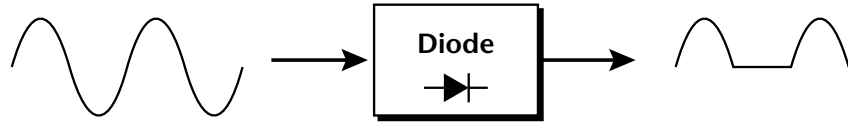

Flip-Flop

The output of this processor alternates between a digital "1" and digital "0" each time the input goes positive from zero or a negative value. With an LFO input, the output will be a square wave of half the input frequency.



Quantizer

With the input PatchCord set to 100%, the output value is limited to 16 discrete values. The value of the input PatchCord controls the number of steps. The value of the output PatchCord controls the size of the steps.

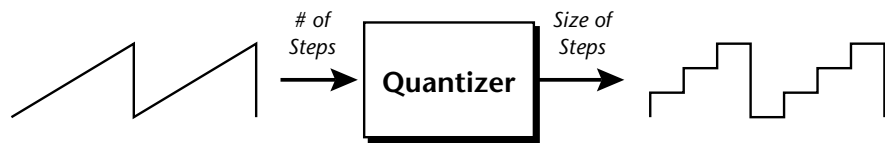

4x Gain

This processor amplifies the modulation source by a factor of 4.

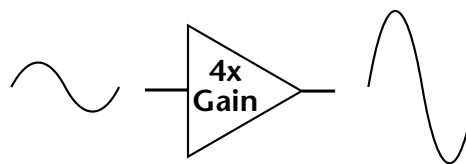

Lag Inputs

The Lag processors can be used as 2 additional summing amps. Lag0sum and Lag1sum are modulation sources which equal the sum of PatchCords connected to the Lag in destination. The summing amp is located before the lag processor as shown in the following illustration.

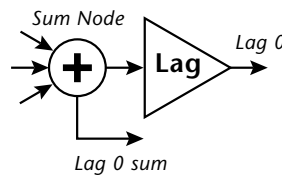

 The value of a digital "1" is equal to the PatchCord amount.

 Summing Amps can be useful in complicated patches where you want to control a combination of modulation signals with a single patchcord.

Preset Modulation Processors



Preset Modulation Processors start working as soon as the preset is selected. The Layer Modulation Processors take effect only when a key is pressed.

There are also two “Preset Level” modulation processors located in the “Preset Patchcords” screen of the Edit menu. It is important to understand that although the preset processors *originate* at the *Preset Level PatchCords*, their output is used in the *Layer PatchCords*.

Preset Lag

Like the Layer Lag processors (*described on page 65*) the Preset Lag slows down rapid changes in the input signal. The output “lags” behind the input at a pre-programmed rate. Unlike the layer level lag processors, the *preset lag* takes effect as soon as the preset is selected. In contrast, the layer level lag processors begin acting only after a keyboard key has been depressed. The Preset Lag also has a *Lag Amount* input which controls the lag time. Positive lag amounts increase the lag time. A MIDI controller (*front panel knob*) is commonly used to control lag amount.

The preset lag can be used to “spin-up” and “spin-down” an LFO which controls some other effect, perhaps left/right panning, pitch, or the filter. A MIDI footswitch could be used as the input to the lag which acts to slow down the instantaneous change of the switch. The slowly changing output value is then routed using a layer patchcord to crossfade between layers or change the speed of an LFO.

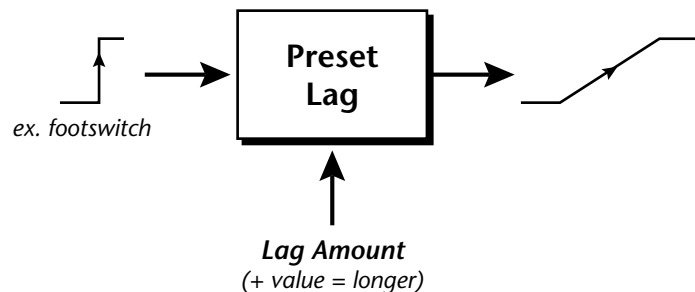

Preset Ramp

This processor generates a positive or negative going slope whenever the **first** key is depressed on the MIDI channel.

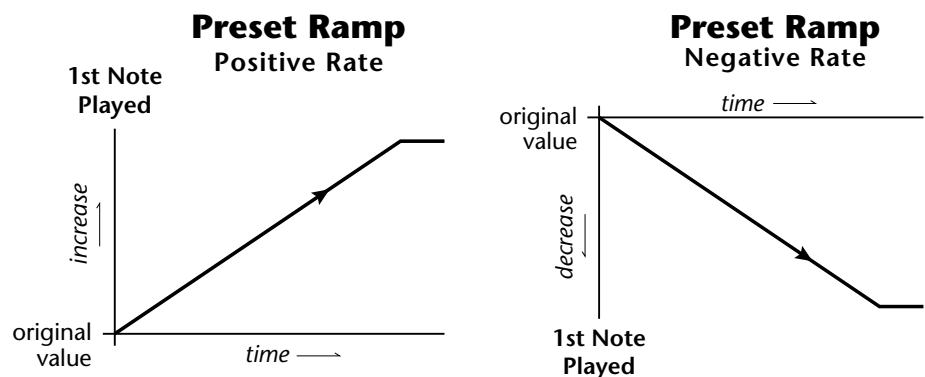

The preset ramp instantly resets when all notes have been released and the next *first key* on the MIDI channel is pressed. The Ramp Rate polarity (+ or -) determines if the ramp will be positive or negative going. The value of the ramp rate sets the increment. Large values produce fast ramps and small values produce slow ramps. Multiple inputs can be connected to the ramp rate (just like all the other destinations in Proteus 1000).

The patch below shows an application for the Preset Ramp which generates an adjustable decay envelope ONLY on the first note played to bring in the sound from another layer. Instead of routing the output to the Amp Volume you could just as easily route it to control Pitch, LFO Speed or any other destination you can think of. Study this patch if you want to learn a few new tricks using the patchcords.

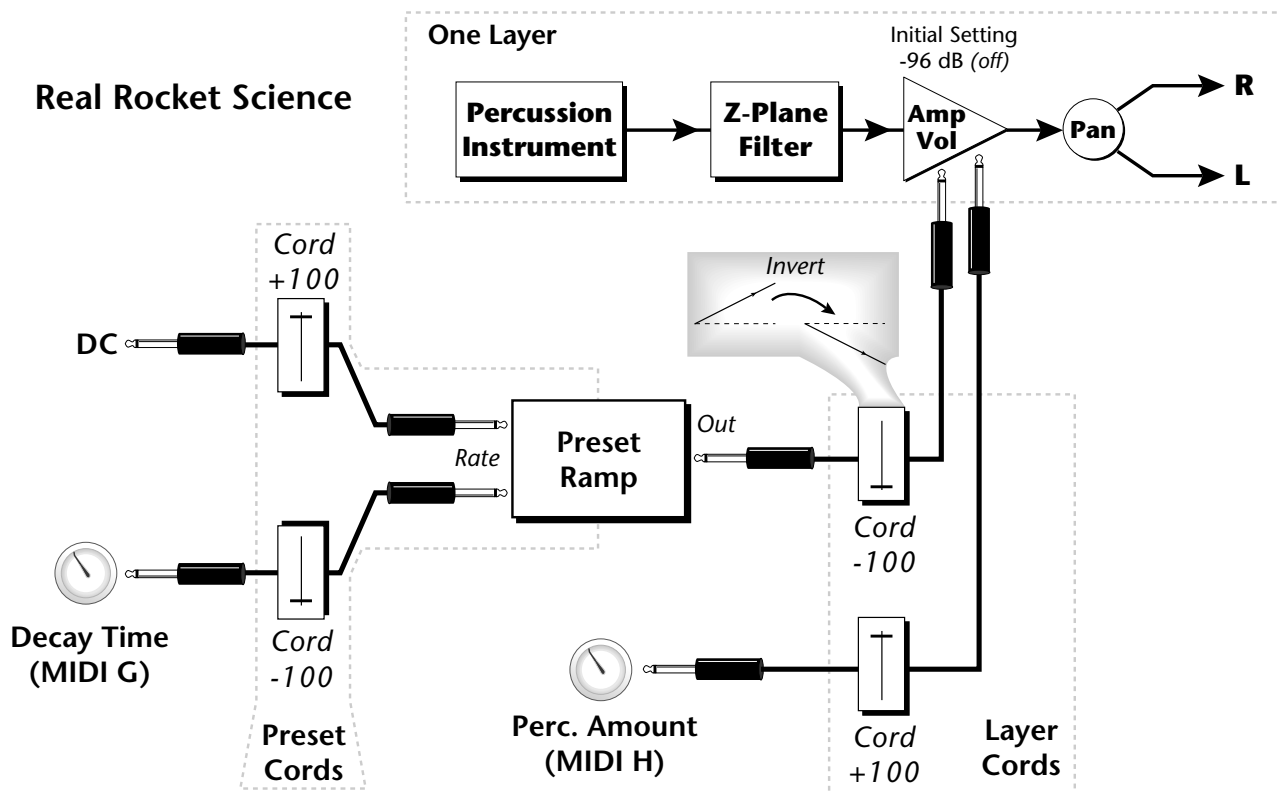

1. DC - Sets initial ramp Fast-Positive (+100)
2. Decay Knob - Inverted value slows ramp as the knob value is increased.
3. Ramp Out Cord - Inverts Ramp slope (downward).
4. Amp Vol - Initial setting is Off (-96dB). Ramp cannot overcome this negative bias.
5. Perc. Amt - When this knob is turned up, the positive bias on the Amp is restored so that so that the Ramp can now affect Amp Volume.
6. Volume Envelope - Fast Attack, Full Sustain, No Release

 The combination of the DC & Perc. Decay Time Cords has the effect of reversing the Percussion Decay Time knob. The decay time increases as the knob is turned up.

Using the Modulation Processors

Modulation processors are inserted into a modulation routing as shown in the following diagram.

The modular analog synthesizers of yesteryear were incredibly flexible, partly because processing devices could be connected in any order. Modulation processors are designed according to this modular concept. They can be linked and used in a wide variety of ways limited only by your imagination. Consider the following example:

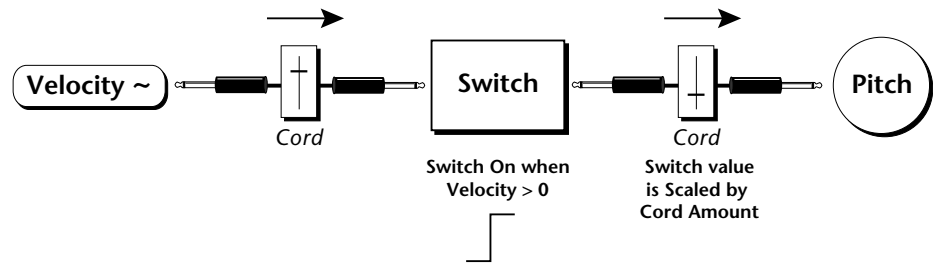

The patch illustrated above is programmed by setting the PatchCord screens as shown below.



This particular modulation shifts the overall pitch up a fifth when the key velocity exceeds 64. Velocities below 64 play at normal pitch. Notes with velocities of 64 and above are raised a perfect fifth. The Velocity “~” source scales the played velocity around zero. In other words, low velocities (below 64) will have negative values and high velocities (64 and above) will be positive. A velocity of 64 would be zero. The Switch module only outputs a “1” if the input value is greater than zero. This digital “1” value can be scaled through the attenuator on the PatchCord to raise or lower the pitch by any amount. In this case, a scaling value of +22 raises the pitch by a perfect fifth. The amount of the PatchCord on the input to the switch is unimportant because ANY velocity value equal or greater than 64 will flip the switch. If the input PatchCord amount were a negative value however, the action of the velocity would be reversed and velocities less than 64 would raise the pitch and velocities equal or greater than 64 would play the original pitch.

But what if you want the velocity switch point to be something other than 64? Thanks to modulation processors, it can be done. Here's how.

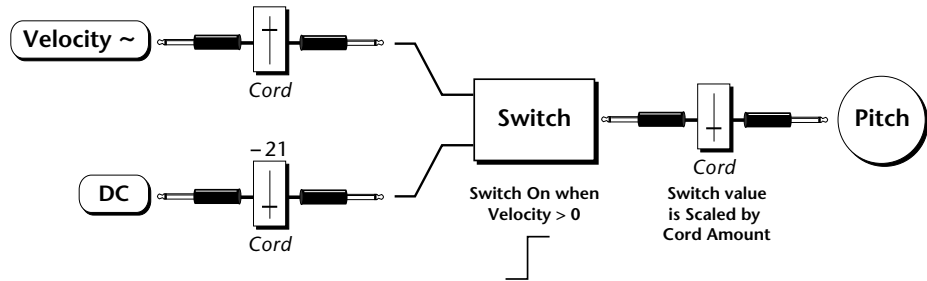

Connect the DC level to the input of the switch along with the velocity value. Note that more than one modulation source can be applied to the input of a processor.

DC offset adds a fixed value based on the PatchCord Amount setting. If applied to the switch along with the velocity, it changes the velocity value required to trip the switch. By setting the DC amount to a negative amount, higher velocity values are required to trip the switch. Setting the DC value to a positive value would bring the velocity switch point down. The PatchCord screens for this patch are shown below.

L1 PATCHCORD	#01
Vel+- -> Switch	+100

L1 PATCHCORD	#02
DC -> Switch	-021

L1 PATCHCORD	#03
Switch -> Pitch	+022

More Examples

To derive a smooth random function you could route the Pink Noise generator through one of the Lag Processors. A smooth random wave is useful in small amounts to add a degree of natural variation to timbre when routed to filter cutoff. Normal pink noise is low pass filtered audio frequency noise with a 3 dB/octave slope to give equal energy per octave. Proteus 1000 pink noise is actually more like very low frequency filtered noise, but it is perfect for use as a random control source.

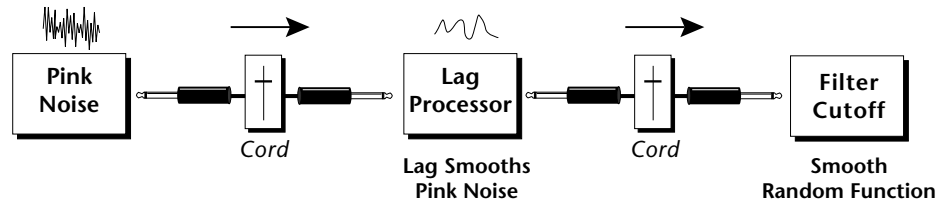

The **Quantizer** can generate interesting whole-tone scales when envelope generators or LFOs are routed to the input. The quantizer turns a smoothly changing input signal into a series of steps. By routing the output of the quantizer to Pitch and adjusting the PatchCord amounts, you can control both the number of steps and the pitch interval of each step.

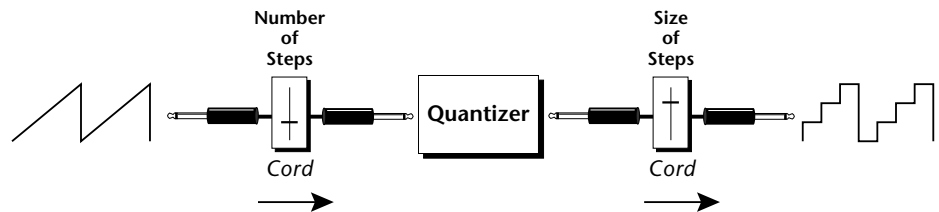

The input PatchCord amount controls how many steps will be generated. With a sawtooth wave (LFO+) feeding the input and the PatchCord amount set to 100%, sixteen steps are generated. The output PatchCord amount controls the size (or interval) of the steps.

Try setting up the following patch exactly as shown below using your favorite preset as a starting point.

L1	LFO1	SHAPE	SYNC
		sawtooth	key sync

L1	LFO1	RATE	DELAY	VAR
		0.35Hz	000	000

 The 4x Amp can be used to get more steps or increase the interval of the Quantizer.

L1	PATCHCORD	#01
LFO1+	-> Quantize	+030

L1	PATCHCORD	#02
Quantize	-> Pitch	+100

L1	PATCHCORD	#03
DC	-> Pitch	-050

 Experiment with this patch by connecting other sources and destinations to the Quantizer.

This patch generates an ascending arpeggio every time a key is pressed. A diagram of the patch is shown below. The patch is very straightforward except for the DC offset which was added to bring the pitch down into tune. (Sometimes you have to fix a problem, but using the mod processors there's usually a way around it to achieve the desired result.)

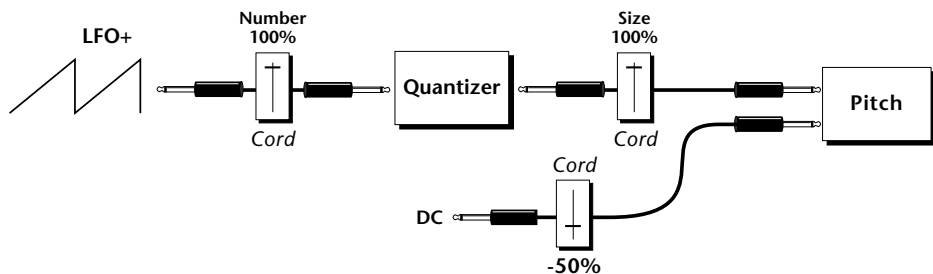

You can start to see some of the possibilities (and there are many). Whenever you find yourself wishing for some esoteric type of control, take a minute to think and see if there is a way to achieve the desired result using the modulation processors.

Dynamic Filters

The block diagram of the Proteus 1000's signal path is shown below.

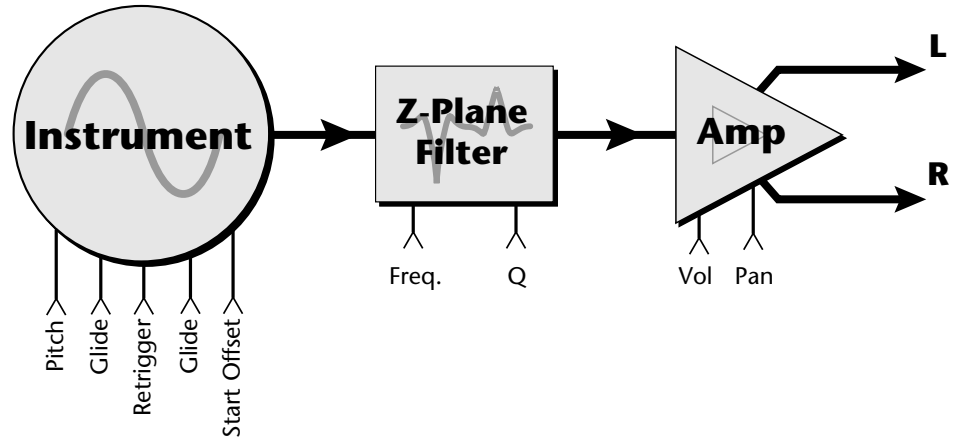

To understand how a filter works, we need to understand what makes up a sound wave. A sine wave is the simplest form of sound wave. Any waveform, except a sine wave, can be analyzed as a mix of sine waves at specific frequencies and amplitudes.

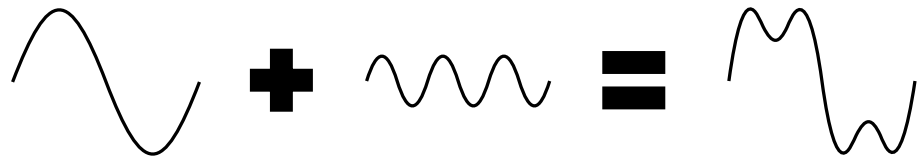

Any waveform can be analyzed as a mixture of sine waves.

One way to represent complex waveforms is to use a chart with frequency on one axis and amplitude on the other. Each vertical line of the chart represents one sine wave at a specific amplitude and frequency.

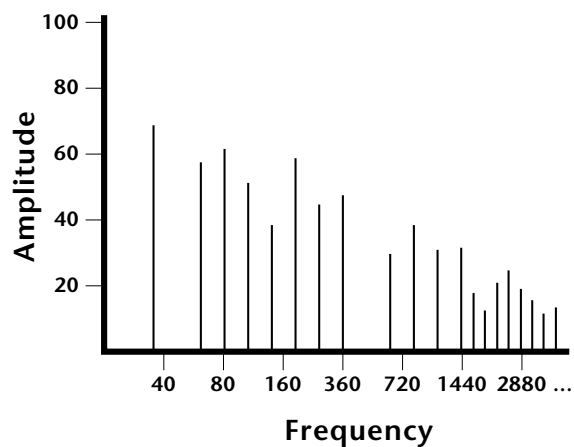

What is a Filter?

Most sounds are complex waves containing many sine waves of various amplitudes and frequencies. A **filter** is a device which allows us to **remove certain components of a sound depending on its frequency**. For example, a *low-pass filter* lets the low frequencies pass and removes only the high frequencies as illustrated in the following diagram.

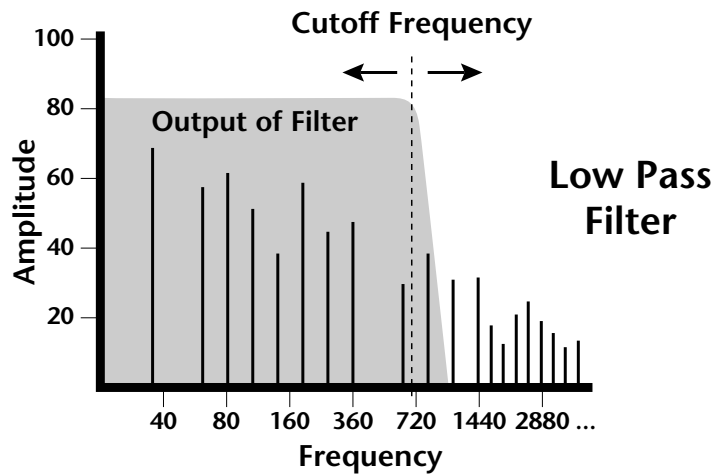

A filter that lets only the high frequencies pass is called a *high-pass filter* as illustrated in the following diagram.

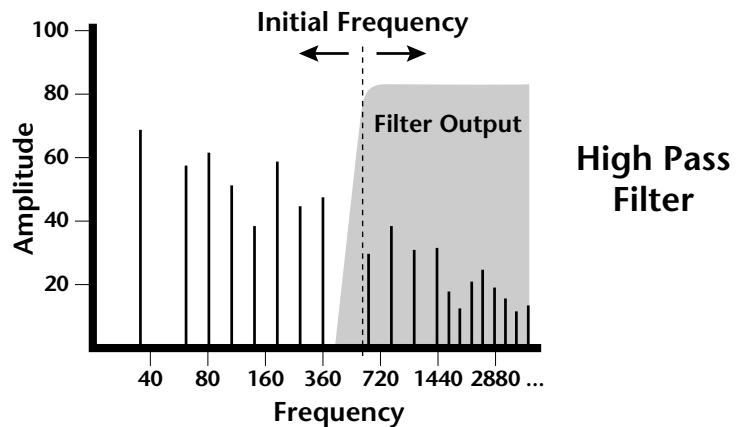

A filter which only lets a certain band of frequencies pass is called a *band-pass filter*.

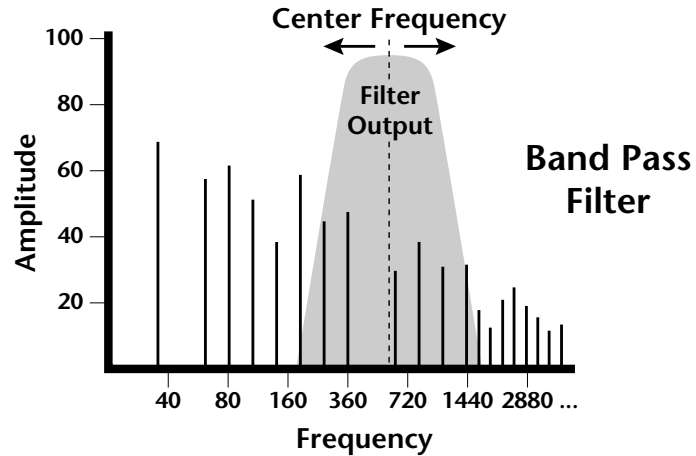

A *notch filter* is just the opposite of a band-pass filter and is used to eliminate a narrow band of frequencies.

Another control found on traditional filters is called Q or resonance. A lowpass filter with a high Q emphasizes the frequencies around the cutoff frequency. The following chart shows how different amounts of Q affect the low-pass filter response. In terms of sound, frequencies around the cutoff tend to “ring” with high Q settings. If a filter with high Q is slowly swept back and forth, various overtones are “picked out” of the sound and amplified as the resonant peak sweeps over them. Bells and gongs are real world examples of sounds which have a high Q.

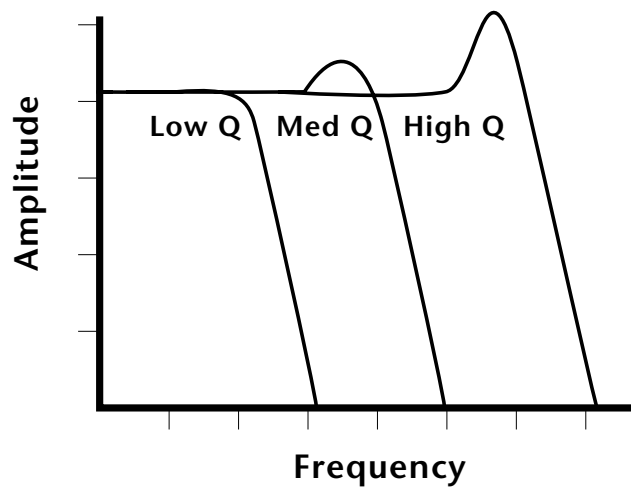

Another characteristic of a filter is the number of poles it contains. Traditional synthesizer filters were usually either 2-pole or 4-pole filters. The Proteus 1000 has selectable 2, 4, and 6-pole low-pass filters. The number of poles in a filter describes the steepness of its slope. The more poles, the steeper the filter's slope and the stronger the filtering action. The tone controls on your home stereo are probably one-pole or two-pole filters. Parametric equalizers are usually either two-pole or three-pole filters.

In terms of vintage synthesizers, Moog and ARP synthesizers used 4-pole filters, Oberheim and E-mu synthesizers were famous for their 2-pole filter sound.

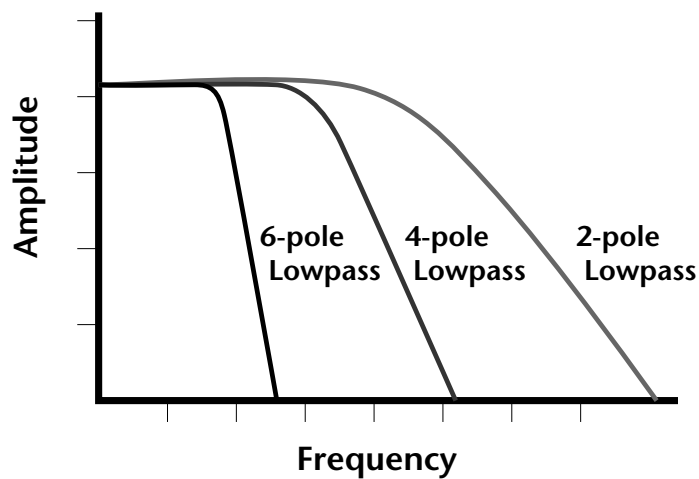

Using a filter, we have a way to control the harmonic content of a sound. As it turns out, even a simple low-pass filter can simulate the response of many natural sounds.

For example, when a piano string is struck by its hammer, there are initially a lot of high frequencies present. If the same note is played softer, there are fewer high frequencies generated by the string. We can simulate this effect by routing keyboard velocity to control the low-pass filter. The result is expressive, natural control over the sound.

If you use an envelope generator to control the cutoff frequency of a filter, the frequency content can be varied dynamically over the course of the note. This adds animation to the sound as well as simulates the response of many natural instruments.

Parametric Filters

A more complex type of filter is called a parametric filter or *Swept EQ*. A parametric filter allows control over three basic parameters of the filter. The three parameters are: *Bandwidth*, *Frequency* and *Gain*. The Bandwidth allows you to select the width of the range of frequencies to be boosted or cut, the Frequency defines the center frequency of the bandwidth, and the Gain parameter either boosts or cuts the frequencies within the selected band by a specified amount. Frequencies not included in the selected band are left unaltered. This is different from a band-pass filter which attenuates (reduces) frequencies outside the selected band.

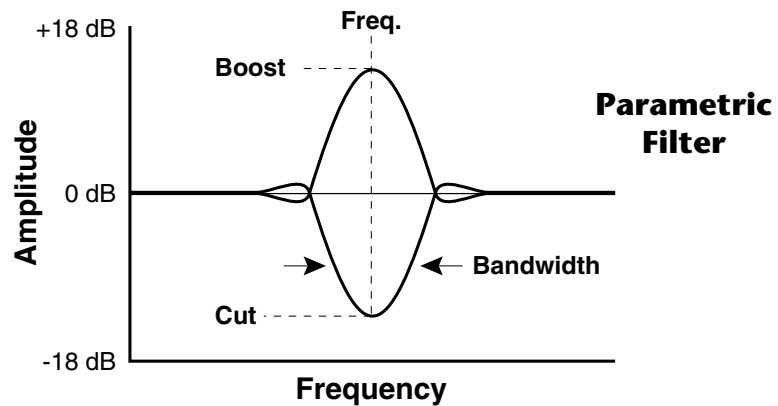

The parametric filter is quite flexible. Any range of frequencies can be either amplified or attenuated. Several parametric sections are often cascaded in order to create complex filter response curves.

If four parametric filter sections were cascaded, it would be possible to create the following complex filter response.

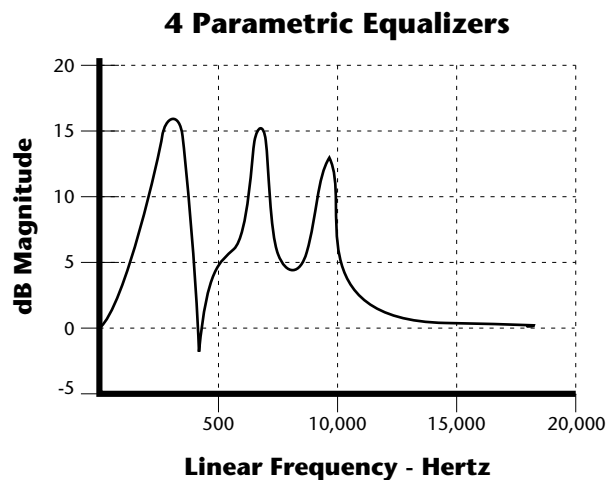

Many natural instruments have complex resonances which are based on their soundboard or tube size. The resonance shown above would be impossible to create using a normal synthesizer filter.

The Z-Plane Filter

A Z-plane filter is a filter which can change its function over time. In a Z-plane filter, we start with two complex filter types and interpolate between them using a single parameter. See the following diagram.

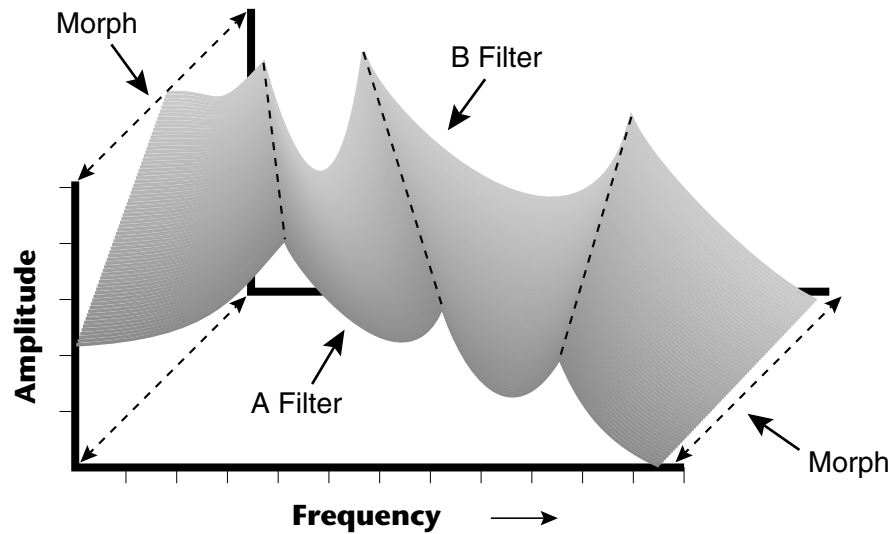

The Z-plane filter has the unique ability to change its function over time.

Filters A and B represent two different complex filters or “frames.” Changing a single parameter, the Morph, changes many complex filter parameters simultaneously. Following along the Morph axis you can see that the filter response smoothly interpolates between the two filters. This is the essence of the Z-plane filter. Through the use of interpolation, many complex parameters are condensed into one manageable entity.

Consider, as an example, the human vocal tract, which is a type of complex filter or resonator. There are dozens of different muscles controlling the shape of the vocal tract. When speaking, however, we don't think of the muscles, we just remember how it feels to form the vowels. A vowel is really a configuration of many muscles, but we consider it a single object. In changing from one vowel to another, we don't need to consider the frequencies of the resonant peaks. You remember the shape of your mouth for each sound and interpolate between them.

This Z-plane filter sweep can be controlled by an envelope generator, an LFO, modulation wheels or pedals, keyboard velocity, key pressure, and so on. In fact, any of the modulation sources can control the Z-plane filter.

Because creating the complex filtering is difficult and very time consuming, we have created 50 different filters and installed them permanently in ROM for your use. You simply select and use the filters in a manner similar to choosing an instrument. Because there are so many types of instruments and filters to choose from, the number of possible permutations is staggering.

Signal Flow

Going back to the Signal Path diagram for a single channel we can reexamine the complete signal path.

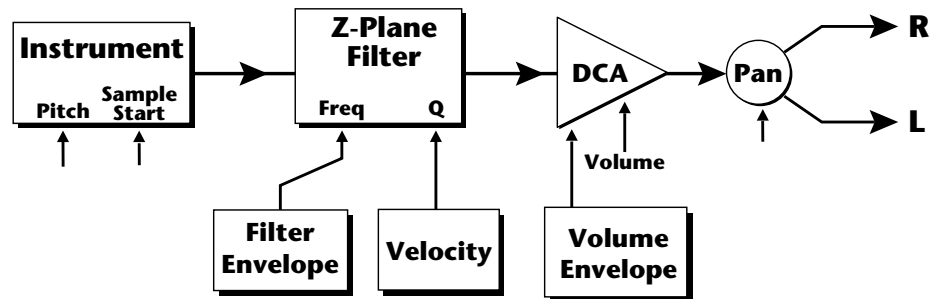

Instrument

This is the sampled sound wave. The pitch of the instrument can be modulated by any modulation source. The sample start point can be changed only at the time the note is played.

Z-Plane Filter

The Z-Plane Filter is used to shape the harmonic content of an instrument. The filter envelope is commonly used to shape the harmonic content dynamically over time but the filter frequency can be modulated by any source. The Q parameter can be modulated only at note-on time. There are 50 types of filters available. See “Proteus 1000 Filter Types” on page 105 for a complete list of the filters.

Digitally Controlled Amplifier (DCA)

Together with the Volume Envelope, the DCA is used to shape the volume contour of a sound. The DCA can be controlled by any modulation source. Velocity is often used as a modulation source for the DCA so that the harder you play, the louder the sound becomes.

Pan

Adjusts the balance of sound to the left and right channels. Pan can be modulated by any modulation source.

MIDI Channels & Real-time Controls

The MIDI real-time controllers may seem confusing at first, but they are really very simple once you understand them. You already know that there are 16 MIDI channels per MIDI cable. Each MIDI channel uses three basic types of messages; note on/off, preset changes, and continuous controller messages. Your MIDI keyboard, in addition to telling Proteus 1000 which note was played, can also send real-time control information, which simply means control occurring in real-time or "live." (You may be using a MIDI device other than a keyboard, but for simplicity's sake we'll presume that you are using a keyboard.) Real-time control sources include such things as pitch wheels or levers, modulation wheels or levers, control pedals and aftertouch and are used to add more expression or control.

Your MIDI keyboard sends out real-time controller information on separate continuous controller numbers. There is a set of 32 continuous controller numbers for each MIDI channel. Some of the controllers, such as the modulation wheel, volume, and pan have standardized numbers. For example, volume is usually sent on continuous controller #7. Your keyboard may have other real-time controls such as a control pedal or data sliders which can also be programmed to control the Proteus 1000.



The following MIDI controls are automatically routed in Proteus 1000:

Pitch Wheel	pwh
Modulation Wheel	01
Old DX7 Aftertouch	03
Pedal	04
Volume	07
Pan	10
Expression	11

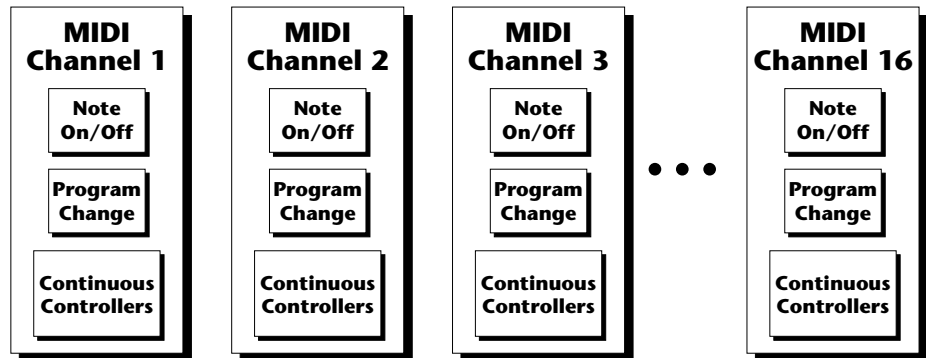

Any MIDI controller can be routed to any modulation destination. First, you have to know which controller numbers your keyboard transmits. Most modern MIDI keyboards let you select a controller number for each control on the keyboard. For example, it may let you select a number from 0-31 for the data slider. The realtime controller numbers that the keyboard transmits must match the numbers Proteus 1000 is receiving, otherwise nothing will happen when you move the controls.

Suppose you wanted to send the four data sliders on your master keyboard. Proteus 1000 can handle 12 MIDI controllers (A-L) of your choosing. "MIDI A-L" are simply names for the internal connections that link external MIDI continuous controllers to the PatchCord section of Proteus 1000. There are two parts to the connection. First, MIDI controller numbers are assigned to the letters A-L in the Master menu. Next, the letters A-L are connected to synthesizer control parameters in the PatchCord section of the Edit menu. The PatchCord Amount scales the amount of each controller by a positive or negative value.

The factory presets have the MIDI A-L controls connected to standard synthesizer functions (marked on the front panel). By choosing any four of the 12 standard functions, the four sliders on your keyboard will work the same on every preset. The chart below shows how this might work if your keyboard transmitted the slider settings on MIDI controllers 21-24.

Control	MIDI Controller #	Routing	Standard Function
Slider 1	21	A	Controls Filter Frequency
Slider 2	22	B	Controls Filter Resonance
Slider 3	23	C	Controls Envelope Attack
Slider 4	24	D	Controls Envelope Release

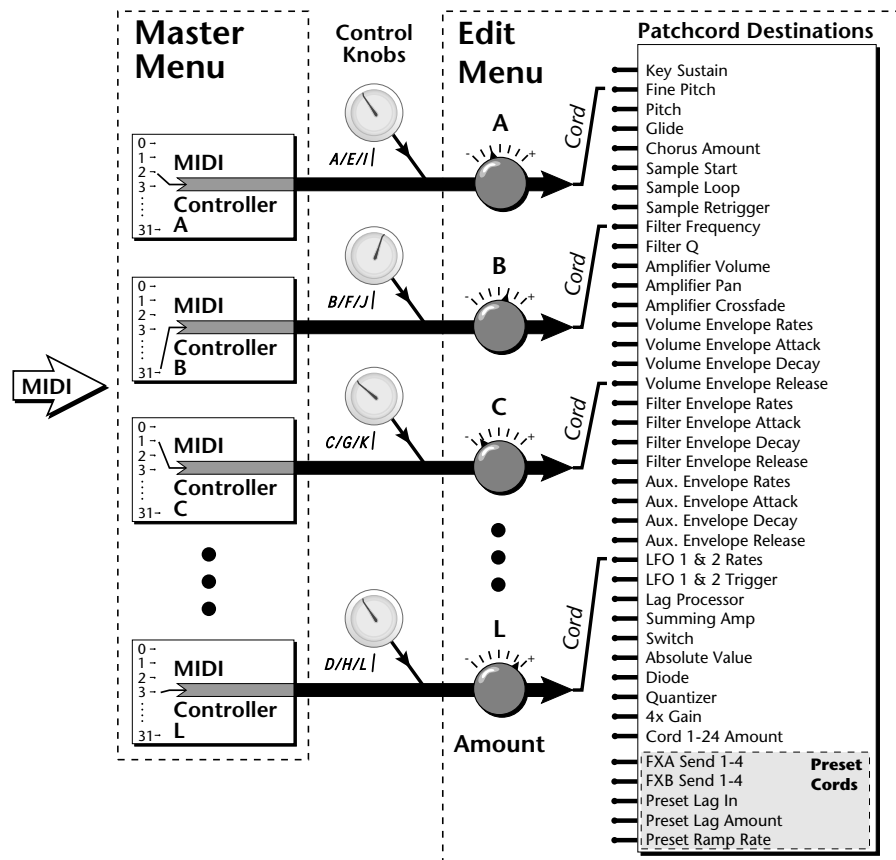

MIDI A-L are internal connections which simultaneously carry front panel controller knob data and MIDI continuous controller data.

The four controller knobs on the Proteus 1000 front panel work just like MIDI real-time controllers. The four controller knobs are permanently assigned to controllers A-L. Pressing the control button adjacent to the row of knobs selects A-D, E-H or I-L functions for the knobs. The front panel knob (A-L) and incoming MIDI controller messages assigned to that letter, both control the same parameter that you select in the PatchCord screen.

Bank Select Commands

When the original MIDI specification was developed, synthesizers had only 8 to 40 preset locations. At that time being able to select up to 128 presets didn't seem like much of a limitation. So it was that the original MIDI specification provided for the selection of up to 128 presets.

Musicians screamed for *MORE* and so the MIDI specification was later amended to include **Bank Select Commands**. It was decided that Bank Select Commands would use Continuous Controllers 0 and 32 to allow the selection of up to 16,384 banks of 128 presets (over two million presets).

Because Bank Selects are implemented using Continuous Controllers, the Bank Selections can be made *per channel*. (This is getting better and better.) For each MIDI channel, you can select any of 16,384 banks and then one of the 128 presets in the bank. Of course no synthesizer has 16,384 banks (yet), but hey, it's nice to know it's possible (for that really BIG project).

Continuous Controller (CC) 0 is the MSB (most significant byte) and CC 32 is the LSB (least significant byte). Normally you send both the MSB and LSB controllers to implement a bank change.

Proteus 1000 remembers the MSB and the LSB that were last sent (or last changed from the front panel). For example, if you have already set the Bank MSB to 04, you need only send the LSB to change banks within the Proteus 1000 sound set. See the MIDI Bank Select chart below.

The selected bank remains selected until you change it (either via MIDI or by changing the bank from the front panel). Standard MIDI Program Change commands select from 128 presets within the selected bank.

 When you press the Audition button, the Bank Select MSB and LSB are displayed on the top line of the display.

MIDI BANK SELECT			
	MSB	LSB	
	cc00	cc32	
USER	00	00	Bank 0
USER	00	01	Bank 1
USER	00	02	Bank 2
USER	00	03	Bank 3
CMPSR	04	00	Bank 0
CMPSR	04	01	Bank 1
CMPSR	04	02	Bank 2
CMPSR	04	03	Bank 3
CMPSR	04	04	Bank 4
CMPSR	04	05	Bank 5
CMPSR	04	06	Bank 6
CMPSR	04	07	Bank 7

Stereo Mix Outputs

This feature is useful for adding signal processing (EQ, reverb, etc.) of individual sounds prior to final mixdown.

The routing can be performed according to MIDI channel from the Mix Output screen in the Master menu. Simply assign each channel to the desired output.

**Master
Menu**

MIX OUTPUT
channel 01: Send 2

To route a particular preset to a Send, first go to the Mix Output screen in the Master menu and set the MIDI channel to "Preset".

**Master
Menu**

MIX OUTPUT
channel 01: Preset

Next set the Mix Output routing in the preset to the desired output (for each layer). Yes, you can send each layer to a different send if you want.

**Edit
Menu**

L1 MIX OUTPUT
Send 2

By sending different amounts of presets to the effects, subtle or striking effects can be achieved using the two effect processors. This feature allows you to get the most out of two effects since you can have eight different mixes.

For more information, refer to the diagram on the following page or, See "Mix Output" on page 37.

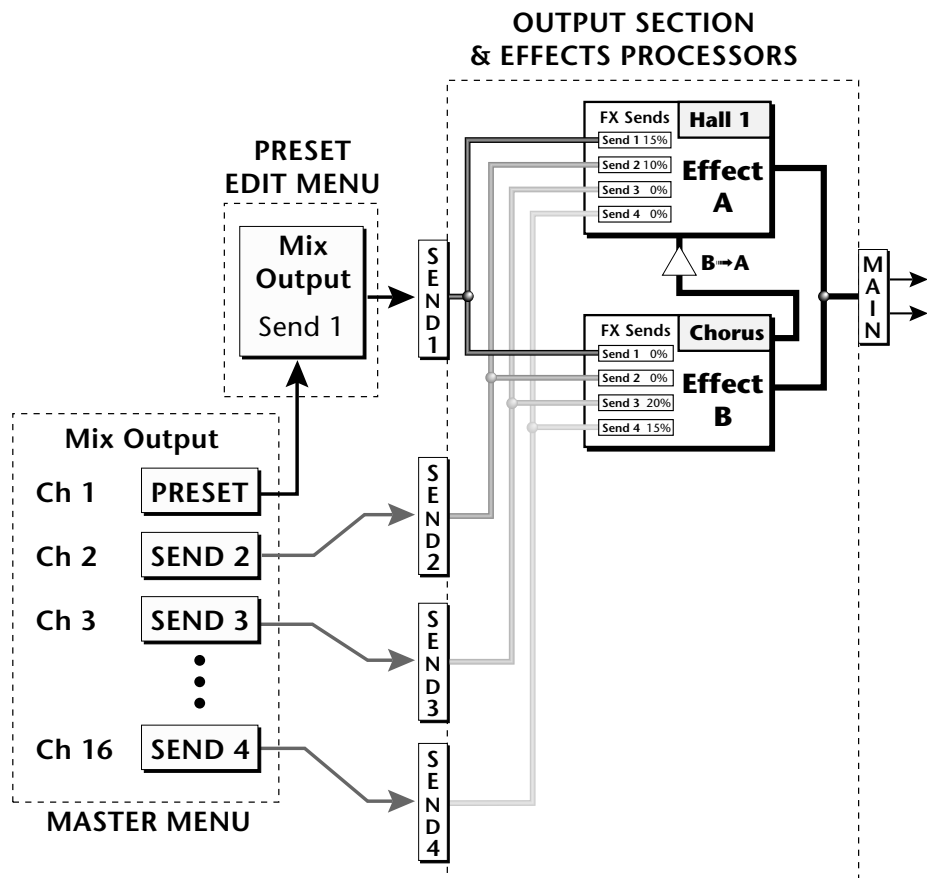

The Mix Output screen in the **Master** menu assigns each MIDI channel to a Send (1-4) or to "Preset".

The Mix Output screen in the **Edit** menu is ONLY used if the Master Mix Output is set to "Preset". Otherwise the Edit menu Mix Output settings are ignored.

Edit Menu



While the Edit menu is activated, all incoming MIDI preset changes on the selected channel are ignored.



If there is no "A" option in the Layer field, you must enable the "Edit All Layers" function in the Master Menu.

The Edit Menu contains four layers of preset parameters that you can modify and then save as preset information in one of the user preset locations.

There are four instrument layers in the Edit menu. See the illustration on page 87 for a description of the Preset Layer model.

► To Access the Edit Menu

Press the Edit button, lighting the LED. The Edit Menu screen displays the menu page most recently selected since powering up Proteus 1000. The cursor appears below the first character of the screen heading on line one.

► To Scroll through Layers

Place the cursor below the layer field. Rotate the Data Entry Control to select a layer (1-4).

You can also select **All Layers** by choosing "A" in the layer field. When All Layers is selected, the existing parameter value for any field will be displayed if the values of all four layers are equal. If the values of all four layers are NOT equal, the value of layer 1 will be displayed with flashing characters. If you change the parameter value, all layers will assume the new value and the display will stop flashing.

► To Scroll through Pages

Place the cursor below the page title field. This will automatically be done when you press the Home/Enter button. Rotate the Data Entry Control to scroll through the pages.

► To Change a Parameter

Place the cursor below the parameter field. Rotate the Data Entry Control to change the parameter value.

Preset Name

The Preset names consists of two parts: a 3 letter preset category and a 12 letter preset name. Position the cursor under the character location and use the data entry control to change the character.

The preset category is used in conjunction with the Sound Navigator feature. Using the Sound Navigator, a category is selected and the presets in that category are listed in alphabetical order. Creating categories makes it easier to find specific sounds when you need them. For more information on Sound Navigator, see Sound Navigator in Chapter 2: Operations.



The keyboard can also be used to select character. The charts below show the keyboard character assignments.

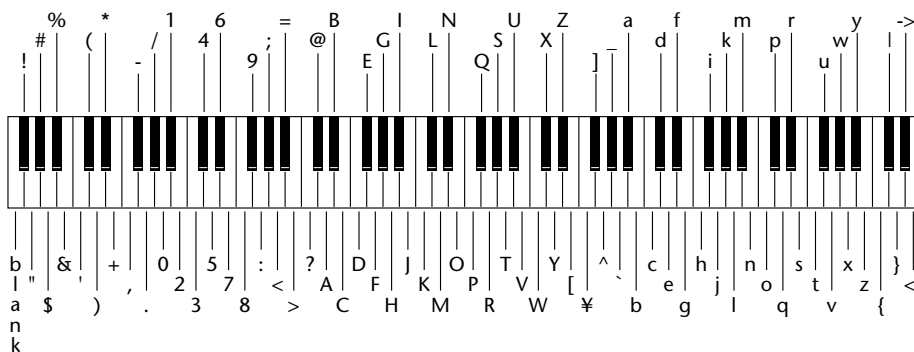

	C	C#	D	D#	E	F	F#	G	G#	A	A#	B	Pitch
-2						blank	!	"	#	\$	%	&	
-1	'	()	*	+	,	-	.	/	0	1	2		
0	3	4	5	6	7	8	9	:	;	<	=	>	
1	?	@	A	B	C	D	E	F	G	H	I	J	
2	K	L	M	N	O	P	Q	R	S	T	U	V	
3	W	X	Y	Z	[¥]	^	_	`	a	b	
4	c	d	e	f	g	h	i	j	k	l	m	n	
5	o	p	q	r	s	t	u	v	w	x	y	z	
6	{		}	→	←								

Octave

Four Layer Architecture

Proteus 1000 provides a 4 layer instrument structure. Each layer is a complete synthesizer voice with 50 filter types, over 64 modulation sources, more than 64 modulation destinations and 24 patchcords to connect everything together. In addition, the four layers can be crossfaded or switched by key position, velocity or any real-time modulation source.

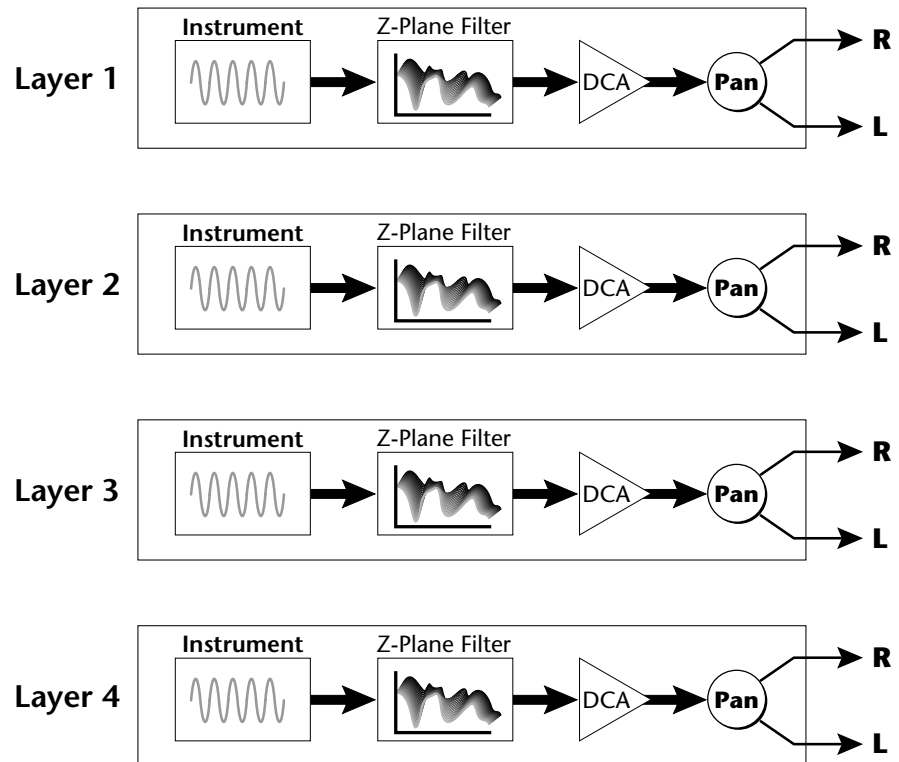

Selecting Layers

In most of the Edit screens, the selected layer is shown in the upper left corner of the display. Layers 1-4 or All can be selected by positioning the cursor on this field and using the Data Entry Control to change the layer. In the screen shown below, Layer 1 is selected.

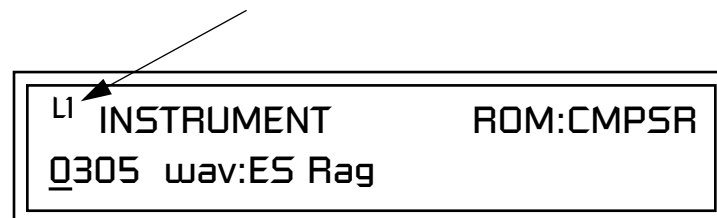

When "All Layers" (A) is selected, the existing parameter value for any field will be displayed if all layers are equal. If the layer parameter values are NOT equal, the value of Layer 1 will be displayed with flashing characters. If you move the Data Entry Control all values will be equal to this new value and the parameter value will no longer flash.

Defining Layer Parameters

Selecting an Instrument

The Edit menu parameters define the four layers and include the instrument assigned to the layer, the ranges of the layer, tuning, envelopes, filters, and patch cords. These parameters are defined for each layer on an individual basis (based on the currently selected layer). See “Common Preset Parameters” on page 118 for global preset settings.

The Instrument parameter defines which of the available instrument sounds is played by the current layer.

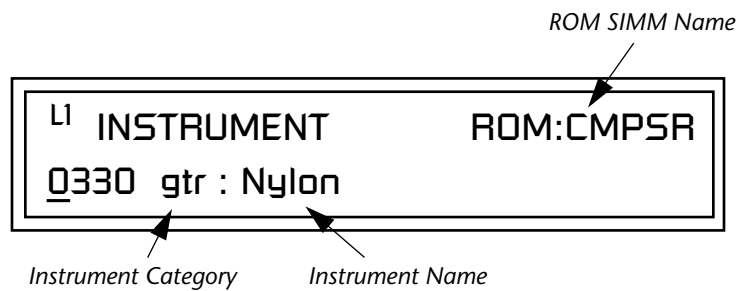

To select an instrument for the selected layer(s), move the cursor to the bottom line of the display and change the instrument using the Data Entry Control.

Sound Navigator

Sound Navigator also works to help select Instruments although the category names are predefined. When the cursor is on the Instrument Category field, turning the Data Entry Control selects different instrument categories. The Name Field will change to show the first instrument in each category. Move the cursor to the instrument name to select instruments in the selected category.

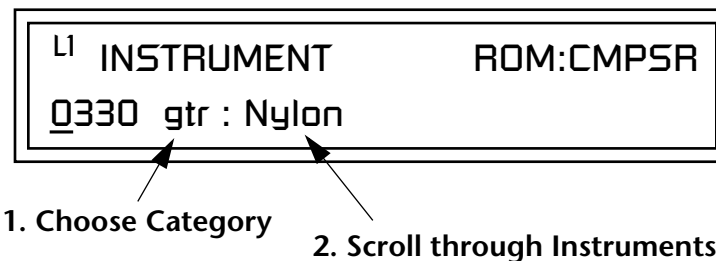

Selecting Categories of Instruments using Sound Navigator.

Defining Key Range

The Key parameter defines the range on the keyboard used by the current layer. The Key range is from C-2 through G8.

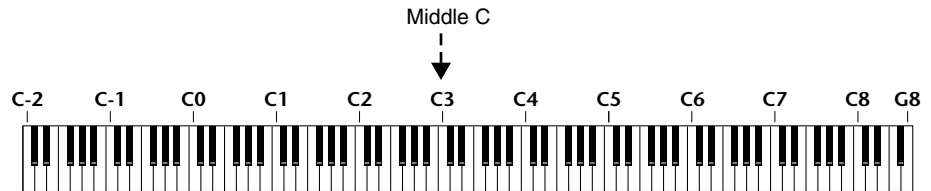

To define the range, set the low key value and the high key value.

You can select key numbers by simply pressing the desired keyboard key when the cursor is positioned on the low or high key field in the display.

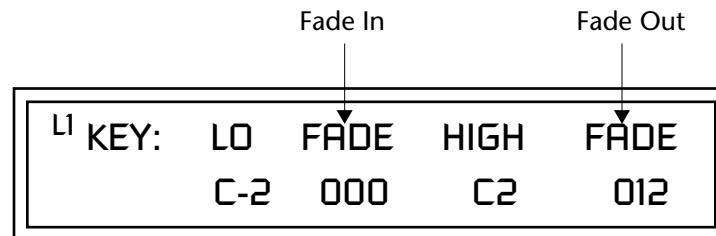

Layers can be crossfaded according to key position by adjusting the Low and High Fade parameters. The first Fade field determines how many semitones it takes the layer to Fade In from the low key. The second Fade field determines how many semitones it takes the layer to Fade Out to the high key. The screen shot above and the diagram below show Layer 1 being faded out over a one octave range.

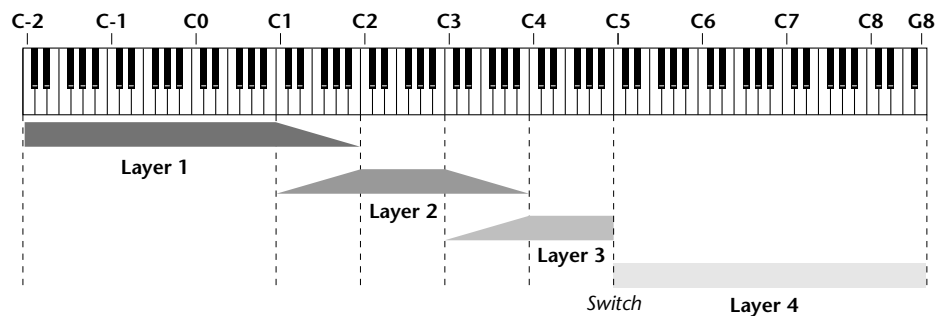

With a High Fade value of zero (as in layer 3 of the diagram), the layer simply switches off at the high key.

► To Switch Layers According to Key Position

The Key Range parameter allows you to create a “split” keyboard with up to four sounds adjacent to each other on the keyboard. This is shown in the diagram below.

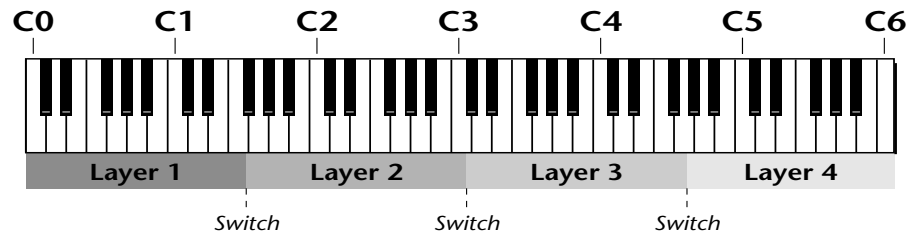

Just assign the low and high key range for each of the four layers with Fade set to zero. Set the Low and High Keys so they don't overlap other layers.

 You can select key numbers by simply pressing the desired keyboard key when the cursor is positioned on the low or high key field in the display.

L ¹ KEY:	LO	FADE	HIGH	FADE
	<u>C</u> 0	000	F1	000

L ² KEY:	LO	FADE	HIGH	FADE
	<u>F</u> #1	000	C3	000

L ³ KEY:	LO	FADE	HIGH	FADE
	<u>C</u> #3	000	F#4	000

L ⁴ KEY:	LO	FADE	HIGH	FADE
	<u>G</u> 4	000	C6	000

If two layers do overlap, both will play as shown in the next example.

► **To Stack Layers**

If the ranges of two or more Layers overlap it is called *stacking layers*. All Layers assigned to a key sound when the key is played. This is shown in the following diagram. It's very easy to stack layers. Simply duplicate the key ranges for any layers you want to stack.

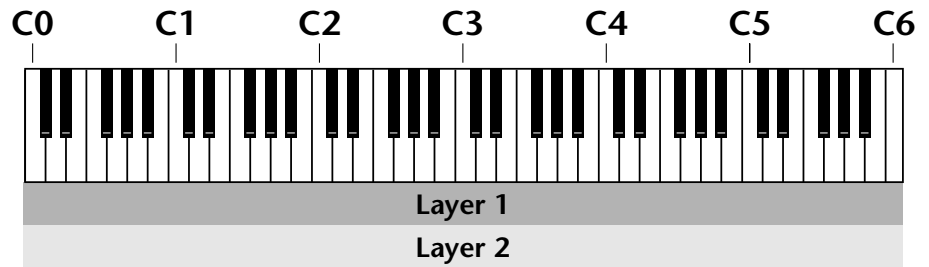

L ¹ KEY:	LO	FADE	HIGH	FADE
	<u>C</u> 0	000	C6	000

L ² KEY:	LO	FADE	HIGH	FADE
	<u>C</u> 0	000	C6	000

Defining the Velocity Crossfade Range

Velocity is a measure of how hard the key is pressed. Velocity Range lets you control the volume of the layers using velocity. Using this function you can crossfade or cross-switch between layers according to how hard you play the keyboard.

Set the velocity range of the layer by defining the high and low velocity values. Values range from 0 (off) to 127 (hardest).

L ² VEL:	LO	FADE	HIGH	FADE
	<u>36</u>	012	96	012

The Fade fields define the velocity crossfade range for the currently selected layer. The first Fade field defines the Fade In range for the low velocity value. The second defines the Fade Out range for the high velocity value.

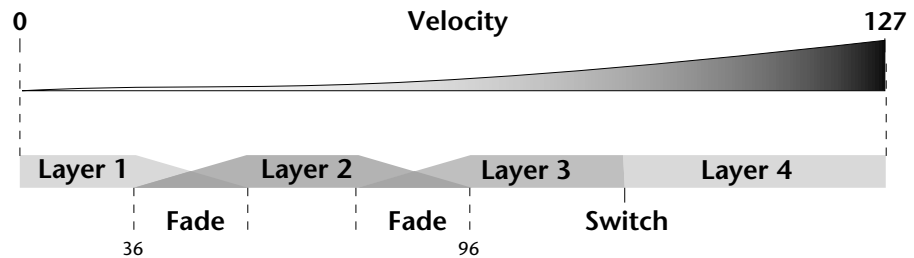

With soft playing, Layer 1 sounds. As you play harder, Layer 1 gradually fades out and Layer 2 fades in. When the keyboard is played hard, Layer 3 plays.

► To Set Up a Velocity Crossfade Between Layers

Set the velocity fades so that layer 1 fades out with higher key velocity, while layer 2 fades in. At a velocity of 64, the two sounds are equal volume. You may want to adjust the fade in and fade out points to achieve a natural sounding crossfade. These parameters vary depending on the sounds.

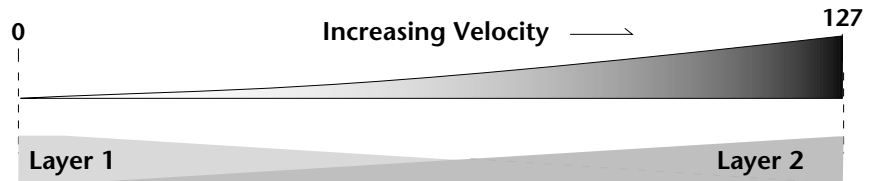

L ¹	VEL:	LO	FADE	HIGH	FADE
		<u>000</u>	000	127	127

L ²	VEL:	LO	FADE	HIGH	FADE
		<u>000</u>	127	127	000

Defining the Real-time Crossfade Range

The Real-time Crossfade window lets you control the volume of the four layers using a real-time controller such as a front panel knob, a pedal or an LFO or Envelope generator. The controller is defined by the PatchCord parameter (see “PatchCords” on page 114).

The Fade fields define the crossfade range in velocity for the currently selected layer. The first Fade field defines the Fade In amount for the low Real-time Control value. The second defines the Fade Out amount for the high Real-time Control value. The Fade value range is from 0 to 127.

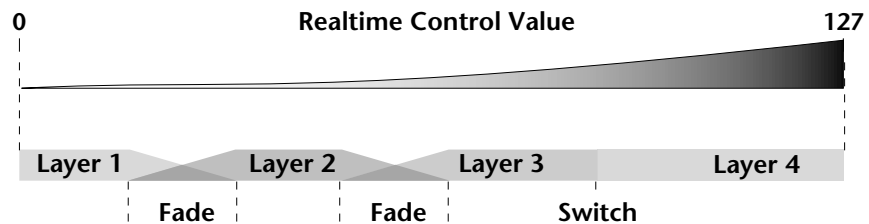

After the Ranges and Fades have been adjusted for each layer in the Real-time Crossfade screen, you must assign a real-time controller to RTXfade (Real-time Crossfade) on each Layer in the PatchCord screen. Set the PatchCord Amounts to +100.

► To Set Up a Real-time Crossfade Between Two Layers

As the real-time control (knob, pedal, LFO, etc.) is increased, Layer 1 fades out as Layer 2 fades in. This example only uses two of the possible four layers. Refer to the screen diagrams below.

L1	RT:	LO	FADE	HIGH	FADE
		000	000	127	127

L2	RT:	LO	FADE	HIGH	FADE
		000	127	127	000

1. Select a preset.
2. Press the Edit button to access the Edit menu.
3. Go to the Instrument page and select instruments for Layers 1 and 2.

4. Press Enter, then use the Data Entry Control to advance to the Real-time Crossfade page.
5. Define the High and Low range of each Layer. In this example the entire range of 0-127 is used.
6. Define the Fades for each Layer. This is just an initial setting. The Range and Fade parameters may have to be adjusted later to get a smooth crossfade.
7. Press Home/Enter and use the Data Entry Control to advance to the PatchCord page. Select Layer 1.
8. Select the modulation source for the crossfade (knob, pedal, LFO, Envelope) and set the destination to RTXfade. Set the Cord Amount to +100.
9. Select Layer 2. Select the same source and destination for the crossfade and set the Cord Amount to +127.

L1 PATCHCORD	#01
MidiA -> RTXfade	+100

10. Play the keyboard while adjusting the real-time controller. Go back to the Real-time Crossfade screens to fine tune the crossfade if necessary. Decreasing the fade size will narrow the region where both layers are sounding.

► **To Randomly Cross-Switch Between Four Layers**

In certain situations, you may want to switch between several layers randomly. **Crossfade Random** is a modulation source specifically designed to handle this situation. Unlike the other random sources, Crossfade Random generates one random number for all layers each time a key is pressed.

To set up a four layer Cross-Switch, simply assign each of the four layers to a different Real-time Crossfade range, then assign XfdRnd to RTXfade in the PatchCords for each layer.

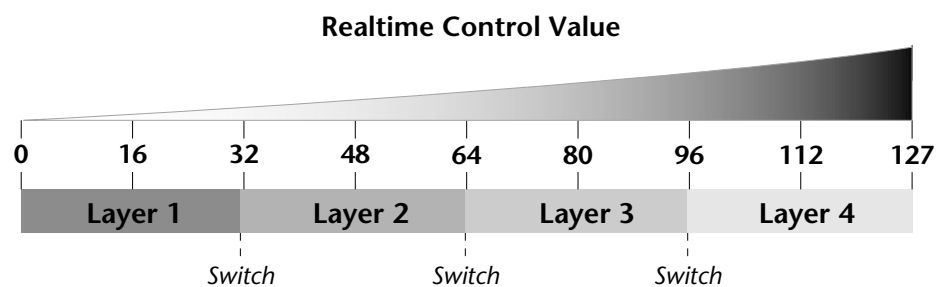

1. Press the Edit button to access the Edit menu.
2. Go to the Instrument screen and select Instruments for Layers 1 through 4.
3. Press Enter, then use the Data Entry Control to advance to the Real-time Crossfade page.

L1	RT:	LO	FADE	HIGH	FADE
		000	000	<u>031</u>	000

L2	RT:	LO	FADE	HIGH	FADE
		<u>032</u>	000	063	000

L3	RT:	LO	FADE	HIGH	FADE
		<u>064</u>	000	095	000

L4	RT:	LO	FADE	HIGH	FADE
		09 <u>6</u>	000	127	000

4. Define the High and Low range of each Layer as shown above.
5. Press Home/Enter and use the Data Entry Control to advance to the PatchCord page. Select Layer 1.
6. Select XfdRnd as the modulation source and RTXfade as the destination. Set the Cord Amount to +100.
7. Repeat step 6 for the remaining three layers.

*Transposing the
Instrument*

```
L1 PATCHCORD #01
XfdRand -> RTXfade +100
```

8. That's it! Now set each Layer up the way you want. Try radically different instruments, filter settings, or tunings. Or you can make each layer just slightly different for a more natural effect. Try adjusting the Fades or overlapping the ranges if you want more than one layer to play at once.

The Transpose parameter lets you transpose the key of the current layer's Instrument. Transpose works by shifting the keyboard position in semitone intervals relative to middle C. Use this parameter to transpose different layers apart by semitone intervals. For example, by transposing one layer by +7 semitones, it will track other layers at a perfect fifth interval.

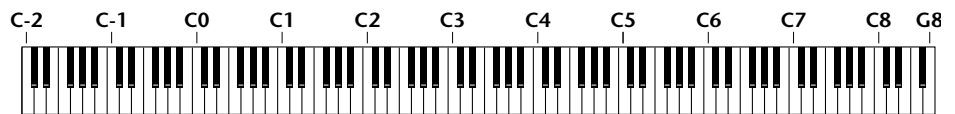

The range of transposition is -36 to +36 semitones.

```
L1 TRANSPOSE
+36 semitones
```

Tuning

The Tuning parameter changes the pitch of the key in semitone and 1/64 semitone intervals.

L1 <u>T</u> UNING			
Coarse:	+36	Fine:	+63

Use the Coarse field to shift the tuning by semitone intervals. Use the Fine field to shift tuning by 1/64 semitones (or 1.56 cents) intervals.

Background: Transpose vs. Coarse Tuning

Transpose works by shifting the keyboard assignment of the Instrument (as if you were sliding the keyboard up and down with the Instrument remaining in the same position). Coarse Tuning keeps the instrument placement on the keyboard and actually tunes the samples up using a digital process called interpolation. Use Course Tuning on drum instruments to change the pitch while keeping sample placement constant. Coarse Tuning can also be useful to slightly change the timbre of the instrument.

Amplifier

This parameter sets the initial volume and pan position of the current layer. These values can be changed using any Real-time Controller set up in the PatchCords. The value range for the volume is from -96 dB to +10 dB. 0 dB is the default setting. Routinely turning the volume up to +10 dB is not recommended because it doesn't allow other modulation sources to increase the volume further.

L1 <u>A</u> MPLIFIER			
Volume:	+10dB	Pan:	48L

This field determines the initial Pan value for the current layer. The value range for Pan is from 64L to 0 (left) and 0 to 63R (right). Pan adjusts the volume into the left and right output channels relative to the Pan setting in the main Preset Select screen (see "Channel Pan" on page 28). So, if you, for example, set the Pan value in the Preset Select screen to 64L and set this Pan value to 63R, the actual pan amount would be 0 as these two pan parameters are relative to each other.

Volume Envelope

 *Factory Mode is useful for Instruments containing multiple drums, since each drum can have its own envelope settings.*

 *If two adjacent segments have the same level in a “time-based” envelope, the segment will be skipped. Adjacent segments must have different levels for the rate control to work.*

 *See “Base Tempo” on page 52.*

An envelope can be described as a “contour” which is used to shape the sound over time. The *Volume Envelope* controls the volume of the sound in the current layer over time. The way the volume of a sound evolves has a profound effect on how we perceive the sound.

Each instrument has its own Factory preset Volume Envelope setting. The Volume Envelope allows you to program your own envelope settings.

Selecting the Mode

The Mode field determines whether the layer will use the instrument’s default envelope (Factory) or use the user-programmed Volume Envelope. There are three mode options and repeat.

- **Factory:** Uses the factory preset envelope contained in each instrument. If you select the “Factory” mode, the Volume Envelope parameters are disabled and the factory defined settings are used instead.

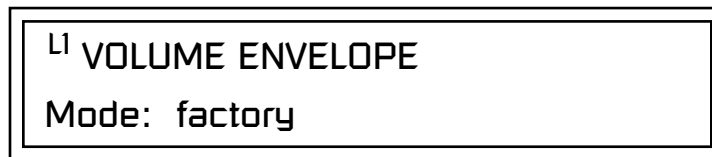

- **Time-based:** Defines the Volume Envelope rates from 0 to 127 (approximately 1 ms to 160 seconds). The Master clock has no affect on time-based rates.
- **Tempo-based:** The Volume Envelope times vary based on the Base Tempo setting. Note values are displayed instead of a number when the time corresponds to an exact note value. Tempo-based envelopes are useful when using external sequencers and arpeggiators because the envelope rates compress and expand according to the Base Tempo setting, keeping the envelopes in sync with the sequence or arpeggio.

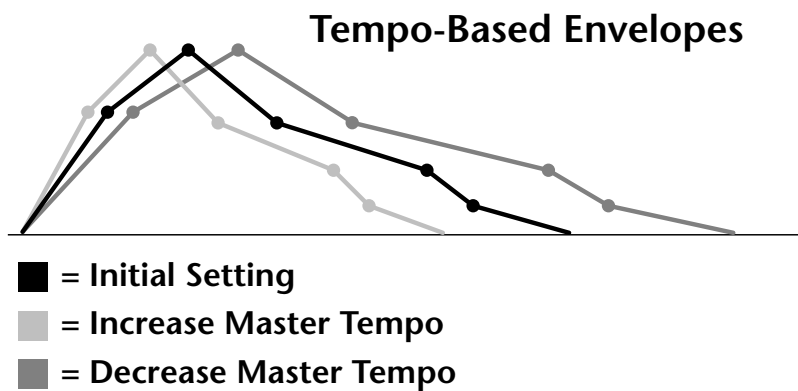

Tempo-based envelope rates change according to the Base Tempo rate.

 See the Programming Basics section of this manual for detailed information about how the Envelopes work.

Defining the Volume Envelope

The Volume Envelope controls the volume of the layer over time. The Volume Envelope has six stages to the contour: Attack 1, Attack 2, Decay 1, Decay 2, Release 1 and Release 2. When a key is pressed, the Envelope goes through the first four stages. If you continue to hold down the key, the envelope holds at the Decay 2 level. When the key is released, the envelope continues through the Release stages ending at the Release 2 level.

L1	VOL ENV	RATE	LEVEL
	<u>A</u> ttack 1	84	100%

As soon as the Attack 1 level is reached, the Attack 2 phase begins. When the Attack 2 Level is reached, the Decay 1 phase begins. When the key is released, the envelope immediately jumps to the Release 1 stage, then the Release 2 stage finally ending at the Release 2 level.

If you have selected the factory mode, the Volume Envelope parameter screen looks like the following illustration.

L1	VOL ENV	RATE	LEVEL
	(using factory envelope)		

 If the Release 2 level is set at a value other than zero, the note will continue to sound after the key is released. This might be useful for drone effects, but the channel won't stop sounding until all channels are used up.

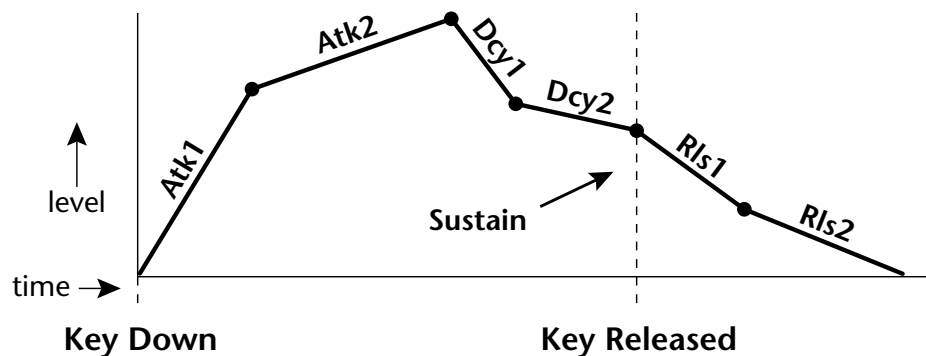

On the Volume Envelope, levels can only be set to positive values. The value range is from 0 to +100.

Chorusing the Layer



WARNING: Because it works by doubling instruments, Chorusing halves the number of notes you can play.

Chorusing “thickens” the sound by doubling the sound in stereo and then detuning it. Every layer with chorus turned on uses twice the polyphony for that layer.

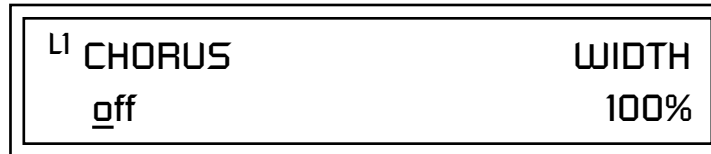

The first field in this screen turns Chorus On or Off and allows you to adjust the amount of detuning (1 to 100%). The *Width* parameter controls the stereo spread. 0% reduces the chorus to mono and 100% provides the most stereo separation.

Sound Start Offset and Delay

Sound Start sets where the instrument begins playing when you hit a key. Setting the Start Offset amount to “0” plays the sample from the beginning. Higher values move the Sample Start Point further into the sample toward the end. There is also a PatchCord source which can be used to change the Sound Start point at note-on time.

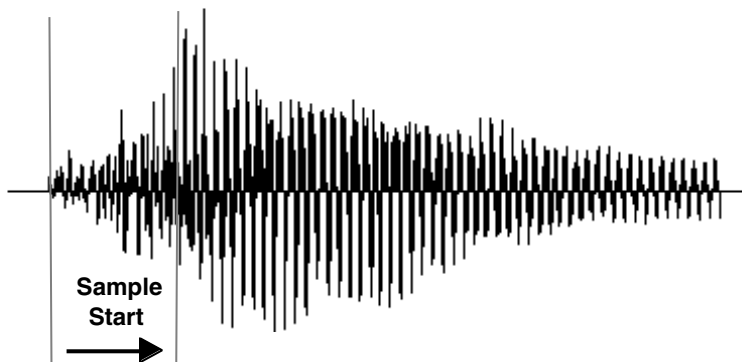
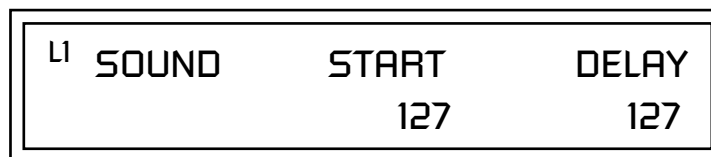

Controlling the Sound Start using Key Velocity (< Amt -) brings in the attack of the wave only when you play hard. This is especially effective with percussion instruments.



See “Base Tempo” on page 54.

Delay defines the time between when you hit a key (note-on) and the onset of the current layer’s note and the start of the envelopes (if applicable). Delay values below zero are *Tempo-based* values, meaning the time is based on the Base Tempo setting. Note values are displayed by adjusting the Delay Time value below zero. The sound will be delayed by the selected note value based on the master clock.

Non-Transpose Mode

This function turns keyboard transposition On or Off for the current layer. With Nontranspose “on,” the keyboard will not control the pitch of the instrument. This is a useful function for drones, attack “chiffs,” or other sound effects which you may not want to track the keyboard.

L1 NONTRANSCOPE
off

Solo Mode

Provides the playing action of a monophonic instrument such as a lead synthesizer by preventing more than one note from sounding at once. There are eight different solo modes provided. Try setting up different layers with different solo mode and glide rates or combine solo mode with polyphonic playing modes.

L1 SOLO MODE
synth (low)



In order to define a monophonic glide (see the Portamento parameter), you must be in Solo mode.

The Solo modes are:

Multiple Trigger: Last note priority. No key-up action. Retrigger envelopes and samples when a key is pressed.

Melody (last): Last note priority. No key-up action.

First solo note: Envelopes start at Attack segment from zero. Samples start at the beginning.

If previous note is releasing: Envelopes start at Attack segment, but from current level. Samples start at the beginning.

When playing “Legato”: Envelopes continue from current segment and level. Samples start at the loop or the beginning if unlooped.

Melody (low): Same as Melody (last), but with low note priority. Newly played keys which are higher than the lowest solo key held do not sound.

Melody (high): Same as Melody (last), but with high note priority. Newly played keys which are lower than the highest solo key held do not sound.

Synth (last): Similar to Melody (last) but this mode has key-up action. When you release the currently sounding solo key while holding other keys down, the highest held solo key sounds in a Legato fashion.

Assign Group

Synth (low): Same as Synth (last) but with low note priority. When you release the currently sounding solo key while holding other keys down, the lowest held solo key sounds in a Legato fashion (MiniMoog).

Synth (high): Same as Synth (last) but with high note priority. When you release the currently sounding solo key while holding other keys down, the highest held solo key sounds in a Legato fashion.

Fingered Glide: Same as Synth (last), except that Glide is disabled when playing Staccato, enabled when playing Legato.

Use the Assign Group parameter to assign a certain number of channels to each layer. By assigning all voices in the preset to assign groups, important parts are protected from being “stolen” by more recently played keys. Or you can assign a voice, such as an open high hat, to a mono channel so it is cancelled by a closed high hat on the same mono channel. Layers rotate within their assigned “bin” of channels, not interfering with other bins.



The modes are:

Poly All: Notes are played polyphonically with dynamic channel assignment using all 64 channels.

Poly 16 A-B: Two bins of 16 channels each. Notes are played polyphonically with dynamic channel assignment using no more than 16 channels.

Poly 8 A-D: Four bins of 8 channels each. Notes are played polyphonically with dynamic channel assignment using no more than 8 channels each.

Poly 4 A-D: Four bins of 4 channels each. Notes are played polyphonically with dynamic channel assignment using no more than 4 channels each.

Poly 2 A-D: Four bins of 2 channels each. Notes are played polyphonically with dynamic channel assignment using no more than 2 channels each.

Mono A-I: Nine monophonic channels, Any layers assigned to the same letter interrupt each other without affecting other layers.

Glide

Glide creates a smooth transition from one note to the next instead of the normal instantaneous change in pitch when a new key is pressed. This effect is commonly heard on slide guitars, synthesizers and violins.

L1	GLIDE RATE	CURVE
	0.000 sec/oct	linear

The **Glide Rate** parameter defines the time it takes to glide to the new pitch (the larger the value, the slower the glide rate) The glide rate value range is from 0 through 32.738 seconds (zero means off).

The **Glide Curve** describes how the glide accelerates as it slides between notes. Because of the ear's non-linear response to pitch, a linear glide sounds slow at the beginning and speeds up toward the end. Exponential curves actually sound smoother and more linear. Eight exponential curves are provided. Choose one that suits your style.

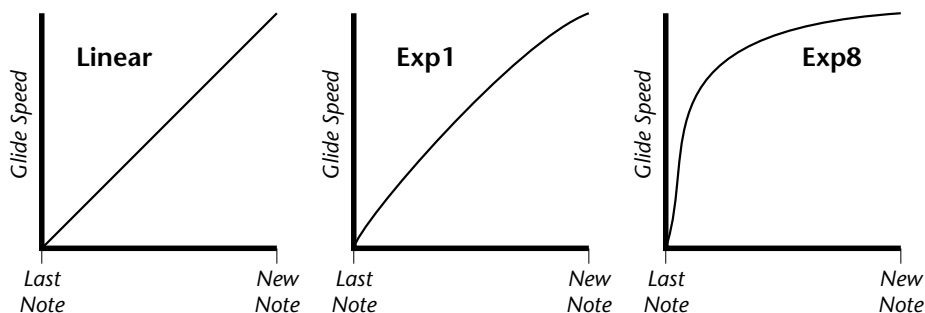

Glide can be either polyphonic or monophonic depending of the state of *Solo Mode*.

Z-Plane Filters

A filter is a device which changes the output of a signal (sound) by removing certain elements of the signal based on the frequency and amplitude. The "Order" of a filter defines the number of filter elements it contains. The more elements, the more complex the filter.

Proteus 1000 contains 50 different types of E-mu's celebrated Z-plane filters. In addition to the standard Low pass, High pass and Band pass filters, Proteus 1000 contains Swept Octave Equalizers, Phasers, Flangers, Vocal Formant Filters, and digital models of classic synthesizer filters.

In the filter chart below you will notice that the "Order" of the filters varies from 2 to 12 order. Higher order filters have more sections and can produce more complex formants. Proteus 1000 can produce 64 filters of up to 6th order or 32 filters of 12th order complexity. Therefore, if you decided to use

all 12th order filters, Proteus 1000 would be limited to 32 voices. *See page 73 for more information about filters.*

Proteus 1000 Filter Types

This screen allows you to choose the type of filter for the current layer.

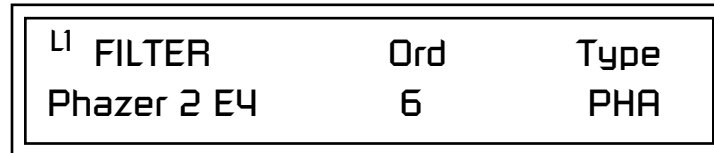

Filter Types	
LPF	Low-pass filter
PHA	Phaser
HPF	High-pass filter
FLG	Flanger
BPF	Band-pass filter
VOW	Vowel/ formant
EQ+	EQ boost
EQ-	EQ cut
SFX	Special Effect

Filter Name	Order	Type	Description
Smooth	02	LPF	Typical OB type low-pass filter with a shallow 12 dB/octave slope.
Classic	04	LPF	4-pole low-pass filter, the standard filter on classic analog synths. 24 dB/octave rolloff.
Steeper	06	LPF	6-pole low-pass filter which has a steeper slope than a 4-pole low-pass filter. 36 dB/octave rolloff!
MegaSweepz	12	LPF	“Loud” LPF with a hard Q. Tweeters beware!
EarlyRizer	12	LPF	Classic analog sweeping with hot Q and Lo-end.
Millennium	12	LPF	Aggressive low-pass filter. Q gives you a variety of spiky tonal peaks.
KlubKlassik	12	LPF	Responsive low-pass filter sweep with a wide spectrum of Q sounds
BassBox-303	12	LPF	Pumped up lows with TB-like squelchy Q factor.
Shallow	02	HPF	2-pole high-pass filter. 12 dB/octave slope.
Deeper	04	HPF	Classic 4-pole high-pass filter. Cutoff sweep progressively cuts 4th Order High-pass.
Band-pass1	02	BPF	Band-pass filter with 6 dB/octave rolloff on either side of the passband and Q control.
Band-pass2	04	BPF	Band-pass filter with 12 dB/octave rolloff on either side of the passband and Q control.
ContraBand	06	BPF	A novel band-pass filter where the frequency peaks and dips midway in the frequency range.
Swept1>1oct	06	EQ+	Parametric filter with 24 dB of boost or cut and a one octave bandwidth.
Swept2>1oct	06	EQ+	Parametric filter with 24 dB of boost or cut. The bandwidth of the filter is two octaves wide at the low end of the audio spectrum, gradually changing to one octave wide at the upper end of the spectrum.

Filter Name	Order	Type	Description
Swept3>1oct	06	EQ+	Parametric filter with 24 dB of boost or cut. The bandwidth of the filter is three octaves wide at the low end of the audio spectrum, gradually changing to one octave wide at the upper end of the spectrum.
DJAlkaline	12	EQ+	Band accentuating filter, Q shifts "ring" frequency.
AceOfBass	12	EQ+	Bass-boost to bass-cut morph
TB-OrNot-TB	12	EQ+	Great Bassline "Processor."
BolandBass	12	EQ+	Constant bass boost with mid-tone Q control.
BassTracer	12	EQ+	Low Q boosts bass. Try sawtooth or square waveform with Q set to 115.
RogueHertz	12	EQ+	Bass with mid-range boost and smooth Q. Sweep cutoff with Q at 127.
RazorBlades	12	EQ-	Cuts a series of frequency bands. Q selects different bands.
RadioCraze	12	EQ-	Band limited for a cheap radio-like EQ
AahAyEeh	06	VOW	Vowel formant filter which sweeps from "Ah" sound, through "Ay" sound to "Ee" sound at maximum frequency setting. Q varies the apparent size of the mouth cavity.
Ooh-To-Aah	06	VOW	Vowel formant filter which sweeps from "Oo" sound, through "Oh" sound to "Ah" sound at maximum frequency setting. Q varies the apparent size of mouth cavity.
MultiQVox	12	VOW	Multi-Formant, Map Q To velocity.
Ooh-To-Eee	12	VOW	Oooh to Eeee formant morph.
TalkingHedz	12	VOW	"Oui" morphing filter. Q adds peaks.
Eeh-To-Aah	12	VOW	"E" to "Ah" formant movement. Q accentuates "peakiness."
UbuOrator	12	VOW	Aah-Uuh vowel with no Q. Raise Q for throaty vocals.
DeepBouche	12	VOW	French vowels! "Ou-Est" vowel at low Q.
PhazeShift1	06	PHA	Recreates a comb filter effect typical of phase shifters. Frequency moves position of notches. Q varies the depth of the notches.
PhazeShift2	06	PHA	Comb filter with slightly different notch frequency moving the frequency of notches. Q varies the depth of the notches.
FreakShifta	12	PHA	Phasey movement. Try major 6 interval and maximum Q.
CruzPusher	12	PHA	Accentuates harmonics at high Q. Try with a sawtooth LFO.

Filter Name	Order	Type	Description
FlangerLite	06	FLG	Contains three notches. Frequency moves frequency and spacing of notches. Q increases flanging depth.
AngelzHairz	12	FLG	Smooth sweep flanger. Good with vox waves. eg. I094, Q =60
DreamWeava	12	FLG	Directional Flanger. Poles shift down at low Q and up at high Q.
MeatyGizmo	12	REZ	Filter inverts at mid-Q.
DeadRinger	12	REZ	Permanent "Ringy" Q response. Many Q variations.
ZoomPeaks	12	REZ	High resonance nasal filter.
AcidRavage	12	REZ	Great analog Q response. Wide tonal range. Try with a sawtooth LFO.
BassOMatic	12	REZ	Low boost for basslines. Q goes to distortion at the maximum level.
LucifersQ	12	REZ	Violent mid Q filter! Take care with Q values 40-90.
ToothComb	12	REZ	Highly resonant harmonic peaks shift in unison. Try mid Q.
EarBender	12	WAH	Midway between wah & vowel. Strong mid-boost. Nasty at high Q settings.
FuzziFace	12	DST	Nasty clipped distortion. Q functions as mid-frequency tone control.
BlissBatz	06	SFX	Bat phaser from the Emulator 4.
KlangKling	12	SFX	Ringing Flange filter. Q "tunes" the ring frequency.

Filter Parameters

The Freq and Q parameters control various elements of the filter depending on the type of filter used. See the table in the *Filter Types* section for details about what the Freq and Q fields control in each filter.

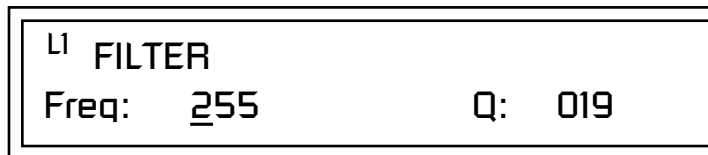

Filter Envelope

The Filter Envelope is normally used to control the filter frequency and has six stages. Unlike the Volume Envelope, the Filter Envelope must be patched to the Filter Frequency using a PatchCord. In this respect, it can be thought of as a general purpose envelope generator which is normally patched to control the filter. The Filter Envelope Levels can be negative as well as positive.

There are three mode options:

- **Time-based:** Defines the Filter Envelope rates from 0 to 127 (approximately 1 ms to 160 seconds). The Master clock has no affect on time-based rates.

L1	FILT ENV	RATE	LEVEL
	Attack 1	<u>8</u> 4	100%

- **Tempo-based:** The Filter Envelope times vary based on the Master Clock (Base Tempo) setting and are displayed in values such as 1, 2, 3, etc. Note values are displayed instead of a number when the time corresponds to an exact note value. Tempo-based envelopes are useful when using arpeggiators and sequencers because the envelope rates compress and expand according to the Base Tempo setting, keeping the envelopes in sync with the music. See the illustration on page 60.

L1	FILT ENV	RATE	LEVEL
	Attack 1	<u>1</u> /4	100%

- **Envelope Repeat:** The Envelope Generators can also be made to repeat. When the envelope repeat function is On, the Attack (1&2) and Decay (1&2) stages will continue to repeat as long as the key is held. As soon as the key is released, the envelope continues through its normal Release stages (1 & 2). For more information, see "Envelope Repeat" on page 60.

► **To Turn on Envelope Repeat:**

1. Move the cursor until it is underneath the Mode field as shown below.

L1	FILTER ENVELOPE
	<u>Mode:</u> time-based

2. Turn the data entry control clockwise. The lower line changes to:

L1	FILTER ENVELOPE
	Repeat: off

3. Move the cursor underneath the on/off field, then turn the data entry control clockwise so that Repeat is On.



See "Base Tempo" on page 54.



See the Programming Basics section of this manual for detailed information about how the Envelopes work.



The default PatchCord settings connect the Filter Envelope to Filter Frequency but the envelope can be routed to any real-time control destination using a PatchCord.

Defining the Filter Envelope

The Filter Envelope controls the filter frequency of the layer over time. The Envelope has six stages to the contour: Attack 1, Attack 2, Decay 1, Decay 2, Release 1 and Release 2. When a key is pressed, the Envelope goes through the first four stages. If the key continues to be held, the envelope holds at the Decay 2 level. When the key is released, the envelope immediately jumps to the Release 1 stage, then the Release 2 stage finally ending at the Release 2 level.

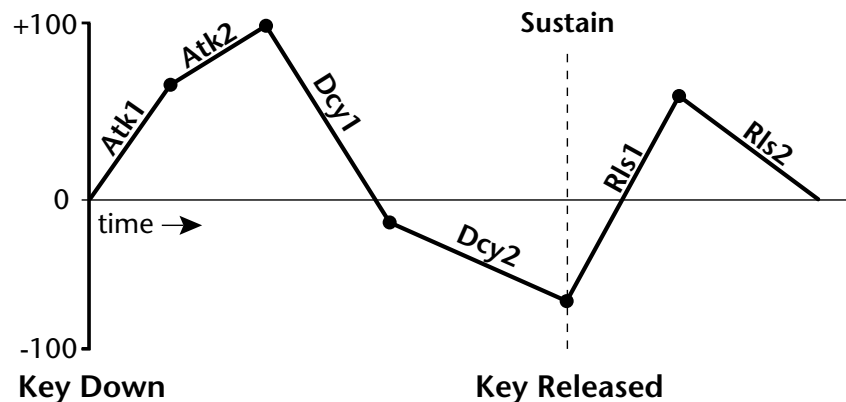

Auxiliary Envelope

The Auxiliary Envelope is a supplementary general purpose envelope that can be routed to any real-time control destination in the PatchCords. It is identical to the filter envelope generator. See “Filter Envelope” on page 107 for full details.

Low Frequency Oscillators (LFOs)

A Low Frequency Oscillator or LFO, is simply a wave that repeats at a slow speed. Proteus 1000 has two LFOs per layer identified on the display as LFO1 and LFO2.

An LFO can be routed to any real-time control destination using a PatchCord. LFOs have a myriad of uses, some of which probably haven’t been thought of yet. The following examples show a few common uses.

- Control the pitch of the sound (LFO -> Pitch). This effect is called “vibrato” and is an important performance tool. Many presets use this routing with the modulation wheel controlling “how much” modulation is applied.
- Create a “tremolo” effect by routing the LFO to control the volume (LFO -> AmpVolume).
- Add a bit of animation to the sound by routing the LFO to control the filter. Set the PatchCord amount low for a subtle effect.

The LFOs have five parameters: Shape, Sync, Rate, Delay and Variation.

Shape

LFO waveforms have different shapes. The shape of the waveform determines the effect of the LFO. LFOs have traditionally been used to add vibrato or repeating movement to a sound. These new shapes offer a lot of new programming possibilities.

If you modulate the pitch of an instrument, it's easy to visualize the shape of the waveform. For example, the sine wave has a smooth, rolling shape that changes the pitch smoothly. The square wave changes between two pitches abruptly. A sawtooth waveform increases the pitch smoothly, then abruptly changes back down. The available waveforms are shown below.

LFO Tricks & Tips:

- The Random LFO wave is truly random and is different for each voice and layer.
- The Pattern (Pat) waveforms will sound the same on different layers and voices.
- Sine + Noise is very useful for simulating trumpet and flute vibrato.

★ When routing Hemi-quaver to Pitch:

- +38 = major scale
- 38 = phrygian scale
- +76 = whole tone scale
- (+38) + (+76) = diminished (two cords)
- odd amount = S+H sound

Note: References to musical intervals in the pattern LFO shapes are with the LFO routed to pitch and a PatchCord amount of +38.

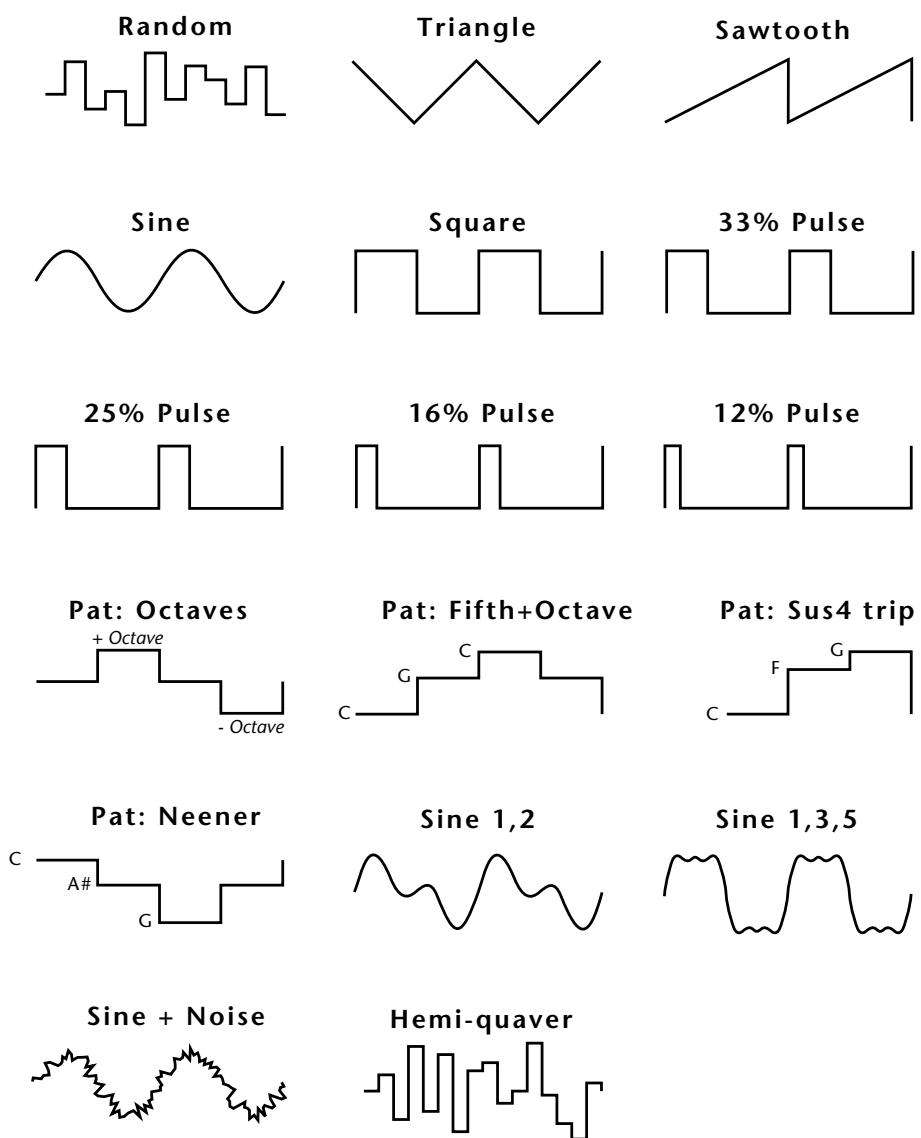

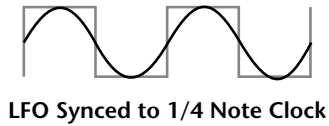

L1	LFO1	SHAPE	SYNC
		sawtooth	<u>key sync</u>

Sync

The Sync field specifies whether the LFO is synchronized to a key stroke or is Free Running. Key Sync starts the LFO wave at the beginning of its cycle each time you press a key on the controller. In Free Run mode, the LFO wave begins at a random point in its cycle each time you press a key on the controller.

Rate

The Rate field determines the LFO speed in absolute frequency rate values or tempo-based note values. All values equal to or greater than zero specify absolute frequency values from 0.08 Hz to 18.14 Hz.

Values less than zero specify tempo-based rates. If you modulate the rate of a tempo-based LFO, the rates will jump between the tempo-based note values with each PatchCord increment of "1". As an example: if the LFO rate was set to 8/1 and you patched the Mod Wheel to control rate with a PatchCord amount of +1, turning the Mod Wheel to maximum would change the LFO rate to 4/1d. Refer to the chart below.

L1	LFO1	RATE	DELAY	VAR
		<u>0.08Hz</u>	60	020

Tempo-based Rates (based on Master Clock Tempo)	Display
octal whole note	8/1
dotted quad whole note	4/1d
octal whole note triplet	8/1t
quad whole note	4/1
dotted double whole note	2/1d
quad whole note triplet	4/1t
double whole note	2/1
dotted whole note	1/1d

Tempo-based Rates (based on Master Clock Tempo)	Display
double note triplet	2/1t
whole note	1/1
dotted half note	1/2d
whole note triplet	1/1t
half note	1/2
dotted quarter note	1/4d
half note triplet	1/2t
quarter note	1/4
dotted 8th note	1/8d
quarter note triplet	1/4t
8th note	1/8
dotted 16th note	1/16d
8th note triplet	1/8t
16th note	1/16
dotted 32nd note	1/32d
16th note triplet	1/16t
32nd Note	1/32

Delay

The Delay parameter defines the amount of time between hitting a key on the controller and the onset of the LFO modulation. Delay can be used to simulate an effect often used by acoustic instrument players where the vibrato is brought in only after the initial note pitch is established. The following illustration demonstrates how delay works.

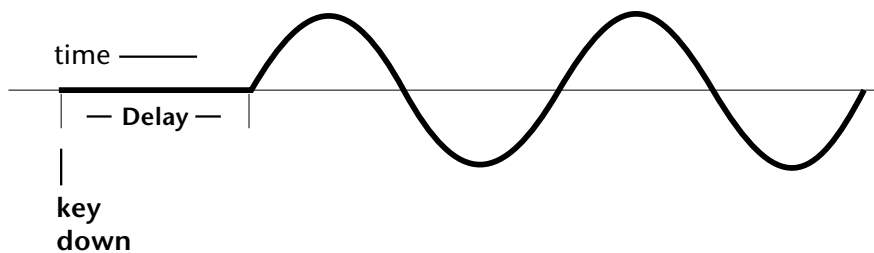

All Delay values equal to or greater than zero specify absolute time rates from 0 to 127. Values less than zero specify Tempo-based mode. Refer to the previous table for times and tempo-based rates.



*Variation is disabled
when a Tempo-Based LFO is
selected.*

Variation

LFO Variation sets the amount of random variation of the LFO each time you press a key on the controller. This creates a chorus or ensemble effect since each note played has a slightly different modulation rate. The higher the value entered, the greater the note to note variation in the LFO.

The Variation value range is from 0 through 100.

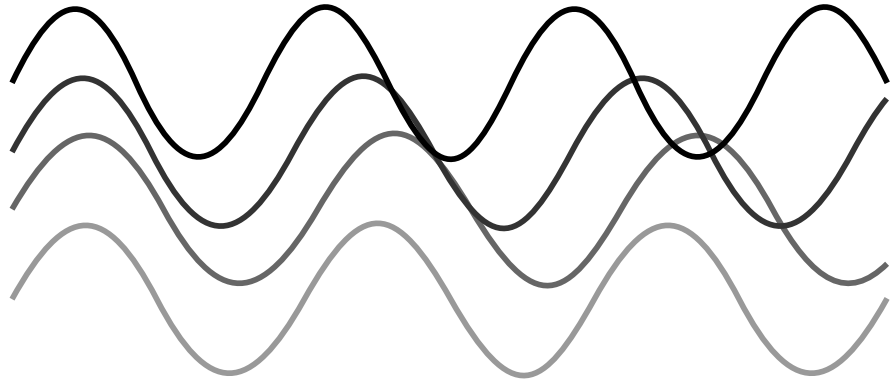

LFO variation changes the rate of each note to create an “ensemble” effect.

PatchCords

PatchCords tie everything together by connecting modulation sources to destinations. Each PatchCord has its own *Amount* control which can be positive or negative (negative amounts invert the signal). In addition, the PatchCord amounts themselves can be controlled by any modulation source. Proteus 1000 provides 24 patches for each layer.

There are three permanently connected control routings: volume envelope to amplifier, pitch wheel to pitch and key to pitch. All other connections must be made using the PatchCords.

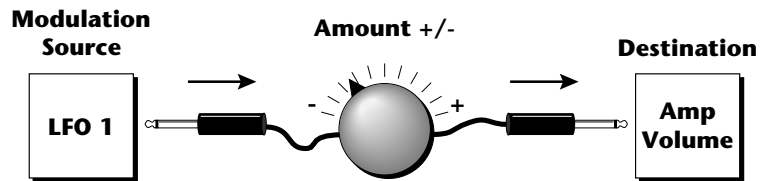

Each patch has an amount field which determines how much modulation is applied to the destination. The modulation amount can be positive or negative. Negative values invert the input. The amount value range is from -100 to +100.

L1	PATCHCORD	#01
RlsVel	->	AmpVol +100

L1	PATCHCORD	#24
Key+	->	FiltRes -27

Modulator Polarity

You will notice that some of the modulation sources have symbols following their names. For example, there are three Velocity modulation sources, Vel +, Vel ±, and Vel <.

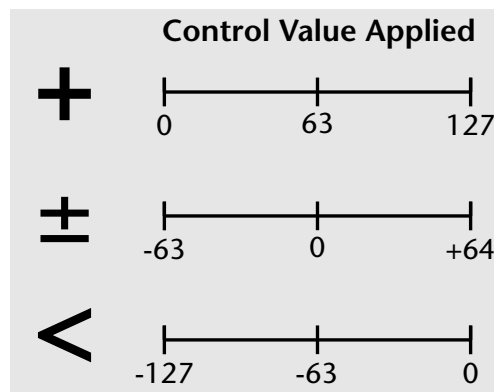
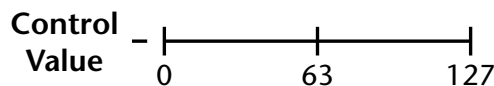

+ modulation ADDS to the initial value. (Normal)

± centers around Zero. (Use for LFOs, Filt. Freq.)

< modulation SUBTRACTS from the initial value

Note: Flip-Flop Footswitches 1 & 2 remain in their last condition when a new preset is selected. Flip-Flop Footswitch 3 resets to the Off condition whenever a new preset is selected.

“+” Modulation: Uses only the positive half of the range, adding to the current value. For example, if the filter frequency were set to 100 and you patched Vel+ to the filter, the filter frequency would increase from 100 as velocity was applied.

“±” Modulation: Uses both sides (full) range and both adding and subtracting from the current value. For example, if the filter frequency were set to 100 and you patched Vel ± to the filter, the filter frequency would decrease from 100 with key velocities of 63 or less and increase from 100 with key velocities of 64 and above. Therefore with medium velocity, the Filter frequency is approximately where you set it at 100.

An LFO ± works the same way; on the positive half of the cycle it increases the initial amount and on the negative half of the cycle it decreases the initial amount. With a ± modulation source, a value of 64 equals 0.

“<” Modulation: Uses only the negative half of the range, subtracting from the current value. For example, if the Amplifier Volume were set to +3 dB and you patched Vel < to AmpVol, the volume would be at +3 dB only when maximum key velocity were applied. Lower key velocities would scale back the volume. In general, < modulation is the proper choice when modulating Volume.

Refer to the following table for a list of modulation sources and destinations available in the Proteus 1000.

Modulation Sources:

Off
 Key (+, ±)
 Velocity (+, ±, <)
 RlsVel (Release Velocity)
 Gate
 Pressure
 PitchWhl (Pitch Wheel)
 ModWhl (Modulation Wheel)
 Pedal
 MIDI A-L
 PLagOut (Preset Lag Out)
 PRampOut (Preset Ramp Out)
 FootSw1 - 3 (Foot Switch 1-3)
 FootFF (Flip-Flop Foot Switch 1 -3)
 MIDI Volume (Controller 7)
 MIDI Pan (Controller 10)
 MIDI Expression (Controller 11)
 KeyGlide
 VolEnv +, ±, < (Volume Envelope)
 FilEnv +, ±, < (Filter Envelope)
 AuxEnv +, ±, < (Auxiliary Envelope)
 LFO 1 & 2 (+, ±)
 White (White Noise)
 Pink (Pink Noise)
 XfdRand (Crossfade Random)
 KeyRand 1 & 2 (Key Random)
 Lag 0 sum (summing amp out)
 Lag 1 sum (summing amp out)
 Lag 0 & 1 (Lag Processor)
 Clk Divisors (Octal, Quad, Double Whole, Whole, Half, Qtr, 8th,16th)
 DC (DC Offset)
 Summing Amp
 Sum
 Switch
 Absolute Value
 Diode
 Flip-Flop
 Quantizer
 4x Gain

Modulation Destinations

Off
 KeySust (Key Sustain)
 FinePtch (Fine Pitch)
 Pitch
 Glide
 ChrsAmt (Chorus Amount)
 'SStart (Sample Start) -note-on)
 SLoop (Sample Loop)
 SRetrig (Sample Retrigger)
 FiltFreq (Filter Frequency)
 'FiltRes (Filter Resonance -note-on)
 AmpVol (Amplifier Volume)
 AmpPan (Amplifier Pan)
 RTXfade (Real-time Crossfade)
 VEnvRts (Volume Envelope Rates -all)
 VEnvAtk (Volume Envelope Attack)
 VEnvDcy (Volume Envelope Decay)
 VEnvRls (Volume Envelope Release)
 FEnvRts (Filter Envelope Rates -all)
 FEnvAtk (Filter Envelope Attack)
 FEnvDcy (Filter Envelope Decay)
 FEnvRls (Filter Envelope Release)
 FEnvTrig (Filter Envelope Trigger)
 AEnvRts (Auxiliary Envelope Rates -all)
 AEnvAtk (Auxiliary Envelope Attack)
 AEnvDcy (Auxiliary Envelope Decay)
 AEnvRls (Auxiliary Envelope Release)
 AEnvTrig (Auxiliary Envelope Trigger)
 LFO 1 & 2 Rate
 LFO 1 & 2 Trigger
 Lag Processor In 0 & 1
 Sum (Summing Amp)
 Switch
 Abs (Absolute Value)
 Diode
 Quantize
 Flip-Flop
 Gain 4x
 Cord 1-24 Amount

Pitch Bend Range

Specifies the Pitch Wheel range in semitones for the current layer. Pitch Wheel is a standard synthesizer control which is transmitted as a MIDI continuous controller message used (normally) to bend the pitch up and down.

The PitchBend range is from 0 to ± 12 semitones or "Master." A setting of "0" turns the pitch wheel Off for the current layer. The Master setting uses the Pitch Bend range defined in the *Master menu*.



Mix Output

This feature allows you to program the Effect Send as a part of the preset. Note that for this feature to work, the Mix Output setting in the Master menu MUST be set to "Preset" on the selected MIDI channel. If you want to define output routing by MIDI channel, set it up using the Mix Output page in the Master menu. See "Mix Output" on page 37 for more information.

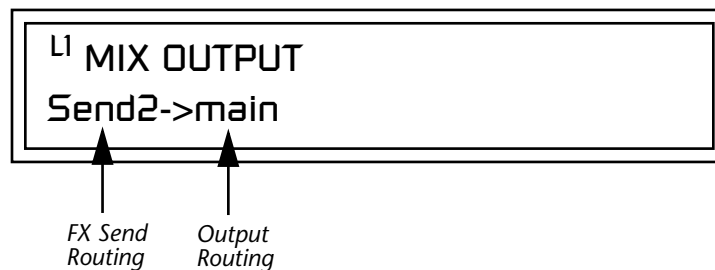

The Sends function as effect processor inputs (effect sends). The Output Routing field shows the true routing of the Sends to the Main output. The Output Routing never changes!

► To Control the Mix Output from the Preset:

1. Move the cursor until it is underneath the Layer field and change the Layer using the Data Entry Control.
2. Move the cursor until it is underneath the FX Send Routing field and change the Send (1-4) using the Data Entry Control.
3. Locate the MIX OUTPUT screen in the Master menu.
4. Set the MIDI channel you are using to "use preset".

Common Preset Parameters

Preset Effects

This section of the Edit menu chapter describes parameters that affect all layers in the preset.

Proteus 1000 has two stereo effects processors. When playing presets one at a time, the two processors can be programmed as part of the preset. The diagram below shows how the effects are integrated into the signal path using a parallel effects send/return model, similar to a mixing console.

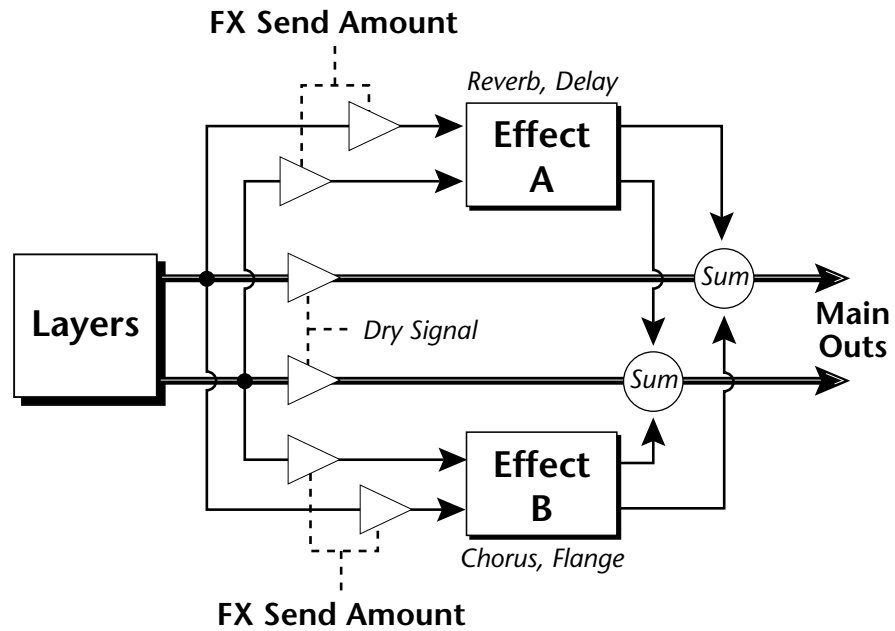

Refer to the Effects chapter for additional information and instructions for setting up both the Preset Effects and the Master Effects.

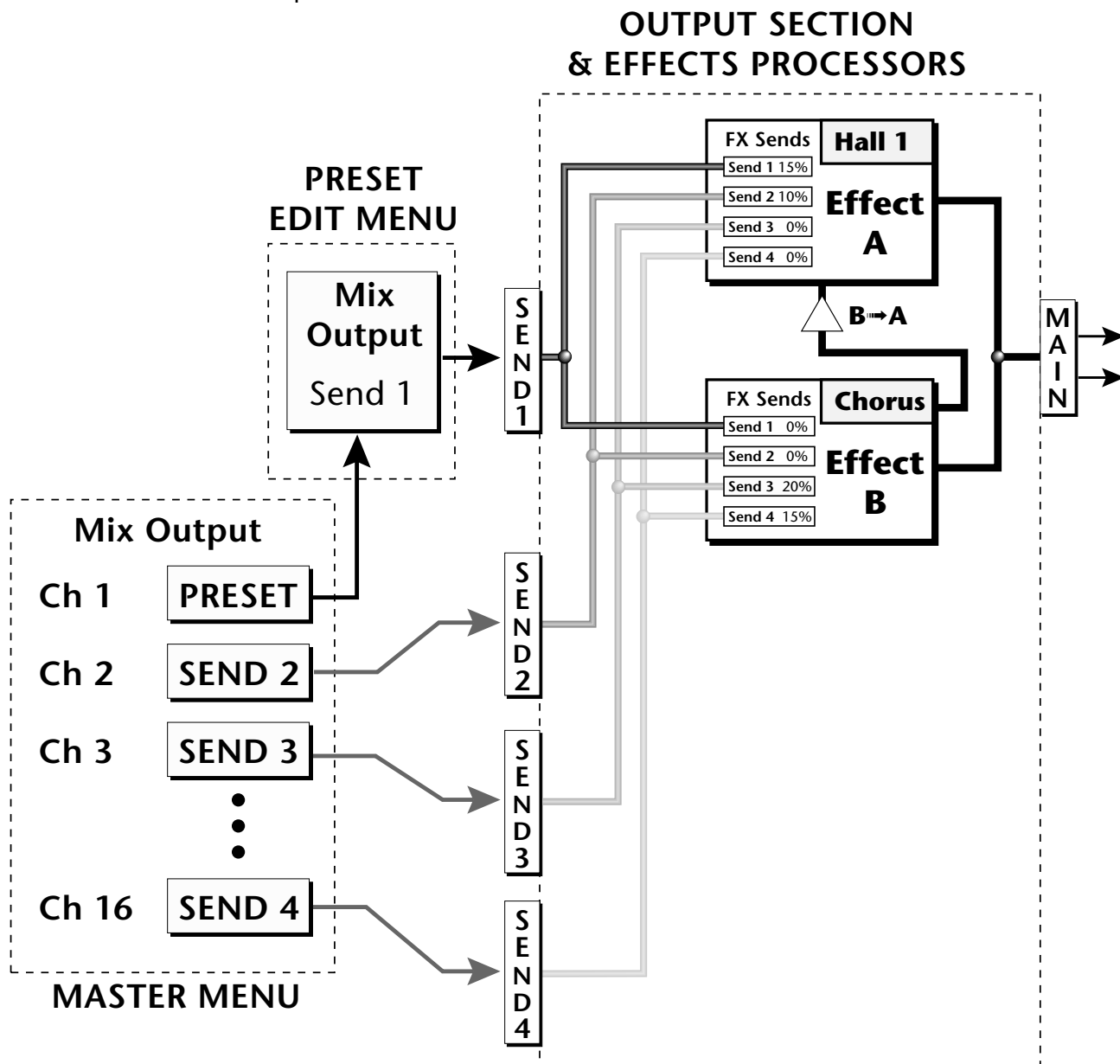

The Mix Output setting in the Master Menu determines if the Preset's Mix Output routing will be used. This allows the Sends to be programmed by either MIDI Channel or by Preset, whichever you prefer.

FXA Algorithm

This screen selects the effect type for Effect Processor A. The “A” effects consist of different reverb types and digital delays. Move the cursor to the lower line of the display and select the effect you want.

FXA ALGORITHM
Lg Concert Pan

A Effect Types

- | | |
|---------------------|-----------------------|
| 1. Room 1 | 23. BBall Court |
| 2. Room 2 | 24. Gymnasium |
| 3. Room 3 | 25. Cavern |
| 4. Hall 1 | 26. Concert 9 |
| 5. Hall 2 | 27. Concert 10 Pan |
| 6. Plate | 28. Reverse Gate |
| 7. Delay | 29. Gate 2 |
| 8. Panning Delay | 30. Gate Pan |
| 9. Multitap 1 | 31. Concert 11 |
| 10. Multitap Pan | 32. Medium Concert |
| 11. 3 Tap | 33. Large Concert |
| 12. 3 Tap Pan | 34. Large Concert Pan |
| 13. Soft Room | 35. Canyon |
| 14. Warm Room | 36. DelayVerb 1 |
| 15. Perfect Room | 37. DelayVerb 2 |
| 16. Tiled Room | 38. DelayVerb 3 |
| 17. Hard Plate | 39. DelayVerb 4 Pan |
| 18. Warm Hall | 40. DelayVerb 5 Pan |
| 19. Spacious Hall | 41. DelayVerb 6 |
| 20. Bright Hall | 42. DelayVerb 7 |
| 21. Bright Hall Pan | 43. DelayVerb 8 |
| 22. Bright Plate | 44. DelayVerb 9 |

FXA Parameters

The FXA parameters are Decay, High Frequency Damping, and the FxB to FxA send. **Decay** sets the length of time it takes an effect to fade out. **HF Damping** causes the high frequency energy to fade away more quickly during the reverb decay. **FxB to FxA** controls the amount of the “B” effect sent through effect “A”. This allows you to place the two effects in series and create setups such as “distortion through reverb” among others. Please refer to the Effects chapter for more information about the effects.

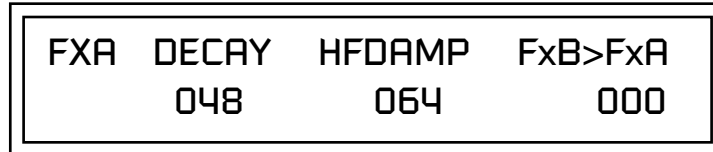

FXA Send Amounts

These parameters set the effects amounts for each of the four stereo effects busses.

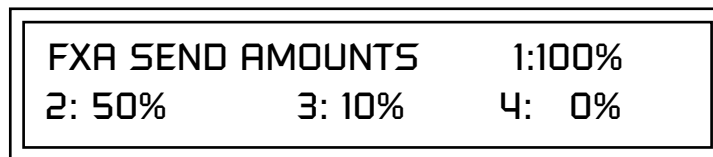

FXB Algorithm

This screen selects the effect type for Effect Processor A. Move the cursor to the lower line of the display and select the effect you want.

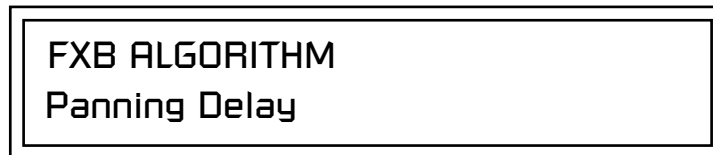

B Effect Types

- | | | |
|--------------|--------------------|-----------------------|
| 1. Chorus 1 | 12. Flange 5 | 23. PanDelay Chorus 1 |
| 2. Chorus 2 | 13. Flange 6 | 24. PanDelay Chorus 2 |
| 3. Chorus 3 | 14. Flange 7 | 25. Dual Tap 1/3 |
| 4. Chorus 4 | 15. Big Chorus | 26. Dual Tap 1/4 |
| 5. Chorus 5 | 16. Symphonic | 27. Vibrato |
| 6. Doubling | 17. Ensemble | 28. Distortion 1 |
| 7. Slapback | 18. Delay | 29. Distortion 2 |
| 8. Flange 1 | 19. Delay Stereo | 30. Distorted Flange |
| 9. Flange 2 | 20. Delay Stereo 2 | 31. Distorted Chorus |
| 10. Flange 3 | 21. Panning Delay | 32. Distorted Double |
| 11. Flange 4 | 22. Delay Chorus | |

FXB Parameters

The FXB parameters are Feedback, LFO Rate and Delay. **Feedback** sends the output of the effect back into the input. This creates multiple echoes on a delay effect and intensifies a chorus or flange effect. **LFO Rate** allows you to change the speed of the modulation oscillator for flange and chorus effects. **Delay** sets the length of the delay line. This affects the time between echoes, or the tone of flange effects.

FXB	FEEDBK	LFORATE	DELAY
	032	003	200ms

FXB Send Amounts

These parameters set the effects amounts for the four stereo effects busses.

FXB SEND AMOUNTS	1:100%
2: 50%	3: 10%
	4: 0%

Preset Patchcords

Preset PatchCords give you real-time control of global parameters. The effect processors are a powerful synthesis tool and this feature lets you control and use them in exciting new ways. For example, you can dynamically adjust the effects mix during a sequence or live performance.

There are many exciting performance possibilities using Preset PatchCords to control BEATs and Arpeggiator parameters. The front panel knobs “Wild 1-4” are usually connected to Arp and BEATs parameters in factory presets marked “arp:” or “bts:”. Likewise, Pitch and Mod wheels are often routed to “Beats Busy” and “Beats Variation” in factory presets marked “bts:”. Be sure to try out these controls

There are 12 Preset PatchCords per preset with a source, a destination and an amount control. The amount can be set from -100 to +100. The Preset PatchCord controls are *added* to the FX Send Amounts set in the Master or Edit menus. In other words, multiple sources connected to destinations are *summed*.



To crossfade between effects.

- 1) Set FXA Send 1 to 100%.
- 2) Set FXB Send 1 to 0%.
- 3) Set FX Cord #1 to FXA Send 1 at -100.
- 4) Set FX Cord #2 to FXB Send 1 at +100.

Increasing the controller amount will crossfade from FXA to FXB.

PRESET CORDS		#01
Pedal	-> FXBSend2	+100

Modulation Sources:

Off
PitchWhl (Pitch Wheel)
ModWhl (Modulation Wheel)
Pedal
MIDI Volume (Controller 7)
MIDI Pan (Controller 10)
MIDI Expression (Controller 11)
MIDI A-L
Footswitch 1
Flip-Flop Footswitch 1
Footswitch 2
Flip-Flop Footswitch 2
Footswitch 3
Flip-Flop Footswitch 3
DC

Modulation Destinations

Off
Effect A Send 1
Effect A Send 2
Effect A Send 3
Effect A Send 4
Effect B Send 1
Effect B Send 2
Effect B Send 3
Effect B Send 4
Preset Lag In
Preset Lag Amount
Preset Lag Rate
Preset Ramp Rate
Arp Resolution
Arp Extension
Arp Velocity
Arp Gate
Arp Interval
Beats Velocity Group 1-4
Beats Transpose (Xpose) Group 1-4
Beats Variation
Beats Busy

Initial Controller Amount

This parameter sets the initial value of MIDI controllers A-L when the preset is first selected. The front panel Control Knobs can be thought of as front panel MIDI controllers because in the Proteus 1000, they are treated just as if they originated from an external MIDI device. Refer to the following diagram. There are three Initial Controller Amount screens (A-D, E-H, I-L).

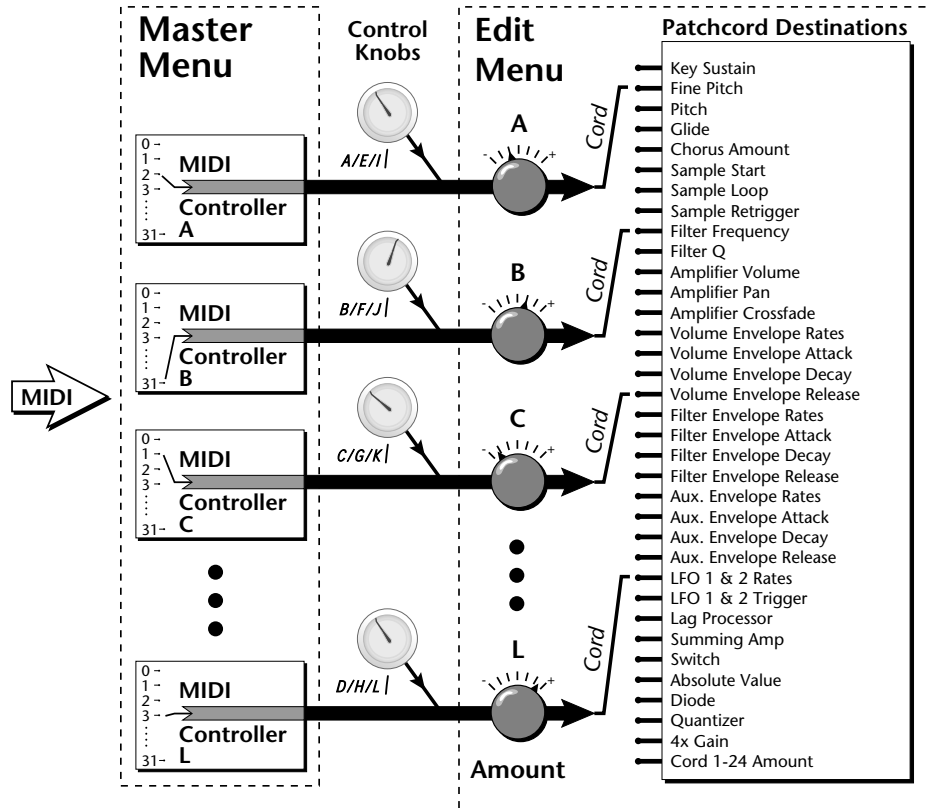

External MIDI controller numbers are assigned to the Letters A-L in the Master menu. The Initial Controller Amount value is sent to the PatchCord destination when the Preset is first selected. If you move the Control Knob, then that value replaces the initial value. If MIDI controller data is received it will similarly replace the knob or initial setting.



The Initial controller amounts can be set from 000-127 or they can be turned Off. If set to Off, the current controller value is used when the preset is first selected. Setting the Initial Amount to "off" uses the values from the previously selected preset.

Keyboard Tuning

In addition to the standard equally divided octave tuning, Proteus 1000 contains twelve factory programmed tunings and 12 user-definable tunings. The Keyboard Tuning parameter selects which tuning is used by the current preset. The User Tuning tables are defined in the Master menu.

The factory Keyboard Tuning tables are described in the following table.

Tuning Tables	Description
Equal Temperament	Standard Western tuning (12 equally spaced notes per octave)
Just C	Just intonation. (Based on small interval ratios. Sweet and pure, non-beating intervals.)
Vallotti	Valotti & Young non-equal temperament. (Similar to 12 tone equal temperament. Each key has a different character for a given scale.)
19-Tone	19 tone equal temperament. (19 notes per octave. Difficult to play, but works well with a sequencer.)
Gamelan	5 tone Slendro and 7 tone Pelog. (Javanese. Pelog are white keys, Slendro are black keys. Exotic tunings of Gamelan flavor.
Just C2	Allows you to play the following chords in the key of C: C, E, F, G, A, B, C#m, D#m, Em, F#m, G#m, Am, Bm
Just C-minor	Allows you to play the following chords in the key of C: C, E, F, G, A, B, Em, Am, Bm, C#m, D#m, G#m
Just C3	Allows you to play the following chords in the key of C: C, D, F, Bb, C#m, Dm, Em, F#m, G#m, Am
Werkmeister III	A "well" temperament developed in the 17th century. Although you can play in all keys, each key sounds slightly different.
Kirnberger	Another well temperament developed by Johann Philipp Kirnberger where no pitch is more than 12 cents off from equal temperament.
Scarlatti	A variant of Meantone tuning which was used from the 15th to 18th centuries.
Repeating Octave	Middle C octave is repeated up and down the keyboard. Link with a preset in equal temperament to form unusual inversion up and down the keyboard.
User 1-12	Define your own tuning tables (<i>Master menu</i>).

Refer to "User Key Tuning" on page 52 in the Master Menu chapter for instructions on how to define your own Keyboard Tunings.



Proteus 1000 implements the MIDI Tuning Dump protocol which allows you to create tuning tables on your personal computer and download them via MIDI. There are several computer applications available on the internet which let you create and download tuning tables via MIDI.

The Just C Tuning Tables

Well Tempered and Just were standard keyboard tunings up until the 20th-century when the current “equal tempered” scale became prevalent. In an equal tempered scale, the octave is equally divided into 12 parts. In Just or Well Tempered scales, the 12 notes are separately tuned to produce pure chords. However, in Just tunings you are limited to playing certain chords and if you play the wrong chord it may sound very BAD!

Proteus 1000 allows you to modulate between keys by providing you 12 user tuning tables. Tuning tables can be changed as you play using a program change (create several presets with the same sound and different tuning tables), by MIDI SysEx command (using a programmable MIDI footswitch or other device), or using a continuous controller (link 2 presets and crossfade between them using a controller). The Just C2, Just C min, Just C3 Tuning Tables.

These new tuning tables take the concept of just intonation a step beyond previous E-mu products. Fully explaining the mysteries of just intonation is beyond the scope of this manual, but the subject is covered exhaustively in Hermann Helmholtz's On the Sensations of Tone, available at most libraries and bookstores.

The new tables are called Just C2, Just C3, and Just C Minor. Try playing in the key of C/Cm using each table. You'll quickly discover both the wonders and the frustrations of just intonation! In Just C, for example, you'll find that the chords C, Em, F, G, and Am sound beautiful. If you hold one of these chords, you'll hear no “beating”. After playing for a few minutes, switch back to Equal Temperament for a rude awakening!

At this point you might wonder why anyone would use Equal Temperament to begin with. For the answer to that question, play a D, Dmi, or Bb chord!.The intervallic ratios that make the C & G chords sound so pure make the D chord sound horribly out of tune. That's why we had to include Just C3. In this tuning, D, Dmi and Bb sound in tune, but the G chord will sound wrong.

Each of the 4 tables allows you to play a different group of common chords in just intonation. Sadly, there is no single 12 note tuning that will allow all of the common chords to be in tune, and of course that's why they invented the equal temperament tuning system that we use today.

Just C

Play these chords: C, E, F, G, A, Cm, C#m, Em, F#m, Gm, Am

Just C2

Play these chords: C, E, F, G, A, B, C#m, D#m, Em, G#m, Am, Bm

Just C2 minor

Play these chords: C, D^b, D, E^b, G, A^b, Cm, Em, Fm, Gm

Just C3

Play these chords: C, D, F, B^b, C#m, Dm, Em, F#m, G#m, Am

Preset Links

You can link presets to other presets to create layering or keyboard splits. The current preset can be linked with up to two other presets (Links 1 & 2). Each linked preset can be assigned to a specific range in order to create keyboard splits or can be assigned a velocity range to switch links according to key velocity. In addition, you can specify Volume, Pan, Transpose and Delay settings for each Link. The modulation parameters specified in each preset remain in effect for each preset in the link.

LINK 1 Preset	CMP5R
000 ² Preset Name	

LINK 1	KEY	VEL
RANGE	C-2	G8
		000-127

LINK 1	VOLUME	PAN
	+0dB	00

LINK 1	TRANSPOSE	DELAY
	+00	0

Links provide an easy way to create new sounds by combining the existing presets. Or, you can create your own custom stacked presets with up to 12 layers! We're talking LARGE sounds here. Of course Links can also be used when you just want to stack up two sounds.

As an example, let's stack two presets to create a big sound. Start with a preset you like, then go into the Links screen and start scrolling through the preset list while you play to hear both presets together. When you find a winner, simply Save the preset and you're finished!

- You can "Split" the keyboard up to 12 ways by using combinations of the Layers and Links.
- By adjusting the Velocity for the link, you can bring in the link by playing hard.
- Transposing the Link can radically change the sound.
- The delay parameter lets you create surprise effects, echoes or cascades of sound as you continue to hold the keys.

Preset Tempo Offset



See "Base Tempo" on page 54.

This function allows you to double or halve the Base Tempo as it applies to this preset. When playing or sequencing several presets in Multimode, the Base Tempo may be too fast or slow for one preset. Using this feature, you can adjust the tempo for the misbehaving preset. The Tempo Offset can use the **current tempo** or be set to **half** or **twice** the current tempo.

TEMPO OFFSET
use current tempo x 2

Audition Riff Selection



Listening to the Riffs is a quick way to learn the sounds in Proteus 1000. If a preset has hidden tricks or controllers, these will be shown off in the Riff.

A Riff is a short pre-recorded musical phrase which can be anything from a single note to a full 16-track sequence as in the BEATS (bts) Riffs. This function allows you to assign a Riff to a Preset. The Preset Riff will be used when the front panel Audition button is pressed or when BEATS mode is set either to "On" or "Omni" in the main preset selection screen.

The Riffs themselves cannot be modified.

AUDITION SELECTION
Plays:KEY-MiddleC

Play Solo Layers

When constructing multilayer sounds it is often useful to turn off one or more of the layers so you can hear what you're doing! This feature allows you to temporarily solo individual layers or listen to them in any combination. This screen differs from the other Edit screens in that it is NOT saved with the preset. The values reset each time you exit the Edit menu.

Solo is activated by setting any layer to On (On = the layer is being Soloed). Any layers set to **On will play** and any layers set to **Off will be muted**. If all layers are set to Off, then Solo mode ends and all layers play normally. When you exit the Edit menu, all layers play normally.

PLAY SOLO LAYERS
1: off 2: off 3: off 4: off

Programming Tutorial

Editing Presets

Changing the Instrument

There is so much you can do with the Proteus 1000 it's impossible to describe it all. This chapter will give you some ideas for programming your own custom sounds and contains step-by-step instructions to help you get started. In order to get the most from this chapter, we recommend you actually try each example. Have fun!

One of the easiest ways to make a new preset is to edit an existing preset. This is also an excellent way of becoming familiar with Proteus 1000. If you don't like what you hear, simply select a new preset, then Proteus 1000 reverts to the original sound. Changes are not permanent until you Save them (see "Saving a Preset" on page 155).

Let's experiment and modify a few parameters of an existing preset. We'll start with functions that have an obvious effect on the sound: Instrument Select, Tuning, and Chorus.

Changing the instrument is the easiest and most dramatic way to modify an existing preset.

► To Change the Instrument for the Current Layer

1. Choose any cool preset, then press the Edit button.
2. Scroll through the Edit menu until you come to the Instrument page.

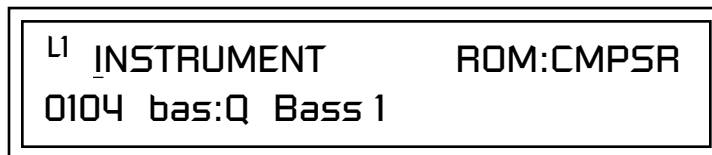

```
L1 INSTRUMENT      ROM:CMPSR
0104 bas:Q Bass 1
```

3. Move the cursor down to the bottom line (using a Cursor button).
4. Use the Data Entry Control to change the instrument. This changes the instrument for the current layer (in this case it's L1).
5. Play the keyboard as you scroll through the various instruments.

► **To Change the Instrument for any Layer in the Preset**

6. Move the cursor back up to the first field in the first line (the layer).
7. Use the Data Entry Control to select the layer you want.



8. Repeat steps 3 and 4 for each selected layer. Find an instrument that sounds good when combined with the previous instruments selected.

With all these great instruments to work with, you really can't go wrong. Now let's play with the tuning.

*Changing the Tuning
of an Instrument*

Tuning the selected layer of the preset changes the pitch of the key on the controller. If the numbers are "00," it means that the instruments are tuned to concert pitch (A=440 Hz). The Coarse tuning value represents whole semitone intervals. The Fine tuning value shifts the pitch in 1/64 semitones (or 1.56 cents).

► **To Tune the Instrument of the Current Layer**

1. Scroll through the Edit menu until you come to the Tuning page.

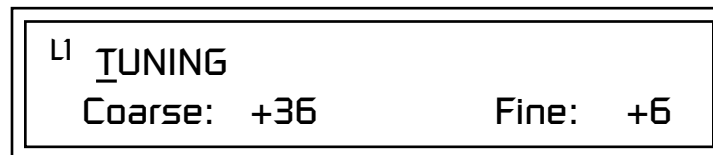

2. Move the cursor to the Coarse field (using the cursor button).
3. Set the value to +12 to shift the pitch up a whole octave. To shift the pitch in smaller units than a semitone, use the Fine field.

Try tuning one of the instruments to a perfect fifth above the other by setting the Coarse value to +7.

Tuning an instrument far out of its normal range completely changes the character of the sound. For example, if you tune a bass guitar up 2 octaves, it's going to sound rather petite. On the other hand, if you tune it down 2 octaves, you can probably rattle plaster off the walls! Experiment with radical pitch shifting. You'll be surprised at the results.

Chorus



WARNING: Since it works by doubling the instruments, Chorus halves the number of notes you can play on Proteus 1000.

This is an easy one. Chorus works by doubling the instruments and detuning them slightly. The larger the chorus value, the more detuning occurs. The Width parameter controls the stereo spread. A Width value of 0% reduces the chorus to mono, a value of 100% provides the most stereo separation. Chorus is useful when you want to “fatten up” a part quickly and easily.

► To Chorus a Layer

1. With the cursor on the top line of the display, turn the Data Entry Control until you find the Chorus page.
2. Use the cursor buttons to advance the cursor to the Chorus field (the first field in the bottom line of the display). Use the Data Entry Control to turn on chorus.

L1	CHORUS	WIDTH
	off	100%

3. Select a Width value based on the amount of detuning you want. Smaller numbers mean less detuning, larger ones more.

You can select various amounts of chorusing for each of the instruments, just play around with the Chorus and Width parameter until you like what you hear.

Volume Envelope

Every sound you hear, whether it’s a piano note, a drum, or a bell, has a characteristic volume curve or envelope. This Volume Envelope shapes the volume of the sound which grows louder or softer in various ways during the course of the sound. The volume envelope of a sound is one of the clues our brain uses to determine what type of sound is being produced.

An envelope shapes the sound or volume of the sound over time. The envelope generators in Proteus 1000 all have six stages to the contour: Attack 1, Attack 2, Decay 1, Decay 2, Release 1 and Release 2. When you press a key on the keyboard, the envelope goes through each of the first four stages, advancing to the next stage when the defined Level for each is reached. As long as you continue to hold the key down, the envelope continues through the first four stages holding at the end of the Decay 2 level until the key is released. When you release the key, the envelope jumps to the Release stages (no matter where the envelope is when you release the key) ending at the Release 2 level.

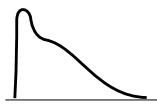

Piano

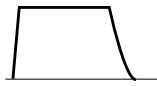

Organ



Strings

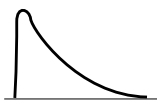

Percussion

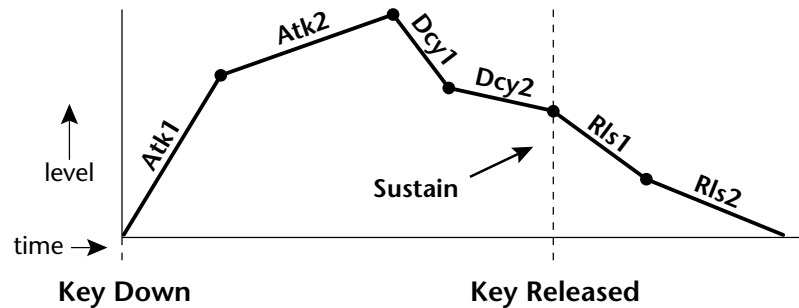

Every instrument in Proteus 1000 has its own predetermined volume envelope which is used when the Volume Envelope parameter is set to "factory." By setting the Volume Envelope to "time-based" or "tempo-based," we can reshape the instrument's natural volume envelope any way we want. By reshaping the volume envelope of an instrument, you can dramatically change the way the sound is perceived. For example, you can make "bowed" pianos or backward gongs. The diagrams to the left show the characteristic volume envelopes of a few common sounds.

In preparation for this experiment choose almost any of the standard organ presets which continues to sustain when the key is held down. Go to the Instrument page and set it to "None" on all layers except Layer 1. Now you're ready to play with the Volume Envelope.

► To Setup the Volume Envelope

1. Go to the Volume Envelope mode screen and set the Volume Envelope mode to "time-based."



2. Now move on to the next screen to set the Volume Envelope parameters.

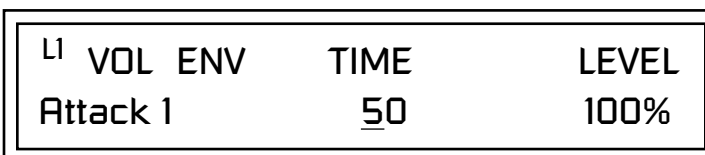

3. Increase the Attack 1 time value and play a note. The attack controls the time it takes for the sound to reach the Attack level when a key is pressed and held.

Working with Filters

4. Move the cursor to the first field in the bottom line and use the cursor buttons to advance to the Release pages.
5. Increase the Release 1 and 2 times. Note the effect as you release the key on the controller. The Release stages controls the time it takes for the sound to die away when a note is released.

The filters make it possible to remove certain components of the sound. A low pass filter removes the high frequency components or put another way, it “lets the low frequencies pass.” A high-pass filter removes the low frequency components from the sound letting only the high frequencies pass. See “Proteus 1000 Filter Types” on page 105 for a complete list of Proteus 1000’s filters and their descriptions.

In preparation for the next tutorial, select the Default Preset.

1. Go to the Instrument screen (Edit menu) and select Instrument #321 - Rast Keys. This is a really buzzy sound. Since filters work by removing or accentuating certain frequencies, we want to make sure that we have a lot of frequencies to start with.
1. Advance to the Filter Type screen using the Data Entry Control. Select the Classic 4th order filter.

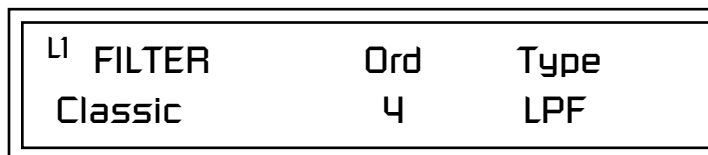

2. Go to the Filter Frequency and Q screen. Position the cursor in the Freq: field as shown in the following illustration.

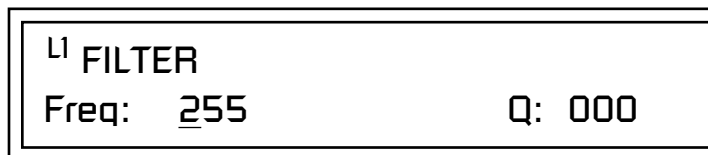

The Frequency parameter determines the filter cutoff frequency or the frequency the filter uses as the highest frequency allowed to pass.

If you play the keyboard now, you should hear the raw Looped Perc 1 sound. Slowly decrease the filter cutoff frequency value as you play the keyboard. The sound gets more and more dull as you remove more and more high frequencies from the sound. At some point, the sound completely disappears. (You have filtered out everything.) The chart on the following page illustrates what you just did.

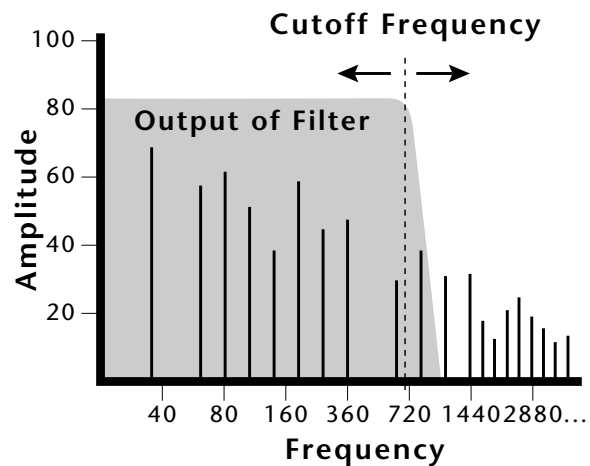

3. Open the filter back up to 255, then move the cursor to the Q field.
4. Set the Q to 10, then move the cursor back under the Freq value. As you change the frequency, notice that the sound now has a sharp, nasal quality. A high Q boosts or amplifies the frequencies at the cutoff frequency (Fc).
5. Reset the cutoff frequency to the lowest setting (0.08Hz) and the Q to 00.

Adding the Filter Envelope

Now let's modulate the Filter Frequency with the Filter Envelope. The Filter Envelope is a device that can automatically change the filter frequency during the course of the note. Before we define the Filter Envelope, we need to patch the Filter Envelope to the Filter Frequency.

► To Setup the Filter Envelope

1. Go to the PatchCord screen.

L1	PATCHCORD	#01
R1sVel	-> AmpVol	+100

2. Move the cursor below the first field in the bottom line of the display. This is the Source field. Use the Data Entry Control to change the Source to "FiltEnv" as shown in the following illustration.
3. Advance the cursor to the next field. This is the Destination field. Use the Data Entry Control to change the destination to "FiltFreq."

4. Move the cursor to the last field in the line. This is the Amount field. The Amount field determines the amount of modulation applied. Set this value to "+100."

```

L1 PATCHCORD                #01
FiltEnv+  ->  FiltFreq      +100
  
```

This setup connects the Filter Envelope Generator to the Filter Cutoff as shown in the following diagram.

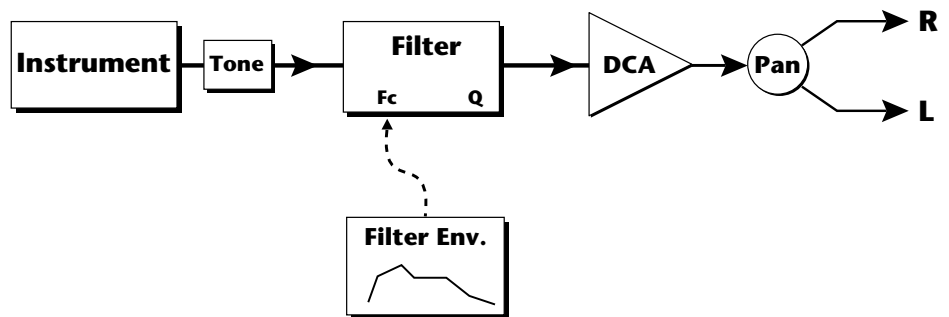

5. Now, return to the Filter Envelope Mode screen. Set the Mode to "time-based."

```

L1 FILTER ENVELOPE
Mode: time-based
  
```

6. Advance to the Filter Envelope parameter page.

```

L1 FILT ENV      RATE      LEVEL
Attack1         50         100%
  
```

7. Move the cursor underneath the time field and change the value to about +50. Now when you press a key the filter slowly sweeps up.

L1 FILT ENV	RATE	LEVEL
Attack1	50	+88%

8. Change the attack rate and note the change in the sound.
9. Set the envelope parameters as shown in the following table.

Envelope Phase	Time	Level %
Attack 1	40	65
Attack 2	65	100
Decay 1	80	85
Decay 2	25	50
Release 1	97	20
Release 2	73	0

With the above setup, the filter sweeps up, then Decays back down to the Decay 2 Level until you release the key. Then it sweeps down at the Release rates. Play with the envelope parameters for awhile to get a feel for their function. (If you're having trouble understanding the Envelope Generators, please refer to the Programming Basics section in this manual.)

Changing Filter Types

Go back to the Filter Type screen shown below and move the cursor down the lower line of the display. Change the filter type while playing the keyboard. There are 50 different filter types.

L1 FILTER	Ord	Type
Aah-Ay-Eeh	6	VOW

These filters are extremely powerful and have been carefully crafted to offer maximum flexibility and musical control. You may want to change the Envelope (PatchCord) Amount, Q and/or the Filter Frequency to get the right sound for each filter and instrument. These three controls, coupled with the Filter Envelope, are perhaps the most important controls on any synthesizer. Take the time to learn how they interact with each other and you will be able to create sounds beyond imagination.

Envelope Repeat

The Envelope Generator can also be made to repeat. When the envelope repeat function is On, the Attack (1&2) and Decay (1&2) stages will continue to repeat as long as the key is held.

► To Make the Filter Envelope Repeat:

1. Go to the Filter Envelope **Mode** screen shown below.
2. Move the cursor to the Mode field.



3. Turn the data entry control clockwise. The Mode field will change to Repeat as shown below.



4. Move the cursor to the on/off field and turn Envelope Repeat On.
5. Play a key on the keyboard. You should now hear the envelope repeating.
6. Go back to the envelope parameter page and adjust the Attack 1&2, and Decay 1&2 parameters. The repeating envelope cycles through these four stages as long as the key is held.

Practice Modulating

- Try modulating the pitch with the Filter Envelope generator
- Use Velocity to modulate the Filter Envelope PatchCord or the Filter Frequency. This brightens the sound as you play harder.
- Program the LFO to modulate Filter Frequency and Volume (Patch-Cord screen).
- Modulate the LFO with the other LFO, with Velocity, and with the Modulation Wheel.
- Examine the Factory presets to learn how they're constructed. There are lots of cool synthesis tricks you can use in your own presets.
- Think of ten of your own modulation routings, then try them out. The key to learning Proteus 1000 is to experiment.

Troubleshooting

A common source of confusion when working with the filter envelope is that the Attack or Release parameters might not seem to be working correctly. If you are not getting the expected result, try to analyze the situation. There will be many times when you will have to stop for a minute and think, "What am I trying to do and why isn't it working?" When this happens (and it will), don't panic. Troubleshooting is a normal part of the synthesis process. Simply examine the various parameters and try to be as analytical as possible as you solve the problem. The solution is usually simple (the filter is already wide open and can't open any more). Learning to play any instrument takes a little patience and practice.

Referring to the diagram below which shows the Proteus 1000 signal flow, notice that the DCA comes after the Filter. The DCA controls the final volume of the sound, so if the filter's release is longer than the release for the DCA, you won't hear it, because the DCA has already shut off the sound.

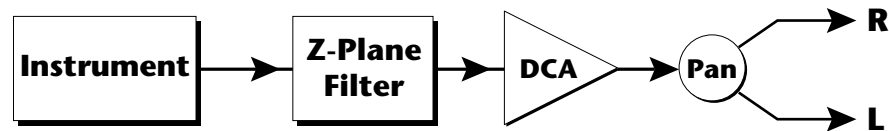

You're getting the general idea by now. Remember not to select a new preset before saving the current one or all your changes will be lost (the preset reverts to the last saved version). If you want to save your creation, select the Save/Copy menu and select a destination preset location for your masterpiece, then press Enter.

Because you can save your work, it's worth spending time to get the sound just right. When designing sounds you become an instrument builder as well as a musician. With Proteus 1000 you can design the custom radical instruments you've always wanted!

Linking Presets

 See "Preset Links" on page 127 for more information.

Using the Link pages in the Edit menu is a quick and easy way to create new sounds. Use the Links to "layer" presets and to "split" a keyboard into sections containing different sounds.

► To Layer Two Presets

1. Select the first preset you want to layer.
2. Press the Edit button. Use the Data Entry Control to move through the screens until you find either the "LINK 1" or "LINK 2" screen shown below.

LINK 1	PRESET	CMP5R
off		

3. Move the cursor to the second line of the display. Select the preset you want to link with the preset you selected in step 1. Play the keyboard as you scroll through the various presets to hear the results.
4. If you want the link to be a permanent part of the preset, be sure to save the preset. Otherwise, simply change the preset to erase your work.

► To Create a Split Keyboard Using Links

1. Follow steps 1 through 4 above.
2. Press Enter and use the Data Entry Control to advance to the next page.

LINK 1	KEY	VEL
RANGE	C-2 B4	000 127

3. Set the keyboard range of the linked preset as desired.
4. Press Enter and use the Data Entry Control to go to the Key Range page (It's one of the first Edit menu pages).

L1	KEY:LO	FADE	HIGH	FADE
	C5	000	G8	000

5. Set the range of the original preset so it fills the remaining keyboard area. Save the preset.



Effects

Effects Overview

Proteus 1000 has two stereo effects processors. When playing presets one at a time, the two processors can be programmed as part of the preset. When the MIDI Mode is set to “multi,” Proteus 1000 uses a global effects assignment (Master Effects). The diagram below shows how the effects are integrated into the signal path using a parallel effects send/return model, similar to a mixing console.

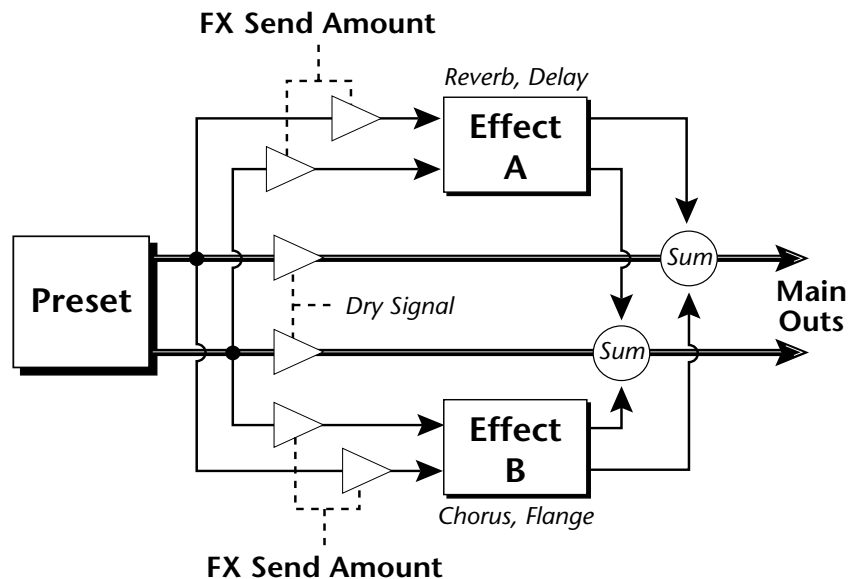

The Effects Sends

On a mixing console you can control the amount of signal each channel sends to the effect bus. This allows each channel to be placed in a slightly different “sonic space” which creates an airy, open sound.

Proteus 1000 uses this basic concept, but works in a slightly different manner. There are four effects busses: Send1-Send4. Each preset or each MIDI channel (you determine which), can be directed to one of the four busses. Each effect processor has four Send Amounts which allow you to set the wet/dry mix on each of the four busses going into the effect. A setting of 0% is completely dry (no effect). A setting of 50% contains an equal mix of affected and normal (dry) signal.

The Effects Send is programmed for each layer in the Edit menu. These routings can be overruled in the Master menu *Mix Output* screen by changing the submix setting from “preset”, which uses the preset routing, to Send1-Send4. In the diagram below, MIDI channel 1 is programmed to obey the preset routing which in this case is Send 1.

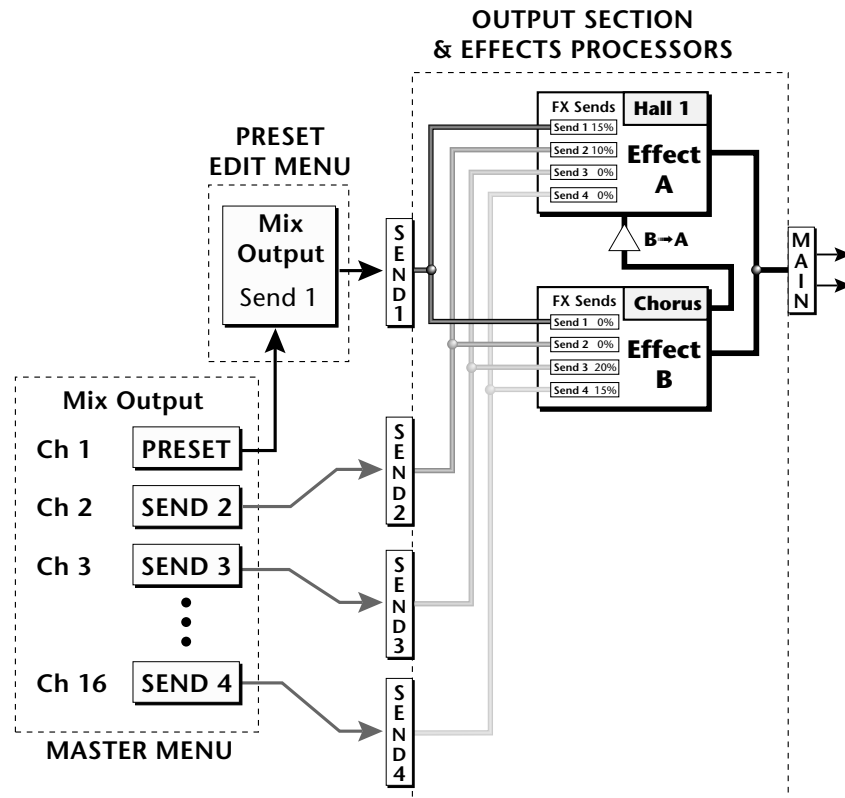

Individual layers or entire MIDI channels can be routed to any of the four busses.

The four Effect Sends allow you to get the most out of the two effect processors. For example, with Effect B set to an echo algorithm, you could route one MIDI channel to Send 3 and set the effect amount to 80%. Another MIDI channel could be routed to Send 4 with an effect amount of only 5%. This is almost like having two different effects!

The Mix Output function is also useful when sequencing since it lets you route specific MIDI channels (and thus sequencer tracks) to specific Sub outputs (on the back panel) where they can be processed with EQ or other outboard effects.

Effect Types

A Effect Types

Room 1-3
Hall 1 & 2
Plate
Delay
Panning Delay
Multitap 1
Multitap Pan
3 Tap
3 Tap Pan
Soft Room
Warm Room
Perfect Room
Tiled Room
Hard Plate
Warm Hall
Spacious Hall
Bright Hall
Bright Hall Pan
Bright Plate
BBall Court
Gymnasium
Cavern
Concert 9
Concert 10 Pan
Reverse Gate
Gate 2
Gate Pan
Concert 11

Medium Concert
Large Concert
Large Concert Pan
Canyon
DelayVerb 1-3
DelayVerb 4-5 Pan
DelayVerb 6-9

B Effect Types

Chorus 1-5
Doubling
Slapback
Flange 1-7
Big Chorus
Symphonic
Ensemble
Delay
Delay Stereo
Delay Stereo 2
Panning Delay
Delay Chorus
Pan Delay Chorus 1 & 2
Dual Tap 1/3
Dual Tap 1/4
Vibrato
Distortion 1 & 2
Distorted Flange
Distorted Chorus
Distorted Double

Effect Parameters

“A” Effect types contain Reverb and Delay effects. “B” Effect types contain Chorus, Flange and Distortion effects. There are 44 “A” effects and 32 “B” effects. In addition to the effect type, there are user adjustable parameters for each effect. The “A” effects have programmable Decay and High Frequency Damping. The “B” effects have user programmable Feedback, LFO Rate, and Delay Time.

Decay

The Decay parameter is used when setting “A” type effects. Decay sets the length of time it takes an effect to fade out. When setting up reverb effects, Decay controls the room size and the reflectivity of the room. For larger room sizes and greater reflectivity, set the Decay value higher. When setting up delay effects, the Decay parameter controls how many echoes are produced or how long the echoes last. The greater the value, the more echoes and longer lengths of time.

The Decay value range is from 0 through 90.

High Frequency Damping

The HF Damping parameter is used when setting “A” type effects. High Frequency energy tends to fade away first as a sound is dissipated in a room. the HF Damping parameter adjusts the amount of damping applied to the signal’s high frequency elements which, in turn, changes the characteristics of the room. Rooms with smooth, hard surfaces are more reflective and have less high frequency damping. Rooms filled with sound absorbing materials, such as curtains or people, have more high frequency damping.

The value range for High Frequency Damping is from 0 through 127.

Feedback

The Feedback parameter is used when setting “B” type effects. The Chorus and Flange effects have a controllable feedback loop after the delay element. Feeding back a small amount of the signal intensifies the effect by creating multiple cancellations or images. Higher feedback values increase the amount of the Feedback loop.

The Feedback value range is from 0 to 127.

LFO Rate

The LFO Rate parameter is used when setting “B” type effects. Both Chorus and Flange effects use a Low Frequency Oscillator (LFO) to animate the effect. LFO applied to a chorus effect creates the slight changes necessary for a realistic choral effect. Applied to a flanger effect, the LFO moves the comb filter notches and adds animation to the sound.

The LFO Rate value range is from 0 to 127.

Delay

Flanging, chorus and echoes are all based on a delay line where the signal is delayed by some time period and then mixed back with the unaltered signal. This parameter specifies the how much time passes before you hear the delayed signal. On some effects, this value cannot be changed. In this case, the field contains a dash.

The Delay value range is from 0ms to 635ms.

Effects Programmed in the Preset

Effects are normally programmed as part of the preset allowing you to have a different effect for each. This section describes how to program and modify Proteus 1000's preset effects.

► To Program the Effects as Part of the Preset:

1. Press the Edit button. The LED illuminates and the Edit screen appears.
2. Use the Data Entry Control to select the FXA Algorithm screen.



FXA ALGORITHM
Lg Concert Pan

3. Select an Effect. Do not select the "Master Effect" setting or the global effects set up in the Master menu will be used instead of the Preset Effect settings.
4. Use the Data Entry Control to select the FXA parameter screen.



FXA	DECAY	HFDAMP	FxB>FxA
	90	127	127

The FxB -> FxA parameter lets you route the B effect through the A effect. See "Effect B Into Effect A" on page 150.

5. Set the other effect parameters to your preference. Refer to the information in the last section for detailed descriptions of these parameters.
6. Use the Data Entry Control to select the FXB Algorithm screen.



FXB ALGORITHM
Distorted Flange

7. Select an Effect. Do not select the "Master Effect" setting or the global effects set up in the Master menu will be used instead of the Preset Effect settings.
8. Use the Data Entry Control to select the FXB parameter screen.

Master Effects

FXB	FEEDBK	LFORATE	DELAY
	127	127	635ms

9. Set the other effect parameters to your preference. Refer to the information in the last section for detailed descriptions of these parameters.
10. Save the preset. The programmed effects setting will be saved along with the preset.

You might want the effects to be programmed on a global basis when in Omni or Poly modes. You could choose your favorite reverb, for example, and have it applied to any preset you select.

When playing single presets, the effects are normally programmed as part of the preset. In Multimode, the Master effects are used, since there are only two effect processors to serve 16 MIDI channels.

► To Program the Master Effects

1. Press the Master menu button. The LED illuminates and the Master screen appears.
2. Use the Data Entry Control to select the FXA Algorithm screen.

FXA ALGORITHM
Lg Concert Pan

3. Select an Effect.
4. Use the Data Entry Control to select the FXA parameter screen.

FXA	DECAY	HFDAMP	FxB>FxA
	90	127	127

The FxB -> FxA parameter lets you route the B effect through the A effect. See "Effect B Into Effect A" on page 150.

5. Set the other effect parameters to your preference. Refer to the information in the last section for detailed descriptions of these parameters.
6. Use the Data Entry Control to select the FXB Algorithm screen.



7. Select an Effect.
8. Use the Data Entry Control to select the FXB parameter screen.

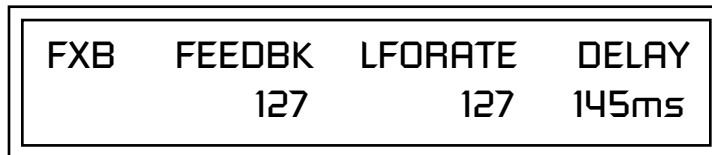

9. Set the other effect parameters to your preference. Refer to the information in the last section for detailed descriptions of these parameters.
10. Press the Edit menu button. The LED illuminates and the Edit menu displays the last screen used.
11. Use the Data Entry Control to access the FXA Algorithm page and select "Master Effect A."



The MIDI mode (Master Menu) must be set to Omni or Poly mode in order to select the effects in the preset.

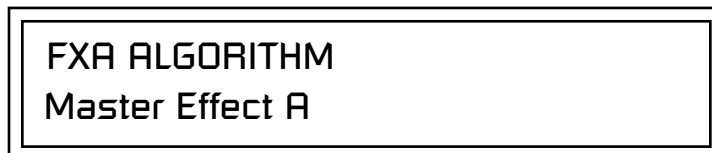

12. Repeat step 11 for the FXB Algorithm
13. Save the preset. The Master effects routing will be saved along with the preset.

Effects Mode

This control provides a true bypass of the effects engine. Bypass is a useful feature if you are using external effects at the mixing console and want to turn the effects off for all presets.

► To Bypass the Effects:

1. Press the Master menu button. The LED lights and the last Master parameter screen used is displayed.
2. Use the Data Entry Control to select the Effects Mode screen.

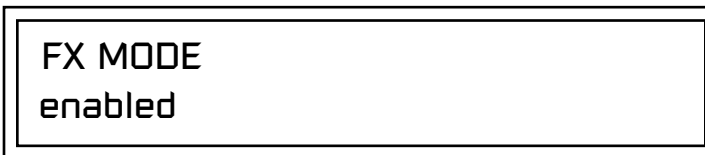

3. Use the cursor button to advance the cursor to the bottom line in the screen.
4. Use the Data Entry Control to change the value.
5. Press the Enter key to save the settings.

The Effects Mode values are “enabled” and “bypassed.” Enabling the Effects Mode turns on effects. Selecting “bypassed” turns off the effects.

Flexible Effects Control

The effects processor controls are very flexible. The effects can be controlled in three different ways to suit your personal preference and to adapt to different situations.

When in Omni or Poly mode, effects are normally programmed as part of the preset. In Multi mode, the two effects processors can be controlled using the Master settings or by using the effects settings of a preset on a specific MIDI channel. Effects can be programmed in the following ways:



You can create special “Effects Presets” which are assigned to the FX Multi mode Control channel, then use standard MIDI Program Change commands to switch effects during sequence playback.

1. **Programmed as part of the preset when playing single presets (Omni or Poly Modes).**
2. **Programmed from the Master Effects Section when playing either single presets (preset Effect Type set to “Master”) or when in Multi Mode.**
3. **Programmed from the designated control preset when in Multi Mode.**

Refer to the following diagram for a look at how effects are programmed.

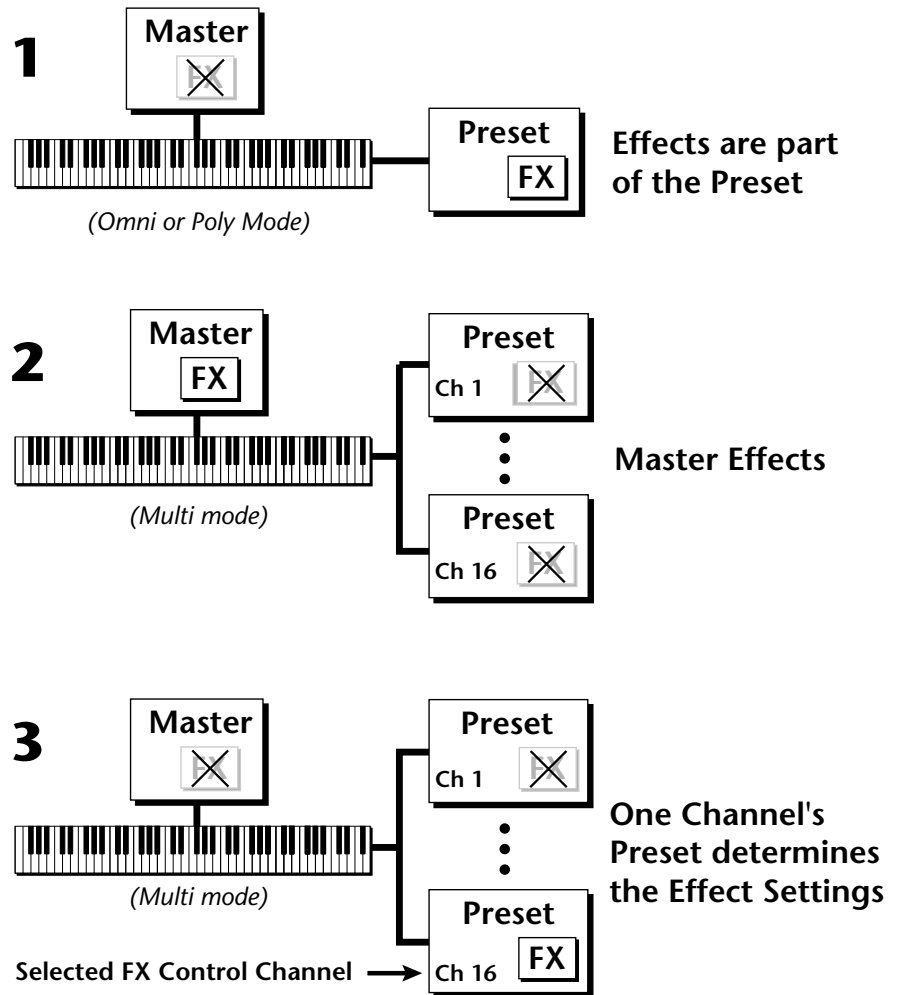

► **To Program the Effects Globally for all Presets in Multi Mode:**

1. Press the Master menu button. The LED illuminates and the Master menu screen appears.
2. Use the Data Entry Control to select the MIDI mode page. Choose “multi” for the mode.

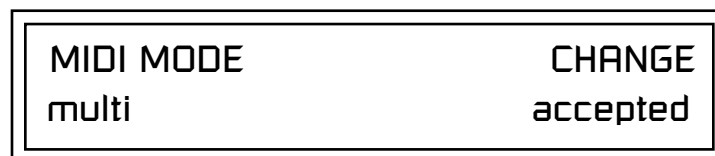

3. Move the cursor to the Multi mode Effects Control page using the Data Entry Control.



4. Set the Effect Control channel to *use master settings* using the Data Entry Control.
5. Press the Enter key to save the settings and return to the main screen.

Using the Effects Channel Settings in Multi Mode

In Multi mode, the two effects processors can be controlled from the Master Effects settings or they can follow the effects settings of the preset on a special MIDI channel. The effect settings on this special channel will be applied to all the other MIDI channels. This allows the effects to be changed during a sequence simply by changing the preset on a specified MIDI channel.

► To Program the Effects by Channel Number in Multi Mode

1. Press the Master menu button. The LED illuminates and the Master menu screen appears.
2. Use the Data Entry Control to select the MIDI mode page. Choose “multi” for the mode.
3. Move the cursor to the Multi mode Effects Control field using the Data Entry Control
4. Set the Effect Control to “preset on Channel #” (where # is replaced by the actual channel number from 1 through 16) using the Data Entry Control.
5. Press Enter to save the settings and return to the main screen.

Effect B Into Effect A

The output of effects processor B can be routed into effects processor A. This connects the effects in series instead of their normal parallel configuration. Two effects connected in series sound very different than the same two effects in parallel. For example, a chorus patched through reverb can turn a bland string section into a lush wall of sound. The B →A amount can also be controlled for even more flexibility.

► To Send the Output of Effect B through Effect A:

In this example, 100% of Effect B will be sent into Effect A.

1. Access the FXA parameter screen (in either the Master or Edit menus) that contains the FXB →FXA parameter.

FXA	DECAY	HFDAMP	FxB>FxA
	127	127	127

- Set this amount to 127. Press the cursor button to return the cursor to the top line in the display.
- Use the Data Entry Control to select the FXA submix routing parameter screen.

FXA SEND AMOUNTS	1: 10%
2: 20%	3: 30%
	4: 40%

- Press the cursor buttons to advance the cursor to the Main field.
- Set the Main send amount to any amount other than zero.
- Press the cursor button again to return the cursor to the FXA title. Use the Data Entry Control to advance to the FXB Algorithm page.
- Select an effect.
- Advance to the FXB submix routing page and set the Main FXB send percentage to zero.
- Play the keyboard and you should hear the B Effect running through Effect A. This patch is shown below.

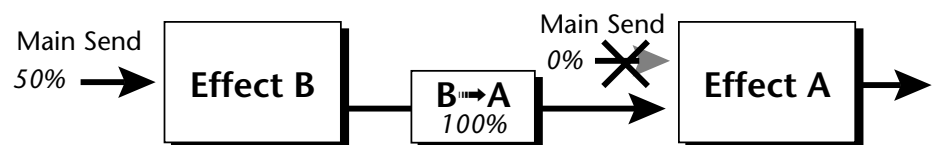

General Effect Descriptions

Reverb

Reverberation is a simulation of a natural space such as a room or hall. The reverb algorithms in Proteus 1000 simulate various halls, rooms and reverberation plates. In addition, there are several other reverb effects such as Gated Reverbs, Multi Tap (early reflections), Delay and Panning effects. There are two adjustable parameters on the reverb effects - Decay Time and High Frequency Damping.

Decay time defines the time it takes for the reflected sound from the room to decay or die away. The diagram below shows a generalized reverberation envelope.

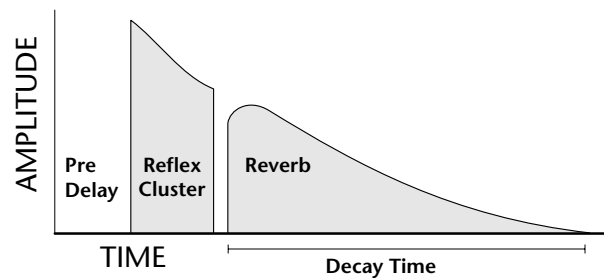

After an initial pre-delay period, the echoes from the closest walls or ceiling are heard. These first echoes, or the early reflection cluster, vary greatly depending on the type of room. Roughly 20 milliseconds after the early reflection cluster, the actual reverberation begins and decays according to the time set by the Decay Time parameter.

High frequency energy tends to fade away first as a sound is dissipated in a room. The High Frequency Damping parameter allows you adjust the amount of high frequency damping and thus change the characteristics of the room. Rooms with smooth, hard surfaces are more reflective and have less high frequency damping. Rooms filled with sound absorbing materials such as curtains or people have more high frequency damping.

General Descriptions of the Reverb Types

Room: Programs simulate small rooms with high frequency absorption caused by drapes and furniture.

Plates: Simulates plate type reverbs with their tight, dense, early reflections and sharp reverb buildup.

Hall: Presets recreate the open, spacious ambience of large concert halls.

Gated Reverbs: Add ambience only while the original signal is still sounding. As soon as the signal falls below a threshold, reverb is cut off.

Delay: Programs can be used to create echo and doubling effects.

Multi Tap: Programs consist of the reflection cluster only without the reverb decay.

Chorus

The function of a chorus device is to thicken the sound or to make one voice sound like many. This effect is usually created by mixing one or more delayed versions of the signal with the original. The delay times used are too short to be perceived as an echo, but long enough so that comb filtering does not occur. In addition, the delay time is varied via a low frequency oscillator to simulate the random differences which occur when multiple instruments are playing together. A slight amount of feedback improves the effect by creating multiple images of the sound as it recirculates again and again.

All the choruses are true stereo using two separate delay lines controlled by a single set of controls. The delay times are slightly different for each channel and the LFO phase is inverted on one channel to help contribute to the overall chorus effect. The LFO Rate and Depth settings are critical to achieving a realistic effect, with faster LFO rates generally requiring less LFO amount and vice-versa.

Doubling

When a copy of a sound delayed by about 26 milliseconds is added back to the original, two audio images are perceived by your brain. When the delayed image is slightly varied or modulated, the illusion of two voices is created.

Slapback

Slapback is a single short echo in the range of 50-60 milliseconds. A sound delayed by this length of time is perceived as a discrete and separate image which is useful for a thickening effect or as a pre-delay for reverb simulating a hard, reflective surface such a gymnasium wall.

Stereo Flanger

A flanger consists of a short audio delay line whose output is mixed together with the original signal. Mixing the delayed and original signals results in multiple frequency cancellations called a comb filter. Since the flanger is a type of filter, it works best with harmonically rich sounds.

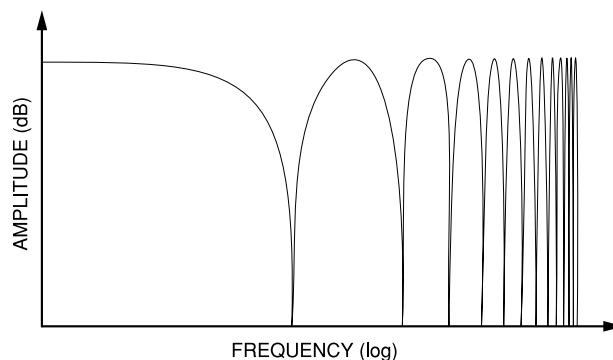

This is the frequency response of a Comb Filter.

Flanging was originally created using two tape recorders playing identical recordings. By exactly synchronizing the two decks and then slowing the speed of one by grasping the tape reel flanges, the flanging effect was born.

The Proteus 1000 flanger is a stereo device consisting of two separate delay lines controlled by a single set of controls. A Low Frequency Oscillator (LFO) varies this initial delay setting, changing the frequency of the notches and adding animation to the sound. LFO Rate controls the rate of change and LFO Depth controls how much the LFO changes the delay.

The Feedback control sends some of the delayed signal through the delay line again. When feedback is used the comb filter notches are deepened.

Delay

Delay is an effect which can be used for doubling, reverb pre-delay, or echoes.

Delay Time is variable from 0-635 mS and controls the time between echoes. Feedback and determines how long the echoes continue sounding. "Infinite" delay effects are also possible without the risk of runaway.

Stereo Delay

Similar to delay except that the delay line outputs a stereo signal from the mono input. The two output signals are a few milliseconds apart to create a stereo image. The delay times are variable from 0-635 mS.

Panning Delay

A panning delay is similar to the normal delay lines except that the echoes bounce back and forth between the two stereo speakers.

Dual Tap

These are delay lines where the signal is "tapped off" at two unevenly spaced locations. When feedback is used, multiple complex echoes are produced. The fraction in some of the algorithm names (i.e. 1/3, 1/4) refers to the time ratio between the taps.

Vibrato

Basically, this a delay line modulated by an LFO, but with none of the original signal added in. The LFO modulation creates a Doppler shift and a resultant cyclical pitch shift. The vibrato created in this manner sounds very different than vibrato created by frequency modulating the sample.

Distortion

Distortion uses a technique called "soft-clipping" to create additional harmonics in the signal. As the level increases, the top of the waveform becomes somewhat squared. As the level increases further, it transforms into a true square wave.



Soft clipping gradually squares the edges of the waveform as the amplitude is increased.

Save/Copy Menu

Saving a Preset

 Each time you change a preset parameter, the Save/Copy button LED illuminates reminding you to save your work.

The Save/Copy menu is used to save changes to a preset and to copy data between presets. When in “Quick Edit” mode, this menu always defaults to the “Save to Preset” page of this menu with the cursor on the second line. You can use the Data Entry Control to navigate to other pages that support copying information.

Any time you make a change to a preset, either using the Edit menu or by changing the Controller Knobs in Quick Edit mode, you must save the preset in order for the change to become permanent. When you save a preset it erases any existing preset information in that location. Make sure that the destination location does not contain preset information you want to keep.



SAVE PRESET to User
0201 Destination Preset

► To Save a Preset

1. Press the Save/Copy menu button.
2. Scroll to the Save Preset screen using the data entry control.
3. Move the cursor to the bottom line on the display.
4. Select the new preset location using the Data Entry Control.
5. Press the Enter/Home button.

Copying Information

Copy Preset

The Copy operations let you copy information from any preset or layer to any other preset or layer. To use the copy command, first select the preset or layer to which you want to copy (the destination location). Then, from the copy screen, select the preset or layer you want to copy to the currently selected location (the source location). Using the copy commands you can copy preset, layer, PatchCord and arpeggiator information.

The Copy Preset command lets you copy all of the preset information from one location into the preset of the current location. The preset information in the source location (the preset location from which you want to copy) is not deleted from the original location, just copied to the destination location.



 All the Sound Navigator features work when using the Copy functions.

► To Copy a Preset

1. Select the Preset you want to copy information *into*.
2. Press the Save/Copy menu button.
3. Scroll to the Copy Preset screen using the data entry control.
4. Select "Copy Preset from" using the Data Entry Control.
5. Select the preset you want to copy using the Data Entry Control. The ROM Bank, Preset Number, Bank Number, Category and Preset Name fields are all selectable.
6. Press the Enter/Home button.
7. A warning screen appears asking you to confirm once more. Press the Enter/Home button to copy the selected preset into the current location.

Copy Layer

The Copy Layer command lets you copy any layer information from one preset into any layer of the current preset location. The layer information in the source location (the layer location from which you want to copy) is not deleted from the original location, just copied to the destination location.

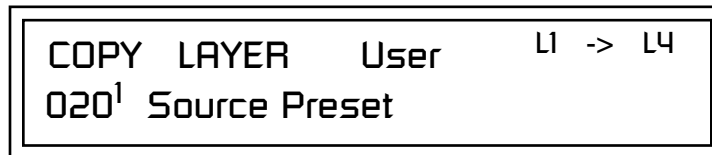

► To Copy a Layer

1. Select the Preset and Layer you want to copy information into.
2. Press the Save/Copy menu button.
3. Scroll to the Copy Layer screen using the data entry control.
4. Move the cursor to the bottom line on the display.
5. Select the preset location using the Data Entry Control, of the preset containing the information you want to copy into the current preset.
6. Move the cursor to the top line in the display.
7. Select the layer of the source preset in the first field on the right.
8. Select the destination layer in the second field.
9. Press the Enter/Home button.

Copy PatchCords

The Copy PatchCord command lets you copy the patchcord settings from one layer of the preset location into the current layer of the current preset location. The preset information in the source location (the preset location from which you want to copy) is not deleted from the original location, just copied to the destination location.

```
COPY CORDS      User      L1 -> L4
0201 Source Preset
```

► To Copy a PatchCord

1. Select the Preset and Layer you want to copy information into.
2. Press the Save/Copy menu button.
3. Scroll to the Copy Cords screen using the data entry control.
4. Move the cursor to the bottom line on the display.
5. Select the preset location using the Data Entry Control, of the preset containing the information you want to copy into the current preset.
6. Move the cursor to the top line in the display.
7. Select the layer of the source preset in the first field on the right.
8. Select the destination layer in the second field.
9. Press the Enter/Home button.

Copy Preset PatchCords

The Copy Preset PatchCord command lets you copy the preset patchcord settings from one preset location into the current preset location. The preset information in the source location (the preset location from which you want to copy) is not deleted from the original location, just copied to the destination location.

```
COPY PRESET CORDS      User
0201 Source Preset
```

► To Copy a Preset PatchCord

1. Select the Preset you want to copy information into.
2. Press the Save/Copy menu button.
3. Scroll to the Copy Preset Cords screen using the data entry control.
4. Move the cursor to the bottom line on the display.
5. Select the preset containing the information you want to copy.
6. Press the Enter/Home button.

Copy Preset Bank

The Copy Preset Bank command lets you copy an entire bank from any ROM or RAM bank location to any RAM (user) bank. This function can be especially useful after installing a new sound SIMM.

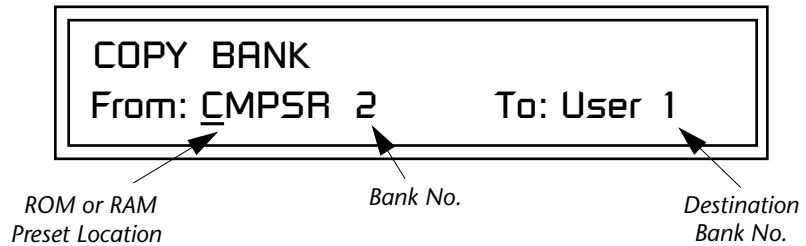

► To Copy a Preset Bank

1. Press the Save/Copy menu button.
2. Scroll to the Copy Preset bank screen using the data entry control.
3. Move the cursor to the "From" field on the bottom line on the display.
4. Use the Data Entry Control to select the preset bank you want to copy *from*.
5. Move the cursor to the "To" field on the bottom line on the display.
6. Use the Data Entry Control to select the User preset bank you want to copy *into*.
7. Press the Enter/Home button to overwrite the bank.

Create Random Preset

This is a great feature which creates a new preset using portions of the ROM presets as source material. By merging random presets, really great sounding presets can be generated with ease. Use this feature to generate wild new sounds, get new programming ideas or just for fun.



► To Create a Random Preset

1. Press the Save/Copy menu button.
2. Move the cursor to the bottom line on the display and press Enter.
3. A new random preset will be created.
4. Don't like the sound? Press Enter again and a new random sound will be generated.



Examine interesting presets to learn how they work using the Edit menu.

Sound Authoring

Copy User Bank to Flash



If there is no Flash SIMM in the unit, the error message, "Requires Flash SIMM" will be displayed.

This is a special purpose function to be used with the Flash sound authoring feature. Flash Sound SIMMs created on an EOS Ultra sampler can be used as a custom Proteus 1000 bank. Presets are then created in a User bank. When the bank of presets is finished, it can be copied, using this function, to the Flash SIMM. Flash SIMMs contain two separate memory locations. One of these memories contains the sound samples and the other memory can hold four banks of 128 presets.

WARNING: dangerous voltages are exposed inside Proteus 1000! Make sure power is completely disconnected from Proteus 1000 before removing the top panel. Replace the top panel before restoring power to the unit. The two sound SIMM sockets in Proteus 1000, marked 0 and 1, are located behind the controller knobs on the circuit board. **The destination Flash SIMM must be placed in SIMM socket 1.**

COPY USER BANK TO FLASH
From: User⁰ To: Flash²

► To Copy a User Bank to Flash

1. Make sure a Flash SIMM is inserted into the extra Proteus 1000 SIMM socket.
2. Press the Save/Copy menu button.
3. Rotate the Data Entry Control to select the "Copy User Bank" function shown above.
4. Move the cursor to the "From" field and select the User bank that you want to copy to the Flash SIMM.
5. Move the cursor to the "To" field and select the Flash bank that you want to contain the User bank.
6. Press Enter. The Enter LED will flash and the screen below appears.

**Press ENTER to Overwrite
Flash SIMM Presets**

7. Press Enter again to confirm. The following screen appears:

**COPYING USER BANK TO FLASH
Done. Please Reboot Now.**

8. The Flash presets cannot be used until Proteus 1000 is rebooted (power off then on). Reboot the Proteus 1000 and verify that the new Flash bank has been properly copied.

Rename Flash SIMM

 The Flash ID is the MSB of the MIDI Bank Select command used to select the Sound Bank.

 If there is no Flash SIMM in the unit, the error message, "Requires Flash SIMM" will be displayed.

This utility allows you to rename the Flash SIMM and change its ID number. Flash SIMMs can have any five letter name you choose. Each Flash SIMM in a Proteus 1000 unit must have a unique ID number (106-119).

The field in the upper right corner selects between multiple Flash SIMMs. If only one Flash SIMM is installed, the field cannot be modified.

RENAME FLASH SIMM	Flash
New Name: Drums	ID: 110

1. Make sure a Flash SIMM is inserted in a Proteus 1000 SIMM socket.
2. Press the Save/Copy menu button.
3. Rotate the Data Entry Control to select the "Rename Flash SIMM" function shown above.
4. Move the cursor to the "New Name" field and rename the SIMM using the Data Entry Control to select the letter and the cursor keys to select the position.
5. Set the Sound ID number for the SIMM. It doesn't matter which number you choose as long as the same number isn't used in another SIMM.
6. Press Enter. The following screen appears and the Enter LED will be flashing.

Press ENTER to Update Flash SIMM data
--

7. Press Enter again to confirm or any other button to abort. The following screen appears:

CHANGING SIMM NAME & ID (takes about 2 minutes)
--

8. The Flash presets cannot be used until Proteus 1000 is rebooted (power off then on). Reboot the Proteus 1000 and verify that the new Flash bank has been properly renamed.

Duplicate Flash

This utility allows you to duplicate Flash SIMMs using Proteus 1000. Both Sound and Preset data is copied when a Flash SIMM is duplicated. A factory sound SIMM cannot be copied using this utility.

WARNING: dangerous voltages are exposed inside Proteus 1000! Make sure power is completely disconnected from Proteus 1000 before removing the top panel. **Replace the top panel before restoring power to the unit.**

The two sound SIMM sockets in Proteus 1000 are marked 0 and 1. These are located behind the controller knobs on the circuit board. The Flash SIMM you want to copy **MUST** be placed into SIMM Socket 0. The destination Flash SIMM must be placed in SIMM socket 1.

DUPLICATE SLOT 0 FLASH
Start

1. Make sure the two Flash SIMM are located in the required Proteus 1000 SIMM sockets.
2. Press the Save/Copy menu button.
3. Rotate the Data Entry Control to select the "Duplicate Flash SIMM" screen shown above.
4. Move the cursor to the bottom line and press Enter. The following screen appears and the Enter LED will be flashing.

Press ENTER to overwrite
the Flash SIMM in Slot 1

5. Press Enter again to confirm or any other button to abort. The following screen appears and the SIMM is copied.

DUPLICATING SLOT 0 -> SLOT 1
(Takes about 5 minutes)

6. When Proteus 1000 has finished duplicating the SIMM, turn power off, remove the copied SIMM, then reboot. That's it!



If there are no Flash SIMMs in the unit, or if the SIMMs are in the wrong slots, an error message will be displayed.

Appendix

Front Panel Knob Functions

 The Front Panel Knobs can be reprogrammed for each preset and stored in any of the User Presets. The functions shown here are the factory programmed settings.

This section provides some of the more technical information about Proteus 1000. In this appendix, you will find information about velocity curves, MIDI commands and PatchCord charts.

The front panel knob functions are standardized for most of the factory presets. The typical functions of the controller knobs are described below. Match the controller knobs on your MIDI controller to the Realtime Controller Assignments in the Master menu to control these functions.

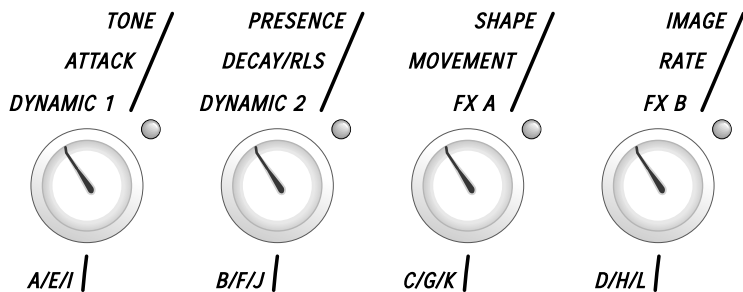

- Tone** Filter Frequency
- Presence** Filter Resonance
- Shape** Filter Envelope Amount
- Image** Typically brings in additional layers
- Attack** Volume or Filter Envelope Attack
- Decay/Release** Vol/Filt. Envelope Release and/or Decay
- Movement** LFO->Dynamic Movement (i.e.panning)
- Rate** LFO Rate
- Dynamic 1** Typically Velocity -> Amplifier Volume
- Dynamic 2** Typically Velocity -> Filter Frequency
- FX A** Effects Processor A Amount
- FX B** Effects Processor B Amount

Presets

Proteus 1000 Preset Categories

The Proteus 1000 presets are organized in categories according to the types of sound. Listed below are the categories and their three letter prefixes:

bpm: Tempo-based, LFO/Envs	kit: Drum Kit
brs: Brass Instruments	led: Leads
bs1: Acoustic Bass	nse: Noises
bs2: Electric Bass	orc: Orchestral sounds
bs3: Sub Bass	pad: Sustained, pad-like
bs4: Dance Bass	prc: Percussive
bs5: Miscellaneous	scr: Scratches
gtr: Guitar	sfx: Sound Effects
hit: Orchestra Hit / Short Blast	str: Strings (violins, cellos, etc.)
kb1: Piano	syn: Synthesizers
kb2: Electric Piano	vox: Vocals
kb3: Organs	wav: Simple Waveforms
kb4: Hybrid / Mixed Keyboards	wnd: Wind Instruments

Preset Listing

User Bank 0, CMPSR Bank 4

- | | | |
|----------------------|----------------------|-----------------------|
| 0. kb1:DynamicGrand | 43. kb1:Dance Pno | 86. kb3:Bally Yard |
| 1. kb4:Yo My Dynos | 44. kb1:Elecro7CP | 87. kb3:Clean X-Whl |
| 2. orc:Orchestral | 45. kb1:Grande | 88. kb3:Clicky B |
| 3. gtr:Grusty | 46. kb1:HonkTonkeyz | 89. kb3:Day |
| 4. bs1:A Ku Stq | 47. kb1:Klassical | 90. kb3:DirT baG |
| 5. kb3:Rock'in B | 48. kb1:Layer Piano | 91. kb3:DirtyHertz |
| 6. kb2:WideSuitcase | 49. kb1:Miami Grand | 92. kb3:Disco |
| 7. led:Zimppler | 50. kb1:Piano Mio | 93. kb3:Drawbar |
| 8. bs4:AnalogPlanet | 51. kb1:Piano&Strng1 | 94. kb3:Drawbars |
| 9. kit:Kit 1 | 52. kb1:Piano&Strng2 | 95. kb3:DX |
| 10. kb1:And Voice | 53. kb1:StereoGrand1 | 96. kb3:DX Organ |
| 11. sfx:MetalScience | 54. kb1:StereoGrand2 | 97. kb3:Full Organ |
| 12. syn:Silk OBXsaws | 55. kb1:StereoGrand3 | 98. kb3:Gospel Soul |
| 13. gtr:Stolen7Away | 56. kb1:StereoGrand4 | 99. kb3:GreenEyed |
| 14. brs:Movie Brass | 57. kb1:Sung Piano | 100. kb3:Gritty B Wav |
| 15. str:Dyna-heim | 58. kb1:Techno Piano | 101. kb3:Grundge XXX |
| 16. bpm:Jumping | 59. kb2:Ballad Tine | 102. kb3:JX Organ |
| 17. vox:New Age Oohs | 60. kb2:Classic EP 1 | 103. kb3:Kool N Mello |
| 18. bs4:Sugar Freak | 61. kb2:Classic EP 2 | 104. kb3:Mellow Man |
| 19. kb4:Clavinetti | 62. kb2:Classic EP 3 | 105. kb3:Nod |
| 20. kit:Acoustic 1 | 63. kb2:Classic EP 4 | 106. kb3:Oddd Organ |
| 21. brs:BreathyTBone | 64. kb2:DooGie | 107. kb3:Org Lite |
| 22. wnd:Real Flute | 65. kb2:Dynofunk EP | 108. kb3:Organomics X |
| 23. str:Allin a Pizz | 66. kb2:FM El Piano | 109. kb3:Perc Organ |
| 24. bs4:Walky Talk | 67. kb2:FM EP 1 | 110. kb3:Pipe Organ |
| 25. str:Filmscore | 68. kb2:FM EP 2 | 111. kb3:Simple Organ |
| 26. led:L.V.'s Worm | 69. kb2:FM2Classic | 112. kb3:Testify |
| 27. kit:Bag O Tricks | 70. kb2:Hard Dyno | 113. kb3:Tone Organ |
| 28. kb2:Melosoul EP | 71. kb2:Hard EP | 114. kb3:Upper B |
| 29. wnd:Breather | 72. kb2:Hard Tine | 115. kb3:Vox 1 |
| 30. vox:Frozen Time | 73. kb2:Med Dyno | 116. kb3:Vox 2 |
| 31. hit:MasterBlast | 74. kb2:Med EP | 117. kb3:WheelSpeed B |
| 32. gtr:NyloSteel | 75. kb2:Pretty EP | 118. kb4:Breathy |
| 33. kb3:JimmyJazzy B | 76. kb2:PrettyLushEP | 119. kb4:Clavinet 1 |
| 34. kit:Kit | 77. kb2:Rezzroadz | 120. kb4:Clavinet 2 |
| 35. bs2:Fing&Harms 2 | 78. kb2:Suitcase EP | 121. kb4:Clavinet 3 |
| 36. kb2:Lovers Fm EP | 79. kb2:Supatramp EP | 122. kb4:Clavin' It |
| 37. syn:JunoPlseComp | 80. kb2:Wurlitzer Hd | 123. kb4:Clavity |
| 38. gtr:WaaKeeGa | 81. kb2:WurlitzerSft | 124. kb4:Comp Keyz 1 |
| 39. led:inBottles | 82. kb2:WurlyD'Layer | 125. kb4:Comp Keyz 2 |
| 40. kb1:Ballad Grand | 83. kb3:B3 X-Wheel 1 | 126. kb4:Comp Keyz 3 |
| 41. kb1:Chime Grand | 84. kb3:B3OrganWave1 | 127. kb4:Crystal |
| 42. kb1:Concert Pno | 85. kb3:B3OrganWave2 | |

Preset Listing

User Bank 1, CMPSR Bank 5

- | | | |
|----------------------|----------------------|-----------------------|
| 0. kb4:Dance | 43. bs1:Upright 2 | 86. bs2:Sloppiest |
| 1. kb4:Dyno Piano | 44. bs1:Upright Days | 87. bs2:Spankin |
| 2. kb4:DynoWahClav | 45. bs1:WalkinUprite | 88. bs2:ThickFretles |
| 3. kb4:E Grand | 46. bs2:BADtube | 89. bs2:VeloFretless |
| 4. kb4:Elecre 1 | 47. bs2:Big Basic | 90. bs3:26 |
| 5. kb4:Elecre 2 | 48. bs2:EP 1 | 91. bs3:Analow |
| 6. kb4:Elecre 3 | 49. bs2:EP 2 | 92. bs3:ATC 1 |
| 7. kb4:Electrified | 50. bs2:EP 3 | 93. bs3:ATC 2 |
| 8. kb4:EP Fog | 51. bs2:EP Bass | 94. bs3:ATC 3 |
| 9. kb4:EP Roll 1 | 52. bs2:Fing&Harms 1 | 95. bs3:ATC 4 |
| 10. kb4:EP Roll 2 | 53. bs2:Finger Out | 96. bs3:Beauty |
| 11. kb4:EP Roll 3 | 54. bs2:Finger&Harmz | 97. bs3:Below Sub |
| 12. kb4:Farfisa 1 | 55. bs2:Finger1 | 98. bs3:Big Basic |
| 13. kb4:Farfisa 2 | 56. bs2:Finger2 | 99. bs3:DB Sub |
| 14. kb4:Farfisa 3 | 57. bs2:Fingered In | 100. bs3:Easy |
| 15. kb4:Grand FM | 58. bs2:Fretless 1 | 101. bs3:Face Bass |
| 16. kb4:Hard Comp 1 | 59. bs2:Fretless 2 | 102. bs3:Fat Sunbass |
| 17. kb4:Hard Comp 2 | 60. bs2:Fretless 3 | 103. bs3:Four U |
| 18. kb4:Hard Comp 3 | 61. bs2:Fretless 4 | 104. bs3:HipPocket |
| 19. kb4:Hard Comp 4 | 62. bs2:Fretless 5 | 105. bs3:Homeboy E |
| 20. kb4:Hard Comp 5 | 63. bs2:Fretless'd | 106. bs3:Ice |
| 21. kb4:Hard Tined | 64. bs2:FretterNot | 107. bs3:JP-Moog 4 |
| 22. kb4:Knockerz | 65. bs2:Full Finger | 108. bs3:Line |
| 23. kb4:M12Tines | 66. bs2:Gruzzly Pop | 109. bs3:Lowness |
| 24. kb4:Mystery Roll | 67. bs2:Harmonics | 110. bs3:MassiveMini |
| 25. kb4:Nu Tynez 1 | 68. bs2:MelloRounder | 111. bs3:MooG DropS |
| 26. kb4:Nu Tynez 2 | 69. bs2:Picked | 112. bs3:Moogy Mudd |
| 27. kb4:PerkyRhodes | 70. bs2:Picked Off | 113. bs3:Planet Bass |
| 28. kb4:Pharpheeza | 71. bs2:Pop | 114. bs3:Plex |
| 29. kb4:PnoWndStrg 1 | 72. bs2:Pop Slide 1 | 115. bs3:Poly Style |
| 30. kb4:PnoWndStrg 2 | 73. bs2:Pop Slide 2 | 116. bs3:Real Low |
| 31. kb4:Roll | 74. bs2:Pop Slide 3 | 117. bs3:RoundabouT |
| 32. kb4:RollinDreams | 75. bs2:Pop Slide 4 | 118. bs3:SE Micro |
| 33. kb4:Syn Ballad | 76. bs2:Signfeld Pop | 119. bs3:SE Sub 1 |
| 34. kb4:Synth Cheese | 77. bs2:Slap 1 | 120. bs3:SE Sub 2 |
| 35. kb4:Synth Organ | 78. bs2:Slap 2 | 121. bs3:Spanker |
| 36. kb4:Tine EP | 79. bs2:Slap 3 | 122. bs3:Spkr Damage |
| 37. kb4:Vox-A-Phaze | 80. bs2:Slap 4 | 123. bs3:Sub Core |
| 38. kb4:Whistle Keys | 81. bs2:Slap 5 | 124. bs3:Sub Drop |
| 39. bs1:Acoustic | 82. bs2:Slap Me! | 125. bs3:Sub Plunk |
| 40. bs1:DynoStandUp | 83. bs2:SlapBack | 126. bs3:Sub Poke |
| 41. bs1:Up ~ | 84. bs2:Slappity | 127. bs3:Sub Pummeled |
| 42. bs1:Upright 1 | 85. bs2:Slop Bass | |

Preset Listing

User Bank 2, CMPSR Bank 6

- | | | |
|----------------------|----------------------|-----------------------|
| 0. bs3:Sub-Basement | 43. bs4:Mini 3 | 86. bs4:Synth 9 |
| 1. bs3:Subtle Bass | 44. bs4:Mini 4 | 87. bs4:Synth |
| 2. bs3:Super Sub | 45. bs4:Mini More | 88. bs4:TB 1 |
| 3. bs3:The Tunnel | 46. bs4:Mod da Wheel | 89. bs4:TB 2 |
| 4. bs3:Thickley Dub | 47. bs4:Moog 1 | 90. bs4:TB 3 |
| 5. bs3:Thip Kong | 48. bs4:Moog 2 | 91. bs4:TB 4 |
| 6. bs3:Way Low Down | 49. bs4:Moog Tri | 92. bs4:Thunk |
| 7. bs3:Wide Chorus | 50. bs4:Mr. Clean | 93. bs4:Tight Mo MW |
| 8. bs3:ZuB CoMpLeX | 51. bs4:Not So Mini | 94. bs4:Tres o Tres |
| 9. bs4:3 O WorM | 52. bs4:Occitan Root | 95. bs4:Walky Talk2 |
| 10. bs4:Acid | 53. bs4:Octave | 96. bs5:All Purpose |
| 11. bs4:Acid 4 Ever | 54. bs4:Org Gruz | 97. bs5:Buzzed |
| 12. bs4:Analogic | 55. bs4:Osc-Kars | 98. bs5:DX 1 |
| 13. bs4:Asidic Bass | 56. bs4:PercoOrgana | 99. bs5:DX 2 |
| 14. bs4:Bass Hit | 57. bs4:Plexy | 100. bs5:DX 3 |
| 15. bs4:Bass ic | 58. bs4:Power Q | 101. bs5:Feeder |
| 16. bs4:Bernie Funk | 59. bs4:PuLs A'ting | 102. bs5:Funkalicious |
| 17. bs4:Big Sync | 60. bs4:Q Attack | 103. bs5:Home 1 |
| 18. bs4:Bondomatic | 61. bs4:Q Bass 1 | 104. bs5:Home 2 |
| 19. bs4:Brite Beauty | 62. bs4:Q Bass 2 | 105. bs5:Hybrid |
| 20. bs4:Brolin's 1st | 63. bs4:Q Bass 3 | 106. bs5:Knocker |
| 21. bs4:Buzza | 64. bs4:Q Bass 4 | 107. bs5:Mozambique |
| 22. bs4:Crystal Meth | 65. bs4:Q Snap | 108. bs5:Mozamdrip |
| 23. bs4:CZ1 | 66. bs4:Reverend JB | 109. bs5:Oh Yea |
| 24. bs4:DB | 67. bs4:Ripped3 | 110. bs5:Organ Bass 1 |
| 25. bs4:DB9 1 | 68. bs4:Saw Sync | 111. bs5:Organ Bass 2 |
| 26. bs4:DB9 2 | 69. bs4:Sawz | 112. bs5:Perco |
| 27. bs4:Deep Pocket | 70. bs4:SE 1 | 113. bs5:Phlappy |
| 28. bs4:Digi-Punch | 71. bs4:SE 2 | 114. bs5:Pocket |
| 29. bs4:Distorto-TB | 72. bs4:SE One | 115. bs5:Pure |
| 30. bs4:Examination | 73. bs4:Shift | 116. bs5:Say What |
| 31. bs4:FM | 74. bs4:Simple 3 | 117. bs5:Slider |
| 32. bs4:FM Sonic | 75. bs4:Sobered Up | 118. bs5:Smoothy |
| 33. bs4:FP Powerbass | 76. bs4:StraytUPjunO | 119. bs5:Soft & Hard |
| 34. bs4:HaLLoW ! | 77. bs4:Sync Echo | 120. bs5:Sonics |
| 35. bs4:In the Money | 78. bs4:Synth 1 | 121. bs5:Spitt |
| 36. bs4:JP4 Bass | 79. bs4:Synth 2 | 122. bs5:Spread |
| 37. bs4:Juno | 80. bs4:Synth 3 | 123. bs5:Standard |
| 38. bs4:Luke's Best | 81. bs4:Synth 4 | 124. bs5:Street |
| 39. bs4:Memory Moog | 82. bs4:Synth 5 | 125. bs5:Tapp |
| 40. bs4:Micro | 83. bs4:Synth 6 | 126. bs5:Thickener |
| 41. bs4:Mini 1 | 84. bs4:Synth 7 | 127. bs5:Ultimate 1 |
| 42. bs4:Mini 2 | 85. bs4:Synth 8 | |

Preset Listing

User Bank 3, CMPSR Bank 7

- | | | |
|----------------------|----------------------|-----------------------|
| 0. bs5:Ultimate 2 | 43. gtr:Power 2 | 86. str:Sham Wave |
| 1. bs5:Ultimate 3 | 44. gtr:Rezatronics | 87. str:SitarTalk |
| 2. bs5:VP1 1 | 45. gtr:Slippery Joe | 88. str:Sneajy |
| 3. bs5:VP1 2 | 46. gtr:SlipSly | 89. str:Solo Quartet |
| 4. bs5:WetMonica | 47. gtr:Spy | 90. str:So Long |
| 5. gtr:Carlos | 48. gtr:Steel | 91. str:SoloOutFront |
| 6. gtr:Cast Teller | 49. gtr:Steel Real | 92. str:Swoon |
| 7. gtr:Chuckin | 50. gtr:Strat Wow | 93. str:Texture |
| 8. gtr:Cry Babies | 51. gtr:The 12String | 94. str:The Lonely 1 |
| 9. gtr:Dark Gut | 52. gtr:ThickPick | 95. str:Tron |
| 10. gtr:Distorter-X | 53. gtr:TwangyNylon | 96. str:TronStrings |
| 11. gtr:Dolobroso | 54. gtr:Waaaa Waaaa | 97. str:Velo Marcato |
| 12. gtr:El Mute 1 | 55. gtr:Wah Minor | 98. str:Victrola |
| 13. gtr:El Mute 2 | 56. gtr:WahWah Spice | 99. brs:5th Wave |
| 14. gtr:Electric 1 | 57. str:Abbey'Strngs | 100. brs:Airy Trumpet |
| 15. gtr:Electric 2 | 58. str:Analog | 101. brs:B4PCM Brass |
| 16. gtr:ElectricDis | 59. str:Analogic | 102. brs:Barry Bones |
| 17. gtr:EmmTV Crunch | 60. str:ArcotremPizz | 103. brs:Bigga |
| 18. gtr:FlangnVioWah | 61. str:Big Strings | 104. brs:Bone |
| 19. gtr:FullNylon | 62. str:ChamberGrp | 105. brs:Brass&Bari |
| 20. gtr:FunkChunk | 63. str:DarkMoods | 106. brs:BrassControl |
| 21. gtr:Heavy Mon | 64. str:Digital 1 | 107. brs:Brassy |
| 22. gtr:JangleWah | 65. str:Digital 2 | 108. brs:Breathy Mute |
| 23. gtr:Jazz | 66. str:Drews Harp | 109. brs:ClassicBrass |
| 24. gtr:Jazzed | 67. str:ExtremeStrng | 110. brs:Da Brasses |
| 25. gtr:LA Strata | 68. str:Fortuna | 111. brs:Dizzy |
| 26. gtr:Looz 12s | 69. str:GlissiPizzi | 112. brs:Don'sTrumpet |
| 27. gtr:MellowElect | 70. str:Helium | 113. brs:Ensemble |
| 28. gtr:Metal Head | 71. str:Hindookurdoo | 114. brs:Han's E4s |
| 29. gtr:MutableJazz | 72. str:Japanman | 115. brs:Horny |
| 30. gtr:Mutant Pick | 73. str:Koto | 116. brs:Huge Brass |
| 31. gtr:Mute Gtr vsw | 74. str:Kult E Vatn' | 117. brs:Louis |
| 32. gtr:Mute-Ted | 75. str:Many Quarts | 118. brs:MellowD'Trmp |
| 33. gtr:Mutes | 76. str:Matrix Synth | 119. brs:Miles |
| 34. gtr:Nrysty | 77. str:MeltroniKnbd | 120. brs:Profit 5 |
| 35. gtr:Nrysty | 78. str:Morocco Feel | 121. brs:RadioHorns |
| 36. gtr:Nye Lonny | 79. str:Obie'anna | 122. brs:Reed & Brass |
| 37. gtr:Nylon | 80. str:Pizzicati | 123. brs:S'miles |
| 38. gtr:Nylon Silk | 81. str:Pizzicato | 124. brs:Schwyn 1 |
| 39. gtr:Nylon Vox | 82. str:Real Matrix | 125. brs:Section |
| 40. gtr:Nylonistic | 83. str:Rich Analogs | 126. brs:SforzadoEnsb |
| 41. gtr:Pantastic | 84. str:Section | 127. :default |
| 42. gtr:Power 1 | 85. str:Sectioned | |

Preset Listing

CMPSR Bank 0

- | | | |
|----------------------|----------------------|-----------------------|
| 0. brs:SforzatoSect | 43. wnd:Harmonica | 86. vox:Tarzanalien |
| 1. brs:Soft Trumpet | 44. wnd:Harmonika | 87. vox:ThroatRattle |
| 2. brs:Solo 'Bone | 45. wnd:Harmony | 88. vox:Tokenring |
| 3. brs:Synth Brass | 46. wnd:Monica Blow | 89. vox:Trapped |
| 4. brs:The Ensemble | 47. wnd:Nuages | 90. led:Apple Eater |
| 5. brs:Too Bahhd | 48. wnd:Oboe 1 | 91. led:Blue Danube |
| 6. brs:Trmpt+Sect | 49. wnd:Oboe 2 | 92. led:Cat's Nip |
| 7. brs:Tromboned | 50. wnd:Ocarina 1 | 93. led:Dancerama |
| 8. brs:Trombrass | 51. wnd:Ocarina 2 | 94. led:Dwiddle |
| 9. brs:Trump FX etc | 52. wnd:Pan Flute 1 | 95. led:Ethereosity |
| 10. brs:Trumpet FX 1 | 53. wnd:Pan Flute 2 | 96. led:Flutter |
| 11. brs:Trumpet FX 2 | 54. wnd:Pastoral | 97. led:Freakus |
| 12. brs:Trumpet FX 3 | 55. wnd:Polka Cheat | 98. led:Intervalis |
| 13. brs:Trumpet FX 4 | 56. wnd:S-Sax | 99. led:JabbaStabba |
| 14. brs:Trumpet FX 5 | 57. wnd:Sax FX 1 2 3 | 100. led:Laser Larry |
| 15. brs:Trumpet FX 6 | 58. wnd:Sax Session | 101. led:Nice Lead |
| 16. brs:Trumpet FX 7 | 59. wnd:Shenai | 102. led:Post 90's DM |
| 17. brs:Trumpet Hard | 60. wnd:Synth Flute | 103. led:Q Snapper |
| 18. brs:TrumpetMute1 | 61. wnd:T-Sax | 104. led:Quacker |
| 19. brs:TrumpetMute2 | 62. wnd:Tenor Phone | 105. led:RememberWhen |
| 20. wnd:A-SAX | 63. wnd:Virtuaccord | 106. led:Sci-Fi B |
| 21. wnd:AiryClarinet | 64. wnd:WindTrio | 107. led:Shimmy |
| 22. wnd:Akkordione | 65. vox:Ahhs | 108. led:Shiner |
| 23. wnd:Alto Saxo | 66. vox:Arco Breath | 109. led:SineSurprise |
| 24. wnd:B-Sax | 67. vox:Common Vox | 110. led:Smack Bender |
| 25. wnd:B2-Sax | 68. vox:Dark Angels | 111. led:Speedronic |
| 26. wnd:Bari | 69. vox:Gossamer | 112. led:Syrian Nod |
| 27. wnd:Big Top | 70. vox:Gothic Dream | 113. led:Wandering |
| 28. wnd:Bottle Blow | 71. vox:Lo FakeChoir | 114. led:Weezy Lead |
| 29. wnd:Breathy Flt1 | 72. vox:Lo-Fi Ether | 115. led:Worm 1 |
| 30. wnd:Breathy Flt2 | 73. vox:Majestic | 116. led:Worm 2 |
| 31. wnd:Chamber Orch | 74. vox:MauzeWowz | 117. led:Wormwood |
| 32. wnd:Chi-Town | 75. vox:Mist | 118. led:Wormy Janis |
| 33. wnd:Clar/Oboe | 76. vox:Odd Boys | 119. led:Zaw Za Zah |
| 34. wnd:Clarinet | 77. vox:Odd Vox | 120. wav:Arp |
| 35. wnd:Clarinette | 78. vox:Oohs Souls | 121. wav:Bass Synth |
| 36. wnd:English Horn | 79. vox:PhasePhlips | 122. wav:Bell Synth |
| 37. wnd:Fieldberries | 80. vox:Pop Aahs | 123. wav:Blipper |
| 38. wnd:Flt/Obe/Bone | 81. vox:Pop Oohs | 124. wav:Buzz Saw Syn |
| 39. wnd:Flute | 82. vox:Slo Lunarvox | 125. wav:Chime |
| 40. wnd:Full Bari | 83. vox:Soul Oohs | 126. wav:CZ Echo |
| 41. wnd:G's Soprano | 84. vox:SpiritWorld | 127. wav:CZ Lead |
| 42. wnd:Grouch | 85. vox:SynthSing | |

Preset Listing

CMPSR Bank 1

- | | | |
|----------------------|----------------------|-----------------------|
| 0. wav:CZ101 Digi | 43. wav:VS48 | 86. syn:Razor Edge |
| 1. wav:Dig Buzz Syn | 44. wav:Whine | 87. syn:Rez Synth |
| 2. wav:Eraser | 45. wav:Wild Synth | 88. syn:Rezy Wave |
| 3. wav:ES Rag | 46. syn:5th Brass | 89. syn:Saw Blip |
| 4. wav:Fat Attack | 47. syn:808 Synthax | 90. syn:Saw Stack |
| 5. wav:Glass Perc | 48. syn:Arpitty | 91. syn:Saw Sweep |
| 6. wav:Hollow Deep | 49. syn:BenderPlanet | 92. syn:SawsweepComp |
| 7. wav:Juno Pulse | 50. syn:Big Planet | 93. syn:Skreach Arp |
| 8. wav:Juno Square | 51. syn:Blippoid | 94. syn:Soft Synth |
| 9. wav:Log Hit | 52. syn:Brazz | 95. syn:Synbrasso |
| 10. wav:M12 Lead | 53. syn:Buzz Synth | 96. syn:Syncsyn Clav |
| 11. wav:M12 Sync | 54. syn:Conglomo | 97. syn:Syncty |
| 12. wav:Magic | 55. syn:CZ Synstring | 98. syn:SynEnsemble |
| 13. wav:Metal 1 | 56. syn:DigiBuzphaze | 99. syn:Syntax On2 |
| 14. wav:Metal 2 | 57. syn:Digiglass | 100. syn:Synthall AT |
| 15. wav:MetalAttack | 58. syn:DinkedSquare | 101. syn:Synth Brass |
| 16. wav:Mini Lead | 59. syn:Ensemblist | 102. syn:ThinHi Worm |
| 17. wav:Moog Lead | 60. syn:Ethnosplint | 103. syn:ThinTecPulse |
| 18. wav:Narrow Synth | 61. syn:Euro Wave | 104. syn:Transpander |
| 19. wav:Overtone Syn | 62. syn:Fat Slide | 105. syn:VoxNonsense |
| 20. wav:Perc Axe Syn | 63. syn:Festival | 106. syn:Wheezy Worm |
| 21. wav:Pluck Tone | 64. syn:Gritstrings | 107. syn:Wildsync |
| 22. wav:Pop Square | 65. syn:Heavy | 108. syn:Z&C Leeder |
| 23. wav:PPG | 66. syn:Hi Oct Synth | 109. pad:AirBorn |
| 24. wav:Pure H | 67. syn:Hi String | 110. pad:Classic |
| 25. wav:PWM | 68. syn:Hydraine | 111. pad:Cloud 9 |
| 26. wav:Rast Keys | 69. syn:Little Tins | 112. pad:Crystal Beam |
| 27. wav:Rezy | 70. syn:LOCoCution | 113. pad:Dance Chord |
| 28. wav:Spacey Keys | 71. syn:Messy | 114. pad:Dances Well |
| 29. wav:Square Lead | 72. syn:Mood Strings | 115. pad:Deep Spacy |
| 30. wav:SquareAttack | 73. syn:Moog | 116. pad:Dream Pad |
| 31. wav:SquareChorus | 74. syn:NarrowEscape | 117. pad:Dreamer |
| 32. wav:Syn Tone | 75. syn:Nervous | 118. pad:Dreamy |
| 33. wav:Sync 1 | 76. syn:No NerveNet | 119. pad:Floatatious |
| 34. wav:Sync 2 | 77. syn:OBX Saws | 120. pad:GreaT |
| 35. wav:Sync 3 | 78. syn:OohAhh Vox | 121. pad:Highway |
| 36. wav:Sync 4 | 79. syn:P5 Brass | 122. pad:Infants |
| 37. wav:Sync 5 | 80. syn:ProfitMargin | 123. pad:JP6 Pad |
| 38. wav:Sync 6 | 81. syn:Promoseus | 124. pad:Keyngdom |
| 39. wav:Synth Wave | 82. syn:Pulse Pulse | 125. pad:Kingdom High |
| 40. wav:Synthetic | 83. syn:Pulsey! | 126. pad:LOCoMotion |
| 41. wav:VS Voxwav | 84. syn:Pweet Square | 127. pad:Meloden |
| 42. wav:VS37 | 85. syn:Razor | |

Preset Listing

CMPSR Bank 2

- | | | |
|-----------------------|-----------------------|------------------------|
| 0. pad: MetalBeats | 43. hit: Brass Hits 3 | 86. sfx: DawnFollows |
| 1. pad: MovingBells | 44. hit: Brass Hits 4 | 87. sfx: Full Circle |
| 2. pad: Pad Life | 45. hit: Brass Hittas | 88. sfx: Gtr Scrape 1 |
| 3. pad: Paddy | 46. hit: Brass Hitz | 89. sfx: Gtr Scrape 2 |
| 4. pad: Paddy Flange | 47. hit: Da Danzits | 90. sfx: GtrBodyKnock |
| 5. pad: Phat Pad | 48. hit: Dance Hits 1 | 91. sfx: Guitar Pick |
| 6. pad: Phat Pan | 49. hit: Dance Hits 2 | 92. sfx: Hello!!! |
| 7. pad: Pulsation | 50. hit: Deep Brass | 93. sfx: Hill |
| 8. pad: PWM Melopadd | 51. hit: Dirt Strings | 94. sfx: It's Coming |
| 9. pad: PWM Rezslide | 52. hit: Fashion | 95. sfx: Loop 3 |
| 10. pad: RiffTrippin' | 53. hit: Garagiste | 96. sfx: NightCrawler |
| 11. pad: Spinwip Octa | 54. hit: Guitars | 97. sfx: Oh No its... |
| 12. pad: SweptAway | 55. hit: Guitarzits | 98. sfx: Ohh |
| 13. pad: Synth Pad | 56. hit: Orch Fatlow | 99. sfx: PnoSndBoard |
| 14. pad: Tunguska | 57. hit: Organ Hits 1 | 100. sfx: PoppysOnMars |
| 15. pad: Under Pad FM | 58. hit: Organ Hits 2 | 101. sfx: Ritual |
| 16. pad: Urban Pipe | 59. hit: Poker | 102. sfx: StringScrape |
| 17. pad: Whisp | 60. hit: Punch Prak | 103. sfx: TarzansDance |
| 18. pad: Xylo Pad | 61. hit: Sax Scandals | 104. sfx: We Ha |
| 19. pad: Zoom | 62. hit: Skweeler | 105. sfx: WhoaWhoa |
| 20. pad: Zoom 2000! | 63. hit: String Hits | 106. sfx: Woooo! |
| 21. pad: Zyzze | 64. hit: Synth Basses | 107. sfx: Ya Who |
| 22. bpm: Build Up | 65. hit: Vox Grunts | 108. nse: Carrion |
| 23. bpm: Choice 1 | 66. hit: Vox Hits 1 | 109. nse: Dust Bunny |
| 24. bpm: Deep Blue | 67. hit: Vox Hits 2 | 110. nse: Jungle Pump |
| 25. bpm: DXBeat | 68. hit: Vox Hitties | 111. nse: Lift Off |
| 26. bpm: Electronica | 69. orc: Brasso | 112. nse: Pink |
| 27. bpm: Free Love | 70. orc: Combo | 113. nse: StopThat! |
| 28. bpm: Freeze | 71. orc: Fanfare | 114. nse: Vinyl |
| 29. bpm: Industry Vox | 72. orc: Orch w/Perc | 115. nse: White |
| 30. bpm: Move Clock ! | 73. orc: Orchestra | 116. scr: Cuts & Hats |
| 31. bpm: Something | 74. orc: PnoBrsStrg | 117. scr: DissedSkrach |
| 32. bpm: The Man | 75. orc: Str/Brs/Wd1 | 118. scr: Dogs'nHeat |
| 33. bpm: Waver | 76. orc: Str/Brs/Wd2 | 119. scr: From Vinyl |
| 34. hit: Alta Trumprt | 77. orc: Str/Brs/Wd3 | 120. scr: Monsta Slips |
| 35. hit: Bass Slips | 78. sfx: 30 | 121. scr: Outa Sqaced |
| 36. hit: Basses | 79. sfx: 70's Phazzy | 122. scr: Play It |
| 37. hit: Big Band | 80. sfx: AKS Vinyl | 123. scr: PuppyAlarm |
| 38. hit: Biggy Brass | 81. sfx: Bad Bells | 124. scr: Scratches 1 |
| 39. hit: Brass Batz | 82. sfx: Bass Scrape | 125. scr: Scratches 2 |
| 40. hit: Brass Bite | 83. sfx: Bass Thud | 126. scr: Skrach Dis |
| 41. hit: Brass Hits 1 | 84. sfx: Crickets | 127. scr: Vinyl Set |
| 42. hit: Brass Hits 2 | 85. sfx: Crowd | |

Preset Listing

CMPSR Bank 3

- | | | |
|----------------------|----------------------|-----------------------|
| 0. prc:Acidphone | 43. prc:Soft Vibes | 86. kit:ClubVinyl |
| 1. prc:Agogos | 44. prc:Stuff 1 | 87. kit:CookUsAHit |
| 2. prc:Bell Tree 1 | 45. prc:Stuff 2 | 88. kit:Dance 1 |
| 3. prc:Bell Tree 2 | 46. prc:Tams 1 | 89. kit:Dance 2 |
| 4. prc:Bells1 | 47. prc:Tams 2 | 90. kit:DearLyBeEmuD |
| 5. prc:Bells2 | 48. prc:Timbs 1 | 91. kit:Dee and Be 1 |
| 6. prc:Blocks1 | 49. prc:Timbs 2 | 92. kit:Dee and Be 2 |
| 7. prc:Blocks2 | 50. prc:Timpani | 93. kit:DeepBooty |
| 8. prc:Borneo | 51. prc:Toms 1 | 94. kit:Disenegrate |
| 9. prc:C Bells | 52. prc:Toms 2 | 95. kit:Drum 3 |
| 10. prc:Cargo | 53. prc:TV Spy Vibes | 96. kit:Drum/Bass 1 |
| 11. prc:Claps 1 | 54. prc:Velo Vibes | 97. kit:Drum/Bass 2 |
| 12. prc:Claps 2 | 55. prc:Vibraslap | 98. kit:Drum/Bass 3 |
| 13. prc:Claves | 56. prc:Village | 99. kit:Drum/Bass 4 |
| 14. prc:Congas1 | 57. prc:WoodHitsBell | 100. kit:Drum/Bass 5 |
| 15. prc:Congas2 | 58. prc:Xylophone | 101. kit:Drum/Bass 6 |
| 16. prc:Cyms 1 | 59. kit:424 | 102. kit:DrumBuzza |
| 17. prc:Cyms 2 | 60. kit:Kit 02 | 103. kit:For Real |
| 18. prc:Electro | 61. kit:Kit 03 | 104. kit:Gate Dances |
| 19. prc:Flexi | 62. kit:Kit 04 | 105. kit:Gett..OutPt2 |
| 20. prc:Guiros | 63. kit:Kit 05 | 106. kit:GritKitt |
| 21. prc:Hard Vibes | 64. kit:Kit 06 | 107. kit:HatAttack |
| 22. prc:Hats 1 | 65. kit:Kit 07 | 108. kit:Hot Swing |
| 23. prc:Hats 2 | 66. kit:Kit 08 | 109. kit:Jams |
| 24. prc:Hi Bell | 67. kit:Kit 09 | 110. kit:Jazz Quartet |
| 25. prc:Kalimba | 68. kit:Kit 10 | 111. kit:Jazz Trio |
| 26. prc:Kix 1 | 69. kit:Kit 11 | 112. kit:OnTheTip |
| 27. prc:Kix 2 | 70. kit:Kit 12 | 113. kit:Phased DrumR |
| 28. prc:Log On | 71. kit:Kit 13 | 114. kit:Phattasassin |
| 29. prc:Maracca | 72. kit:Kit 14 | 115. kit:R&B Flava |
| 30. prc:Marimba | 73. kit:Kit 15 | 116. kit:Shag |
| 31. prc:Miscellany | 74. kit:Kit 16 | 117. kit:Skin Drums |
| 32. prc:Orchestral | 75. kit:Kit 17 | 118. kit:Smackers |
| 33. prc:Perky Dance | 76. kit:Kit 18 | 119. kit:SounDfactory |
| 34. prc:PerkyThings1 | 77. kit:Kit 19 | 120. kit:Speed Garage |
| 35. prc:PerkyThings2 | 78. kit:Kit 20 | 121. kit:Subversive |
| 36. prc:Plexitone | 79. kit:Acoustic 2 | 122. kit:Swing Hop 1 |
| 37. prc:Progress | 80. kit:All Niter | 123. kit:Swing Hop 2 |
| 38. prc:Shakers | 81. kit:Berzerker | 124. kit:Swing Hop 3 |
| 39. prc:SiameseCats | 82. kit:BMF | 125. kit:This & That |
| 40. prc:Snaps | 83. kit:Booster | 126. kit:Tribal House |
| 41. prc:Snares 1 | 84. kit:ClassicHouse | 127. kit:Werzerker |
| 42. prc:Snares 2 | 85. kit:Clean R&B | |

Instrument Listing

Instrument Listing

This section lists the raw instruments in the Composer ROM set. Instruments can be either multisamples or single samples.

0. None	42. org:JX Organ	84. bas:Bass ic
1. pno:Stereo Grand	43. org:Tone Organ	85. bas:Stereo VP1 1
2. pno:Grand Piano2	44. org:Simple Organ	86. bas:VP1 2
3. pno:Techno Piano	45. org:Org Lite	87. bas:FM
4. epo:Med Rhodes	46. org:Nod	88. bas:DB
5. epo:Hard Rhodes	47. org:Full Organ	89. bas:Memory Moog
6. epo:DynoRhodesMd	48. org:Synth Organ	90. bas:Moog Tri
7. epo:DynoRhodesHd	49. org:Breathy	91. bas:Moog Basic
8. epo:Hard Tine	50. org:Dance	92. bas:Mini 1
9. epo:WurlitzerSft	51. org:Synth Cheeze	93. bas:Mini 2
10. epo:Wurlitzer Hd	52. org:Oddd Organ	94. bas:Mini 3
11. epo:FM El Piano	53. sub:Bass Hum	95. bas:Mini 4
12. epo:Tine EP	54. sub:Below Sub	96. bas:Micro Moog
13. epo:Pretty EP	55. sub:Super Sub	97. bas:Not So Mini
14. epo:Classic EP	56. sub:SE Sub 1	98. bas:Sawz
15. epo:FM EP 1	57. sub:SE Sub 2	99. bas:Lowness
16. epo:FM EP 2	58. sub:SE Sub 3	100. bas:Ice
17. epo:Clavinet 1	59. sub:SE Sub 4	101. bas:Analow
18. epo:Clavinet 2	60. sub:SE Sub 5	102. bas:Fat Sunbass
19. epo:EP Roll 1	61. sub:SE Sub 6	103. bas:Analogic
20. epo:EP Roll 2	62. sub:SE Sub 7	104. bas:Q Bass 1
21. epo:EP Roll 3	63. sub:Subtle Bass	105. bas:Q Bass 2
22. epo:EP Fog	64. sub:Moog 1	106. bas:Q Bass 3
23. org:B3DistLowSlo	65. sub:Moog 2	107. bas:Planet Bass
24. org:B3 Dist Fast	66. sub:Q Attack	108. bas:2600
25. org:B3 Hi Slow	67. sub:Juno	109. bas:Synth 1
26. org:B3 Hi Fast	68. sub:Complex	110. bas:Synth 2
27. org:B3 Perc 3rd	69. sub:Full Octave	111. bas:Synth 3
28. org:B3OrganWave1	70. sub:Deep Pocket	112. bas:Synth 4
29. org:B3OrganWave2	71. sub:JP4 Bass	113. bas:Synth 5
30. org:Gritty B Wav	72. sub:Bass Hit	114. bas:Synth 6
31. org:Farfisa 1	73. bas:Acid	115. bas:Synth 7
32. org:Farfisa 2	74. bas:TB 1	116. bas:Synth 8
33. org:Farfisa 3	75. bas:TB 2	117. bas:Synth 9
34. org:Vox 1	76. bas:TB 3	118. bas:Synth 10
35. org:Vox 2	77. bas:TB 4	119. bas:CZ101
36. org:Pipe Organ	78. bas:Saw Sync	120. bas:PPG Hybrid
37. org:Drawbar	79. bas:Big Sync	121. bas:Ultimate 1
38. org:Perc Organ	80. bas:Power Q	122. bas:Ultimate 2
39. org:Day	81. bas:Buzzed	123. bas:DB9 1
40. org:Disco	82. bas:SE 1	124. bas:DB9 2
41. org:DX Organ	83. bas:SE 2	125. bas:Phlappy

Instrument Listing

- | | | |
|-----------------------|-----------------------|-----------------------|
| 126. bas:Pocket | 170. bas:Upright 2 | 214. str:Pizzicato |
| 127. bas:Sonics | 171. gtr:Nylon | 215. str:Tron |
| 128. bas:Perco | 172. gtr:Steel | 216. str:Analog |
| 129. bas:Spitt | 173. gtr:Jazz | 217. str:Matrix Synth |
| 130. bas:Tapp | 174. gtr:Electric 1 | 218. str:Digital |
| 131. bas:DX 1 | 175. gtr:Electric 2 | 219. str:Sham Wave |
| 132. bas:DX 2 | 176. gtr:El Mute 1 | 220. str:Koto |
| 133. bas:DX 3 | 177. gtr:El Mute 2 | 221. str:Sitar |
| 134. bas:Finger 1 | 178. gtr:Mutes | 222. brs:Soft Trumpet |
| 135. bas:Finger 2 | 179. gtr:ElectricDis | 223. brs:Hard Trumpet |
| 136. bas:Picked | 180. gtr:Power 1 | 224. brs:MuteTrumpet1 |
| 137. bas:Slap 1 | 181. gtr:Power 2 | 225. brs:MuteTrumpet2 |
| 138. bas:Slap 2 | 182. gtr:Power Hit | 226. brs:Trombone |
| 139. bas:Slap 3 | 183. gtr:Synth Axe | 227. brs:Tuba |
| 140. bas:Slap 4 | 184. gtr:Gtr Hi Chuck | 228. brs:Trumpet FX 1 |
| 141. bas:Slap 5 | 185. gtr:Gtr Up Strk | 229. brs:Trumpet FX 2 |
| 142. bas:Pop | 186. gtr:Gtr Scratch | 230. brs:Trumpet FX 3 |
| 143. bas:Fretless 1 | 187. gtr:Muted String | 231. brs:Trumpet FX 4 |
| 144. bas:Fretless 2 | 188. gtr:Klean Chuck | 232. brs:Trumpet FX 5 |
| 145. bas:Fretless 3 | 189. gtr:Jangle | 233. brs:Trumpet FX 6 |
| 146. bas:Fretless 4 | 190. gtr:Riff 1 | 234. brs:Trumpet FX 7 |
| 147. bas:Fretless 5 | 191. gtr:Riff 2 | 235. brs:Alt TptLoops |
| 148. bas:Fretless 6 | 192. gtr:Riff 3 | 236. brs:Ensemble |
| 149. bas:EP 1 | 193. gtr:Funky Hit | 237. brs:Section |
| 150. bas:EP 2 | 194. gtr:Another Hit | 238. brs:Brass Hits 1 |
| 151. bas:EP 3 | 195. gtr:Jazz Riff 1 | 239. brs:Brass Hits 2 |
| 152. bas:Home 1 | 196. gtr:Jazz Riff 2 | 240. brs:ClassicBrass |
| 153. bas:Home 2 | 197. gtr:Jazz Riff 3 | 241. brs:Moog |
| 154. bas:Street | 198. gtr:Slide Riff | 242. brs:Prophet 5 |
| 155. bas:Pure | 199. gtr:Pop Slide | 243. brs:5th Wave |
| 156. bas:Fing&Harms 1 | 200. gtr:Pop | 244. wnd:Ocarina |
| 157. bas:Fing&Harms 2 | 201. gtr:Chord Chuck | 245. wnd:Pan Flute |
| 158. bas:All Purpose | 202. gtr:Slide | 246. wnd:Flute |
| 159. bas:Standard | 203. gtr:Sad Guitar | 247. wnd:Synth Flute |
| 160. bas:Gruzzly Pop | 204. gtr:Wawa 1 | 248. wnd:Clarinet |
| 161. bas:Pop Slide 1 | 205. gtr:Wawa 2 | 249. wnd:Oboe |
| 162. bas:Pop Slide 2 | 206. gtr:Wawa 3 | 250. wnd:English Horn |
| 163. bas:Pop Slide 3 | 207. gtr:Wawa 4 | 251. wnd:Soprano Sax |
| 164. bas:Pop Slide 4 | 208. gtr:Wawa 5 | 252. wnd:Alto Sax |
| 165. bas:Organ Bass 1 | 209. gtr:Wawa 6 | 253. wnd:Tenor Sax |
| 166. bas:Organ Bass 2 | 210. gtr:Heavy Hit | 254. wnd:Sax Wave |
| 167. bas:Acoustic | 211. gtr:Heavy Dive | 255. wnd:Bari Sax 1 |
| 168. bas:Harmonics | 212. str:Solo Quartet | 256. wnd:Bari Sax 2 |
| 169. bas:Upright 1 | 213. str:Section | 257. wnd:Sax Riff |

Instrument Listing

258.	wnd:Sax FX 1	302.	wav:Moog Lead	346.	wav:Worm Lead 3
259.	wnd:Sax FX 2	303.	wav:Fretless	347.	wav:Worm Lead 4
260.	wnd:Sax FX 3	304.	wav:Magic	348.	wav:Worm Lead 5
261.	wnd:Bottle Blow	305.	wav:ES Rag	349.	wav:Worm Lead 6
262.	wnd:Shenai	306.	wav:Chime	350.	wav:Sinusoid
263.	wnd:Harmonica	307.	wav:Pure H2O	351.	wav:Sine Wave 2
264.	vox:Pop Oohs	308.	wav:Log Hit	352.	wav:Sine Squared
265.	vox:Pop Aahs	309.	wav:Pluck Tone	353.	wav:Sine Inv Sqr
266.	vox:Soul Oohs	310.	wav:Hollow Deep	354.	wav:Sine Cubed
267.	vox:Breathy 1	311.	wav:Bell Synth	355.	wav:SineInvCubed
268.	vox:Breathy 2	312.	wav:Syn Tone	356.	wav:Triangle
269.	vox:Very Breathy	313.	wav:Perc Axe Syn	357.	wav:Square
270.	vox:VS Wave	314.	wav:Whine	358.	wav:Sawtooth 1
271.	vox:Choir Wave	315.	wav:CZ101 Digi	359.	wav:Sawtooth 2
272.	vox:Jax Breath	316.	wav:CZ Lead	360.	wav:Pulse Plus
273.	vox:Vox Synth	317.	wav:CZ Echo Lead	361.	wav:Pulse 75%
274.	vox:Orch Vox	318.	wav:Wild Synth	362.	wav:Pulse 90%
275.	vox:CMI Breath	319.	wav:Spacey Keys	363.	wav:Pulse 94%
276.	vox:Tarzana	320.	wav:Dig Buzz Syn	364.	wav:Pulse 96%
277.	vox:Gothic	321.	wav:Rast Keys	365.	wav:Pulse 98%
278.	vox:Oow	322.	wav:Narrow Synth	366.	wav:FourOctaves
279.	vox:Comon Vox	323.	wav:Fat Attack	367.	wav:Low Odds
280.	vox:Odd Vox	324.	wav:Synthetic	368.	wav:Low Evens
281.	vox:Mmm Hmm	325.	wav:Overtone Syn	369.	syn:Saw Stack
282.	vox:Ah Hah	326.	wav:Buzz Saw Syn	370.	syn:Moog 55
283.	wav:PWM	327.	wav:Blipper	371.	syn:Buzz Synth
284.	wav:Eraser	328.	wav:Full Synth	372.	syn:Bender
285.	wav:M12 Sync	329.	wav:Bass Synth	373.	syn:Soft Synth
286.	wav:Stereo Synth	330.	wav:Mini Lead	374.	syn:Hi String
287.	wav:FeedbackWave	331.	wav:M12 Lead	375.	syn:OBX Saws
288.	wav:MetalAttack	332.	wav:Sync 1	376.	syn:Big Planet
289.	wav:Arp 1	333.	wav:Sync 2	377.	syn:Saw Sweep
290.	wav:Arp 2	334.	wav:Sync 3	378.	wav:Juno Pulse
291.	wav:Arp 3	335.	wav:Sync 4	379.	syn:CZ Synstring
292.	wav:ARP Lead	336.	wav:Sync 5	380.	syn:SynEnsemble
293.	wav:Metal 1	337.	wav:Sync 6	381.	syn:Rezyzy Wave
294.	wav:Metal 2	338.	wav:Pop Square	382.	syn:Heavy
295.	wav:Metal 3	339.	wav:Juno Square	383.	syn:Rez Synth
296.	wav:PPG	340.	wav:SquareAttack	384.	syn:Hi Oct Synth
297.	wav:VS Vox	341.	wav:Square Lead	385.	syn:Mood Strings
298.	wav:VS37	342.	wav:SquareChorus	386.	syn:Brazz
299.	wav:VS48	343.	wav:Juno Pulse	387.	syn:Synth Brass
300.	wav:Rezyzy	344.	wav:Worm Lead 1	388.	syn:P5 Brass
301.	wav:Glass Perc	345.	wav:Worm Lead 2	389.	pad:JP6 Pad

Instrument Listing

390.	pad:Dreamy	434.	hit:Brass Hit 9	478.	hit:Dance Hit 11
391.	pad:Phat Pad	435.	hit:Brass Hit 10	479.	hit:Dance Hit 12
392.	pad:Synth Pad	436.	hit:Brass Hit 11	480.	hit:Dance Hit 13
393.	pad:Pad Life	437.	hit:Brass Hit 12	481.	hit:Dance Hit 14
394.	pad:Classic	438.	hit:Brass Hit 13	482.	hit:Dance Hit 15
395.	pad:Dream Pad	439.	hit:Brass Hit 14	483.	hit:Dance Hit 16
396.	pad:Paddy	440.	hit:Brass Hit 15	484.	hit:Dance Hit 17
397.	pad:Dance Chord	441.	hit:Brass Hit 16	485.	hit:Dance Hit 18
398.	pad:Zoom	442.	hit:Brass Hit 17	486.	hit:Dance Hit 19
399.	pad:Keyngdom	443.	hit:Brass Hit 18	487.	hit:Dance Hit 20
400.	pad:Under Pad FM	444.	hit:Brass Hit 19	488.	hit:Dance Hit 21
401.	pad:Xylo Pad	445.	hit:Brass Hit 20	489.	hit:Dance Hit 22
402.	hit:Organ Hits 1	446.	hit:Boink	490.	hit:Dance Hit 23
403.	hit:Organ Hits 2	447.	hit:Fat Low Syn	491.	hit:Dance Hit 24
404.	hit:Basses	448.	hit:Hit On It	492.	hit:Dance Hit 25
405.	hit:Synth Basses	449.	hit:Jazz Short	493.	hit:Dance Hit 26
406.	hit:Guitars	450.	hit:Blamp Hit	494.	hit:Dance Hit 27
407.	hit:String Hits	451.	hit:Blipp	495.	sfx:Q Snap
408.	hit:Brass Hits 1	452.	hit:Buzz Blip	496.	sfx:Bass Scrape
409.	hit:Brass Hits 2	453.	hit:Game Hit	497.	sfx:Bass Thud
410.	hit:Vox Hits 1	454.	hit:Diss Hit	498.	sfx:Gtr Scrape 1
411.	hit:Vox Hits 2	455.	hit:Bell Hit	499.	sfx:Gtr Scrape 2
412.	hit:Dance Hits 1	456.	hit:Klang Hit	500.	sfx:Guitar Pick
413.	hit:Dance Hits 2	457.	hit:Metal Hit	501.	sfx:GtrBodyKnock
414.	hit:Organ Hit 1	458.	hit:Slinky Q Hit	502.	sfx:StringScrape
415.	hit:Organ Hit 2	459.	hit:Space Whip	503.	sfx:Tpt Breath
416.	hit:Organ Hit 3	460.	hit:Short Quack	504.	sfx:Alto Breath
417.	hit:Organ Hit 4	461.	hit:Quack Ahhh	505.	sfx:PnoSndBoard
418.	hit:Organ Hit 5	462.	hit:Bowser Bark	506.	sfx:Loop 1
419.	hit:Organ Hit 6	463.	hit:Chiffin	507.	sfx:Loop 2
420.	hit:Bass Stab 1	464.	hit:Ripped	508.	sfx:Loop 3
421.	hit:Bass Stab 2	465.	hit:Drum Stab	509.	sfx:Loop 4
422.	hit:Bass Slide	466.	hit:Hip Hop Hit	510.	sfx:Loop 5
423.	hit:Orch C3	467.	hit:Drum Stall	511.	sfx:Loop 6
424.	hit:UnisonString	468.	hit:Dance Hit 1	512.	sfx:Loop 7
425.	hit:Unison Brass	469.	hit:Dance Hit 2	513.	sfx:Loop 8
426.	hit:Brass Hit 1	470.	hit:Dance Hit 3	514.	sfx:Crickets
427.	hit:Brass Hit 2	471.	hit:Dance Hit 4	515.	sfx:Crowd
428.	hit:Brass Hit 3	472.	hit:Dance Hit 5	516.	sfx:Music Crowd
429.	hit:Brass Hit 4	473.	hit:Dance Hit 6	517.	sfx:Lawn Mower
430.	hit:Brass Hit 5	474.	hit:Dance Hit 7	518.	sfx:Riff Trip
431.	hit:Brass Hit 6	475.	hit:Dance Hit 8	519.	sfx:Cyber Pan
432.	hit:Brass Hit 7	476.	hit:Dance Hit 9	520.	sfx:Groove Thing
433.	hit:Brass Hit 8	477.	hit:Dance Hit 10	521.	sfx:Science

Instrument Listing

522.	sfx:Sci Fi	566.	scr:Classic Tape	610.	prc:Cymbals 2
523.	sfx:Synth Siren	567.	scr:Scratch Out!	611.	prc:Shakers
524.	sfx:Space Wiggle	568.	scr:Punch It	612.	prc:Maracas
525.	sfx:Sqweal Rev	569.	scr:Ork Scratch	613.	prc:Bells 1
526.	nse:White 1	570.	scr:Tape Stop	614.	prc:Bells 2
527.	nse:No Pitch	571.	scr:Zip Scratch	615.	prc:Blocks 1
528.	nse:Pink 1	572.	scr:Tape Pull	616.	prc:Blocks 2
529.	nse:Pink 2	573.	scr:Wild Scratch	617.	prc:Tams 1
530.	nse:Spectrum 1	574.	scr:Up Scratch	618.	prc:Tams 2
531.	nse:Spectrum 2	575.	scr:Scratch Away	619.	prc:Claps 1
532.	nse:Spectrum 3	576.	scr:Frenzy	620.	prc:Claps 2
533.	nse:Spectrum 4	577.	scr:KickScratch1	621.	prc:Snaps
534.	nse:Air	578.	scr:KickScratch2	622.	prc:Claves
535.	nse:High Pass	579.	scr:SnareScratch	623.	prc:Vibraslap
536.	nse:Excited HP	580.	scr:Tite Scratch	624.	prc:Guiro Roll
537.	nse:IP Wave	581.	scr:Scratch Up	625.	prc:Cowbells
538.	nse:Metal Noise	582.	scr:Barker	626.	prc:Agogos
539.	nse:Vinyl 1	583.	scr:Plunger	627.	prc:Carillon
540.	nse:Vinyl 2	584.	scr:Skipper	628.	prc:Misc Perc 1
541.	nse:Vinyl 3	585.	scr:Fast Scratch	629.	prc:Misc Perc 2
542.	nse:Vinyl 4	586.	prc:Soft Vibes	630.	kit:Acoustic 1&2
543.	nse:Vinyl 1 NTF	587.	prc:Hard Vibes	631.	kit:Acoustic 3&4
544.	nse:Vinyl 2 NTF	588.	prc:Xylophone	632.	kit:Dance Set
545.	nse:Vinyl 3 NTF	589.	prc:Marimba	633.	kit:Dance Perc
546.	nse:Vinyl 4 NTF	590.	prc:Kalimba	634.	kit:Kit 1
547.	nse:CMI Hot Air	591.	prc:Plexitone	635.	kit:Kit 2
548.	nse:L9000 Noise	592.	prc:Orchestral	636.	kit:Kit 3
549.	scr:Scratches 1	593.	prc:Miscellany	637.	kit:Kit 4
550.	scr:Scratches 2	594.	prc:FM Log Drum	638.	kit:Kit 5
551.	scr:Vinyl Set	595.	prc:SynDrum Wave	639.	kit:Kit 6
552.	scr:Stalled	596.	prc:X-ite Tick	640.	kit:Kit 7
553.	scr:Wind Down 1	597.	prc:Kicks 1	641.	kit:Kit 8
554.	scr:Wind Down 2	598.	prc:Kicks 2	642.	kit:Kit 9
555.	scr:Draggit	599.	prc:Snare 1	643.	kit:Kit 10
556.	scr:MC Scratch	600.	prc:Snare 2	644.	kit:Kit 11
557.	scr:Fun Scratch	601.	prc:Toms 1	645.	kit:Kit 12
558.	scr:SSSSystem 1	602.	prc:Toms 2	646.	kit:Kit 13
559.	scr:SSSSystem 2	603.	prc:Timbales 1	647.	kit:Kit 14
560.	scr:Scratch Here	604.	prc:Timbales 2	648.	kit:Kit 15
561.	scr:Scratch On I	605.	prc:Congas etc 1	649.	kit:Kit 16
562.	scr:Scratch Diss	606.	prc:Congas etc 2	650.	kit:GM Dance
563.	scr:Bow Wow	607.	prc:Hats 1	651.	kit:Swing Hop
564.	scr:Diva Scratch	608.	prc:Hats 2	652.	kit:Swing Hop 2
565.	scr:OrganBlipper	609.	prc:Cymbals 1	653.	kit:Swing Hop 3

Instrument Listing

654.	prc:Kick 1	698.	prc:Kick 45	742.	prc:Snare 18
655.	prc:Kick 2	699.	prc:Kick 46	743.	prc:Snare 19
656.	prc:Kick 3	700.	prc:Kick 47	744.	prc:Snare 20
657.	prc:Kick 4	701.	prc:Kick 48	745.	prc:Snare 21
658.	prc:Kick 5	702.	prc:Kick 49	746.	prc:Snare 22
659.	prc:Kick 6	703.	prc:Kick 50	747.	prc:Snare 23
660.	prc:Kick 7	704.	prc:Kick 51	748.	prc:Snare 24
661.	prc:Kick 8	705.	prc:Kick 52	749.	prc:Snare 25
662.	prc:Kick 9	706.	prc:Kick 53	750.	prc:Snare 26
663.	prc:Kick 10	707.	prc:Kick 54	751.	prc:Snare 27
664.	prc:Kick 11	708.	prc:Kick 55	752.	prc:Snare 28
665.	prc:Kick 12	709.	prc:Kick 56	753.	prc:Snare 29
666.	prc:Kick 13	710.	prc:Kick 57	754.	prc:Snare 30
667.	prc:Kick 14	711.	prc:Kick 58	755.	prc:Snare 31
668.	prc:Kick 15	712.	prc:Kick 59	756.	prc:Snare 32
669.	prc:Kick 16	713.	prc:Kick 60	757.	prc:Snare 33
670.	prc:Kick 17	714.	prc:Kick 61	758.	prc:Snare 34
671.	prc:Kick 18	715.	prc:Kick 62	759.	prc:Snare 35
672.	prc:Kick 19	716.	prc:Kick 63	760.	prc:Snare 36
673.	prc:Kick 20	717.	prc:Kick 64	761.	prc:Snare 37
674.	prc:Kick 21	718.	prc:Kick 65	762.	prc:Snare 38
675.	prc:Kick 22	719.	prc:Kick 66	763.	prc:Snare 39
676.	prc:Kick 23	720.	prc:Kick 67	764.	prc:Snare 40
677.	prc:Kick 24	721.	prc:Kick 68	765.	prc:Snare 41
678.	prc:Kick 25	722.	prc:Kick 69	766.	prc:Snare 42
679.	prc:Kick 26	723.	prc:Kick 70	767.	prc:Snare 43
680.	prc:Kick 27	724.	prc:Kick 71	768.	prc:Snare 44
681.	prc:Kick 28	725.	prc:Snare 1	769.	prc:Snare 45
682.	prc:Kick 29	726.	prc:Snare 2	770.	prc:Snare 46
683.	prc:Kick 30	727.	prc:Snare 3	771.	prc:Snare 47
684.	prc:Kick 31	728.	prc:Snare 4	772.	prc:Snare 48
685.	prc:Kick 32	729.	prc:Snare 5	773.	prc:Snare 49
686.	prc:Kick 33	730.	prc:Snare 6	774.	prc:Snare 50
687.	prc:Kick 34	731.	prc:Snare 7	775.	prc:Snare 51
688.	prc:Kick 35	732.	prc:Snare 8	776.	prc:Snare 52
689.	prc:Kick 36	733.	prc:Snare 9	777.	prc:Snare 53
690.	prc:Kick 37	734.	prc:Snare 10	778.	prc:Snare 54
691.	prc:Kick 38	735.	prc:Snare 11	779.	prc:Snare 55
692.	prc:Kick 39	736.	prc:Snare 12	780.	prc:Snare 56
693.	prc:Kick 40	737.	prc:Snare 13	781.	prc:Snare 57
694.	prc:Kick 41	738.	prc:Snare 14	782.	prc:Snare 58
695.	prc:Kick 42	739.	prc:Snare 15	783.	prc:Snare 59
696.	prc:Kick 43	740.	prc:Snare 16	784.	prc:Snare 60
697.	prc:Kick 44	741.	prc:Snare 17	785.	prc:Snare 61

Instrument Listing

786.	prc:Snare 62	830.	prc:Snare 106	874.	prc:Tom 13
787.	prc:Snare 63	831.	prc:Snare 107	875.	prc:Tom 14
788.	prc:Snare 64	832.	prc:Snare 108	876.	prc:Tom 15
789.	prc:Snare 65	833.	prc:Snare 109	877.	prc:Tom 16
790.	prc:Snare 66	834.	prc:Snare 110	878.	prc:Tom 17
791.	prc:Snare 67	835.	prc:Snare 111	879.	prc:Tom 18
792.	prc:Snare 68	836.	prc:Snare 112	880.	prc:Tom 19
793.	prc:Snare 69	837.	prc:Snare 113	881.	prc:Tom 20
794.	prc:Snare 70	838.	prc:Snare 114	882.	prc:Tom 21
795.	prc:Snare 71	839.	prc:Snare 115	883.	prc:Tom 22
796.	prc:Snare 72	840.	prc:Snare 116	884.	prc:Tom 23
797.	prc:Snare 73	841.	prc:Snare 117	885.	prc:Tom 24
798.	prc:Snare 74	842.	prc:Snare 118	886.	prc:Tom 25
799.	prc:Snare 75	843.	prc:Snare 119	887.	prc:Tom 26
800.	prc:Snare 76	844.	prc:Snare 120	888.	prc:Tom 27
801.	prc:Snare 77	845.	prc:Snare 121	889.	prc:Tom 28
802.	prc:Snare 78	846.	prc:Snare 122	890.	prc:Tom 29
803.	prc:Snare 79	847.	prc:Snare 123	891.	prc:Tom 30
804.	prc:Snare 80	848.	prc:Snare 124	892.	prc:Tom 31
805.	prc:Snare 81	849.	prc:Snare 125	893.	prc:Conga 1
806.	prc:Snare 82	850.	prc:Snare 126	894.	prc:Conga 2
807.	prc:Snare 83	851.	prc:Snare 127	895.	prc:Conga 3
808.	prc:Snare 84	852.	prc:Snare 128	896.	prc:Conga 4
809.	prc:Snare 85	853.	prc:Snare 129	897.	prc:Conga 5
810.	prc:Snare 86	854.	prc:Snare 130	898.	prc:Conga 6
811.	prc:Snare 87	855.	prc:Snare 131	899.	prc:Conga 7
812.	prc:Snare 88	856.	prc:Timbale 1	900.	prc:Conga 8
813.	prc:Snare 89	857.	prc:Timbale 2	901.	prc:Conga 9
814.	prc:Snare 90	858.	prc:Timbale 3	902.	prc:Conga 10
815.	prc:Snare 91	859.	prc:Timbale 4	903.	prc:Conga 11
816.	prc:Snare 92	860.	prc:Timbale 5	904.	prc:Conga 12
817.	prc:Snare 93	861.	prc:Timbale 6	905.	prc:Conga 13
818.	prc:Snare 94	862.	prc:Tom 1	906.	prc:Conga 14
819.	prc:Snare 95	863.	prc:Tom 2	907.	prc:Conga 15
820.	prc:Snare 96	864.	prc:Tom 3	908.	prc:Conga 16
821.	prc:Snare 97	865.	prc:Tom 4	909.	prc:Conga 17
822.	prc:Snare 98	866.	prc:Tom 5	910.	prc:Conga 18
823.	prc:Snare 99	867.	prc:Tom 6	911.	prc:Conga 19
824.	prc:Snare 100	868.	prc:Tom 7	912.	prc:Conga 20
825.	prc:Snare 101	869.	prc:Tom 8	913.	prc:Conga 21
826.	prc:Snare 102	870.	prc:Tom 9	914.	prc:Hat 1
827.	prc:Snare 103	871.	prc:Tom 10	915.	prc:Hat 2
828.	prc:Snare 104	872.	prc:Tom 11	916.	prc:Hat 3
829.	prc:Snare 105	873.	prc:Tom 12	917.	prc:Hat 4

Instrument Listing

918.	prc:Hat 5	962.	prc:Hat 49	1006.	prc:Hat 93
919.	prc:Hat 6	963.	prc:Hat 50	1007.	prc:Hat 94
920.	prc:Hat 7	964.	prc:Hat 51	1008.	prc:Hat 95
921.	prc:Hat 8	965.	prc:Hat 52	1009.	prc:Cymbal 1
922.	prc:Hat 9	966.	prc:Hat 53	1010.	prc:Cymbal 2
923.	prc:Hat 10	967.	prc:Hat 54	1011.	prc:Cymbal 3
924.	prc:Hat 11	968.	prc:Hat 55	1012.	prc:Cymbal 4
925.	prc:Hat 12	969.	prc:Hat 56	1013.	prc:Cymbal 5
926.	prc:Hat 13	970.	prc:Hat 57	1014.	prc:Cymbal 6
927.	prc:Hat 14	971.	prc:Hat 58	1015.	prc:Cymbal 7
928.	prc:Hat 15	972.	prc:Hat 59	1016.	prc:Cymbal 8
929.	prc:Hat 16	973.	prc:Hat 60	1017.	prc:Cymbal 9
930.	prc:Hat 17	974.	prc:Hat 61	1018.	prc:Cymbal 10
931.	prc:Hat 18	975.	prc:Hat 62	1019.	prc:Cymbal 11
932.	prc:Hat 19	976.	prc:Hat 63	1020.	prc:Cymbal 12
933.	prc:Hat 20	977.	prc:Hat 64	1021.	prc:Cymbal 13
934.	prc:Hat 21	978.	prc:Hat 65	1022.	prc:Cymbal 14
935.	prc:Hat 22	979.	prc:Hat 66	1023.	prc:Cymbal 15
936.	prc:Hat 23	980.	prc:Hat 67	1024.	prc:Cymbal 16
937.	prc:Hat 24	981.	prc:Hat 68	1025.	prc:Cymbal 17
938.	prc:Hat 25	982.	prc:Hat 69	1026.	prc:Cymbal 19
939.	prc:Hat 26	983.	prc:Hat 70	1027.	prc:Cymbal 20
940.	prc:Hat 27	984.	prc:Hat 71	1028.	prc:Cymbal 21
941.	prc:Hat 28	985.	prc:Hat 72	1029.	prc:Cymbal 22
942.	prc:Hat 29	986.	prc:Hat 73	1030.	prc:Cymbal 23
943.	prc:Hat 30	987.	prc:Hat 74	1031.	prc:Cymbal 24
944.	prc:Hat 31	988.	prc:Hat 75	1032.	prc:Cymbal 25
945.	prc:Hat 32	989.	prc:Hat 76	1033.	prc:Cymbal 26
946.	prc:Hat 33	990.	prc:Hat 77	1034.	prc:Cymbal 27
947.	prc:Hat 34	991.	prc:Hat 78	1035.	prc:Cymbal 28
948.	prc:Hat 35	992.	prc:Hat 79	1036.	prc:Cymbal 29
949.	prc:Hat 36	993.	prc:Hat 80	1037.	prc:Shaker 1
950.	prc:Hat 37	994.	prc:Hat 81	1038.	prc:Shaker 2
951.	prc:Hat 38	995.	prc:Hat 82	1039.	prc:Shaker 3
952.	prc:Hat 39	996.	prc:Hat 83	1040.	prc:Shaker 4
953.	prc:Hat 40	997.	prc:Hat 84	1041.	prc:Shaker 5
954.	prc:Hat 41	998.	prc:Hat 85	1042.	prc:Shaker 6
955.	prc:Hat 42	999.	prc:Hat 86	1043.	prc:Shaker 7
956.	prc:Hat 43	1000.	prc:Hat 87	1044.	prc:Shaker 8
957.	prc:Hat 44	1001.	prc:Hat 88	1045.	prc:Shaker 9
958.	prc:Hat 45	1002.	prc:Hat 89	1046.	prc:Shaker 10
959.	prc:Hat 46	1003.	prc:Hat 90	1047.	prc:Shaker 11
960.	prc:Hat 47	1004.	prc:Hat 91	1048.	prc:Shaker 12
961.	prc:Hat 48	1005.	prc:Hat 92	1049.	prc:Shaker 13

Instrument Listing

1050.	prc:Shaker 14	1092.	prc:Block 26	1134.	prc:Clap 17
1051.	prc:Shaker 15	1093.	prc:Block 27	1135.	prc:Clap 18
1052.	prc:Shaker 16	1094.	prc:Block 28	1136.	prc:Snap 1
1053.	prc:Shaker 17	1095.	prc:Block 1	1137.	prc:Snap 2
1054.	prc:Shaker 18	1096.	prc:Block 2	1138.	prc:Snap 3
1055.	prc:Shaker 19	1097.	prc:Block 3	1139.	prc:Snap 4
1056.	prc:Shaker 20	1098.	prc:Block 4	1140.	prc:Snap 5
1057.	prc:Shaker 21	1099.	prc:Block 5	1141.	prc:Snap 6
1058.	prc:Shaker 22	1100.	prc:Block 6	1142.	prc:Misc 1
1059.	prc:Shaker 23	1101.	prc:Block 7	1143.	prc:Misc 2
1060.	prc:Shaker 24	1102.	prc:Block 8	1144.	prc:Misc 3
1061.	prc:Shaker 25	1103.	prc:Block 9	1145.	prc:Misc 4
1062.	prc:Shaker 26	1104.	prc:Block 10	1146.	prc:Misc 5
1063.	prc:Shaker 27	1105.	prc:Block 11	1147.	prc:Misc 6
1064.	prc:Shaker 28	1106.	prc:Block 12	1148.	prc:Misc 7
1065.	prc:Flexitone	1107.	prc:Block 13	1149.	prc:Misc 8
1066.	prc:Block 1	1108.	prc:Block 14	1150.	prc:Misc 9
1067.	prc:Block 2	1109.	prc:Tam 1	1151.	prc:Misc 10
1068.	prc:Block 3	1110.	prc:Tam 2	1152.	prc:Misc 11
1069.	prc:Block 4	1111.	prc:Tam 3	1153.	prc:Misc 12
1070.	prc:Block 5	1112.	prc:Tam 4	1154.	prc:Misc 13
1071.	prc:Block 6	1113.	prc:Tam 5	1155.	prc:Misc 14
1072.	prc:Block 7	1114.	prc:Tam 6	1156.	prc:Misc 15
1073.	prc:Block 8	1115.	prc:Tam 7	1157.	prc:Misc 16
1074.	prc:Block 9	1116.	prc:Tam 8	1158.	prc:Misc 17
1075.	prc:Block 10	1117.	prc:Tam 9	1159.	prc:Misc 18
1076.	prc:Block 11	1118.	prc:Clap 1	1160.	prc:Misc 19
1077.	prc:Block Tree	1119.	prc:Clap 2	1161.	prc:Misc 20
1078.	prc:Block 12	1120.	prc:Clap 3	1162.	prc:Misc 21
1079.	prc:Block 13	1121.	prc:Clap 4	1163.	prc:Misc 22
1080.	prc:Block 14	1122.	prc:Clap 5	1164.	prc:Misc 23
1081.	prc:Block 15	1123.	prc:Clap 6	1165.	prc:Misc 24
1082.	prc:Block 16	1124.	prc:Clap 7	1166.	prc:Misc 25
1083.	prc:Block 17	1125.	prc:Clap 8	1167.	prc:Misc 26
1084.	prc:Block 18	1126.	prc:Clap 9	1168.	prc:Misc 27
1085.	prc:Block 19	1127.	prc:Clap 10	1169.	prc:Misc 28
1086.	prc:Block 20	1128.	prc:Clap 11	1170.	prc:Misc 29
1087.	prc:Block 21	1129.	prc:Clap 12	1171.	prc:Misc 30
1088.	prc:Block 22	1130.	prc:Clap 13	1172.	prc:Misc 31
1089.	prc:Block 23	1131.	prc:Clap 14	1173.	prc:Misc 32
1090.	prc:Block 24	1132.	prc:Clap 15		
1091.	prc:Block 25	1133.	prc:Clap 16		

Riff Listing

Riff Listing

- | | | |
|----------------------|----------------------|-----------------------|
| 1. KEY-C3 | 45. BAS-Slap Me | 89. GTR-EmmTV Crunch |
| 2. KEY-C3 (2 Bars) | 46. BAS-Slappity | 90. GTR-FallingNylon |
| 3. KEY-C3 (4 Bars) | 47. BAS-Soft&Hard | 91. GTR-FlangnVioWah |
| 4. KEY-C4 | 48. BAS-Stomper | 92. GTR-FullNylon |
| 5. KEY-Cs Up | 49. BAS-Sub Core | 93. GTR-GenericClean |
| 6. KEY-Cs Up-Down | 50. BAS-Sub Pummeled | 94. GTR-Grusty |
| 7. KEY-C Triad | 51. BAS-Sub-Basement | 95. GTR-JangleWah |
| 8. KEY-Cm7 | 52. BAS-Sugar Freak | 96. GTR-Jazzed |
| 9. KEY-Cm9 | 53. BAS-The Reason | 97. GTR-LA Strata |
| 10. KEY-Cmaj7 | 54. BAS-ThickFretles | 98. GTR-Looz 12s |
| 11. BAS-2600 | 55. BAS-Thickley Dub | 99. GTR-MellowElect |
| 12. BAS-3 O Worm | 56. BAS-VeloFretless | 100. GTR-Metal Head |
| 13. BAS-A Ku Stq | 57. BAS-WalkinUprite | 101. GTR-Mutant Pick |
| 14. BAS-ATC 3 | 58. BAS-WalknUprite2 | 102. GTR-Mutant Pick2 |
| 15. BAS-BadTube | 59. BAS-Walky Talk | 103. GTR-Mutes |
| 16. BAS-Brolin's 1st | 60. BAS-WalkyTalk2 | 104. GTR-Nrysty12 |
| 17. BAS-Distorto-TB | 61. BRS-Alt TptLoops | 105. GTR-Nylon |
| 18. BAS-Easy | 62. BRS-Barry Bones | 106. GTR-NyloSteel |
| 19. BAS-Finger1 | 63. BRS-Brass&Bari | 107. GTR-Nylon Silk |
| 20. BAS-Fingered In | 64. BRS-BreathTBone | 108. GTR-Nylonistic |
| 21. BAS-FingerHarms2 | 65. BRS-Centurions | 109. GTR-Spy |
| 22. BAS-Finger Out | 66. BRS-Don'sTrumpet | 110. GTR-Steel |
| 23. BAS-Finger&Harms | 67. BRS-Horny | 111. GTR-SteelReal |
| 24. BAS-Four U | 68. BRS-Huge Brass | 112. GTR-Stolen7 |
| 25. BAS-Fretless 2 | 69. BRS-MelloD'Trmp | 113. GTR-Stolen7Away |
| 26. BAS-Froggy | 70. BRS-Milez | 114. GTR-WaaKeeGa |
| 27. BAS-Homeboy E | 71. BRS-Movie Brass | 115. HIT-Brass Hits 2 |
| 28. BAS-In the Money | 72. BRS-MutedTrumpet | 116. HIT-Fashion |
| 29. BAS-Lead Bottom | 73. BRS-Soft Trumpet | 117. HIT-MasterBlast |
| 30. BAS-Metal Heart | 74. BRS-The Ensemble | 118. HIT-Organ Hits 2 |
| 31. BAS-Mini More | 75. BRS-Trmpt&Sect | 119. KBD-And Voice |
| 32. BAS-Mod da Wheel | 76. GTR-Carlos | 120. KBD-And Voice2 |
| 33. BAS-Mr. Clean | 77. GTR-Cast Teller | 121. KBD-B3 X-Wheel |
| 34. BAS-Mutation | 78. GTR-Cast Teller2 | 122. KBD-B3 X-Wheel 1 |
| 35. BAS-Plexy | 79. GTR-Chuckin | 123. KBD-Ballad Tine |
| 36. BAS-PuLs A'ting | 80. GTR-Dark Gut | 124. KBD-Bally Yard |
| 37. BAS-Q Bass 2 | 81. GTR-Distorter-X | 125. KBD-Classic EP |
| 38. BAS-Reverend JB | 82. GTR-Distorter-X2 | 126. KBD-Clav 1 |
| 39. BAS-RoundaboutT | 83. GTR-Distorter-X3 | 127. KBD-Clavinetti 1 |
| 40. BAS-SE Micro | 84. GTR-Distorter-X4 | 128. KBD-Clavinetti 2 |
| 41. BAS-Say What | 85. GTR-Dolobroso | 129. KBD-Comp Keyz 2 |
| 42. BAS-Shift | 86. GTR-Electric 1 | 130. KBD-Crystal |
| 43. BAS-SignFeld Pop | 87. GTR-Electric 2 | 131. KBD-DynofunkEP |
| 44. BAS-Simple 3 | 88. GTR-ElectricDis | |

Riff Listing

- | | | |
|-----------------------|-----------------------|-----------------------|
| 132. KBD-DynamcGrand | 176. KBD-Yo My Dynos | 220. KIT-Kit 03 d |
| 133. KBD-DynoPiano | 177. KIT-424 | 221. KIT-Kit 03 e |
| 134. KBD-E Grand | 178. KIT-Acoustic 1 | 222. KIT-Kit 03 f |
| 135. KBD-EP Roll 2 | 179. KIT-Acoustic 2 | 223. KIT-Kit 04 a |
| 136. KBD-Elecre 2 | 180. KIT-BMF | 224. KIT-Kit 04 b |
| 137. KBD-Elecro7CP80 | 181. KIT-Bag O Tricks | 225. KIT-Kit 05 a |
| 138. KBD-FM2Classc | 182. KIT-Berzerker | 226. KIT-Kit 05 b |
| 139. KBD-Filmscore | 183. KIT-Booster | 227. KIT-Kit 06 |
| 140. KBD-GenBalladEP | 184. KIT-ClassicHouse | 228. KIT-Kit 07 a |
| 141. KBD-Gospel Soul | 185. KIT-Clean R&B | 229. KIT-Kit 07 b |
| 142. KBD-Grand FM | 186. KIT-ClubVinyl | 230. KIT-Kit 07 c |
| 143. KBD-Grand Piano2 | 187. KIT-CookUsAHit | 231. KIT-Kit 08 |
| 144. KBD-Grande 4 | 188. KIT-CookUsAHit 2 | 232. KIT-Kit 09 a |
| 145. KBD-GreenEyed | 189. KIT-DerLyBeEmuD | 233. KIT-Kit 09 b |
| 146. KBD-Hard Comp 1 | 190. KIT-DeepBooty | 234. KIT-Kit 09 c |
| 147. KBD-Hard Comp 5 | 191. KIT-DeepBooty2 | 235. KIT-Kit 10 |
| 148. KBD-Hard Dyno | 192. KIT-DeepBooty3 | 236. KIT-Kit 11 a |
| 149. KBD-HonTonkeyz | 193. KIT-Disengrate | 237. KIT-Kit 11 b |
| 150. KBD-JimmyJazzyB | 194. KIT-Drum 303 | 238. KIT-Kit 11 c |
| 151. KBD-Klassical | 195. KIT-Drum Buzza | 239. KIT-Kit 11 d |
| 152. KBD-Knockkerz | 196. KIT-Drum-Bass 1a | 240. KIT-Kit 12 a |
| 153. KBD-KoolNMelo | 197. KIT-Drum-Bass 1b | 241. KIT-Kit 12 b |
| 154. KBD-Lovers FM EP | 198. KIT-Drum-Bass 2 | 242. KIT-Kit 12 c |
| 155. KBD-Med Dyno | 199. KIT-Drum-Bass 3a | 243. KIT-Kit 13 a |
| 156. KBD-Med EP | 200. KIT-Drum-Bass 3b | 244. KIT-Kit 13 b |
| 157. KBD-Mellow man | 201. KIT-Drum-Bass 4a | 245. KIT-Kit 14 |
| 158. KBD-Melosoul EP | 202. KIT-Drum-Bass 4b | 246. KIT-Kit 15 a |
| 159. KBD-Miami Grand | 203. KIT-Drum-Bass 5 | 247. KIT-Kit 15 b |
| 160. KBD-Organomics X | 204. KIT-Drum-Bass 6 | 248. KIT-Kit 15 c |
| 161. KBD-PerkyRhodes | 205. KIT-Electro | 249. KIT-Kit 16 a |
| 162. KBD-Piano&Strng1 | 206. KIT-For Real | 250. KIT-Kit 16 b |
| 163. KBD-Pure Fog | 207. KIT-For Real 2 | 251. KIT-Kit 17 |
| 164. KBD-Pure Roll 2 | 208. KIT-Gett..OutPt2 | 252. KIT-Kit 18 |
| 165. KBD-Pure Roll 3 | 209. KIT-GritKitt | 253. KIT-Kit 19 |
| 166. KBD-Rock'in B | 210. KIT-Hot Swing | 254. KIT-Kit 20 |
| 167. KBD-RollinDreams | 211. KIT-Jams | 255. KIT-OnTheTip |
| 168. KBD-Stereo Grand | 212. KIT-Kit 01 a | 256. KIT-Shag |
| 169. KBD-StereoGrand2 | 213. KIT-Kit 01 b | 257. KIT-Smackers |
| 170. KBD-StereoGrand3 | 214. KIT-Kit 02 a | 258. KIT-SounDfacTory |
| 171. KBD-Suitcase EP | 215. KIT-Kit 02 b | 259. KIT-Swing Hop 3 |
| 172. KBD-Supatramp EP | 216. KIT-Kit 02 c | 260. KIT-Swing Hop a |
| 173. KBD-TechnoUprite | 217. KIT-Kit 03 a | 261. KIT-Swing Hop b |
| 174. KBD-WheelSpeed B | 218. KIT-Kit 03 b | 262. KIT-This & That |
| 175. KBD-WideSuitcase | 219. KIT-Kit 03 c | 263. KIT-Tribal House |

Riff Listing

- | | | |
|-----------------------|------------------------|-----------------------|
| 264. KIT-Werzerker | 308. PRC-Shakers | 352. VOX-Lo-Fi Ether |
| 265. LED-Apple Eater | 309. PRC-SiameseCats | 353. VOX-MauzeWowz |
| 266. LED-Blue Danube | 310. PRC-TV Spy Vibes | 354. VOX-Mist |
| 267. LED-Ethereosity | 311. PRC-Velo Vibes | 355. VOX-New Age Oohs |
| 268. LED-Freakus | 312. PRC-Velo Vibes 2 | 356. VOX-Odd Boys |
| 269. LED-inBottles | 313. PRC-Village | 357. VOX-Pop Oohs |
| 270. LED-Post 90's DM | 314. PRC-Xylophone | 358. VOX-Slo Lunarvox |
| 271. LED-Q Snapper | 315. SFX-MetalScience | 359. VOX-Spiritworld |
| 272. LED-Quacker | 316. SFX-Oh No Its | 360. VOX-SynthSing |
| 273. LED-Sci-Fi B | 317. STR-AbbeyStrngs | 361. VOX-Voxicord |
| 274. LED-Shiner | 318. STR-AbbeyStrngs2 | 362. WAV-Lowtronics |
| 275. LED-Soft Slip | 319. STR-Allin a Pizz | 363. WAV-M12 |
| 276. LED-Weezy Lead | 320. STR-AllinaPizz 2 | 364. WAV-Metal 2 |
| 277. LED-Worm | 321. STR-ArcotremPizz | 365. WAV-VS37 |
| 278. LED-Worm 2 | 322. STR-Dyna-heim | 366. WND-A-Sax |
| 279. LED-Worm Up | 323. STR-ExtremeStrng | 367. WND-Alto Saxo |
| 280. LED-Wormwood | 324. STR-Filmscore | 368. WND-Bottle Blow |
| 281. LED-Zimppler | 325. STR-HindooKurdoos | 369. WND-Breather |
| 282. ORC-Combo | 326. STR-Japanman | 370. WND-Chambr Orch |
| 283. ORC-Orchestra | 327. STR-Kult E Vatn | 371. WND-Clarinet |
| 284. PAD-Airborn | 328. STR-Pizzicati | 372. WND-Ethnic Reed |
| 285. PAD-Ganic | 329. STR-SitarTalk | 373. WND-Fieldberries |
| 286. PAD-Highway | 330. STR-Solo Quartet | 374. WND-Flute |
| 287. PAD-Infants | 331. STR-Strg + Choir | 375. WND-Harmonica |
| 288. PAD-Infants2 | 332. STR-Swoon | 376. WND-Nuages |
| 289. PAD-MetalBeats | 333. STR-Texture | 377. WND-Oboe |
| 290. PAD-My Hero | 334. STR-TronStrings | 378. WND-Ocarina a |
| 291. PAD-Pad Life | 335. STR-Velo Marcato | 379. WND-Ocarina b |
| 292. PAD-Paddy | 336. STR-Victrola | 380. WND-Pan Flute |
| 293. PAD-Phat | 337. SYN-Bender | 381. WND-Pastoral |
| 294. PAD-Sophia | 338. SYN-Brazz | 382. WND-Real Flute |
| 295. PRC-Acidphone | 339. SYN-Ensemblist | 383. WND-Real Flute 2 |
| 296. PRC-Claves | 340. SYN-Euro Wave | 384. WND-Synth Flute |
| 297. PRC-Congas | 341. SYN-Festival | 385. WND-T-Sax |
| 298. PRC-Congas 2 | 342. SYN-Hydraine | 386. WND-Virtuaccord |
| 299. PRC-Cymbals | 343. SYN-ProfitMargin | |
| 300. PRC-Hats 1 | 344. SYN-Silk OBXsaws | |
| 301. PRC-Kalimba | 345. SYN-Sync Trance | |
| 302. PRC-Kalimba 2 | 346. SYN-Syntax On2 | |
| 303. PRC-Log On | 347. SYN-Synthall AT | |
| 304. PRC-Marimba | 348. SYN-ThinTecPulse | |
| 305. PRC-Plexitone | 349. SYN-Z&C Leeder | |
| 306. PRC-Progress a | 350. VOX-Ahhs | |
| 307. PRC-Progress b | 351. VOX-Frozen Time | |

Velocity Curves

This section provides diagrams and descriptions of the Proteus 1000 velocity curves.

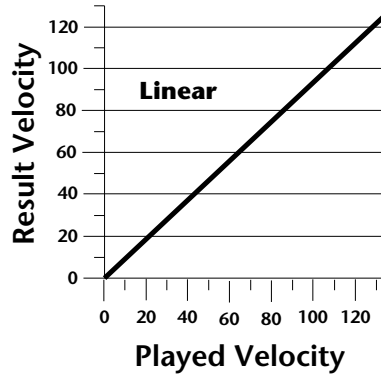

Linear, no change to velocity.

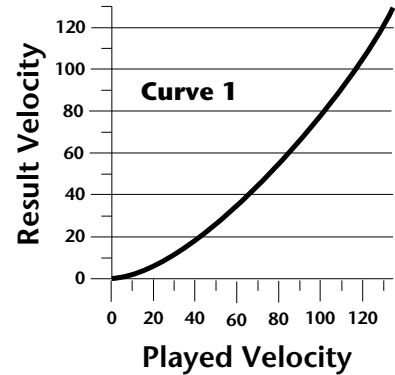

Compresses velocity range.

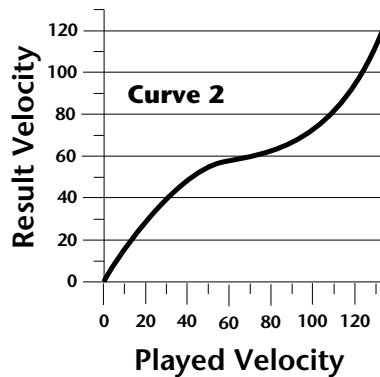

Expands dynamics in low range, emphasizing medium velocity values and compressing high velocity values.

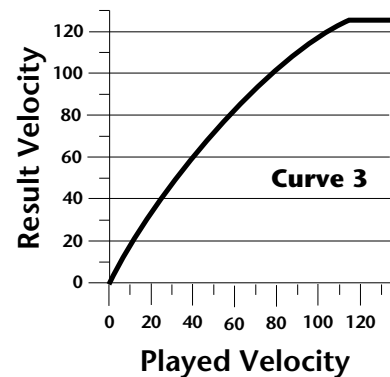

Expands velocity range. Soft -> Loud

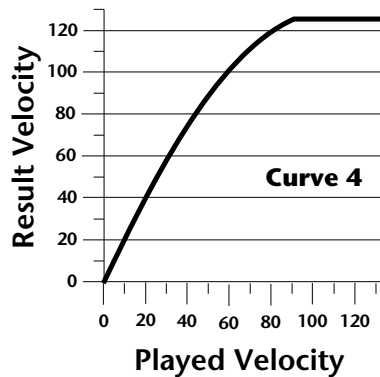

Expands velocity range. Outputs high values.

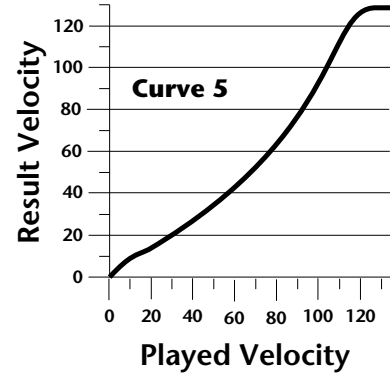

Shifts velocity values upward. Good dynamic range.

Velocity Curves

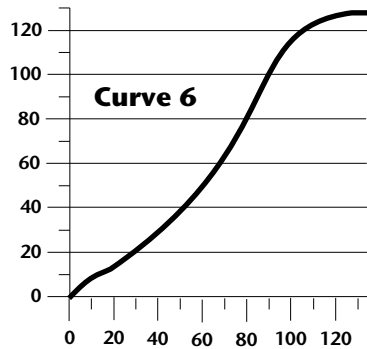

Curve 6
Shifts velocity values up while compressing the middle range.

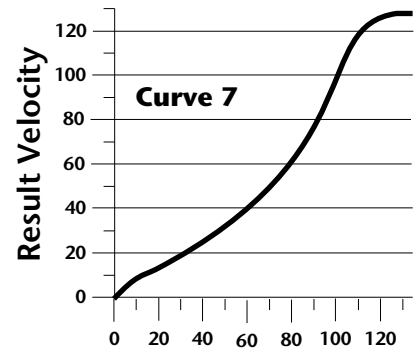

Curve 7
Similar to Curve 6.

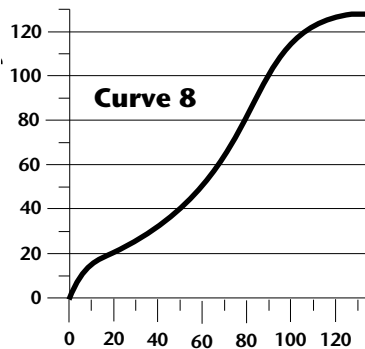

Curve 8
Similar to Curve 6 with more emphasis on the middle range.

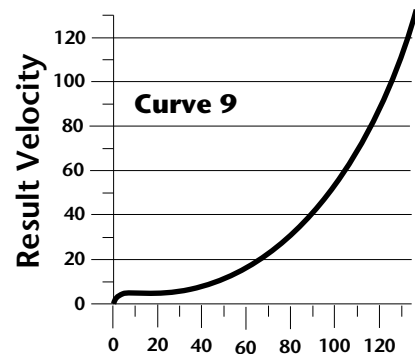

Curve 9
Extreme dynamic range compression.

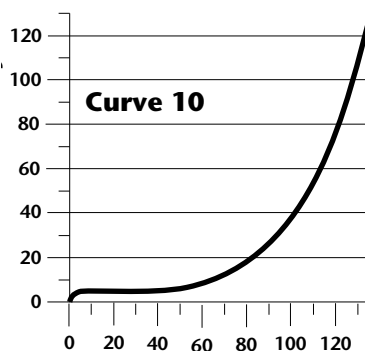

Curve 10
Extreme dynamic range compression. Outputs low values.

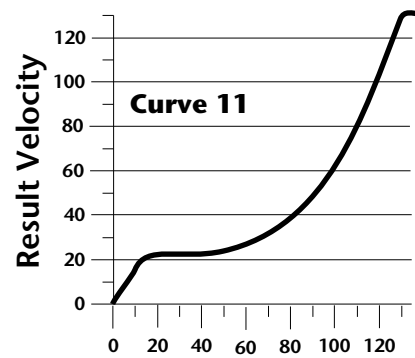

Curve 11
Extreme dynamic range compression but doesn't output low values

PatchCord Amount Chart

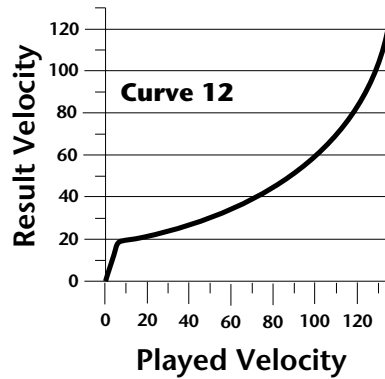

Less severe version of Curve 11.

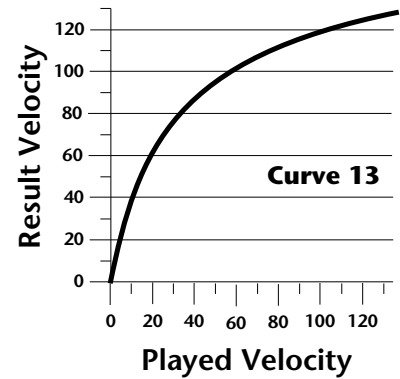

Extreme expansion of velocity range.

The following chart shows the PatchCord “Amount” settings in order to get semitone intervals when modulation sources are connected to pitch.

Semitone	PatchCord Amount	Semitone	PatchCord Amount
1	3	21	66
2	6	22	69
3	approx. 9	23	approx. 72.5
4	approx. 12	24	approx. 76
5	16	25	79
6	19	26	82
7	22	27	88
8	25	28	91
9	28	29	approx. 95
10	approx. 31	30	98
11	35	31	
12	38	32	
13	41	33	
14	44	34	
15	47	35	
16	50	36	
17	approx. 53	37	
18	57	38	
19	60	39	
20	63	40	

MIDI

MIDI Implementation Chart

MIDI Information	Transmitted	Recognized	Remarks
MIDI Channels	---	1-16	
Note Numbers	---	0-127	
Program Change	---	0-127	
Bank Select Response?	No	Yes	MSB + LSB
Modes: Omni (<i>Mode 1</i>)	No	Yes	
Mono (<i>Mode 2</i>)	No	Yes	
Poly (<i>Mode 3</i>)	No	Yes	
Mode 4 (<i>Y/N</i>)	No	No	
Multi (<i>Mode 5</i>)	No	Yes	
Note On Velocity	No	Yes	
Note Off Velocity	No	No	
Channel Aftertouch	No	Yes	
Poly (Key) Aftertouch	No	No	
Pitch Bend	No	Yes	
Active Sensing	No	No	
System Reset	No	No	
Tune Request	No	No	
System Exclusive	Yes	Yes	
Sample Dump Standard	No	No	
File Dump	No	No	
MIDI Tuning	Yes	Yes	
Master Volume	No	Yes	
Master Balance	No	No	
Notation Information	No	No	
Turn GM1 System On	No	No	
Turn GM2 System On	No	No	
Turn GM1 System Off	No	No	
Other (<i>See Remarks</i>)	No	No	
NRPNS	No	No	
RPN 00 (<i>Pitch Bend Sensi.</i>)	No	No	
RPN 01 (<i>Chan. Fine Tune</i>)	No	No	
RPN 02 (<i>Chan Coar. Tune</i>)	No	No	
RPN 03 (<i>Tuning Prog Sel.</i>)	No	No	
RPN 04 (<i>Tuning Bank Sel.</i>)	No	No	
RPN 05 (<i>Mod Depth Rang</i>)	No	No	
MIDI Timing & Sync			
MIDI Clock	No	Yes	
Song Position Pointer	No	No	
Song Select	No	No	
Start	No	Yes	
Continue	No	No	
Stop	No	Yes	

MIDI Information	Transmitted	Recognized	Remarks
MIDI Time Code	No	No	
MIDI Machine Control	No	No	
MIDI Show Control	No	No	
Extension Capability			
General MIDI Compat?	No	No	
Is GM default mode?	No	No	
DLS compatible?	No	No	
Import DLS Files?	No	No	
Export DLS Files?	No	No	
Import stand MIDI files	No	No	
Export stand MIDI files	No	No	
NOTES: Pan: -64 = hard left, +63 = hard right			

Product ID for **Proteus 1000** = 0F (15)

MIDI Device Inquiry Responses

Family

MSB 0x04 (Musical Instruments)

LSB 0x04 (ROM Players)

Member

MSB 0x00 (P2k Group)

LSB 0x02 Audity 2000	0x0C Planet Earth Turbo
0x03 Proteus 2000	0x0D XL-7
0x04 B-3	0x0E MP-7
0x05 XL-1	0x0F Proteus 2500
0x06 Virtuoso 2000	0x10 Orbit 3
0x07 Mo'Phatt	0x11 PK-6
0x08 B-3 Turbo	0x12 XK-6
0x09 XL-1 Turbo	0x13 MK-6
0x0A Mo'Phatt Turbo	0x14 Halo
0x0B Planet Earth	0x15 Proteus 1000

There is only one edit buffer which is used by the current preset (the preset shown in the display). You can edit only one preset at a time via SysEx commands, although these presets can be edited independently of the current preset edited using the Front Panel. Remote Preset selection is independent of the edit buffer. Changing the current preset erases the edit buffer.

Received Channel Commands

Channels number (n) = 0-15. Message bytes are represented in hex. All other numbers are decimal. Running Status is supported.

Command	Message	Comments
Note Off	8n kk vv	
Note On	9n kk vv	velocity 0 = note off
Key Aftertouch	An kk vv	kk = 0-127 vv = 0-127
Program Change	Cn vv	0-127
Channel Aftertouch	Dn vv	0-127
Pitch Bend	En ll mm	l = lsb, m = msb
Real-time Controller	Bn cc vv	cc = 00-31, 64-95
Footswitch	Bn cc vv	cc = 64-79, vv ≥ 64 = on
Volume	Bn 07 vv	0-127
Pan	Bn 0A vv	0=left, 127=right, 64=center
Expression	Bn 0B vv	reset by multimap selection or "Reset All Controllers"
All Sound Off	Bn 78 00	turns all sound off
Reset All Controllers	Bn 79 00	ignored in omni mode
All Notes Off	Bn 7B 00	ignored in omni mode
Omni Mode Off*	Bn 7C 00	forces all notes & controls off
Omni Mode On*	Bn 7D 00	forces all notes & controls off
Mono Mode On (Poly Off)*	Bn 7E 00	forces all notes & controls off
Poly Mode On (Mono Off)*	Bn 7F 00	forces all notes & controls off
Bank Select MSB	Bn 00 bb	bb = bank MSB (see page 82)
Bank Select LSB	Bn 20 bb	bb = bank LSB (see page 82)

* Special Notes:

- **From Omni Mode** Omni Off turns Poly On.
- **From Poly Mode**..... Omni On turns Omni On; Mono On turns Mono On.
- **From Mono Mode** Mono Off turns Poly On; Omni On turns Omni On.
- **From Multi Mode**..... Omni On turns Omni On; Omni Off or Mono Off turns Poly On; Mono On turns Mono On.
- All other changes have no effect.

SysEx Specification

Proteus 1000 contains an extensive set of MIDI SysEx commands. (*Virtually every parameter is controllable via SysEx.*) Because of the size and technical nature of the System Exclusive specification, it is beyond the scope of this manual. The complete SysEx specification for Proteus 1000 is available on the official E-MU Systems, Inc. web site: www.emu.com

Technical Specifications

Audio Channels:	64
MIDI:	MIDI In, MIDI Out, MIDI Thru
MIDI Channels:	16
Presets:	512 user presets. <i>(The number of ROM presets is determined by the sound SIMMs installed.)</i>
Filters:	6th Order (50 different types)
Audio Outputs:	2 polyphonic analog outputs, 20-bit $\Delta\Sigma$ DACs
Max. Output Level:	+4 dB
Output Impedance:	1000 Ohms
Sound Memory:	32 MB (expandable to 64 MB)
Data Encoding:	16-bit linear data
Effects Engine:	24-bit internal processing
Sample Playback Rate:	44.1 kHz
Signal to Noise:	>92 dB
Dynamic Range:	>90 dB
Frequency Response:	20 Hz - 20 kHz (+2/-1 dB)
THD + Noise:	< 0.02% (1kHz sine wave, A-weighting)
IMD	< 0.05%
Stereo Phase	Phase Coherent +/- 1° at 1 kHz
Power Consumption:	15 Watts
Voltage Input:	90VAC-260VAC at 50Hz-60Hz
Dimensions	H: 1.75 inches W: 19 inches L: 8.5 inches
Weight	6 lb., 14 oz. (3.1 Kg)

Sound Design

Samples, Sound Set & Instruments

Ed Mann

Presets

Ed Mann

Ed Dickie

Andrew Schlesinger

Alex Strudley

Tim Swartz

Audition Files

Ed Mann

Nate Tschetter

John DePatie

Kevin Woodhouse

Sam Ward & Friends

Demo Sequences

Rain Dance – Dr. Gerry Basserman

Proteus 1000 – Ed Mann

Mov'in Earth – Sam Ward

Organic – Nick Tidy

Earth Tones – Nate Tschetter

Executive Producer

Tim Swartz

Warranty

Please read this warranty, as it gives you specific legal rights.

Warranty

This product is warranted, to the original consumer purchaser, to be free of all defects in workmanship and materials for a period of one (1) year from the date of such purchase from an authorized EMU dealer, provided that (a) the Warranty Registration Card is filled out and returned to EMU within 14 days of the purchase date, and (b) the EMU service center is provided a copy of the consumer purchaser's sales receipt.

Warranty Restrictions

Specifically, but without limitation, EMU does not provide warranty service for:

- Damages due to improper or inadequate maintenance, accident, abuse, misuse, alteration, unauthorized repairs, tampering, or failure to follow normal operating procedures as outlined in the owner's manual;
- Deterioration or damage of the cabinet;
- Damages occurring during any shipment of the unit;
- Any unit which has been modified by anyone other than EMU.

No other express or implied warranty is made, and EMU specifically disclaims any implied warranty of merchantability, satisfactory quality, and fitness for a particular purpose. EMU's liability under warranty is limited to repair or replacement of the unit, or refund, at EMU's option.

In no event will EMU be liable for loss of revenue or savings, loss of time, interruption of use, or any other consequential, indirect, incidental, special or exemplary damages. The foregoing will apply notwithstanding the failure of essential purpose of any remedy provided herein. Some jurisdictions do not allow the exclusion of implied warranties or conditions, or limitations on how long an implied warranty or condition may last, so the above limitations may not apply. This warranty gives you specific legal rights. You may have other rights which vary from jurisdiction to jurisdiction.

How To Obtain Warranty Service

All EMU products are manufactured with the highest standards of quality. If you find that your unit does require service, it may be done by any authorized EMU service center. If you are unable to locate a service center in your area, please contact EMU's Service Department at (831) 438-1921. They will either refer you to an authorized service center in your area or ask that you return your unit to the EMU factory.

When returning your unit to the EMU factory, you will be issued a Return Merchandise Authorization (RMA) number. Please label all cartons, shipping documents and correspondence with this number. EMU suggests you carefully and securely pack your unit for return to the factory. (Do not send the power cord or operation manual.) Send the unit to E-MU Systems, Inc., 1600 Green Hills Road, Scotts Valley, CA 95066. You must pre-pay shipping charges to EMU; EMU will pay return shipping charges. You will be responsible for any damage or loss sustained during shipment in any direction.

3/99

Index

Symbols

- “+” modulation polarity 115
- “±” modulation polarity 115

Numerics

- 19-tone tuning 125
- 2-pole filters 76
- 4-pole filters 76
- 6-pole filters 76

A

- A effect types 143, 144
- absolute value processor 65
- aftertouch, mono 57
- algorithm
 - FXA 145, 146
 - FXB 145, 147
 - master FXA 40
 - master FXB 41
- all layers 85, 87
- alternate tuning 125
- amount, patchcord 80, 114
- amplifier 98
- amplitude 104, 132
 - envelope 99
 - modulation 56
- assign group 103
- attack, envelope 100, 109, 116, 136
- audition
 - button 17, 22
 - preset 17
 - riff 128
- auxiliary envelope 59, 109

B

- B effect types 143, 144
- balance 79
- band-pass filter 75, 105
- bandwidth 77
- bank
 - organization 19
 - select display 22
 - selecting 27
- bank number 19, 26

- basic setup 14
- basics, programming 55
- bend range 36
- breath controller 46
- button
 - control 21
 - cursor 22
 - edit menu 21
 - home/enter 23, 35
 - master menu 21
 - save/copy 22
- bypass effects 148

C

- calibration 49
- category
 - instrument 29
 - preset 29, 164
- center frequency 77
- change
 - filter type 136
 - MIDI preset 45
 - preset 19
 - the voice 129
- channel
 - arpeggiator 29
 - MIDI enable 44
 - MIDI select 26
 - pan 28
 - selection, MIDI 26
 - volume 27
- chorus 143, 153
 - width 131
- chorus, effect 153
- chorusing 101, 131
- clock
 - divisor 57
 - MIDI 52
 - modulation 63
- coarse tuning 98, 130
- comb filter 106, 144
 - effect 153
- connection instructions 14
- continuous controllers 80
- contour, envelope 57, 100
- control
 - button 21
 - data entry 23
 - effects multi mode 39
 - mode 21
 - rows 21
 - volume 21
- controller
 - assigning real-time 45
 - footswitch 46
 - knobs 25, 45, 81
 - MIDI 45, 80
 - MIDI #10 28
 - MIDI #7 27, 80
 - MIDI real-time 80
 - modes 23
 - quick edit and real-time mode 24

- real-time 21, 23
 - only mode 23
 - standardized MIDI numbers 46
 - copying
 - layers 157
 - patchcords 158
 - preset banks 159
 - preset patchcords 158
 - presets 156
 - create random preset 159
 - credits 192
 - crossfade random 58
 - crossfade, ranges 94
 - current tempo offset 128
 - cursor buttons 22
 - curve
 - velocity 37
 - volume 131
 - curve, glide 104
 - cutoff frequency 75, 133
- D**
- damping, high frequency 144, 152
 - data entry control 23
 - DC offset, example 72
 - DCA 79, 138
 - decay
 - effect A 41, 144
 - effects 144
 - envelope 131
 - deep edit mode 24, 48
 - delay 101
 - effect B 42
 - effect processor 154
 - effects 143, 144
 - LFO 112
 - master FXB 42
 - preset link 127
 - demo sequences 17
 - destinations, modulation 64, 116
 - device
 - external MIDI 62
 - device ID 43
 - dimensions 191
 - diode processor 66
 - display, viewing angle 53
 - distortion effects 143
 - distortion, effect processor 154
 - double and detune 101, 131
 - doubling 153
 - doubling, effect 153
 - dual tap, delay 154
 - dynamic filters 73
 - dynamic range 191
- E**
- edit menu button 21
 - editing
 - presets 129
 - effects
 - A type 143
 - B into effect A 150
 - B submix routing 42
 - B type 143
 - busses 141
 - by channel number 150
 - chorus 153
 - decay 144
 - delay 144, 154
 - description 152
 - diagram 118, 119, 121
 - distortion 154
 - doubling 153
 - dual tap delay 154
 - feedback 144, 154
 - flanger 153
 - FXA decay 41
 - FXA HF Damping 41
 - FXB feedback 42
 - FXB->FXA 41, 145
 - global 149
 - HF damping 144
 - LFO rate 42, 144
 - master 141, 146, 149
 - A algorithm 40
 - B algorithm 41
 - FxB->FxA 146
 - LFO rate 42
 - mode 39
 - mode, bypass 39, 148
 - multi mode control 39, 148
 - panning delay 154
 - patchcords 123
 - preset 118, 145
 - processor 141
 - programmed in the preset 118, 145
 - reverb 152
 - send amounts 141
 - sends 38, 141
 - slapback 153
 - stereo delay 154
 - submix routing, A 41, 121, 122
 - type A 40, 120, 143, 144
 - type B 42, 121, 143, 144
 - vibrato 154
 - enabling MIDI channels 44
 - enter button 23
 - envelope
 - attack 100, 109, 116
 - auxiliary 109
 - decay 131
 - example 76
 - filter 107, 134, 135, 137
 - generator 57, 59
 - mode, factory 132
 - mode, filter 135
 - release 131
 - repeating 60
 - reverberation 152
 - volume 99, 100, 131, 132
 - equal temperament tuning 125
 - errors, data transmission 50
 - expression controller 190

F

- factory
 - envelope mode 132
- Fc 107, 133
- feedback 144
 - effect 154
 - FXB 42
- filter
 - 2-pole 76
 - 4-pole 76
 - 6-pole 76
 - bandpass 75, 105
 - changing type 136
 - comb 106, 144
 - definition 74
 - dynamic 73
 - envelope 59, 107, 134, 135, 137
 - envelope attack 136
 - envelope mode 135
 - frequency 107, 116, 133
 - high-pass 74, 133
 - low-pass 74
 - mode 135
 - morph 78
 - notch 75
 - overview 133
 - parametric 77
 - pole 76
 - Q 107, 133, 134
 - swept EQ 77
 - troubleshooting 138
 - tutorial 73
 - type 133, 136
 - changing 136
 - Z-plane 78, 79, 104
- fine tuning 98, 130
- fingering glide solo mode 103
- first key 68
- flange effects 143
- flanger, effect processor 153
- flip-flop processor 66
- footswitch 14, 46, 57
- free running, LFO 111
- frequency
 - center 77
 - cutoff 75
 - filter 107, 116
- frequency modulation 56
- front panel knobs 163
- FX cords 123
- FX mode 39, 148
- FXA algorithm 145, 146
- FXA parameters 121
- FXB -> FXA 145, 146, 150
- FXB algorithm 121, 145, 147
- FXB master algorithm 41
- FXB parameters 122
- FXB submix routing 42

G

- gain processor 66
- gamelan tuning 125
- gate 57
- generator
 - envelope 57
 - filter envelope 107, 137
 - noise and random 57
 - volume envelope 99
- glide 104
 - curve 104
 - key 57
 - rate 57, 104
- global effects 146, 149
- group, assigning channels to a 103

H

- headphones 14
- high frequency damping 41, 144, 152
- high-pass filter 74, 133
- home position 19
- home/enter button 23, 35

I

- ID number
 - sysex 43
- implementation chart, MIDI 188
- initial pan position 98
- initial volume 98
- instrument 79, 129
 - category 29
 - listing 172, 173, 174, 175, 176, 177, 178, 179, 180, 181
 - selecting 88
- inverting LFO waves 62

J

- just C tuning 125
 - description 126
- just intonation 125

K

- key
 - glide 57
 - range 90
 - preset link 127
 - transpose 97
 - tuning 52
 - velocity 57
- keyboard
 - character assignments 86
 - key 57
 - layering and splitting 139
 - pressure 57
 - range 89, 90
 - splitting 139
 - transpose 97

- transpose on/off 102
 - tuning 125
 - 19-tone 125
 - equal temperament 125
 - gamelan 125
 - just C 125
 - Vallotti 125
 - Kirnberger tuning 125
 - knob
 - calibration 49
 - controller 25, 81
 - real-time control 23
 - transmit MIDI 24
 - typical functions 163
 - knob preset quick edit 47
 - knobs MIDI out 48
- L**
- lag amount 67
 - lag processor 65
 - layer
 - copy 157
 - definition 87
 - instrument 55
 - presets 139
 - selecting 87
 - legato 102
 - LFO 109
 - effect B 42
 - flanger 154
 - key sync 111
 - master FXB rate 42
 - rate 144
 - rate, effect 42
 - tricks & tips 110
 - trigger 62
 - variation 113
 - waveforms 61
 - waveshape 110
 - linking presets 127, 128, 139
 - looping envelopes 60
 - low frequency oscillator 57, 61, 109
 - delay 112
 - free running 111
 - sync 109, 111
 - variation 113
 - low-pass filter 74
 - example 76
- M**
- main screen 26, 35
 - master
 - bend range 36
 - clock
 - current tempo 52
 - modulation 62
 - effect 149
 - effects 141, 146
 - FXA algorithm 40
 - FXB algorithm 41
 - menu 35
 - menu button 21
 - tuning 36
 - melody solo mode
 - (high) 102
 - (last) 102
 - (low) 102
 - MIDI 47
 - A-H messages 23
 - bank select display 17, 22
 - channel 26
 - channel selection 26
 - clock 52
 - continuous controllers 45, 57, 80
 - controller #7 27
 - device ID 43
 - enable 44
 - external clock 62
 - footswitches 46
 - implementation chart 188
 - in 14
 - inputs A & B 15
 - knobs transmit 24, 48
 - mode 30, 43, 141
 - multi mode 43
 - omni mode 43
 - out 15
 - pan control #10 28
 - poly mode 43
 - real-time controllers 80
 - receive program change 45
 - received channel commands 190
 - receiving sysex data 51
 - recording sysex data 51
 - send sysex data 51
 - standardized controller numbers 46
 - sysex
 - send/receive 51
 - sysex data, sending 50
 - sysex packet delay 50
 - transmit, knob 48
 - minimoog, solo mode 103
 - mix output 117, 142
 - mod wheel 57
 - mode
 - control 21
 - controller 23
 - deep edit 48
 - effect bypass 148
 - effects 39, 148
 - factory 132
 - filter envelope 135
 - MIDI 43, 141
 - mono 190
 - multi 43, 141, 190
 - non-transpose 102
 - omni 43, 148, 190
 - poly 43, 148, 190
 - quick edit and real-time controller 24
 - real-time controllers only 23
 - solo 102
 - time-based 135
 - modulation
 - amplitude 56
 - clock 63

- definition 56
 - destinations 64
 - note-on 64
 - polarity 115
 - processors 65, 69
 - random 58
 - routing 114
 - sources 57, 58
 - sources & destinations 116
 - wheel 46
 - mono aftertouch 57
 - mono A-I, assign group 103
 - mono mode 190
 - morph filter 78
 - multi mode 43, 141, 190
 - control, effects 148
 - effects control 39
 - multimode map
 - send/receive 50
 - multiple trigger solo mode 102
 - multisetup 22, 31
 - button 22, 31
 - restore 32
 - saving 32
 - send/receive 50
 - multitimbral operation 30, 34
 - multitimbral sequencing 34
- N**
- naming, preset 86
 - noise & random generators 57
 - non-transpose mode 102
 - notch filter 75
 - note-on modulation 64
- O**
- omni mode 43, 148, 190
 - output
 - headphones 14
 - jack 14, 15
 - mix 117, 142
 - mono 14, 15
 - routing 117
 - overall tuning, adjusting 36
- P**
- packet delay, MIDI sysex 50
 - pan 79
 - channel 28
 - control 28
 - initial 98
 - preset link 127
 - pan L/R 28
 - panning delay, effect 154
 - parameters
 - effects 143
 - parametric filters 77
 - patchcord 58, 114
 - amount 80, 114
 - copying a 158
 - example 69
 - routing 64
 - pedal 57
 - performance controllers 57
 - pink noise, example 71
 - pitch wheel 57, 137
 - master bend range 36
 - range 117
 - pitch, shifting 130
 - pitchbend range 117
 - play solo layers 128
 - polarity
 - modulation and LFO 115
 - ramp rate 68
 - pole filters 76
 - poly all, assign group 103
 - poly mode 43, 148, 190
 - poly, assign group 103
 - portamento 104
 - power 16
 - power consumption 191
 - preset
 - architecture 87
 - audition 17, 22
 - categories 164
 - category 19, 29
 - changing 19
 - copying 156
 - editing 129
 - effects 118, 145
 - links 127, 128, 139
 - listing 166, 167, 168, 169, 170, 171, 172
 - MIDI changes 45
 - naming 86
 - quick edit 47
 - random 159
 - saving a 155
 - selecting 18, 26
 - user 51
 - preset lag 67
 - preset ramp 67
 - processor
 - 4x gain 66
 - absolute value 65
 - diode 66
 - effect 141
 - flip-flop 66
 - modulation 69
 - quantizer 66
 - summing amp 65
 - switch 65
 - product description 1
 - program change, receive 45
 - program->preset map 44
 - send/receive 50
 - programming basics 55
- Q**
- Q 75, 106, 107, 133, 134, 136

quantizer 66, 72
 example 71
 quick edit 24
 preset 47

R

ramp rate 68
 random
 creating presets 159
 crossfade 58
 crossswitch 95
 generator, noise and 57
 modulation sources 58
 range
 key 89, 90
 keyboard 89
 pitchbend 117
 velocity 92
 rate
 effect LFO 42, 144
 glide 104
 LFO 111
 master FXB LFO 42
 rate/level envelopes 59
 real-time controller 21, 23, 80
 assignment 45
 crossfading 94
 mode, quick edit and 24
 real-time crossfade 94
 receive program change 45
 received channel commands, MIDI 190
 receiving MIDI SysEx data 51
 recording MIDI SysEx data 51
 rectifier 65
 release velocity 57
 release, envelope 131
 resonance 75, 106, 107, 134, 136
 restore
 multisetup 32
 multisetup via MIDI 31
 reverb 143, 152
 envelope 152
 riff
 assignment 128
 listing 182, 183, 184
 MIDI out 48
 playing 17, 22
 ROM card identifier 18
 routing
 FXA submix 41, 121, 122
 FXB submix 42
 modulation 114
 output 117

S

safety instructions 3
 save/copy
 button 22
 menu 155
 saving presets 155

Scarlatti tuning 125
 screen
 main 26, 35
 preset select 26
 viewing angle 53
 selecting a MIDI channel 26
 selecting presets 18, 26
 send
 amount 141
 FXA 41, 121, 122
 effect 38
 preset effect 117
 sequence
 setup 34
 using multisetups in a 31
 sequencing 34
 setup
 basic 14
 studio 15
 signal path 79, 141
 slapback 153
 slapback, effect 153
 solo layer 128
 solo mode 102
 sound design credits 192
 sound navigator 29
 selecting instruments 88
 sound start 101
 sources, modulation 116
 specifications, technical 191
 split
 keyboard 127, 139
 splitting the keyboard
 using links 139
 stack
 presets 127
 stack layers 91
 standard MIDI controller numbers 46
 standard MIDI switch numbers 47
 step-by-step instructions 129
 stereo delay, effect 154
 stolen voices 103
 studio setup 15
 submix routing
 FXB 42
 summing amp 65, 66
 mod processor 65
 summing nodes 56
 swept EQ filter 77
 switch processor 65, 69
 sync
 LFO 109, 111
 synth solo mode
 (high) 103
 (last) 102
 (low) 103
 system exclusive
 device ID 43
 ID 43
 packet delay 50
 send data 51

T

- technical specifications 191
- tempo offset 128
- tempo-based 99, 132
- tempo-based envelope 60, 108
- time, master FXB delay 42
- time-based 99, 132, 135
- time-based envelope 59, 108
- transmission errors 50
- transmit MIDI, knob 48
- transpose 36, 97, 98
 - preset link 127
- troubleshooting, filter 138
- tuning 36, 98, 130
 - 19-tone 125
 - coarse 130
 - equal temperament 125
 - fine 130
 - gamelan 125
 - just C 125
 - key 52
 - keyboard 125
 - Vallotti 125
 - Werkmeister 125
- tuning tables
 - send/receive 50
- tutorial, filter 73
- tutorial, programming 129

U

- user
 - key tuning 52
 - presets 51

V

- Vallotti tuning 125
- variation, LFO 113
- velocity
 - crossfade 92
 - curve 37, 185
 - curves 185
 - key 57
 - preset link 127
 - release 57
- vibrato, effect processor 154
- viewing angle, screen 53
- voices
 - changing 129
 - stolen 103
- voltage setting 16
- volume
 - channel 27
 - control 21
 - control #7 27
 - curve 131
 - envelope 59, 79, 99, 100, 131, 132
 - initial 98
 - preset link 127

W

- warranty 193
- waveforms
 - inverting 62
 - LFO 61
- weight 191
- Werkmeister tuning 125
- wheel
 - modulation 46, 57
 - pitch 57, 137
- width, chorus 131

Z

- Z-plane filter 78, 79, 104