



APARILLO



User Manual

About	3
Quick Start	4
Tips & Tricks	8
Structure	9
Parameters	9
The Building Blocks	10
Presets	10
Sound Designers	11
Synth Page	12
Synthesizer	12
The Arpeggiator	18
LFO 1 & 2	20
FX Page	24
Envelope Page	27
Modulation Windows	28
Modulation Amount	28
Polarity Switch	28
Modulation Sources	28
Modulation Filters	29
The Orbit	33
About Screen	39
Native Kontrol Standard NKS	41
Installation	42
Windows	
macOS	42
Uninstallation	43
Windows	43
macOS	43
Authorization	43
Host integration	44
Contact	45

About

Welcome to the world of Aparillo! You have obtained a very special breed of synthesizer which will deliver powerful textural and organic sounds , extracted directly from the microbiotics of synthesis.

Aparillo is based on two interacting FM Synthesizers, capable of forming the most complex timbres. The signal generator has been enriched with fine DSP spices like Jitter, Brightness and Formant/Waveshaping, followed by a free-signalflow Filter/Spatial Comb device, flowing into a polyphonic Auto Pan, the obligatory Delay and our finest Reverb algorithm yet.

The synthesizer is mostly 16-voice-unison, meaning you can play one note at a time, consisting of 16 individual synth voices. Combined with the polyphonic double LFO which also includes FM, this brings you the complex sounds, either of the atonal or of the super harmonic kind, because there is a scale generator in there, capable of the most dramatic orchestrations or just a perfect golden ratio unison.

The Arpeggiator adds another layer to the sound, extracting synth voices on its own and playing them back by different rules, mostly based on what the LFO is doing.

And then there is the Orbit, being a one-touch macro-controller for the whole sound engine, that finally gives you unlimited control over new grounds of sound manipulation.

Enjoy Aparillo, and let the fun grow the deeper you dive into it!

Quick Start

Aparillo's output has three distinctive layers of sound: the Synth, the Arp and the Spacializer.

Leash the Arp via the **Arp** knob and **Decay** control right above the LFO display.
Calm down the Spacializer with the **Mix Fader** (FX Page).

The Synth Engine will mellow out, after initializing modulations by doubleclicking **Amount** in the modulation options (below the faders).

Synth Page

The FM engine follows the classic setup: two operators, each with a modulator and a carrier wave.

The operators' **Ratio** and **Amount** control the (dis)-harmonics of the output (Ratio) and the intensity of modulation between the modulator- and carrier-wave (Amount).

Tune sets the base pitch within a range of -4 octaves to +4 octaves.

All faders come with **16 vertical meters** in the background: a visual feedback on the respective parameter value (fader position +/- modulation) for each of the 16 voices.

OP-I and OP-II can have 3 different relationships (algorithms):

Algo 1: Independent operation of OPI and OP-II

Algo 2: OP-I modulates OP-II's carrier/ OP-II's Ratio is applied to OP-I's carrier

Algo 3: OP-I modulates OP-II / Both Ratios are added and applied to OP-I's modulator

The 3 different **harmonic modes** (next to Algo) determine the nature of the Ratio:



Off for the full spectrum of Ratio settings. Allows for exact tuning and disharmonic setups.



Quantized applies a *Farey Sequence* (a table of 80 fractions: 1/1, 1/2, 1/3, 1/4, ..., 1/20). See the Q mode as a huge scale of pre-defined ratios that are rather mathematically correct.



Harmonic: crystal-clear, state-of-the-art FM synthesis. A value range of 40 harmonic ratios.

Enter the **Modulation Options** by clicking the icons right under the faders. The basic setup is the same across all screens: Pick any of 10 Sources, choose which Voices to affect, define Amount and Bi-Polarity.



Shift is a melody generator with a scale engine to put your 16 voices to different pitches. This might be a gigantic unison spread or a scale turning a single MIDI note into a chord. Combined with modulation, Shift is a very powerful tool!

The **LFO**, as the main modulating source, gets its own Display. Each of the 16 vertical tubes represents one of the voices. The balls jumping up and down show the value of LFO 1 (bluish) and LFO 2 (yellowish). Grab the **Crosshairs** for quick access to the rates of LFO 1 (y-axis) and LFO 2 (x-axis), full LFO parameters after click below the display.

Arpeggiator

The **Arp Knob** above the central display is a dry/wet control: dial up for a pure Arp signal, down for dry.

The Arpeggiator engine creates signals of its own. It's not your typical note sequencer, more of a dynamic selector picking the raisins from the polyphonic audio dough. Imagine it like a combination of sequenced switch/envelope/VCA.

The **Decay Knob** has a major impact on the Arp's sonic character. The 16 Arp indicators will give you visual feedback on the duration of each of the 16 voices.

The Arpeggiator is triggered via an Envelope with four modes:

Threshold (for LFO 1 or LFO 2): Once any of the 16 balls crosses the threshold, the corresponding voice will be triggered. You can move the **Threshold** along the y-axis with the (dynamic) knob above the LFO display.

Collision: If the two LFOs cross each other inside any tube, the corresponding voice is triggered. Not that the (dynamic) knob now changes into **Rate**, dial up to trigger on each collision, fully down for trigger on every 16th collision.

Clock: Turns the Arp into a step sequencer – dial the **Rate Knob** up for forward, down for backward steps.

FX Page – Spacializer

The Spacializer can serve as a delay, reverb or a pitch-controlled resonator.

Its character depends on the **Spacial Range** and the dynamic **Size/Pitch Fader** for fine tuning:

Small	1 ms < Range < 250 ms
Medium	1 ms < Range < 500 ms
Large	1 ms < Range < 1,000 ms
Pitch	-24 semitones < Range < +24 semitones
Sync	1/16 bar < Range < 1/1 bar

The **Feedback** fader will build a wall of reverb but also is your entry to the weird realms of modal synthesis.

As expected, the **Mix** fader is the envoy between the dry synth/Arp signal and the wet Spacializer output.

Filter and Spacializer share a free signal flow: just click the **little** \longleftrightarrow **button**.

Envelope Page

The Envelope Page holds ADSR controls affecting the Modulation System and its Output. Each of the parameters comes with its individual modulation options (as usual after clicking the icon below the faders), here with additional settings for **Slope-Curve** and **Loop Mode**.

In the upper left-hand corner, **Envelope Mode** switches between **Unison** (for all 16 voices in sync and a monophonic envelope) and **Polyphon** for a 16-voice polyphonic synthesizer, where each voice has a different sound, most probably...

Orbit Page

A bi-polar amount control for 15 parameters across the instrument – distance based.



Activates Orbiter (see the SB logo playing ping pong?)

Move the **Orbiter object** around the cosmos for gravitational effects on the parameter amounts. Once the Orbiter enters the perimeter of a parameter object, a link between the two is established. Change the **Radius** in the **Options Menu** for each parameter object (Right Click).

The Orbiter's gravitational impact is close to zero on the perimeter, close to max near the centre. The parameter object will show its current level of affection with an increasingly impassioned animation.

Max Value of each parameter object is defined by the bi-polar **Amount** knob in the Options Menu.

Moving the Orbiter around the cosmos will affect several objects at once with ever-changing intensity. The easiest method is just grabbing the Orbiter and move it around by hand.

Learn the Orbiter

The x- and the y-axis can be remoted via MIDI knobs on your hardware.

Recording Movements



Open the **Orbiter Options** to define the **Record Mode**. The **Keyboard** icon is for Orbiter positions per MIDI note, the **Tour** icon is for mouse movements, which can run in Loop and Oneshot mode. All Orbiter memory is written with the **Record** Button to the right.

MIDI

Press a MIDI note, move the Orbiter to the position you like, press another MIDI note, move it to another position, etc. Stop Recording and your keyboard will send the Orbiter warp-jumping across the cosmos. Or just randomize the Key Recorder for random sounds all over the keyboard.

Mouse

Set the Record Mode to **Tour**. Set the **Length** to any value between 1 and 32 bars. Press **Record** and move around. For a smooth transition, stop where you started (see the grey indicator?) and stop Recording.

Random, Init & Cosmos



Initialize & Random options.

Grab anywhere in the cosmos to turn the world upside down! Move all objects at once (mirrors on the four borders.) Revert via Undo.

Tips & Tricks

1. **Shift's Q** button tunes this parameter to more harmonic output.
2. **The Filter.** The comb can produce quite some detuning effects, especially at low reso. At high resonance, some filters might ping and create pitch themselves.
3. **The Spacializer.** At small size and high feedback, it starts to ring and produce pitch. When the **Spacial Range** is set to **Pitch**, the size is connected to the pitch engine, adding tuned notes, based on the pitch you play and the spread/scale engine. With Mix fully up, you only hear what the Spacializer generates. Doing stuff on the synth page will not change too much for the sound, as it only produces the exciter waveform for a karplus-strong sound. So if you find the synth controls not really affecting the sound, check the Spacializer if it's got all the power.
4. If there are rhythms going on and they won't fit for your track, check the **Arp Trig menu**. If it's set to **Threshold** or **Collision**, it triggers not necessarily in sync. You can try to put the LFOs in sync with usual rates (1/8) and S+H/Quantize. But best would be to put the Arp to clock mode.

Structure

The GUI pretty much follows the structure of the sound.

On the [Synth Page](#), we have two FM operators, represented mainly by their Ratio and FM Amount controls (left side). In the middle, there is the LFO and Arpeggiator. To the right, we take up the sound path with Form, Jitter, Brightness, Operator Balance and Level Control.

On the [FX Page](#), you'll find Aparillo's effects engine: Filter/Specializer, Pan, Delay and Reverb.

The [Envelope Page](#) offers Envelopes and their ADSR controls for Modulation & Output.

The [Orbit Page](#) will give you The Orbit with all its magic.

Parameters

The parameters are displayed as 16 vertical meters, representing the parameter value (fader position +/- modulation) for each of the 16 voices. Most of these parameters are connected to the modulation system which consists of a modulation amount control, polarity switch, modulation source and modulation filter.

Modulation is accessible through the buttons below the parameters.

Nearly all sound parameters are controlled by the Orbit as well. The Orbit will add values to the parameters, based on their distance to the "Orbiter" object.

The Building Blocks

- Presets
- Sound Designers
- Undo/Redo
- Synth Page
- FX Page
- Envelope Page
- Modulation Windows
- The Orbit
- About Screen

Presets

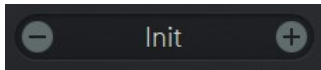

Presets are accessible via the preset menu in the top area of the interface.

You can easily step through the presets with the Minus (-) and Plus (+) button. Click on the preset's name to open the preset folder and file structure and to access to the **User folder**.

Use the **'Save Preset'** entry for saving presets. It automatically saves the preset into the User folder.

Aparillo comes with more than 450 presets. They are sorted into categories like Bass, Pads, Leads, etc., but there's also one folder called "Starters" to support your first steps.

Presets saved in the **MIDI Programs folder** can be recalled via MIDI program change messages. The preset number is the program change number.

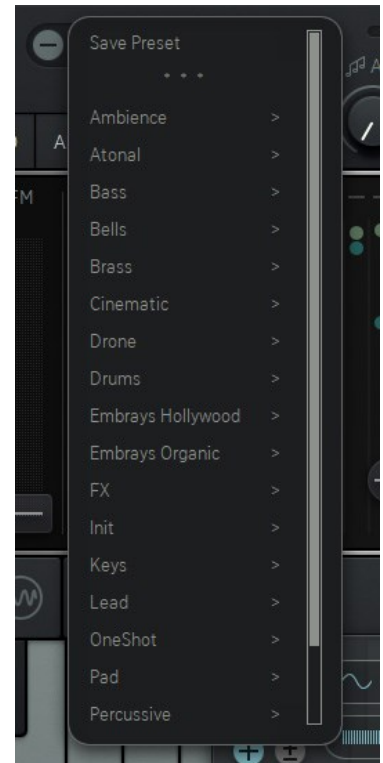

Sound Designers

Aparillo was developed together with the sound designers. Their love for Aparillo showed in a record-breaking number of presets being sent in, which gave us the opportunity to cherry-pick only the awesome ones. Still, Aparillo ships with nearly 500 unique sounds, varying from blasting synths to most complex environments.

The letters in the end of each preset name represent the name of the sound designer:

SB	Sugar Bytes
DF	DavidF
VN	VANE
KPR	Klaus P. Rausch
MA	Mikael Adle
RM	Ryn Manning
VB	Vincenzo Bellanova
CCT	Christian C. Thompson
PLGRND	Plaeground
EV	Empty Vessel
ML	Mads Lindgren
ET	Ed Ten Eyck
RAY	Embrays
DS	Daniel Stawczyk

Undo / Redo function



These buttons (in the header) reset or redo your last operating step.

Synth Page



Synthesizer

- Ratio OP-I
- FM Amount OP-I
- Ratio OP-II & FM Amount OP-II
- Shift
- Tune/FM Mode/Arp Trigger settings
- Form
- Jitter
- Brightness
- Operator Mix
- Level

The Synthesizer is placed on the first page and the controls are marked with light blue faders and it basically consists of a 2-operator FM units - Operator I (OP-I) and Operator II (OP-II) - with granular jitter, waveshaping, feedback, operator crossfade and three grades of complexity.

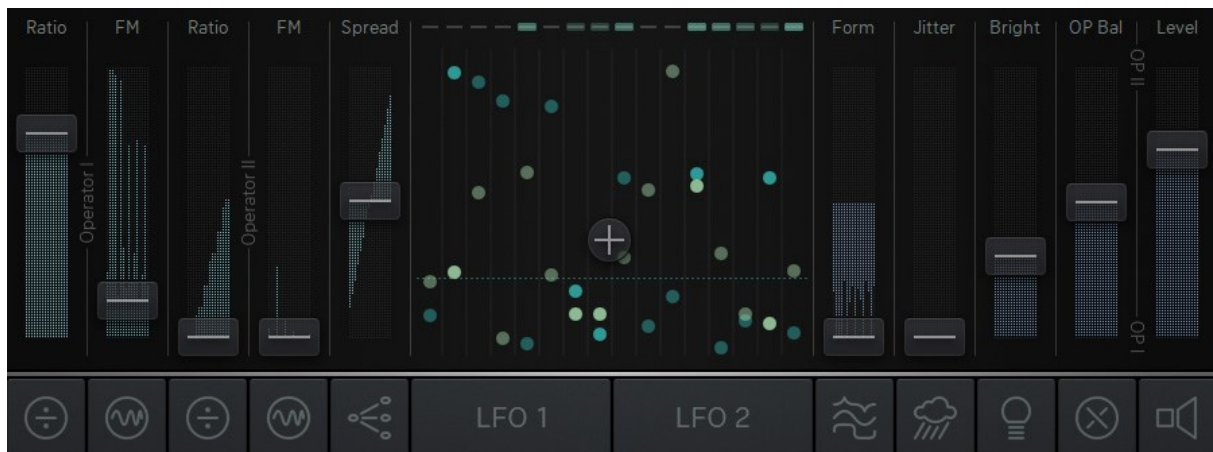

Ratio OP-I

Determines the pitch of the Phase Modulating oscillator, in relation to the incoming pitch. At a ratio of 2:1, the modulating oscillator is running at double speed, compared to the slave/carrier oscillator (the one you hear).

The higher you raise the fader, the faster the Phase Modulation will be. The numbers above the fader give you hints for harmonic ratio settings.

In this model, we use sine waves as usual, but the Formant can distort these sines exponentially or logarithmically, in the modulation path as well as in the audio path.

If the meter is moving on its own, the fader is modulated either by the modulation system or by a moving Orbiter. The Orbiter handles Ratio I & II in one control.

Click the button below the Ratio OP-I fader to open the Modulation Window, choose from different modulators and curves, fit them with Amount and Polarity and filter the voices.

FM Amount OP-I

The second fader on the synth page controls the FM Amount of Operator I.

The FM Amount is the intensity of Phase Modulation provided from the modulator to the carrier osc (the one you hear). FM Amount OP-I/II share the same Orbit object.

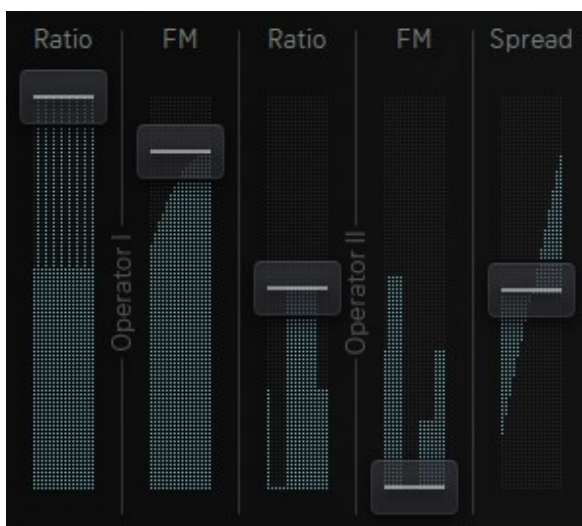

Ratio OP-II & FM OP-II

Work exactly as the controls for OP-I, but they have different impact depending on the selected FM Mode.

Pitch Generator: Shift

Let's stay on the synth page and move to the center. There we have the Shift control. This is one of the most powerful controls, as it puts your 16 voices to pitch. Think of the Shift control as 16 detune-faders for your unison (or polyphonic, but that comes a little later) synth voice.

The Shift modulation system differs from the others. While you have the usual modulators with mod-amount and polarity, there are different filters, differing from unison, about scales, to a user definable table.

Shift works bipolar, and so it utilizes the scale in a bipolar way.

If Shift is above 50%, the scale will be used as you see it.

If the Shift is below 50%, the scale will be used in a negative way, subtracting the given intervals from the given pitch.

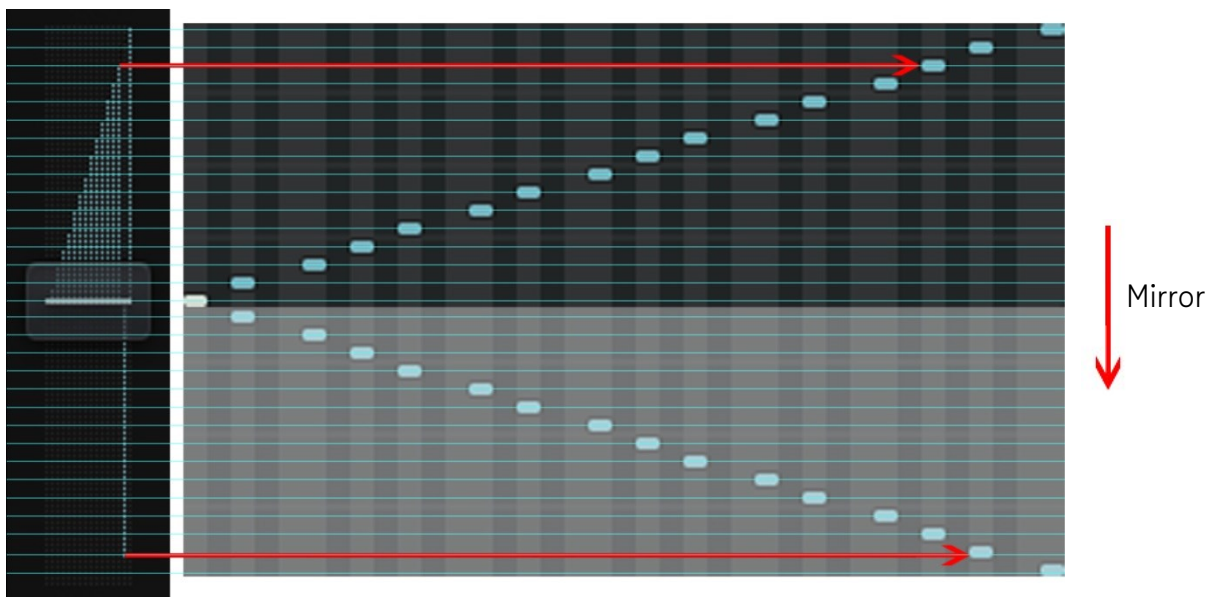

(For unison effects, it is important to pitch the voices up and down, so that you have no audible change in the recognized pitch.)

Tune/FM Mode/ Arp Trigger settings

Tune	FM Mode	Arp Trig
0 0.00	Algo 1 	Clock

Tune

Octave

The octave control sets the base pitch of the oscillators in octave steps. The range of this control is from -4 octaves to +4 octaves.

Fine tune

Both oscillators will be fine-tuned to each other, so the one up and the other down.

FM Mode

The different FM Modes represent a twist in the FM signal flow.

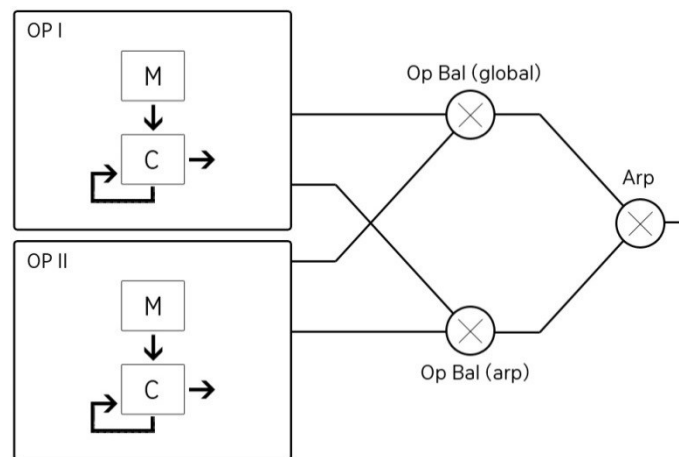

The audio outputs of OP-I and OP-II can be mixed using the OP Bal control. The Arp has an individual OP balance control, so you can have a completely different sound coming from the Arp.

Algo 1

Here we use OP-I and OP-II as individual pairs, not affecting each other.

Algo 2

Gives a glance at the complexity of FM Synthesis, as we now use OP-I as modulator for OP-II, bypassing the internal modulator of OP-II. The Ratio of OP-II is now applied to the carrier of OP-I.

Algo 3

Here we also use OP-I instead of OP-II's modulator, but we apply Ratio2 to OP-I modulator, resulting in much more harmonic variety, but also some chaos.

[Back To Table of Content](#)

Take your time when setting and modulating these controls, as lots of interesting timbres are covered here.

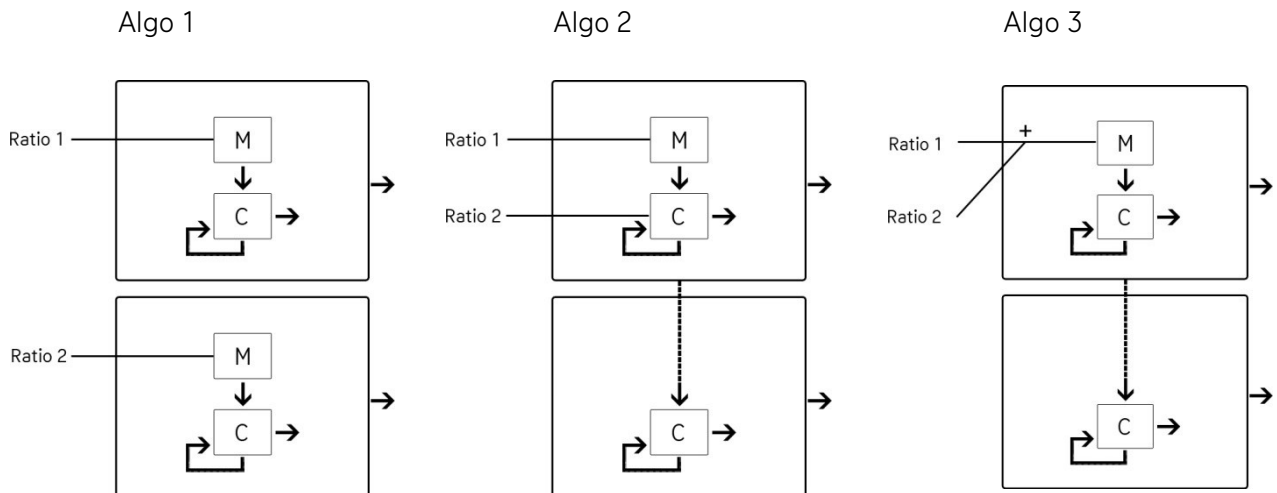

Harmonic modes



When turned to off, we handle the ratio as an un-quantized parameter. This makes it possible to be really unharmonic and enjoying the fun of dialing in an exact ratio or whatever pleases your ears.



Quantize the parameter by applying a Farey Sequence to the ratio, which basically is a big table of 80 fractions ($1/1, 1/2, 1/3, 1/4, \dots, 1/20$). See the Q mode as a huge scale of pre-defined ratios that are rather mathematically correct.



Here we use a table of 40 harmonic ratios, and additionally we apply the ratio to modulator and carrier as further fractions, resulting the crystal clear sound of state of the art FM synthesis.

Now we jump over to the right section where we can take up the sound path with **Form**, **Jitter**, **Brightness**, **Operator Balance** and **Level Control**.

Form

To make the FM Engine a little bit more interesting, the sine oscillators are treated with the form parameter. It actually houses two waveshaping effects, which can be applied to the operators independently. So these effects do not only provide sound design qualities on their own, they also have influence on the fm itself, leading to very new and unheard sounds.

Formant

This makes the form parameter shift the formants of the operators waveforms in complex mode, that means you can use formant shifted sounds as fm modulator.

Shaper

This will put the form control to shaper mode, where it will narrow the waveform in the upper half, while broadening the waveform in the lower half.

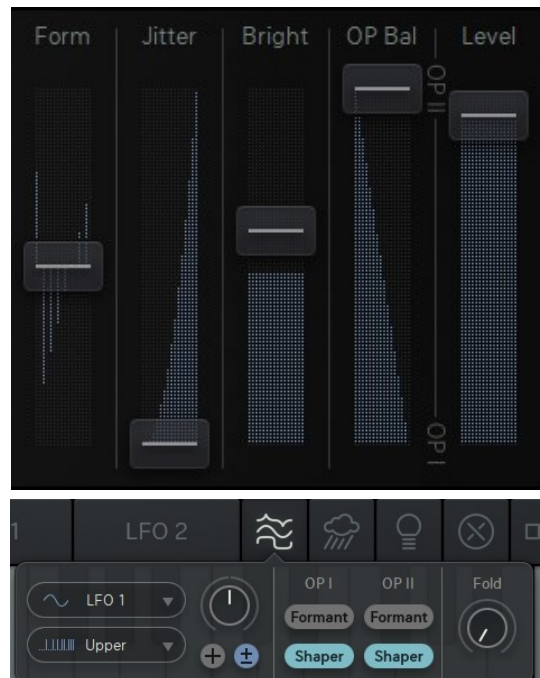

From its modulation system you can decide whether you want to apply Formant, Shaper or both for each OP separately.

In [Algo 2](#) and [Algo 3](#) mode, the shaper of OP-I also applies to the modulator signal.

Fold

The waveform is boosted and sent through a sine function which will then fold the signal around, generating lot of harmonic overtones.

Jitter

We took some jittering from the granular shelf, as it turned out to be a bit more interesting than usual noise. The jitter will add a little random number to each oscillator's phase, so that eventually each waveform has its very own frequency. This results in a rather granular noise, which is not replacing the original sound as much as usual noise.

Brightness

This is the feedback path of the FM circuit. Turning up the brightness reshapes the final waveform to sawtooth, providing more harmonics and a rather "conventional" synthesizer sound which the filter is naturally starving for.

Operator Mix (OP Bal)

As we have 2 operators working, we need a mixer to put them together, and here we are: The OP Balance crossfades between OP-I (bottom) and OP-II (top).

Level

This is the Master Level control, but it can also be put to modulation mayhem.

The Arpeggiator

Like a crown on the LFO sits the Arpeggiator, which is a neat little engine that works together with the LFO to pick and play a selection from the available 16 voices.

Technically, it picks the 16 oscillator voices and plays them with an individual decay envelope. Therefore, the 2 operators can be mixed individually and the arpeggiated audio can be mixed with the polyphonic audio.

So the Arpeggiator is not what you are used to, like a note sequencer, it's rather a sequenced switch/envelope/VCA combination that creates an individual monophonic audio signal from the already existing polyphonic audio signal.

Arp knob

This very first control in the Arpeggiator crossfades the original audio signal (dial down) with the arpeggiated audio signal (dial up).

Arp Trigger menu (Arp Trg)

The Arpeggiator has 16 voices to choose from. This is done with an envelope which pulls up the level of certain voices. The envelope must be triggered on a voice to make that voice be heard.

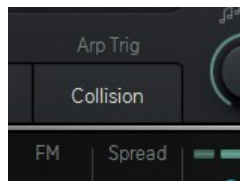
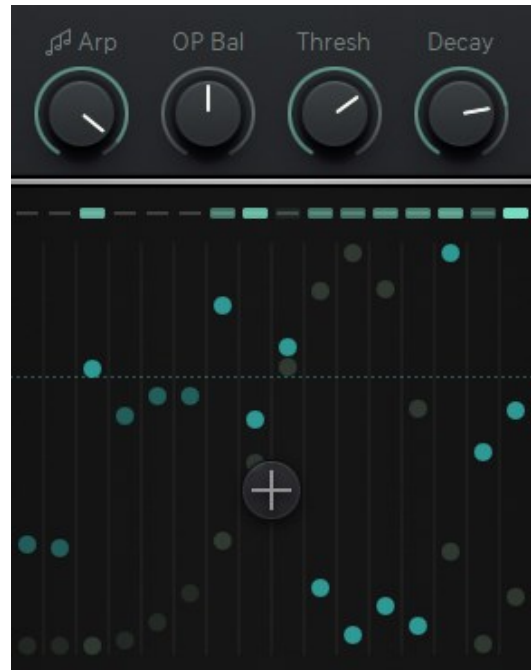

The Arp Trig menu offers 4 modes to trigger the envelope. In each of these modes, the third parameter (rate or threshold) changes its dedication.

These are the 4 modes available in the Arp Trig menu:

Threshold LFO 1 (blue)

Here we set the threshold for triggering the Arp by the voices of LFO 1. If a voice of LFO 1 crosses the line, this voice will trigger the Arp envelope and the voice will be heard.

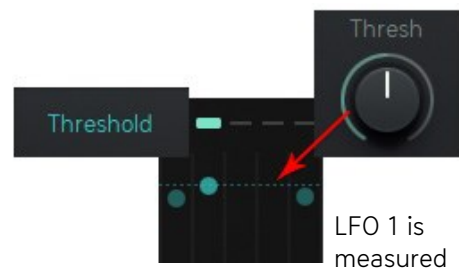

Threshold LFO 2

Here we set the threshold for triggering the Arp by the voices of LFO 2.

[Back To Table of Content](#)

Collision

If LFO 1 and LFO 2 voices are crossing each other, a trigger will be generated. Here the 3rd control is named RATE, as it will skip triggers when the parameter is not at 100%, playing each 16th trigger at 0%.

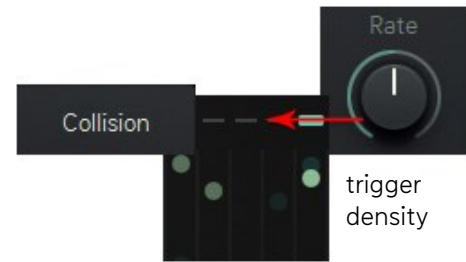

Clock Mode

Here the 3rd control is named Rate, as it sets the Arp clock speed (always in sync with host bpm). The Rate control works bipolar, so that the Arp can run forward(cw) or backward (ccw) or not at all (center).

The [Global Settings](#) of Aparillo provide two different [Collision Methods](#) to cover all possible aspects for measuring an LFO-voice with either the threshold or another LFO-voice.

What we have learned is that the Arpeggiator can trigger more than one voices at once, if not in clock mode, and that it produces sound that can be mixed with the polyphonic synthesizer signal.

OP Bal

Here we create a mix of the OP-I and OP-II audio signals, especially for the Arp. That means: your polyphonic OP Balance (Operator Mix) on the main synth page can have a different sound than the OP Balance setting of the Arpeggiator.

Rate/Threshold

The Rate/Threshold control depends on the [Arp Trigger mode](#).

Decay control

The Arp selects voices from the polyphonic audio stream, using its own envelope. Set the decay time of that envelope here. The envelope is triggered by different events, selected by the Arp Mode Switch.

The Arp displays blink up when a trigger is received and they fade out according to the decay time. That makes it easy to see what is going on in your voice trigger setup.

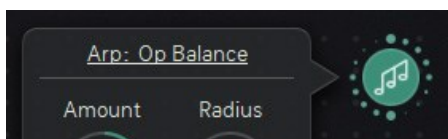

In the Orbit, these four Arpeggiator controls can be selected in the Arp Object window as a modulation target.

LFO 1 & 2

There are two complex LFO circuits running in Aparillo, these were the initial backbone of the product idea. While 16-voice unison FM provides a lot of possibilities already, the LFOs will put these 16 voices at work and make them dance, at least with your intentions being paid attention to.

The LFOs are interconnected with phase modulation from LFO 1 to LFO 2, but there are more differences, as we will find out, following their slightly different parameter sets.

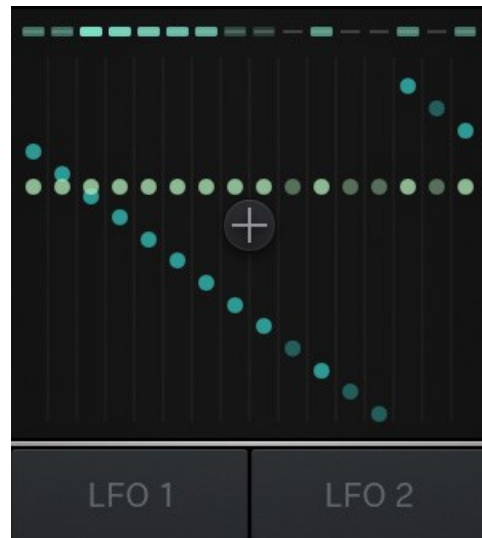

Hit one of the LFO buttons below the [LFO window](#) to open the LFO controls:



Waveform (Direction)

There are 3 waveforms available. Linear Up, Linear Down and Sine.

Oneshot/Loop

The LFO can repeat its waveform forever in Loop mode (grey straight arrow), or it will do the waveform just once, just like an envelope (lighting straight arrow).

Retrigger

There are 3 retrigger-options available to define the LFO restart behaviour:

MIDI

The LFO will restart with a MIDI Gate

Free

The LFO will not be restarted

Collision

An LFO-voice restarts on Collision with the respective voice of the other LFO

Rate

The Rate determines the speed of the LFO and is connected to the Crosshairs in the LFO Window (LFO 1 vertical, LFO 2 horizontal).

The Rate of LFO 1 is always in sync with your BPM and goes from 1/64 up to 4/1 bars. The Rate of LFO 2 is also in sync with your BPM but goes from zero (to be fully controlled by PhM) to 16/1 bars.

Rate Jitter

The Rate Jitter will create 16 individual LFO frequencies.

The control works like a crossfader for two jitter modes.

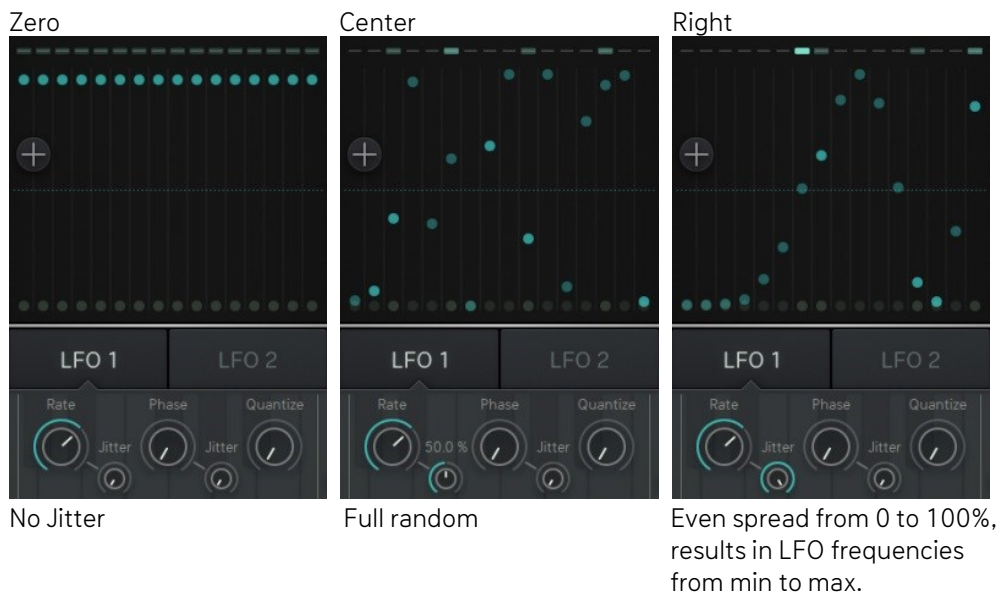

Phase Jitter

Works exactly like the Rate Jitter.

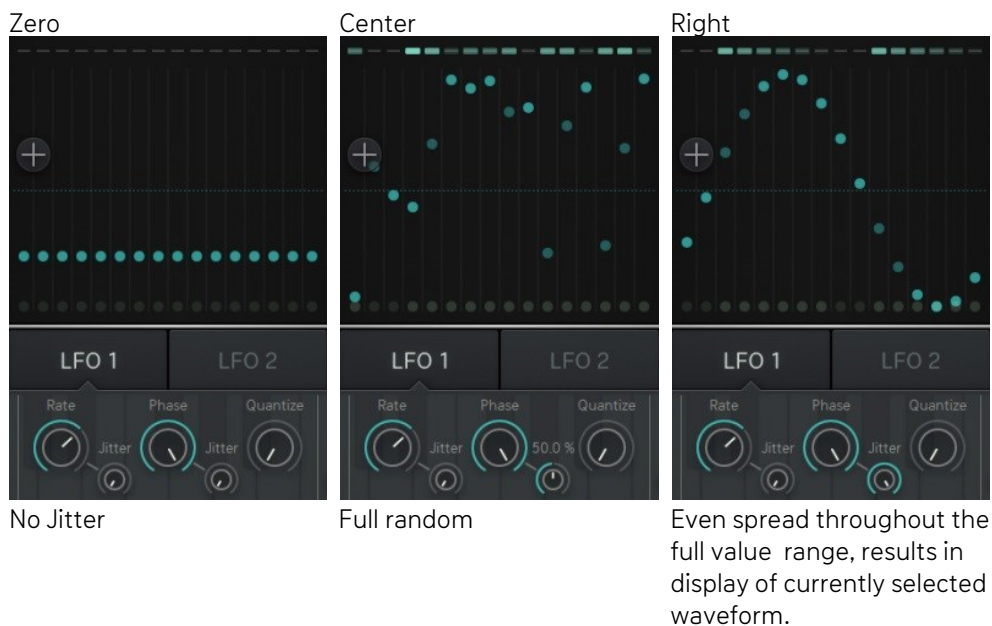

Phase (LFO1)

Use the Phase control to determine the starting point of your LFO. Easiest way is to retrigger the LFO repeatedly while turning the Phase control to find the Phase that fits your needs. Or just wiggle the Phase control until the LFO sounds right for you.



PhM (LFO 2)

Use this control to determine how much LFO 1 is affecting the Phase of LFO 2.

As you raise the control, more portion of LFO 1 will be added to LFO 2, making it quicker and providing complex waveforms.



Quantize (LFO 1)

Use the quantize control to turn LFO 1 into a stepped modulator. The higher you raise the knob, the bigger the steps will be, resulting in less variety of output values, but with a rhythmical aspect, due to the jumping values.

S+H (LFO 2)

A Sample and Hold circuit is used to turn LFO 2 into a stepped modulator.

The S+H control sets the sampling rate. At this rate, LFO 2 will produce output values that have been sampled from its original output. The sampling rate is always in sync with your bpm and ranges from 1/32 to 1/1 bar.

Gravitation

Gravitation will reduce the LFO amplitude over time, while increasing the frequency, until it reaches zero/phase.

Depending on the LFO loop mode, the Gravitation will start again in Loop mode and go to rest in oneshot mode.



The time of the Gravitational effect can be set with the bipolar Gravitation control.

Below the center mark, the Gravitation will be negative, resulting in an LFO wave that rises from zero to its maximum value, depending on the Phase setting.

Above the center mark, the gravitation is positive resulting in an LFO that starts at its max value and is bouncing down to phase.

The little button besides the Gravitation control toggles the feature on or off.

LFO window

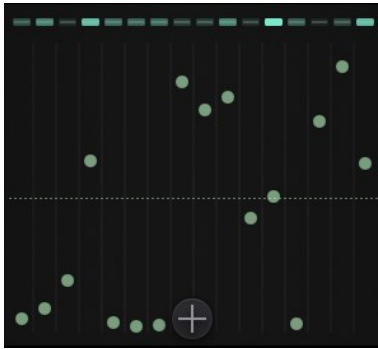

The window is sliced into 16 tubes, in which the LFO-dots and the Arp-indicators are positioned.

The 16 balls represent your 16 voices, and their graphics work as follows:

Arp indicator

Here you can watch your Arp triggering the voices. Arp decay will do a longer fade out time on those lamps, providing visual feedback of uprising polyphony by overlapping voices.

LFO-dots



These dots represent the position (i.e. value) of an LFO-voice. LFO 1 is blueish, LFO 2 is yellowish.

The Dots light up when their LFO voice is triggered.

Crosshairs



The Crosshairs is used to control LFO 1 and LFO 2 Rate simultaneously and also displays the current rate setting and automations.

Keep in mind !

LFO 1 differs from LFO 2, which is an FM-slave to LFO 1.

LFOs can be stepped and that they can retrigger in funny ways using the Collision trigger.

The gravitation is something very special and will be your friend on a travel through sound.

FX Page



Here we do the post processing, final shaping of the sound.

Filter

The multi-mode filter provides a broad variety of filter types, including unusual ones like the dirt filters or the vowel filter. The filter is also connected to the modulation system in the usual fashion (refer to FM amount modulation) and also to the Orbiter, with individual Orbit objects for cutoff, cutoff mod amount and resonance. The dirt filters can be used to provide the sound with more fatness, less clarity and buzzing overtones.

Lowpass

Cuts off high frequencies according to the cutoff frequency.

LP 4 Silk

Four pole lowpass filter based on the oberheim paradigm.

LP 2 Sat

Two pole state variable filter with saturation.

LP Dirt

Two pole lowpass filter based on the oberheim paradigm but with a very hot internal distortion and some other magic.

BP Bandpass

Cuts off low and high frequencies and passes thru the cutoff frequency.

BP Silk

Two pole bandpassfilter based on the oberheim paradigm.

BP Sat

Two pole state variable filter with saturation.

BP Dirt

Two pole bandpass filter based on the oberheim paradigm but with a very hot internal distortion and some other magic.

Highpass

Cuts off low frequencies according to the cutoff frequency.

HP Silk

Two pole highpass filter based on the oberheim paradigm

HP Sat

Two pole highpass state variable filter with saturation

HP Dirt

Two pole highpass filter based on the oberheim paradigm but with a very hot internal distortion and some other magic.

Special

Peak

Creates a peak at the cutoff frequency without losing original audio.

Comb

A feedback delayline with delaytimes according to the cutoff frequency. Should be used with high resonance.

Vowel

Sugar Bytes' famous Vowel Mode delivers a powerful 'talkbox' sound, making the output signal sound like it's being spoken.

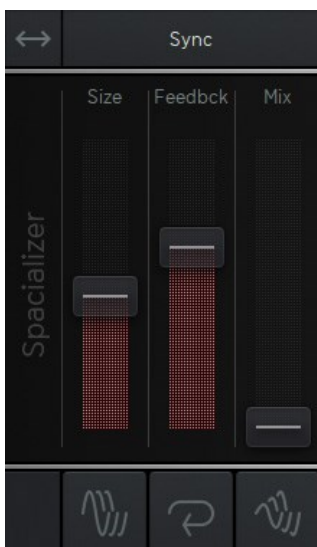

Spacializer

This is a very special breed of delay based effect, which can work as a delay, reverb or tuned comb filter. Here you can add room, plucked strings or even pinged percussion to your sound.

Modulation works in the usual Fashion (refer to FM amount modulation), Feedback and Dry/Wet Mix are represented by individual Orbit symbols.

Filter and Spacializer share a **free signal flow**, so you can run the filter first (recommended), sending damped material to the Spacializer, or run the Spacializer first to play with filtered artefacts created by spacial size modulation. Just click the little \longleftrightarrow button to switch the signal flow.

Spacial Range

This menu provides different timebases for the delay that the spacializer is based on. There are 3 free time bases from 1sec via 500msec to 250msec, plus a pitch based and a host bpm based time table.

Use the large size for delays, the med size for reverbs and the small size for resonators/percussions with 16 modal frequencies.

Use the pitch mode to have polyphonic bongos tuned to the instrument pitch, or use sync mode to have a mighty synced 16 taps delay. In either mode, the spacializer effect provides a wall of sound.

Large

1 sec

Medium

550 msec

Small

250 msec

Pitch

Based on the current pitch (-24/+24 semitones)

Sync

Based on the host bpm

Panner

Here we move from “mono polyphonic” to “stereo monophonic”.

We spread the voices in the stereo field, then combining them to a stereo audio stream.

The Panner offers 4 function generators (panner waveforms) , Rate and drywet mix.

Sine



The 16 voices are facing a sinusoid level modulation forming a nice and smoothing wave.

Sine S+H



The sine wave is sampled at certain intervals.

Random



Random values arrive at the given rate.

Continuous random



Random waveform LFO

Delay

A small delay circuit with saturated feedback path and always in sync with your bpm.

Reverb

A new reverb that delivers a rich and warm cloud, but also nice and defined rooms.

We shrunk it down to 2 controls though. The Panner, Delay and Reverb controls are not connected to the [Modulation System](#), while still being represented in the [Orbit](#).

Envelope Page



While we find the modulation and level envelopes here as well as Arp and LFO for convenience, this page contains a very important setting:

The Envelope Mode

Unison

The envelopes work monophonic, providing the standard Aparillo case: One note plays 16 voices at once.

Polyphon

The envelopes represent a 16 voice polyphonic synthesizer, where, due to the special nature of Aparillo, each voice most probably has a different sound.

The Modulation System for the modulation and amplifier envelope comes with the standard modulation sources and filters as well as a slope parameter and AD loop feature (for sustain).

The output volume level is usually modulated by the amplifier envelope (**Vel** disabled). The maximum modulation envelope as well as the maximum amplifier envelope can be determined by velocity (**Vel** enabled).

[Back To Table of Content](#)

Modulation Windows



Choose from different modulators and fixed curves, fit them with amount and polarity and filter the voices. The modulation options are accessible through the buttons below the individual parameters.



The upper menu selects from different Modulation Sources.

The lower menu offers filters for the 16 modulation voices.

Modulation Amount

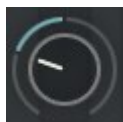

Works as an Attenuverter. Being a bipolar control, it can add or subtract the modulation from your fader value.

Polarity Switch



Decide if your modulation is **unipolar** or **bipolar**.
Use the fader position as its minimum or maximum (uni) or if it works above and below the fader position (bi).

Modulation Sources:

LFO 1

Modulation comes from LFO 1

LFO 2

Modulation comes from LFO 2

LFO RM

Both LFOs ring-modulated (multiplied)

Mod Env

Modulation Envelope (the left one on “ENV” Page)

Arp Env

The Decay envelope of the Arpeggiator

Up

Linear upward Curve (Play with amount and polarity with these curves!)

[Back To Table of Content](#)

Down

Linear Downward Curve

Exp

Exponential Upward curve

Log

Logarithmic Downward curve

Flat

Just a Flat Offset (good use with the mod filters)

Lin

Linear Curve (for spread)

M-Wheel

Assigns the MIDI modulation wheel to define the modulation depth.

P-Wheel

Assign the Pitch bend wheel to define the modulation depth.

Velocity

The modulation level will be determined by velocity.

Modulation Filters:

ALL

No filtering

Even

Only even numbered events get through (2,4,6,8...)

Odd

Only odd numbered events get through (1,3,5,7...)

Third

Each third event gets through(1,4,7,10,13...)

Lower

More lower than upper events get through (1,2,4,6,9...)

Upper

More upper events get through (4,7,9,11,12,13...)

5-7-12

Events are Quantized in 5th, 7th and octaves

Octave

Events are quantized in octaves

On the Envelope tab the modulation system of attack, decay and release additionally offers a slope parameter.

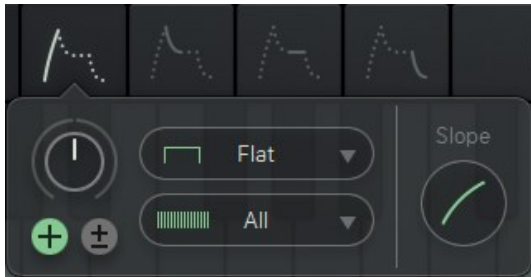

Slope-Curve

With Slope you can define the fading curve. A higher Slope value results in a larger controlling range for the parameter while a lower value does the opposite.

To alter the curve value click the curve from the slope window and drag the mouse up or down.

The modulation system of the sustain parameter comes with an **attack-decay loop mode**.



Loop Mode

When AD-Loop is disabled (grey circle arrow) it acts like an ordinary ADSR envelope.

When AD-Loop is enabled (lighting circle arrow) the envelope acts like an LFO. It repeats the phase between attack and sustain as long as a note is hold and as the attack phase was once run through. The envelope releases only after the note is released. The phase ends at the sustain level and starts from zero.

The Shift modulation system differs from the others.



While you have the usual modulators, there are different filters, differing from unison, about scales, to a user definable table.

Unison

The Shift fader will introduce a nice unison curve, based on the golden ratio

Sine

The Shift fader will introduce a sine curve

Minor

Generates a natural minor scale

Interval: 1 2 \flat 3 4 5 \flat 6 \flat 7

Major

Generates a major scale

Interval: 1 2 3 4 5 6 7

Minor 5

Minor Pentatonic Scale

Interval: 1 \flat 3 4 5 \flat 7

Major 5

Major Pentatonic Scale

Interval: 1 2 3 5 6

Aug

Interval: 1 \flat 3 3 5 \sharp 5 7

Dim

Interval: 1 2 \flat 3 4 \flat 5 \sharp 5 6 7

Whole

Generates an interval of whole tones



The USER Scale

The User Scale offers 16 horizontal sliders and a 36-note range to transpose the 16 individual voices. Use the editor to define your own scales, from your personal drone-unison-seed, to the tricky scale that puts out that one special melody.

The Scale-Editor can always be modified, so you can make your own edit of a factory scale and it will be saved and recall normally. Bringing up another scale however, will destroy your work.

If you copy your Scale to the User Table, you can leave it there while trying out other factory scales, and you can copy and paste it from/to another preset.



Q Button puts the faders to quantized mode for easy pitch assignments.

Copy button is used to copy the currently shown scale.

Paste button is used to paste into the user scale editor.

Right click to initialize.

Shift Mode: Shift+Click for horizontal linear spread and vertical shift.

The Orbit

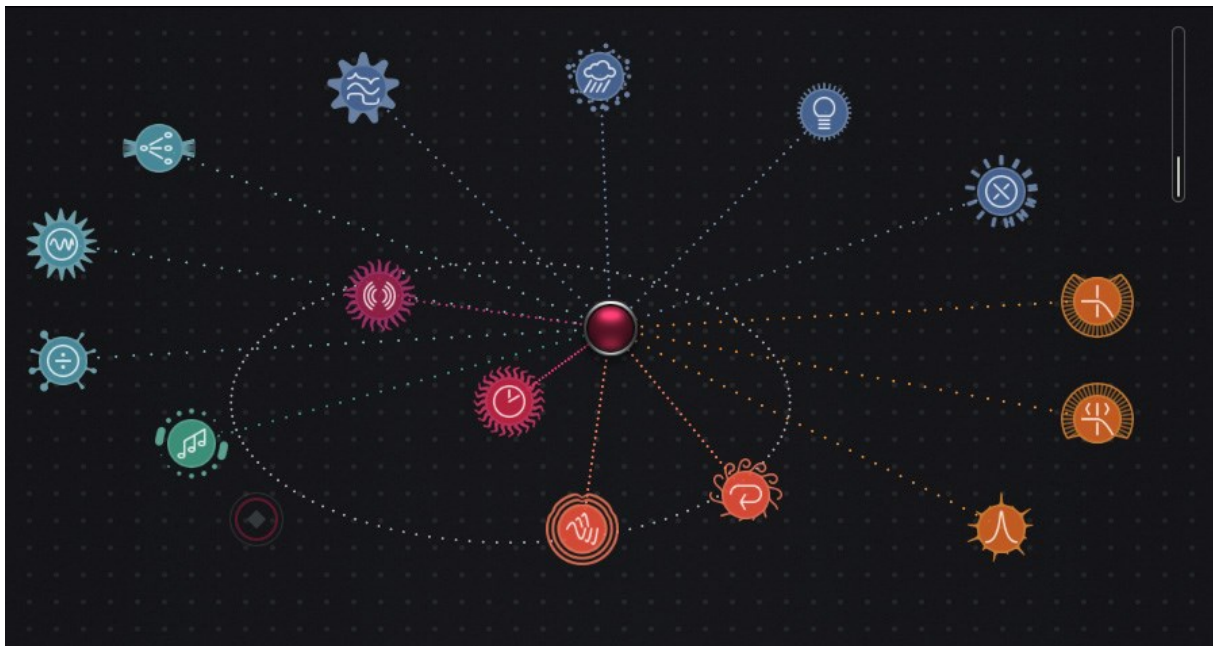

Hit the Orbit Tab in the top right corner below the SB icon to open the Orbit Page.

Aparillo has become a pretty complex sound engine and we had to take it back to where it started! An easy to use unicorn of a synth which produces lots of sounds with few controls! That's when we came up with **the Orbit**.

The red **Orbiter object**  measures its distance to **15 parameter objects**.



So, the Orbiter object is one control giving you access to 15 parameters at once, based on distance. Move it around and you will see how it connects and disconnects to the parameter objects.

The **circle** shows the current radius of your object.

The **dotted line** indicates that the Orbiter object is within your radius and shows the connection to the Orbiter.

The object will draw an **animation** if the Orbiter is in radius, and the animation will become faster as closer as the Orbiter comes to the object.

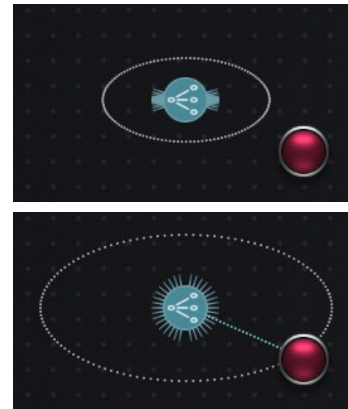

Orbit Headline



The Orbit headline gives you choices on how you would like to use the Orbit.

Click the  button to access the synth engine.

If the SB icon in the top right corner is moving, the Orbit engine is powered on. So when faders do stuff on their own, they are either modulated, or affected by the Orbiter object.

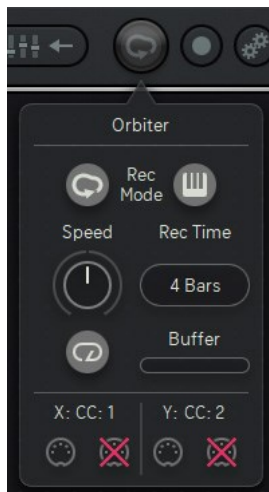

Orbiter options

The Orbiter features its own settings screen, so you can manage its options, also while the Orbit is moving around.

It handles parameters related to the Orbiter-automation features.

The Orbit works as a touch controller, but it can also record your mouse movements or save an Orbiter position for each of your 128 possible MIDI keys.

Mouse-Recorder Button



Click this Tour icon to put the Orbiter mouse-recorder to playback.

MIDI Position Button



Activates the MIDI-position feature, where each MIDI note can be assigned to an individual Orbiter position. The MIDI notes can then be used to let the Orbiter travel from stage to stage, with an additional slew processor which is to be found in the Orbiter window.

This is how it works:

- Activate the record button and the MIDI button.
- Hit a MIDI key and put the Orbiter to the desired position.
- Hit another MIDI Key and set another Orbiter-position and so on.
- Deactivate recording when you are finished.
- Now, call the Orbiter positions using the MIDI keys that you used for recording.
- Use the Speed control in the Orbiter window to smooth out the travel curve.

Speed

Will slow down (left) or speed up (right) the Orbiter movement.

Rec Length

Sets the maximum time for mouse recording.
The maximum length is 32 bars.

Loop button



When activated the Orbiter will move in loop mode.

When deactivated the Orbiter will do it's movement just once after triggered by MIDI.

Record Buffer

Shows your current position within the recording buffer.

Orbiter MIDI learn

The movement of the x-axis and the y-axis of the Orbiter can be remoted via MIDI controllers.



Assigns incoming MIDI CC's



Deletes the assignment

Initialize and Randomize



Hit this button to call up the Initialize and Random options.

Initialize the entire Orbit (All), set the Objects to their default position (Objects) or initialize Amount, Radius, Level and Pan of your Objects as well as your Mouse- and your Key-recordings individually.

Randomize

Click Objects to randomize the Object positions.

Amounts sets random amounts for your Objects.

Radius randomizes the radius of the objects.

MouseRecorder creates a random Orbiter animation.

KeyRecorder creates a keyboard full of 128 different Orbiter positions.

Record Button



Activate recording for the Orbiter.

In mouse-recording mode the recording will start as soon as you touch the screen and it will end as soon as the mouse is released. During the recording the record button will start blinking and you will see a red lit ring appearing around it which shows your current position within the recording buffer.



The **“Home” indicator** will show where you started the recording, so you can end the recording there for a smooth loop.

Orbit On/Off Button



This button will activate the Orbit.

Clicking into the inactive Orbit will also activate it.

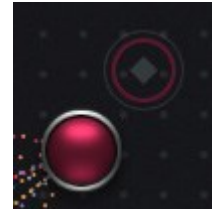
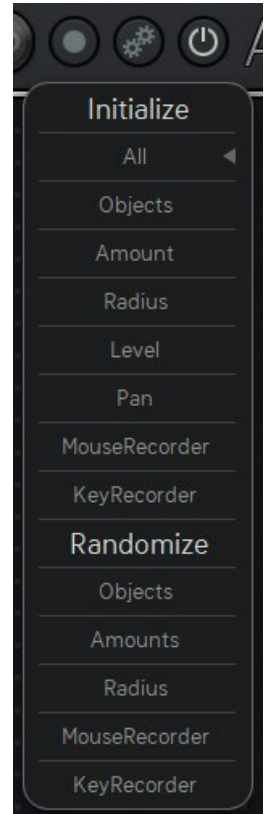

Objects window

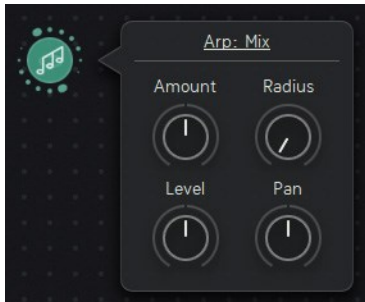

The funny objects have their little controls window that pops up when you right-click an object.

Here you find 4 parameters which help you to shape your dramatic conditions:

Amount

This control will set the amount of impact that the Orbit has on the regarded parameter. This is a bipolar control, so you can create positive and negative amounts. You can see the Orbit's impact everywhere across the instrument: If a fader is moving on its own, it is most probably modulated by the Orbit.

Radius

Sets the radius for the object. Radius is useful to control the amount of impact from the Orbiter-distance metering, but also to exclude the object from the Orbiter in certain areas.

Level

This object can influence the overall output level.

Use the level control to have influence to the overall volume, as the Orbiter comes closer to this object. Since all objects have the same parameter set, their level and pan influences are automatically mixing together to a bigger, more complex picture.

Pan

Define the width of the stereo effect for each object.

In the **Arp Object** you can select the four Arpeggiator controls as a modulation target.

In the **Ratio** and the **FM Object** you can toggle between OP-I, OP-II or both as a modulation target.



Turning the world

Touch the empty space to turn the world!

Here you can move all objects at once, mirroring at the corners, forming new shapes. After releasing the Mouse, this can easily be reverted using undo.

Orbit parameter value display



Hover any **Object** with your mouse to see its name and coordinates in the bottom left corner right above the keyboard.

About Screen



Clicking the Aparillo logo opens the About Screen where you find some global settings and functions:

Restart Oscillators

If the Restart Oscillators option is active, all oscillators will restart with the first note (after all notes were off) and after the amp envelope has reached zero. If you retrigger a note before the release of the amp envelope has reached zero there will be no restart.

If the option is off, all oscillators will recall their phase spread.

Global Tuning

With the Global Tune parameter you can change the overall tuning of Aparillo in order to adapt it to other sound sources.

Pitch Bend Range

Intensity of the pitch bend wheel.

Glide Time

The pitch will slide from one voice to another with increasing glide time. Glide is only active on Legato notes (when more than one note is held)

Collision Method

Whenever we measure the collision of an LFO-voice with either the threshold or another LFO-voice, we came to the conclusion that two modes are needed to cover all possible aspects of the issue.

[Back To Table of Content](#)



Method equal

We measure a collision with "is equal" method. This makes sure that an LFO-voice will not collide when it wraps around (ramp waveforms need to wrap from 1 to 0 or vice versa), as the wrap around is not actually seen as a movement here.

However, when using very fast rates or sample&hold/quantize, the voices might never fulfill the "is equal" rule, resulting in very few triggers. Therefore we apply the 'Method not equal'.



Method not equal

We measure the collision by status change. If an LFO-voice has been smaller than the threshold/other LFO-voice, but is now higher, it must have collided somewhere, so we send a trigger. Toll to pay here is that wrapping around is also a status change, so the trigger will occur when the ramp wraps from 1 to 0, as well as when it regularly crosses the threshold/other voice. This will keep the LFO from fulfilling its whole wave cycle.

These modes are pretty deep down the rabbit hole, but usually you are fine with the "not equal" mode. You might observe LFO-voices just run above the threshold, if that's a problem for you, just switch to the other method.

Ignore Program change

Only presets from the folder "MIDI Programs" will be used for program changes. Incoming program-change messages will be ignored.

CC Preset Isolate

MIDI Learn settings won't change when loading presets.

CC Map

Load or save your current MIDI CC assignment.

Zoom

Adjust the Aparillo Gui to your monitor screen size via the Zoom menu or click into an empty area in Aparillo, then hold down the Ctrl key and press the + to increase the size or - to decrease the size.

Extras

Here you can find your Aparillos **version number**. Please make sure, that you are always running the latest version. By clicking „?“ , you are directed to Aparillos [User Manual](#). Click the www.sugar-bytes.de to open the Sugar Bytes [Website](#).

Native Kontrol Standard NKS

Aparillo supports Native's NKS standard, giving you the same deep integration with NI controllers like Complete Instruments. The main features are a plug-and-play support of Aparillo's preset browser and trouble-free tagging/organisation for inclusion in the powerful Complete Kontrol / Maschine browser. This lets you search by sound type (e.g. synth lead), character (e.g. dark), or any combination thereof. We have strived for highly profound control of Aparillo's sound engine. Knobs and faders can be mapped to match those on the Kontrol and Maschine hardware in logical ways, with similar controls grouped by pages. For example: Skip to the Synth tab and you will find the set of controls related to the synth characteristics. All presets have been wrapped into .nksf files which contain preset and tagging information as well as mapped out controls. Different genre and mood categories will speed up the producers' workflow when browsing through libraries, and help you keep your eyes off the computer screen.

Controller Mapping

All mappings are consistent throughout the different presets. There are four pages available:

Page 1: Synth

Features the level, cutoff and resonance controls and also provides the amount controls for FMI and FMII as well as the shift amount, bright and jitter parameter.

Page 2: Spacializer/Pan/Delay/Reverb

Here you will find the controls of Aparillo's FX section.

Page 3: Arp/LFO/Pitch/Orbiter

This page features the most relevant controls for Aparillo's Arpeggiator and LFO. Alongside global pitch controls we've also included knobs for the movement of the x-axis and the y-axis of the Orbiter.

Page 4: Mod Env/Amp Env

In this section you can set the level of attack, decay, sustain and release for the modulation and the amplifier envelope.

Installation

Download (requires login) the latest version [here](#).

Double-click on the installer and follow exactly the instructions provided by the installation process.

The standalone version and manual will be installed to:

Windows: C:\Program Files\Sugar Bytes\Aparillo

macOS: /Applications/Sugar Bytes/Aparillo

Presets will be installed into

\Users\YOURLOGINNAME (your home folder)\Documents\Sugar Bytes\Aparillo

Important: Do not relocate Aparillo presets after installation!

Windows

Default installation paths:

VST2 C:\Program Files\VSTPlugins

VST3 C:\Program Files\Common Files\VST3

AAX C:\Program Files\Common Files\Avid\Audio\Plug-Ins

macOS

All versions of Aparillo will be installed by default. Depending on your host, the proper one will be loaded and used.

Default installation paths:

VST2 /Library/Audio/Plug-Ins/VST/

VST3 /Library/Audio/Plug-Ins/VST3/

AU /Library/Audio/Plug-Ins/Components/

AAX /Library/Application Support/Avid/Audio/Plug-Ins

Uninstallation

To uninstall Aparillo, please follow the instructions:

Windows

Uninstall Aparillo under Control Panel>Add/Remove Software.

macOS

Delete all the following files and folders:

/Applications/Sugar Bytes/Aparillo
/Library/Audio/Plug-Ins/VST/Aparillo.vst
/Library/Audio/Plug-Ins/VST3/Aparillo.vst3
/Library/Audio/Plug-Ins/Components/Aparillo.component
/Library/Application Support/Avid/Audio/Plug-Ins/Aparillo.aaxplugin

~/Documents/Sugar Bytes/Aparillo
~/Library/Preferences/com.sugar-bytes.Aparillo.plist

/Library/Application Support/Sugar Bytes/Aparillo
/Library/Preferences/com.native-instruments.Aparillo.plist

NKS:

/Library/Application Support/Native Instruments/Service Center/Aparillo.xml
/Library/Application Support/Sugar Bytes/Aparillo /
/Library/Preferences/com.native-instruments.Aparillo.plist

,~‘ means: /Users/YOURLOGINNAME (your home folder)

(Please note that in macOS 10.7 and later, the user Library folder is hidden. In case you cannot locate your Library folder in the Finder: Select „Go to Folder“ from the Finder’s Go menu and enter ,~/Library‘.)

Authorization

The serial number is requested during installation. If the serial number is missing or incorrect, the product will not produce any sound. Check the the top area of the Aparillo interface to verify whether your serial number is VALID. Manually entering the correct serial number there or performing a quick reinstall, should fix any issues.

License

License covers both the macOS and Windows version and can be activated for two computers at the same time. For use on more than two computers, please buy an additional license.

Host integration

Aparillo works as a VST2 / VST3 / AU / AAX plugin in the most common DAW hosts. Make sure that Aparillo is installed in the Plugins folder used by your DAW. Some hosts need to perform a plugin rescan when a newly installed plugin is launched for the first time. Please find all detailed instructions for your DAW below.

Cubase

Perform a full rescan in the Cubase plugin manager. Make sure that the Aparillo.dll/Aparillo.vst3 (Win) or Aparillo.vst/Aparillo.vst3 (macOS) file is contained in Cubase's assigned VST Plugins folder. Load Aparillo as Instrument into an Instrument track.

Ableton Live

When using macOS, we recommend using the VST version of Aparillo in Live. Please note: With Ableton Live, plugins sometimes will be marked as unloadable and not rescanned automatically. If this happens to be the case, force a rescan by unchecking and checking the 'Use custom VST Folder' checkbox in Preferences/File Folder/Plug-In Sources. Set up a MIDI track and insert Aparillo as instrument.

Pro Tools

When installing Aparillo, select AAX plug-in format. (AAX 64bit is supported by Pro Tools 11 and higher.) Use Aparillo as an instrument.

Studio One

Go to the Studio One menu and choose Options. Click Locations, then VST Plug-Ins. Click the Add... button and select your VST Plugins folder. Press OK. Create an instrument track and pick Aparillo up from the Instrument list.

Sonar

Make sure that Aparillo is installed in the VST Plugins folder used by Sonar. Insert Aparillo as a „soft synth“.

Logic

Select Aparillo as an AU-Instrument from the I/O dialogue of a Software Instrument track.

FL Studio

Go to Channels>Add one>More... There you should find Aparillo and perform a refresh. You can now open Aparillo in the Mixer Inserts.

[Back To Table of Content](#)

Contact

Sugar Bytes GmbH | Made of passion
Greifswalder Str. 29 | 10405 Berlin, Germany
phone:+493060920395
info@sugar-bytes.de
www.sugar-bytes.com

[Back To Table of Content](#)