

M 18 Digital Mixer - User's Manual



App ver. 1.1.0
FW ver. 203

Date: 10 mag 2016
Rev.: 1.1.020
p/n: 10399006 rev. C

This document refers to:
- Firmware version **203**
- iOS MixRemote app version **1.1.0 (build 105)**

This manual also applies to firmware 182 and app ver. 1.0.2, with side notes to highlight the differences and/or limitations.

What's new in firmware 203 / app ver. 1.1.0

M18 firmware release history:

version 182 (released 2016-01-14)

version 203 (released 2016-04-20)

Version 203 adds the following features:

- REC page; this feature was not enabled in firmware 182
- Redesigned and improved PREAMP graphics
- PFL indication on MAIN VU meters
- Improved VU Meter calibration
- Audio Player has louder output level

plus a series of bug fixes.

We recommend to deploy the latest MixRemote app version that matches the installed firmware.

MixRemote ver. 1.1.0 (build 105) is compatible with both released firmware versions.

RCF S.p.A. accepts no liability for any loss which may be suffered by any person who relies either wholly or in part upon any description, photograph, or statement contained herein. Technical specifications, appearances, and other information are subject to change without notice. All trademarks are the property of their respective owners.

Summary

The M series Digital Mixers by RCF.....	4
M 18 features	6
Overview	6
Internal Reverb.....	8
MultiFX.....	9
Master Processor.....	10
VALVE WARMER	10
XCITER	10
MAXIMIZER.....	10
Storing and recalling parameters	11
MixRemote iOS app	13
FADERS > INPUTS view.....	14

Input channels: preamplifier, dynamics, MultiFX.....	15
Input channels: EQ section.....	23
FADERS > SEND view.....	24
EFFECTS view.....	25
EFFECTS > SEND.....	25
EFFECTS > MULTIFX.....	26
OUTPUTS view.....	27
PHONES view.....	28
PLAY/REC view.....	29
PLAY.....	29
REC.....	30
METERS view.....	33
LOAD/SAVE view.....	34
SETTINGS view.....	35
Hardware Description.....	39
Connectors.....	39
Startup sequence and recovery from an error condition.....	41
Restoring the unit with firmware ver. 182.....	42
Restoring the unit with firmware ver. 203.....	43
M 18 Usage.....	43
Secrets of mixing on a digital console.....	44
Sound Shaping with M 18.....	45
DRUMS.....	46
BASS.....	48
KEYBOARDS.....	48
ELECTRIC GUITARS.....	49
ACOUSTIC GUITARS.....	49
VOICE.....	50
A1 - Block Diagram.....	51
A2 – MIDI implementation chart.....	53

The M series Digital Mixers by RCF

A new family of compact Digital Mixers have been designed by RCF, with the aim to address the requirements of modern performing musicians.

The main goal is to allow the user to minimize the amount of equipment needed for a live act. Therefore, a significant effort has been spent to include all the main features to ensure a seamless performance. These features are the following:

- compact size: the mixer is small and can be placed anywhere within the stage or between the instruments
- full remote control over WiFi of all features
- integration of high-quality amplifier modeling
- internal WiFi Access Point and Power Supply

The M series of Digital Mixers are ideal in all cases where a dedicated sound engineer may not be available, and therefore a FOH mixer would be inappropriate. The musicians themselves can perform the sound check by moving in from of the house PA with a tablet and setting up the mixer accordingly.

Two independent amplifier simulation algorithms, licensed from Overloud™, have been included into a multieffect-like organization of internal effects. This enables a further option to avoid bringing on the stage bulky and large amplifiers, relying on the main PA and stage monitors.

A high-quality stereo player is available on the unit, accessing files from a USB flash drive, representing a further option in minimizing the amount of equipment required for a live gig.

Therefore, you can leave home several items, such as the multicore snake, external effects that would normally connect to the mixer, guitar and/or bass amplifiers, external file player, and yet obtain a high-quality and professional result.



This document is available to help you in exploring the various features of the M 18 Digital Mixer, and is arranged in different sections:

M 18 Features

An overview of the most interesting features of the M 18 Digital Mixer is presented, focusing on the unique aspects of the unit. It includes details on the internal high-quality digital reverb, on the MultiFX concept, on the Master Processor, and on the options to save and recall internal parameters.

MixRemote iOS app

Detailed reference of the MixRemote app for iOS, which is the primary way to interact with the mixer itself. All app views and controls are presented in detail.

Hardware Description

Overview of the connections available on rear panel.

Detailed indications on the startup sequence and recovery options.

M 18 Usage

Useful tips on how to make the best use of the M Series Digital Mixer.

This section includes advices on the gain structure concept, and several practical hints on equalization and compression settings for specific instrument types.

Appendixes

A1 – Block Diagram

A2 – MIDI implementation

M 18 features

Overview

The M 18 Digital Mixer is a feature-packed unit that includes several of the useful blocks required to arrange a good-sounding live act.

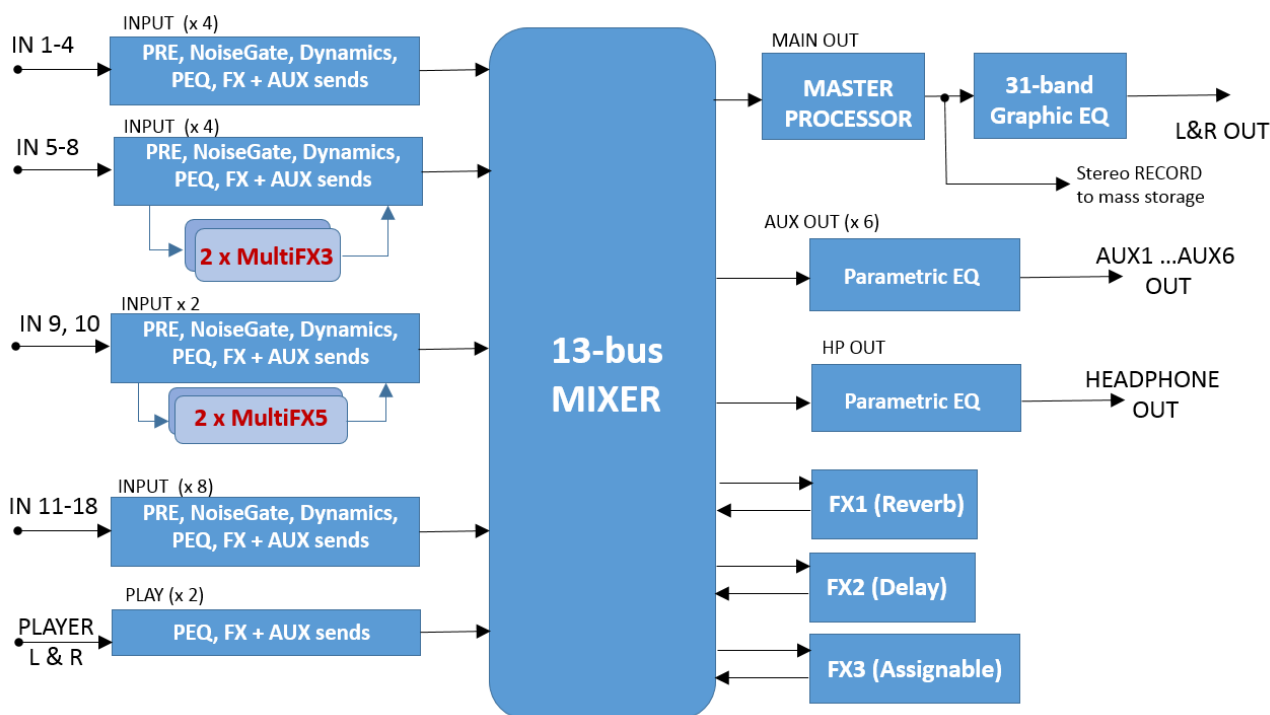

Signal processing capabilities of the M 18 Digital Mixer

In addition to the usual essential processing blocks that are present in every mixer (equalizers, compressors), several effects are available, arranged as follows:

- **Three global stereo effects**, each with a dedicated FX SEND buss
- **Two 5-stage MultiFX blocks**, dedicated to channels 9 and 10; in each of these two blocks, an amp simulator is available
- **Two 3-stage MultiFX blocks**, dedicated to channels 5 and 6 or 9 and 10
- A highly musical **Mastering Processor** on the MAIN L & R output signals
- A 31-band stereo **Graphic Equalizer** on the MAIN L& R output signals, after the Mastering Processor

The MultiFX blocks can be managed independently from the mixer, with a set of memories (which we call PATCHES), to allow the same flexibility which would be available with an external multieffect unit.

A total of 13 summing busses are present in the M 18 Digital Mixer:

- MAIN left & right buss
- FX SEND 1,2,3 buss
- AUX SEND 1,2,3,4,5,6 buss
- Stereo PHONES buss

Among these, the stereo personal monitor deserves special mention.

You can set the PHONES buss in one of two modes:

- **PFL mode** (pre-fader listen), in which the input channels put in SOLO mode are summed and sent to the PHONES output, through the EQ and PHONES fader; the PFL level is shown on the MAIN L and R VU meter. Please notice that the stereo PFL VU meter display reflects the PAN value, and of course, being pre-fader, is not affected by the fader level.
- **Personal Mix mode**, in which a separate mix of all inputs, including the 2-channel player, is available and allows a complete stereo mix to be routed to the PHONES output (and optionally to a pair of AUX outputs; see routing options)

A complete overview of the M 18 internal features is shown here below:

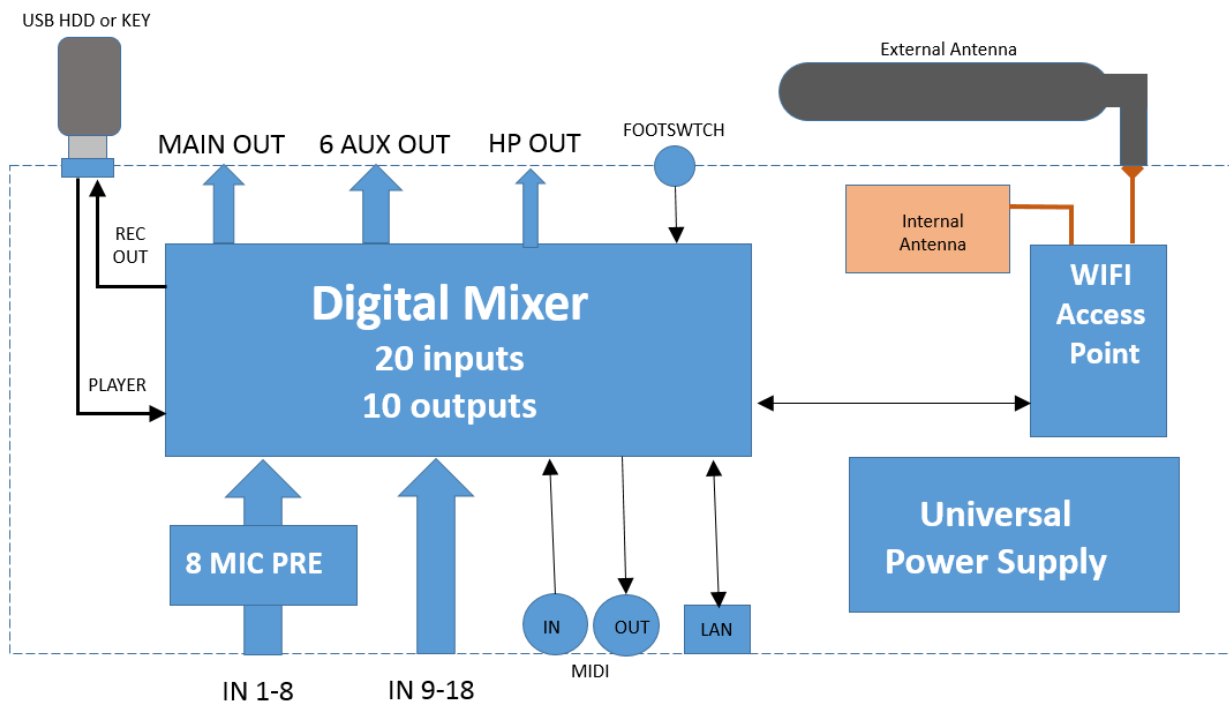

The internal Access Point is a dual-band, dual-antenna MIMO WiFi interface; one of the two antennas is external, while the other is located on the top right side (when facing at the RCF logo).

Internal Reverb

The M18 Digital Reverb is a very intuitive and smooth sounding processor, and represents an essential ingredient of the final mix. Great care has been taken to provide the highest quality algorithms and presets.



Based on 12 algorithms, it allows to easily find the perfect reverberation for every kind of application in a few clicks. The algorithms are been designed and tailored to focus immediately the sound you are looking for and then fine tune it with the essential parameters available through the five pots.

The algorithms are also available in some cases into two variations (Bright/Warm or Digital/Vintage) to further help in selecting the proper starting point.

A total of four different reverb types are available:

TYPE		VARIATIONS
Hall	usually perfect for smooth and deep reverberations	large/medium warm/bright
Room	the algorithm to start with if you are looking for hi impact reverberations	large/medium warm/bright
Plate	classic "all purpose" algorithm with unique character	digital/vintage
Ambience	the first choice if you are looking for something to expand the stereo field or to somehow enhance the sounds	model 1, model 2

TIP

The reverberation is one of the most crucial signal processors to achieve a correct mix, so it's very important to use it with care. Often the reverberation of the venue affects our overall sound, especially because usually the sound check is done without audience that is another element that can drastically change the reverberation time of the venue.

So keep in mid to evaluate the reverberation time of the empty venue, and then consider that it will be shorter with the audience during the live gig; for these reasons, it could be useful to check the amount of the reverb also on headphones.

A full set of carefully crafted presets are available, grouped into categories as indicated by their prefix:

[MIS]	Miscellaneous, general-purpose
[VOX]	Voice-oriented
[ACO]	Acoustic

MultiFX

The M series Digital Mixers offer an unprecedented level of integration by offering multiple internal effects that can be assigned to some of the inputs channels; these effects are additional and independent from the main effects which are connected to the internal effect busses.

The aim of multieffect inclusion is to provide a new approach to effect processing, as effect settings can be effectively combined with mixing parameters. It is thus possible to create a wide variety of sonic results without additional equipment.

In the M 18 Digital Mixers the internal effects are combined into a total of 4 multi-effects, which are inserted into 4 input channels. The insertion point is before the EQ section, as follows:

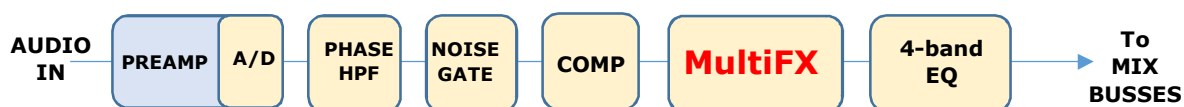

The M18 Digital Mixer offers a total of four independent MultiFX blocks, allocated as follows:

Multieffect chain	cascaded effects	Allocated to input channel	Some usage examples
MFx1	3	5 (XLR in) or 7 (COMBO in)	Voice, acoustic guitar, percussions, analog synths
MFx2	3	6 (XLR in) or 8 (COMBO in)	Voice, acoustic guitar, percussions, analog synths
MFx3	5	9 (Line in, Hi-Z option)	Electric guitar, electric bass, analog synths
MFx4	5	10 (Line in, Hi-Z option)	10 (Line in, Hi-Z option)

MFx1 and MFx2 feature a Modulation effect, a Delay and a Special FX unit; MFx3 and MFx4 are similar to MFx1 and MFx2, but they add OverDrive modeling and a high-quality Amp Simulation section.

The order of cascaded effects can be modified for each patch; the M series has a total of 5 different **effect families**, and one of each family is available within a MultiFX block, as follows:

Effect Family	Abbreviation	MFx1,2	MFx3,4	Description
Modulation	MOD	YES	YES	classical modulators typically used for several instruments (chorus, flanger, tremolo)
Delay	DLY	YES	YES	Several types of mono delays
Special Effects	FX	YES	YES	General-purpose container, including pitch shift
OverDrive	OD	-	YES	Modeling of classic overdrive stomp boxes, licensed from Overloud™
Amplifier simulation	AMP	-	YES	Accurate modeling of guitar and basshead amps and cabinets, licensed from Overloud™ and from MarkBass™

You can save the all parameters of a specific MFx chain, including effect ordering, within a PATCH, that can be recalled independently from other mixer parameters. You can recall PATCHes via MIDI program change message, and you can also individually turn on and off the effects via NoteOn MIDI messages; each MFx reacts on different MIDI channels, which can be set within the SETTINGS > MIDI page. The dual footswitch input can be set to control a specific MFx, to either move to next or previous PATCH, or turn individual effects on and off.

Therefore, you have a high degree of flexibility for controlling MFx chains during a live gig.

Master Processor

The M Series Master Processor is the last stage of processing, before the MAIN Graphic Equalizer, and represents a precious toolset to give a final touch to overall sound. The Master processor is composed of three individual processors in series: **Valve Warmer**, **Xciter**, **Maximizer**.

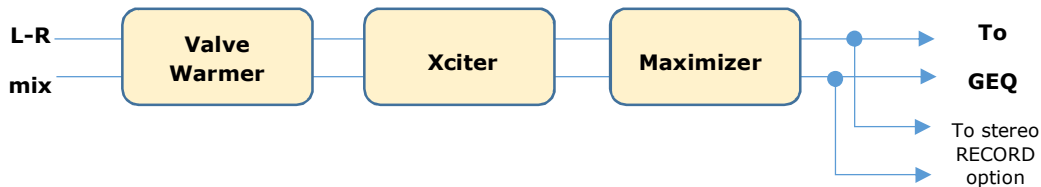

These three processors have been developed to work together or individually, to achieve a warmer, analog overall sound, but at the same time to make your sound loud and proud as required from the contemporary music business. You can bypass the set of three processors with a single button, to ease the evaluation of its effect on the overall mix. The factory presets are, as always, a great starting point to easily learn how the three processors can work together and then to go ahead creating your own settings.

VALVE WARMER

Very easy to use one knob processor, it allows to vary from subtle warmth to extreme saturated sound.

This processor works like a real analog piece of gear: it means that the resulting sound is depending on input level; the more you feed it with a louder signal, the earlier you get a saturated sound, so be careful with your levels inside the mixer and use it very slightly if you want to use it only for warming your sound.

XCITER

It allows to sculpt sound with two adaptive curves on the low end and high end. The frequency of these curves have been tailored to fit easily and quickly every kind of mix.

You can easily achieve a more pleasant and dynamic sound by fine-tuning the overall frequency balance (Focus) and make it more or less evident (Process)-

MAXIMIZER

This is the last processor in the signal flow chain, that allows you to give a final boost to overall sound. This processor is very transparent and has been designed to be a “set and forget” stage.

With this in mind, the Maximizer is super easy to set with its two knobs:

Boost: sets the amount of the incoming signal to the maximizer (it's a boost only knob so rotate it anticlockwise for NO boost)

Out Ceiling: sets the final level (it's an attenuator knob, so rotate it full clockwise for NO attenuation)

The Maximizer can be also used “to compact” the overall mix sound, so in this case you can use it boosting and attenuating at the same time.

Storing and recalling parameters

The mixer handles the many hundreds parameters available in a specific way that has been tailored to the needs of the performing musician. The following parameters groups can be identified:

- Global configuration parameters: they are stored in the mixer as soon as they are modified
- Network configuration parameters: they need a mixer reboot to become effective
- **SHOW**: it includes all the mixer parameters, except configuration parameters
- **SNAPSHOT**: as a SHOW, but without the output related parameters, and may include recall of PATCHes
- **PATCH**: it includes the parameters of a multieffect (MFX1, MFX2, MFX3, MFX4)

The SHOW is best suited to save all settings after a sound check, or to store the equalization settings of a specific venue; it can then be recalled when doing a live act in the same venue.

The SNAPSHOT is ideal for storing all the settings that are related to a specific song or context; i.e., you can change EQ and equalization types on all input channels, as well as all send effects (both send levels and effect types).

When using the M 18 as a submixer, you can also save input channels levels by enabling the Mix Bus option during Save; this helps in obtaining a consistent audio result.

We can show an overview of M 18 Digital Mixer parameters and the various ways of saving them as follows:

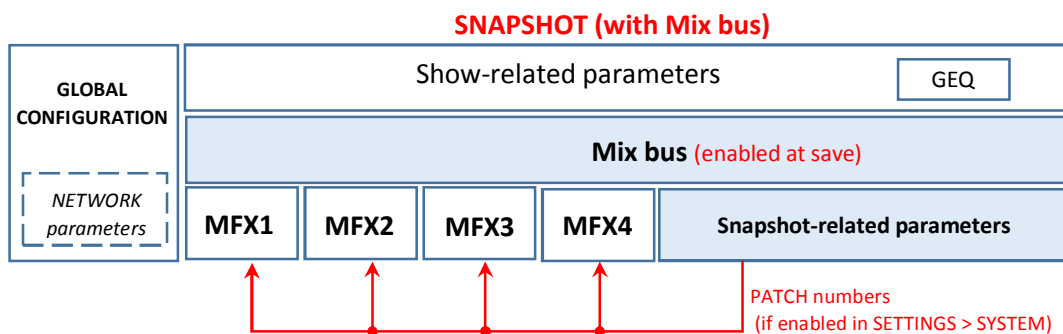
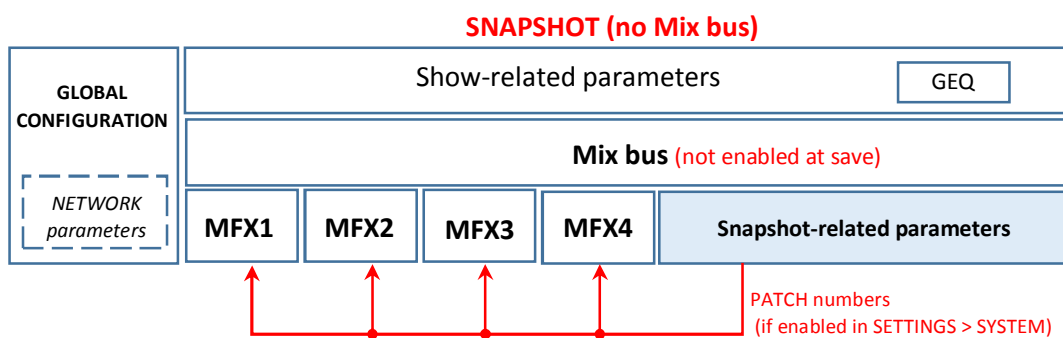
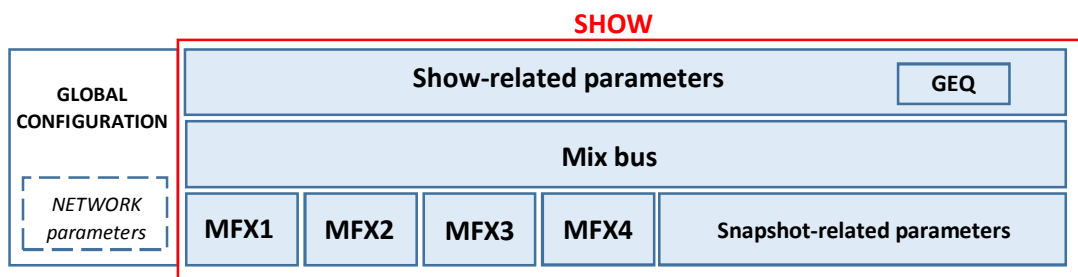

Every group is detailed in the following table:

Group	Parameters	Notes
Global Configuration	NETWORK/LAN Settings NETWORK/WLAN AP Settings +48V Phantom Enable PHONES Mode (PFL/Personal Mix) MFX1, MFX2 Routing Footswitch Settings Outputs Routing Snapshot Settings (save of MFX patch numbers) Startup Setting MIDI settings PLAYER AUTO Mode ON/OFF	The NETWORK subgroup require a reboot to become effective
SHOW related	INPUTS CH. PRE (GAIN, TRIM, PHASE, HPF, HiZ) INPUTS CH. STEREO LINK settings OUTPUTS LEVEL (Main Out, AUX Out, Phones Out) INPUTS CH. names OUTPUT CH. names AUXs BUS (Level, Mute) PHONES BUS (Level, Mute, Pan/Balance) AUX OUT EQ parameters PHONES EQ parameters All MFX1, MFX2, MFX3, MFX4 parameters AUX 5-6 CH. PRE/POST settings GEQ ON/OFF	A SHOW saves the complete mixer state (inputs, outputs, processing)
GEQ	Stereo 31-band Graphic EQ settings	<i>May be saved and recalled independently</i>
SNAPSHOT related	INPUTS CH. EQ parameters INPUTS CH. GATE parameters INPUTS CH. COMPRESSOR parameters INPUTS CH. names OUTPUT CH. names SEND EFFECTS parameters MASTER PROCESSOR parameters FXs Bus (Level, Mute) Mix Bus parameters (if enabled at save) MFX1 PATCH number (if enabled in SETTINGS) MFX2 PATCH number (if enabled in SETTINGS) MFX3 PATCH number (if enabled in SETTINGS) MFX4 PATCH number (if enabled in SETTINGS)	A SNAPSHOT saves all the parameters not directly related to the outputs
Mix Bus	INPUTS BUS (Level, Mute, Pan/Balance)	<i>May be included in a SNAPSHOT</i>
MFX1	DLY parameters FX parameters MOD parameters FX order	MFX1 is a daisy-chain of 5 individual effects (DLY, FX, MOD, with assignable order); affects input channel 5 or 7
MFX2	DLY parameters FX parameters MOD parameters FX order	MFX2 is a daisy-chain of 3 individual effects (DLY, FX, MOD, with assignable order); affects input channel 6 or 8
MFX3	DLY parameters FX parameters MOD parameters OD parameters AMP parameters FX order	MFX3 is a daisy-chain of 5 individual effects (DLY, FX, MOD, OD, AMP with assignable order); it affects input channel 9
MFX4	DLY parameters FX parameters MOD parameters OD parameters AMP parameters FX order	MFX4 is a daisy-chain of 5 individual effects (DLY, FX, MOD, OD, AMP with assignable order); it affects input channel 10

MixRemote iOS app

The **MixRemote** app allows full control of the M 18 Digital Mixer, and links to the unit via a WiFi connection.

Several enhancements are periodically added to the app, therefore we suggest to check periodically for updates on the iTunes Store. +Before downloading the updated app, please verify on the release notes if there is the requirement to upgrade the hardware unit via a firmware update before using the updated app.

When you first launch the app, you reach a welcome screen; at this point, you are still not connected to the mixer itself. You have three options available:



Welcome screen

In this view, you can choose between the following:

Offline (M08): *this feature is intended for the M08 model, is currently disabled and reserved for future upgrades*

OffLine (M18): you can browse all features of the app without the need to connect to a physical M 18 unit

Connect: the mixer connects to your control device in few seconds, provided that you have selected the proper mixer WiFi Access Point

On the bottom row, you can modify the IP address of the target mixer; there is a button to recall the default value intended for the internal WiFi Access Point (*only available on MixRemote ver 1.1.0 or newer*).

After pressing **Connect**, you are directed to the real operative views of MixRemote.

FADERS > INPUTS view

The first page you access is the FADERS INPUTS page, which shows on the top left the MIX REMOTE logo (1). If you tap on the MIX REMOTE logo, you will be directed to the main FADERS > INPUTS view; this is a sort of “Home” button that leads you always to the initial page with input faders.

In the central area, on the upper side, there is a small text box with indications of the currently active session (2). Below there is a row of main tabs, named from left to right FADERS (4), EFFECTS (5), OUTPUTS (6), PHONES (7), REC/PLAY (8), METERS (9), LOAD/SAVE (10) and SETTINGS (11); the active tab is backlit. On the right side there's the RCF logo (3), which is lit (in brilliant white) when your controller is connected to the M 18 Digital Mixer. A small indicator just below the logo signals lights up to indicate that the M 18 Digital Mixer is busy and the app is waiting for a response.

The fader caps are color coded consistently throughout the app:

SILVER caps	Input faders; Monitor output faders; FX buss send faders
ORANGE caps	FX send faders, for each input channel
GREEN caps	AUX send faders, for each input channel
RED cap	MAIN output fader



The FADERS INPUTS page, as most pages, is divided in three areas.

The left area, under the **MIX REMOTE** logo, enables the recall of the **INPUTS** tab, which is the default one. Below, there are **FX1**, **FX2**, and **FX3** tabs in orange, as well as **AUX1**, **AUX2**, **AUX3**, **AUX4**, **AUX5**, and **AUX6** tabs in green. At the bottom there is a double arrow allowing you to scroll down 8 inputs at a time, or more if some channel are stereo linked.

The right column, under the RCF logo, is dedicated to the **MAIN OUT** section, featuring the * key **(19)** to recall the MAIN settings page, a box **(20)** indicating the level of the stereo fader in dB, the Mute button **(21)**, the MAIN OUT text box and the red stereo fader **(22)**, which remains active in almost every page of the mixer. At the bottom there is a double arrow allowing you to scroll up 8 inputs at a time, or more if some channel are stereo linked.



The central area is reserved for a view of 8 faders **(12)**; this area can be scrolled by swiping your finger horizontally. Above each fader there is a * **(13)** to recall its setup pages, a box indicating the pan-pot position or each fader level in dB **(14)** and a Mute button **(15)**. Please note that clicking on the pan-pot, a larger windows opens, allowing better setting accuracy.

Then there's a text box **(16)** which by default shows the channel number, e.g. CH.01 by clicking on the button appears a keyboard allowing you to enter up to **12 characters to name the channel**. On the right of each fader there's the relevant level indicator, and under the fader there is the headphone icon **(17)** if the **PFL** mode is activated – please see the **Settings** tab, **Global** page. Finally there's the number of the hardware input **(18)**, which can't be modified.

The faders of the 18 analog inputs are followed by **PLAY-L** and **PLAY-R** faders, controlling the signal from stereo USB flash drive – these channels don't have the PRE-DYN section. Finally there are the faders of internal effect returns **FX1 RTN**, **FX2 RTN** and **FX3 RTN**, which have only boxes for dB level, MUTE, fixed name, and PFL, as well as the fader.

The PFL function (Pre-Fader Listen), when enabled, redirects the level indication from the PFL bus into the Main VU meter; a yellow LED indicates that the Main VU meter is showing the PFL level instead of the actual audio output *(only available on MixRemote ver 1.1.0 or newer)*.

Input channels: preamplifier, dynamics, MultiFX

By clicking on * you access to each channel settings page; please note that these pages are different for inputs 1-8, which hardware section is provided with combo connectors, allowing the use of microphones, eventually provided of Phantom power, see **SETTINGS** tab **GLOBAL** page. Note that channels 05-08 may have the MULTI FX page - with up to three effects.

Inputs 09-10 hardware sections allows the use with a Hi-Z signals, with a specific selector in mixer channels, and have a large **MULTI FX** page - with up to five effects. Channels 11-18 features line level only inputs, with a different RCF PRE layout.

In the left column the last modified section between **PRE/DYN**, **EQ**, **MULTI FX** (only for channels 05-10) and **SEND** is lit. The right column, shows the MAIN OUT controls.



Inputs 01-08

The left part of the center column contains on the top left a **BACK** button (1) to allows you return to the **INPUTS** view, followed by the pan control which also shows fader value in dB when moved (2), the Mute (3) button, the channel editable name (4), the fader (5), the PFL (6) button and the non-editable number of the hardware input (7). The larger part of this page shows a rack containing **RCF PRE**, **RCF GATE** and **RCF COMPRESSOR**, above the latter two there is a box to recall presets.

The two large arrow buttons on bottom left and right enable you to change input channel immediately, without requiring to go back to the INPUTS view.

On MixRemote ver. 1.0.2 (previous version)

The **RCF PRE** preamplifier features **GAIN** (from 0 dB to 60 dB in 10 dB steps), **TRIM** (from 0 dB to -10 dB in 0.1dB steps), the LED indicating the activation of the Phantom 48V power over the **INV** switch (phase inversion). The display shows the values of each parameter, including the frequency of the **HPF** (selectable between 10Hz and 500Hz) which is activated via its **ON** button.



On MixRemote ver. 1.1.0

The **RCF PRE** preamplifier now features a single **GAIN** control (from 0 dB to 60 dB in 31 dB steps), the LED indicating the activation of the Phantom 48V power over the **INV** switch (phase inversion). The display shows the values of each parameter, including the frequency of the **HPF** (selectable between 10Hz and 500Hz) which is activated via its **ON** button.



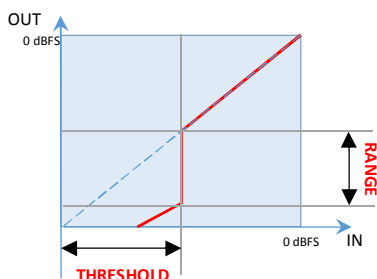

The second unit is the **RCF GATE**, topped by its **Preset** box, with **ATTACK** and **RELEASE** time controls, **THRESHOLD** level and **RANGE** intervention, completed by the display and the activation switch. On the left you can see the characteristic curve of the internal GATE: when the input signal goes below the THRESHOLD, its level is reduced by RANGE dBs.

The third unit is the **RCF COMPRESSOR**, topped by its **Preset** box, with a display on the left, followed by **ATTACK** and **RELEASE** times controls, **THRESHOLD** level, **RATIO** compression, **POST GAIN** level and the activation switch. On the right, the characteristic curve of the compressor is shown, including the contribution of POST GAIN control.

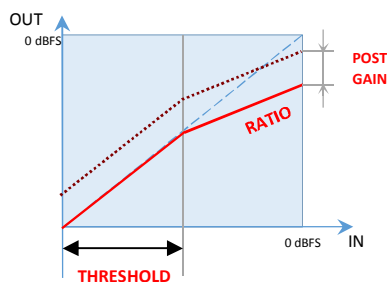

For faster adjustments, the compressor features the **Easy** option, located in a small box on the left of the **Preset** box - Easy has only the **COMPRESSION** control (based on input level signal with preset thresholds, with automatic Post Gain adjustment) against the five controls of **Advanced** option.



Inputs 5-6 and 7-8

The left part of the center column contains on the top left a key (1) to return to **INPUTS** followed by the level of the individual fader in dB (2), the Mute (3) key, the name of the channel (4), the fader (5), the PFL (6) key and the non-editable number of the hardware input (7). The larger part of this page shows a rack containing **RCF PRE**, **RCF GATE** and **RCF COMPRESSOR**, above the latter two there is a box to recall presets.

Inputs 5-6 and 7-8 left column is a little bit different, since these channels may have **MultiFX** (MFX) additional section. MFX assignment is made in **SETTINGS** tab **GLOBAL** page.

The MultiFX section allows you to use up to three chained effects selectable between **MOD** (Chorus, Flanger or Tremolo), **FX** (Pitch Shifter), and **DEL** (Mono Delay, Vintage Delay, ER Delay). Pressing the **Order** selector appears a drop-down menu allowing you to choose the order of effects which better suits your needs for each song, as you can see in above pictures.



At the top of each pedal there's a display showing the last modified control value. At the bottom there's the activation switch; its status is displayed by a light which is lit when the unit is on.

IN DEPTH

These channels let you use up to three cascaded effects types: MOD (Chorus, Flanger or Tremolo), FX (Pitch Shifter), and DEL (Mono, Vintage or ER Delay).

You can change the order of cascaded effects through the selector Order, and view the result on the top right indicators. These indicators show the ON/OFF status, and also allow you to select which pair of effect is visible on the central section for editing. The order from left to right of the FX, MOD and DEL buttons reflect the actual audio cascading.

If you touch any of the effect button, the editing view for effects will shift to include the effect you have selected.



*Please note that in **MixRemote ver. 1.0.2**, there was no indication of ON/OFF status of individual insert effects; rather the two shown pedals are indicated as a pair of lit buttons.*



Inputs 09-10

Hardware inputs 09 and 10 have line-level sensitivity, but also allows the direct connection of electric guitar and bass instruments, as they feature a **Hi-Z option**.



The -10dBV and +4dBu options are similar to the other line-level inputs; the **Boost** option allows you to insert another 2 dB boost to the analog stage; while the **Hi-Z** option enables a real high-impedance stage to get the best sound from your passive instrument. When in Hi-Z mode, the impedance is 1 Mohm. When using active instruments, we suggest to maintain the Hi-Z option OFF.

These two channels offer additional capabilities to tailor your own sound, as they both feature a 5-effect MultiFX.



Similarly to channels 5 to 8, the effects are displayed in pairs, and you can jump to the desired insert effect by touching the dedicated button on top right (see the red box here below).

You change effect daisy-chaining using the **Order** Selector, immediately to the left of the insert sequence indication. If you drag the rightmost part of the list, you can modify the insert position of a specific effect, and the change is effective immediately.



At the top of each pedal there's a display showing the last edited control value. At the bottom there's an activation switch; its status is displayed by a light which is lit when the unit is on.

The **OD** section allows to choose between an Overdrive and a Distortion effect, modeled after well-known stomp boxes that have been used by guitar players for decades.

The **AMP** processor is a special one: you can quickly select the amplifier type on its drop-down menu, and if you tap anywhere on the pedal, you will be directed to the dedicated AMP page (see below) with several useful controls.

Let's see an example of the following effects order: DEL, FX, MOD, OD, AMP. The picture above shows the first two effects; then, by tapping on the buttons at the top right (see red box), you obtain different views:



By tapping the AMP stomp box, a new page shows up, with all the relevant parameters on a single view for maximum editing efficiency.

Each Head AMP simulation has a preferred Cabinet combination, and every time you select a Head AMP, the matching Cabinet will show up. Then, you can vary the Cabinet model and experiment with unusual combinations.

Each Head AMP has up to 6 parameters that accurately model the controls available on the original amplifiers.

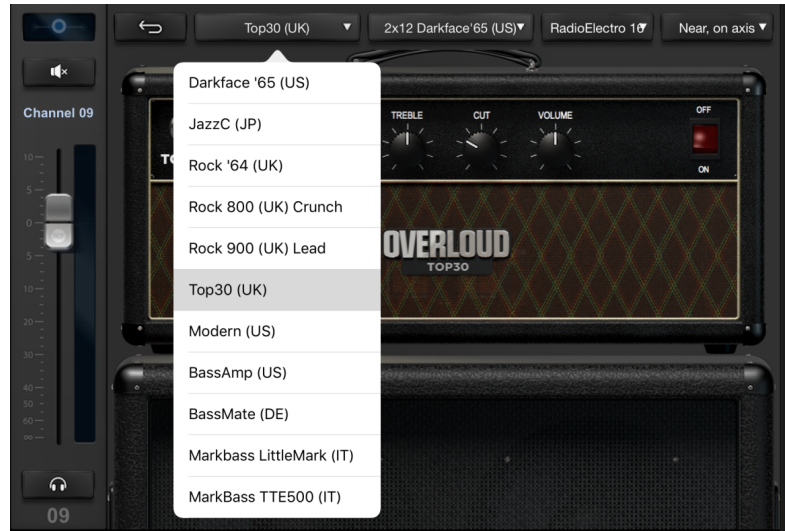

The ON/OFF rocker switch represents the BYPASS switch, and has same function as the switch on the stomp box view.

As visible on the left, most Cabinets have similar names to the Head AMPs.



The last four Head AMPs and Cabinets are dedicated to bass guitar, covering a wide range of resulting timbre. In addition to the Overloud™ models, two well-known MarkBass™ models have been included.

You can also select the microphone type which has been used when modeling the AMP (see below):

- RadioElectro 16** (large-diaphragm cardioid dynamic)
- American 57** (small-diaphragm cardioid dynamic)
- GermanFet 87** (large-diaphragm cardioid condenser)

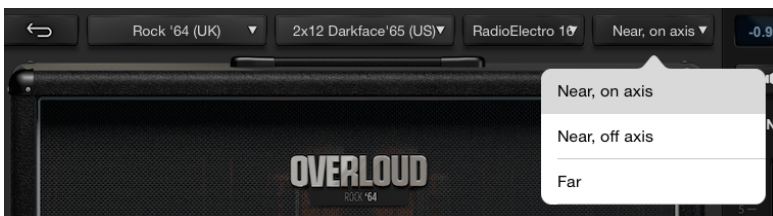
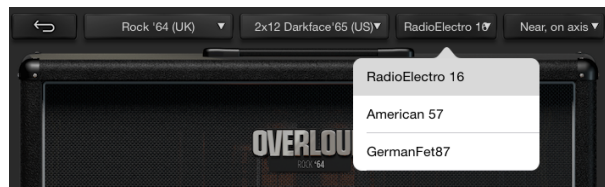

The choice for microphone position is between:

- Near, on-axis**
- Near, off-axis**
- Far** (1 metre from cabinet)

Inputs 11-18

Hardware inputs from 11 to 18 have line connections, with the option to switch between -10dBV and +4 dBu sensitivity.

INV and HPF other controls are identical to the other inputs, as you can see on the right.



Stereo Player (from USB flash drive)

TK USB inputs are managed as a stereo input by default, but you can always unlink them in SETTINGS > GLOBAL page.

As the audio is directly generated in digital, there is no need for PRE or DYNAMICS.



When you have a stereo track, the typical use is in stereo (linked) mode.

If you have a mono backing track on one channel, and the metronome click on the other, then you may work in dual mono mode, which allows you independent pan and mixing controls.

Input channels: EQ section

The 4-band EQ page is identical for all input channels - including **TK** channels. This page is characterized by the large **Preset** box, followed by **Standard** and **Advanced** boxes and **ON** switch.

Great versatility is provided by allowing the selection of three different types of equalizer: **Standard** (a no-frills, precise EQ), **Vintage** (modeled after a UK classic EQ), **Smooth** (whose modeling was inspired by a modern US EQ). You have a wide choice that can help in providing the right color to your sound. For each of the three equalizer types, two options are available: **Advanced** (showing all the available parameters) and **Easy** (in which some of the more advanced controls are hidden to enable a quicker interaction).

In **Standard** mode, the display shows the operation of the 4-band equalizer (the overall intervention is indicated by a white line).

The **Advanced** option provides variable frequency shelving filters for low and high bands and two fully parametric mids, while the **Easy** option provides high and low shelving with fixed frequency, and selection of the frequency for mid-low and mid-high.

The range of intervention goes from -12.00dB to $+12.00\text{dB}$; double clicking on the **GAIN** resets the value to 0.00dB for each band, while to completely turn off the equalizer, you have a global **ON/OFF** button right above the display.



All three models, with the Advanced option, have the following frequency ranges:

Band	Freq. Range
LO	40-400 Hz
MID1	100 Hz – 10 kHz
MID2	100 Hz – 10 kHz
HI	1 – 16 kHz

FADERS > SEND view

For each of the input channels, the **SEND** page allows the accurate settings of three FX and six AUX sends.



FX sends are always post-fader, thus allowing the channel level to affect FX send levels, maintaining the desired balance. AUX1-AUX4 sends are always pre-fader, thus allowing to set the required level independently from channel level settings – this solution is ideal for stage monitoring. AUX5 and AUX6 can be set pre or post fader independently for each input channel.

The central part of this page has 3 faders for FX sends and six faders for AUX send levels. Each of the FX send faders feature a Mute button. To choose the effects of the three sends, please go to the **EFFECTS** tab.

EFFECTS view

The EFFECTS tab contains two pages: SEND and MULTIFX.



The left column shows the SEND and the MULTIFX select buttons; the right column shows usual the MAIN OUT controls.

EFFECTS > SEND

The SEND page shows the three rack mount effects units: FX1 for reverbs, FX2 for delays, and FX3 which can be assigned to one of four different types of delays and modulations effects. On the upper left side over each rack device there are small Preset boxes, to recall several factory presets. On the right left side over each unit there is a box to choose the effect variation. Only on the third device, there is an additional central box to choose the effect type among Delay, Chorus-Flanger, Tremolo and Pitch Shifter.

The large display shows parameter values and on the right there is the activation button for each effect.

IN DEPTH

The **Digital Reverb** lets you choose between two large hall, two medium hall, two medium rooms, two small rooms, two plates and two ambiances.

You can create your own configurations by modifying the following parameters:

- **Predelay** (delay before reverb)
- **ER** (amount of primary reflections)
- **Decay** (time decay)
- **Spaceness** (percentage of spatialization)
- **Damping** (percentage of absorption of the higher frequencies)

The Digital Delay can be chosen among **Stereo**, **Vintage**, **Modern**, **Dual** and **ER**.

You can create your own settings for **Stereo** and **ER** by changing the following parameters:

- **Time** (length of the delay)
- **Feedback** (% of delay feedback)
- **Lo Cut** (low cut filter frequency)
- **Hi Cut** (high cut filter frequency)
- **Width** (amplitude)

Vintage delay parameters:

- **Offset** (offset time compared with main Time) instead of Feedback
- **Filter** (da 0,00 a 100) is a Band-pass filter

Modern delay parameters:

- **Offset** (offset time related to Main Time) instead of Feedback
- **LoCut** (low cut filter frequency) instead of Hi Cut.

Dual delay parameters:

- **Factor** (1/2, 1/3, 1/4, 1/6, 1/8 and 1/16) instead of Feedback
- **Feedback 2** (% of delay 2 feedback) instead of Hi Cut

Chorus-Flanger parameters:

- **Rate** (frequency swing)
- **Width** (amplitude)
- **Depth** (depth swing)
- **Feedback** (% effect feedback)
- **Blend** (% mix between dry signal and processed)

Tremolo parameters:

- **Rate** (frequency rate)
- **Depth** (depth swing)

Pitch Shift parameters:

- **Pitch 1** (voice 1 note interval; from -12 to +12, in semitones , equivalent to +/- 1 octave)
- **Pitch 2** (voice 1 note interval; from -12 to +12, in semitones , equivalent to +/- 1 octave)
- **Cent1** (detune of voice 1, in cents)
- **Cent2** (detune of voice 1, in cents)
- **Mix** (% mix between voice 1 and voice 2)

EFFECTS > MULTIFX

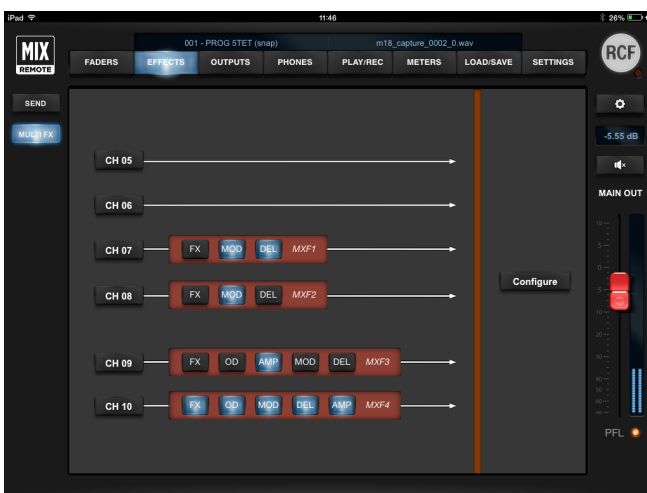

This page shows the four channels that have multiple effects. Here you can also configure which pair of channels - Channels 05-06 or Channels 07-08, which are active in this example – will have the MFX option active. Only channels 09 and 10 provide you five effects.

The order and ON/OFF status of each insert effect is shown. Pressing any of these buttons or the blue button, you access immediately the corresponding channel.

For details about MFX options, please see Inputs 05-08 and Inputs 09-10 chapters.

OUTPUTS view

This tab has one page only, which shows the six silver master faders for the AUX sends, the PHONES master level, as well as MAIN OUT master level on the rightmost column, as in most views.



Each AUX output has a * button to recall the settings pages (1), a box indicating the level of the individual fader in dB (2) and a Mute button (3); just above the fader there is a text field (4) which by default indicates the send number, but of course can be renamed; the fader (5) for master output level is above output number, which corresponds to the physical AUX socket.

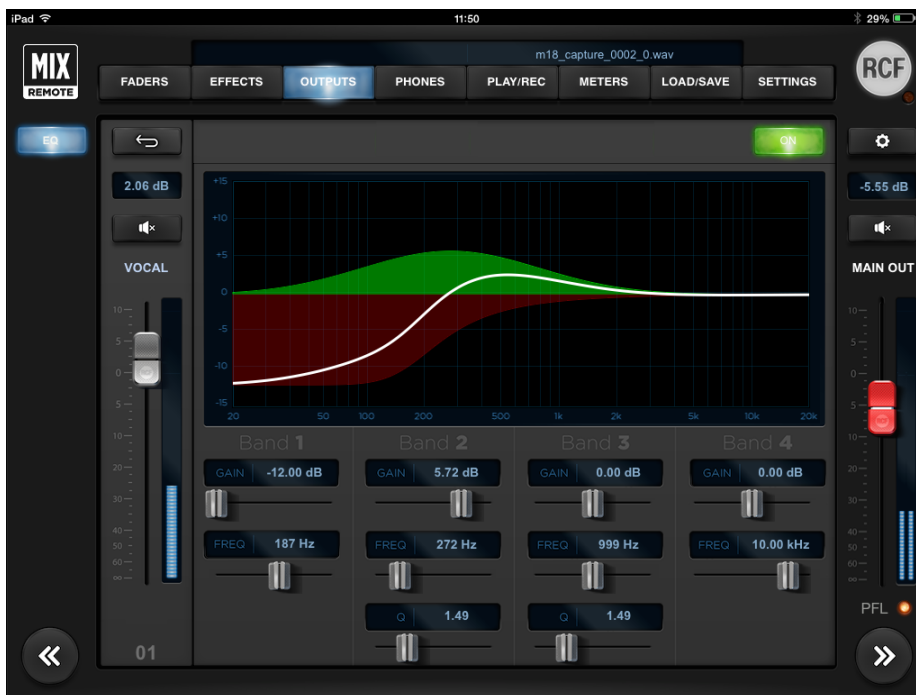

Pressing *, you recall the OUTPUTS EQ page, containing the Advanced EQ for that AUX send; the other controls are for level and mute.

The “Advanced” equalizer features low (40Hz-400Hz) and high (1kHz-16kHz) shelving and two fully parametric bands (range 100Hz-10kHz for both).

PHONES view

The way the **PHONES** output works depends on **SETTINGS** tab **GLOBAL** page selection. You can choose the operating mode between PFL (Pre-Fade Listen) or Personal Mix.

In **Personal Mix** mode, the central column of the PHONES page includes a box indicating the level of the individual fader in dB or the pan-pot position, a small Mute button, a text box which by default is the number of the send, which can be renamed, and a blue fader for headphone level and the non-editable number of the hardware socket. The level is pre-fader.

In **PFL** (pre-fade listen) mode, the signal to the headphones is set by the PFL key of each input, the USB player and FX RET.

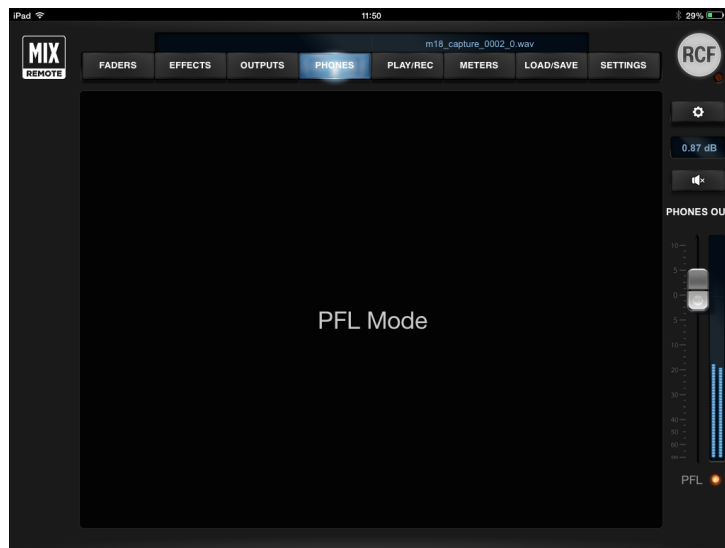

PLAY/REC view

Two tabs are available on the left column, and you can select either the stereo PLAYER or the stereo RECORDER views; both access files on a USB Mass Storage device (USB pen drive, or external HDD) attached to the local USB host port. Within specific conditions, player and recorder can operate simultaneously even on the same USB device.

PLAY

This view shows the channels **TK1** and **TK2** of USB playback. Please note that these channels are stereo linked by default; if you want independent settings for each channel, you have to un-link them using **Input Stereo Links** in **SETTINGS** tab, **GLOBAL** page. These channels are processed by a dedicated EQ, of the same type as other input channels; therefore, three types are available (Standard, Vintage, Smooth) each with two modes (Advanced and Easy).



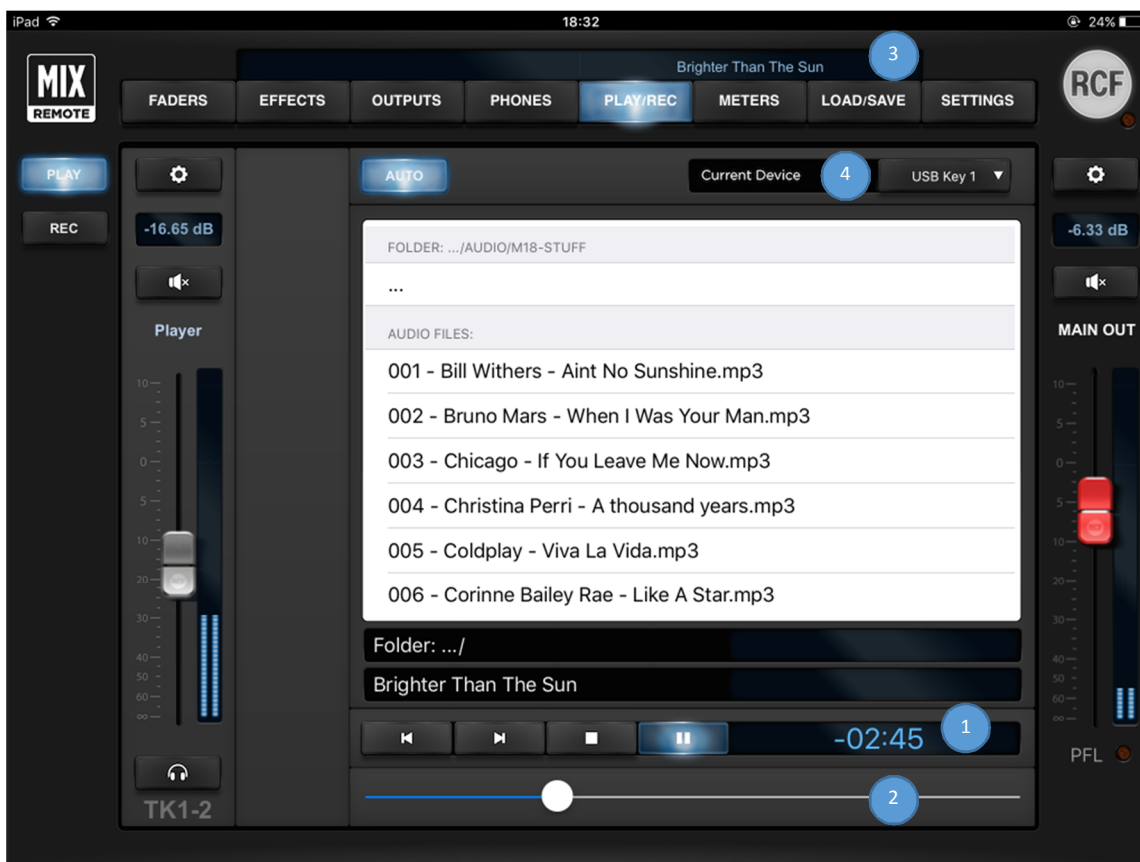

On the right side of these controls there is a time indicator **(1)**; by default, it shows the remaining time to the end of file. By clicking on the time indication, you can toggle the value shown to represent the time elapsed. A scroll bar **(2)** shows the current position within the file; you can grab the scroll bar and move to the desired position, either when in playback mode or stop mode. A drop-down selector **(4)** on the upper right corner allows the selection between different 4 USB flash drives; this is required in case multiple USB flash drives are connected through a USB hub.

On the upper bar, on the right side, you can view **(3)** the file currently selected on the player.



A large selection pane allows you to navigate through the USB flash drive folder (upper section), and then to select the specific files (lower section). To navigate to the previous directory, in the folder section, you can click on the line with 3 dots. *Please notice that with a very large amount of files, it takes several seconds to show all file names.*

Under this window there are the following player controls:

		AUTO ON	AUTO OFF
	PREV	Go to previous file in list and PLAY	Go to previous file in list and STOP at beginning
	NEXT	Go to next file in list and PLAY	Go to next file in list and STOP at beginning
	STOP	STOP current playback and rewind to beginning of file	
	PLAY/PAUSE	Toggle between playback of current file and PAUSE at current position	

The following audio file formats are supported by the player and shown in the file list:

- WAV stereo audio files; 44.1 and 48 kHz, 16- and 24-bit (*.WAV extension)
- AIFF stereo audio files, ; 44.1 and 48 kHz, 16- and 24-bit (*.AIF and *.AIFF extensions)
- MP3 stereo audio files (*.MP3 extension)

REC

On MixRemote ver. 1.0.2 (previous version)

This view is not available, you can access the PLAY view only.

You will need to upgrade both the MixRemote app to ver. 1.1.0 and the mixer firmware to build 203 to have access to the REC page.

The REC window allows high-quality, stereo recording of the MAIN left and right channels. The tap point is after the Mastering processor, and before the Graphic Equalizer (which is generally used for settings that are a function of the available amplification system).

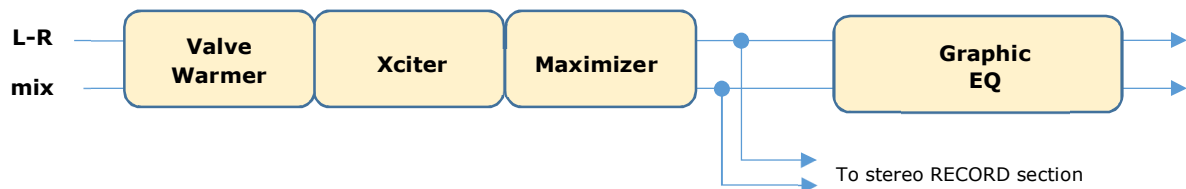

The currently available format is 24-bit, 48 kHz (the internal sample rate of the M18 Digital Mixer).

As the recording level greatly depends on the number of active inputs, a wide-range **Rec Trim** control **(1)** is available. The minimum value of -18 dB is intended for full use of the mixer, with all inputs being used.

The meter **(2)** below shows the audio level after the Rec Trim regulation, so that you can check if you are too close to clipping.

All recordings are stored in the /REC folder within the USB Mass Storage device being selected on the upper right selector **(3)**.

A default name is generated if no specific name is entered, of the form m18_capture_XXXX_0.wav, where XXXX is a numeric counter to ensure a unique filename.

To modify the filename, it is sufficient to touch the folder/filename area **(6)** and a text entry popup shows up.

If a name is given, the numeric counter is automatically appended every time a new record begins.

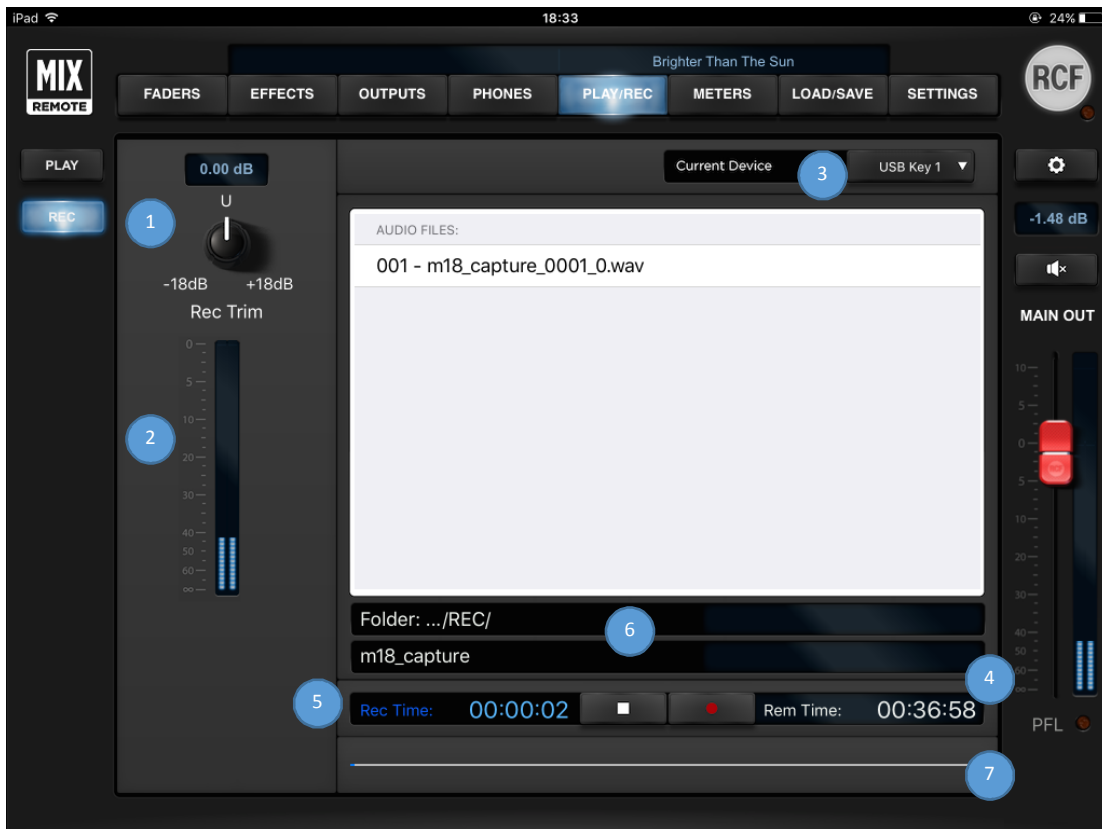

The file is auto-saved every ten seconds, so that any unwanted interruption (i.e., the USB storage device is removed abruptly, or M18 power is turned off) does not result in a total loss of audio data.

Two time indications are shown: the time since start of recording **(5)** and the remaining time **(4)** calculated on the available storage size. A progress bar **(7)** shows the status compared to the remaining time, defined as above.

While M18 is quite flexible in terms of USB storage device capabilities for playing back files, a good quality device is required for recording on USB in real-time.

FAT32 is the only supported file format on M series digital mixers, and is also the safest cross-platform (Mac / PC) format. Please avoid FAT formatting as we have noticed random problems in playback of audio files.

Please notice that the minimum supported size for audio recording is 4 GB (mainly due to variations in formatting results for smaller size devices).

Furthermore, consistent and error-free results have been obtained with premium, good-quality USB pens. Several lower-quality devices can cause random errors due to their lower data transfer performance. USB 3.0 compatible storage devices are recommended, as these guarantee higher data throughput.

Due to filesystem limitations, the internal recorder can generate a file with maximum size of 4 GB, corresponding to more than 3 hours of continuous recording. If this limit is exceeded, the recorder closes the current file and creates another file with a minimal audio gap, without interrupting the recording process.

We have found on several USB devices, that it is recommended to have at least 50% free space on the USB key; beyond this percentage, most USB keys show significant fragmentation and in this case glitches can appear in the recorded files.

In case you need to reformat a USB pen for audio recording, please follow these guidelines:

Operating System	FORMAT settings
Windows (any)	File System = FAT32, Allocation Unit Size = Default
Mac OS X	Format = MS DOS (FAT32), Scheme = Master Boot Record

METERS view

This tab has just page, which provides an instant view of the levels of all **INPUTS** - including the **PLAYER** – and of three FX stereo returns (**RTNS**).

The lower section shows the output levels of the three FX **SENDS** and the **OUTS** level of the six AUX sends.

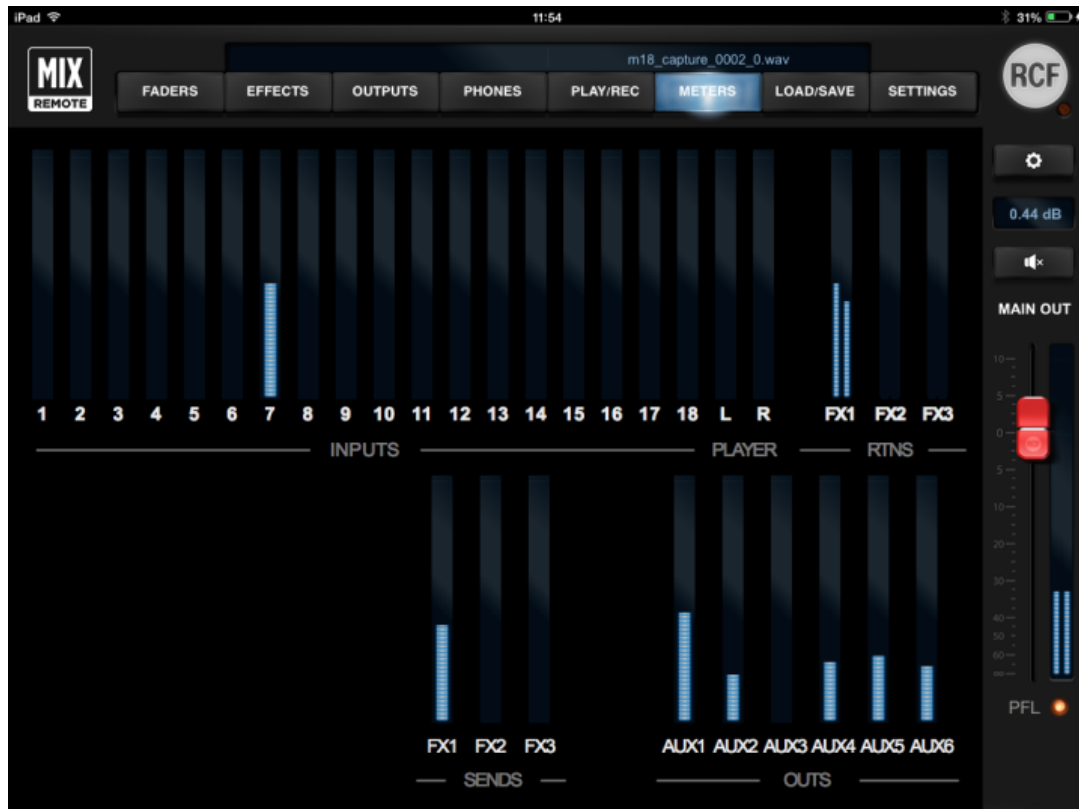

This view is very useful to quickly check which signals are actually active, and it is recommended to check this view every time you want to verify the mixer status.

LOAD/SAVE view

This section features two pages: **SNAPSHOT** and **SHOW**. Using these pages you can **save** up to 200 **SNAPSHOT** presets or 100 **SHOW** presets that you can recall later by pressing the **load** button after the selection of the desired snapshot/show number.

SNAPSHOT

The snapshot presets include all the settings but outputs. They are intended for storing all the parameters that you would typically fine tune in advance for a specific song or context; with them, you avoid affecting output settings (level, equalization, monitor busses) so that a Snapshot change does not modify the settings that are usually found during the sound check within the venue for the live act.

A Snapshot Load action does not mute the audio outputs, but applies parameter changes smoothly to minimize audio artifacts.

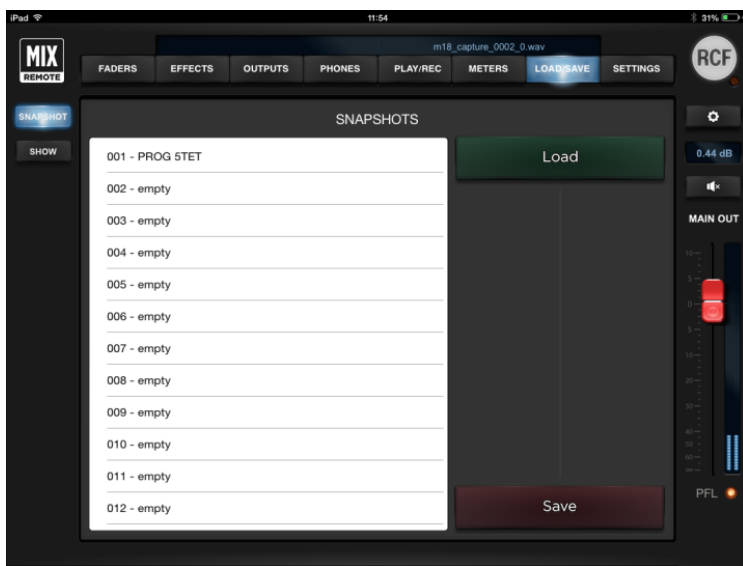

Please note that in **SETTINGS > SYSTEM** page you can select whether to include MFX patches recalls independently for each MFX.

When saving a Snapshot, you have a further option: you can enable the save of Mix Bus parameters (see at page 11). This is useful when the M18 Digital Mixer is being used as a submixer, in which case the channel levels are part of the overall sound creation process.

To load a Snapshot, first select the Snapshot number on the left pane, and then press Load.

SHOW

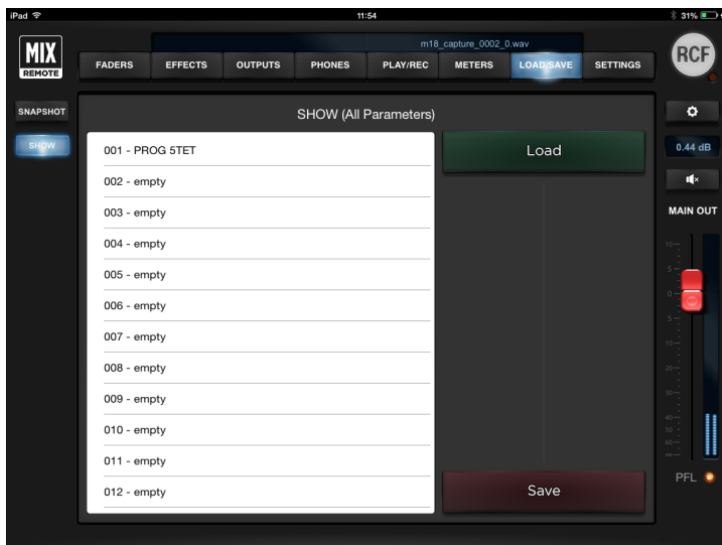

The Show includes all parameters pertaining to inputs and outputs, except the global configuration parameters (see at page 11). A Show Load action mutes all outputs, to avoid sudden level changes.

To load a Show, first select the Show number on the left pane, and then press Load.

To save a Show, first select the Show number on the left pane, and then press Save; you have the option to edit the Show name before confirming the Save operation.

SETTINGS view

The SETTINGS view allows access to all of the global configuration parameters (see at page 11). Four tabs are available, on the left column.

NETWORK

Two sections are accessible from the NETWORK view: on the left side, for the wired LAN port; on the right side, for the internal Wireless LAN Access Point.

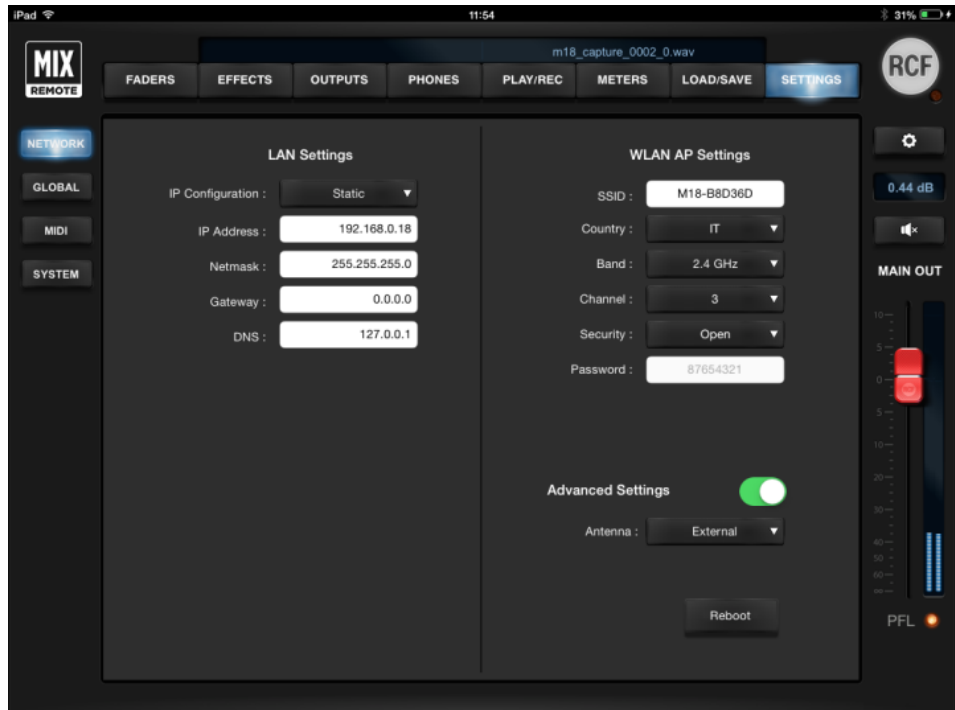

LAN Settings: all network-related adjustments can be made, such as **IP Address**, **Netmask**, **Gateway** and **DNS**. These settings are usually left at the factory values, but they can be modified for special uses. Standard usage of the M18 Digital Mixer does not require the LAN port.

WLAN Settings: all WiFi-related adjustments can be made, mostly like a standard WiFi Access Point. The parameters are described in detail here:

SSID	You can modify the factory setting to provide a name you can remember. The factory name is in the form M18-XXXXXX where the latter are a combination of letters and numbers.
Country	By selecting the appropriate country where you are operating the mixer, you can comply with local radio regulations. Please notice that if you leave to the default value NONE, transmitting power is limited and you will not obtain the best performance from the M 18 Digital Mixer, including maximum distance and robustness to interference
Band	You can select between the usual 2.4 GHz band and the less crowded 5 GHz band, depending on your tablet capabilities
Channel	You can minimize interference from other Access Points by selecting a channel not being used by others. There are several scanning software applications that enable you to view which channels are available.
Security	You can either keep the Access Point open, or enable WiFi security (WPA2/PSK). In this case, you will be able to modify the default password.

After you perform all changes to either LAN of WLAN parameters, you must press SEND to modify these settings into the mixer. A reboot will be required to make these changes effective.

If you enable **Advanced Settings**, then you can switch between the internal and external antennas. This change is immediate and does not require a reboot.

The **Reboot** button is intended for advanced applications, and should be avoided in normal usage.

GLOBAL

This page contains several settings affecting the operating mode of the mixer.

The **48V Phantom Enable** section allows the activation of 48V phantom power for microphone inputs in groups of 4, using **Phantom 1-4** and **Phantom 5-8** switches.

The **Phones Mode** section sets the mode of the headphone output, allowing the selection between **PFL** (on FADERS INPUT page) and **Personal Mix**.

The **Input Stereo Links** section allows you to link in stereo an odd channel with the next even channel. After the link, all settings from the odd channel will be copied to the even channel, and in the bottom row the numbers of paired inputs will show up (e. g. 03-04) below a single fader with stereo VU meter. The Link option is available for all inputs (1 to 18) plus the stereo player from USB flash drive. By default the player is linked in stereo.

The **Footswitch** section controls allows you to determine the footswitch operation; **Mode** allows you to choose between **LATCHING** or **MOMENTARY N.C.** footswitch contact. Then there are **SW1 assign (TIP)** and **SW2 assign (RING)** drop-down menus listing all the parameters to be controlled.

The **Output Routing** section has drop-down menus to choose the source for several physical output:

- **AUX** output between its relevant **AUX**, **MAIN** or **PHONES** busses
- **PHONES** output between **MAIN** and **PHONES** busses

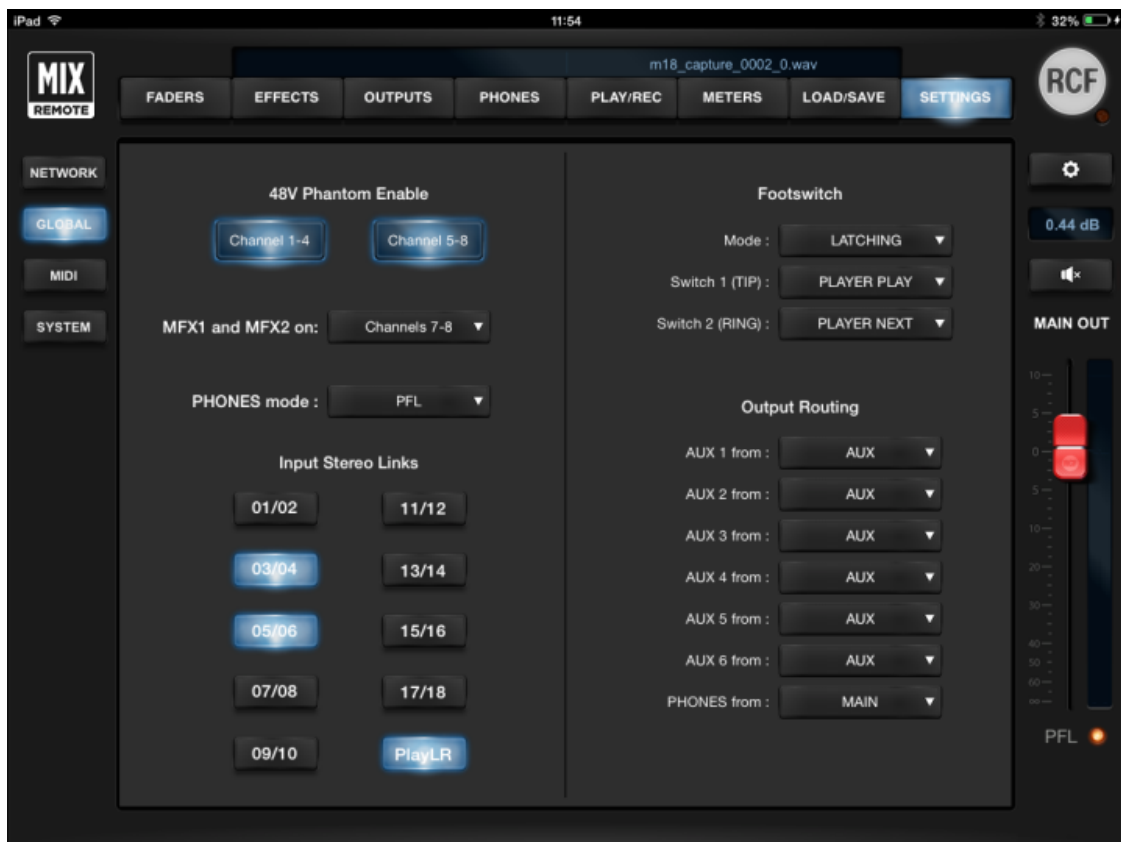

MIDI

This page manages allows the define which MIDI are associated with specific functions. You can also disable reception of MIDI commands.

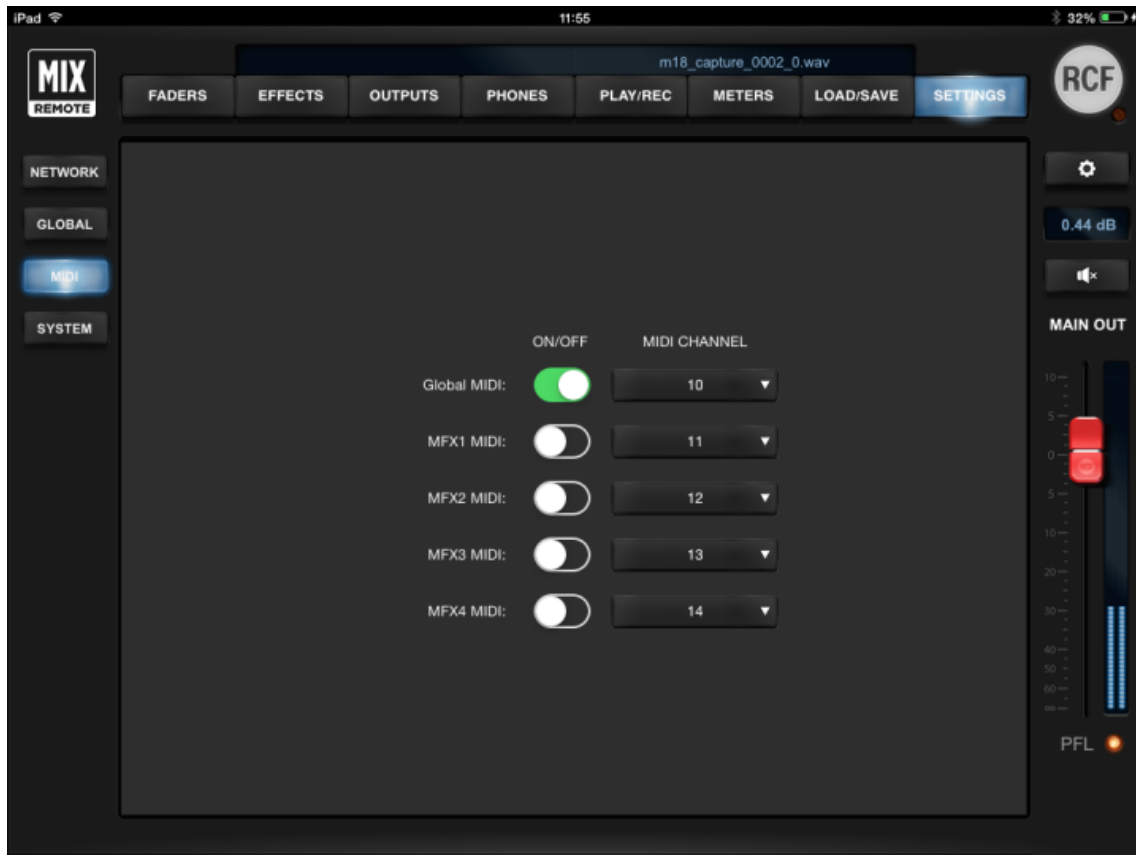

Section	Default MIDI ch	Description
Global	10	The allowed commands include output levels (CC messages), player control (NOTE on) and snapshot load (Pgm Change messages)
MFX1	11	Multieffect MFX1 (assigned to either input ch 5 or 7) patch change (Pgm change messages) and individual effect toggle (NOTE on)
MFX2	12	Multieffect MFX2 (assigned to either input ch 5 or 7) patch change (Pgm change messages) and individual effect toggle (NOTE on)
MFX3	13	Multieffect MFX3 (assigned to input ch 9) patch change (Pgm change messages) and individual effect toggle (NOTE on)
MFX4	14	Multieffect MFX4 (assigned to input ch 10) patch change (Pgm change messages) and individual effect toggle (NOTE on)

SYSTEM

This page contains system settings affecting the M 18 Digital Mixer operations.

The **Snapshot saves** switches allow to save also the MFX patch numbers, independently for each MFX. In this way, you can associate saved patches of each MFX to the current Snapshot.

The ONLINE and OFFLINE buttons allow a change of connection status. Immediately below, there's a text line indicating the status of the mixer (*Mixer disconnected* or *Mixer connected*).

There is the option “**Go OFF-Line if the mixer is disconnected for:**” followed by its time line to choose how many minutes, in a range from 1 minute to 30 minutes. We suggest to keep it to the maximum value.

WARNING: if disconnection is frequent, please check the **WLAN** connection in **SETTINGS** tab **NETWORK** page.

On the right side, we have the **Application Version** and the **Firmware Version**.

These information are followed by **At startup** behavior setting: you can select between **Init Mixer** (the mixer powers up in initialized state, with all faders turned down) and **Last show** (at power-up, the mixer loads the last show that was either loaded or saved).

In case of communication issues between the tablet and the mixer itself, you can press **Updt All Data**, which recalls the last active status of the mixer, including all the changes done.

Documentation Mode contains information for our team... nothing useful for the use of the unit 😊

Random VU Meters activates the VU Meters when the mixer is disconnected, and is used for demo purpose only!



Hardware Description

Connectors

All connectors are available on the rear panel, for maximum compactness.

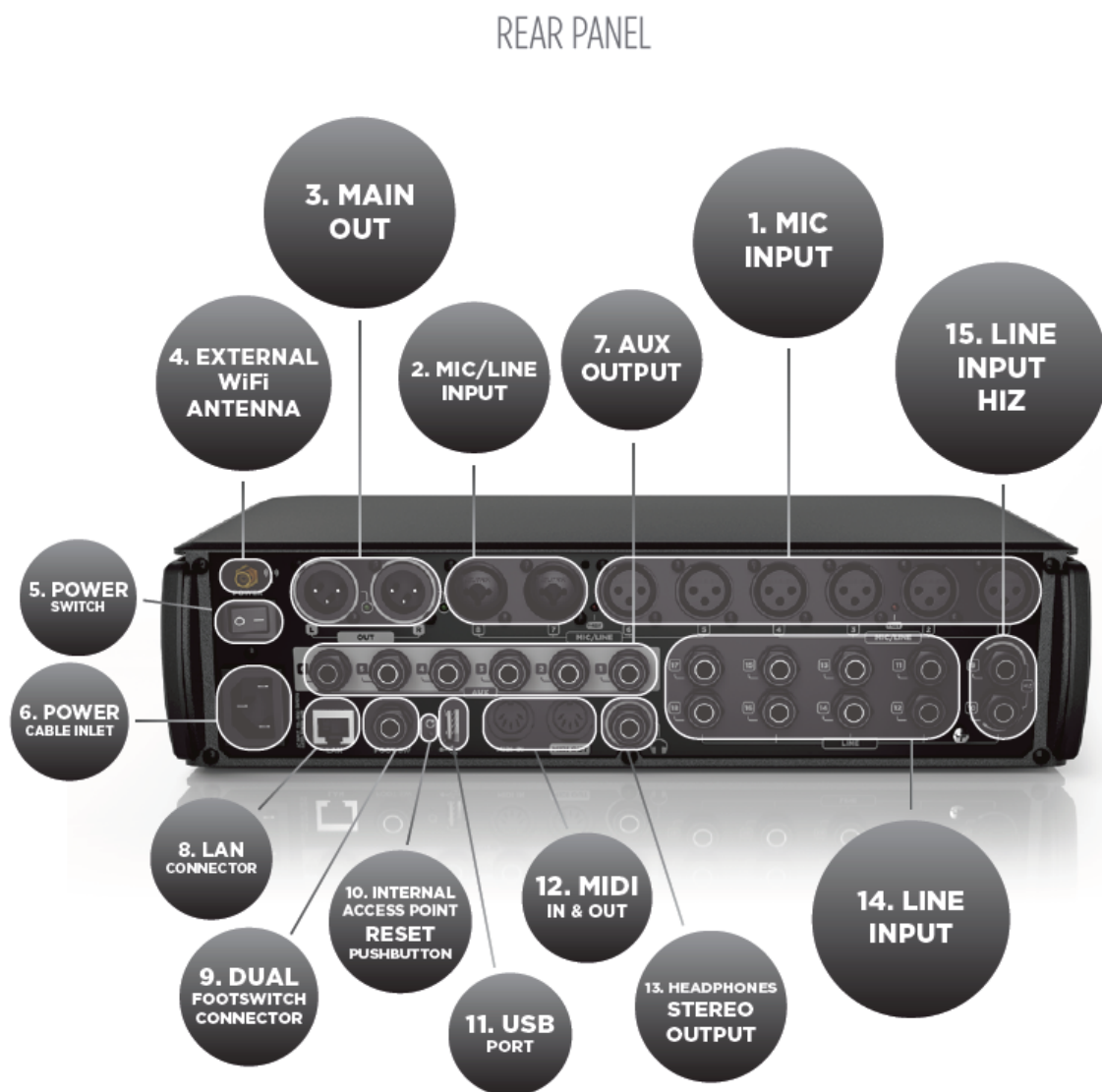

1. MIC Input 1 to 6 – XLR Female

Connect your Microphones to these remotely-controlled 60dB gain-range inputs. Red LEDs indicate the Phantom power status ON or OFF for MIC input groups 1 to 4 and 5 to 8. To obtain best performances from your microphones, use balanced XLR cables.

2. MIC/LINE Input 7 and 8 – Combos

Input 7 & 8 provide Mic input on the XLR connection and Line input on the TRS jack connection.

3. MAIN OUTPUT L&R

Connect your active speaker or your amplifier to these +21dBu balanced Output. The green LEDs

show the signal presence on MAIN MIX channels independently for LEFT and RIGHT outputs.

4. External Wi-Fi Antenna connector

M 18 includes an internal antenna and provisions for an external antenna. Attach the provided external antenna to this connector for optimal performance of the MixRemote app.

5. Power switch

Turn On and Off your M 18 device.

6. Power cable inlet.

Connect here the provided power cord.

7. AUX Output 1-6 Balanced jacks

Connect to these +21dBu balanced output your stage monitors or external effects.

8. LAN connector

It is possible to connect here an external Wi-Fi Access Point for advanced communication configurations. This port is intended also for future applications.

9. Dual footswitch connector

Connect here a single or dual external footswitch. The footswitch port allows connection of a single or double stage footswitch to recall effects' presets or to mute effects' returns, as well as providing several other control functions.

10. Internal access point reset pushbutton

Press this button during normal operation (for less than 10 seconds) to restore the default settings for both the internal Wi-Fi Access Point and the LAN port, as follows:

LAN	IP configuration	Static
	IP address	192.168.0.18
	Netmask	255.255.255.0
	Gateway	0.0.0.0
	DNS	0.0.0.0
WiFi	Band	2.4 GHz
	Country	NONE
	Channel	3
	Security	OPEN
	SSID	M18-xxxxxx
	External Antenna	Enabled

This button is available also for other functions, you can review them more in detail at page 42. You can modify these settings from the MixRemote app in the SETTINGS > NETWORK page.

11. USB Type A port

Insert here a USB stick to play high quality audio files. .WAV, .AIFF and MP3 file allowed for reproduction.

12. MIDI connectors

Connect here your MIDI controller. See the dedicated page on MixRemote (SETTINGS > MIDI) to view the assigned MIDI channels for specific functions.

13. Headphones stereo output

Connect your headphones here either for PFL, Personal Monitoring or the Main Mix listening.

14. LINE Input 11-18

Connect here your line level sources like keyboard, external audio device or other small analog consoles used for submix. These input are unbalanced, and their operating levels can be set to +4dBu or -10dBV.

15. LINE Input 9-10 with switchable HiZ input

Connect to these unbalanced inputs your line-level sources, at +4 dBu or -10 dBV, or high-impedance passive instruments, like electric guitars, electric basses or piezo pickups. You can individually enable the Hi-Z option, that offers a 1 Mohm input impedance when activated.

Startup sequence and recovery from an error condition

The M series Digital Mixer features an advanced booting system that ensures the unit correctly powers up in any condition. The white front LED gives indications about the startup process, which is divided into several stages.

STAGE		LED
1	startup	Single flash
2	(bootloader)	Fast blinking
3	OS starts	Steady ON
4	M18 executable starts	Slow blinking
5	Completed, ready for use	Steady ON

It can happen that the internal files of the mixer are corrupted, typically when a firmware update procedure is halted by mistake, by powering down the unit during the process or immediately after.

If the bootloader detects a corrupted file within its internal memory, then it forces the M18 to start in RECOVERY MODE. This is a special mode in which a clean image is loaded and allows for proper upgrading to the latest firmware, if needed.

The RECOVERY MODE is indicated in the Firmware version field, in both MixRemote (SETTINGS > SYSTEM), and in MixUpdate apps. After a mixer starts in RECOVERY MODE, please check if later firmware updates are available on RCF web site to ensure that you can take advantage of all functionalities.

Restoring the unit with firmware ver. 182

Firmware 182

Please notice that this section details behavior for firmware versions 182 ONLY. Go the next Chapter for firmware 203.

If your unit is not reachable by the MixRemote app, you have some options to force the unit into an operating condition again. These options require that the reset button, on the rear panel, near the USB port, is pressed:



1) The unit is working, but you forgot WiFi and/or LAN password and settings

When the unit is ON and working, press the reset button for no more than 10 seconds, and for at least 3 seconds. The front LED will blink rapidly; when you release the button, the default settings will be overwritten and the unit will reboot automatically. When the startup procedure is completed, you can access the unit with the default parameters.

Please notice that all previously saved data (shows, snapshots, patches) will be maintained.

2) The unit is working, and you want to revert the mixer to default global configuration

When the unit is ON and working, press the reset button for more than 10 seconds. The front LED will blink very rapidly; when you release the button, the default global configuration parameters will be copied and the unit will reboot automatically. When the startup procedure is completed, you can access the unit with the default global configuration parameters.

Please notice that all previously saved data (shows, snapshots, patches) will be maintained.

3) If the unit is not reachable under any condition, and there is no sound

With the unit turned off, press the reset button, then turn power ON, and maintain the button pressed for at least 8 seconds. The mixer will then start a complete restore that will last about two minutes, reverting to factory firmware and settings.

After about two minutes, when the front LED starts blinking slowly, you must turn power off. At the next power-on, the unit will startup in default conditions. Please notice that if you have saved global settings previously (country code, password, etc...) you will need to set these parameters again.

Please notice that the first restart after this recovery operation will take much longer than usual, i.e., about two minutes to complete its reinstall, and therefore the WiFi AP will be visible after a longer time interval.

Restoring the unit with firmware ver. 203

On firmware ver. 203, recovery options have been modified as follows.

If your unit is not reachable by the MixRemote app, you have some options to force the unit into an operating condition again. These options require that the reset button, on the rear panel, near the USB port, is pressed:



1) The unit is working, but you suspect that WiFi is not behaving as intended.

When the unit is ON and working, press the reset button for no more than 10 seconds, and for at least 3 seconds. The front LED will blink rapidly; when you release the button, the WiFi Access point will be restarted, without rebooting the mixer. Please notice that all previously saved data (shows, snapshots, patches) will be maintained. From the moment the button is released, about 10 seconds are required to complete the operation.

2) The unit is working, but you forgot WiFi and/or LAN password and settings

When the unit is ON and working, press the reset button for more than 10 seconds. The front LED will blink rapidly first, then more rapidly; when you release the button, all configuration parameters of both WiFi Access Point and LAN port are restored to their default values. The WiFi Access Point will be restarted, without rebooting the mixer.

Please notice that all previously saved data (shows, snapshots, patches) will be maintained.

From the moment the button is released, about 15 seconds are required to complete the operation.

4) If the unit is not reachable under any condition, and there is no sound

With the unit turned off, press the reset button, then turn power ON, and maintain the button pressed for at least 8 seconds. The mixer will then start a complete restore that will last about two minutes, reverting to factory firmware and settings.

After about two minutes, when the front LED starts blinking slowly, you must turn power off. At the next power-on, the unit will startup in default conditions. Please notice that if you have saved global settings previously (country code, password, etc...) you will need to set these parameters again.

Please notice that the first restart after this recovery operation will take much longer than usual, i.e., about two minutes to complete its reinstall, and therefore the WiFi AP will be visible after a longer time interval.

M 18 Usage

Secrets of mixing on a digital console

The most important thing to keep in mind using a digital console is the **Gain Structure**.

Mixing is essentially an art, but the Gain Structure is based on mathematical reasoning and represents the most important thing to learn to manage before taking off with your mixing creativity!

The correct input level, starting from the Analog Gain, with all the further processing inside the mixer, must be set by checking continuously the master output to avoid overload because digital consoles work differently from analog ones.

The 0dBFS level (where FS stands for full-scale) refers to sound level in the digital domain, inside the mixer itself, and corresponds to the maximum signal that can be applied to an Analog-to-Digital conversion stage: above this level, the conversion process clips the signal and severe distortion appears.

A fair starting point to set the proper Analog Input Gain is to set the individual sounds levels in the range of -18 .. -14 dBFS.

One of the most powerful but often underestimated tools is the High-Pass Filter (HPF); in the M Series mixer the HPF is located in the PRE-DYN page. The proper HPF setting on the individual channels is important to optimize the processing of the audio sources, and furthermore it also helps to cut away some subsonic inaudible components of the sounds that often cause an efficiency loss of the power amplification system.

It's highly suggested to always use the HPF on all the input channels, especially on mic inputs during live gigs where the HPF is a great tool to reduce the noises captured by the microphones by transmission (as an example, foot stomping or noises captured touching the mic stands).

How to set the HPF?

Generally, except for instruments with lot of low end like a Kick Drum or Bass, 50Hz is a good frequency to start with. The HPF is not only the first tool to optimize the signal chain but it must be considered like an EQ band, and for this reason it should be used to easily optimize the frequency range aimed to achieve a more focused overall balance between the different sounds

A classic example of HPF usage in frequency range optimization is on the Toms. When played alone, Toms have huge energy in the low end; in a mix of medium density of instruments the perception of those low frequencies is masked by other instruments, so to make the Tom sound more focused we could boost some mid-hi frequency or cut some low end with the HPF – 100Hz and above - and increase the level.

This approach allows to keep the same RMS audio level (matching the perceived audio level), but with an optimized frequency range.

The approach described for Toms above should be reiterated for all instruments.

Gain Input Level, HPF and Gain Structure are the most important elements to keep in mind for the usage of a digital console.

Sound Shaping with M 18

A full array of processors is available on each M Series Mixer's channel: HPF, Gate, Compressor, Insert, Equalizer, Three Fx Sends.

They allow to tailor every kind of sound not only for correction but also with a creative approach.

The **Gate** with its full set of controls allows to be optimized for every kind of incoming signal, even the most complex and difficult to tame.

The **Compressor** can be at the same time super transparent but also very aggressive.

The **Equalizer** is the essential mixing tool, and is available in three variations: Standard, Vintage, Smooth. The Vintage and Smooth types have been derived from models of classic analog equalizer banks that have been used in countless recordings and mixing sessions.

For each type, an *EASY* mode is available, showing the essential parameters only, and is perfect for superfast usage

Which are the features of each type?

Standard	This is the most transparent type of Equalizer in the M series Digital Mixer. Four bands ideal for every kind of correction but also perfect to tailor the sounds without colorations.
Vintage	This Equalizer is modeled after the Classic British EQs. It's the first choice when you are looking for an Equalizer with character and impact.
Smooth	This is a really unique Equalizer. The two Mid bands have been designed to shape gently the frequencies and the two Shelving sections have been developed to cut gently some frequencies in conjunction to their boost.

These features allow to shape sounds carefully, placing them into the mix with unparalleled smoothness.

The large number of presets are ideal to learn more about the power of Equalizer types and they represent an invaluable starting point to create your own unique sound.

To simplify navigation, equalizer presets have been grouped in classes depending on the instrument being targeted; groups are identified by the prefix assigned to each preset, as follows:

[DRM]	Drums
[PRC]	Percussion
[BSS]	Bass
[EGT]	Electric Guitar
[AGT]	Acoustic Guitar

[KEY]	Keyboards
[VOX]	Voice
[ORC]	Orchestral
[MIS]	Miscellaneous

Let's take a look to some real examples and usage tips.

DRUMS

Gate and Compressor are processors heavily used on drums and percussions.

Among the various Equalizer options, the Vintage Type is for sure the most recommended if we are looking for a sound shape with character. The Standard Equalizer Type is still the first choice for surgical corrections and for transparent shaping. The Smooth Equalizer Type is for sure the best choice for soft sounds.

Here are some examples and tips for each part of the drum kit.

KICK

EQ	COMP	GATE
HPF: OFF > 50Hz Body: 50Hz>150Hz Resonance (Cut) : 180>400Hz Attack: 4>8 KHz	Attack: Med-Slow Release: Med-Fast Ratio: 4:1>8:1	Attack: 1msec Hold: 80msec Release: 50msec Range: 15 > 50 dB

TIP: The Kick is an instrument that, due to its low end, takes a big part of the RMS level, so it's very important to define the frequency range where it will stay in relation to the bass guitar.

Generally a good starting point for optimizing the low end range is to avoid boosting the same frequencies on both the instruments, trying to create some relations between kick and bass, where the kick wraps the bass and the opposite avoiding – when possible – to overlap frequency ranges.

SNARE

EQ	COMP
HPF: 50 > 250 Hz Body: 150Hz>250Hz Resonance (Cut) : 200>400Hz Attack: 5>8 KHz Air: 10>12 KHz	Attack: Med-Slow Release: Med-Fast Ratio: 4:1>8:1

TIP: Usually the Snare Drum is miked with two microphones (top and bottom). Sometimes it's necessary to invert the phase on one of them, especially is the microphone are positioned almost at 180°.

How can you quickly determine if phase shift is necessary?

Take a listen to the two channels in solo and shift the phase of one (generally the bottom); if you hear the low end increasing, then it would be better to keep the phase inverted, because some phase cancellation is occurring in absence of phase shift.

TOM

EQ	COMP
HPF: 50 > 200 Hz Body: 150Hz>250Hz Resonance (Cut) : 250>600Hz Attack: 4>8 KHz	Attack: Med-Slow Release: Med-Fast Ratio: 4:1>8:1

TIP:

- 1) Usually, Tom microphones capture cymbals so it's advisable to avoid extreme boost in the high-end frequency range; the Smooth Eq Shelving is perfect to cut some hi frequencies and gentle boost some mid-hi frequencies easily with a single pot!
- 2) The first Tom (typically positioned above the snare) usually captures a big part of the snare too;

It is better to place the microphone "looking" in direction of the floor tom but not the snare; this is a simple way to dramatically improve the efficiency of the Gate too.

HI HAT

EQ	COMP
HPF: 50 > 200 Hz Body: 150Hz>250Hz Resonance (Cut) : 250>600Hz Attack: 4>8 KHz	No Comp

OVERHEAD

EQ	COMP
HPF: 100 Hz > 1 KHz Body: 150Hz>250Hz Resonance (Cut) : 800Hz >2 KHz Air: 10>12 KHz	Attack: Med-Slow Release: Med-Fast Ratio: 4:1>8:1

TIP: The Overhead can be used in different ways. The classic approach is to capture only the cymbals; in this case, it makes sense to apply an HPF (above 300Hz) to reduce the presence of other instruments.

Especially in live gigs, it makes sense to use the Overhead also like a "stereo" drum source, using a reduced amount of HPF and adding a bit of compression and reverb. In this way, the Overhead mics are like the "Room Mics" generally used in studio recordings that can give to the overall sound a natural spaciousness that it's hard to achieve with close mics only.

BASS

Typical processing of the bass input signal requires both Compressor and Equalizer.

Due the versatility of the M Series Compressor, it can be used on bass for several purposes, from increasing the average volume – and limiting some pick – to adding some attack and aggressiveness to the overall sound.

All the EQ types are also usable on bass, with excellent results depending on the sound we are looking for.

As for the Drums, we recommend to use the Vintage EQ if you are looking for a solid and precise sound. The Standard EQ is as always a good choice for a neutral and surgical approach to the sound. The Smooth EQ, thanks to its unique curves, is perfect if you are aiming at a super thick sound avoiding tedious resonance in the mid-low range.

EQ	COMP
HPF: OFF > 40Hz Presence: 60Hz>100Hz Body: 100Hz > 150Hz Resonance: 180Hz >250Hz Presence: 1KHz>3KHz	Attack: Med-Slow Release: Med Ratio: 4:1>8:1

TIP: The Bass's extra Low frequencies could be critical in the overall sound of the mix. It is strongly suggested to check the extra low frequencies of the kick drum as well, to avoid overlap of the boost of some extra low frequencies. Again, the HPF is a great and simple tool to focus the low range.

Example: If you bass sound has a big presence below the 50Hz maybe it could be a good idea to check how it sounds in the mix cutting the frequencies below 50 Hz on the kick drum.

KEYBOARDS

The Equalizer is generally the most used processor on keyboards. Compressor is sometimes used to increase the attack (on the piano for example) and rarely to limit the dynamic range.

All the M Series equalizers can be used with great results; each one, with its own character, is able to tailor the sound in a very pleasant way. The Smooth EQ can be a great choice to gently sculpt the sounds increasing the focus and cutting easily at the same time some unwanted frequencies which usually cause some congestions in the mid-low and mid-hi range. As always, also on keyboards the HPF is the perfect tool to cut some not unuseful frequencies and immediately clean the mix allowing also to place the keyboard at an higher level in the mix.

Here are some suggested frequency ranges to be considered when approaching keyboard equalization:

EQ	
HPF: OFF > 400Hz Body: 100Hz > 200Hz Resonance: 180Hz >500Hz	Presence: 1KHz>3KHz Attack: 2KHz>8KHz Definition: 5KHz>12KHz

ELECTRIC GUITARS

The approach to the Electric guitar processing changes a lot according to the original sound.

The internal M Series guitar processor allows tons of tone possibilities that can be fine tuned also through EQ and Compressor.

Of course, you can use the mixer miking a real amp and cabinet, and in this case the internal processors could be used more to fine tune the sound.

EQ	COMP
HPF: OFF > 100Hz Body: 100Hz>200Hz Resonance (Cut) : 150>400Hz Presence : 900Hz > 2 KHz Attack: 2>5 KHz	Attack: Med-Slow Release: Med Ratio: 4:1>8:1

ACOUSTIC GUITARS

Acoustic Guitars are usually amplified during live gigs through a pickup, and only occasionally with mics.

The pickup sounds is often a bit harsh, and it may be necessary to smooth it reducing some extra high frequencies and adding some warm with EQ and Compressor.

EQ	COMP
HPF: OFF > 120Hz Body: 100Hz>200Hz Resonance (Cut) : 150>400Hz Presence : 900Hz > 2 KHz Attack: 2>4 KHz Harshness (Cut) : 8>12 KHz	Attack: Med-Slow Release: Med-Fast Ratio: 2:1>6:1

TIP: The Smooth EQ is the perfect EQ type to remove some harshness in the high-end, adding at the same time some definition to the sound of acoustic guitars in the mid-hi range.

The Smooth EQ is also great to increase the body of the sound removing some resonances using only one band!

VOICE

The Voice is a complex “instrument”, mainly because it can be emitted in several different ways.

The main problems to handle, especially during live gigs, are first the control of the dynamic range and then the balance of the frequencies according to the dynamic.

The M Series Compressor is absolutely transparent, and on voices it can be used to control the dynamic range also hardly without the classic *pumping* side effect.

All the M Series Equalizers can be used successfully to easily tailor the voice tone each one with its own unique character. If you want to gently boost the voice sound, making it more exciting, the Smooth EQ is for sure the first choice; if you want an aggressive, in-your-face sound, the Vintage EQ is the recommended selection and, as always, the Standard EQ is the perfect all-purpose choice.

EQ	COMP
HPF: OFF > 120Hz Body: 100Hz>200Hz Resonance (Cut) : 150Hz>300Hz Presence : 2KHz > 4KHz Air : 10KHz>16KHz	Attack: Fast-Med Release: Med Ratio: 4:1>6:1

TIP: When mixing, voice intelligibility is the main concern. The mid range is where the voice is mostly located, so be careful to check how other instruments work in that frequency range; usually it is better to cut some instruments that over-eq or increase the voice level.

A1 - Block Diagram

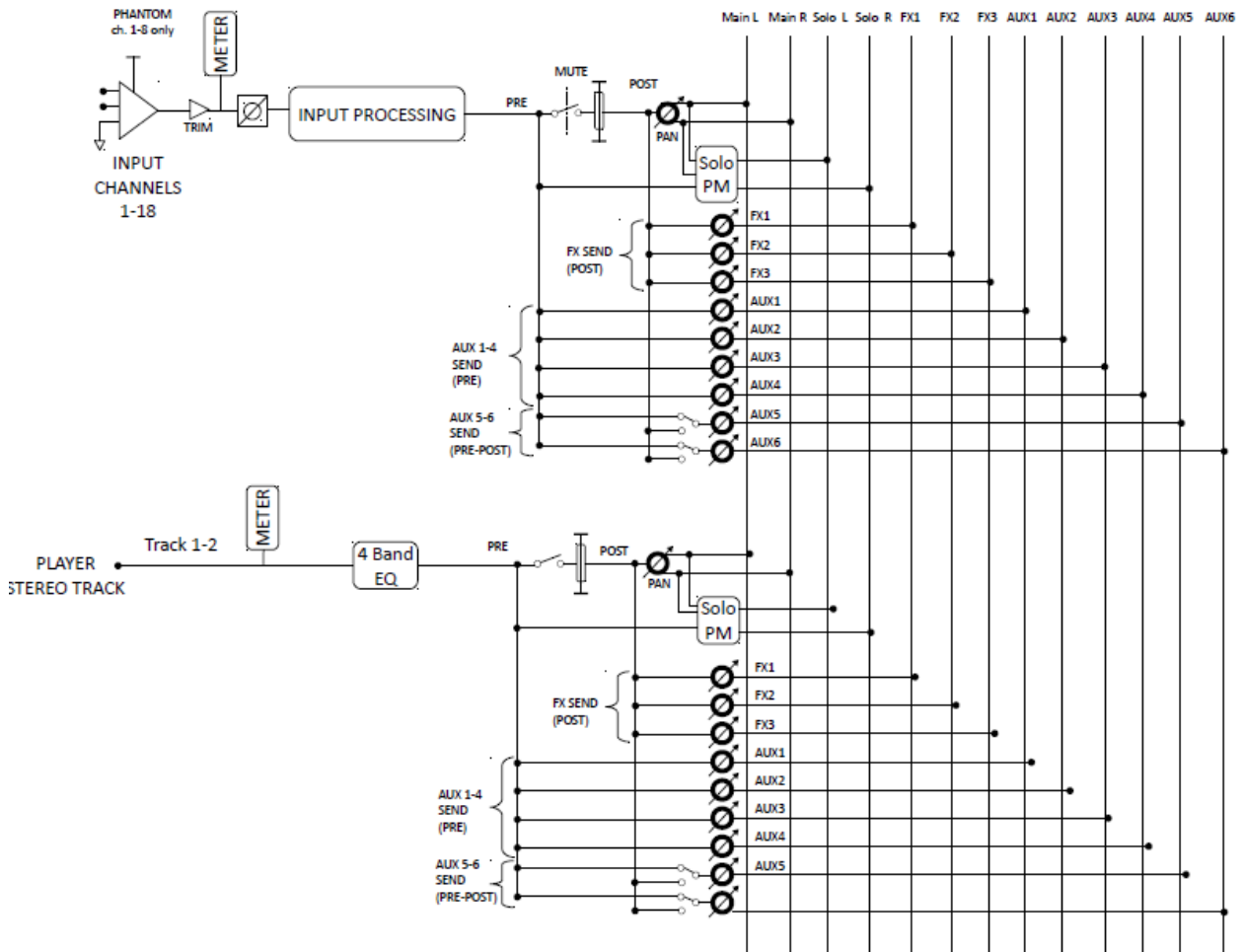

INPUT PROCESSING DETAIL

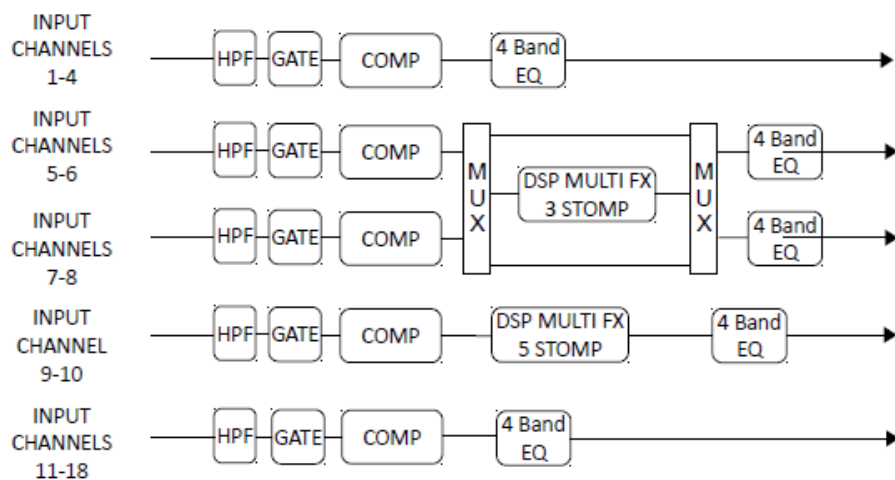

SOLO PM details

SOLO / P.M. BLOCK

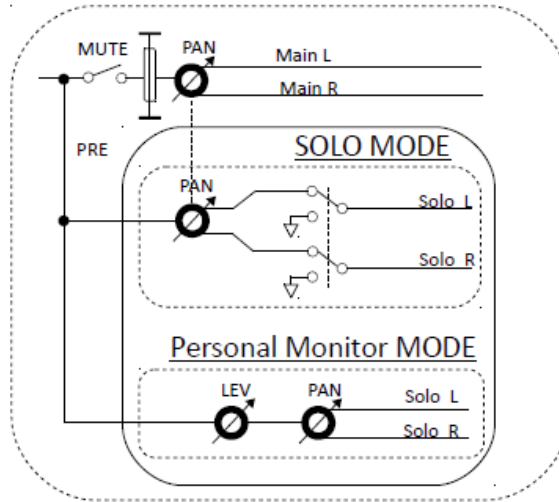

OUTPUT SECTION details

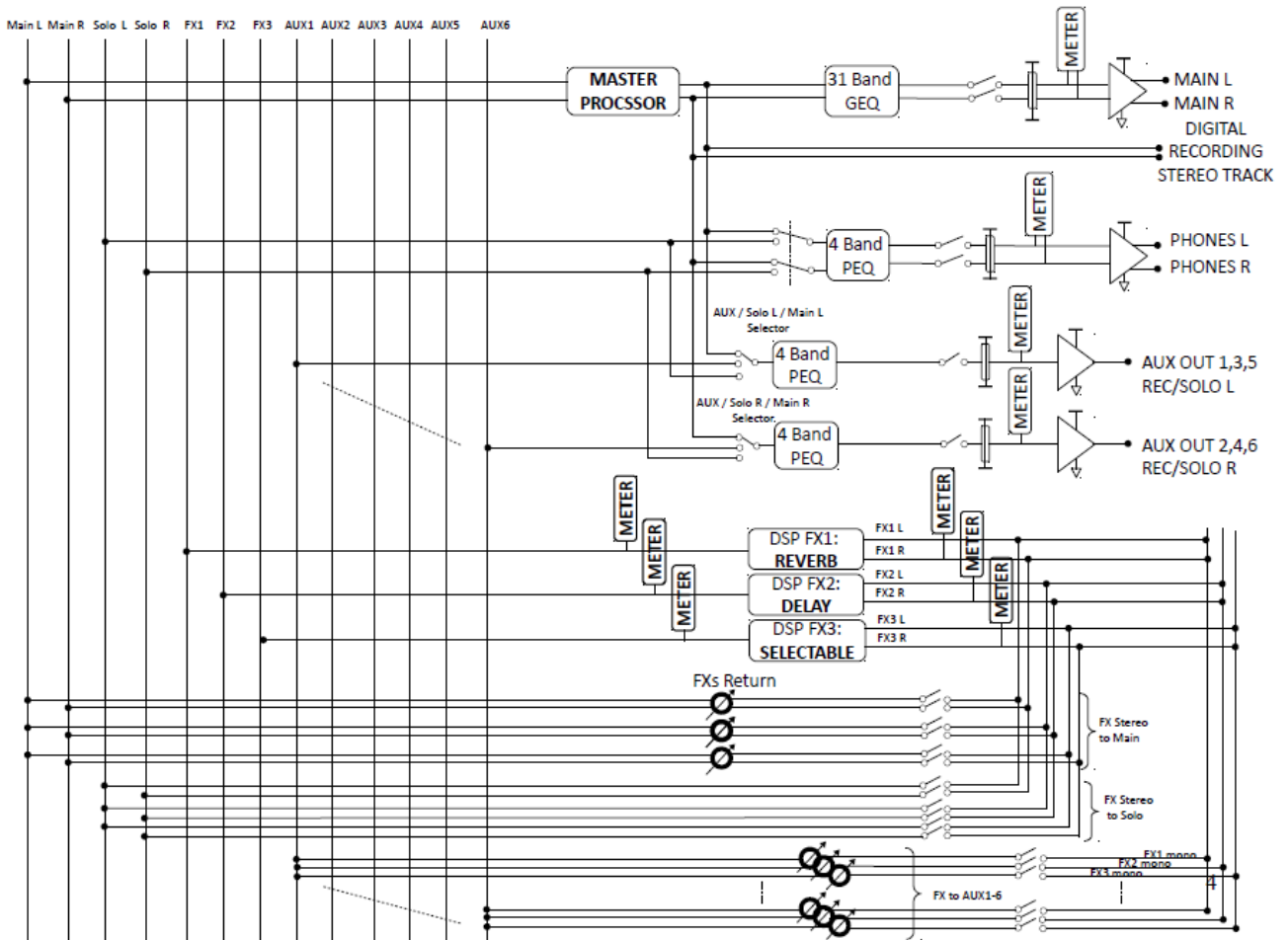

A2 – MIDI implementation chart

ON GLOBAL CHANNEL (default = ch 10)

MIDI message	Number	Assigned to	Transmitted	Recognized
Control Change	1	MAIN OUT LEVEL	YES	YES
Control Change	2	PHONES LEVEL	YES	YES
Control Change	3	AUX1 LEVEL	YES	YES
Control Change	4	AUX2 LEVEL	YES	YES
Control Change	5	AUX3 LEVEL	YES	YES
Control Change	6	AUX4 LEVEL	YES	YES
Control Change	7	AUX5 LEVEL	YES	YES
Control Change	8	AUX6 LEVEL	YES	YES
Note On	18	PLAYER PREV	--	YES
Note On	19	PLAYER NEXT	--	YES
Note On	21	PLAYER STOP	--	YES
Note On	22	PLAYER PLAY	--	YES
PROGRAM CHANGE	1-100	SNAPSHOT LOAD	--	YES
BANK SELECT (CC32)	0, 1	SNAPSHOT BANK	--	YES

ON MFXn CHANNELS

Defaults:

MFX1	Ch 11	disabled
MFX2	Ch 12	disabled
MFX3	Ch 13	disabled
MFX4	Ch 14	disabled

MIDI message	Number	Assigned to	Transmitted	Recognized
Note On	32	DEL ON/OFF TOGGLE	--	YES
Note On	33	MOD ON/OFF TOGGLE	--	YES
Note On	34	FX ON/OFF TOGGLE	--	YES
Note On	35	OD ON/OFF TOGGLE	--	YES
Note On	36	AMP ON/OFF TOGGLE	--	YES
Note On	42	PATCH PREV	--	YES
Note On	43	PATCH NEXT	--	YES
PROGRAM CHANGE	1-100	PATCH LOAD	--	YES