

G•Major

GUITAR PROCESSOR



USER'S MANUAL

TABLE OF CONTENTS

INTRODUCTION

<i>Table of Contents</i>	3
<i>Introduction</i>	5
<i>Front Panel</i>	6
<i>Rear Panel</i>	8
<i>Signal Flow Diagram</i>	9
<i>G•Major Setups</i>	10

BASIC OPERATION

<i>The Display</i>	12
Preset Handling	
<i>Recall</i>	13
<i>Edit</i>	13
<i>Store</i>	13
<i>Preset Backup Via MIDI</i>	14
Setup	
<i>I/O Setup</i>	14
<i>Utility & MIDI</i>	15
Additional Features	
<i>The Tuner</i>	17
<i>Levels All & Relay 1+2</i>	18
<i>Routings</i>	19
<i>Channel Switching and Tap Tempo</i> ..	20
Controlling the G•Major	
<i>Introduction</i>	21
<i>The Mod Menu</i>	21
<i>Modifiers</i>	22
<i>Assigning Modifiers</i>	23
<i>How To</i>	24

EFFECT BLOCKS

<i>Introduction</i>	25
<i>Noise Gate</i>	25
<i>Compressor</i>	26
<i>Chorus</i>	28
<i>Flanger</i>	30
<i>Vibrato</i>	31
<i>Resonance Filter</i>	32
<i>Phaser</i>	33
<i>Tremolo</i>	34
<i>Panner</i>	34
<i>Delay</i>	35
<i>Pitch Detune</i>	38
<i>Whammy</i>	38
<i>Pitch Shifter</i>	39
<i>Reverb</i>	40

APPENDIX

<i>Important Safety Instructions</i>	44
<i>MIDI Implementation</i>	46
<i>Technical Specifications</i>	47
<i>Preset List</i>	48

INTRODUCTION

Congratulations on the purchase of your G•Major Effects processor.

If you have never used a multi-effects processor with your guitar rig, you might be wondering at this point whether you have placed yourself in a position where you have days of work ahead of you, until your G•Major behaves as you please and adds to your creativity. No need to panic!

With the presets already existing your basic needs are most likely covered and you will be set to go within minutes.

But chances are that you probably will like to go beyond factory presets and find a more personalized usage of the G•Major - and that won't be a hassle either.

Stomp Box Setup

If you are used to working with stomp boxes you might want to use the G•Major for a similar setup and simply benefit from high quality of effects. With any MIDI pedal sending MIDI Control Change values the G•Major can be setup and used just as a bunch of regular stomp boxes where you simply turn effects on and off.

Preset Setup - for ultimate changes in sounds

Another approach would be creating unique presets for each sound accessible via a single press on a MIDI foot-controller. Or - you could combine the preset-approach with the on/off-stomp box setup mentioned above.

Channel Switching

Changing your sound from a crisp clean dry rhythm sound to an overdriven lead sound, will often involve channel switching of your Preamp or Combo in addition to changing your effects preset. To be able to switch amp-channels via MIDI the investment of a separate MIDI switching system is often implied. Not with the G•Major. With the built in Relay Switching on the G•Major you are able to switch between up to 4 channels on you Preamp/Combo.

Modifiers - Instant parameter control

If utilizing the above still doesn't give you the sought after flexibility you are looking for, instant parameter control via the Modifier section of the G•Major is probably the answer. Many algorithm parameters can be assigned to an external MIDI controller or Expression pedal. The possibilities here are endless. With an Expression Pedal you can not only control any level of a specific effect, you could also e.g. change the Panning Speed - or what about using the Expression pedal as a customized Whammy pedal.

Quality

With the G•Major TC Electronic introduces a Guitar Effects Processor in the "affordable" price range.

You should however not be deceived by the price as the G•Major delivers true top quality processing with no unwanted coloring of your beloved guitar-tone. As one of the leading companies in the business of signal processing the vast amount of knowledge and experience concentrated at TC Electronic is all for your benefit. Though each product is unique it is worth noticing the success and achievement gained on other products from TC Electronic. Prices won for astounding Reverb quality, Compression techniques and numerous other classic TC effects such as Dynamic Delay and Chorus guarantees also the quality of this product. Logical operation via the intuitive user interface will let you setup a series of quality sounds accessible from any attached MIDI pedal in just a few minutes.

The quality of the effects in the G•Major are guaranteed, but furthermore we are confident that once you have spend a few hours twisting the few controls on the G•Major, assisted with this manual, you will start to appreciate the numerous possibilities within the G•Major.

Enjoy - and have fun

FRONT PANEL

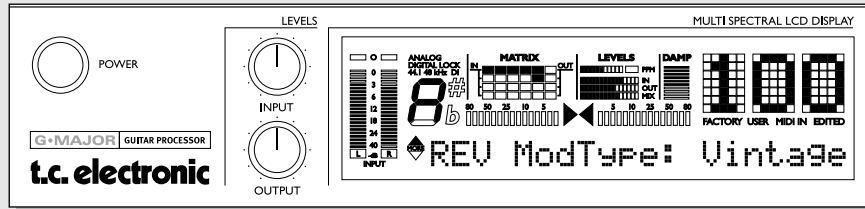

POWER KEY

On/Off switch for the unit.

INPUT LEVEL KNOB

Adjusts the Input level.
Range: 24dB

OUTPUT LEVEL KNOB

Adjusts the Output level.
Range: 24dB

INPUT METERS

Peak meter showing Input level.
The Meter range is: 0, -3, -6, -12, -18, -24, -40dB.

INPUT OVERLOAD LEDS

The Overload LEDs indicates one of two situations: The Input level is too hot and therefore overloading or there is an internal DSP overflow.

INPUT TYPE - ANALOG DIGITAL

Input selection is done in the I/O section accessed by pressing the I/O key.

Analog: Indicates analog Input mode is selected.

Digital Lock: Indicates that digital lock is achieved with a device connected to the Digital Input.

44.1/48kHz: Indicates whether the achieved digital lock is at 44.1kHz or at 48kHz.

If a digital device is connected to the digital Input on the G-Major but no lock is achieved, the Digital Lock indication will blink.

DI LED

Indicates that external digital Clock Input is selected.

TUNER

The G-Major holds a Tuner. The tuner is always active. When the instrument is in tune the two arrows will both be lit.

THE MATRIX

The G-Major holds 3 different effect block routing options. Serial, Semi Parallel and Parallel. The matrix illustrates the structure of the used routing.

LEVELS SECTION

These parameters refer only to the block being edited.

PPM - Peak Program Meter:

Indicates the peak level of the effect block currently being edited.

IN Meter:

Indicates the block Effect Input Level.

OUT Meter:

Indicates the Effect block Output Level.

MIX Meter

Indicates the Effect Block Mix level.

DAMP

If both the Noise Gate and the Compressor is in use the DAMP indicator will indicate the Noise Gate attenuation when no Input signal is present and the applied

compression when Input signal is present.

PRESET NUMBER

When steady the currently recalled preset number is displayed. When previewing presets the number will blink until the preset is recalled by pressing the RECALL key.

EDITED

When this LED is lit the currently recalled preset has been edited but not yet stored.

FACTORY/USER

Indicates whether you are operating in the Factory or in the User bank.

MIDI IN

Indicates incoming MIDI information.

SELECT (Outer)

- ADJUST (Inner) wheels

The two wheels are used to handle one significant parameter from each effect block. Turn the outer SELECT to scroll between seven parameters (one from each block plus Noise Gate). Now use the ADJUST wheel to select value. After 2 seconds untouched the display returns to its previous state.

FRONT PANEL

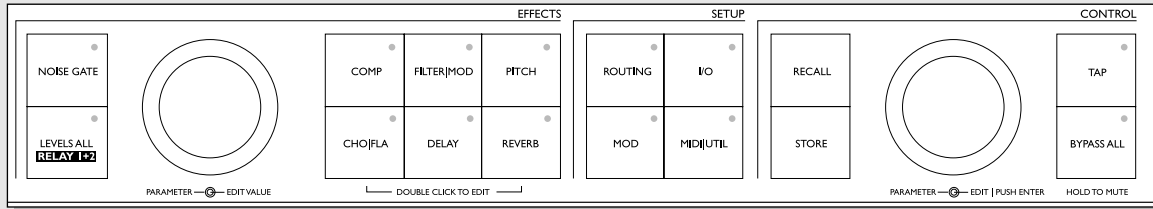

FRONT PANEL KEYS GENERAL INFORMATION

A single click will activate/deactivate the effect. Double clicking on the key will enter the Edit menu of the effect algorithm. Lit key LED indicates active effect block.

NOISE GATE KEY

On/off key for the Noise Gate block.

LEVELS ALL/ RELAY 1+2

Press to access global Level parameters and settings for the two Relay switches that will allow you to e.g. switch channels on you combo/head or preamp.

COMP

On/Off key for the Compressor block.

CHO/FLA

On/Off key for the Chorus/Flanger block.

FILTER/MOD

On/Off key for the Filter and Modulation block.

DELAY

On/Off key for the Delay block.

PITCH

On/Off for the Pitch block.

REVERB

On/Off key for the Reverb block.

ROUTING

Press to access the Routing section. This is where you select the routing of your effect blocks.

MOD

Press to access the Modifier section. This is where you setup which parameters that should be controlled externally, e.g. via a connected Expression Pedal.

I/O

The I/O menu is where you control all Input and Output related parameters.

MIDI/UTIL

Press to access all MIDI and other general parameters.

RECALL

Press RECALL to initiate a recall operation. Use the EDIT wheel in the Control section (inner wheel) to select preset. Then press ENTER (EDIT wheel) or RECALL to confirm operation.

STORE

Press STORE once to initiate a store operation. Select location using the EDIT wheel in the Control section (inner wheel). Now press ENTER to confirm

operation.

The name of the preset can be altered before pressing ENTER for confirmation. To do this use the PARAMETER wheel in the Effects section to select letter-space and the VALUE wheel to select letter. When done press ENTER twice to confirm entire STORE operation.

PARAMETER WHEEL (Outer) & EDIT WHEEL (Inner) ENTER (Push for Enter function)

These two wheels are used to handle all setup and non-effects related parameters. The PARAMETER wheel is used to select parameters. The EDIT wheel is used to adjust values. Push the EDIT wheel for Enter/Confirm functions.

TAP

Tap to enter global tempo. Effects related to tempo as e.g. the Delay block can use this tempo or a subdivision thereof. The LED in the key will blink according to the current global tempo.

BYPASS ALL

Press to bypass all effects. Press and hold for approx. 1 sec to mute Outputs for e.g. silent tuning.

REAR PANEL

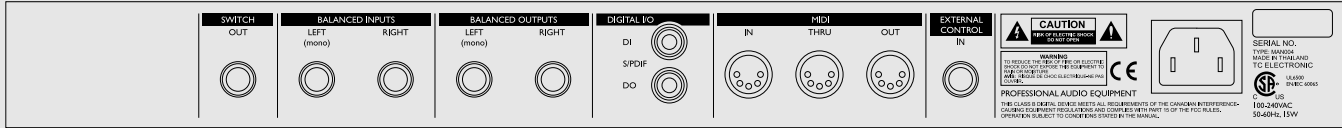

**Switch
Out
Relay
Jack**

**Balanced
Jack
Analog
Inputs**

**Balanced
Jack
Analog
Outputs**

**Digital
S/PDIF
Input/
Output**

**MIDI
In, Out, Thru**

**External
Control**

**Power
Input
100 - 220V**

Note!

The analog Input and Output connectors on the G+Major are balanced 1/4" jacks. Optimal connection to balanced equipment is achieved using balanced cables. However most guitar equipment is NOT balanced and you will generally have no problems using standard mono-to-mono cables as illustrated below.

MIDI Cable

DIN CONNECTOR
5POLE - MALE
45 degrees

DIN CONNECTOR
5POLE - MALE
45 degrees

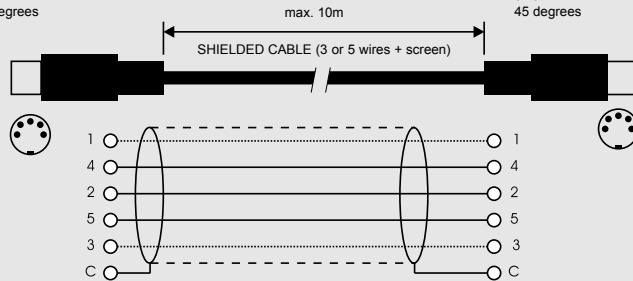

Jack Cable Mono to Mono

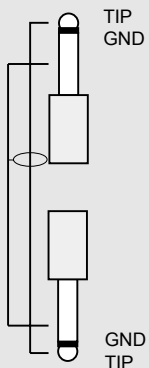

Jack Cable Stereo to Mono

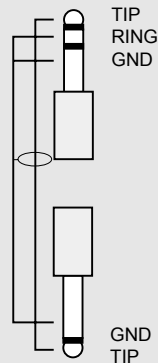

Relay Jack Cable - Stereo Jack Type

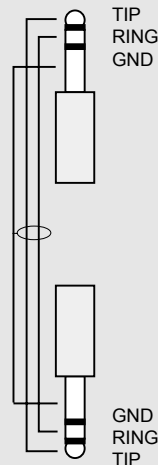

Relay Jack Cable - Y-Splitter Type

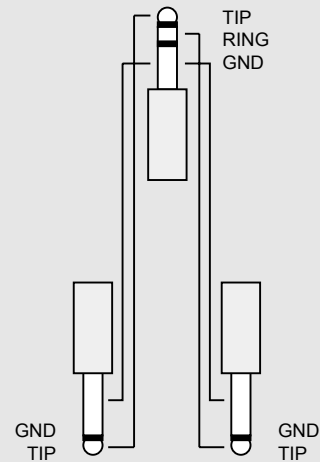

SIGNAL FLOW

G•Major

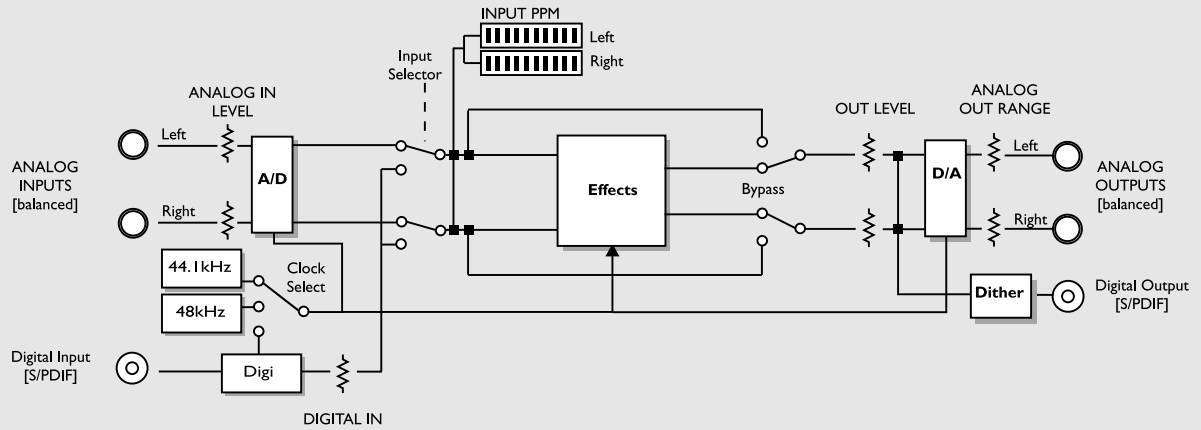

G•MAJOR - SETUPS

Connecting and Setting up the G•Major

There are numerous ways of hooking up guitar rigs. On these pages we have listed some of the most commonly used setups. We recommend using serial setups where the entire signal passes through the G•Major. This will give you the maximum benefit from all effect algorithms. As stated several times in this manual, you should NOT worry about coloring of your sound as TC Electronic uses top quality converters that does NOT color your tone.

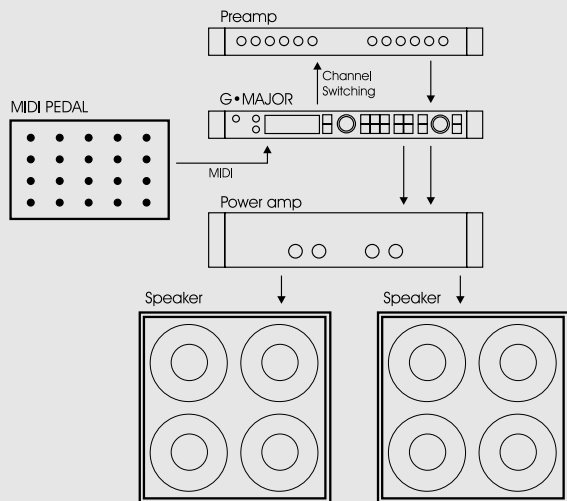

Serial Setup with Preamp and Power Amp

- Connect the Output of your preamp to the Input of the G•Major.
- Connect the Output of the G•Major to the Input of your power amp.
- To be able to switch preamp channels with the G•Major connect the Relay Jack connection on the G•Major to the channel switching jacks on the preamp. (This does not apply for MIDI preamps).

Serial Setup with Preamp and one or two Combo Amps

- Connect the Output of your preamp to the Input of the G•Major.
- Connect the Output of the G•Major to either the Input or the Loop Return of the Combo or Combos.
- To be able to switch preamp channels with the G•Major, connect the Relay Jack connection on the G•Major to the channel switching jacks on the preamp. (this does not apply for MIDI preamps).

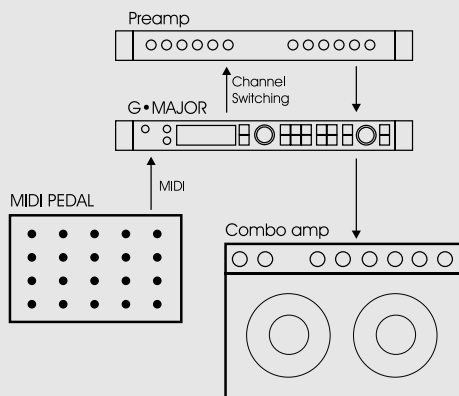

Using the return on the Combo's effect loop will in most cases give you a setup similar to the power-amp setup described above.

Using the regular Input on the Combo gives you a "double-preamp" setup where you can use the tone controls on the Combo to color your sound. This introduces more noise than when using the Effect Return connection, but has become a popular setup with amplifiers like Vox AC 30, Fender Bassman etc.

G•MAJOR - SETUPS

Connecting and Setting up the G•Major

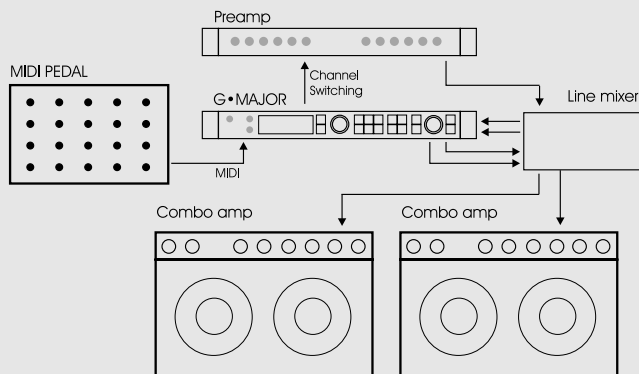

Parallel Setup using a Line Mixer

- Connect the Output of your preamp to the Input of the Line Mixer.
- To be able to switch preamp channels with the G•Major connect the Relay Jack connection on the G•Major to the channel switching jacks on the preamp. (this does not apply for MIDI preamps).
- Connect the Line Mixer Loop Outputs to the G•Major Inputs and the G•Major Outputs to the Line Mixer Loop Inputs.
- Connect the Line Mixer main Outputs to your amplification.

The Illustration shows Combos - these could also be a power amp, and the Preamp could easily be the Preamp-section of a Combo amplifier.

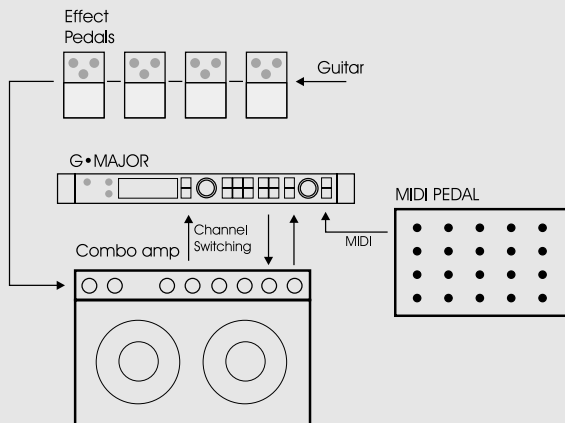

Combined Setup with Regular Effect Pedals, a G•Major and a MIDI pedal

- Connect the Combo's Effect loop Out to the G•Major Input.
- Connect the G•Major Output to the Effect loop Input.
- Connect your guitar to your pedals and your pedals to the Input of the Combo as usual.
- If you wish to switch presets on the G•Major e.g. including Channel switching of the Preamp/Combo you should also connect a MIDI pedal to the G•Major and use the Relay Switching function.

THE DISPLAY

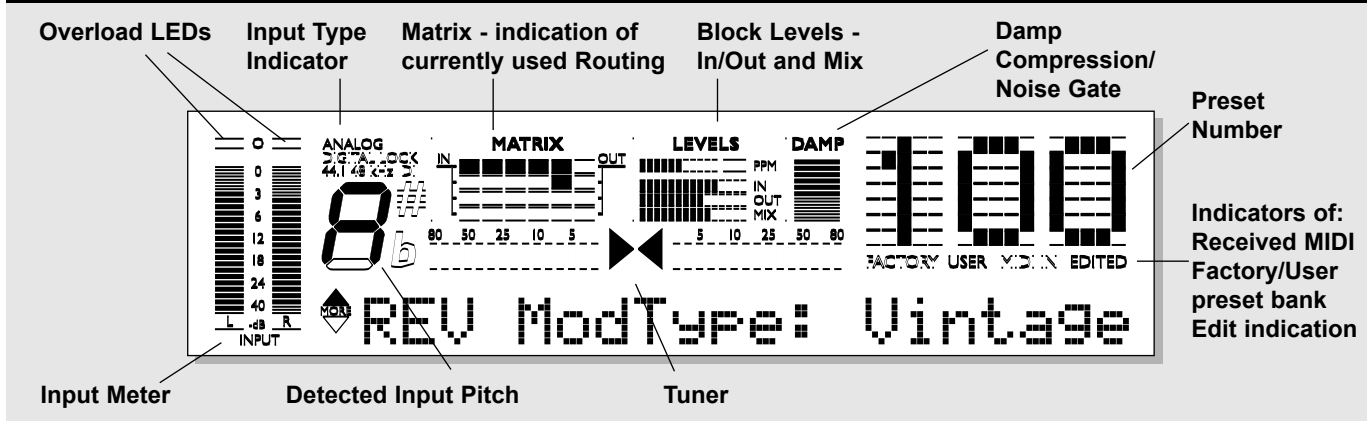

Input Meters

Peak meter showing Input level.

The Meter range is: 0, -3, -6, -12, -18, -24, -40dB.

To set correct Input level:

Select the "loudest" sounds containing the most dynamic content on the equipment you are feeding the G•Major with, e.g. your preamp. This will probably be a clean sound. Adjust the Input level at the G•Major so the -3dB LED flashes frequently and the -0dB LED flashes only at absolutely highest levels.

Input Overload LEDs

The Overload LEDs indicates one of two situations:

The Input level is too hot and therefore overloading or there is an internal DSP overflow. The Overload LED is lit when 1 sample is @ 0dBFS.

Reduce either the Output of the device feeding the G•Major or Input gain on the G•Major using the Input level knob.

Input Type and Clock

Input selection is done in the Utility section accessed by pressing the I/O key.

Analog/Digital: Indicates selected Input mode.

Lock: Indicates that digital lock is achieved with a device connected to the Digital Input.

44.1/48kHz: Indicates the current Clock Rate.

DI LED: Indicates that external digital Clock Input is selected.

If a digital device is connected to the digital Input on the G•Major but no lock is achieved, the Lock indication will blink. Check cables and Clock Rate on the connected device and try again.

Tuner

The G•Major holds a Tuner, which is always active. The two arrows will both be lit when the instrument is in tune. If a TC Electronic G•Minor MIDI pedal (optional) is used you can also have the Tuner displayed in the Pedal.

The Matrix

The G•Major holds 3 different effect block routing options. This matrix indicates which of the three that is used.

Levels Section

These parameters refer only to the block being edited.

PPM - Peak Program Meter:

Indicates the level of the block currently being edited.

IN Meter:

Indicates the present Input Level in the block currently being edited.

OUT Meter:

Indicates the parameter position of the Output Level in the block currently being edited.

MIX Meter:

Indicates the parameter position of the Mix level in the block currently being edited.

THE DISPLAY

DAMP

If both the Noise Gate and the Compressor is in use the DAMP indicator will indicate the Noise Gate attenuation when no Input signal is present and the applied compression when Input signal is present.

Preset Number

When steady the currently recalled preset number is displayed. When previewing presets the number will blink until the preset is recalled.

Edited

When this LED is lit the currently recalled preset has been edited but not yet stored.

Factory/User

Indicates whether you are operating in the Factory or in the User bank.

PRESET HANDLING

Preset types

User presets - RAM

User presets that can be edited and stored in any User location. You can store up to 100 user presets in the User bank.

Factory presets - ROM

The G•Major holds 100 factory presets. Factory presets that can be edited and stored in any User location. You cannot store presets into a factory location.

Recall

Recalling a Preset

Recalling a preset means loading/activating a preset.

- Press RECALL to enter the RECALL menu.
- Use the EDIT wheel to preview presets. Blinking preset number indicates Preview mode. Previewing means that you are not actually changing/loading the preset until ENTER is pushed.
- Press ENTER or RECALL to recall/activate the preset. (ENTER is the center-dialer in the Control section)

Press any other key at any time during previewing to abort mission and return to the currently recalled preset.



Previewing and Routings:

When previewing a preset with a Routing that is different from the Routing currently used the Routing/Matrix LEDs will be blinking.

Edit

To edit preset parameters

- Double click on the Effect block key you would like to edit.
- Select parameters using the PARAMETER wheel and change values using the EDIT wheel.
- See the following section for instructions on how to store a preset.

PRESET HANDLING

Store

To store a preset with the same name:

- Press STORE.
If the preset you are about to store is a Factory preset the G•Major suggests the first available User location but you can select any of the 100 locations using the EDIT wheel.
If the preset you are about to store is a User preset, the G•Major suggests the current location of the preset.
You can, however, store at any of the 100 User locations. Select location using the EDIT wheel.
- Press ENTER twice to confirm store operation.

To rename a preset while storing:

- Press STORE.
If the preset you are about to store is a Factory preset the G•Major suggests the first available User location but you can select any of the 100 locations using the EDIT wheel.
- Press ENTER once.
- Select storing location using the CONTROL EDIT wheel.
- To alter the preset name; use the PARAMETER wheel to move cursor and the EDIT wheel to select character.
- Press ENTER twice to store the preset with the new name.

Presets Backup Via MIDI

The User bank can be dumped for backup via MIDI to either a sequencer or another G•Major. This is how to do it:

- Connect G•Major MIDI Out to MIDI In on either another G•Major or sequencer.
- Enter the Utility menu by pressing the MIDI/UTIL key and scroll to select "Bulk Dump" using the CONTROL PARAMETER wheel.
- If connected to another G•Major simply press ENTER and the entire User bank will be copied to the other G•Major.
- If connected to a sequencer let the sequencer record in OMNI mode (all channels) and press ENTER on the G•Major.

The G•Major is always ready to receive a MIDI Bulk Dump. Simply connect MIDI Out from the device you are dumping from to MIDI In on the G•Major. If you are dumping from a sequencer, simply play the sequence holding the BULK information. If dumping from a G•Major - see above!

I/O SETUP

I/O Setup

In the I/O menu you will find all I/O related parameters such as Input/Output settings, analog/digital, Status Bit and Dither. For any successful operation of the G•Major these parameters must be correctly set!

All parameters in the I/O menu are "general" parameters that are not stored with the presets.

Basic Operation

- Press I/O
- Select parameters using the PARAMETER wheel in the Control Section.
- Change values using the EDIT wheel.

Input

Select between Analog and Digital.

Analog Input

When "Analog" is selected the G•Major automatically defaults to the internal 44.1kHz clock as Sample Rate.

Digital Input

When "Digital" is selected the G•Major attempts to lock to the S/PDIF Input. During the lock-up period the LOCK icon blinks indicating none or unacceptable clock, and the Outputs are muted.
When lock is achieved the LOCK icon turns solid, and the Outputs are un-muted.

Clock

Analog Input

When Input source is analog the following Sample Rates are available:
Internal 44.1kHz - The G•Major runs at internal 44.1kHz.
Internal 48kHz - The G•Major runs at internal 48kHz.
Digital - The G•Major locks to the incoming Digital clock.

Digital Input

When Input Source is digital the following Sample Rates are available:
Internal 44.1kHz - The G•Major runs at internal 44.1kHz.
Internal 48kHz - The G•Major runs at internal 48kHz.
Digital - The G•Major locks to the incoming Digital clock.

I/O SETUP



Please note that when using internal clock with external digital audio, the incoming digital audio must be in sync with the G•Major internal clock in order to avoid slip-samples.

****Rate Mismatch****

This Error message will occur in the display if the G•Major detects slip-samples. Typically this problem only occurs in special clock setups e.g. if the G•Major is running via internal clock, while processing audio from the Digital Input. If the incoming clock and the internal clock do not match the G•Major will display the above written error message.

Digital In Gain

Adjusts the Digital In level. This parameter is only active when Digital In is selected.

Dither

Going from one type of bit resolution to a lower, e.g. from 24 bit to 16 bit, you actually lose 8 bits of information. The process of cutting off bits is called truncation and it introduces digital distortion of low level signals, due to lack of complete signal information. To compensate for this - dither must be applied. Dither is a small amount of filtered noise that generates randomization at the noise floor, ensuring a less distorted low level signal.

Dithering is relevant only on digital Outputs and it is always the receiving device that determines the number of bits you must dither to. A signal delivered to a CDR or a DAT recorder should normally be dithered to 16 bit.

In other words - when using the digital Outputs from the G•Major to feed any 16 or 20 bit equipment you should dither to that value via the G•Major.

Status Bits

Sets whether the G•Major is sending out AES/EBU (professional standard or S/PDIF (consumer standard) status bits.

Input Range

Range: Pro/Consumer

Sets the sensitivity of the G Major Input.

Default setting is "Pro" which will match most preamps.

Output Range

Range: 2dBu, 8dBu, 14dBu, 20dBu

Sets the maximum Gain range of the analog Output Stage.

MIDI/UTIL

All parameters in the I/O menu are "general" parameters that are not stored with the presets.

MIDI Channel

Range: Off/1-16/Omni.

Sets the responding MIDI channel of the G•Major.

If Omni is selected the G•Major will respond to MIDI information received on any channel.

MIDI Program Change

Range: On/Off.

Determines whether the G•Major should respond to received MIDI program changes or not.

Bulk Dump

Press ENTER to perform a total Bulk dump of all presets to an external MIDI device such as a MIDI sequencer.

The G•Major is always ready to receive MIDI Bulk dump information. See the section "Presets Backup Via MIDI" for more information on this in the Preset handling chapter.

Single presets and current settings can be sent and received.



The "Send Tuner" parameter **MUST** be set to off when performing a bulk dump. The "Send Tuner" function is located further down in the Utility menu.

Program bank

Determines which bank an external MIDI device will address in the G•Major when sending a program change.

The options are; External, Factory or User.

When External is selected controller #32 can be used to address either the Factory or the User bank.

Factory bank: Controller #32=0

User bank: Controller #32=1

SysEx ID

Determines the Sys-Ex ID number of the unit.

Pedal Type

Sets up the pedal type used on the Ext. Control 1/4" jack.

Select between Momentary, Alternating or Expression-Volume pedal types.

Momentary types are similar to hold pedals typically used on keyboards, where there is only connection between tip and ground when the pedal is pressed. Alternating pedal types "stays connected" when pressed, and must be pressed again to be deactivated. Default setting is Expression.

Pedal Calibrate

For the G•Major to respond correctly to the actions performed by a connected Expression pedal, the G•Major must be calibrated to the specific pedal.

- Connect your pedal and select appropriate pedal type.
- Select Pedal calibrate and press ENTER.
- Move pedal to Max position (heel up) and press ENTER.
- Move pedal to Min position (heel down) and press ENTER.
- Your pedal has been calibrated.



Depending on the pedal type you are using you can be asked to repeat steps 3 and 4.

Tuner Ref.

Range: 420 to 460Hz

Sets the master Tune frequency of the built in Tuner. 440Hz is the standard setting.

Tuner Mode

The Tuner can operate with two different accuracy's.

Fine Tune

Maximum accuracy. Use this mode when fine-tuning your guitar.

Coarse

Slightly less accurate mode, allowing for fast results in a live situation.

Tuner Range

Sets the range of the Tuner. Select between Bass, 7-string Guitar and Guitar. The accuracy of the Tuner is dependent on this tuner range, and it is therefore important to set this parameter according to the instrument you desire to tune.

Send Tuner

Set this parameter to "On" to feed a connected G•Minor with Tuner information.

MOD Master

Range: Read/Ignore

If you are not acquainted with Modifiers you can read about them in the Modifier Section of this manual.

In short - parameter values can be controlled via an external controller such as e.g. a MIDI Expression pedal. If setup to control e.g. the Preset Out Level you must decide via this MOD Master parameter how you would like the

G•Major to respond to the position of the Expression pedal at preset changes. Choosing between the following options depends very much on what your Modifier is set up to do/control.

Mod

If set to "Mod" the G•Major will at any preset change check the position of the connected external Controller and respond to this position thereby ignoring the Modifier value for the relevant parameter.

Preset

If set to "Preset" the G•Major will ignore the position of the connected External controller and load the Modifier value stored with the preset.



If using Ignore function with an Expression Pedal that is controlling a level parameter, you should be aware that next time you move the pedal the parameter will jump to the value equivalent to the pedal position. This could in some cases mean a considerable jump in level.

Tap Master

Preset : Tempo will follow presets.

Tap : Tempo will follow the Global tapped tempo.

Tap Unit

Selects whether the tapped tempo in the Tap Menu should be displayed in milliseconds (ms) or in Beats Pr Minute (BPM).

MIDI Clock

Range: On/Off

The Global Tap Tempo can be synchronized to an Incoming MIDI clock from e.g. a MIDI sequencer. Thereby you can keep the Speed of a Tremolo or a Delay Time in sync with the Tempo of the song.

FX Mute

Range: On/Off

This parameter determines how Delay and Reverb effects should be handled at preset changes.

On : Effects are muted at preset change.

Off : Delays will "spill over" and Reverbs are smoothly glided to the setting in the preset you access.

View Angle

Adjusts the LCD display backlight for better viewing comfort.

THE TUNER

The Tuner is always on, and displayed in the LCD display.

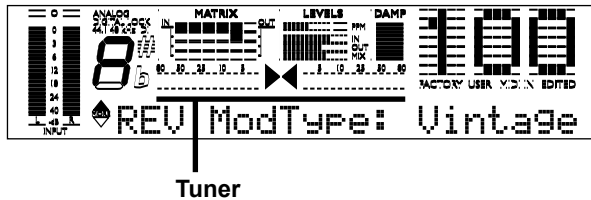

The following parameters are set in the Utility.

- Press MIDI/UTIL to access the menu.
- Use the CONTROL PARAMETER wheel to select parameter.
- Use the EDIT wheel to set values.

Tuner Mode

Sets the mode of the Tuner. Choose between two modes:

Fine Tune

Maximum accuracy. Use this mode when fine-tuning your guitar.

Coarse

Slightly less accurate mode, allowing for fast results in a live situation.

Tuner Range

Sets the range of the Tuner. Select between Bass, 7-string Guitar and Guitar (6 string). The accuracy of the Tuner is dependent on this Tuner range, and it is therefore important to set this parameter according to the instrument you desire to tune.

Tuner Frequency

You can set the master tuning reference in the Utility menu. The range is from 420 Hertz to 460 Hertz. Standard tuning is 440Hz but often when playing with classical instruments frequencies from 438 to 442Hz are used as tuning reference.

Tuner Mute

It is often a good idea to mute the Output of your G•Major when tuning your guitar. You can setup either a MIDI pedal sending a MIDI CC or a momentary or alternating switch or even an Expression pedal to control the mute function. This is set up in the Mod section.

Example

Setting up the G•Major to mute for tuning when receiving a MIDI Control Change from your MIDI pedal.

- Connect your MIDI pedal to the G•Major.
- Press MOD and select the Tuner Mute parameter using the PARAMETER wheel in the Control section.
- Press ENTER to set the G•Major in “Learn” mode.
- Press the Control Change button on the MIDI pedal you would like to react as “Tuner Mute”.

That's it - whenever you press this button in the future you will be able to tune without disturbing your fellow musicians.



It is a common choice to use an Expression pedal to control the Input volume. If you do this, the tuner will still be active when you turn down the volume entirely.

The G•Major Tuner and the G•Minor Pedal

If using the optional TC Electronic G•Minor Pedal the Tuner is displayed in the pedal as well.

The Output Mute function for silent tuning is of course also accessible via the optional G•Minor pedal.



The Send Tuner parameter in the Utility menu MUST be set to “On” to feed tuner information to a G•Minor pedal.

LEVELS ALL & RELAY 1+2

Basic Operation

- Press the LEVELS ALL key to enter this menu.
- Use the PARAMETER/EDIT wheels in the Control section to select and edit parameters and values.

Preset Out Level

Range: Off (-100dB) to 0dB.

Sets the Output level of the current preset. This allows level adjustment of each preset, enabling you to make application specific presets, such as lead and rhythm presets. The Preset Out level is stored with the preset. Please note that all factory presets is set to -6dB, leaving headroom for additional individual preset boost. This parameter can be remote controlled via MIDI or the Ext. Control jack and is set up in the "Mod" menu.

An example on how to setup a solo level is given in the "How To" section in this manual.

Global In Level

Range: Off (-100dB) to 0dB.

Sets the overall Input level of the G•Major.

As the parameter name states this level is global and therefore not stored with presets.

Using the Global Input level as overall volume for your guitar setup, will allow the effects to ring out after volume has been turned down, e.g. Reverb and Delays will continue their natural decay.

This parameter can be remote controlled via MIDI or the Ext. Control jack. This is set up in the "Mod" menu.

Global Out Level

Range: Off (-100dB) to 0dB.

Sets the overall Output level of the G•Major.

As the parameter name states this level is global and therefore not stored with presets.

Using the Global Out level as overall volume for your guitar setup, instant volume control of your entire setup, including decaying effects, is possible.

This parameter can be remote controlled via MIDI or the Ext. Control jack. This is set up in the "Mod" menu.

Relay 1 and 2

G•Major has a built in switching relay that allows analog pre-amps or other equipment to be controlled through the preset change of the G•Major. The setting of Relay 1 and 2 is stored with your presets so you can switch channels on your preamp or power amp from preset to preset.

You can also switch channels sending a MIDI CC value MIDI foot controller without changing presets.

- Relay 1 shorts the tip of the switching 1/4" jack with the sleeve/GND, when set to On. Off position means that the relay is open.
- Relay 2 shorts the ring of the switching 1/4" jack with the sleeve/GND, when set to On. Off position means that the relay is open.

These parameters can be remote controlled via MIDI or the Ext. Control jack. This is set up in the "Mod" menu.

ROUTINGS

Routing Menu

The G•Major holds three different effects routings. The Routings can be stored with the preset. However you can also choose to fixate your favorite routing by utilizing the "Routing lock" function. Consider the Routing as how you would connect your stomp boxes on a regular pedal board.

Operation

- Press ROUTING.
- Select Routing Lock or Routing type using the PARAMETER wheel.
- If selecting Routing type select Serial, Semi Parallel or Parallel using the EDIT wheel and confirm with ENTER.

Serial

The Serial routing connects all seven effect blocks in straight line, connecting one effect to the next equal to a regular guitar stomp box setup. This means that the preceding effect blocks affect any effect block.



If using a long Delay in the Delay block you might find the added Reverb on the Delay repeats disturbing. In that case use either Semi Parallel or Parallel routing.



Semi Parallel

Semi Parallel still connects the first five effect blocks in serial, but the Reverb and Delay blocks are now connected in parallel. Consequently the Delay and Reverb effects do not affect each other. This would e.g. mean that the repeats of the Delay are not reverberated and vice versa. The parallel connection of the Reverb and Delay may help to clear the effects picture.

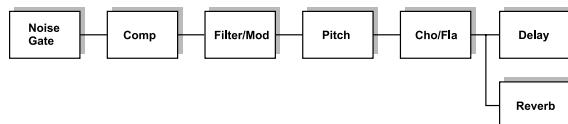

Parallel

The Parallel routing still allows serial based effects like the Noise Gate, Compressor and Tremolo to be connected in serial but additionally connects the Pitch, Chorus, Delay and Reverb in a parallel setup.

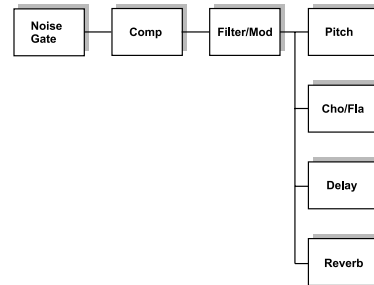

Routing Lock

The Routing Lock function is the first parameter located in the Routing menu. It is accessed simply by pressing the ROUTING key.

At each MIDI program change the Routing-status is evaluated and will change if the preset you are switching to is using a different routing than the one you are switching from. The "Routing Lock"-function disables this and fixates the Routing, and consequently only effect parameters are now changed by a preset change.



For smooth preset changes and general ease of programming it is advisable to use the same routing as often as possible and only change routing when a special effect or function is needed.

CHANNEL SWITCHING & TAP TEMPO

Channel Switching of External Preamp

Via the Switch Jack connection on the G•Major rear panel it is possible to program e.g. channel switching of a preamp. This channel selection is done via the Relay Jack connection and can then be stored with any preset. Depending on the channel switching connection on your preamp/combo either a “Y-Splitter Cable” splitting a Stereo 1/4” jack to two mono jacks (tip to tip and tip to ring), or a standard “Stereo jack to Stereo jack-cable” must be used.

Cables must be soldered like this.

Y-Splitter Cable

Stereo to Stereo Jack Cable

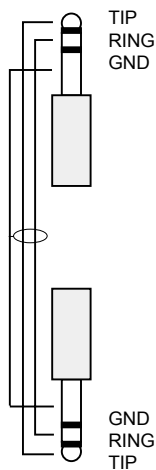
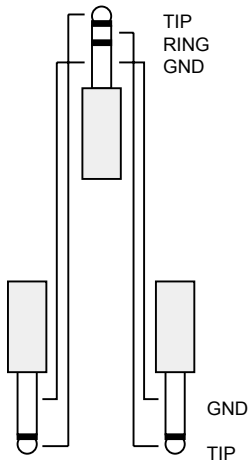

Relay 1

When set to On, Relay 1 shorts the tip of the switching 1/4” jack with the sleeve (GND). Off position means that the relay is open.

This parameter can be remote controlled via MIDI or the Ext. Control jack. This is set up in the "Mod" menu.

Relay 2

When set to On, Relay 2 shorts the ring of the switching 1/4” jack with the sleeve. Off position means that the relay is open.

This parameter can be remote controlled via MIDI or the Ext. Control jack. This is set up in the "Mod" menu.

Example

Let us assume you have hooked the G•Major up with either a three-channel combo or preamp.

- First of all check whether your amp uses 2 mono connectors or one stereo connector for the channel switching and select cable accordingly.
- Connect the Stereo jack to the Switch Out connection on the G•Major rear panel.
- Connect the two mono jacks (or the stereo jack depending on the used cable) to the channel switching connectors on the combo or preamp.
- Recall the preset on the G•Major to which you wish assign a channel switching setting to.
- Hit the RELAY 1+2 key.
- Now select Relay 1 or Relay 2 using the PARAMETER wheel and use the EDIT VALUE wheel to On/Off switch the two Relays.

By doing this you are now switching the channels on your preamp. Exactly which setting that will give you your Clean Crunch and Distorted channels we cannot tell as this varies from amp to amp. Experiment and learn the few basic settings that applies to your amp.

- Store the preset by pressing the STORE key twice. (see the Preset Handling section for more info on storing)

Tap Menu

Tap Tempo

The Tap tempo feature allows you to tap in the tempo of the song you are currently playing. This way a Vibrato, Tremolo or a Delay effect can match and fit the tempo of the song you play.

The tempo you tap on the TAP key is global but you can setup the Tempo parameter in different algorithms to subdivide the tapped Global Tempo as you wish.

CONTROLLING THE G • MAJOR

Introduction

If you have played around and listened to the G•Major and maybe programmed a few presets you are probably anxious to get control of the unit from your MIDI board, Expression pedals or maybe via the optional G•Minor MIDI foot switch.

If you are new to the 19 inch “world of wonders” this section will maybe startle you at first, but once you get a grip of the basics you will see how easy it is to gain full control of the G•Major and appreciate these possibilities. As described below we have even implemented a “Learn” function that makes setting up external control of various parameters very easy.

The Mod Menu

This section describes how the parameters in the MOD menu are assigned to an External Control Device. Modifiers can be perceived as interfaces between external controlling devices (such as e.g. an Expression pedal) and specific algorithm parameters. The section “Modifiers” will describe in detail how to work with these.

- Press MOD and select parameters using the CONTROL PARAMETER wheel.
- For each of the parameters you can now setup how this parameter should be controlled. Use the CONTROL EDIT wheel to select between following options:
 - **Off**
 - **Learn**
 - **Pedal**
 - **CC 1-128**

Off

Off means: No external control of the Modifier.

Learn

The obvious comfortable choice that makes setting up a breeze.

- Press ENTER and the display will blink showing that you are in the Learn mode.
- Now you must show G•Major which of the connected external controllers you will use to control the modifier. Either send a CC (by pressing one of your MIDI pedals CC buttons) or move your Expression pedal or switch.
- “Learning” will now no longer blink and the G•Major has recognized your external controller.

Pedal

When “Pedal” is selected it is only the pedal connected to the “External Control” jack on the rear panel that can control the Modifier.

CC 0-127

This is where you can directly specify exactly which CC number the Modifier should respond to.



Natural choice for switching blocks on/off or Tuner Mute would be using MIDI CCs (Control Change values) sent from your MIDI pedal. Natural choice for controlling any Level, Speed or Pitch parameter would be using an Expression Pedal.

Parameters in the MOD menu:

Mod 1 to 4

Modifiers can be perceived as interfaces between external controlling devices (such as e.g. an Expression pedal) and specific algorithm parameters. The section “Modifiers” will describe in detail how to work with these.

Tap Tempo

Remote control of Tap Tempo. This is the tempo that you can assign tempo parameters to e.g. Delay Time or Tremolo Speed.

Bypass All

Remote control of the Overall Bypass All.

Tuner Mute

Allows you to Mute the Outputs of the G•Major, while tuning your guitar.

Global In Level

Remote control of the Global In level.

Preset Out Level

Remote control of the Preset Out level. With this parameter you can boost a preset to solo level.

PresetBoost

This is an excellent feature allowing you to boost any preset for fills etc. You can boost the preset from its current preset level (setup in the “Levels All” menu) to 0dB by using any MIDI CC value or pedal connected to the Pedal Input. A MIDI CC value above 64 will set the current preset to 0dB. A MIDI CC value below 64 will set the current preset back to the preset level.

CONTROLLING THE G•MAJOR

When a new preset is recalled, the PresetBoost controller is reset (a value below 64 is sent out). This will allow for an update of the LED status on your footcontroller given that the MIDI Out of the G•Major is connected to the MIDI In on your footcontroller.

Please note that if the Preset Level parameter in the Levels All menu is set to 0dB, no boost will be possible.

For further instructions on how to set up the PresetBoost function please read the example on page 24.

Global Out Level

Remote control of the Global Out level.

Relay 1 & Relay 2

Remote control of Relay 1 and 2.

Comp On/Off

On/off toggle of the Compressor via an external controller.

Filter On/Off

On/off toggle of the Filter block via an external controller.

Pitch On/Off

On/off toggle of the Pitch block via an external controller.

Cho/Flg On/Off

On/off toggle of the Chorus/Flanger block via an external controller.

Delay On/Off

On/off toggle of the Delay block via an external controller.

Reverb On/Off

On/off toggle of the Reverb block via an external controller.

Noise Gate On/Off

On/off toggle of the Noise Gate via an external controller.

Modifiers

Modifiers 1-4

The G•Major holds four Modifiers.

A Modifier is a virtual handle, that can be remote controlled via MIDI CCs or any controller connected to the Ext. Control jack such as an Expression Pedal. A Modifier can

be connected, internally in the G•Major, to one or several effect parameters simultaneously.

As an example you can use an Expression pedal connected to a Modifier to control a Delay Output, the Speed of the Tremolo or maybe just the Input Level.

External Control Using Modifiers

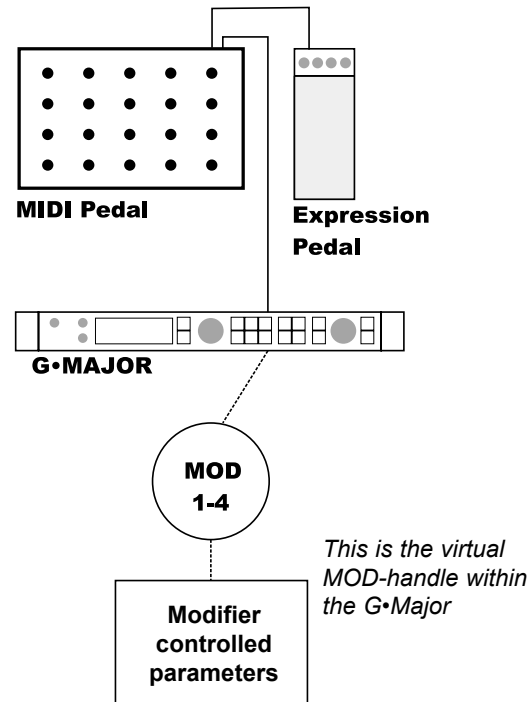

Assigning Modifiers

There are two steps in assigning an external controller to control a specific parameter.

Step 1 - Assigning Modifiers to External Control

- Press MOD to enter the Modify menu and select MOD 1-4 using the CONTROL PARAMETER wheel.
- Turning the EDIT wheel clockwise you can now select between the following options determining how the Modifier should be controlled.

- Off
- Learn
- Pedal
- CC 1-128.

Learn

- Press ENTER and the display will blink showing that you are in the Learn mode for the Modifier.

CONTROLLING THE G•MAJOR

- Now you must show the G•Major which connected external controller you will use to control the modifier. Either send a CC (e.g. by pressing one of your MIDI pedals CC buttons) move your Expression pedal or press your connected switch.
- “Learning” will now no longer blink and the G•Major has recognized which external controller you want to control the Modifier with and which MIDI CC value the device is sending if any.

Off

Off means: No external Control of the Modifier.

Pedal

When “Pedal” is selected it is only the pedal connected to the “External Control” jack on the rear panel that can control the Modifier.

CC 0-127

This is where you can directly specify which CC number the Modifier should respond to.

Step 2 - Assigning a Parameter to a Modifier

- If not already in the MOD menu press MOD so the display shows MOD 1, 2, 3 or 4. Then press ENTER. Note that this is not where you select which Modifier you are assigning, so any of the 4 will do.

You will now have a list of all the parameters that can be controlled via a Modifier. Only parameters in the active effect blocks are listed. You can scroll through the parameters using the PARAMETER wheel. In the left side of the display you will have the parameter name and in the right side the assigned Modifier.

- Use the PARAMETER wheel to select parameter and the VALUE wheel to select which of the 4 Modifiers the parameters must be assigned to. Press ENTER and go to Step 3.

Step 3 - Setting the Modifier Response Curve

The Modifier Response Curve determines how the Modifier responds to e.g. the movement of an Expression pedal. There are three parameters to set.

MinOut

Determines the Modifier Outlevel when the Expression pedal/Modifier Input is at minimum position.

MidOut

Determines the Modifier Outlevel when the Expression pedal/Modifier Input is at medium position.

MaxOut

Determines the Modifier Outlevel when the Expression pedal/Modifier Input is at maximum position.

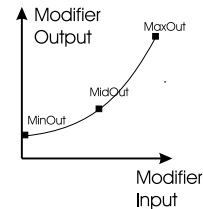

Assigning an Expression Pedal as a Whammy

This example requires that you have assigned an Expression pedal to Modifier 1 using e.g. the Learning function as described in the previous column.

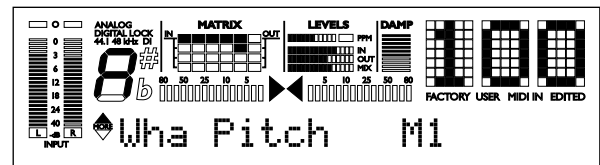

Algorithm Parameter Assigned Modifier

Example

- Connect your Expression pedal to either the External Control jack on the back of the G•Major or to the Expression pedal Input on your MIDI pedal. Use a stereo to stereo jack cable for connection. (Please see the MIDI/UTIL section on how to calibrate your Expression Pedal if you haven't calibrated yet).
- Press MOD key to access the MOD menu.
- Press ENTER.
- Select the Whammy parameter using the PARAMETER wheel and select the MOD 1 using the EDIT wheel.



The G•Major must be calibrated to the Expression Pedal type you connect. This is done in the Utility menu. Please read the description of how to operate the Utility menu in this manual.

Which Parameters Can Be Assigned?

The parameters you can assign to Modifiers are located in the bottom of the Mod menu. The parameter list will vary depending on which algorithms are active from the various effect blocks.

HOW TO

How to get started

- Connect the G Major according to your setup as described on pages 10/11 and power on.
- Find the “loudest” sound from your preamp or effect pedals with the most dynamics and set the Input level so peaks are at approx. -3dB. The sound with the most dynamics is most likely to be a clean sound as the over driven sounds per nature are more compressed.
- Set the Output level to match the equipment you feed the G•Major Output to. As this could be close to anything you will have to experiment.

How to bypass an effect block from a preset

Simply press the block you wish to remove. The Effect block will then be bypassed but not deleted.

The preset can now be stored by pressing STORE followed by ENTER for confirmation.

You can at any time activate the block with the exact same settings you had earlier by pressing the block key again.

Remember that a bypassed block does NOT interfere with the sound.

How to setup a Boost function for a preset

All factory presets in the G•Major are saved at -6dB leaving headroom for boosting any preset to a “solo-level”.

We advise that you keep a minimum of 6dB headroom in all User presets as well via the Preset Level parameter in the Levels All menu.

You will appreciate this PresetBoost function as it allows you to easily boost your current preset for fills, themes etc. that otherwise would not be heard sufficiently.

- Select the preset you wish to add the Boost function to.
- Set the presets level via the Levels All menu to -6dB.
- Press the MOD key and select the PresetBoost parameter using the PARAMETER wheel.
- Select Learn using the VALUE wheel, press ENTER and press the switch on your MIDI board sending a CC value or press the pedal connected to External Control.
- The display now shows either Pedal, if that was the used controller device, or it shows the CC value received from your MIDI board.
- Store the preset.

Now every time you call up that specific preset it will start out at the -6dB specified in the Levels all menu, but you can boost the preset 6dB to 0dBFS by hitting the control you have setup for this function.

How to let the G•Major mute the Outputs when you tune up your Guitar

Muting the G•Major Outputs via the G•Major Front Panel

Press and hold the BYPASS key for approx. 1 second. To un-mute press BYPASS again.

Muting the G•Major Outputs using Control Changes from e.g. a MIDI pedal

- Press MOD and use the PARAMETER wheel to select “Tuner Mute”
- Press ENTER to activate the Learn function. The display will start to blink.
- Now press the button on your MIDI board sending out the MIDI CC value you would like to use for muting control or press the momentary or alternating pedal connected to the External Control jack on the G•Major. The G•Major has now “learned” what action you are using to mute the Outputs when tuning.

How to let a Delay “spill over” at preset change

This is a global parameter located in the Utility menu.

Matching the speed of a Rhythmic Tremolo or Vibrato to a MIDI sequence

- Connect the MIDI Output of your sequencer or other device sending out the MIDI Clock you wish the G•Major to sync up to, to the MIDI Input of the G•Major.
- Press TAP once to enter the Tap menu and use the PARAMETER wheel to select the MIDI Sync parameter.
- Set MIDI sync to “On”.
The G•Major will now use the incoming MIDI clock tempo as its Global Tempo. Subdivisions can be set via the Tempo parameter in the algorithm.

Switching preamp channels using the G•Major Switch Out connection and a MIDI board sending MIDI CCs

Connect the Switch Out connection on the G•Major to your preamps/combos channel switching connectors.

- Press MOD and select Relay 1 or 2 using the CONTROL PARAMETER wheel.
- Press ENTER to activate the Learn function.
- Press a MIDI CC switch on your MIDI board.

This MIDI CC switch will now switch channels on your amp. Repeat the steps above for Relay 2 if you have more than two channels to switch between.

EFFECT BLOCKS

Basic Operation of the Effect Menus

The six (or seven including Noise gate) effect keys on the front panel, all work as follows:

- Single click: Toggles the current effect on/off.
- Double click: Accesses the edit page of the current effect.

The navigation in the effect edit pages is done with the dedicated EFFECT EDIT and PARAMETER wheel. Some of the effect blocks contain several effect algorithms. As an example the Filter block contains Phaser, Tremolo, Panner, Resonance Filter etc. The Algorithm choice is located as the first parameter in the effects edit page.

As all the effect blocks are always present, they can be activated or accessed at any time by simply using the single or double click functions. Bypassing an effect block equal removing it from the effects setup, meaning that though the block is still in the routing it does not affect the signal in any way.

The settings of a bypassed block are always kept in the preset and it is therefore easy to reactivate a bypassed block in the preset again keeping the previous settings in that block. Consider it as turning a stomp-box on and off.

NOISE GATE

Introduction

A Noise Gate is generally used to attenuate the signal when you don't play the guitar. This way you can avoid hearing the entire hiss, hum and other noise you might have on your system. Of course a Noise Gate is not the solution to any noise problem. You should try to avoid the noise in the first place. Problems with noise can be introduced by a number of different things. Poor cables, poorly shielded single coil pickups and power supplies placed close to signal cables are common problems that you can work your way out of by experimenting. There will, however, always be a certain amount of noise in any guitar setup. The Noise Gate can help you attenuate the noise when you are not playing. Be careful when setting Threshold and Release Rate. A too high Threshold setting will result in e.g. not "opening" the Gate when you play the guitar softly. A too slow Release time will result in cutting your attack. Setting will vary depending on the signal present on the Input of the G•Major, so will most likely need different settings for Clean and Overdrive sounds.

Mode

Range: Off - Hard - Soft

General overall mode that determines how fast the Noise Gate should attenuate/dampen the signal when below Threshold.

Threshold

Range: -60dB to 0dB

The Threshold point determines at what point the Noise Gate should start to dampen the signal.

To set this parameter you should turn up the volume on your guitar's volume potentiometer but not play. Then start turning up the Threshold value from -60dB to the point where desired dampening is actually achieved.

This little experiment will of course require that the Max Damping parameter is set different from 0dB - as 0dB means: no damping.

NOISE GATE

Max. Damping

Range: 0dB to 90dB

This parameter determines how hard the signal should be attenuated when below the set Threshold. You could argue that a max dampening would be appropriate always, but you would also like to have a smooth transience between the “gated/attenuated” stage and the “open” stage. The more dBs that must be released the more obvious the Noise Gate might seem. Experiment with each of the sounds you use as no general settings can be applied always.

Release

Range: 0dB/sec to 200dB/sec

The Release Rate determines how fast the signal is released when the Input signal rises above the Threshold point. As a rule of thumb this setting should be set fairly high.

Illustration

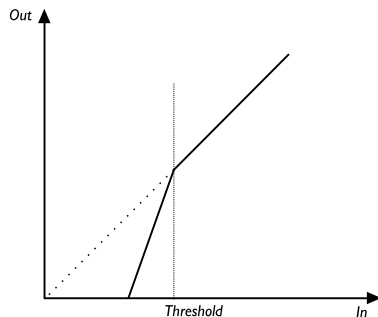

COMPRESSOR

Introduction

A Compressor is used to reduce the dynamic content of a signal. How can this improve your guitar's appearance in the overall sound? There are situations where a compressor should not be applied on the guitar and there are definitely situations where it is the key to letting the guitar stand out and appear rock solid. Here are a few examples.

Let's say your aim is playing a steady clean rhythm guitar figure at the same level all the time. This is to some extent virtually impossible. You cannot avoid playing a few strokes too hard once in while. This will most likely result in the sound engineer backing off a bit on the guitar channels in live situations to avoid harsh sounding peaks. At this “lower” overall level (that neither you or the sound engineer intended in the first place), your weakest strokes in the guitar rhythm figure will now disappear completely. - The answer to this situation is using a Compressor. Correctly set, the highest peaks will be reduced, giving you and the sound engineer a much more homogeneous guitar level to work with.

You can also apply compression to a lead sound to even out variations in level. Combining a low set Threshold, that lets the Compressor operate constantly with a high Ratio, a very audible compression effect is achieved. As an example try listening to the famous solo played by David Gilmour on the record “The Wall” in the song “Another Brick In the Wall.”

However, if your style of playing utilizes having great dynamics to work with - as e.g. Robben Fords excellent comping style or similar - you might not want to apply any compression at all.

As with many effects, but particularly the Compressor it goes that when applied correctly you will clearly benefit from using it, but it is just as easy to find settings that work against your goals.

- Try out our presets containing the Compressor block in the G•Major with both lead and rhythm sounds, and get an idea of where you will get the most of using it.

COMPRESSOR

Illustration

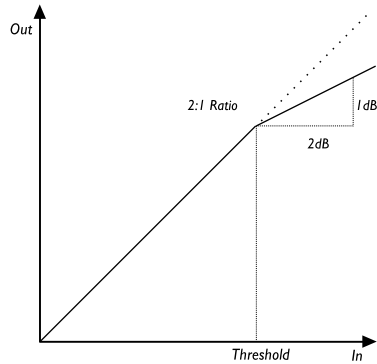

Threshold

Range: -30dB to 0dB

When the signal is above the set Threshold point the Compressor is activated and the gain of any signal above the Threshold point is processed according to the Ratio, Attack and Release settings.

Ratio

Range: Off to Infinite: 1

The Ratio setting determines how hard the signal is compressed. (see illustration above).

Example: With a Ratio setting of 2:1 an Input signal at 4dB above Threshold is reduced to only 2dB on the Output side. Infinite setting gives you a Limiter function.

Attack

Range: 0 to 200ms

The Attack time is the response time of the Compressor. The shorter the Attack time the sooner the Compressor will reach the specified Ratio after the signal rises above the Threshold point.

Release

Range: 0 to 200ms

The Release time is the time it takes for the Compressor to release the gain reduction of the signal after the signal drops below the Threshold point again.

CHORUS

Introduction

A Chorus/Flanger is basically a short Delay that is modulated by an LFO (Low Frequency Oscillator). The difference between Chorus and Flanging is the applied Delay time and the Feedback parameter in the Flanger. The modulation of the short Delay gives very small variations in pitch. These pitch changes blended with the direct sound gives you the Chorus sound, while the modulated signal alone will give you a Pitch modulator also known as Vibrato.

Illustration

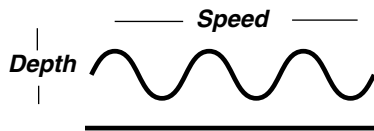

The basic illustration shows that the Chorus effect consists of both the original and the pitch modulated signal.

Classic Chorus - CHO/FLA Block

The Classic Chorus uses as default a relationship between Speed and Depth called the Golden Ratio. The G•Major inherited this feature from the TC 2290 and ensures a smooth even-sounding Chorus at any setting.

Speed

Range: 0.050Hz to 19.95Hz

The Speed of the Chorus, also known as Rate.



The speed of this effect block is either defined by this parameter or by the Tempo parameter which sets the speed according to the globally tapped tempo. This Speed parameter is only active/valid if the Tempo parameter is set to "Ignored".

Depth

Range: 0 to 100%

The Depth parameter specifies the intensity of the Chorus effect - the value represents the amount of modulation. (see Illustration)

Tempo

Range: 1/32T to 1 Bar or Ignored

The Tempo parameter sets the relationship to the global Tempo.



When set to anything else than Ignored the tempo defined by the Speed parameter is ignored.

Hi Cut

Range: 19.95Hz to 20kHz

Reduces the high-end frequencies in the Chorus effect.

Try using the Hi Cut parameter as an option if you feel the Chorus effect is too dominant in your sound and turning down the Mix or Out level doesn't give you the dampening of the Chorus effect you are looking for.

Mix

Range: 0 to 100%

Sets the relationship between the dry signal and the applied effect in this block.

Out level

Range: -100 to 0dB

Sets the overall Output level of this block.

CHORUS

Advanced Chorus - CHO/FLA Block

The Advanced Chorus algorithm holds a few extra parameters compared to the Classic Chorus. You have the option of turning the Golden Ratio on/off, controlling the Chorus Delay and also applying a Phase Reverse function for extra widening of the Chorus effect.

Speed

Range: 0.050Hz to 19.95Hz

The Speed of the Chorus, also known as Rate.



The speed of this effect block is either defined by this parameter or by the Tempo parameter which sets the speed according to the globally tapped tempo. This Speed parameter is only active/valid if the Tempo parameter is set to "Ignored".

Depth

Range: 0 to 100%

The Depth parameter specifies the intensity of the Chorus effect - the value represents the span of the Curve. (see Illustration)

Tempo

Range: 1/32T to 1 Bar or Ignored

The Tempo parameter sets the relationship to the global Tempo.



When set to anything else than Ignored the tempo defined by the Speed parameter is ignored.

Hi Cut

Range: 19.95Hz to 20kHz

Reduces the high-end frequencies in the Chorus effect. Try using the Hi Cut parameter as an option if you feel the Chorus effect is too dominant in your sound and turning down the Mix or Out level doesn't give you the dampening of the Chorus effect you are looking for.

Phase Reverse

Range: Off / On

Reverses the processed Chorus signal in the right channel. This gives a very wide Chorus effects and a less defined sound.

Chorus Delay

Range: 0 to 50ms

As described earlier, a Chorus/Flanger is basically a Delay being modulated by an LFO. This parameter makes it possible to change the length of that Delay. A typical Chorus uses Delays at approximately 10 ms, while a Flanger uses Delays at around 5 ms.

Gold Ratio

Range: Off to On

TC Engineers found years ago that when Speed is increased the Depth must be decreased to achieve the same amount of perceived Chorus effect. When Golden Ratio is "ON" this value is automatically calculated. Golden Ratio is a feature inherited from the classic TC 2290 processor.

Mix

Range: 0 to 100%

Sets the relationship between the dry signal and the applied effect in this block.

Out level

Range: -100 to 0dB

Sets the overall Output level of this block.

FLANGER

Classic Flanger - CHO/FLA Block

Speed

Range: 0.050Hz to 19.95Hz

The speed of the Flanger, also known as Rate.



The speed of this effect block is either defined by this parameter or by the Tempo parameter which sets the speed according to the globally tapped tempo. This Speed parameter is only active/valid if the Tempo parameter is set to "Ignored".

Depth

Range: 0 to 100%

Adjusts the Depth of the Flanger, also known as Intensity. The value represents the amount of modulation applied.

Tempo

Range: 1/32T to 1 Bar or Ignored

The Tempo parameter sets the relationship to the global Tempo.



When set to anything else than Ignored the tempo defined by the Speed parameter is ignored.

Hi Cut

Range: 19.95Hz to 20kHz

Reduces the high-end frequencies in the Flange effect. Try using the Hi Cut parameter as an option if you feel the Flange effect is too dominant in your sound and turning down the Mix or Out level doesn't give you the dampening of the Flange effect you are looking for.

Feedback

Range: -100 to 100

Controls the amount of Feedback/Resonance of the short modulated Delay that causes the Flange effect. A too high Feedback setting (above approx. 90-95%) might introduce an actual internal Feedback resulting in a squealing noise that in most cases is unwanted in flanging effects. Be aware of this when experimenting at high volumes. Setting this parameter to "-100" reverses the phase of the signal that is fed back to the algorithm Input.

FB Hi Cut

Range: 19.95Hz to 20kHz

A parameter that can attenuate the high-end frequencies of the resonance created via the Feedback parameter.

Mix

Range: 0 to 100%

Sets the relationship between the dry signal and the applied effect in this block.

Out level

Range: -100 to 0dB

Sets the overall Output level of this block.

Advanced Flanger - CHO/FLA Block

Speed

Range: 0.050Hz to 19.95Hz

The speed of the Flanger, also known as Rate.



The speed of this effect block is either defined by this parameter or by the Tempo parameter which sets the speed according to the globally tapped tempo. This Speed parameter is only active/valid if the Tempo parameter is set to "Ignored".

Depth

Range: 0 to 100%

Adjusts the Depth of the Flanger, also known as Intensity.

Tempo

Range: 1/32T to 1 Bar or Ignored

The Tempo parameter sets the relationship to the global Tempo.



When set to anything else than Ignored the tempo defined by the Speed parameter is ignored.

Hi Cut

Range: 19.95Hz to 20kHz

Will reduce high-end frequencies in the Flange effect. Try using the Hi Cut parameter as an option if you feel the Flange effect is too dominant in your sound and turning down the Mix or Out level doesn't give you the dampening of the Flange effect you are looking for.

FLANGER

Feedback

Range: -100 to 100

Controls the amount of Feedback/Resonance of the short modulated Delay that causes the Flange effect.

A too high Feedback setting (above approx. 90-95%) might introduce an actual internal Feedback resulting in a squealing noise that in most cases is unwanted in flanging effects. Be aware of this when experimenting at high volumes. Setting the parameter to “-100” reverses the phase of the signal that is fed back to the algorithm Input.

FB Hi Cut

Range: 19.95Hz to 20kHz

A parameter that can attenuate the high-end frequencies of the resonance created via the Feedback parameter.

Phase Rev

Range: Off to On

Reverses the processed Flange signal in the right channel. This gives a very wide Flange effects and a less defined sound.

Fla Dly - Flanger Delay

Range: 0 to 50ms

A typical Delay time to achieve the Flanging effect is around 5ms whereas Chorus effects occur with Delay times around 10ms. You can however choose Delay times from 0 to 50ms.

Gold Ratio

Range: Off to On

TC Engineers found years ago that when Speed is increased the Depth must be decreased to achieve the same amount of perceived Flanging effect. When Golden Ratio is set to on this value is automatically calculated. Golden Ratio is a feature inherited from the classic TC 2290 processor.

Mix

Range: 0 to 100%

Sets the relationship between the dry signal and the applied effect in this block.

Out level

Range: -100 to 0dB

Sets the overall Output level of this block.

VIBRATO

Vibrato - CHO/FLA Block

A Vibrato effect modulates the incoming pitch.

The result is similar to the vibrato technique used by vocalists. As opposed to a Chorus effect no direct signal is combined with this pitch modulation.

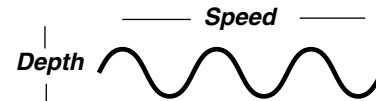

Speed

Range: 0.050Hz to 19.95Hz

The speed of the Vibrato, also known as Rate.



The speed of this effect block is either defined by this parameter or by the Tempo parameter which sets the speed according to the globally tapped tempo. This Speed parameter is only active/valid if the Tempo parameter is set to “Ignored”.

Depth

Range: 0 to 100%

The amount of Pitch modulation applied.

Tempo

Range: 1/32T to 1 Bar or Ignored

The Tempo parameter sets the relationship to the global Tempo.



When set to anything else than Ignored the tempo defined by the Speed parameter is ignored.

Hi Cut

Range: 19.95Hz to 20kHz

Determines the frequency above which the Hi Cut filter will attenuate the high-end frequencies of the generated effect. Hi Cut filters can be used to give a less dominant effect even at high mix levels.

Out level

Range: -100 to 0dB

Sets the overall Output level of this block.

RESONANCE FILTER

Resonance Filter - FILTER/MOD BLOCK

The Resonance filters are basically a Hi and Lo Cut filter that can be swept up and down the frequency range. When the Resonance (Q-factor) parameter is increased, the filter peak at the cutoff frequency gets very narrow and very steep. That is at the very core of the characteristic sound of Resonance filters.

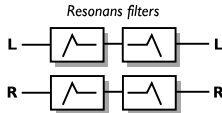

Order

Range: 2nd to 4th

The Order parameter of the resonance filters changes the steepness of the filters. 2nd order filters are 12dB/Octave while 4th order filters are 24dB/Octave. 4th order filters will "ring" or resonate more than 2nd order filters.

Hi Cut

Range: 19.95Hz to 20kHz

Determines the frequency above which the Hi Cut filter will attenuate the high-end frequencies of the generated effect.

Hi Resonance

Range: 0 to 100%

Sets the amount of resonance on the Hi Cut filter.

Mix

Range: 0 to 100%

Sets the relationship between the dry signal and the applied effect in this block.

Out level

Range: -100 to 0dB

Sets the overall Output level of this block.

Auto Resonance Filter

- FILTER/MOD BLOCK

The Auto Resonance filter will create an effect similar to a Touch Wah. The sweep through a frequency range is controlled via the dynamics on the Input.

Sensitivity

Range: 0 to 10

Sets the sensitivity according to the Input you are feeding the unit.

Response

Range: Fast or Slow

Determines whether the sweep through a frequency range will be performed fast or slow.

Frequency Max

Range: 1kHz to 10kHz

Limits the frequency range in which the sweep will be performed.

Mix

Range: 0 to 100%

Sets the relationship between the dry signal and the applied effect in this block.

PHASER

Vintage Phaser/Smooth Phaser

- FILTER (MOD Block)

Two effective good phaser types. The Vintage Phaser will give you the phasing effect similar to the one found in old stomp boxes. The Smooth Phaser is a more subtle type. Excellent for a less dominant effect.

The Vintage Phaser utilizes four All-pass filters. These filters create a comb-looking characteristic. When the filtered sound is mixed with the direct sound the “phasing sound” occurs.

The Smooth Phaser utilizes twelve All-pass filters. Due to the higher number of filters in the Smooth Phaser, compared to the Vintage Phaser, the Smooth Phaser simply sounds smoother than the Vintage type.

Speed

Range: 0.050 Hz to 19.95Hz

Controls the Speed of the Phaser.

Depth

Range: 0 to 100%

Controls the Depth of the Phaser.

Tempo

Range: 1/32T to 1 Bar or Ignored

The Tempo parameter sets the relationship to the global Tempo.



When set to anything else than Ignored the tempo defined by the Speed parameter is ignored.

Feedback

Range: -100 to 100

Controls the amount of feedback in the Phaser. Setting this parameter to “-100” reverses the phase of the signal that is fed back to the algorithm Input.

Range

Range: Low to High

Determines whether the phasing effect should be mainly on the high- or low-end frequencies.

Phase Reverse

Range: On/Off

An LFO phase change that causes a small Delay in one of the waveform starting points. When applied the left and right Outputs will start the current waveform at two different points giving you a more extreme wide spread phasing effect. Try this!

Mix

Range: 0 to 100%

Sets the relationship between the dry signal and the applied effect in this block.

Out level

Range: -100 to 0dB

Sets the overall Output level of this block.

TREMOLO

Tremolo - FILTER/MOD Block

A Tremolo is basically a change of level controlled by an LFO. The G•Major holds variations from soft and smooth to hard and aggressive Tremolo.

Speed

Range: 0.050Hz to 19.95Hz
Sets the Speed of the Tremolo.

Depth

Range: 0 to 100%
A 100% setting means complete mute of the signal between the peaks.

Tempo

Range: 1/32T to 1 Bar or Ignored
The Tempo parameter sets the relationship to the global Tempo.



When set to anything else than Ignored the tempo defined by the Speed parameter is ignored.

LFO Pulsewidth

Range: 0-100%
Controls the division of the upper and lower part of the current waveform, e.g. if Pulsewidth is set to 75%, the upper half of the waveform will be on for 75% of the time.



Hi Cut

Range: 19.95 to 20kHz
Attenuates the High frequencies of the Tremolo effect. Use the Hi Cut filter to create a less dominant Tremolo effect while keeping the Depth.

Type

Range: Soft or Hard (Sinus or Square)
Two variations of the steepness of the Tremolo Curve are available. Listen and select.

Out level

Range: -100 to 0dB
Sets the overall Output level of this block.

PANNER

Panner - FILTER/MOD Block

The panner simply pans the signal from Left channel to the Right.

Speed

Range: 0.050Hz to 19.95Hz
Sets the speed of the Panning.

Width

Range: 0 to 100%
A 100% setting will sweep the signal completely from the Left to Right. Very often a more subtle setting will be more applicable and blend better with the overall sound. But you'll be the judge of that!

Tempo

Range: 1/32T to 1 Bar or Ignored
The Tempo parameter sets the relationship to the global Tempo.



When set to anything else than Ignored the tempo defined by the Speed parameter is ignored.

Out level

Range: -100 to 0dB
Sets the overall Output level of this block.

DELAY

Introduction

The G•Major holds 3 different Delay modes that cover not only your basic needs, but also Delay effects you until now maybe thought of as unachievable unless hooked up with expensive studio equipment.

Once you get the grasp of what the three modes are used for, setting up a Delay for your application is very easy.

Hi Cut & Lo Cut

Hi Cut and Lo Cut Feedback parameters appear several times over the next few pages that describes the different Delay algorithms and to avoid having the same “long” explanation more times than necessary consider the following general explanations if you need them:

Feedback Hi Cut - General Explanation

Using the latest digital technology an extremely precise reproduction of the Input signal for e.g. the repeats in a Delay effect is possible. However, for long Delay repeats on a guitar signal this is not always desirable, as such precise repeats can seam disturbing and result in a less homogeneous sound.

To compensate for this try using the Hi Cut filter thereby emulating analog or tape style delay units.

Feedback Lo Cut - General Explanation

Using a Delay on a signal containing low frequencies will at times add too much rumble. If you feel this is happening you should try dampening the low-end frequencies using the Feedback Lo Cut parameter as an alternative to lowering the entire Delay Mix level.

Ping Pong

With the PingPong Delay line you are able to pan the repeats from left to right if you are using a stereo setup. We hope you will find new unique ways of utilizing this effect but just to mention a few that are already popular: Try using a PingPong Delay when smoothly fading in chords. This will give you a true width in the sound. Also try using the PingPong Delay type for repeating rhythmic tricks - or for a lead tone that you want to give a really wide sound.

Delay time

Range: 0 to 1800ms

The time between the repetitions.

Feedback

Range: 0 to 100%

Determines how many repetitions there will be.

Width

Range: 0 to 10

The Width parameter determines whether the Left or Right repetitions is panned 100% or not. 10 is the most extreme setting but also the most disturbing in the overall sound. Experiment with this.

FB Hi Cut - Feedback Hi Cut

Range: 2.00kHz to 20kHz

Attenuates the frequencies over the set frequency thereby giving you a more analog Delay sound that in many cases will blend better in the overall sound.

FB Lo Cut

Range: 19.95Hz to 2.00kHz

Attenuates the frequencies below the set frequency.

Mix

Range: 0 to 100%

Sets the relationship between the dry signal and the applied effect in this block.

Out level

Range: -100 to 0dB

Sets the overall Output level of this block.

DELAY

Dynamic Delay

The Dynamic Delay initially introduced in the well-recognized TC 2290, is a function that allows the Delay Output level to be actively altered by the dynamics of the Input level.

A function that can be used to leave the source material clear and undisturbed while played and delicately accompanied by the Delay between phrases.

Dly time

Range: 0 to 1800ms

The time between the repetitions.

Offset R

Range: -200 to 200ms

Offsets the Delay repeats in the Right channel only.

For a true wide stereo Delay the Delay in the two channels should not appear at exactly the same time. For the “wide” effects a few milliseconds should do the trick. Using more than that will give you anything from a wide slap-back effect on the repeats to more extreme effects.

Feedback

Range: 0 to 100%

Determines the number of repetitions of the Delay.

Sensitivity

Range: -50 to 0dB

With this parameter you control how sensitive the “ducking” or dampening function of the Delay Repeats should be according to the signal present on the Input.

Damping

Range: 0 to 100dB

This parameter controls the actual attenuation of the Delay while Input is present.

Release

Range: 20ms, 30ms, 50ms, 70ms, 100ms, 140ms, 200ms, 300ms, 500ms, 700ms or 1 sec.

A parameter relative to a Compressor Release.

As explained in the Dynamic Delay Introduction the Delay repetitions are dampened while you play and released when you stop.

The Release parameter determines how fast the Output of the Delay repetitions returns to “normal” after attenuation of these repeats have ceased.

FB Hi Cut

Range: 2.00kHz to 20kHz

Attenuates the frequencies over the set frequency thereby giving you a more analog Delay sound that in many cases will blend better in the overall sound.

FB Lo Cut

Range: 19.95Hz to 2.00kHz

Attenuates the frequencies below the set Threshold frequency.

Tempo

Range: 1/32T to 1 Bar or Ignored

The Tempo parameter sets the relationship to the global Tempo.



When set to anything else than Ignored the tempo defined by the Speed parameter is ignored.

Mix

Range: 0 to 100%

Sets the relationship between the dry signal and the applied effect in this block.

Out level

Range: -100 to 0dB

Sets the overall Output level of this block.

DELAY

Dual Delay

The Dual Delay algorithm allows you to have two Delay lines running at the same time. In other terms you have two separate Delay “units” in parallel, each with its own set of parameters.



If using only e.g. Delay Line 1 you simply have a regular mono Delay.

DlyTime 1

Range: 0 to 1800ms

Sets the Delay time of the first Delay Line.

DlyTime 2

Range: 0 to 1800ms

Sets the Delay time of the second Delay Line.

Tempo

Range: 1/32T to 1 Bar or Ignored

The Tempo parameter sets the relationship to the global Tempo.



When set to anything else than Ignored the tempo defined by the Speed parameter is ignored.

Offset R

Range: -200 to 200ms

Offsets the delay repeats in the right channel.

For a true wide stereo Delay the Delay in the two channels should not appear at exactly the same time. For the “wide” effects a few milliseconds should do the trick. Using more than that will give you anything from a wide slap-back effect to more extreme effects.

FB 1

Range: 0 to 100%

Determines the number of repetitions of the Delay of the first Delay Line.

FB 2

Range: 0 to 100%

Determines the number of repetitions of the Delay of the second Delay Line.

Hi Cut

Range: 2.00kHz to 20kHz

Attenuates the frequencies over the set frequency thereby giving you a more analog Delay sound that in many cases will blend better in the overall sound.

Lo Cut

Range: 19.95Hz to 2.00kHz

Attenuates the frequencies below the set frequency.

Pan 1

Range: 50L to 50R

Pans the Delay repetitions of the first Delay Line.

Pan 2

Range: 50L to 50R

Pans the Delay repetitions of the second Delay Line.

Mix

Range: 0 to 100%

Sets the relationship between the dry signal and the applied effect in this block.

Out level

Range: -100 to 0dB

Sets the overall Output level of this block.

PITCH

Detune

A Detune effect has a sound that to some extent can be associated with a Chorus effect. The source signal is split and a specified amount of the signal is detuned by an amount of cents specified by you. (100 cents is 1 semitone). The main difference between the Detune effect and the Chorus effect is that the Detune amount does not change. It is a split signal where you simply offset the pitch. The Detune algorithm in the Pitch block holds two voices. If you think your sound is simply too direct and clean try out a setting with only a few cents off detune on both voices. - E.g. +2 cents on Voice 1 and -3 on Voice 2. A Delay for each voice can be applied as e.g. a Slapback effect.

Voice 1

Range: -100 to 100 cent

Offsets the first Voice in the Detune block.

Voice 2

Range: -100 to 100 cent

Offsets the second Voice in the Detune block

Delay 1

Range: 0 to 50ms

Specifies the Delay on the first Voice.

Delay 2

Range: 0 to 50ms

Specifies the Delay on the second Voice.

Mix

Range: 0 to 100%

Sets the relationship between the dry signal and the applied effect in this block.

Out Level

Range: -100dB to 0dB

Sets the overall Output level of this block.

Whammy

The Whammy effect gives you the opportunity to control the pitch of an added voice with an external MIDI Expression pedal.

Whammy

Range: 0 to 100%

This parameter sets the mix between the dry and processed signal. If e.g. set to 100%, no direct guitar tone will be heard - only the processed "pitched" tone. (This applies only for the Serial and the Semi parallel mode).

Direction

Range: Up - Down

This parameter determines whether the attached Expression pedal should increase or decrease Pitch when moved either direction.

Range

Range: 1-Oct/2-Oct

Selects how far the Whammy block will pitch your tone.

Select 2 octaves for the extreme and 1 octave for the more commonly used whammy effects.

Out level

Range: -100 to 0dB

Sets the Output level of this effect block.

PITCH

Pitch Shifter

With the G•Major Pitch Shifter you are able to add 2 voices, each with a fixed pitch within +/- one octave from the Input note. The processing of the G•Major is at a speed where you will never notice any “searching” for the notes as with many older octaver units or octaver stomp boxes. Try lowering the single Voice to -1200 cents (100 is one semitone). With a Mix level of 100 you will be able to get at pretty good bass-simulation.

Voice 1

Range: -1200 to 1200

Specifies the Pitch of the first Voice. As 100 cent equals 1 semitone you can select a pitch freely between one octave below the Input Pitch to one octave above.

Voice 2

Range: -1200 to 1200

Specifies the Pitch of the second Voice. As 100 cent equals 1 semitone you can select a pitch freely between one octave below the Input Pitch to one octave above.

Pan 1

Range: 50L to 50R

Pan parameter for the first voice.

Pan 2

Range: 50L to 50R

Pan parameter for the second voice.

Dly 1

Range: 0 to 700ms

Sets the Delay time for the first voice.

Dly 2

Range: 0 to 700ms

Sets the Delay time for the second voice.

FB 1

Range: 0 to 100%

Determines how many repetitions there will be on the Delay of the first voice.

FB 2

Range: 0 to 100%

Determines how many repetitions there will be on the Delay of the second voice.

Mix

Range: 0 to 100%

Sets the relationship between the dry signal and the applied effect in this block.

Out level

Range: -100 to 0dB

Sets the overall Output level of this block.

REVERB

Spring

The Spring algorithm is designed to reproduce the sound of the old spring reverbs, such as the ones used in vintage guitar amps.

Decay

Range: 0.1 to 20s

The Decay parameter determines the length of the Reverb Tail. The length is defined as the time it takes for the Reverb Tail to decay approximately 60dB.

Pre Delay

Range: 0 to 100ms

A short Delay placed between the direct signal and the Reverb Tail. By using Pre Delay the source material is kept clear and undisturbed by the more diffuse Reverb Tail arriving shortly after.

Size

Range: Small, Med, Large

The “Size” parameter defines the size of the Early Reflection pattern used. A Reverb consists of both Early Reflections and a Diffuse Field. In reverb simulation the Early Reflections or “Initial Reflections” defines the shape and size of the room, whereas the Diffuse Field is what you generally refer to as “Reverb” or the “Reverb Tail”. Compared to the Early Reflections the duration of the Diffused field is considerably longer.

Hi Color

Range: 0 to 6

6 different Hi Colors can be selected. Try setting the Hi Factor parameter at +20 and listen to the 6 different Colors.

Hi Factor

Range: -25 to 25

Adds or subtracts the selected Hi Color type.

Lo Color

Range: 0 to 6

6 different Lo Colors can be selected. Try setting the Lo Factor parameter at +20 and listen to the 6 different Colors.

Lo Factor

Range: -25 to 25

Add or subtract the selected Lo Color.

Room Level

Range: -100 to 0

This parameter adjusts the Reverb Tail level. Lowering the Room Level will give you a more ambient sound, since the Early Reflection patterns will become more obvious.

Reverb Lev

Range: -100 to 0

The level of the Early Reflections.

Diffuse

Range: -25 to 25

Allows fine-tuning of the density of the Reverb Tail.

This parameter is set automatically when selecting a desired Decay time and makes it possible to reduce flutter in the Decay to an absolute minimum.

Mix

Range: 0 to 100%

Sets the relationship between the dry signal and the applied effect in this block.

Out level

Range: -100 to 0dB

Sets the overall Output level of this block.

REVERB

Hall

Decay

Range: 0.1 to 20s

The Decay parameter determines the length of the Reverb Tail. The length is defined as the time it takes for the Reverb Tail to decay approximately 60dB.

Pre Delay

Range: 0 to 100ms

A short Delay placed between the direct signal and the Reverb Tail. By using Pre Delay the source material is kept clear and undisturbed by the more diffuse Reverb Tail arriving shortly after.

Size

Range: Small, Med, Large

The "Size" parameter defines the size of the Early Reflection pattern used. A Reverb consists of both Early Reflections and a Diffuse Field. In reverb simulation the Early Reflections or "Initial Reflections" defines the shape and size of the room, whereas the Diffuse Field is what you generally refer to as "Reverb" or the "Reverb Tail". Compared to the Early Reflections the duration of the Diffused field is considerably longer.

Hi Color

Range: 0 to 6

6 different Hi Colors can be selected. Try setting the Hi Factor parameter at +20 and listen to the 6 different Colors.

Hi Factor

Range: -25 to 25

Adds or subtracts the selected Hi Color type.

Lo Color

Range: 0 to 6

6 different Lo Colors can be selected. Try setting the Lo factor parameter at +20 and listen to the 6 different Colors.

Low Factor

Range: -25 to 25

Adds or subtracts the selected Lo Color.

Room Level

Range: -100 to 0

This parameter adjusts the Reverb Tail level. Lowering the Reverb Level will give you a more ambient sound, since the Early Reflection patterns will become more obvious.

Reverb Lev

Range: -100 to 0

The level of the Early Reflections.

Diffuse

Range: -25 to 25

Allows fine-tuning of the density of the Reverb Tail. This parameter is set automatically when selecting a desired Decay time and makes it possible to reduce flutter in the Decay to an absolute minimum.

Mix

Range: 0 to 100%

Sets the relationship between the dry signal and the applied effect in this block.

Out level

Range: -100 to 0dB

Sets the overall Output level of this block.

REVERB

Room

Decay

Range: 0.1 to 20s

The Decay parameter determines the length of the Reverb Tail. The length is defined as the time it takes for the Reverb Tail to decay approximately 60dB.

Pre Delay

Range: 0 to 100ms

A short Delay placed between the direct signal and the Reverb Tail. By using Pre Delay the source material is kept clear and undisturbed by the more diffuse Reverb Tail arriving shortly after.

Size

Range: Small, Med, Large

The "Size" parameter defines the size of the Early Reflection pattern used. A Reverb consists of both Early Reflections and a Diffuse Field. In reverb simulation the Early Reflections or "Initial Reflections" defines the shape and size of the room, whereas the Diffuse Field is what you generally refer to as "Reverb" or the "Reverb Tail". Compared to the Early Reflections the duration of the Diffused field is considerably longer.

Hi Color

Range: 0 to 6

6 different Hi Colors can be selected. Try setting the Hi Factor parameter at +20 and listen to the 6 different Colors.

Hi Factor

Range: -25 to 25

Adds or subtracts the selected Hi Color type.

Lo Color

Range: 0 to 6

6 different Lo Colors can be selected. Try setting the Lo Factor parameter at +20 and listen to the 6 different Colors.

Lo Factor

Range: -25 to 25

Adds or subtracts the selected Lo Color.

Room Level

Range: -100 to 0

This parameter adjusts the Reverb Tail level. Lowering the Reverb Level will give you a more ambient sound, since the Early Reflection patterns will become more obvious.

Reverb Lev

Range: -100 to 0

The level of the Early Reflections.

Diffuse

Range: -25 to 25

Allows fine-tuning of the density of the Reverb Tail.

This parameter is set automatically when selecting a desired Decay time and makes it possible to reduce flutter in the Decay to an absolute minimum.

Mix

Range: 0 to 100%

Sets the relationship between the dry signal and the applied effect in this block.

Out level

Range: -100 to 0dB

Sets the overall Output level of this block.

REVERB

Plate

Decay

Range: 0.1 to 20s

The Decay parameter determines the length of the Reverb Tail. The length is defined as the time it takes for the Reverb Tail to decay approximately 60dB.

Pre Delay

Range: 0 to 100ms

A short Delay placed between the direct signal and the Reverb Tail. By using Pre Delay the source material is kept clear and undisturbed by the more diffuse Reverb Tail arriving shortly after.

Size

Range: Small, Med, Large

The "Size" parameter defines the size of the Early Reflection pattern used. A Reverb consists of both Early Reflections and a Diffuse Field. In reverb simulation the Early Reflections or "Initial Reflections" defines the shape and size of the room, whereas the Diffuse Field is what you generally refer to as "Reverb" or the "Reverb Tail". Compared to the Early Reflections the duration of the Diffused field is considerably longer.

Hi Color

Range: 0 to 6

6 different Hi Colors can be selected. Try setting the Hi Factor parameter at +20 and listen to the 6 different Colors.

Hi Factor

Range: -25 to 25

Adds or subtracts the selected Hi Color type.

Lo Color

Range: 0 to 6

6 different Lo Colors can be selected. Try setting the Lo Factor parameter at +20 and listen to the 6 different Colors.

Lo Factor

Range: -25 to 25

Add or subtract the selected Lo Color.

Room Level

Range: -100 to 0

This parameter adjusts the Reverb Tail level. Lowering the Reverb Level will give you a more ambient sound, since the Early Reflection patterns will become more obvious.

Reverb Lev

Range: -100 to 0

The level of the Early Reflections.

Diffuse

Range: -25 to 25

Allows fine-tuning of the density of the Reverb Tail. This parameter is set automatically when selecting a desired Decay time and makes it possible to reduce flutter in the Decay to an absolute minimum.

Mix

Range: 0 to 100%

Sets the relationship between the dry signal and the applied effect in this block.

Out level

Range: -100 to 0dB

Sets the overall Output level of this block.

IMPORTANT SAFETY INSTRUCTIONS

Please read, keep, and follow these instructions before connecting this unit. Heed all warnings and instructions. Retain this notice and the owner's manual for future reference.



The lightning flash with an arrowhead symbol within an equilateral triangle, is intended to alert the user to the presence of uninsulated "dangerous voltage" within the product's enclosure that may be of sufficient magnitude to constitute a risk of electric shock to persons.



The exclamation point within an equilateral triangle is intended to alert the user to the presence of important operating and maintenance (servicing) instructions in the literature accompanying the product.

Warning!

- To reduce the risk of fire or electric shock, do not expose this unit to rain or moisture.
- Do not open the unit - risk of electric shock inside.
- This apparatus must be earthed.
- Use a three wire grounding type line chord like the one supplied with the product.
- Be advised that different operating voltages require the use of different types of line cord and attachment plugs. If in doubt please contact your TC distributor.
- Check the voltage in your area and use the correct type. See table below:

Voltage	Line plug according to standard.
110-125V	UL817 and CSA C22.2 no 42.
220-230V	CEE 7 page VII, SR section 107-2-D1/IEC 83 page C4.
240V	BS 1363 of 1984. Specification for 13A fused plugs and switched and un-switched socket outlets.

- Mount in a well ventilated rack with a little space above and below.
- This equipment should be installed near the socket outlet and disconnection of the device should be easily accessible.
- Do not install near heat source, such as radiators, heat registers, stoves or other apparatus. (including amplifiers) that produce heat.
- Do not rely solely on the front screws when mounted in touring rack. Support the back as well.
- Clean only with a damp cloth.
- Do not defeat the safety purpose of a polarized or grounding type plug. A polarized plug has two blades with one wider than the other. A grounding type plug has two blades/prongs and a third grounding prong. The wide blade or the third prong are provided for your safety. When the provided plug does not fit into your outlet, consult an electrician for replacement of the obsolete outlet.
- Protect the power cord from being walked on or pinched particularly at plugs convenience receptacles, and the point where they exit from the apparatus.
- Only use attachments/accessories specified by the manufacturer.
- Unplug this apparatus during lightning storms or when unused for long periods of time.

IMPORTANT SAFETY INSTRUCTIONS

Service

There are no user-serviceable parts inside. All service must be performed by qualified personnel. Servicing is required when:

- the unit has been damaged in any way, such as when the power-supply cord or plug is damaged.
- the unit has been exposed to rain or moisture, or liquid has been spilled into the unit.
- objects have fallen into the unit.
- the unit does not work properly.
- the unit has been dropped.

This equipment has been tested and found to comply with the limits for a Class B Digital device, pursuant to part 15 of the FCC rules.

These limits are designed to provide reasonable protection against harmful interference in a residential installations. This equipment generates, uses and can radiate radio frequency energy and, if not installed and used in accordance with the instructions, may cause harmful interference to radio communications. However, there is no guarantee that interference will not occur in a particular installation.

If this equipment does cause harmful interference to radio or television reception, which can be determined by turning the equipment off and on, the user is encouraged to try to correct the interference by one or more of the following measures:

- Reorient or relocate the receiving antenna.
- Increase the separation between the equipment and receiver.
- Connect the equipment into an outlet on a circuit different from that to which the receiver is connected.
- Consult the dealer or an experienced radio/TV technician for help.

The user may find the following booklet, prepared by the Federal Communications Commission, helpful:

"How to identify and Resolve Radio/TV interference Problems."

This booklet is available from the US. Government Printing Office, Washington, DC 20402, Stock No. 004-000-0034-4.

Caution:

You are cautioned that any change or modifications not expressly approved in this manual could void your authority to operate this equipment.

For the customers in Canada:

This Class B Digital apparatus meets all requirements of the Canadian Interference-Causing Equipment Regulations (ICES-003). Cet appareil numérique de la classe B respecte toutes les exigences du Règlement sur le matériel brouilleur du Canada.

Certificate Of Conformity

TC Electronic A/S, Sindalsvej 34, 8240 Risskov, Denmark, hereby declares on own responsibility that following product:

G•Major - Guitar Processor

- that is covered by this certificate and marked with CE-label conforms with following standards:

EN 60065 (IEC 60065)	Safety requirements for mains operated electronic and related apparatus for household and similar general use
EN 55103-1	Product family standard for audio, video, audio-visual and entertainment lighting control apparatus for professional use. Part 1: Emission.
EN 55103-2	Product family standard for audio, video, audio-visual and entertainment lighting control apparatus for professional use. Part 2: Immunity.

With reference to regulations in following directives:
73/23/EEC, 89/336/EEC

Issued in Risskov, January 2001

Anders Fauerskov
Chief Executive Officer

APPENDIX - MIDI IMPLEMENTATION CHART

G•MAJOR - GUITAR EFFECTS PROCESSOR

Function		Transmitted	Recognized	Remarks
Basic Channel	Default	1	1	
	Changed	1-16	1-16	
Mode	Default			
	Messages	X	X	
	Altered			
Note Number		X	X	
	True Voice	X	X	
Velocity	Note ON	X	X	
	Note OFF	X	X	
After Touch	Key's	X	X	
	Ch's	X	X	
Pitch Bend		X	X	
Control Change	System Parameters	from 1-128	from 1-128	
	Bank Select:			
	Ctrl 32	1= User Bank	0= Factory Bank	
Prog Change		O	O	
System Excl. Common		O	O	
	Song Pos	X	X	
	Song Sel	X	X	
	Tune	X	X	
System real time	Clock	X	O	
	Commands	X	X	
Aux Messages	Local ON/OFF	X	X	
	All Notes OFF	X	X	
	Active Sense	X	X	
	Reset	X	X	
Clock		X	O	
O: YES	Mode 1: OMNI ON, POLY		Mode 2: OMNI ON, MONO	
X: NO	Mode 3: OMNI OFF, POLY		Mode 4: OMNI OFF, MONO	

APPENDIX - TECHNICAL SPECIFICATIONS

Digital Inputs and Outputs

Connectors: RCA Phono (S/PDIF)
Formats: S/PDIF (24 bit), EIAJ CP-340, IEC 958
Output Dither: HPF/TPDF dither 24/20/16/8 bit
Sample Rates: 44.1 kHz, 48 kHz
Processing Delay: 0.1 ms @ 48 kHz
Frequency Response DIO: DC to 23.9 kHz \pm 0.01 dB @ 48 kHz

Analog Inputs

Connectors: 1/4" phone jack, balanced
Impedance, Bal / Unbal: 21 kOhm / 13 kOhm
Max. Input Level: +24 dBu
Min. Input Level for 0 dBFS: 0 dBu
Sensitivity: @ 12 dB headroom: -12 dBu to +12 dBu
A to D Conversion: 24 bit, 128 x oversampling bitstream
A to D Delay: 0.65 ms / 0.70 ms @ 48 kHz / 44.1 kHz
Dynamic Range: 100 dB typ, 20 Hz - 20 kHz
THD: typ < 92 dB (0.0025 %) @ 1 kHz
Frequency Response: +0/-0.1 dB @ 48 kHz, 20 Hz to 20 kHz
Crosstalk: <-95 dB, 20 Hz to 20 kHz

Analog Outputs

Connectors: 1/4" phone jack, balanced
Impedance Balanced / Unbalanced: 40 Ohm
Max. Output Level: +20 dBu (balanced)
Output Ranges: Balanced: 20/14/8/2 dBu
Unbalanced: 14/8/2 dBu
D to A Conversion: 24 bit, 128 x oversampling bitstream
D to A Delay: 0.63 ms / 0.68 ms @ 48 kHz / 44.1 kHz
Dynamic Range: 104 dB typ, 20 Hz to 20 kHz
THD: typ <-94 dB (0.002 %) @ 1 kHz, +20 dBu Output
Frequency Response: +0/-0.5 dB @ 48 kHz, 20 Hz to 20 kHz
Crosstalk: <-100 dB, 20 Hz to 20 kHz

EMC

Complies with: EN 55103-1 and EN 55103-2
FCC part 15, Class B, CISPR 22, Class B

Safety

Certified to: IEC 65, EN 60065, UL6500 and CSA E65

Environment

Operating Temperature: 32° F to 122° F (0° C to 50° C)
Storage Temperature: -22° F to 167° F (-30° C to 70° C)
Humidity: Max. 90 % non-condensing

Control Interface

MIDI: In/Out/Thru: 5 Pin DIN
Pedal: 1/4" phone jack
Relay closure (separate tip and ring connection to sleeve): 1/4" phone jack

General

Finish: Anodized aluminum front
Plated and painted steel chassis
Display: 23 character / 280 icon STN-LCD display
Dimensions: 19" x 1.75" x 8.2" (483 x 44 x 195 mm)
Weight: 4.1 lb. (1.85 kg)
Mains Voltage: 100 to 240 VAC, 50 to 60 Hz (auto-select)
Power Consumption: <15 W
Warranty Parts and labor: 1 year

Due continuous development these specifications are subject to change without notice.

PRESET LIST

- 1 G-Major Verb & Slap
- 2 Clean Reverb
- 3 Sheryls Sound
- 4 Tremolo Pedal Speed
- 5 So Scho
- 6 Scotty's Blues
- 7 Straight Lead
- 8 Funky Thang
- 9 Right On The Edge
- 10 Bluebox Echo's
- 11 Sparkle
- 12 Pan Chorus
- 13 Clean Cowboy
- 14 Cowboy Slap
- 15 The Good, Bad & Ugly
- 16 Rockabilly Slap
- 17 All That Lee
- 18 A Bit Of Chet A
- 19 Shadows Of H. Marvin
- 20 Filtered Slap Delay
- 21 Straight Slap Dly
- 22 Subtle Lead Fx's
- 23 Chorused Lead
- 24 Chorus & Dyn Dly
- 25 T Petty Chorus
- 26 Jazz Ballad
- 27 Wide Chorus
- 28 Wes M Jazz Lead
- 29 Funky Music Verb
- 30 Rock'n Roll Spring
- 31 Rev Amb
- 32 TightVerb
- 33 SpreadVerb
- 34 Small Room
- 35 Dly Doubler
- 36 Clean,Comp,Chorus'd
- 37 Comp'n Detune
- 38 Blues Lead
- 39 Blues Room
- 40 Blues Rhythm
- 41 Subtle Acoustic
- 42 For Acoustic Guitar
- 43 Finger Picking
- 44 Crunch My Phaser
- 45 Jimmy H
- 46 Phaser Pedal
- 47 Pedal Vibe
- 48 Pedal Leslie
- 49 Vibra Room
- 50 Phat Phaser
- 51 Lush Chorus
- 52 Formerly Known As?
- 53 Swell Delays
- 54 Wet Delays
- 55 Clean Verb & Dly
- 56 Tape Flange & Delay
- 57 Lone Flanger
- 58 Phasing Repeats
- 59 Funky Chicken
- 60 Funky Octaver
- 61 Filter Fun
- 62 Lazy Filter
- 63 Auto Filter
- 64 Far Away Vibrato
- 65 What a Bright Kid
- 66 Octave Dubber
- 67 2 Oct Whammy up
- 68 1 Oct Whammy up
- 69 Oct Up
- 70 Whammy 2 Semi Down
- 71 Octave
- 72 OctaWah
- 73 Synth Guitar
- 74 Deep Bass
- 75 Bend Up Slaps
- 76 Rich Dual Delay
- 77 Phaser Room
- 78 Hard Tremolo
- 79 Detune
- 80 Ping Pong
- 81 Slapback Delay
- 82 Straight Tremolo
- 83 Flanged Tremolo
- 84 Big Chicken
- 85 Pedal Filter
- 86 Chopped Steppers
- 87 Locked In Vibrato
- 88 Chopper
- 89 UnconciuousPedal
- 90 Synthesized
- 91 Machine
- 92 Skysaw Guitar
- 93 Synthesized Leads
- 94 Sus4 Dreamscape
- 95 Arpeggiator
- 96 Infinity & Beyond
- 97 Bass Comp
- 98 Bass Chorus
- 99 Bass Autofilter
- 100 To Be Continued...