

ULTRA-G[®] G1100

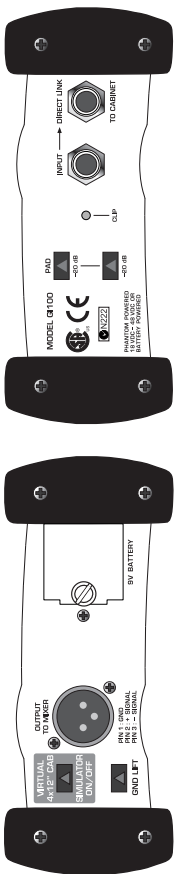

User's Manual

Version 1.0 September 2001

ENGLISH

BEHRINGER
INSTRUMENT AMPLIFICATION

Welcome to BEHRINGER!

Thank you for showing your confidence in us by purchasing the ULTRA-GI100.

In addition to the numerous advantages of an excellent DI box, the GI100 features an extremely authentic, pure analog simulation of a 4x12" guitar speaker cabinet.

On stage and in the studio, it is often desirable to directly connect sound sources with the console. Although this method has many advantages, it also has its technical hurdles. Keyboards rarely offer balanced outputs, and it's simply not possible to connect electric guitars or basses directly to a console. Although common practice, placing a microphone in front of the speaker cabinet is not really an ideal solution, since the mic tends to pick up signals from other instruments and creates another potential source of feedback.

A DI (Direct Injection) box allows you to pick up a signal **directly** from an unbalanced, high impedance output, like that of an electric guitar, and **inject** it into the console, without using a microphone. There are of course several situations that call for feeding an unbalanced sound source directly into a console—preferably in a balanced form. That's exactly what a DI box is for.

Basically, there are two types of DI boxes: passive and active. A passive DI box contains much simpler circuitry and requires no batteries, making it is less expensive. On the other hand, its performance is dependent on the impedance of the connected gear. A change in impedance on the output side will cause the input impedance to change. Among other things, the impedance ratings greatly effect the frequency response. A passive DI box only works correctly when impedance specifications are adhered to (in short: high-Z input, low-Z output).

Active DI boxes, which use an amplifier to buffer the input signal, are not subject to these limitations. The ULTRA-G's input impedance is extremely high, so it lets the input signal pass through with virtually no coloring. At the other end, its balanced output has a particularly low impedance, making the signal much less susceptible to hum and noise. The GI100 is an active DI box and performs optimally regardless of the impedance ratings of the connected gear.

The ULTRA-G is based on the proven BEHRINGER OT-1 transformer, which ensures crystal-clear, distortion-free sound and a wide, linear frequency response. In addition, it can be powered by the console's phantom power or by an internal battery. The battery is automatically "disconnected" when phantom power is present to preserve battery life.

 **In order to avoid damage to your loudspeakers, always mute the corresponding channel on the consoles before connecting the GI100. The same applies when switching between phantom and battery power.**

Designed by J. Rath

The GI100 features a switchable speaker simulation, developed in collaboration with renowned amp designer Jürgen Rath, which adds the sound of a 4x12" cabinet to your direct guitar signal at the touch of a button. Analog speaker simulations, offering the possibility to get a typical guitar cabinet sound to tape or to a PA without the necessity of cabinets or microphones, have been available since the mid-80's. Since then, the appeal of "instant sound" via simulation as a means of reducing equipment and hassle has continuously grown. Having developed a great deal of convincing guitar gear with various manufacturers, Jürgen Rath was an obvious choice for us in developing our VIRTUAL 4x12" CABINET speaker simulation. In the words of Germany's top specialty publication GITARRE & BASS, "The Virtual Cabinet delivers an authentic 4x12" simulation with impressive sound, cutting power and clear reproduction." (Michael Dommers, 8/97)

1. CONTROLS

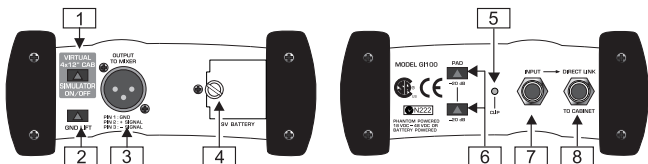





Fig. 1.1: The GI100's front and back panels

- 1 The VIRTUAL 4x12" CAB speaker simulation can be switched on and off with the SIMULATOR ON/OFF switch.
 - 2 When activated, the GND LIFT breaks the ground connection between input and output. Depending on the grounding of the connected equipment, this can eliminate hum or ground loops.
 - 3 OUTPUT TO MIXER is the GI100's balanced, mic level output. Use a high-quality, balanced XLR (microphone) cable to connect the ULTRA-G to a console.
- ⚠️ You should never connect pins 2 or 3 with pin 1 or remove the shield from pin 1. Otherwise, it will not be possible to operate the unit with phantom power.**
- 4 BATTERY COMPARTMENT. To install or replace the 9V battery, remove the screw and lift the lid.
 - 5 The CLIP LED lights up when the input signal level is too high.
 - 6 The two -20 dB PAD switches noticeably increase the operating range of the ULTRA-G, allowing it to accept anything from the low-level signal of a high-impedance microphone or guitar to the loudspeaker output of a guitar amp. These switches have repeatedly proven themselves in the BEHRINGER ULTRA-DI DI100. Pressing both switches results in a gain reduction of 40 dB.

-  Before using the PAD switches, be sure that the ULTRA-G is clipping, and not the mic preamp on the console. You should only attenuate the input signal via the GI100's PAD switches if its CLIP LED lights up frequently or remains lit. If this is not the case and distortion occurs, check the console settings. It is always best to avoid attenuation of the DI input to ensure an optimal signal-to-noise ratio.
- 7** *INPUT*. Use this 1/4" mono jack to connect the signal source, e.g. your guitar, with a high-quality standard instrument cable.
-  The GI100 is switched on as soon as you insert a plug into the INPUT. The battery is “disconnected” when the plug is removed. For this reason, the GI100 has no on/off switch. To preserve battery life, always disconnect the input when the ULTRA-G is not in use.
- 8** The *DIRECT LINK TO CABINET* is a direct output of the input signal, allowing you for example to simultaneously run your instrument through the GI100 and complete your normal signal path by connecting the DIRECT LINK to an amp or speaker cabinet.
-  The INPUT and DIRECT LINK sockets are directly connected. When connecting the speaker output of a tube amp to the input of the GI100, please be sure to connect a guitar speaker or other appropriate impedance load to the DIRECT LINK socket in order to avoid possible damage to your amplifier.

2. CONNECTION EXAMPLES

The following section illustrates various applications of the ULTRA-G GI100.

2.1 Conversion of guitar signals

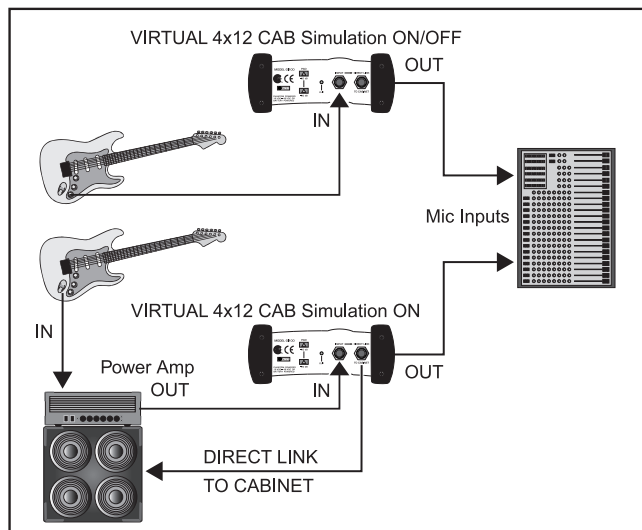

Fig. 2.1: 1. Guitar \Rightarrow GI100 \Rightarrow Console
 2. Guitar \Rightarrow Tube amplifier \Rightarrow GI100 \Rightarrow Loudspeaker/Console

This diagram illustrates two common applications in which unbalanced guitar signals are converted into balanced signals. In the first example the guitar is connected directly to the GI100, which in turn feeds the console. No guitar amp is used. In this case, the PAD switches should be deactivated with the VIRTUAL CAB switched on or off depending on the sound desired.

The second example shows the GI100 being driven by the loudspeaker output of a guitar amp. If you're using a tube amp, it's very important to connect an impedance load—preferably a speaker—to the DIRECT LINK TO CABINET output in order to prevent damage to your amp. For this application, start with one PAD switch depressed and the GND LIFT switch activated. We also recommend using the VIRTUAL CAB speaker simulation for an authentic guitar sound.

2.2 Picking up a bass guitar or keyboard signal

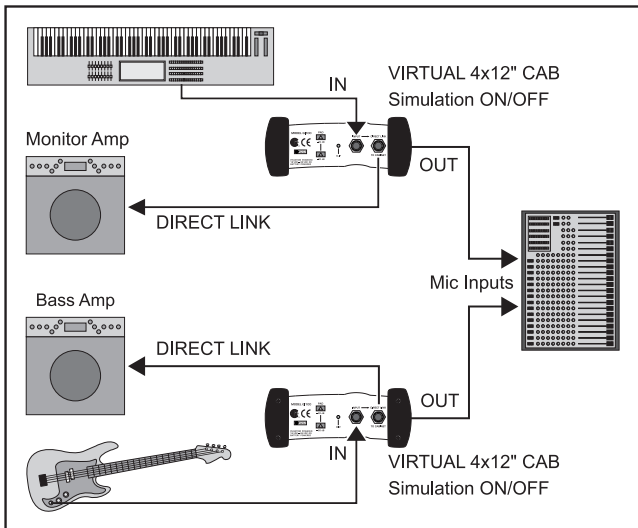

Fig. 2.2: 1. Bass guitar \Rightarrow GI100 \Rightarrow Amplifier/Console
2. Keyboard \Rightarrow GI100 \Rightarrow Amplifier/Console

This diagram illustrates two standard DI applications. The signal going to the amp via the DIRECT LINK is unaffected; it is simply picked up and additionally fed, as a balanced, low-impedance signal, to the mic inputs of the mixing console. This is particularly advantageous with bass guitars, since microphones that reproduce high-energy bass frequencies in a halfway linear manner are rare—and expensive. When using effects or other outboard processors, these should be connected in front of the ULTRA-G in the signal path, so that its output includes these signals.

Few keyboards have balanced outputs. Here, a quality DI box such as the GI100 is indispensable to ensure clean signals, especially when using long cables.

2.3 Converting a microphone signal from high-impedance unbalanced to low-impedance balanced

Many inexpensive microphones have unbalanced high-impedance outputs. With the ULTRA-G, these microphones can be used in spite of long cable runs without the danger of hum or other interference. Simply insert the GI100 between the microphone and the console. For this application, you will most likely want to switch the VIRTUAL CAB speaker simulation off.

2.4 Picking up a signal from a loudspeaker output

There are times when picking up a signal after amplifier processing is desirable to achieve a certain sound, but no direct out is available. Thanks to the GI100's two -20 dB PAD switches, you can feed a console from the loudspeaker output of an amplifier with a power rating of up to 3,000 Watts (4 Ohm) without overloading the ULTRA-G. When using a tube amp, be sure to connect a speaker or other impedance load to the DIRECT LINK output. We recommend using the VIRTUAL CAB speaker simulation in these applications, when signals from electric guitars are transmitted.



Fig. 2.3: Connection to an amplifier's output



Before connection to a loudspeaker output, always make sure that the GND LIFT switch is activated (depressed) to prevent accidental short-circuiting of the amplifier output. The metal casing of the GI100 should not have direct contact with other equipment. The tip of the output socket should be connected to the positive (red) loudspeaker pole.

3. SPECIFICATIONS

Frequency response	10 Hz to 160 kHz
Noise	-99.2 dBu
Distortion	< 0.014% (1 kHz, 0 dBu in)
Input resistance	> 250 kOhm
Connection impedance	> 600 Ohm
Input	1/4" mono jack
Output	XLR balanced
Max. input level	+8/+28/+48 dBu (Simulation OFF) -2/+18/+38 dBu (Simulation ON)
Supply:	
Phantom supply	18 V DC to 48 V DC
Battery	9 V 6LR91
Dimensions	6" (150 mm) x 5" (130 mm) x 2.4" (60 mm)
Weight	approx. 650 g

BEHRINGER is constantly striving to maintain the highest professional standards. As a result of these efforts, modifications may be made from time to time to existing products without prior notice. Specifications and appearance may therefore differ from those listed or shown.

4. WARRANTY

§ 1 WARRANTY CARD/ONLINE REGISTRATION

To be protected by the extended warranty, the buyer must complete and return the enclosed warranty card within 14 days of the date of purchase to BEHRINGER Spezielle Studioteknik GmbH, in accordance with the conditions stipulated in § 3. Failure to return the card in due time (date as per postmark) will void any extended warranty claims.

Based on the conditions herein, the buyer may also choose to use the online registration option via the Internet (www.behringer.com or www.behringer.de).

§ 2 WARRANTY

1. BEHRINGER (BEHRINGER Spezielle Studioteknik GmbH including all BEHRINGER subsidiaries listed on the enclosed page, except BEHRINGER Japan) guarantees the mechanical and electronic components of this product for a period of one (1) year from the original date of purchase, in accordance with the warranty conditions described below. If the product shows any defects within the specified warranty period that are not due to normal wear and tear and/or improper handling by the user, BEHRINGER shall, at its sole discretion, either repair or replace the product.

2. If the warranty claim proves to be justified, the product will be returned to the user freight prepaid.

3. Warranty claims other than those indicated above are expressly excluded.

§ 3 RETURN AUTHORIZATION NUMBER

1. To obtain warranty service, the buyer (or his authorized dealer) must call BEHRINGER (see enclosed list) during normal business hours **BEFORE** returning the product. All inquiries must be accompanied by a description of the problem. BEHRINGER will then issue a return authorization number.

2. Subsequently, the product must be returned in its original shipping carton, together with the return authorization number to the address indicated by BEHRINGER.

3. Shipments without freight prepaid will not be accepted.

§ 4 WARRANTY REGULATIONS

1. Warranty services will be furnished only if the product is accompanied by a copy of the original retail dealer's invoice. Any product deemed eligible for repair or replacement by BEHRINGER under the terms of this warranty will be repaired or replaced within 30 days of receipt of the product at BEHRINGER.

2. If the product needs to be modified or adapted in order to comply with applicable technical or safety standards on a national or local level, in any country which is not the country for which the product was originally developed and manufactured, this modification/adaptation shall not be considered a defect in materials or workmanship. The warranty does not cover any such modification/adaptation, irrespective of whether it was carried out properly or not. Under the terms of this warranty, BEHRINGER shall not be held responsible for any cost resulting from such a modification/adaptation.

ULTRA-G GI100

3. Free inspections and maintenance/repair work are expressly excluded from this warranty, in particular, if caused by improper handling of the product by the user.

This also applies to defects caused by normal wear and tear, in particular, of faders, potentiometers, keys/buttons and similar parts.

4. Damages/defects caused by the following conditions are not covered by this warranty:

- ▲ misuse, neglect or failure to operate the unit in compliance with the instructions given in BEHRINGER user or service manuals.
- ▲ connection or operation of the unit in any way that does not comply with the technical or safety regulations applicable in the country where the product is used.
- ▲ damages/defects caused by force majeure or any other condition that is beyond the control of BEHRINGER.

5. Any repair or opening of the unit carried out by unauthorized personnel (user included) will void the warranty.

6. If an inspection of the product by BEHRINGER shows that the defect in question is not covered by the warranty, the inspection costs are payable by the customer.

7. Products which do not meet the terms of this warranty will be repaired exclusively at the buyer's expense. BEHRINGER will inform the buyer of any such circumstance. If the buyer fails to submit a written repair order within 6 weeks after notification, BEHRINGER will return the unit C.O.D. with a separate invoice for freight and packing. Such costs will also be invoiced separately when the buyer has sent in a written repair order.

§ 5 WARRANTY TRANSFERABILITY

This warranty is extended exclusively to the original buyer (customer of retail dealer) and is not transferable to anyone who may subsequently purchase this product. No other person (retail dealer, etc.) shall be entitled to give any warranty promise on behalf of BEHRINGER.

§ 6 CLAIMS FOR DAMAGES

Failure by BEHRINGER to provide proper warranty service shall not entitle the buyer to claim (consequential) damages. In no event shall the liability of BEHRINGER exceed the invoiced value of the product.

§ 7 OTHER WARRANTY RIGHTS AND NATIONAL LAW

1. This warranty does not exclude or limit the buyer's statutory rights provided by national law, in particular, any such rights against the seller that arise from a legally effective purchase contract.

2. The warranty terms mentioned herein are applicable unless they constitute an infringement of national warranty law.

The information contained in this manual is copyright protected. No part of this manual may be reproduced or transmitted in any form or by any means, electronic or mechanical, including photocopying and recording of any kind, for any purpose, without the express written permission of BEHRINGER Spezielle Studiotechnik GmbH.

BEHRINGER, ULTRA-G and ULTRA-DI are registered trademarks. BEHRINGER Instrument Amplification is a Division of BEHRINGER. ALL RIGHTS RESERVED.

© 2001 BEHRINGER Spezielle Studiotechnik GmbH.

BEHRINGER Spezielle Studiotechnik GmbH, Hanns-Martin-Schleyer-Str. 36-38, 47877 Willich-Münchheide II, Germany

Tel. +49 (0) 21 54 / 92 06-0, Fax +49 (0) 21 54 / 92 06-30
