

Eris™ Series E44 / E66

High-Definition MTM Studio Monitors

Owner's Manual

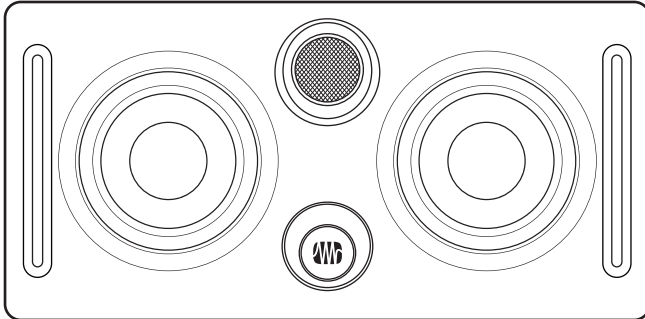
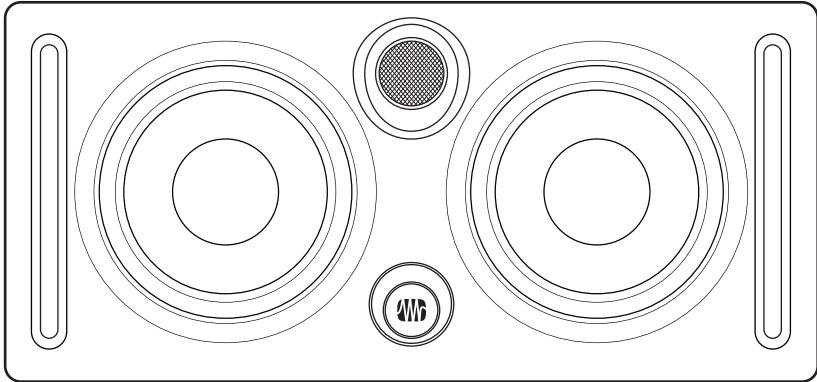

Table of Contents

1 Overview — 1

- 1.1 Introduction — 1
- 1.2 Summary of Eris E44/E66 Features — 2
- 1.3 What is in the box — 3

2 Hookup — 4

- 2.1 Rear Panel Connections and Controls — 4
 - 2.1.1 Inputs — 4
 - 2.1.2 Power — 4
 - 2.1.3 Acoustic Tuning Controls — 5
- 2.2 Hookup Diagrams — 6
 - 2.2.1 Basic Setup — 6
 - 2.2.2 Advanced Setup with Speaker Switching — 7

3 Tutorials — 8

- 3.1 Monitor Placement — 8
 - 3.1.1 Badge Rotation — 9
- 3.2 Input Gain Setting — 10
- 3.3 Equalizer Setting Suggestions — 10
- 3.4 Acoustic Space Setting Suggestions — 11

4 Resources — 12

- 4.1 Technical Specifications — 12
- 4.2 Troubleshooting — 14
- 4.3 Warranty — 15

1 Overview

1.1 Introduction

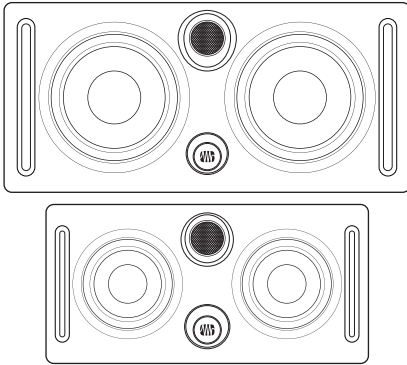

Thank you for purchasing the PreSonus Eris E44/E66 studio monitors. The E44 and E66 active monitors feature a nested MTM (midwoofer-tweeter-midwoofer) design that delivers accurate response, expanded frequency range, and the widest stereo field available in their class.

We encourage you to contact us at 225-216-7887 (9 a.m. to 5 p.m. Central Time) with questions or comments regarding your PreSonus Eris E44/E66. PreSonus Audio Electronics is committed to constant product

improvement, and we value your suggestions highly. We believe the best way to achieve our goal of constant product improvement is by listening to the real experts: our valued customers. We appreciate the support you have shown us through the purchase of this product and are confident that you will enjoy your Eris E44/E66!

ABOUT THIS MANUAL: *We suggest that you use this manual to familiarize yourself with the features, applications, and correct connection procedures for your Eris E44/E66 before connecting it to the rest of your studio gear. This will help you avoid problems during installation and setup.*

*Throughout this manual you will find **Power User Tips** that can quickly make you an Eris expert. In addition to the Power User Tips, you will find several tutorials that cover monitor placement as well as setting the Input Level, EQ, and Acoustic Space controls.*

1.2 Summary of Eris E44/E66 Features

- Nested MTM design provides smooth on- and off-axis response
- Dual 4.5/6.5" Kevlar LF Drivers produce a more dynamic output than conventional designs
- 1.25" silk dome HF Driver
- Supports Horizontal and Vertical speaker placement
- LF Amplifier Power: 50W / 80W
- HF Amplifier Power: 40W / 60W
- Balanced XLR and ¼" TRS, and Unbalanced RCA inputs
- Continuously Variable HF and MF Controls (-6 to +6dB)
- Low Cut Filter (Flat, 80Hz, 100Hz)
- Acoustic Space settings (Flat, -2 dB, -4 dB) compensates for room placement
- RF interference, Output-current Limiting, Over-temperature, and Subsonic filter protection
- External mains fuse
- Power: 110-120V ~50/60 Hz or 220-240V ~50/60 Hz

1.3 What is in the box

In addition to this manual, your Eris E44/
E66 package contains the following:

- (1) PreSonus Eris E44 **or** E66 powered studio monitor

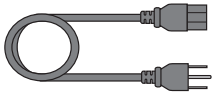
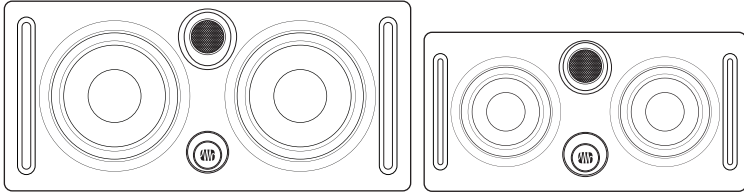

- (1) IEC power cable



- (6) Foam feet to be placed on the bottom of the speaker to improve isolation

2 Hookup

2.1 Rear Panel Connections and Controls

2.1.1 Inputs

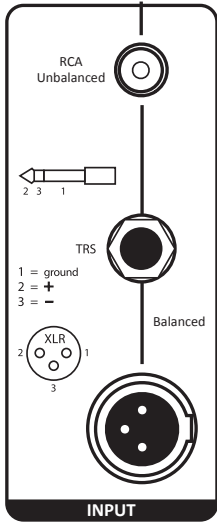

Line-level Inputs. The Eris E44/E66 provides a choice of three inputs: two balanced (XLR and ¼" TRS) and one unbalanced (RCA). These inputs accept a line-level signal from your audio source and feed that signal to the monitor's built-in power amplifiers. These inputs are provided to allow for flexible connectivity and not for connecting multiple sources to your speakers simultaneously. **Please connect only one source to your Eris E44/E66.**

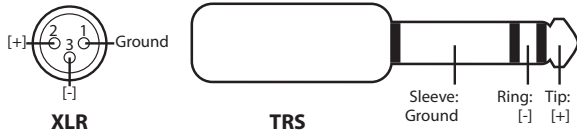

Power User Tip: If your audio source provides balanced XLR or ¼" TRS (tip-ring-sleeve) outputs, use one of the corresponding balanced Eris inputs, since balanced cables are resistant to induced noise from radio-frequency or electromagnetic interference (RFI or EMI). If the audio source has unbalanced ¼" TS (tip-sleeve) outputs, use a ¼"-to-RCA adapter or adapter cable. Always use the shortest cable possible to minimize the risk of induced RFI or EMI noise.

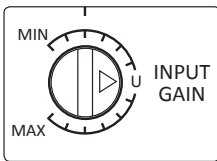

Input Gain: Sets the level of the input signal before it is amplified.

2.1.2 Power

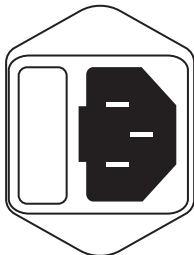

IEC Power Connection: Your Eris E44/E66 accepts a standard IEC power cord.

Warning: Do not remove the center grounding prong or use a ground-lift adapter, as this could result in electric shock.

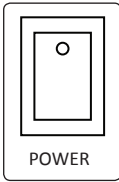

Power Switch. This is the On/Off switch. The power status is indicated by an LED on the front of the cabinet.

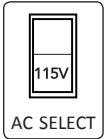

AC Select Switch. The input-power voltage is set at the factory to correspond with the country in which it was shipped. Use this switch only if you are using your Eris speakers in a country that uses a different standard voltage than is used in the country where you purchased your Eris E44 or E66.

2.1.3 Acoustic Tuning Controls

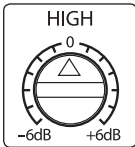

High: Boosts or cuts all frequencies above 10 kHz by ± 6 dB.

Power User Tip: *The High control on the Eris E44/E66 is a high-shelf EQ and attenuates or boosts frequencies above 10 kHz. This EQ is much like the treble control on a car stereo: It raises or lowers the gain on all frequencies above the specified cutoff frequency. Shelving EQs can make big changes to the sound very quickly by adding or removing an entire range of frequencies.*

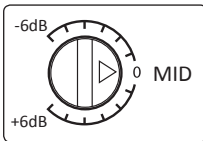

Mid: Boosts or cuts frequencies around 1 kHz by ± 6 dB.

The Mid control is a peak EQ that lets you boost or cut a specified frequency band (in this case, a band about two octaves wide, centered at 1 kHz). It's capable of more subtle changes.

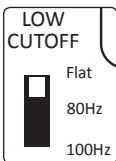

Low Cutoff: Rolls off the level of all frequencies below the specified frequency (80 or 100 Hz) at a slope of -12 dB/octave. Can be defeated by setting it to Flat, in which case, the monitor's natural rolloff takes over.

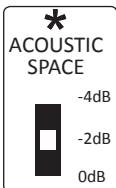

Acoustic Space: Cuts the level of all frequencies below 800 Hz by the specified amount (-2 or -4 dB) to compensate for the bass boost that occurs when the monitor is placed near a wall or corner. Can be defeated by setting it to 0 dB.

2.2 Hookup Diagrams

2.2.1 Basic Setup

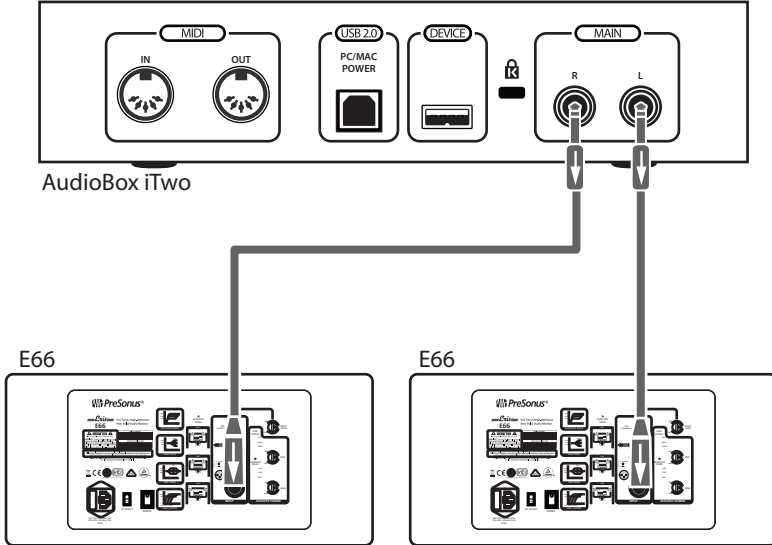

2.2.2 Advanced Setup with Speaker Switching

Studio 192

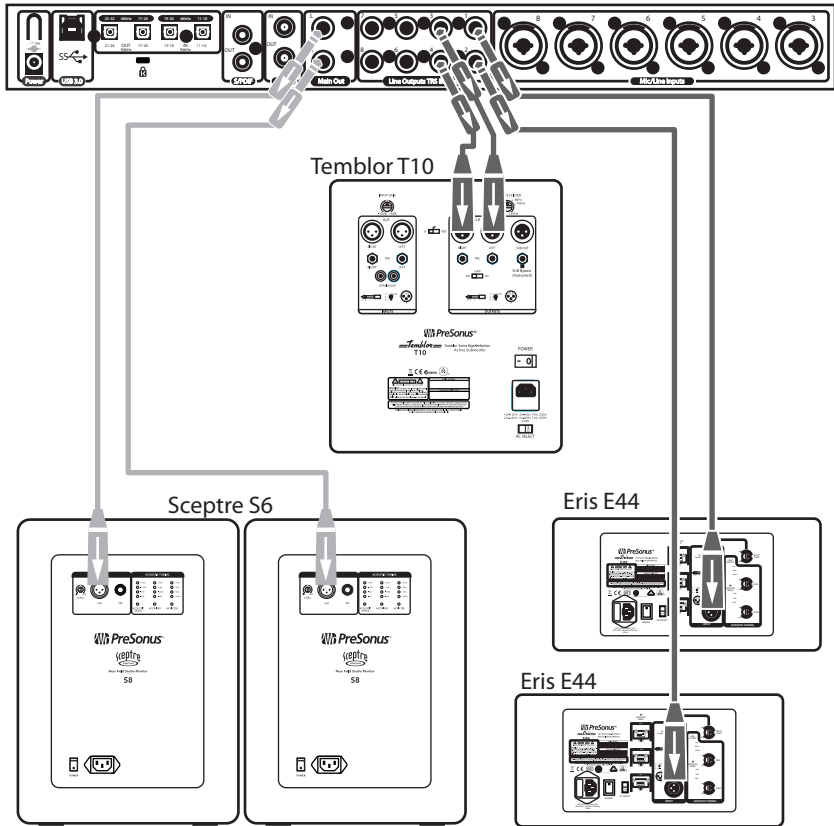

3 Tutorials

3.1 Monitor Placement

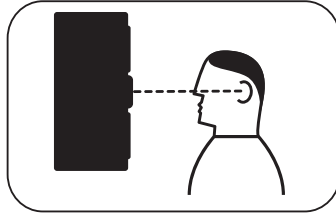

Ideally, near-field monitors should be placed so that the tweeters are at the same height as your ears when you are mixing.

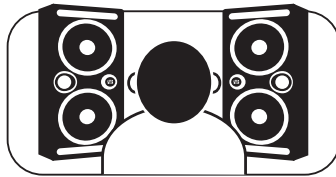

Eris E44 and E66 speakers can be placed vertically or horizontally; when placed vertically, they should form a mirror-image pair, with the tweeters on the outside.

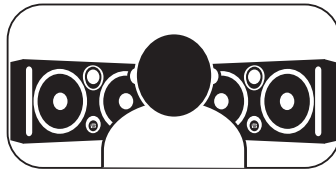

When placed horizontally, the tweeters should be on top.

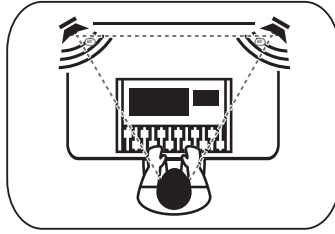

The speakers should be separated so that the tweeters form an equilateral triangle with your head. The monitors should be “toed in,” or angled, so that they are pointed at you, not pointed straight ahead.

3.1.1 Badge Rotation

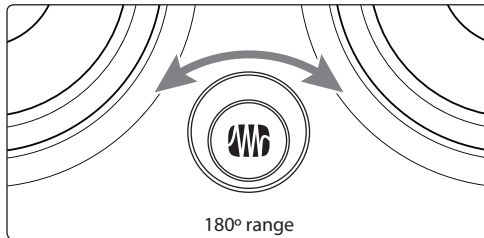

The logo badge on your Eris E44 and E66 can rotated to match their orientation in your studio. Once you have positioned your monitors in the orientation that works the best for you, simply use your fingers to twist the logo so that it is right side up.

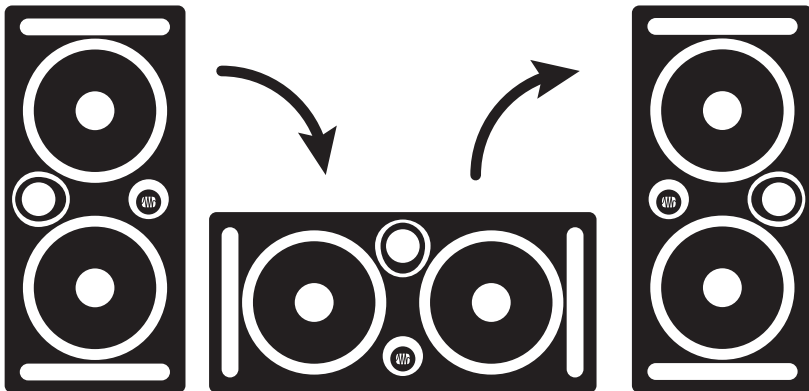

3.2 Input Gain Setting

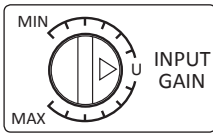

The best place to start is to set the Input Level control at its unity gain position (labeled “U”). That means the level of the signal reaching the amplifier is the same as the level of the signal entering the monitor’s input. This ensures a good, strong signal level without amplifying any extraneous noise. Make sure that the gain controls on your audio source have been optimized for maximum signal level and minimum noise. This process is called “gain staging,” and you can learn about it from many online sources. You should always set the Input Gain on your Eris monitor so that all other level controls in the system needn’t be turned way up or way down to achieve a comfortable listening volume.

If setting the input gain to Unity is unsatisfactory, you can try different settings, but remember that it’s better to avoid settings above U if possible. If the volume is too loud at unity gain, feel free to turn the Input Gain control down a bit—but not so far that you have to crank your audio source’s output level to its maximum setting. If you set it too low, you’ll have to crank your audio source’s output level way up, which will increase the audible noise from your source signal. If you set it too high, any noise in the signal will be amplified, which you don’t want, either! Again, if you properly gain-stage your audio source, setting Input Gain to U or slightly lower should work fine.

Once the monitor’s Input Gain control is set, leave it alone; don’t use it as a system-volume control. Leave that job to your audio device’s output-level control.

3.3 Equalizer Setting Suggestions

The Eris E44/E66 provides three EQ controls in its Acoustic Tuning section: High, Mid, and Low Cutoff. (There’s also an Acoustic Space control, which is covered in the next section.) In general, setting the High control to 0 (no boost or cut) will produce the best results. However, if the sound is generally too bright or shrill, try turning this control down below 0; if the sound is too dull and lifeless, try turning it up above 0. It’s always better to cut than to boost and to use the smallest cut or boost needed to get the job done.

The Mid control is a mid-frequency peak filter that boosts or cuts frequencies centered on 1 kHz and extending about one octave above and below that frequency. Again, setting this control to 0 will generally produce the best results. If you want to emulate a car stereo, try turning it down below 0 to approximate the common “smiley face”

EQ curve. On the other hand, if you want to emulate a cheap portable radio, try turning it up above 0. Try not to boost much, since this can add noise to the signal.

The Low Cutoff control rolls off the low frequencies below the specified frequency (80 or 100 Hz). Engage this control if you are using a subwoofer in conjunction with the Eris E44/E66 monitors, and set it to the same frequency as the crossover to the subwoofer. If you're not using a subwoofer, set the control to Flat. If you want to emulate a cheap radio, engage this control at 80 or 100 Hz while boosting the Mid control.

Power User Tip: *Do not use the EQ controls on your Eris monitor to correct problems in your mix. While this changes what you hear in the control room, it has no effect on your recorded audio.*

3.4 Acoustic Space Setting Suggestions

When a monitor is placed close to a wall, or in a corner, the low frequencies tend to be emphasized more than if the monitor is far from any room boundary; this effect is called "boundary bass boost." It is most pronounced if the monitor is in a corner and less pronounced, but present, if the monitor is near one wall.

To compensate for this bass boost, the Eris E44/E66 provides an Acoustic Space switch that cuts all frequencies below 800 Hz by a fixed amount.

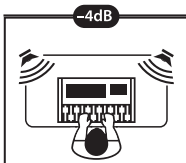

If the monitors are close to the corners of the room, start by setting the Acoustic Space switch to -4 dB, which provides the most bass attenuation.

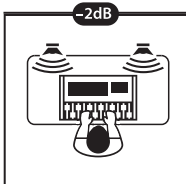

If the monitors are close to the back wall, try setting the Acoustic Space switch to -2 dB for less attenuation.

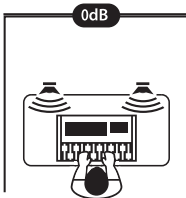

If the monitors are far from any wall, there will be no bass boost, so set the switch to 0 dB.

4 Resources

4.1 Technical Specifications

INPUTS (E44 and E66)

1- Balanced XLR

1- Balanced ¼" TRS

1- Unbalanced RCA

PERFORMANCE

Frequency Response

E44	55 Hz to 22 kHz
-----	-----------------

E66	45 Hz to 22 kHz
-----	-----------------

Crossover Frequency

E44	2.9 kHz
-----	---------

E66	2.4 kHz
-----	---------

LF Amplifier Power

E44	50W
-----	-----

E66	80W
-----	-----

HF Amplifier Power

E44	35W
-----	-----

E66	65W
-----	-----

Peak SPL at 1M

E44	103 dB
-----	--------

E66	106 dB
-----	--------

LF Drivers

E44	dual 4.5" Kevlar
-----	------------------

E66	dual 6.5" Kevlar
-----	------------------

HF Driver

E44	1.25" silk dome
-----	-----------------

E66	1.25" silk dome
-----	-----------------

Input Impedance

E44 and E66	10 kΩ
-------------	-------

USER CONTROLS**Volume Range**

E44 and E66	A-type taper
-------------	--------------

MF Control

E44 and E66	Variable (-6 to +6 dB)
-------------	------------------------

HF Control

E44 and E66	Variable (-6 to +6 dB)
-------------	------------------------

Low Cut

E44 and E66	Flat, 80 Hz, 100 Hz
-------------	---------------------

Acoustic Space

E44 and E66	Flat, -2 dB, -4 dB
-------------	--------------------

PROTECTION (E44 and E66)

RF interference	
-----------------	--

Output-current limiting	
-------------------------	--

Over-temperature	
------------------	--

Turn-on/off transient	
-----------------------	--

Subsonic filter	
-----------------	--

External mains fuse	
---------------------	--

POWER

E44 and E66	100-120V ~50/60 Hz or 220-240V ~50/60 Hz
-------------	--

CABINET

E44 and E66	Vinyl-laminated MDF
-------------	---------------------

PHYSICAL**(Width/Height/Depth)**

E44	7" x 7" x 14.3" (180 mm x 180 mm x 365 mm)
-----	--

E66	8.5" x 9.8" x 18.1" (215 mm x 250 mm x 460 mm)
-----	--

Weight

E44	11.9 lb (5.4 kg)
-----	------------------

E66	23.4 lb (10.6 kg)
-----	-------------------

4.2 Troubleshooting

No Power. First ensure that your Eris E44/E66 is plugged in. If it's connected to a power conditioner, verify that the power conditioner is turned on and functioning.

If problem still exists, disconnect the power cable from your E44/E66 and check the fuse on the back panel of your E44/E66. The fuse housing is located directly beneath the IEC power cable connection. A blown fuse may look black on the inside or the wire inside might appear broken. A very black fuse is a sign that something may have shorted out. Try replacing the fuse with a new one. The type of fuse needed for your monitor is listed below the power inlet. Be sure to use the correct fuse for the set input-power voltage. If the fuse blows again, you will need to contact PreSonus for a repair.

No audio. If your Eris E44/E66 appears to power on but you hear no sound when playing audio from your audio source (the lights are on but nobody's home), first make sure that the cable connecting your audio source to the monitor is working correctly. Also, verify that the Input Gain control is set to provide enough amplitude for the signal.

Hum. Usually, hum is caused by a ground loop. Verify that all audio equipment is connected to the same power source. If you are not using a power conditioner, we highly recommend that you add one. Not only will this help to minimize hum, it will better protect your equipment from power surges, brownouts, etc.

Use balanced cables whenever possible. If your audio device does not offer a balanced output, you can connect it to a direct box, which will provide a ground-lift switch and a balanced output.

Finally, make sure that your audio cables are not run near power cables, and use cables that are the appropriate length for your application. Using cables that are too long not only increases the risk of noise, it increases the likelihood that the cables are coiled, which will essentially create an antenna that picks up all kinds of audio interference.

4.3 Warranty

PreSonus's warranty obligations for this hardware product are limited to the terms set forth below:

How Consumer Law Relates To This Warranty:

THIS WARRANTY GIVES YOU SPECIFIC LEGAL RIGHTS, AND YOU MAY HAVE OTHER RIGHTS THAT VARY FROM STATE TO STATE (OR BY COUNTRY OR PROVINCE). OTHER THAN AS PERMITTED BY LAW, PRESONUS DOES NOT EXCLUDE, LIMIT OR SUSPEND OTHER RIGHTS YOU MAY HAVE, INCLUDING THOSE THAT MAY ARISE FROM THE NONCONFORMITY OF A SALES CONTRACT. FOR A FULL UNDERSTANDING OF YOUR RIGHTS YOU SHOULD CONSULT THE LAWS OF YOUR COUNTRY PROVINCE OR STATE.

PreSonus Products And EU Statutory Warranty:

When you purchase PreSonus products, European Union consumer law provides statutory warranty rights in addition to the coverage you receive from the PreSonus limited warranty. A summary of the EU Statutory Warranty and the PreSonus Limited Warranty is below:

	EU Consumer Law	PreSonus Limited Warranty
Repair or Replacement Coverage For	Defects present when customer takes delivery	Defects arising after customer takes delivery
Warranty Period	2 years (minimum) from original date of purchase (unless superseded by PreSonus)	1 year from original date of purchase (unless superseded by PreSonus)
Cost of Coverage	Provided at no additional cost	Included at no additional cost
Who to contact to make a claim	The seller	PreSonus technical support for your region

What This Warranty Covers:

PreSonus Audio Electronics, Inc., ("PreSonus") warrants defects in material and workmanship in PreSonus-branded products under normal use. This Limited Warranty applies only to hardware products manufactured by or for PreSonus that can be identified by the PreSonus trademark, trade name, or logo affixed to them.

Exclusions and Limitations:

This warranty does not cover the following:

1. Damage caused by accident, abuse, improper installation, failure to follow instructions in the applicable owner's manual or improper operation, rental, product modification, alteration, or neglect.
2. Damage from improper grounding, faulty wiring (AC and signal), faulty equipment, or connection to a voltage range outside published specifications (see applicable owner's manual).
3. Damage to drivers or diaphragm assemblies found to have burnt voice coils from over/under driving or signal surge from another device.
4. Damage occurring during shipment or improper handling.
5. Damage caused by repair or service performed by persons not authorized by PreSonus.
6. Products on which the serial number has been altered, defaced, or removed.
7. Products purchased from an un-authorized PreSonus dealer (products that have transferable warranties are excluded from this provision provided the customer and the product are registered with PreSonus).

Who This Warranty Protects:

This Warranty protects only the original retail purchaser of the product (products that have transferable warranties are excluded from this provision provided the customer and the product are registered with PreSonus)

How Long This Warranty Lasts:

The Warranty begins on the original date of purchase from the retail purchaser and the duration is as follows:

1-Year Limited Warranty		
Product Category	Model	Transferable
Recording Interfaces	AudioBox iOne, AudioBox iTwo, AudioBox Stereo, AudioBox Studio, AudioBox USB, AudioBox VSL (1818, 44, 22), FireStudio Project, FireStudio Mobile, FireStudio Mobile Studio, Music Creation Suite	No
Pre-amplifiers	ADL600, ADL700, BlueTube DP V2, DigiMax D8, Eureka, RC500, StudioChannel, TubePre V2	No
StudioLive Mixers	SL-1642, SL-2442, SL-1602, SLM16.4.2 AI, SLM24.4.2 AI, SLM32.4.2AI	No
Monitoring & Controlling	Eris, Central Station Plus, FaderPort, HP4, HP60, Monitor Station, Monitor Station V2, Sceptre, Temblor	No
Signal Processing	ACP88	No
Accessories	Covers, Dolly, PRM1 mic, Sub Pole, Breakout Cables, Power Supplies, M10 Kit	No
3-Years Limited Warranty		
Product Category	Model	Transferable
Live Sound	StudioLive AI 328, 312, 315, 18S	Yes

What PreSonus Will Do:

PreSonus will repair or replace, at our sole and absolute option, products covered by this warranty at no charge for labor or materials. If the product must be shipped to PreSonus for warranty service, the customer must pay the initial shipping charges. PreSonus will pay the return shipping charges.

How to Get Warranty Service (USA):

1. You must have an active user account with PreSonus and your hardware must be on file with your account. If you do not have an account, please go to: <http://www.presonus.com/registration> and complete the registration process.
2. Contact our Technical Support Department at (225) 216-7887 or log a support ticket at: <http://support.presonus.com>. TO AVOID THE POSSIBILITY OF SENDING IN A PRODUCT THAT DOES NOT HAVE A PROBLEM, ALL SERVICE REQUESTS SHALL BE CONFIRMED BY OUR TECH SUPPORT DEPARTMENT.

3. The return authorization number as well as shipping instructions shall be provided after your service request is reviewed and confirmed.
4. The product should be returned for service in the original product packaging. Products may be shipped in a manufactured "flight" or "road" style cases but PreSonus will NOT cover any shipping damage to these cases. Products that are not shipped in the original product package or a manufactured case may not receive a warranty repair, at PreSonus's sole discretion. Depending on the product model and the condition of your original packaging, your product may not be returned to you in the original packaging. The return shipping box may be a generic box that has been fitted for that model tested if the original gift box is not available.

How to Get Warranty Service (outside of USA):

1. You must have an active user account with PreSonus and your hardware must be on file with your account. If you do not have an account, please go to: <http://www.presonus.com/registration> and complete the registration process.
2. Contact the Technical Support/Service Department for your region at http://www.presonus.com/buy/international_distributors and follow procedures provided by your PreSonus contact.

Limitation of Implied Warranties:

ANY IMPLIED WARRANTIES, INCLUDING WARRANTIES OF MERCHANTABILITY AND FITNESS FOR A PARTICULAR PURPOSE, ARE LIMITED IN DURATION TO THE LENGTH OF THIS WARRANTY.

Some states, countries, or provinces do not allow limitations on how long an implied warranty lasts, so the above limitation may not apply to you.

Exclusion of Damages:

PRESONUS'S LIABILITY FOR ANY DEFECTIVE PRODUCT IS LIMITED TO THE REPAIR OR REPLACEMENT OF THE PRODUCT, AT PRESONUS'S SOLE OPTION. IF PRESONUS ELECTS TO REPLACE THE PRODUCT, THE REPLACEMENT MAY BE A RECONDITIONED UNIT. IN NO EVENT WILL PRESONUS BE LIABLE FOR DAMAGES BASED ON INCONVENIENCE, LOSS OF USE, LOST PROFITS, LOST SAVINGS, DAMAGE TO ANY OTHER EQUIPMENT OR OTHER ITEMS AT THE SITE OF USE, AND, TO THE EXTENT PERMITTED BY LAW, DAMAGES FOR PERSONAL INJURY, OR ANY OTHER DAMAGES WHETHER INCIDENTAL, CONSEQUENTIAL OR OTHERWISE, EVEN IF PRESONUS HAS BEEN ADVISED OF THE POSSIBILITY OF SUCH DAMAGES.

Some states, countries, or provinces do not allow limitations on how long an implied warranty lasts, so the above limitation may not apply to you.

If you have any questions about this warranty or service received, please contact PreSonus (USA) at (225) 216-7887 or one of our authorized international distributors at: http://www.presonus.com/buy/international_distributors.

Product features, design, and specifications are subject to change without notice.

Added bonus: PreSonus' previously Top Secret recipe for... **Rice Dressing**

Ingredients:

- 1lb ground beef
- 1 lb chopped chicken liver
- 1 onion (diced)
- 2 green peppers (diced)
- 4-6 celery stalks (diced)
- 2 garlic cloves (minced)
- ¼ C. chopped fresh parsley
- 3 C. chicken stock
- 6 C. cooked rice
- 1 Tbs. oil
- Salt and pepper to taste
- Cayenne pepper to taste

Cooking Instructions:

1. In a large pot, heat oil on medium high and add meat, salt, and pepper to taste. Stir until meat begins to brown.
2. Lower heat and add all vegetables. Cook until onions are transparent and celery is very tender. Add stock as necessary to prevent burning.
3. Stir in cooked rice. Add remaining stock and simmer on low until ready to serve.

Eris™ Series E44 / E66

High-Definition MTM Studio Monitors

Owner's Manual

