

ZOOM®

Q8

Handy Video Recorder

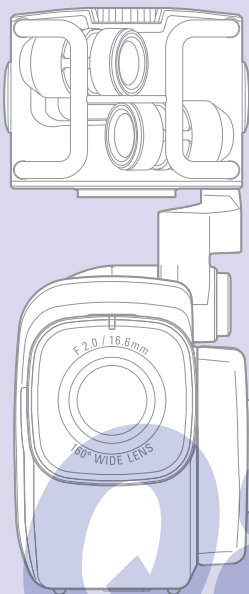

User Guide

Safety and Operation
Precautions must be read
before using this unit.

© 2015 ZOOM CORPORATION

Copying or reproduction of this User Guide in
part or in whole without permission is prohibited.

Contents

Contents	1	Playing recordings.....	28
Parts and their functions	2	Deleting recordings	31
Mic overview.....	5	Mixer Screen settings.....	32
Connecting mics to Inputs 1 and 2.....	7	Headphones/line and HDMI output....	40
Display overview	8	USB connections	41
Charging the battery.....	11	LCD Rotation and FILE list.....	43
Turning the power ON and OFF.....	12	System settings.....	44
Setting the date and time.....	13	Updating the firmware	45
Formatting SD cards.....	14	Troubleshooting.....	46
Recording mode overview.....	15	Specifications.....	47
Selecting tracks to record.....	19	Safety Precautions.....	48
Adjusting recording levels	21	Usage Precautions.....	49
Adjusting the angle of view	22	Warnings and requests regarding safe battery use.....	50
Recording	23		
Audio monitoring settings	24		
Recording mode settings	25		
Camera settings	27		

Parts and their functions

■ Left side

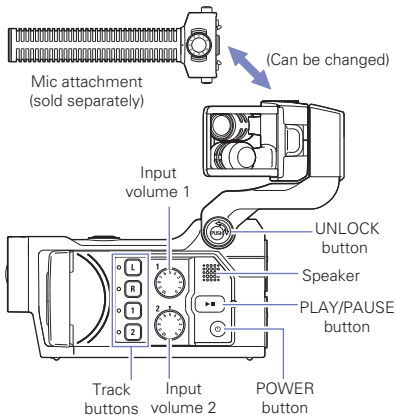

■ Top

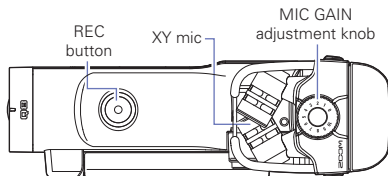

Parts and their functions (continued)

■ Front

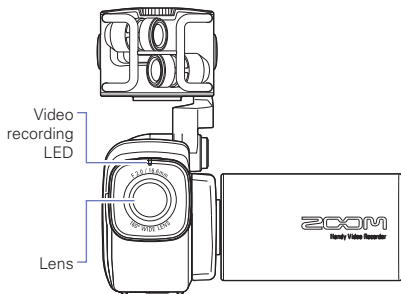

Opening and closing the LCD screen

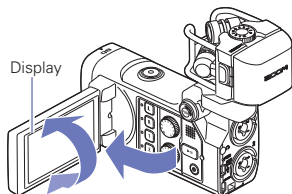

■ Back

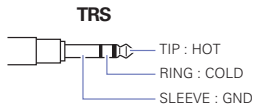
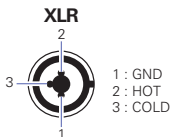
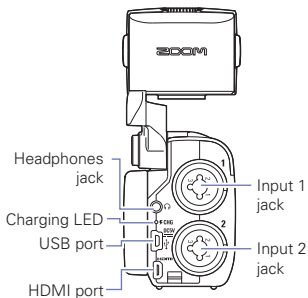

■ Right side

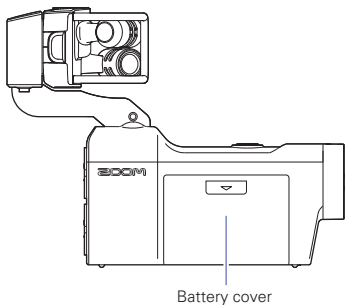

NOTE

Connecting the battery

- 1 Slide the battery cover down to remove it.
- 2 Install the battery as shown in the illustration and reattach the battery cover.

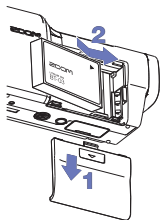

Mic overview

The XY mic included with the **Q8** can be swapped with another mic attachment according to your need.

■ Raising the mic

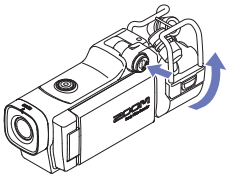

1. While pressing the UNLOCK button, raise the mic until it reaches the fixed position.

■ Lowering the mic

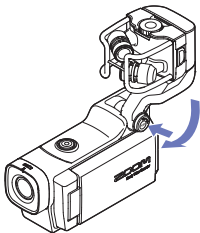

1. While pressing the UNLOCK button, lower the mic.

CAUTION

Do not force the mic arm without pushing the UNLOCK button. Doing so could damage the main unit.



■ Attaching the mic

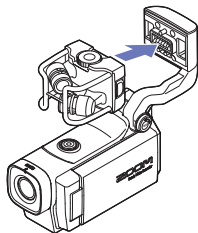

1. Attach the mic to the main unit and push it into place until it locks.

■ Disconnecting the mic

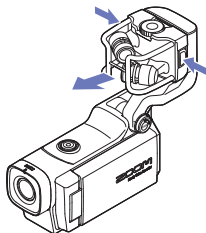

1. While pressing the buttons on the left and right sides of the mic, pull it out of the main unit.



CAUTION

- When disconnecting the mic, do not use too much force. Excessive force could damage the mic or the main unit.
- Video recording will stop if a mic is removed during recording.

Connecting mics to Inputs 1 and 2

You can connect mics, mixers and other devices to the **Q8** Inputs 1 and 2. The L/R input from the XY mic and Inputs 1/2 can be used together to record up to 4 tracks at the same time.

■ Connection examples

Recording audio is possible in the following kinds of situations.

Concert video recording

- L/R input mic: Performance on stage
- Inputs 1/2: Line outputs from mixer

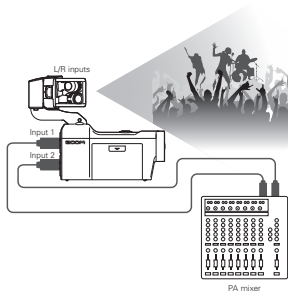

Guitar performance video recording

- L/R input mic: Off-mic recording of vocal and guitar
- Input 1: Vocal mic
- Input 2: Guitar mic (direct)

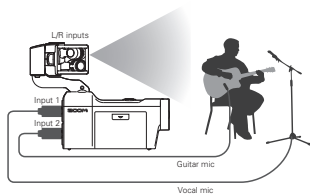

NOTE

Connect dynamic and condenser mics with XLR plugs to Inputs 1 and 2. Phantom power (+12V/+24V/+48V) can be supplied to condenser mics. (→ P:36)

Display overview

■ Main Screen

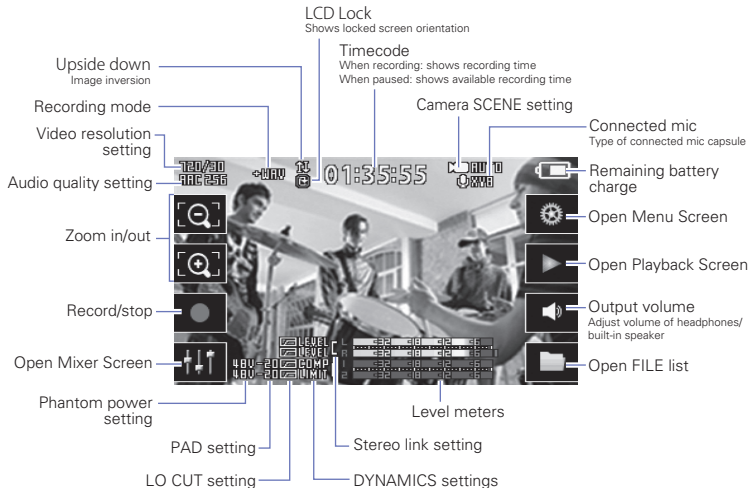

NOTE

If you touch anywhere other than a button or allow some time to pass without operation, the buttons will disappear and only the level meters will be shown.

Display overview (continued)

■ Playback screen



When paused

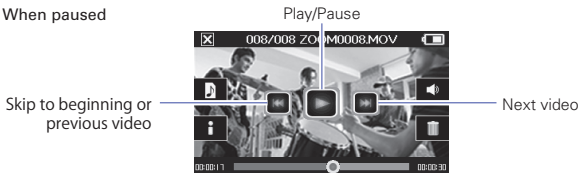

NOTE

- After some time passes without operation, only the video image will be shown. Touch the screen to show the buttons again.
- Level meters can be shown on the playback screen. (See "System settings" on page 44.)

■ Mixer Screen

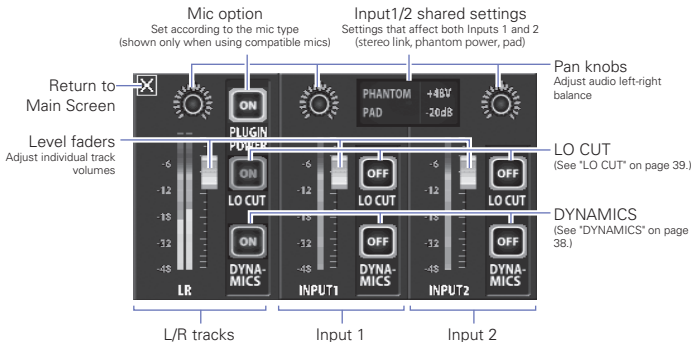

NOTE

When Inputs 1/2 are stereo-linked, they appear differently on the Mixer Screen. (See "Stereo link setting" on page 35.)



Charging the battery

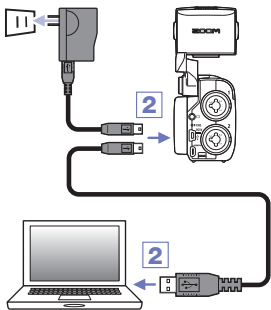

1. Turn the **Q8** off.
2. Connect a USB power source (running computer or ZOOM AD-17 AC adapter (sold separately)).

While the battery is recharging, the Charging LED on the back of the **Q8** will stay lit.

3. After charging completes, disconnect the cable from the USB power source.

After recharging has completed, the Charging LED will become unlit.

NOTE

Recharging the battery completely (100%) takes about 4 hours 30 minutes when connected to a computer and about 2 hours 45 minutes when using an AC adapter. (The amount of time required will vary depending on the conditions.)

CAUTION

- The battery will not charge while the recorder is on.
- The surrounding temperature should be between 5°C and 35°C (41°F and 95°F) when charging. At other temperatures, the battery could become hot, damaged or weakened.
- Do not leave the cable connected for a long time after charging completes.
- You must also follow the handling instructions in "Warnings and requests regarding safe battery use" on page 50.

Turning the power ON and OFF

■ Turning the power ON

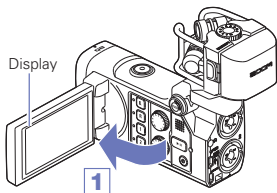

1. Open the LCD.

2. Press  .

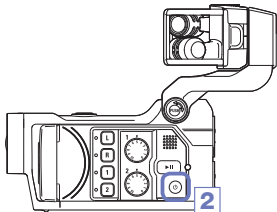

■ Turning the power OFF

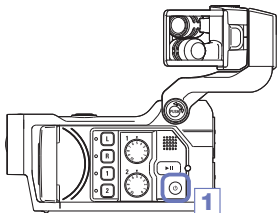



1. Press and hold  .

After "Goodbye See You!" appears, the power turns off.

Setting the date and time

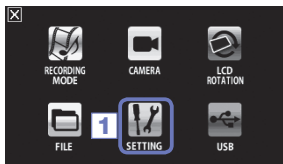
If the date and time are set, the recorder can add the recording date and time to files.



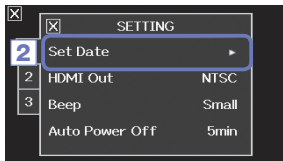

1. On the menu screen, touch  .

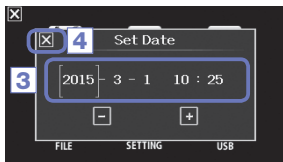

2. In the sub menu, touch "Set Date".





3. Touch an item to be changed to select it, and touch  and  to set the current date and time.

4. After completing the setting, touch  to close the submenu.

Formatting SD cards

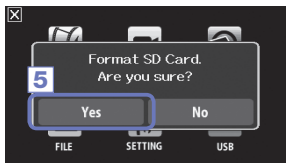
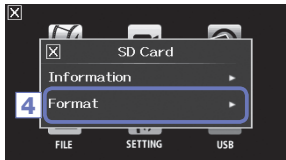
You should format SD cards for use with the **Q8**.



1. On the menu screen, touch  .
2. Touch  .
3. In the sub menu, touch "SD Card".
4. In the sub menu, touch "Format".
5. On the confirmation screen, touch "Yes".

This will start SD card formatting. Select "No" to return to the SD Card menu.

After formatting completes, "Done" will appear and the SD Card menu will reopen.

NOTE

If the SD card's write-protection switch is ON, it cannot be formatted.



CAUTION

- After purchasing a new SD card, always format it using the **Q8** to maximize performance.
- All data previously saved on the SD card will be deleted when it is formatted.

Recording mode overview

The **Q5** can save individual unmixed audio files at the same time as video files. Use the RECORDING MODE menu to change the recording mode. (See "Recording mode settings" on page 25.)

■ MOV mode

The four channels of audio from the mic capsule L/R inputs and external 1/2 inputs are mixed to stereo and saved together with the video in a single video file (MOV format).

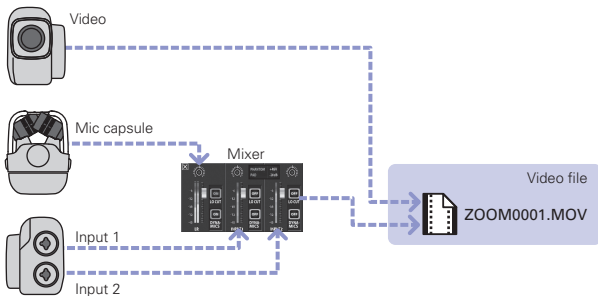

MOV+WAV mode

Audio files (WAV format) are saved for each audio track at the same time as video files. The audio from the mic capsule L/R inputs and the audio from the external 1/2 inputs are saved as separate files.

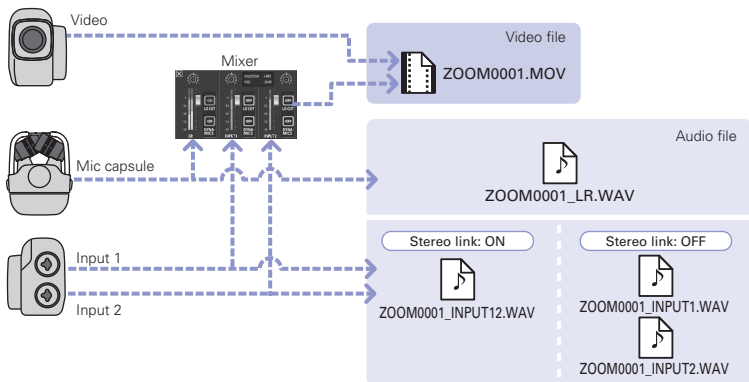

NOTE

- Only 44.1/48kHz WAV formats (16/24-bit) can be selected when recording in MOV+WAV mode.
- In MOV+WAV mode, audio cannot be output from an HDMI TV.
- Audio will be saved to audio files before passing through mixer level and pan adjustments.

Recording mode overview (continued)

■ STEREO AUDIO mode

The four channels of audio from the mic capsule L/R inputs and external 1/2 inputs are mixed to stereo and saved as a single stereo audio file. Video is not recorded.

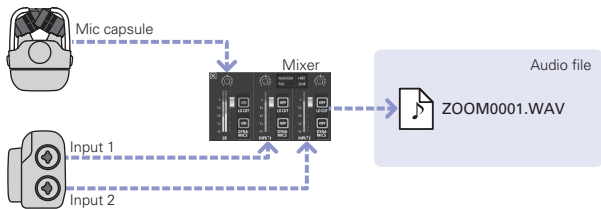

■ MULTI AUDIO mode

The audio from the mic capsule L/R inputs and the audio from the external 1/2 inputs are saved as separate audio files (WAV format). Video is not recorded.

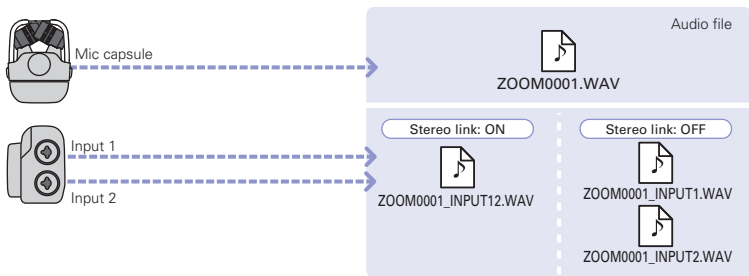

NOTE

- Only 44.1/48kHz WAV formats (16/24-bit) can be selected when recording in MULTI AUDIO mode.
- In MULTI AUDIO mode, the names of the files created depend on the ON/OFF status of each track. (See "Selecting tracks to record" on page 19.)
- In MULTI AUDIO mode, audio cannot be output from an HDMI TV.
- Audio will be saved to audio files before passing through mixer level and pan adjustments.

Selecting tracks to record

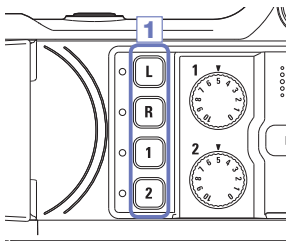

1. Press the buttons of the tracks that you want to record.

NOTE

The indicators of the selected track buttons light red, and you will be able to monitor the signals input on these tracks through headphones/line output.

2. To record Inputs 1/2 as a stereo file (stereo link), press both of their track buttons at the same time.

To end the stereo link, press the track buttons for Inputs 1/2 at the same time.

NOTE

The stereo link of the L/R tracks cannot be disabled.

NOTE

Stereo link settings can also be made using the Input 1/2 shared settings on the Mixer Screen. (See page 35.)

NOTE

File names when recording in MOV+WAV mode

Track recorded	File name	Description
L/R input	ZOOMnnnn_LR.WAV	Stereo file
Input 1	ZOOMnnnn_INPUT1.WAV	Mono file
Input 2	ZOOMnnnn_INPUT2.WAV	Mono file
Inputs 1/2 (stereo link active)	ZOOMnnnn_INPUT12.WAV	Stereo file

File names when recording in MULTIAUDIO mode

The name of the first file is "ZOOMnnnn.WAV". Second and later files will have track names added to their names.

• L/R inputs on

Track recorded	File name	Description
L/R input	ZOOMnnnn.WAV	Stereo file
Input 1	ZOOMnnnn_INPUT1.WAV	Mono file
Input 2	ZOOMnnnn_INPUT2.WAV	Mono file
Inputs 1/2 (stereo link active)	ZOOMnnnn_INPUT12.WAV	Stereo file

• L/R inputs off, Inputs 1/2 on (stereo link active)

Track recorded	File name	Description
Inputs 1/2 (stereo link active)	ZOOMnnnn.WAV	Stereo file

• L/R inputs off, Inputs 1/2 on (no stereo link)

Track recorded	File name	Description
Input 1	ZOOMnnnn.WAV	Mono file
Input 2	ZOOMnnnn_INPUT2.WAV	Mono file

• Input 1 only

Track recorded	File name	Description
Input 1	ZOOMnnnn.WAV	Mono file

• Input 2 only



Track recorded	File name	Description
Input 2	ZOOMnnnn.WAV	Mono file

Note: "nnnn" in the file name is a four-digit number

Adjusting recording levels

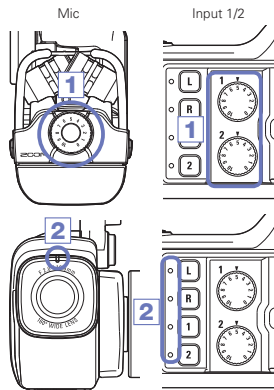
You can adjust the recording level manually.



1. When using the XY mic, turn  on the mic.
When using Inputs 1/2, turn  on the left side of this recorder.
2. Adjust the level so that the recording and track key LEDs do not blink even when loud sounds are input.

NOTE

If an input clips, the recording and track key LEDs will blink.

Adjusting the angle of view

You can set the digital zoom to one of five levels.



1. Touch  and  on the Main Screen.

: Zoom in.

Close in on the central subject.

: Zoom out.

Record more of the scene.

Recording

From the Main Screen, you can start recording video by pressing a single button.

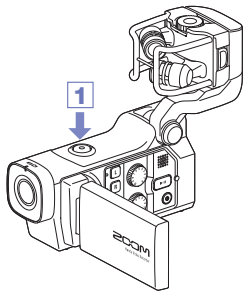

1. After preparing to record, press .

This starts video recording.

During video recording, the video recording LED above the lens lights red.

2. To end recording, press  again.





NOTE

- If the transfer speed to the card is not fast enough during video recording, "Low Speed Card!" appears on the screen and recording stops. To avoid this, we recommend using cards that are Class 10 or faster. Information about SD cards that can be used with this unit is provided at www.zoom.co.jp.
- Use the RECORDING MODE menu to make specific video recording settings. (See "Recording mode settings" on page 25.)

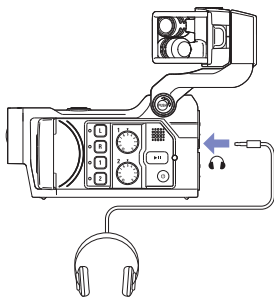
Audio monitoring settings

You can monitor audio being recorded with video through the headphones jack.





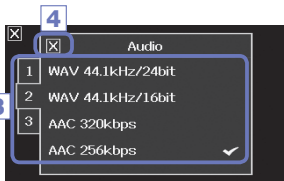
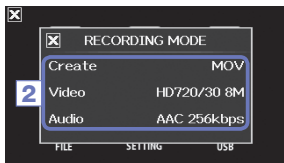

1. Connect headphones or other audio equipment to the headphones jack on the back of the recorder.
2. To adjust the monitoring volume, touch  on the display.
3. In the sub menu, touch  and  .
4. After completing the setting, touch  to close the submenu.

Recording mode settings

You can change the type of files created, video recording resolution and frame rate, and audio quality, for example. Increasing the video resolution decreases the possible recording time.



1. On the menu screen, touch .
2. In the sub menu, touch the item that you want to set.
3. In the sub menu, touch the setting value.
Touch    to show hidden Video or Audio items.
4. After completing the setting, touch  to close the submenu.

RECORDING MODE

Create: Type of files created. (see "Recording mode overview" on page 15.)

Setting	Explanation
MOV	Record MOV files containing both video and audio.
MOV+WAV	WAV files are saved separately for each track in addition to MOV files.
STEREO AUDIO	Only audio is saved as WAV files.
MULTI AUDIO	Four-channel audio is saved as multiple WAV files.

Video: video recording resolution and frame rate

Setting	Resolution	Frames/second	Explanation	File size
3M HD/30 24Mbps	2304 x 1296	30	Record at a resolution higher than Full HD.	 Large Small
HD 1080/30 24Mbps	1920 x 1080	30	Play on HD TVs.	
HD 1080/30 16Mbps	1920 x 1080	30	Save SD card space and play on HD TVs.	
HD 720/60 15Mbps	1280 x 720	60	Record scenes with fast movement.	
HD 720/30 8Mbps	1280 x 720	30	Playback on HD TVs and computers.	
VVGA/60 8Mbps	800 x 480	60	Save SD card space and record scenes with fast movement.	
VVGA/30 5Mbps	800 x 480	30	Save SD card space.	

Audio: recording audio quality

Setting	Explanation	File size
WAV 96kHz/24bit	Record in an uncompressed WAV format when audio quality is important. The higher the sampling frequency (kHz) and bit rate, the better the audio quality.	 Large Small
WAV 96kHz/16bit		
WAV 48kHz/24bit		
WAV 48kHz/16bit		
WAV 44.1kHz/24bit		
WAV 44.1kHz/16bit		
AAC 320kbps	Record in a compressed AAC format when you need to save SD card space. The higher the bit rate (bps), the better the audio quality.	
AAC 256kbps		
AAC 192kbps		
AAC 128kbps		
AAC 64kbps		



NOTE

Only 44.1/48kHz, 16/24-bit WAV formats can be selected when the recording mode setting is MOV+ -WAV or MULTI AUDIO.

Camera settings

You can change the camera settings to suit the video recording conditions.



1. On the menu screen, touch .
2. In the sub menu, touch the setting value.
3. After completing the setting, touch  to close the submenu.

CAMERA



Scene: Set the camera for the lighting conditions when video recording

Setting	Explanation
Auto	Adjust to lighting conditions automatically.
Concert Lighting	Best setting for live shows, concerts and other situations with bright lights.
Night	Best setting for night and other dark situations.

Upside Down: Reverse vertical orientation when recording

Setting	Explanation
On	Video will be saved with the image rotated 180°. Use when the  is recording upside down, for example.
Off	Video is not rotated.

Self Timer: Sets self timer (can only be used when the LCD is rotated)

Setting	Explanation
Off	Do not use the self timer.
3 sec	Start recording 3 seconds after pressing  .
5 sec	Start recording 5 seconds after pressing  .
10 sec	Start recording 10 seconds after pressing  .

Playing recordings

This unit can play recorded videos.



1. Press or touch on the Main Screen.

This starts playback of the last recorded video. After there are no operations for some time, only the video image will be shown. Touch the screen to show the buttons again.

2. To play a different file, press or touch the screen, and then touch or .

3. To stop playback, touch .

The Main Screen will reappear.

● Other operations

Play previous/next recording	When paused, press / .
Jump	During playback, touch the bar on screen and drag to the position you want. (see page 29.)
Pause	Touch the screen during playback.
End pause	Touch when paused.
Adjust the volume	Touch or , and then touch or in the submenu.

NOTE

- The can only play videos that it recorded.
- By connecting an HDMI cable (sold separately) to the HDMI OUT, video can be output to an external device. (See "HDMI output" on page 40.)
- Use QuickTime to play recorded videos on a computer. QuickTime can be downloaded from the Apple Inc. website.

Playing recordings (continued)

■ Changing the playback position



■ Selecting the audio played

With video recorded in MOV+WAV or MULTI AUDIO mode, you can select the audio for playback.

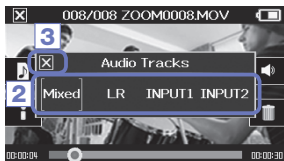

1. Touch the playback position bar and slide it to the position you want.

Remove your finger from the screen to start playback from that position.

1. Touch  on the playback screen.



2. In the sub menu, touch the audio file to play.

Setting	Explanation
Mixed	Play the mixed audio.
LR	Play the L/R input audio.
INPUT 12	Play the audio from stereo-linked Inputs 1/2.
INPUT 1	Play the Input 1 audio.
INPUT 2	Play the Input 2 audio.

3. After completing the setting, touch  to close the submenu.

■ Playing files from the list



1. Touch  on the Main Screen or touch  in the menu.

This opens the FILE list screen.

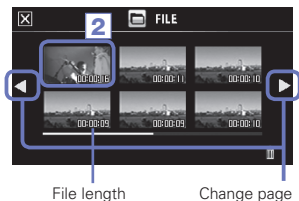

2. Touch the file to play back.

This opens a submenu.

Touch "Play Back" to start playback.

3. To stop playback, touch .

The FILE list screen will reappear.

File length

Change page

Deleting recordings

You can delete videos to increase the open space on the media.



1. Touch  on the FILE list screen.

A list of videos appears.

Touch ◀ ▶ to change the screen.

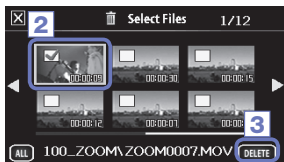

2. Touch a video to select it for deletion.

A check mark appears on the selected video.

You can repeat step 2 to add check marks to multiple videos.

3. Touch .

4. On the confirmation screen, touch "Yes".

The selected videos will be deleted.

NOTE

- You can also touch  on a video playback screen to delete that video.
- With video recorded in MOV+WAV or MULTI AUDIO mode, related audio files will also be deleted at the same time.

Mixer Screen settings

■ Using the Mixer Screen



1. On the Main Screen, touch .



This opens the Mixer Screen.

2. Touch the function you want to set.

This will open a setting screen for that function.

Changing values



Touch  or , or touch and slide the slider to adjust a value.

Touch  to restore the default value.

Selecting from lists

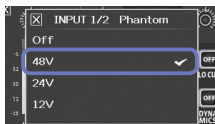

Touch an item in a shown list to select it.

Changing settings



Touch a button to open a submenu where you can change the setting.

Mixer Screen settings (continued)

■ Adjusting levels and panning

Levels

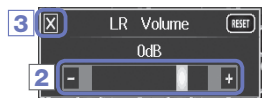
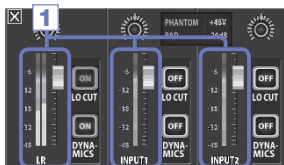

1. On the Mixer Screen, touch the fader for the channel that you want to adjust.
2. In the sub menu that appears, touch **+** / **-** or move the slider to adjust it.
3. After completing the setting, touch **X** to close the submenu.

Panning

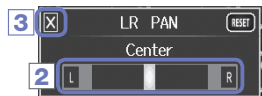
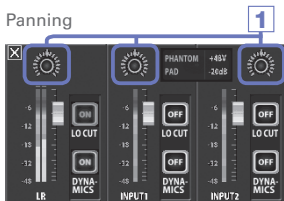

1. On the Mixer Screen, touch the pan pot for the channel that you want to adjust.
2. In the sub menu that appears, touch **L** / **R** or move the slider to adjust it.
3. After completing the setting, touch **X** to close the submenu.

■ Making settings for different mic types

For the LR channel inputs, you can make specific settings according to the type of mic capsule connected to the **QES**.

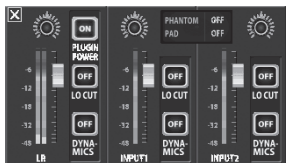

Mic capsule that supports plug-in power

When a mic that supports plug-in power is connected to the **QES**, you can set whether or not plug-in power is supplied to the external input jack. (See "PLUGIN POWER" on page 38.)



MS mic capsule

If an MS attachment, for example, is connected to the **QES**, you can adjust the side mic level.

NOTE

Audio from an MS mic is converted to stereo format during recording.

Mixer Screen settings (continued)

■ Stereo link setting

By enabling the stereo link, Inputs 1/2 can be handled as a stereo pair.

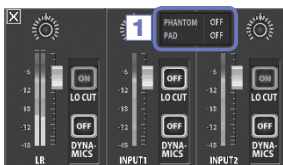

1. Touch the shared setting area for Inputs 1/2 on the Mixer Screen.
2. Change the "INPUT 1/2 Stereo Link" setting in the submenu.
3. After completing the setting, touch  to close the submenu.

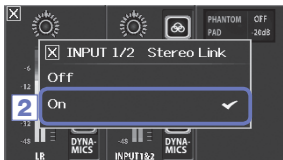



NOTE

You can also set the stereo link by pressing the track buttons for Inputs 1/2 at the same time. (See page 19.)

■ Phantom power

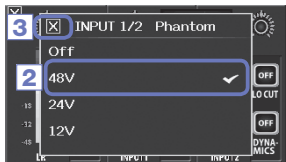
Inputs 1/2 support phantom power. They can supply power at +12V, +24V or +48V.



1. Touch the shared setting icons for Inputs 1/2 on the Mixer Screen.
2. In the sub menu, change the "INPUT 1/2 Phantom" setting to the voltage you want the unit to supply.
3. After completing the setting, touch  to close the submenu.

NOTE

When using condenser mics that can operate with less than +48V phantom power, you can reduce the power consumption of the  by selecting a lower voltage.

■ PAD (reduce input signal levels)

Turn the PAD function ON to reduce input signal levels by 20 dB in order to allow connection of mixers and other devices with a rated output level of +4 dB.



1. Touch the shared setting icons for Inputs 1/2 on the Mixer Screen.
2. In the sub menu, change the "INPUT 1/2 PAD" setting to "-20dB".
3. After completing the setting, touch  to close the submenu.

Mixer Screen settings (continued)

■ EXT MS MATRIX

Signals from an MS format stereo mic input through Inputs 1/2 can be converted to an ordinary stereo (L/R) signal. You must activate the stereo link for Inputs 1/2 before recording.



1. Press the track buttons for Inputs 1/2 at the same time to activate the stereo link.
2. Touch  on the Mixer Screen.
3. Change the "EXT MS Matrix" setting in the submenu that opens.

This opens the MS-MATRIX settings screen.

Setting :

Setting	Explanation
Off	Disable the MS-MATRIX.
In1=Mid, In2=Side	Input 1 will be assigned to the mid mic and Input 2 will be assigned to the side mic.
In1=Side, In2=Mid	Input 1 will be assigned to the side mic and Input 2 will be assigned to the mid mic.

Mid Level:

Adjust the level of the unidirectional mic used to capture the center of the sound (Mid).

This can be set to mute or from -48.0 to $+12.0$ dB.

Side Level:

Adjust the level of the bidirectional mic used to capture sounds from left and right (Side).

This can be set to mute or from -48.0 to $+12.0$ dB.

4. After completing the setting, touch  to close the submenu.

■ PLUGIN POWER

This unit can provide plug-in power to mics that use it. Make the following settings before connecting mics.

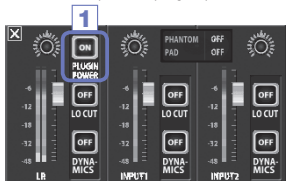

1. Touch "PLUGIN POWER" on the Mixer Screen.
Touching this toggles it ON/OFF

NOTE

You can use this when a mic capsule that supports plug-in power is connected.

■ DYNAMICS

This digital effect reduces audio dynamics. It compensates to reduce volume changes.

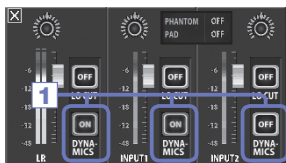

1. On the Mixer Screen, touch the "DYNAMICS" button for the channel that you want to adjust.
2. Change the "DYNAMICS" setting in the submenu that opens.
3. After completing the setting, touch  to close the submenu.

Setting	Explanation
Off	Disable DYNAMICS.
Limiter	If the input signal exceeds a certain level, it will be compressed so the volume stays below that level. This suppresses sudden peaks, making listening to the recorded audio easier.
Compressor	This compresses high-level sounds and raises low-level sounds. When recording bands, for example, this can increase the sound pressure, which increases the impact of the audio.
Leveler	If low-level sound continues, the input signal is amplified and adjusted to make the volume even. This is effective when volume differences are great, such as when an emcee speaks between concert performances.



CAUTION

The DYNAMICS function cannot be used when the audio file format is set to 96kHz WAV.

Mixer Screen settings (continued)

■ LO CUT (low-frequency cut)

You can turn the low-cut filter on to reduce the sound of wind, vocal pops and other noise.

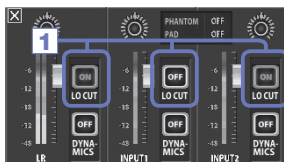

1. On the Mixer Screen, touch the "LO CUT" button for the channel that you want to adjust.
2. Change the "lo cut" setting in the submenu that opens.
3. After completing the setting, touch  to close the submenu.



Setting	Explanation
Off	Disable the lo-cut filter.
80Hz	Cut audio below 80 Hz.
120Hz	Cut audio below 120 Hz.
160Hz	Cut audio below 160 Hz.

Headphones/line and HDMI output

Headphones/line output

You can listen to the audio with headphones or an external audio amplifier.

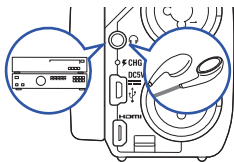

1. Connect headphones or audio equipment to the **Q8** headphones jack using a stereo mini plug cable.
2. Start video playback on the **Q8**.

HDMI output

Use an HDMI cable to connect with an HDMI TV to show **Q8** video recordings in high definition.

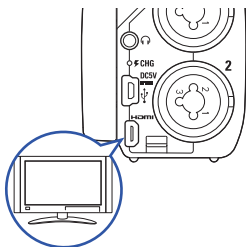

1. Connect the **Q8** HDMI jack with a TV using an HDMI cable (commercially-available).
2. Start video playback on the **Q8**.

NOTE

Some TVs do not support some audio formats, so correct playback might not always be possible.

CAUTION





- The **Q8** has an HDMI Type D Micro connector. When using a commercially-available HDMI cable, be sure to use a High Speed HDMI (category 2) cable that has an HDMI Type D Micro connector on one end to connect to the **Q8** and a connector that matches the TV's HDMI input on the other end.
- When recording video, connecting or disconnecting an HDMI cable will cause video and audio recording to stop.

USB connections

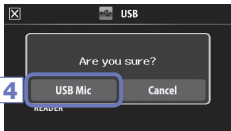
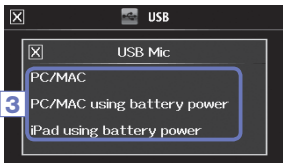
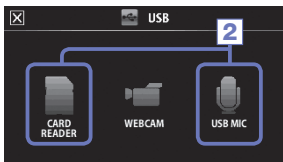
By connecting with a computer or iPad using a USB cable, you can use this recorder as a card reader or USB mic, as well as to stream audio and video as a web camera.

■ Using as a card reader or USB mic (computer/iPad)



1. On the menu screen, touch  .
This opens the USB menu.
2. Touch  (CARD READER) or  (USB MIC).
3. In the sub menu, touch "PC/MAC", "PC/MAC using battery power" (USB Mic only) or "iPad using battery power".
4. On the confirmation screen, touch "Card Reader" or "USB Mic".
5. Use a USB cable to connect a computer or an iPad.
When the  is recognized, it will be ready to use.
6. To end use, conduct the necessary procedures from the computer to end the USB connection. Then, touch  and disconnect the USB cable.
When connected to an iPad or when using the recorder as a USB mic, no procedures are necessary before disconnection.

NOTE



- When connected to a computer, power can be supplied by USB. When connected to an iPad, power cannot be supplied by USB.
- An iPad Camera Connection Kit (sold separately) is necessary to connect an iPad.
- If you want to use phantom power when connected to a computer that can only supply a low amount of USB bus power, select "PC/MAC using battery power".

■ Using as a web camera (computer)

NOTE

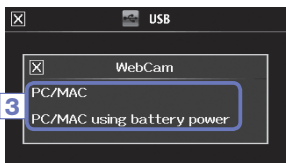
To use as a web camera, an audio driver must be downloaded from the ZOOM website (www.zoom.co.jp) and installed.





1. Connect the **Q8** to a computer using a USB cable, and touch  on the menu screen. This opens the USB menu.
2. Touch  (WebCam).
3. In the sub menu, touch "PC/MAC" or "PC/MAC using battery power".
4. On the confirmation screen, touch "WebCam".
5. Use the **Q8** as a web camera for computer streaming and other applications.
6. To end use, touch "EXIT" on the menu screen, and disconnect the USB cable.

NOTE

- The recorder can simultaneously transmit up to HD720p video and 48kHz/16-bit PCM audio to a computer.
- The **Q8** cannot output computer playback signals.

Delay setting

When using the recorder as a web camera if the streaming application does not have a lip synchronization function, you can set an audio delay time so that it matches the timing of the video.



1. Touch **Delay** on the screen.
2. In the sub menu, use   to adjust the audio delay time.

LCD Rotation and FILE list

■ LCD ROTATION

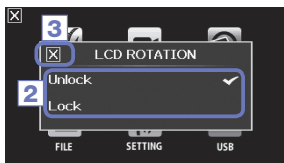
You can lock the rotation of the LCD screen.



1. On the menu screen, touch  .
2. In the sub menu, touch the setting value.
3. Touch  to return to the menu screen.

This will close the submenu.

Setting	Explanation
Unlock	The screen rotates to match the LCD orientation.
Lock	The screen keeps the current state.

■ FILE list

On this screen, you can view video files saved on the SD card as thumbnails and play them back.



1. On the menu screen, touch  .
This opens the FILE list screen.
Touch ◀ ▶ to change the screen.

2. Touch a thumbnail.
3. In the sub menu, touch the setting value.
Touch "Play Back" to start playback.
Touch "Information" to view file information.
Touch "Delete" to delete the file.

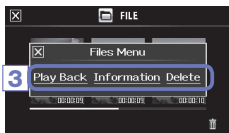



4. Touch  to return to the menu screen.

System settings

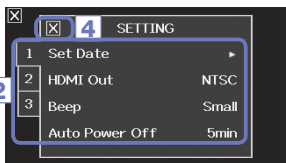
Make settings related to the **Q8** system.



1. On the menu screen, touch .
2. In the sub menu, touch the item that you want to set.
Touch **1** **2** **3** to show hidden items.
3. In the sub menu, touch the setting value.
4. Touch  to return to the menu screen.

This will close the submenu.

Setting	Explanation
Set Date	Set the date and time of the internal clock. (See "Setting the date and time" on page 13.)
HDMI Out	Set the format of the video output from the HDMI port to NTSC or PAL.
Beep	Set whether a beep sound is made when the recorder is turned on and is operated. Select Off, Small or Large.
Direct Monitor	Set whether the input sound is monitored directly when used as a USB mic.
Auto Power Off	Set whether the power turns off automatically when running on batteries if no recording or other operation has occurred for some time. Select Off or 2, 5 or 10 minutes.
Play Mode	Set whether or not multiple files should be played consecutively. Select "Play One" or "Play All".
Playback Lv Meter	Set whether or not level meters are shown on the playback screen.
SD Card	Check the open capacity of the SD card or format it. (See "Formatting SD cards" on page 14.)
Reset	Restore video and audio quality, the scene and other settings to the factory default values.
Information	View the Q8 system version.

Updating the firmware

Update the firmware version when necessary.



NOTE

You can check the firmware version with the Information item in the SETTING menu.



1. Copy the file for updating the firmware to the root directory on the SD card.

The latest version of the firmware can be downloaded from www.zoom.co.jp.

2. Insert the SD card into the unit's card slot.
3. While pressing and holding , press  until the unit starts and the firmware update screen opens.
4. If the version update shown is as desired, touch "Yes".
5. When updating the version completes and "Complete!" appears, press  for at least one second to shut down.

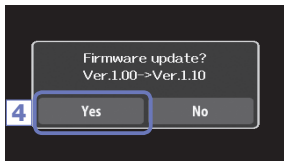

CAUTION

Upgrading the firmware version is not possible if the remaining battery power is low.

Troubleshooting

If you think that the **Q8** is operating strangely, check the following items first.

Recording/playback trouble

- ◆ There is no sound or output is very quiet
 - Check the connections to your monitoring system and its volume setting.
 - Confirm that the volume of the **Q8** is not too low.
- ◆ The recorded sound cannot be heard or is very quiet
 - If you are using the included XY mic, confirm that it is oriented correctly.
 - Check the input level settings. (→ P.21)
 - Check the level settings on the Mixer Screen. (→ P.33)
 - If a CD player or other device is connected to an input jack, raise the output level of that device.
 - Confirm that the PAD setting on the Mixer Screen is set suitably. (→ P.36)
- ◆ Recording video/audio is not possible
 - Confirm that the SD card has open space. (→ P.44)

USB connection trouble

- ◆ When the USB port is connected to a computer, an error message related to power supply appears
 - An error might appear if the power that the computer USB port can supply is exceeded. If this occurs, do the following. Before connecting them by USB, restart the computer and set the **Q8** USB menu to "PC/MAC using battery power". You could also use an AC adapter.

Specifications

Recording media	SD/SDHC/SDXC cards (up to 128 GB)
Image sensor	1/3-inch 3-megapixel CMOS sensor
Lens	Fixed focus (36 cm – ∞), F2.0, focal distance about 16.6 mm (35 mm equivalent)
Video format	MPEG-4 AVC/H.264 (MOV)
Video resolutions	3M HD (2304×1296) 30fps, HD1080p 30fps, HD720p 60fps, HD720p 30fps, WVGA 60fps, WVGA 30fps
Audio formats	WAV (16/24-bit quantization, 44.1/48/96kHz sampling frequency) AAC (64–320kbps bit rate, 48kHz sampling frequency)
Audio functions	Low-cut filter (80Hz, 120Hz, 160Hz), dynamics control (Limiter, Compressor, Leveler)
Image functions	5-step digital zoom, scene selection (Auto/Concert Lighting/Night) Self timer (Off/3sec/5sec/10sec)
Display	2.7" wide full color LCD, Touch screen
L/R inputs	XY mic: XYQ-B 120° XY stereo format Maximum sound pressure input: 140 dBspl Input gain: –∞ to 52 dB Equivalent input noise: –120 dBu or less
INPUT 1/2	Input connectors: TRS/XLR combo jacks Input gain (PAD OFF): –∞ to 55 dB Input gain (PAD ON): –∞ to 35 dB Input impedance: 1.8 kΩ or more Maximum permissible input level: +22 dBu (PAD ON) Phantom power: +12/+24/+48V Equivalent input noise: –120 dBu or less
Output connector	Combined line/headphones stereo mini jack HDMI micro Type D
Built-in speaker	400mW 8Ω mono speaker
USB	Mini B type <Operation as mass storage> Class: USB2.0 High Speed <Operation as audio interface> Class: USB2.0 Full Speed Specifications: 44.1kHz sampling rate, 16-bit <Operation as webcam> Specifications: WVGA/720p video size, 48kHz 16-bit audio Note: Audio interface and mass storage operation with iPad is supported. Note: USB bus power supported
Power supply	Lithium-ion battery: DC 4.2V maximum voltage, DC 3.7V nominal voltage, 1700mAh capacity AC adapter (ZOOM AD-17, sold separately): DC 5V/1A
Recharging times	By USB: about 4 hours and 30 minutes, Using ZOOM AD-17: about 2 hours and 45 minutes
Battery operation time	Rated: about 3.5 hours (when recording 720p/30fps video with LCD closed) Actually use: about 2 hours (when recording 720p/30fps video with LCD opened and condenser mic connected to combo jack)
External dimensions	Main unit (maximum dimensions when arm lowered) 157.57 (length) × 47.8 (width) × 68.65 (height) mm Main unit (maximum dimensions when arm raised) 156.63 (length) × 47.8 (width) × 118.54 (height) mm 300 g (including battery) Mic (maximum dimensions): 50.17 (length) × 37 (width) × 52.3 (height) mm 40g

Safety Precautions

In this User Guide, symbols are used to highlight warnings and cautions that you must read to prevent accidents. The meanings of these symbols are as follows.



Something that could cause serious injury or death



Something that could cause injury or damage to the equipment

Other symbols used



An action that is mandatory



An action that is prohibited

WARNING

■ Operation using an AC adapter

- ❗ Never use any AC adapter other than a ZOOM AD-17 (sold separately).
- ⊘ Do not do anything that could exceed the ratings of outlets and other electrical wiring equipment or supply power other than AC100V. Before using the equipment in a foreign

country or other region where the electrical voltage differs from AC100V, always consult with a shop that carries ZOOM products and use the appropriate AC adapter.

■ Alterations

- ⊘ Do not open the case or modify the product.

CAUTION

■ Product handling

- ❗ Do not drop, bump or apply excessive force to the unit.
- ❗ Be careful not to allow foreign objects or liquids enter the unit.

- ⊘ Do not use in very high humidity or where it could be splashed by water.

- ⊘ Do not use in places with frequent vibrations.

■ Operating environment

- ⊘ Do not use in extremely high or low temperatures.
- ⊘ Do not use near heaters, stoves and other heat sources.

■ AC adapter handling

- ❗ When disconnecting the power plug, always pull on the power plug itself.
- ❗ When not using the unit for a long time, disconnect the power plug from the outlet.

You might need this User Guide in the future. Always keep it in a place where you can access it easily.

Usage Precautions

■ Interference with other electrical equipment

In consideration of safety, the **QBE** has been designed to minimize its emission of electromagnetic waves and to suppress interference from external electromagnetic waves. However, equipment that is very susceptible to interference or that emits powerful electromagnetic waves could result in interference if placed nearby. If this occurs, place the **QBE** and the other device farther apart.

With any type of electronic device that uses digital control, including the **QBE**, electromagnetic interference could cause malfunction, corrupt or destroy data and result in other unexpected trouble. Always use caution.

■ Cleaning

Use a soft cloth to clean the exterior of the unit if it becomes dirty. If necessary, use a damp cloth that has been wrung out well to wipe it.

Never use abrasive cleansers, wax or solvents such as alcohol, benzene or paint thinner.

■ Breakdown and malfunction

If the unit becomes broken or malfunctions, immediately disconnect the AC adapter, turn the power off and disconnect other cables. Contact the store where you bought the unit or ZOOM service with the following information: product model, serial number and specific symptoms of breakdown or malfunction, along with your name, address and telephone number.

■ Copyrights



Windows is a trademark of Microsoft Corporation (USA). Apple, Macintosh, iPad, QuickTime and the QuickTime logo are registered trademarks or trademarks of Apple Inc. in the USA and other countries. The SD, SDHC and SDXC logos are trademarks. HDMI (High-Definition Multimedia Interface) and **HDMI** are trademarks of HDMI Licensing, LLC. Other product names, registered trademarks and company names in this document are the property of their respective companies.

Recording from copyrighted sources, including CDs, records, tapes, live performances, video works and broadcasts, without permission of the copyright holder for any purpose other than personal use is prohibited by law. Zoom Corporation will not assume any responsibility related to infringements of copyrights.

Warnings and requests regarding safe battery use

Carefully read the following warnings in order to avoid serious injuries, burns, fires and other problems caused by leaking, heat generation, combustion, rupture or accidental swallowing.

DANGER

- ⊘ Do not charge the lithium-ion battery (BT-03) in any way other than using the **Q8** and either an AD-17 (sold separately) or a USB port.
- ⊘ Do not disassemble the battery, put it in fire, or heat it in a microwave oven or conventional oven.
- ⊘ Do not leave the battery near a fire, in strong sunlight, inside a vehicle that has become hot or in similar conditions. Do not recharge in conditions like these.
- ⊘ Do not carry or store the battery with coins, hairpins or other metal objects.
- ⊘ Do not allow the battery to be wet by any liquid, including water, seawater, milk, soft drinks and soapy water. Do not charge or use a battery that is wet.

CAUTION

- ⊘ Do not hit the battery with a hammer or other object. Do not step on it or drop it. Do not otherwise impact or apply force to the battery.
- ⊘ Do not use the battery if it becomes deformed or damaged.
- ⊘ Do not remove or damage the outer seal. Never use a battery that has had all or part of its outer seal removed or a battery that has been torn.

Please recycle batteries to help conserve resources. When discarding used batteries, always cover their terminals and follow all laws and regulations that are applicable to the location.

FCC regulation warning (for U.S.A.)

This equipment has been tested and found to comply with the limits for a Class B digital device, pursuant to part 15 of the FCC Rules. These limits are designed to provide reasonable protection against harmful interference in a residential installation. This equipment generates, uses and can radiate radio frequency energy and, if not installed and used in accordance with the instructions, may cause harmful interference to radio communications. However, there is no guarantee that interference will not occur in a particular installation. If this equipment does cause harmful interference to radio or television reception, which can be determined by turning the equipment off and on, the user is encouraged to try to correct the interference by one or more of the following measures:

- Reorient or relocate the receiving antenna.
- Increase the separation between the equipment and receiver.
- Connect the equipment into an outlet on a circuit different from that to which the receiver is connected.
- Consult the dealer or an experienced radio/ TV technician for help.

For EU Countries



Declaration of Conformity:
This product complies with the requirements of
EMC Directive 2004/108/EC and
RoHS Directive 2011 / 65 / EU



Disposal of Old Electrical & Electronic Equipment (Applicable in European countries with separate collection systems)

Products and batteries that have been marked with the symbol of a crossed-out wheeled waste bin must not be disposed of with household waste.



Old electrical/electronic equipment and batteries should be recycled at facilities that are able to process them and their byproducts. Contact the local government for information about nearby recycling facilities. Conducting recycling and waste disposal properly helps conserve resources and prevents harmful impacts on human health and the environment.

THIS PRODUCT IS LICENSED UNDER THE AVC PATENT PORTFOLIO LICENSE FOR THE PERSONAL AND NONCOMMERCIAL USE OF A CONSUMER TO

- (i) ENCODE VIDEO IN COMPLIANCE WITH THE AVC STANDARD ("AVC VIDEO") AND/OR
- (ii) DECODE AVC VIDEO THAT WAS ENCODED BY A CONSUMER ENGAGED IN A PERSONAL AND NONCOMMERCIAL ACTIVITY AND/OR WAS OBTAINED FROM A VIDEO PROVIDER LICENSED TO PROVIDE AVC VIDEO.

NO LICENSE IS GRANTED OR SHALL BE IMPLIED FOR ANY OTHER USE. ADDITIONAL INFORMATION MAY BE OBTAINED FROM MPEG LA, L.L.C. SEE [HTTP://WWW.MPEGLA.COM](http://www.MPEGLA.COM)

ZOOM®

ZOOM CORPORATION

4-4-3 Kanda-Surugadai, Chiyoda-ku, Tokyo 101-0062 Japan

<http://www.zoom.co.jp>

Included items

The package should contain the following items. Please confirm that they have all been included.

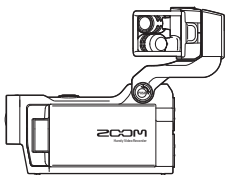

· **QB** main unit



· Lithium-ion battery
(BT-03)



· Lens cover



· Lens hood



· Strap

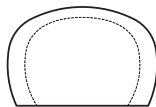

· Foam windscreen



· USB cable

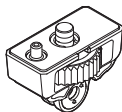

· Accessory mount
adapter



· User Guide