

ELECTRIBE

MX

EMX-1 Music Production Station

Owner's Manual



VALVE  FORCE

MMT

KORG

Precautions

Location

Using the unit in the following locations can result in a malfunction.

- In direct sunlight
- Locations of extreme temperature or humidity
- Excessively dusty or dirty locations
- Locations of excessive vibration
- Close to magnetic fields

Power supply

Please connect the designated AC/AC power supply to an AC outlet of the correct voltage. Do not connect it to an AC outlet of voltage other than that for which your unit is intended.

Interference with other electrical devices

Radios and televisions placed nearby may experience reception interference. Operate this unit at a suitable distance from radios and televisions.

Handling

To avoid breakage, do not apply excessive force to the switches or controls.

Care

If the exterior becomes dirty, wipe it with a clean, dry cloth. Do not use liquid cleaners such as benzene or thinner, or cleaning compounds or flammable polishes.

Keep this manual

After reading this manual, please keep it for later reference.

Keeping foreign matter out of your equipment

Never set any container with liquid in it near this equipment. If liquid gets into the equipment, it could cause a breakdown, fire, or electrical shock. Be careful not to let metal objects get into the equipment. If something does slip into the equipment, unplug the AC/AC power supply from the wall outlet. Then contact your nearest Korg dealer or the store where the equipment was purchased.

THE FCC REGULATION WARNING (for U.S.A.)

This equipment has been tested and found to comply with the limits for a Class B digital device, pursuant to Part 15 of the FCC Rules. These limits are designed to provide reasonable protection against harmful interference in a residential installation. This equipment generates, uses, and can radiate radio frequency energy and, if not installed and used in accordance with the instructions, may cause harmful interference to radio communications. However, there is no guarantee that interference will not occur in a particular installation. If this equipment does cause harmful interference to radio or television reception, which can be determined by turning the equipment off and on, the user is encouraged to try to correct the interference by one or more of the following measures:

- Reorient or relocate the receiving antenna.
- Increase the separation between the equipment and receiver.
- Connect the equipment into an outlet on a circuit different from that to which the receiver is connected.
- Consult the dealer or an experienced radio/TV technician for help.

Unauthorized changes or modification to this system can void the user's authority to operate this equipment.

CE mark for European Harmonized Standards

CE mark which is attached to our company's products of AC mains operated apparatus until December 31, 1996 means it conforms to EMC Directive (89/336/EEC) and CE mark Directive (93/68/EEC). And, CE mark which is attached after January 1, 1997 means it conforms to EMC Directive (89/336/EEC), CE mark Directive (93/68/EEC) and Low Voltage Directive (73/23/EEC).

Also, CE mark which is attached to our company's products of Battery operated apparatus means it conforms to EMC Directive (89/336/EEC) and CE mark Directive (93/68/EEC).

Table of Contents

1. Introduction	7	<i>About the timing of changing patterns</i>	<i>20</i>
Main features	7	Setting the playback tempo	20
<i>Saving your data on the EMX-1</i>	<i>8</i>	<i>Using the dial to set the tempo.</i>	<i>20</i>
<i>About the vacuum tubes</i>	<i>8</i>	<i>To set the tempo more precisely</i>	<i>20</i>
<i>What is VALVE FORCE?</i>	<i>8</i>	<i>Using the TAP key to set the tempo</i>	<i>21</i>
<i>What is MMT? (Multi Modeling Technology)</i>	<i>8</i>	<i>Auto BPM Scanning</i>	<i>21</i>
		<i>Keeping a constant tempo as you change patterns</i>	
		<i>(TEMPO LOCK)</i>	<i>21</i>
2. Parts and their functions	9	Playing the sound of a part	22
Top panel	9	<i>What is a Part?</i>	<i>22</i>
Common section	10	— <i>Drum parts (1-5, 6A-B, 7A-B)</i>	<i>22</i>
Edit section	11	— <i>Synth parts (1-5)</i>	<i>22</i>
Part select section	12	— <i>Accent parts (drum, synth)</i>	<i>22</i>
Step key section	12	Listening to the sound of a part	22
Arpeggiator section	13	<i>Listening to the sound of a drum part</i>	<i>22</i>
Rear panel	14	<i>Listening to the sound of a synth part (the Keyboard</i>	
Front panel	14	<i>function)</i>	<i>22</i>
Card section	14	Selecting a part	23
Items and functions in the display ..	15	<i>Drum part</i>	<i>23</i>
	 <i>To select a part during playback without causing it to</i>	
		<i>sound</i>	<i>23</i>
		<i>Synth part</i>	<i>23</i>
		<i>Accent part</i>	<i>23</i>
		Muting a part	23
		Soloing a part	23
		Adding accents to a part	24
		<i>Specifying the accent locations and strength</i>	<i>24</i>
		<i>Specifying the parts that will be accented</i>	<i>24</i>
		Transposing a phrase (Transpose)	24
		Making a pattern "swing"	25
		<i>Specifying the amount of swing</i>	<i>25</i>
		<i>Specifying the parts that will swing</i>	<i>25</i>
3. Basic operation	17	Applying a roll to a part	25
Preparations	17	<i>Selecting a part and turning on the roll effect</i>	<i>25</i>
Connections	17	<i>Setting the roll type</i>	<i>25</i>
Turning the power on/off	17	Assigning the output of each part	26
<i>To turn the power on</i>	<i>17</i>	Adding distortion to increase the impact of the	
<i>To turn the power off</i>	<i>17</i>	<i>sound</i>	<i>26</i>
Playing a Demo song	18	Using the arpeggiator	27
<i>To pause playback</i>	<i>18</i>	Performing with the arpeggiator	27
<i>To resume playback</i>	<i>18</i>	<i>To arpeggiate a drum part</i>	<i>27</i>
<i>To stop playback</i>	<i>18</i>	<i>To arpeggiate a synth part</i>	<i>27</i>
Demo Song List	18	<i>Specifying the center note</i>	<i>27</i>
		<i>Changing the scale of the arpeggiator</i>	<i>28</i>
		<i>ARPEGGIO SCALE List</i>	<i>28</i>
4. Pattern mode	19	Editing sounds	29
Playing patterns	19	Editing the sound of a drum part	29
<i>What is a Pattern?</i>	<i>19</i>	<i>Assigning a wave</i>	<i>29</i>
Playing a pattern	19	<i>Editing the Part Common parameters</i>	<i>29</i>
<i>To Start playback</i>	<i>19</i>	<i>Modulation</i>	<i>30</i>
<i>To pause playback</i>	<i>19</i>	Editing the sound of a synth part	31
<i>To resume playback</i>	<i>19</i>	<i>Synth oscillator</i>	<i>31</i>
<i>To stop playback</i>	<i>19</i>	<i>Synth filter</i>	<i>31</i>
Selecting a pattern	20	<i>Part Common parameters</i>	<i>32</i>
<i>To check which patterns playing</i>	<i>20</i>	<i>Modulation</i>	<i>33</i>
<i>To force playback to restart at the beginning of the</i>		Adjusting the tuning of a synth part	33
<i>pattern</i>	<i>20</i>		

Oscillator type list	34
Drum PCM List	39
Synth PCM List	40
Effects	41
Using the effects	41
<i>To apply an effect</i>	41
To edit an effect	41
Effect types	42
1. Stereo	42
2. Mono mix	42
3. Stereo cross	42
Effect parameters	43
Recording a phrase	47
<i>Realtime recording</i>	47
<i>Step recording</i>	47
Recording a phrase during playback (Realtime Recording)	47
<i>To record a drum part</i>	47
<i>To record a synth part</i>	47
<i>To record during playback</i>	48
<i>To erase unwanted triggers during playback (Erase)</i> ..	48
Step recording	48
<i>To record a rhythm for a drum part</i>	48
<i>To record a phrase for a synth part</i>	49
<i>To input a rest or tie</i>	49
<i>To move the target step</i>	49
Editing sequence data	50
Editing a phrase pattern (Note Edit)	50
<i>Selecting the step you want to edit</i>	50
<i>Editing the trigger locations (the location of the notes)</i>	50
<i>Editing the note number (pitch)</i>	51
<i>Editing the gate time</i>	51
Specifying the length and time signature of a pattern	52
<i>To check the length and beat</i>	52
<i>Setting the length</i>	52
<i>Setting the beat</i>	52
<i>Setting the last step</i>	53
Moving data within a pattern	54
<i>To move data</i>	54
<i>To copy data repeatedly</i>	54
<i>To move data randomly</i>	54
Transposing the pitch of a synth phrase part ..	55
<i>Shifting the pitch of note data</i>	55
<i>Randomly shifting the note data of a synth part</i>	55
Copying a part	56
Copying only the sound of a part	56
Erasing the sequence data of a part	56
<i>To erase all of a part's performance data</i>	56
<i>To erase trigger data while recording or playing back</i>	57
Erasing all data from a pattern	57
Comparing the currently-edited pattern with the saved pattern (COMPARE)	57
Motion sequence	58
<i>What is a motion sequence?</i>	58
<i>Effects (FX1, FX2, FX3)</i>	58
<i>Drum parts (1-7B)</i>	58

<i>Synth parts (1-5)</i>	58
<i>Accent parts</i>	58
Recording a motion sequence	58
Playing a motion sequence	59
Checking motion sequence data	59
<i>If a motion sequence is recorded for ... The following key will light</i>	59
Editing motion sequence data	60
<i>Selecting the motion sequence that you want to edit ..</i>	60
<i>Editing motion sequence parameter values</i>	60
Erasing a motion sequence for a part or effect ..	61
Pattern Set	62
<i>What is Pattern Set?</i>	62
Performing with a Pattern Set	62
Using Chain Play with Pattern Set	62
Assigning a pattern to a Pattern Set	63
Saving a pattern	64
<i>If you decide not to save a pattern you create</i>	64
Saving by overwriting an existing pattern	64
<i>To overwrite onto a different pattern</i>	64
Saving a pattern under a different name	64

5. Song mode 65

<i>What is a Song?</i>	65
<i>What is the Position?</i>	65

Playing a song	66
<i>To pause playback</i>	66
<i>To resume playback</i>	66
<i>To stop playback</i>	66
<i>Fast-forwarding or rewinding the playback</i>	66
Selecting a song	66
<i>Switching songs</i>	66
<i>To play back from the beginning of the current position or song</i>	66
<i>To continue playing another a song</i>	66
Setting the playback tempo	66
<i>Using the dial to set the tempo</i>	66
<i>Using the tap tempo key to set the tempo</i>	67
<i>Locking the tempo of a song</i>	67

Creating a song	68
Specifying a pattern for each position	68
<i>To play back the completed song from the beginning</i>	68
Transposing the pitch of a Pattern for a specific Position	68

Editing a song	70
Inserting a pattern	70
Deleting a pattern	70
Erasing data from a song	71
<i>If you erase song data by accident</i>	71
Changing the pattern in a specific position ...	71
Maintaining the part mute settings even when the pattern changes	71
Playing back songs in succession	71

Event recording	72	Synchronizing playback with an external MIDI device	83
Recording song event data	72	To use the EMX-1 as the master, and synchronize an external MIDI device to it	83
To record using Event Recording	72	To use the external MIDI device as the master, and synchronize the EMX-1 to it	83
To erase event data from a song	72		
To check the event data in a song	72	Playing back in sync with other Electribe models	84
Saving a song	73	To make the ES-1 play in synchronization to the tempo of the EMX-1	84
To simply save the song	73	To make the EMX-1 and ES-1 play back the identically-numbered pattern in synchronization	84
To overwrite onto a different song	73	About the MIDI messages used for synchronization	84
To rename and save the song	73	Timing Clock	84
6. Global mode	75	Start	84
Setting the metronome	75	Continue, Stop	84
Matching the tuning with another instrument	75	About synchronization in Song mode	85
Protecting the data in memory	75	Song Select	85
Exchangeing the arpeggiator functions	75	Song Position Pointer	85
Saving your Global mode settings	76	Editing sounds	85
Using SmartMedia™	76	Editing via NRPN	85
About cards	76	About system exclusive messages	85
Handling precautions	76	Universal system exclusive messages	85
Formatting SmartMedia	77	8. Appendix	87
Saving data to SmartMedia (Save All)	77	Troubleshooting	87
Loading all data from SmartMedia into the EMX-1	77	Can't control the EMX-1 via MIDI!	87
Loading a single pattern from SmartMedia (Load Pattern)	78	Sound is distorted!	87
Deleting an EMX-1 file from SmartMedia (Delete File)	78	Error messages	88
7. MIDI mode	79	CardFull	88
About MIDI channels	79	Restoring the factory settings	89
Using the EMX-1 as a sound module	79	Specifications	89
If you connect a multi-track MIDI sequencer to the EMX-1	79	Patrn name list	90
Setting the MIDI channel of each part	79	Knob/Sw - MIDI List	92
MIDI Utility	80	Index	93
Making MIDI filter settings	80		
Assigning the drum note numbers	80		
About note-on/note-off	81		
Assigning a MIDI Control Change Number to a knob	81		
Transmitting sound settings and other data	82		
Transmitting/receiving a data dump	82		
Transmission	82		
Reception	82		
Switching patterns	82		
Setting the pitch bend range	83		
Setting the pitch bend range	83		

1. Introduction

Thank you for purchasing the ELECTRIBE MX (subsequently referred to as the “EMX-1”).

The EMX-1 Music Production Station can be used by anyone - from beginner to professional - to create stunningly original music.

The panel knobs and keys allow you to edit sounds intuitively and easily, and to create rhythms and phrase patterns without the need to use any other equipment. The EMX-1 is the ideal tool for the musician, DJ, sound creator, or desktop-music user who wants an easy way to add originality to their music. It's also an ideal compliment to any of the other models in the ELECTRIBE series.

Main features

The ideal tool for producing dance and many other types of music

The EMX-1 provides nine drum parts and five synth parts. Since song arrangement editing is unified with the sound editing for each part, song production is quick and easy.

“MMT (Multiple Modeling Technology)” tone generator system

The synth engine of the EMX-1 features Korg’s latest technology — MMT (Multiple Modeling Technology). This system builds on the know-how that was developed for the DSP technology used in the Z1, MS2000, and Electribe series to create a wide range of timbral variations with a few simple operations.

The oscillator section provides a total of sixteen different synthesis models that include not only standard analog synthesizer models such as Waveform, Sync, Cross Mod, and Ring Mod; but also new types not previously available, such as a Chord type that can produce a full chord from a single note, a Unison type that lets you detune the pitch of up to six oscillators to create an extremely thick sound, and a Waveshape type that mixes two oscillators and then modulates the result to generate complex waveforms.

The carefully selected parameters of the filter and modulation sections boast a greatly improved range, speed, and sound quality. In addition to four filter types that can dramatically vary the sound generated from the oscillator, the new Drive control can create the distinctive sound of analog dis-

1. Introduction

ortion for sharp and powerful analog synth sounds. For totally far-out sounds, we’ve added BPF+ (Band Pass Filter Plus) with adjustable peaking, plus you can use other parameters in conjunction with modulation from the LFO or EG.

207 drum waves for immediate use in your dance music

The EMX-1 features 207 built-in drum waves that have been pre-processed to sound their best in your music, immediately.

Analog synthesizer-style ease of editing

The front panel provides knobs and switches for important sound parameters, allowing you to edit sounds in realtime while you perform, and letting you create sounds in the same way as on an analog synthesizer.

Three simultaneous stereo effects processors

The EMX-1 provides three stereo effect processors, each featuring 16 cutting-edge effect types. You can use the Chain function to modify the way in which the effects are connected to each other.

192 internal patterns programmed for many genres of dance music

The EMX-1 can hold 256 patterns in memory. Each one lets you store a sound and sequence (of up to 128 steps) for each part. When shipped, 192 of the internal patterns are pre-programmed specifically for dance music and other modern music styles.

64 songs

A sequence of patterns, mute data, and knob movements can be saved as a “song” in each of the 64 song memories.

Intuitive pattern programming

The sixteen step keys on the front panel allow you to enter data into pattern quickly, easily and intuitively. Of course, you can also use realtime recording or step recording.

Motion sequencing

The EMX-1’s Motion Sequence feature lets you record and loop knob movements and switch operations, letting you create time-varying changes in the tone during playback.

Newly-developed VALVE FORCE vacuum tube circuit

The EMX-1 features Korg’s newly-developed VALVE FORCE technology, a completely analog circuit that contains two actual vacuum tubes and can be used as a mastering effect to enhance the overall sound level. It delivers a rich, warm, and clearly-defined sound that cannot be replicated by digital technology alone. Use the TUBE GAIN knob

1

2

3

4

5

6

7

8

to adjust the level of the EMX-1's output signal being sent through the vacuum tubes, controlling the smooth distortion and rich overtone structure that vacuum tubes add to the sound. Even at lower volume levels, you can adjust the TUBE GAIN to enjoy great tube-quality sound in any situation.

Process external audio sources

You can connect an audio source to the audio in jack, and process that sound using the internal filter and on-board effects.

Two-channel individual output jacks

In addition to the L/MONO and R main stereo audio outputs, you can route any combination of parts to the two independent audio outputs.

Auto BPM detection

The EMX-1 can automatically detect the tempo of an audio source connected to the audio in jack, and apply that tempo to the current pattern. Of course, you can also use tap tempo to input the tempo, or synchronize to an external MIDI clock.

SmartMedia™ slot

Patterns and songs you create on the EMX-1 can be saved on SmartMedia™.

Arpeggiator

Use the ribbon controller and slider for intuitive and hands-on control of automatically generated arpeggios.

Display

The large back-lit LCD keeps you informed of the operating status and provides other information.

Pattern writing on-the fly

If you unexpectedly come up with a cool pattern or riff while playing patterns, you can write and save the pattern without stopping your performance.

Saving your data on the EMX-1

The patterns and songs you edit and create on the EMX-1 will be lost (the patterns and songs will return to their un-edited state) if you select a new pattern or song, or turn off the power before saving your changes.

If you want to save a pattern or song that you created or edited, or changes you made to global data, you must perform the Write operation.

You can always restore all songs and patterns to the factory settings if desired (see p.89 "Restoring the factory settings").

About the vacuum tubes

Do not attempt to remove, replace or change the tubes in the EMX-1. The tubes are not a user serviceable part.

What is VALVE FORCE?

VALVE FORCE is KORG's proprietary vacuum tube audio technology. The VALVE FORCE system provides the smooth distortion and rich overtone structure that is uniquely characteristic of analog tube circuitry. By providing the tube circuit with its own gain control, the VALVE FORCE system delivers excellent tonal quality in any situation.

What is MMT? (Multi Modeling Technology)

KORG's new cutting-edge MMT (Multi Modeling Technology) engine is based on the vast knowledge acquired from years of DSP development — development that created the Prophecy, Z1, MS2000, OASYS PCI and Electribe series. This technology provides amazingly advanced sound possibilities while maintaining the simple operation that has been the hallmark of the Electribe series.

2. Parts and their functions

Top panel

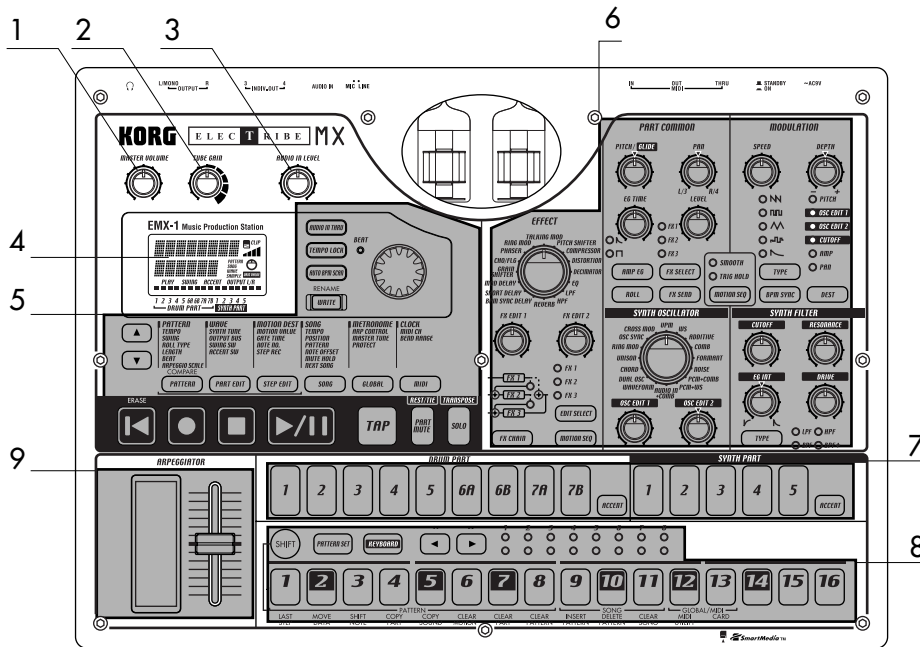

1. MASTER VOLUME

This knob adjusts the output volume of the line out jacks and the headphone jack. The master volume does not adjust the volume of the individual out jacks.

2. TUBE GAIN

This knob adjusts the level of the EMX-1's output signal that is being sent through the vacuum tubes. As you increase this level, the vacuum tubes will produce more distortion. Normally you will leave this set to the minimum level.

 The effect of the vacuum tubes applies to the line out jacks (L/MONO, R) and headphone jacks.

3. AUDIO IN LEVEL

This knob adjusts the input level of the audio input.

4. Display (↪ p.15)

This shows the name of the currently selected pattern, and displays information such as parameter values and messages.

5. Common section (↪ p.10)

The controls grouped in the Common section allow you to switch modes, to use the display to edit parameters, and to control playback and recording.

6. Edit section (↪ p.11)

Using these controls, you can edit the sound of each part and edit the effect settings.

7. Part select section (↪ p.12)

Here you can select each of the drum and synth parts.

8. Step key section (↪ p.12)

Here you can view and edit the triggers of the rhythm or phrase pattern. You can also use the step keys as a keyboard to play the sounds of the synth parts.

9. Arpeggiator section (↪ p.13)

This section lets you sound each part automatically.

1

2

3

4

5

6

7

8

Common section

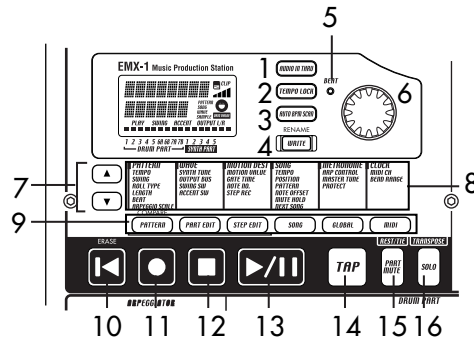

1. AUDIO IN THRU key

Selecting this key will send the sound from the audio in jack directly to the line output jacks and headphone jacks unchanged.

 This key will have no effect for a synth part whose oscillator type is set to “AUDIO IN + COMB,” since turning this key on would simply “thru” the audio input signal unaffected.

2. TEMPO LOCK key

If this key is on, the tempo will stay at its current value, even when you switch patterns.

3. AUTO BPM SCAN key

If this key is on, the tempo will be detected from the music connected to the audio in jack.

4. WRITE/RENAME key

This key allows you to save the changes you make in each mode, and to save any pattern set data you edit.

By holding down the SHIFT key and pressing this key, you can rename a pattern or song.

5. BEAT LED

This LED blinks at quarter-note intervals of the current tempo.

6. Dial

Use this dial to edit the value shown in the display.

7. ▲/▼ (cursor keys)

Use these keys to select a parameter from the matrix menu. The currently selected parameter will be shown in the display.

8. Matrix menu

The matrix menu lists the parameters that are available in each mode. Use the cursor keys to select a parameter.

9. Mode keys

Use these keys to select either the PATTERN mode, PART EDIT mode, STEP EDIT mode, SONG mode, GLOBAL mode, or MIDI mode.

10. RESET, ERASE key

Pressing this key will immediately reset the current pattern or song back to the beginning. During playback, you can hold down the shift key and press this key to erase data from the current part.

11. REC key

Use this key to record rhythms, phrases, or knob movements. During playback or recording, you can use this key to toggle recording on and off.

12. STOP/CANCEL key

Use this key to stop playback of a song or pattern, or to cancel execution of an operation.

13. PLAY/PAUSE key

Use this key to begin, pause or resume the playback of a pattern or song.

14. TAP key

You can set the tempo by pressing this key at quarter-note intervals of the desired tempo.

15. PART MUTE, REST/TIE key

During playback, hold down this key and press a part key to mute that part. When you mute a part, this key will turn on (lit), and the muted part key will go dark. During step recording, use this key to input a rest or tie.

16. SOLO, TRANSPOSE key

During playback, hold down this key and press a part key to “solo” that part (i.e., you will hear only that part). When you solo a part, this key will turn on (lit). If you want to solo more than one part, hold down the solo key and select each part that you want to solo. Press this key once again to turn it off (dark) and defeat the solo function. Also, you can hold down this key and turn the dial or use the step keys to transpose a phrase. (See p.24 “Transpose”)

Edit section

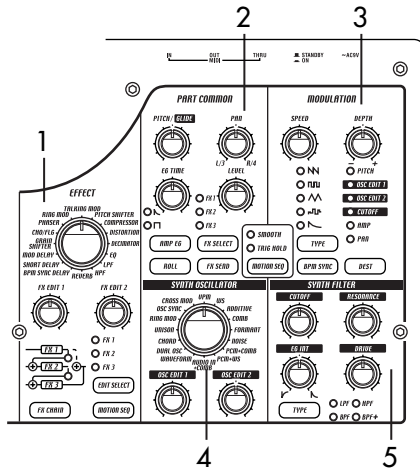

1. EFFECT

In this section you can select the type of effect and adjust various parameters. supports motion sequence.

TYPE (effect type): Selects the type of effect.

FX EDIT1 (effect edit 1) : Adjusts the effect. The actual parameter being controlled will depend on the effect type.

FX EDIT2 (effect edit 2) : Adjusts the effect. The actual parameter being controlled will depend on the effect type.

FX CHAIN (effect chain): On the EMX-1, the output of one effects processor can be fed to the input of another. The connection will change each time you press this, and the connection that is lit will be used.

EDIT SELECT: Chooses which effects processor is currently being edited.

MOTION SEQ. (motion sequence): Records and plays back movements of the FX EDIT1 and FX EDIT2 knobs. This will alternate between on (lit) and off (dark) each time it is pressed.

2. PART COMMON

These are the parameters that are common to the drum parts and to the synth parts. supports motion sequence.

MOTION SEQ. (motion sequence): Turning this function on will allow you to record and playback knob movements for each part. This key will change successively between on (SMOOTH lit), on (TRIG HOLD lit), and off (dark) each time it is pressed.

PITCH/GLIDE : For a drum part, this knob sets the pitch. For a synth part, it specifies the time it takes for the pitch to change smoothly between two legato notes.

EG TIME : Adjusts the envelope time (the time it takes for the note to decay) for each part.

2. Parts and their functions

PAN (panpot) : This controls the position of the part in the stereo field for the line outputs (L/MONO, R) or headphones. If a part is set to the individual (3/4) output bus (p.26: Output bus) this control will adjust the panning to the individual outputs (INDIV. OUT 3, 4).

LEVEL : Adjusts the volume of each part. For an accent part, this will adjust the strength of the accent.

AMPEG : Selects the amp envelope shape for each part. The envelope will alternate between (decay) or (non-decay) each time you press this.

ROLL : For each part, this will switch the roll effect on (lit) or off (dark).

FX SELECT (effect select) : Selects which effect processor will be applied to each part. If FX SEND is on, the selected effect will be applied. This setting is ignored for parts whose output bus (p.26: Output bus) setting is 3/4.

FX SEND (effect send) : Selects whether the sound of the current part will be sent to the selected effect. This will alternate between on (lit) and off (dark) each time it is pressed. This setting is ignored for parts whose output bus (p.26: Output bus) setting is 3/4.

3. MODULATION

These are the parameters such as LFO and EG that create time-varying changes in the sound. supports motion sequence.

SPEED : Adjusts the modulation speed.

DEPTH : Adjusts the modulation depth.

TYPE (modulation type) : Selects the type of modulation.

DEST (destination) : Selects which parameter will be affected by the modulation.

BPM SYNC : Turning this on (lit) will cause the modulation to be in sync with the current tempo.

4. SYNTH OSCILLATOR

This section produces the waveform that is the basis of the synth part. supports motion sequence.

TYPE (oscillator type): Selects the synthesis model being used by the oscillator.

OSC EDIT1 (oscillator edit 1) : Modifies the oscillator waveform. The actual parameter being adjusted will depend on the oscillator model.

OSC EDIT2 (oscillator edit 2) : Modifies the oscillator waveform. The actual parameter being adjusted will depend on the oscillator model.

These parameters have no effect on drum parts.

1

2

3

4

5

6

7

8

5. SYNTH FILTER

These parameters modify the tonal character of the synth part. : supports motion sequence.

CUTOFF : Adjusts the cutoff frequency of the filter.

EG INT (EG intensity) : Adjusts the depth of the filter envelope.

RESONANCE : Adjusts the resonance of the filter.

DRIVE : Adjusts the amount of distortion being introduced by overdriving the filter.

TYPE (filter type) : Selects the type of filter.



These parameters have no effect on drum parts.

Part select section

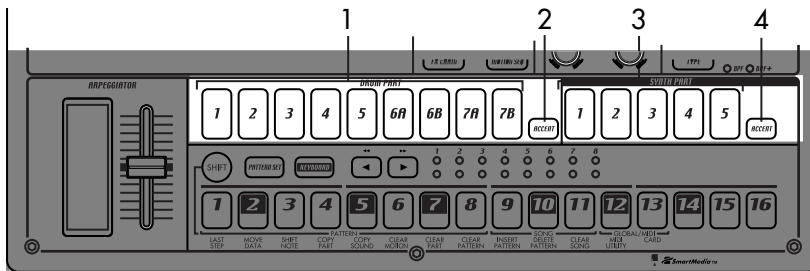

1. (DRUM PART) 1...5, 6A-6B, 7A-7B (drum part keys)

These keys select drum parts. By pressing these keys you can hear the sound that is assigned to each part.

2. (DRUM PART) ACCENT (drum accent part key)

This key selects the drum accent part.

3. (SYNTH PART) 1...5 (synth part keys)

These keys select synth parts.

4. (SYNTH PART) ACCENT (synth accent part key)

This key selects the synth accent part.

Step key section

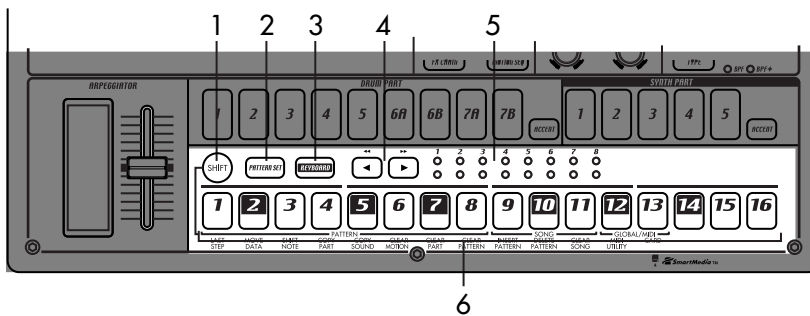

1. SHIFT key

This key is used in conjunction with other keys. Hold down this key and press another key to access the secondary function of that key.

SHIFT+RESET key: Erase data from a pattern.

SHIFT+step key: Execute the function printed below the step key.

SHIFT+dial: Make larger or finer changes in the value. (This will depend on the selected part.)

SHIFT+PATTERN key: Compare patterns.

For details on using the shift key with other keys, refer to the explanation of each parameter.

2. PATTERN SET key

By holding down this key and pressing the STEP key, you can switch to the pattern that was registered for that step key (p.60: Pattern Set).

3. KEYBOARD key

When this key is on (lit), you can use the sixteen step keys as a keyboard to play a synth part (p.22: Keyboard function). This key will alternate on/off each time it is pressed.

4. [◀][▶] (select keys)

These keys are used to control the current position in the lower row (red) of select LEDs. These LEDs indicate different information - pattern set group, keyboard octave, step key position - in conjunction with other keys. (p.13: Select LEDs)

In Song mode, you can use these keys as fast-forward / rewind keys.

5. Select LEDs

The upper row of LEDs (green) indicates the location within the currently-playing pattern (length 1 through 8).

The lower row of LEDs (red) indicates the position shown by the step keys (length 1 through 8). When the Keyboard function is on, these LEDs indicate the octave position.

When the Pattern Set function is on, these LEDs indicate the pattern set group registered to the step keys.

6. Step keys 1...16

These keys can be used to enter data into a pattern, and will light to show the position or timing where each part will sound.

When the KEYBOARD key is on (lit), you can use these keys as a keyboard to play a synth part.

When the Pattern Set function is on (blinking), you can use these keys to select patterns, as well as assigning patterns to the individual keys.

Arpeggiator section

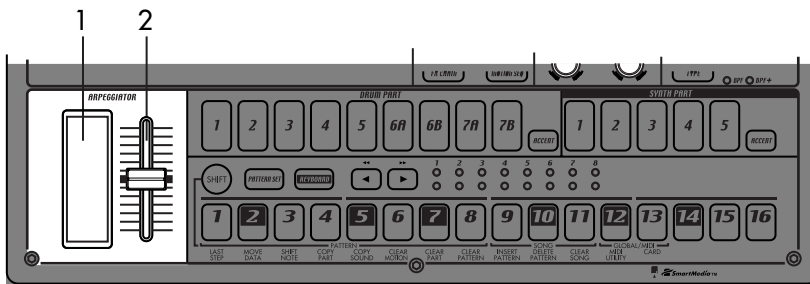

1. Ribbon controller

When you touch the ribbon controller, the selected part will begin sounding automatically. When used with a synth part, 16th notes will be sounded, and the gate time will change depending on where you touch the ribbon controller. When a drum part is selected, the note resolution will depend on where you touch the ribbon controller.

2. Slider

Moving this slider will change the pitches played by the arpeggiator. If a drum part is selected, the slider will have no effect.

 The GLOBAL mode "ARP CONTROL" setting lets you exchange the functions of the ribbon controller and the slider. (p.75)

1

2

3

4

5

6

7

8

Rear panel

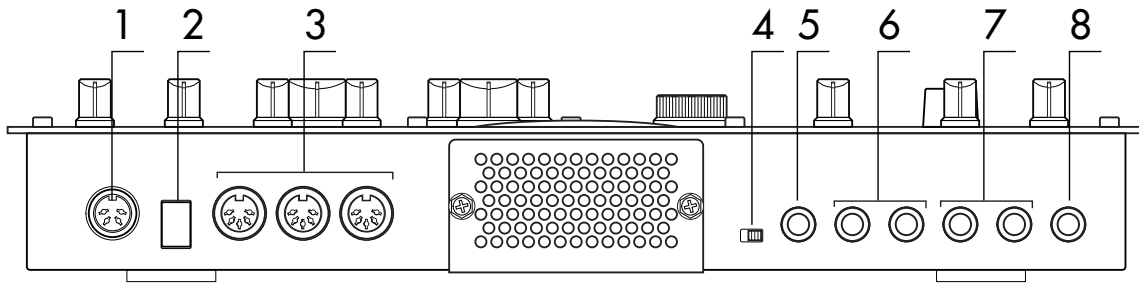

1. ~AC 9V

Connect the included AC/AC power supply to this connector.

2. STANDBY, ON (power switch)

Pressing this switch will alternate between power-on and standby conditions.

3. MIDI connectors

IN This connector receives MIDI data. Use this when you want to control the EMX-1 from an external MIDI device, or to receive a data dump.

OUT This connector transmits MIDI data. Use this when you want to use the EMX-1 to control another MIDI device, or to transmit a data dump.

THRU This connector re-transmits MIDI data that was received at the MIDI IN connector. Use this when you want to send the same data to two or more MIDI devices.

4. MIC, LINE gain select switch

This switches the gain level of the audio in jack. Set this to the MIC position if you are connecting a mic, or to the LINE position if you are connecting a synthesizer or audio device.

5. AUDIO IN jack

This jack lets you use an external audio source as an oscillator. When the synth oscillator is set to AUDIO IN+COMB, the sound that is input here will be used as the oscillator sound. This is a monaural jack.

6. INDIV.OUT 3, 4 (individual out) jacks

These are individual output jacks. If the output bus of a part is set to 3/4, the sound of that part will be output from these jacks.

 For all of the factory-set sounds, the output bus is set to the line out jacks (L/R).

7. OUTPUT L/MONO, R (line out) jacks

Connect audio cables from these jacks to your mixer or powered monitor (amplified speaker) system. If you are using a monaural connection, use the L/MONO jack.

8. Headphone jack

You can connect a set of stereo headphones (phone plug) to this jack.

Front panel

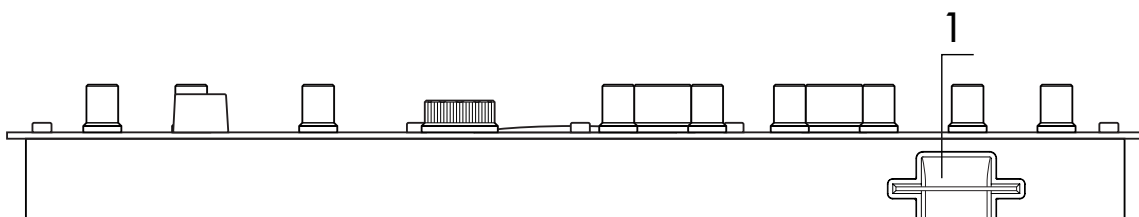



Card section

1. SmartMedia™ slot

You can insert a SmartMedia card here and use it to store or load EMX-1 data.

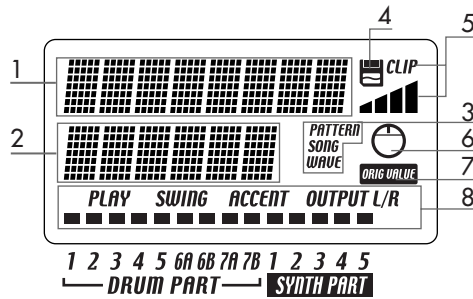
Items and functions in the display



1. **Parameter display**
 This area displays pattern names, song names, and parameter names.
2. **Value display**
 This area displays the selected parameter's value.
3. **PATTERN, SONG, WAVE indicator**
 When the number of a pattern or song is shown in the value display, this will indicate the corresponding mode.
4. **SmartMedia™ indicator**
 This indicator lights when data is being read or written to the SmartMedia™.
 Never remove the SmartMedia™ or turn off the power while this indicator is lit. Doing so may damage the data.
5. **Input level meter**
 This meter shows the level of the signal connected to the audio in jack. If the input level is too high, the "CLIP" indicator will light. Adjust the AUDIO IN LEVEL knob so that the "CLIP" indicator does not light.
6. **Knob indicator**
 When you turn a knob, data for that knob will appear in the parameter display and value display, and this indicator will light. After a time, it will go dark and the previous display will reappear.
7. **Original value indicator**
 This will light when the value of the currently-operated knob is the same as the value stored in the pattern (i.e., the original value).

8. **Part status indicator**
 This shows the status of the following parameters for each part.
PLAY: Indicates the mute status of each part.
 On (lit): This part is not muted.
 Off (dark): This part is muted.
SWING: Indicates which parts have the Swing function enabled. To change or view this setting, use SWING SW in Part Edit mode.
 On (lit): Swing is enabled for this part.
 Off (dark): Swing is disabled for this part.
ACCENT: Indicates which parts will be accented. To change or view this setting, use ACCENT SW in Part Edit mode.
 On (lit): Accent is enabled for this part.
 Off (dark): Accent is disabled for this part.
OUTPUT L/R: Indicates the output jack assignment for each part. To change or view this setting, use OUTPUT BUS in Part Edit mode.
 On (lit): This part is being sent to the line out jacks (L/MONO, R).
 Off (dark): This part is being sent to the individual out jacks (INDI.OUT 3,4).



3. Basic operation

Preparations

Connections

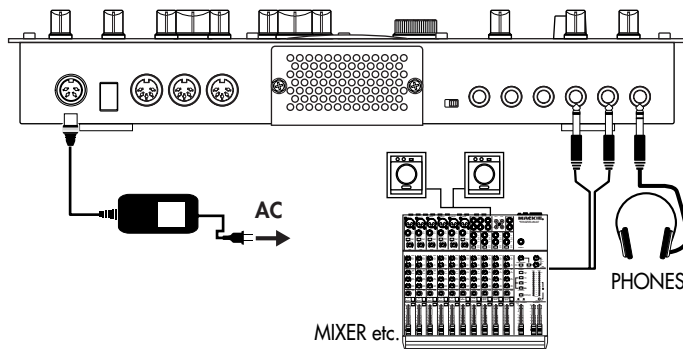

1. Connect the included AC/AC power supply to the EMX-1's ~AC 9V connector, and plug the AC/AC power supply to an AC outlet.
 2. Connect audio cables from the EMX-1's line out jacks (L/MONO, R) to your mixer or powered monitor system (amplified speakers). If you are using a monaural connection, use the L/MONO jack.
 3. If you are using headphones, plug them into the headphone jack.
- note** Sound will still be output from the line out jacks even if headphones are plugged in.

Turning the power on/off

To turn the power on

1. Check the connections
2. Turn on the power switch.
3. Slightly turn up the EMX-1's master volume, and touch the drum part keys to produce sound so that you can check that the connections are correct.
4. Adjust the EMX-1's master volume, and the gain and faders of your mixer or powered monitor system to an appropriate listening level.

! After you turn on the power, it will take approximately one minute before the vacuum tubes reach a stable state of operation. During this time, the output sound may be distorted even if the TUBE GAIN knob is turned down.

To turn the power off

1. Turn down the master volume to the minimum position. Also minimize the volume on your connected equipment.
 2. Make sure that the card indicator in the display is not lit.
 3. Set the power switch to the standby position.
- If you will not be using the EMX-1 for an extended period of time, unplug the AC/AC power supply from the AC outlet.

! You must turn off the power before making any connections. Careless operation can damage your speaker system or other equipment, and may cause malfunctions.

! You must first connect the AC/AC power supply to the EMX-1, and then plug it into the AC outlet.

1

2

3

4

5

6

7

8

Playing a Demo song

The EMX-1 contains several demo songs. Here's how you can listen to the demo songs to get an idea of the EMX-1's sound and potential.

1. Press the SONG key. The SONG key will light.
2. The display will show the current song name and number.
If it does not, press the SONG key a second time.
3. Turn the dial to select a song.
4. Press the PLAY/PAUSE key to play back the song (the key will light).
When the song ends, playback will stop automatically (the key will go dark).

To pause playback

Press the PLAY/PAUSE key (the key will blink).

To resume playback

Press the PLAY/PAUSE key once again (the key will light).

To stop playback

Press the STOP/CANCEL key.

Demo Song List

- S.01 Tales of the Epic / KORG
- S.02 Garage / Oliver Munyak
- S.03 Knob Twister / James Bernard
- S.04 Smooth MX / James Sajeve
- S.05 Butterflyz / Chris Petti
- S.06 Jack! / Oliver Munyak

All Patterns and All Songs — © 2003 KORG Inc. All rights reserved.



The factory-set preset data has been created so that the optimal tone is produced when the TUBE GAIN knob is at the "0" position.

4. Pattern mode

Playing patterns

What is a Pattern?

A “pattern” is a short segment of a performance that consists of rhythm patterns created by drum parts (drum sounds) and phrase patterns (melodic lines) created by synth parts.

The EMX-1 lets you create and store 256 patterns. Each pattern consists of 16 parts. In addition to the sound of each part, a pattern contains effect settings and phrases, and can also record knob movements.

Part(=p.22)

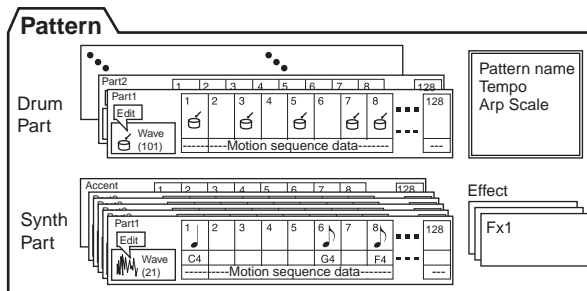

Playing a pattern

To Start playback

1. Press the PATTERN key (the key will light).
 2. Press the [▲] cursor key until the display indicates “(pattern name).”
 3. Press the PLAY/PAUSE key to play the pattern (the key will light).
- When the pattern ends, playback will return to the beginning of the pattern and will continue to loop.

note While the pattern plays, you can use the Keyboard function to play along using the step keys, play drum sounds using the drum part keys, or operate the knobs and keys to modify the sound. By using the various functions of Pattern mode as part of your performance technique, you can create a wide range of expressive variety.

To pause playback

Press the PLAY/PAUSE key (the key will blink).

To resume playback

Press the PLAY/PAUSE key once again (the key will light).

To stop playback

Press the STOP/CANCEL key.

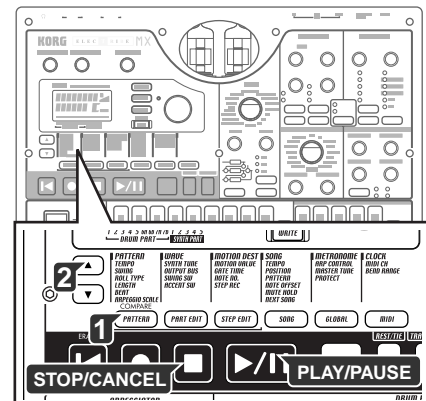

1

2

3

4

5

6

7

8

Selecting a pattern

1. Press the PATTERN key (the key will light).
2. Press the [▲] cursor key until the display indicates "(pattern name)."
3. Turn the dial to select a pattern.

You can use the dial to select from a total of 256 patterns: A.01–A.64, B.01–B.64, C.01–C.64, D.01–D.64.

You can also select patterns while the EMX-1 is playing.

To check which patterns playing

When the PATTERN key is lit, press the PATTERN key and the display will show "(pattern name)."

To force playback to restart at the beginning of the pattern

During playback, you can press the RESET key to force the pattern to play back from the beginning.

note If you want to perform in synchronization with an external audio source, you can use the TAP key to match the tempo, and then press the RESET key at the beginning of each phrase to synchronize your performance without using MIDI.

About the timing of changing patterns

If you change patterns during playback, the currently-playing pattern will finish playing first, and then the newly selected pattern will begin to play. The name of the pattern waiting to be played next will blink in the display until the change occurs.

! If you change patterns during playback, you may hear noise or unwanted sounds at the transition due to the effect or delay settings, or in some cases the effect sound may drop out.

! If the patterns before and after the change use the same effect but with different settings, the result will sound the same as if you had turned those knobs.

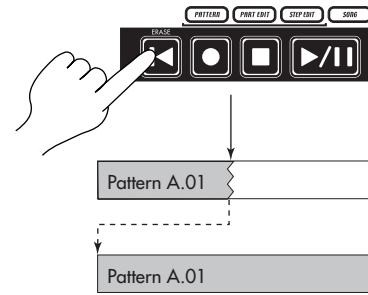

Setting the playback tempo

TEMPO 20.0...300.0

Using the dial to set the tempo.

1. Press the PATTERN key (lit).
2. Use the [▲]/[▼] cursor keys until the display indicates "Tempo."
3. Turn the dial to adjust the tempo.
4. If you want to save this tempo setting, write it into memory. (p.64 Saving a pattern)

! The tempo of the pattern will return to its original setting if you select another pattern without writing the new tempo .

! If the TEMPO LOCK key is off (dark), and you change patterns, the tempo will change to the tempo stored with the new pattern.

To set the tempo more precisely

By holding down the shift key and turning the dial you can adjust the tempo in units below the decimal point (i.e.: 120.4).

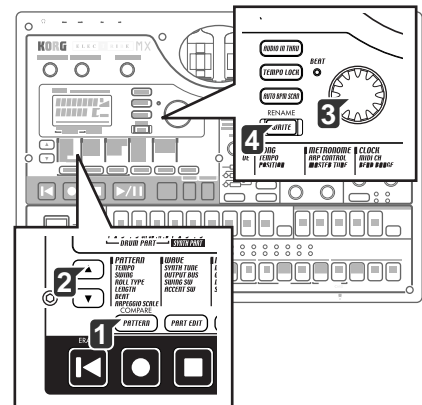
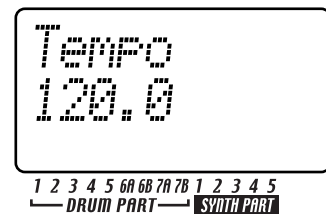

Using the TAP key to set the tempo

While a pattern is playing, press the TAP key twice or more at quarter-note intervals of the desired tempo. The intervals at which you press the key will be detected and the tempo will be set accordingly. You can set the tempo this way even when the EMX-1 is stopped or paused.

Auto BPM Scanning

Detecting the tempo from the input of the AUDIO IN jacks
Here's how you can automatically detect the tempo of an audio signal input to the AUDIO IN jacks, and specify it as the EMX-1's tempo.

1. Press the AUTO BPM SCAN key to begin detection. (The key will light.)

The parameter display will indicate "AutoBPM."

At this time the tempo setting will remain unchanged.

2. When detection is completed, the AUTO BPM SCAN key will blink. The display will show the detected tempo value.

note If automatic detection is unable to determine the tempo, the tempo value display will disappear, and will indicate "—."

3. Press the AUTO BPM SCAN key to finalize the tempo; the detected tempo will be specified as the TEMPO setting.

If you decide not to apply the detected tempo value, press the TAP key or the TEMPO LOCK key. The tempo value will remain at the setting prior to automatic detection. Alternatively, you can cancel the setting by pressing the [▲][▼] cursor keys or a different mode key.

Keeping a constant tempo as you change patterns (TEMPO LOCK)

When the TEMPO LOCK key is on (lit), the current tempo will be used for each pattern you select, regardless of the tempo that was saved in memory with the pattern. With the TEMPO LOCK key off (dark), the tempo saved with each pattern will be used.

note When the TEMPO LOCK key is on, the tempo will be held even if you stop playback. If you want to return to the tempo that is stored in each pattern, turn the TEMPO LOCK key off (dark), and then re-select the pattern.

 The state of the TEMPO LOCK key is not saved as part of the pattern data.



Twice or more

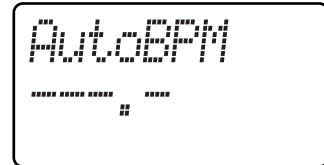

1 2 3 4 5 6A 6B 7A 7B 1 2 3 4 5
— DRUM PART — SYNTH PART

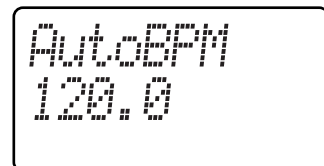

1 2 3 4 5 6A 6B 7A 7B 1 2 3 4 5
— DRUM PART — SYNTH PART

1

2

3

4

5

6

7

8

Playing the sound of a part

What is a Part?

A “part” is the smallest unit within a pattern. Each part contains a sound, a rhythm or phrase pattern, effect on/off settings, and motion sequence data.

For each individual part, you can edit the sound, store a rhythm or phrase pattern, and store motion sequence data (see p.29 “Editing sounds”).

The EMX-1 uses three types of parts, for a total of sixteen parts.

— Drum parts (1–5, 6A-B, 7A-B)

Each of the drum parts contains a drum sound, rhythm pattern (note timing), and motion sequence data.

— Synth parts (1–5)

Each of the synth parts contains a synth sound, phrase pattern (trigger, note number, gate time), and motion sequence data.

— Accent parts (drum, synth)

Accent parts do not contain any sound data. Instead, they can add extra volume to particular beats or steps in a pattern. Each of the accent parts contains an amount of volume emphasis (accents), and motion sequence data.

Drum Part

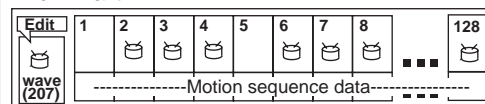

Synth Part

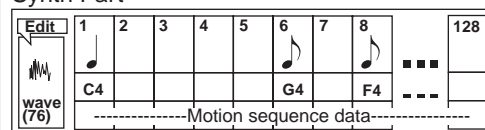

Listening to the sound of a part

You can listen to the sound of each part by pressing the drum part keys, or by selecting a synth part and pressing the step keys with the KEYBOARD key turned on. The sound of the part will differ depending on the pattern. Turn the dial to select various patterns, and try out the wide variety of sounds.

 When you press a drum part key, the keyboard function of the step keys will be cancelled; however, the keyboard function will automatically return to its previous setting when you once again select a synth part.

Listening to the sound of a drum part

Press a drum part key 1 through 7B and you will hear the sound assigned to each key.

 Pressing the drum accent part key will not produce any sound. Drum parts 6A and 6B cannot sound at the same time. The same is true for parts 7A and 7B.

Listening to the sound of a synth part (the Keyboard function)

1. Press one of the synth part keys 1–5 (the key will light).
2. Press the KEYBOARD key (the key will light).
3. Use the step keys as a keyboard to play the part. Use the select keys to change the octave. The select LEDs (lower row, red) will light to indicate the pitch range.

 Pressing the synth part accent key will not produce any sound. You cannot turn the KEYBOARD key on/off unless one of the synth part keys 1–5 is selected.

 Since each synth part is a monophonic synthesizer, it cannot sound two or more notes simultaneously (polyphonically).

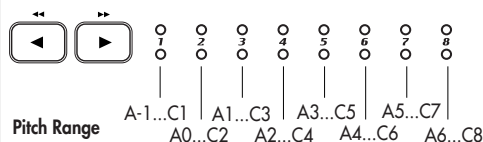

Selecting a part

Use the part keys to select the part that you want to edit.

Drum part

When you press a drum part key, the assigned sound will play and that part will be selected (the part key will light).

The step keys will light to indicate the trigger locations for that part within the rhythm pattern. During playback, the currently-playing step will also light.



When you press a drum part key to make it sound, it will sound at its accented volume.

To select a part during playback without causing it to sound

Hold down the shift key and press a drum part key.

Synth part

When you press a synth part key, the key will light and that part will be selected. With the KEYBOARD key lit, you can play the part using the step keys as a keyboard.

The way in which the step keys will light at this time will depend on the status of the KEYBOARD key.

On (lit): The keys corresponding to each pitch will light successively during playback to indicate the pitch that is sounding at that moment.

Off (dark): The keys will light at the trigger locations of the phrase pattern for that part.

Accent part

When you press an accent part key, the key will light and that part will be selected. At this time, the step keys will light to indicate the accented locations of that accent pattern.

Muting a part

Here's how to mute (temporarily silence) a part.

1. Hold down the PART MUTE key and press the part key that you want to mute. (The PART MUTE key will light.)
2. While you hold down the PART MUTE key, the part status indicator will show the mute status of each part. Unmuted part keys will light, and muted part keys will be dark. You can mute more than one part if desired.
3. To defeat all mute settings, press the SOLO key. To defeat muting for individual parts, press the part key that you want to un-mute.

Soloing a part

1. Hold down the SOLO key and press the part key that you want to solo. You will hear only that part. (The SOLO key and part key will light.)
2. While the SOLO key is lit, you can press another part key to solo that part.
3. If you want to solo two or more parts, hold down the SOLO key and select the parts that you want to solo. Alternatively, hold down the SOLO key (or PART MUTE key) while the SOLO key is already lit and press a part key to add it to the soloed parts.
4. When you press and then release the SOLO key, the Solo function and Mute function will be defeated (the key will go dark).



By holding down the SHIFT key and pressing one of the part keys, you can turn all keys of that part (drum or synth) on/off.

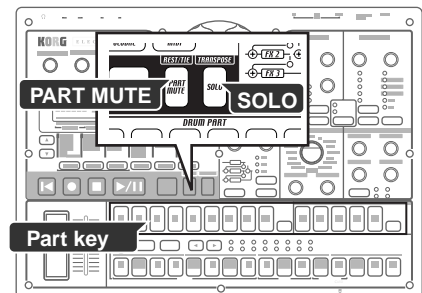

1

2

3

4

5

6

7

8

Adding accents to a part

Specifying the accent locations and strength

You can apply an accent (volume emphasis) independently to the drum parts and to the synth parts.

If accent is on, notes at the accented location (step) will be emphasized.

1. Press either the drum part ACCENT key or the synth part ACCENT key; the step keys will indicate the accented locations.
2. Each time you press a step key, the accent will be turned on/off for that location, letting you specify the accent pattern.
3. Use the level knob in the Part Common section to adjust the amount of accent. Turning the knob toward the right will produce a greater difference between the accented and un-accented sounds. If you turn the knob all the way to the left, there will be no difference between the accented and un-accented sounds.

 Pressing the accent part key will not produce any sound. Also, when you press a part key to play its sound, the sound will play at the accented level.

By playing back the pattern while you make this adjustment you can hear the results.

 Accent settings will not affect a part whose ACCENT SW is turned off.

Specifying the parts that will be accented

ACCENT SW On, Off

You can enable/disable the accent function separately for each part.

1. Press the PART EDIT key (it will light).
2. Use the [▲]/[▼] cursor keys until the parameter display shows "Accent Sw." The "■" symbols at the bottom of the screen will show the accent status (enabled/disabled) of each part. Press a part key, and turn the dial to switch the accent function on (lit) or off (dark) for that part.

 When you execute Pattern Clear, the accent switch will be turned on for all parts.

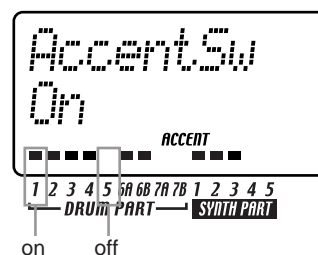
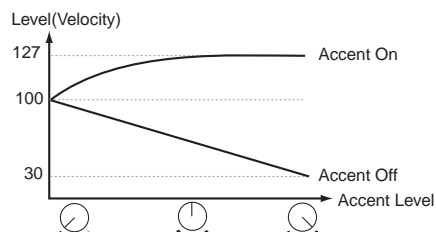

Transposing a phrase (Transpose)

TRANPOSE -24...24

Use this function to transpose the pitch of synth parts 1-5.

1. While you hold down the TRANPOSE key, the display will indicate the current transpose setting.
2. Hold down the TRANPOSE key and turn the dial to transpose the phrases in semitone steps. A setting of ± 1 transposes the pitch by one semitone, ± 2 by a whole step, ± 7 by a fifth, and ± 12 by one octave. If transposition is being used, the TRANPOSE key will blink. When you set the value to "0" the key will go dark.

You can also hold down the TRANPOSE key and use the step keys and select keys to specify the transpose amount.

If you hold down the TRANPOSE key and press a step key to transpose, step key 4 will correspond to the normal pitch of "C."

 If you transpose while soloing a part, the key will remain lit (not blinking). It will blink when you defeat the Solo setting.

 The transpose setting is not remembered. It is reset to 0 when you turn on the power.

 If a wave of the PCM Chord Set category (p.40) is selected for the synth part, the chord or octave may change if you edit the transpose setting.

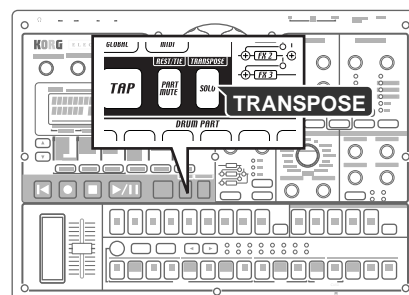

Making a pattern “swing”

Specifying the amount of swing

SWING 50...75

The Swing setting modifies the timing at which certain steps are played. You can use this to transform a straight 16-beat rhythm by giving it a slight shuffle character. You can adjust the amount of swing in a range of 50 to 75 (%), and this will affect the timing of the even-numbered steps. A setting of 50 will produce a straight 16-beat rhythm, and a setting of 66 will produce a shuffle.

The Part Edit mode SWING SW setting lets you enable/disable the Swing setting independently for each part.

1. Press the PATTERN key (it will light).
2. Use the [▲]/[▼] cursor keys to call up “Swing” in the parameter display.
Turn the dial to adjust the amount of swing.

 The swing setting is ignored if the beat is set to “8T ri” (♩₃x12) or “16Tri” (♩₃x12).

Specifying the parts that will swing

SWING SW On, Off

This lets you enable/disable Swing independently for each part.

1. Press the PART EDIT key (lit).
2. Use the [▲]/[▼] cursor keys to select “SwingSw” in the parameter display.
3. The “■” symbols at the bottom of the screen will show the swing status (enabled/disabled) of each part. Press a part key, and turn the dial to switch Swing on (lit) or off (dark) for that part.

 When you execute Pattern Clear, SWING SW will be turned on for all parts.

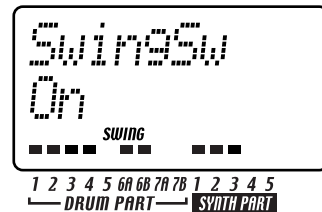

Applying a roll to a part

Selecting a part and turning on the roll effect

ROLL

This switches the Roll (rapid successive strikes) effect on (lit) or off (dark) independently for each part.

The interval between notes of the roll will depend on the tempo of the pattern, the roll type, and the amount of swing (☞“Setting the roll type”).

1. Press the part key for the part you want to play a roll.
2. Press the ROLL key (it will light). During playback, that part will play a roll.

If the playback is stopped, and you press and hold a part key when the ROLL key is on, that part will roll as long as you continue holding down the key.

Setting the roll type

ROLL TYPE 2, 3, 4

This setting specifies the number of times the sound will be played during one step by one trigger when ROLL is on. If Roll is switched on for a part, the part will sound the specified number of notes in each step.

1. Press the PATTERN key (it will light).
2. Use the [▲]/[▼] cursor keys to select “RollType” in the parameter display.

1

2

3

4

5

6

7

8

3. Turn the dial to set the roll type.
 You cannot apply a roll to note-on data from an external MIDI device.

Assigning the output of each part

OUTPUT BUS L/R, 3/4

For each part, you can route the sound to the line out jacks (L/MONO, R) or to the individual out jacks (3, 4).

1. Press the PART EDIT key (it will light).
2. Use the [▲]/[▼] cursor keys to select "OutBus" in the parameter display. The "■" symbols at the bottom of the screen indicate the output destination of each part.
3. Press the part key for the part that you want to set, and turn the dial to select either L/R (lit) or 3/4 (dark).



-  When you execute the Clear Pattern operation, OUTPUT BUS will be set to "L/R" for all parts.

Adding distortion to increase the impact of the sound

TUBE GAIN

This adjusts the level at which the output signal from the line out jacks will be passed through the vacuum tubes. Even if you turn down the master control, you can use the TUBE GAIN knob to adjust the amount of distortion.

This strengthens the distortion produced by the vacuum tube.

-  Raising the TUBE GAIN knob excessively may damage your external speaker system. Please use caution.
-  This has no effect on the sound that is sent from the individual out jacks (3, 4).

Using the arpeggiator

Performing with the arpeggiator

To arpeggiate a drum part

1. Select the drum part that you want to play.
2. When you touch the ribbon controller, the selected part will begin playing automatically. The timing of the repeated notes will vary depending on the location you touch. The speed of the repetition will depend on the specified tempo.

note If ARP CONTROL (☞p.75) is set to “Revers,” the slider will vary the timing of the notes.

To arpeggiate a synth part

1. Select the synth part that you want to play.
2. Use the step keys to specify the pitches that you want to arpeggiate. For example if you want to arpeggiate C–E–G, hold down the C key and press the E and G keys.
3. When you touch the ribbon controller, the sound of the selected part will play automatically. The gate time will change depending on where the ribbon is touched. The speed will depend on the tempo. The notes played by the arpeggiator will be retriggered each time you (release and then) touch the ribbon controller. If you hold down the SHIFT key, the arpeggiator will not retrigger when you release and then touch the ribbon controller.
4. Operate the slider to change the pitch within the scale specified by “ARPEGGIO SCALE.”

note If you want, you can exchange the functions of the ribbon controller and the slider. (☞p.75 “Exchanging the arpeggiator functions”)

Specifying the center note

When using the arpeggiator with a synth part, you can specify the note that will correspond to the center of the slider (i.e., the “center note”). This setting is also saved when you save the pattern.

1. Press the Pattern mode key.
2. Select one of the synth parts, and turn on the keyboard function.
3. Use the [◀|▶] select keys to specify the pitch range, and press the step key that you want to be the center note (press only one key).
4. Save the pattern.

 The position of the slider when you make this setting has no effect on the setting.

 If ARP CONTROL (☞p.75) is set to “Revers,” the center note will be the note produced by touching the center of the ribbon controller.

1

2

3

4

5

6

7

8

Changing the scale of the arpeggiator

ARPEGGIO SCALE Chroma...Octave

You can change the scale that is being used when you arpeggiate a synth part.

1. Press the PATTERN key (it will light).
2. Press the [▼] cursor key to select "ArpScale" in the parameter display.
3. Turn the dial to select the desired scale.

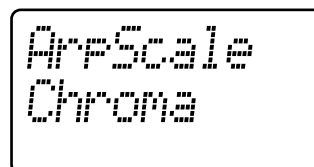

ARPEGGIO SCALE List

No. Display	Scale [Key C]	Scale Name
1. Chroma	C, Db, D, Eb, E, F, Gb, G, Ab, A, Bb, B, C	Chromatic
2. Ionian	C, D, E, F, G, A, B, C	Ionian
3. Dorian	C, D, Eb, F, G, A, Bb, C	Dorian
4. Phrygi	C, Db, Eb, F, G, Ab, Bb, C	Phrygian
5. Lydian	C, D, E, F#, G, A, B, C	Lydian
6. MixLyd	C, D, E, F, G, A, Bb, C	Mixolydian
7. Aeolia	C, D, Eb, F, G, Ab, Bb, C	Aeolian
8. Locria	C, Db, Eb, F, Gb, Ab, Bb, C	Locrian
9. MBlues	C, Eb, E, G, A, Bb, C	Major Blues
10. mBlues	C, Eb, F, Gb, G, Bb, C	minor Blues
11. Dim	C, D, Eb, F, F#, G#, A, B, C	Diminish
12. ComDim	C, Db, Eb, E, F#, G, A, Bb, C	Combination Diminish
13. MPenta	C, D, E, G, A, C	Major Pentatonic
14. mPenta	C, Eb, F, G, Bb, C	minor Pentatonic
15. Raga1	C, Db, E, F, G, Ab, B, C	Raga Bhairav
16. Raga2	C, Db, E, F#, G, A, B, C	Raga Gamanasrama
17. Raga3	C, Db, Eb, F#, G, Ab, B, C	Raga Todi
18. Spansh	C, Db, Eb, E, F, G, Ab, Bb, C	Spanish Scale
19. Gypsy	C, D, Eb, F#, G, Ab, B, C	Gypsy Scale
20. Arabia	C, D, E, F, Gb, Ab, Bb, C	Arabian Scale
21. Egypt	C, D, F, G, Bb, C	Egyptian Scale
22. Hawaii	C, D, Eb, G, A, C	Hawaiian Scale
23. Pelog	C, Db, Eb, G, Ab, C	Bali Island Pelog
24. Japan	C, Db, F, G, Ab, C	Japanese Miyakobushi
25. Ryukyu	C, E, F, G, B, C	Ryukyu Scale
26. Whole	C, D, E, Gb, Ab, Bb, C	Wholetone
28. m3rd	C, Eb, Gb, A, C	m3rd Interval
27. M3rd	C, E, Ab, C	M3rd Interval
29. 4th	C, F, Bb, C	4th Interval
30. 5th	C, G, C	5th Interval
31. Octave	C, C	Octave Interval



In the factory-set preset patterns, the center note and "ARPEGGIO SCALE" are set so that the sound of synth part 5 will be played optimally by the arpeggiator .

Editing sounds

For each drum part, you can select a drum sound wave, or sample. For each synth part, you can select a synth oscillator model.

You can then edit the sound of each part using the oscillator, level, and pan knobs, and the effect and amp EG keys.

Sounds can be edited even while the pattern is playing. You can also use an external MIDI device to control the values of each knob (see p.79 "MIDI mode").

If you want to keep the sound that you modified, save it in the current pattern by pressing the WRITE/RENAME key (see p.64 "Saving a pattern").

 The available knobs will differ depending on the part. If you find it difficult to edit the sound because a motion sequence is affecting a knob, you can turn motion sequence off while editing (see p.58 "Motion sequence").

Editing the sound of a drum part

Assigning a wave

WAVE 1...207

You can choose one of 207 waves to assign to a drum part.

1. Press the PART EDIT key (it will light).
2. Press the [▲] cursor key until the display reads "(wave name)". The "WAVE" indicator in the lower right of the display will light.
3. Press the key for the drum part you wish to edit (the key will light). The name of the wave currently assigned to that part will appear in the display.
4. Turn the dial to select a wave, and press the part key to hear the sound of the wave.

Editing the Part Common parameters

PITCH -63...+63

Sets the playback pitch of the wave. Raising the pitch will speed up the playback, and lowering the pitch will slow down the playback. You can adjust the pitch over a range of ±2 octaves. The settings correspond to the pitches shown below.

 Raising the pitch may cause noise.

Knob value	Pitch	Example pitch (for an input of C3)
+63	2 octaves	C5
+41, 43...59, 61	:	C#4, D4...A#4, B4
+39	1 octave	C4
+9, 12...33, 36	:	D3, D#3...A#3, B3
+6	Semitone up	C#3
0(center)	±0	C3
-6	Semitone down	B2
-9, -12...-36	:	A#2, A2...C#2
-39	-1 octave	C2
-41, -43...-61	:	B1, A#1...C#1
-63	-2 octaves	C1

EG TIME 0...127

Sets the decay time of the EG. The way in which the volume decays will depend on the Amp EG setting.

PAN L63...R63

Sets the stereo position (panpot) of the sound. The sound will be located in the center when the knob is set to the center. Turning the knob toward the left moves the sound toward L, and turning it toward the right moves the sound toward R.

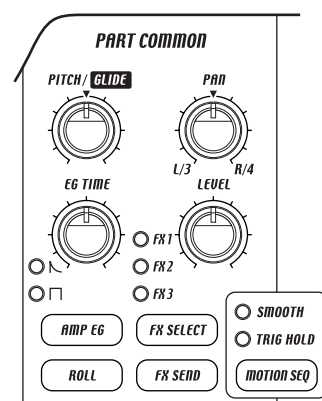
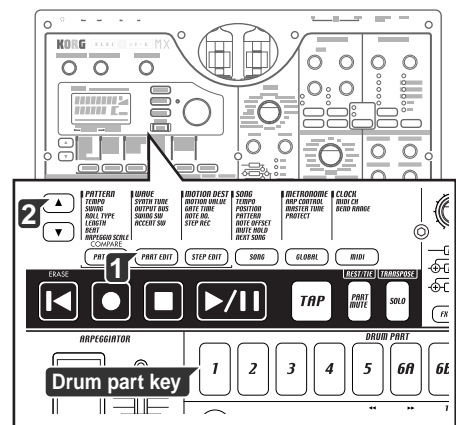

LEVEL 0...127

Sets the output level. Turning the knob toward the right will increase the level.

AMP EG \curvearrowright , \square

Switches the operation of the amp EQ. Each time you press this key, the envelope type will alternate between \curvearrowright (the volume will gradually decay over the time specified by EG TIME) and \square (the sound will stop after the time specified by EG TIME).

ROLL On, Off

This enables (on) or disables (off) the Roll effect for each part. The roll interval is determined by the tempo of the pattern, the Roll Type, and the Swing setting (p.25 "Setting the Roll Type"). If you hold down a part key when Roll is turned on, a roll will play for as long as you hold down the key.

FX SELECT FX1, FX2, FX3

Here you can select which effect processor will be applied to the part. The effect will switch each time you press the key. If the effect send (FX SEND) is on, the selected effect will be applied. This does not apply to parts whose output bus is set to 3/4. (p.26 "Assigning the output of each part")

FX SEND On, Off

This specifies whether the selected effect will be applied. The setting will alternate on (lit) and off (dark) each time you press the key. The FX SELECT setting selects the effects processor. This does not apply to parts whose output bus is set to 3/4.

Modulation

These are the parameters that create time-varying change, such as LFO and EG.

SPEED 0...127

Adjusts the speed of modulation. If BPM SYNC is on, modulation will synchronize to the tempo. The value will correspond to note values of 8/1-1/64.

DEPTH -63...+63

Adjusts the depth of modulation.

TYPE \square , \square , \wedge , \square , \curvearrowright

Selects the type of modulation. With settings other than EG, the modulation will vary cyclically. With the EG setting, the effect will start at maximum and then decay smoothly. If the modulation type is " \wedge ", triggering will not reset the phase of the modulation. For other types, the phase of modulation will be reset at each trigger.

DEST PITCH, AMP, PAN

Selects which parameter will receive the modulation effect.

BPM SYNC On, Off

When you turn this function on, the speed of the modulation effect will be synchronized to the tempo. If this is lit (on), modulation will be synchronized with the tempo.

 Although you can independently edit the sounds of drum parts 6A and 6B, and 7A and 7B, these sounds cannot be played simultaneously.

 If the sound does not change when you turn a knob or switch a key, it may be that the knob or key is not valid for the part you are editing, or that a motion sequence (p.58 "Motion sequence") is operating.

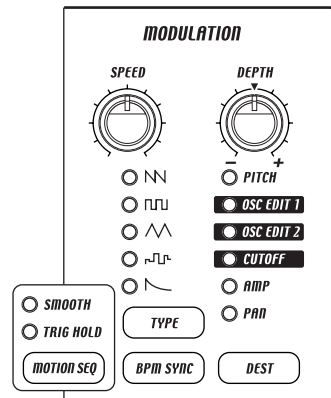

Editing the sound of a synth part

Synth oscillator

SYNTH OSCILLATOR TYPE 1...(76)

Turn the OSCILLATOR TYPE knob to select the synth oscillator type. You can choose from sixteen oscillator algorithms that include typical analog synthesizer waveforms and much, much more. For details on each oscillator type, refer to the Oscillator Type List (p.34).

 Some combinations of oscillator pitch, WAVE, OSC EDIT 1, and OSC EDIT 2 settings may produce noise.

WAVE 1...(76)

This specifies the wave that will be assigned to the synth part. The synth waves you can choose here will depend on the synth oscillator type (SYNTH OSCILLATOR TYPE) you selected.

1. Press the PART EDIT key (it will light).
2. Press the [▲] cursor key until the display shows "(wave name)." (At the same time, the "WAVE" indicator will light in the lower right of the display.)
3. Press the key for the synth part you wish to edit (the key will light). The name of the wave assigned to that key will appear in the display.
4. Turn the KEYBOARD key on, and turn the dial to select a wave while you press the step keys to hear the selected wave. The waves that you can select will depend on the SYNTH OSCILLATOR type.

OSC EDIT1

Adjusts a single pre-selected parameter for each oscillator type.

OSC EDIT2

Adjusts a single pre-selected parameter for each oscillator type.

 Some combinations of oscillator pitch, WAVE, OSC EDIT 1, and OSC EDIT 2 settings may produce noise.

Synth filter

These controls are used to modify the tone and distort the waveform produced by the oscillator.

CUTOFF 0...127

Adjusts the cutoff frequency of the filter. The result will depend on the filter type that is selected.

 For some settings, the sound may be distorted, or nearly inaudible.

EG INT -63...+63

Specifies the depth and direction by which the EG (envelope generator) will vary the cutoff frequency. The EG will start the moment the trigger turns on (or the moment you press the step key). If you set the knob to the center position, it will have no effect.

 If the gate time length of a step extends beyond the timing of the next step, the EG will not be retriggered by the next step.

RESONANCE 0...127

Adds a distinctive character to the sound by boosting the region near the cutoff frequency. By raising the resonance and then moving the cutoff frequency knob or adjusting EG INT or EG TIME, you can create the classic resonant filter sweep sound that is characteristic of analog synthesizers.

 If the resonance is excessively high, the sound may be distorted depending on the cutoff frequency or on the pitch you play.

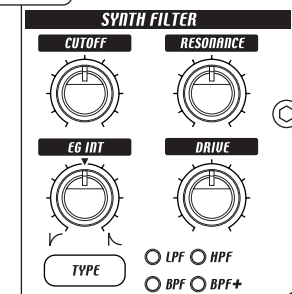
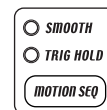
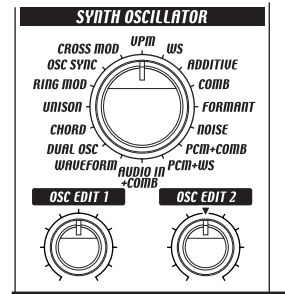

1

2

3

4

5

6

7

8

DRIVE 0...127

This is a new circuit that controls the amount of distortion introduced by the filter. By adjusting this in conjunction with the cutoff frequency and resonance of the synth filter to intentionally create distortion, you can generate overtones that were not present in the original waveform.

TYPE LPF, HPF, BPF, BPF+

Selects the type of filter.

LPF (Low Pass Filter): Cuts the high-frequency region, making the sound more mellow.

HPF (High Pass Filter): Cuts the low-frequency region, making the sound sharper.

BPF (Band Pass Filter): Outputs only the region in the area of the cutoff frequency.

BPF+ (Band Pass Filter Plus): Adds the output of the band pass filter to the original waveform.

Part Common parameters

EG TIME 0...127

Specifies the decay time of the EG.

In order for this setting to have an effect, the AMP EG needs to be set to "L" and the filter EG INT needs to have a value other than 0.

GLIDE 0...127

"Glide" (also called portamento) is a function that smoothly changes the pitch from one legato note to the next without re-triggering the note. Glide will also occur when the gate time of one note extends past the note-on timing of the next note.



As you raise this value, it will take longer to arrive at the new pitch. The pattern tempo determines the time from when the next note is played until that pitch is reached.



The Glide effect is defeated if the ROLL key is on (lit).

PAN L63...R63

LEVEL 0...127

AMP EG L, □

Switches the operation of the amp EG. The setting will change each time you press the key.

L: The sound will decay to silence over the specified "EG TIME."

□: The EG will not cause the volume to decay.

ROLL On, Off

Has the same function as for a drum part (p.30).

If Roll is on, a roll will continue playing as long as you hold down a step key (with the Keyboard function turned on).

FX SELECT FX1, FX2, FX3

FX SEND On, Off



Has the same function as for a drum part (p.30).

If the sound does not change when you turn a knob or switch a key, it may be that the knob or key is not valid for the part you are editing, or that a motion sequence (p.34, "Motion sequence") is operating.

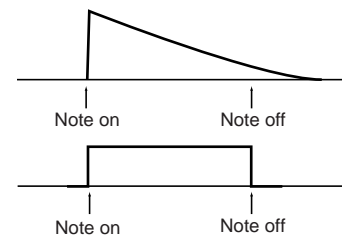
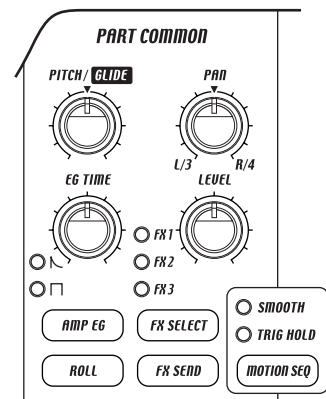

Modulation

These are the parameters that create time-varying change, such as LFO and EG.

SPEED 0...127

DEPTH -63...+63

TYPE

DEST PITCH, AMP, PAN, OSC EDIT 1, OSC EDIT 2, CUTOFF

Has the same function as for a drum part (p.30).

BPM SYNC On, Off

When you turn this function on, the speed of the modulation effect will be synchronized to the tempo. If this is lit (on), modulation will be synchronized with the tempo.

 If the sound does not change when you turn a knob or switch a key, it may be that the knob or key is not valid for the part you are editing, or that a motion sequence (p.58“Motion sequence”) is operating.

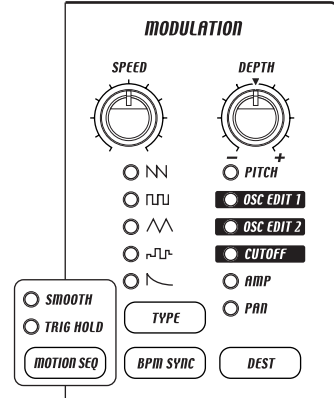

Adjusting the tuning of a synth part

SYNTH TUNE -50...+50

If you want to adjust the pitch of a specific synth part, such as when you are using two or more synth parts as layers, use this parameter to adjust the pitch in units of one cent. Normally you will leave this set at +00 (A=440 Hz).

note If you want to adjust the tuning of the entire EMX-1, use the Global mode parameter Master Tune instead of this.

1. Press the PART EDIT key (it will light).
2. Use the [▲]/[▼] cursor keys to select “SynTune” in the parameter display.
3. Press the key for the synth part whose tuning you want to adjust (the key will light).
4. Turn on the KEYBOARD switch, and press the step keys to hear the sound while you turn the dial to make adjustments.

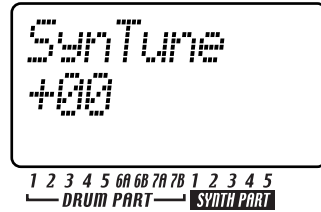

- 1
- 2
- 3
- 4
- 5
- 6
- 7
- 8

Oscillator type list

WAVE FORM (Wave form)

This oscillator type provides two oscillators whose waveform you can modify continuously. OSC EDIT2 adjusts the pitch of oscillator 2 (i.e., the pitch difference relative to oscillator 1), letting you create detuned sounds or octave-doubled sounds.

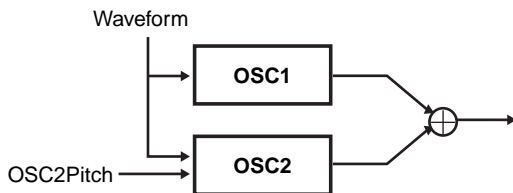

WAVE Saw, Pulse, Tri, Sin

Selects the basic waveform for the wave form oscillator. Oscillator 1 and oscillator 2 will have the same waveform.

Saw: A sawtooth wave is the most widely used waveform on an analog synthesizer. It is suitable for creating a wide range of sounds including synth basses and synth leads. Adjusting the OSC EDIT1 value will modify the waveform as shown in the illustration below. At a setting of 0 the waveform will be a standard sawtooth wave, and at a setting of 127 it will be a square wave.

Pulse: A pulse waveform produces a tone that is often heard in electronic music. OSC EDIT1 adjusts the pulse width. At a setting of 0 the waveform will be a basic square wave, and as you increase the setting the pulse width will decrease, producing a more clavi-like tone. At a setting of 127 the pulse width will be 0, meaning that there will be no sound. By selecting a triangle wave as the modulation type and applying modulation to OSC EDIT 1, you can produce a PWM (Pulse Width Modulation) effect, giving depth to the sound.

Tri: A triangle wave has a stronger fundamental and fewer overtones than a sawtooth wave or pulse wave. It is suitable for mellow bass or arpeggiated sounds. Adjusting the OSC EDIT1 value will modify the waveform as shown in the illustration below. At a setting of 0 the waveform will be a basic triangle wave, and at a setting of 127 it will be a triangle wave of one octave and a fifth higher.

Sin: A sine wave contains only the fundamental with no overtones, producing an extremely mild tone for which it is difficult to hear the effect of subsequent filtering.

Adjusting the OSC EDIT1 value will modify the waveform as shown in the illustration below, changing the overtones that are produced. At a setting of 0 the waveform will be a basic sine wave.

OSC EDIT1: Waveform 0...127

This continuously modifies the shape of the waveform. The waveform shape will change in the same way for oscillator 1 and oscillator 2.

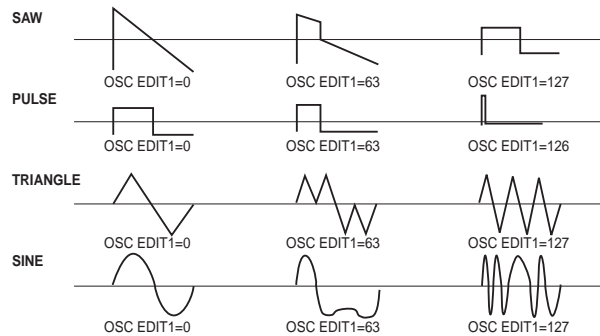

OSC EDIT2: OSC2Pch -63...+63

This adjusts the pitch of oscillator 2. A value of ± 63 creates a pitch difference of ± 2 octaves, and a value of 47 creates a pitch difference of ± 1 octave. For values in the region of 0, only the sound of oscillator 1 will be output.

DUAL OSC (Dual oscillator)

This oscillator type provides two oscillators that output basic waveforms. You can choose the combination of waveforms for the two oscillators.

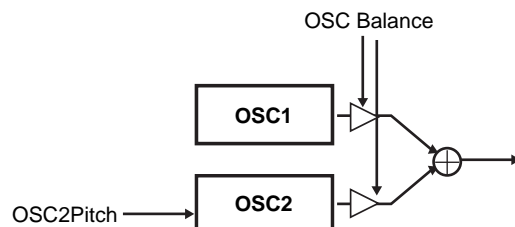

WAVE twenty different combinations of Osc1 (Saw, Squ, Tri, Sin) + Osc2 (Saw, Squ, Tri, Sin, Ns [=Noise])

OSC EDIT1: OSCBlnce 0...127

Adjusts the volume balance of oscillator 1 and oscillator 2. A setting of 0 outputs only oscillator 1, and a setting of 127 outputs only oscillator 2.

OSC EDIT2: OSC2Pch -63...+63

Adjusts the pitch of oscillator 2. A value of ± 63 creates a pitch difference of ± 2 octaves, and a value of 47 creates a pitch difference of ± 1 octave. With a value of 0, the pitch will be the same as the pitch of oscillator 1.

4. Pattern mode

CHORD OSC (Chord oscillator)

This oscillator type provides four oscillators that can output basic waveforms. Using this, you can produce a chord of the form specified by the OSC EDIT1 setting by playing just a single note.

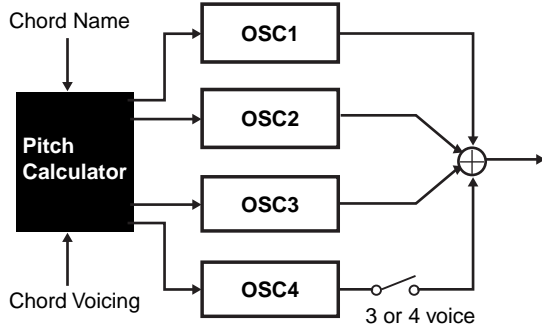

WAVE Saw, Square, Tri, Sin
 Selects the basic waveform used by the wave form oscillators. (The same waveform is used by all four oscillators.)

OSC EDIT1: ChordNam
 Major, 6th, 7th, M7, m7 (♭5), minor, m6, m7, mMaj7, dim, dim7, m7(♭5), aug, aug7, sus4, sus7
 Selects the chord form.

OSC EDIT2: Voicing -3...+3
 Adjusts the voicing of the chord.

UNISON OSC (Unison oscillator)

This oscillator type provides six oscillators that output basic waveforms. Using this, you can produce extremely thick sounds by playing just a single note. OSC EDIT1 adjusts the pitch of one oscillator independently of the other five oscillators.

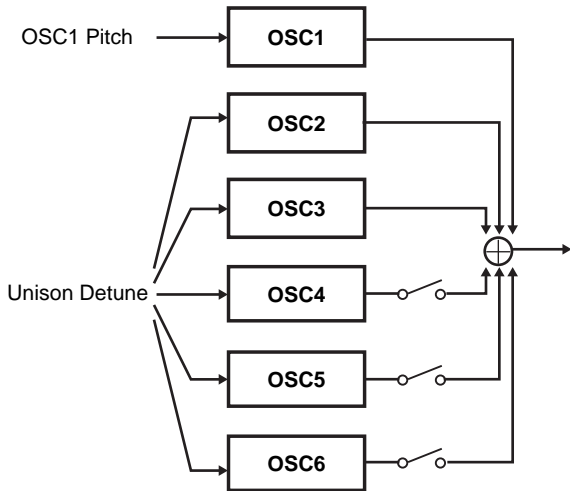

WAVE ... 3Saw-6Saw, 3Squ-6Squ, 3Tri-6Tri, 3Sin-6Sin
 Selects the basic waveform of the unison oscillator (this will be the same for all six oscillators) and the number of oscillators that will sound.

OSC EDIT1: Detune 0...127
 Detunes the pitch of the six oscillators relative to each other. Higher values will produce a greater detuning, making the sound thicker.

Even at a Detune value of 0, the pitch of the oscillators will not be perfectly identical.

OSC EDIT2: OSC1 Pch -63...+63
 Adjusts the pitch of oscillator 1. A value of ±63 creates a pitch difference of ±2 octaves, and a value of 47 creates a pitch difference of ±1 octave. With a value of 0, the pitch will be the same as the other five oscillators.

RING MOD (Ring modulator)

This oscillator type creates new overtones that are the sum and difference of two oscillator waveforms. It can produce shifting metallic resonances. You can choose the combination of waveforms for the two oscillators.

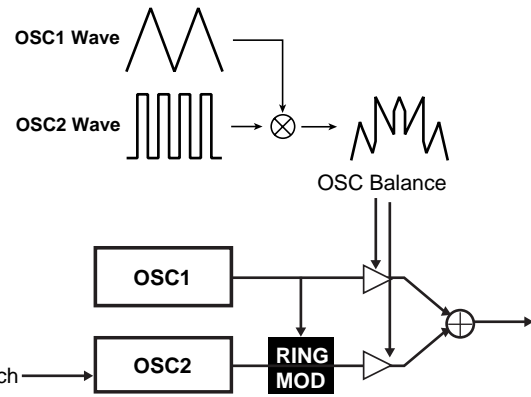

WAVE
 twenty different combinations of oscillator 1 (Saw, Squ, Tri, Sin) + oscillator 2 (Saw, Squ, Tri, Sin, Ns [=Noise])

OSC EDIT1: ModDepth 0...127
 Adjusts the volume balance of oscillator 1 and the ring modulation effect. With a value of 0 only oscillator 1 will be output, and with a value of 127 only the ring modulation sound will be output.

OSC EDIT2: ModPitch -63...+63
 Adjusts the pitch of oscillator 2 (the modulator). A value of ±63 creates a pitch difference of ±2 octaves, and a value of 47 creates a pitch difference of ±1 octave. With a value of 0, the pitch is the same as oscillator 1.

1

2

3

4

5

6

7

8

OSC SYNC (Oscillator sync)

This oscillator type forcibly resets the phase of the oscillator 2 waveform (the “slave”) at the frequency of oscillator 1 (the “master”), producing new overtones.

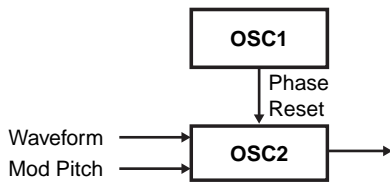
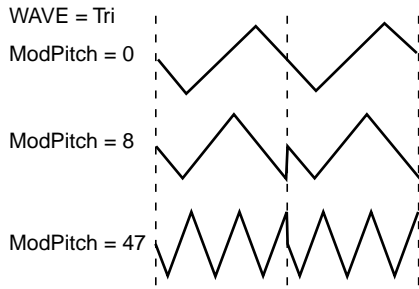

WAVE Saw, Pulse, Tri, Sin
Selects the basic waveform of oscillator 2.

OSC EDIT1: WaveForm 0...127
Continuously modifies the shape of the oscillator 2 waveform. The change in waveform shape is exactly the same as for the Wave Form oscillator type (described earlier).

OSC EDIT2: ModPitch 0...127
Adjusts the pitch of oscillator 2 (the slave waveform). A value of 31 is one octave higher, 63 is two octaves higher, 95 is three octaves higher, and 127 is four octaves higher.

CROSS MOD (Cross modulation)

This oscillator type uses the output waveform of oscillator 2 (the “modulator”) to modulate the frequency of oscillator 1 (the “carrier”), producing complex overtones.

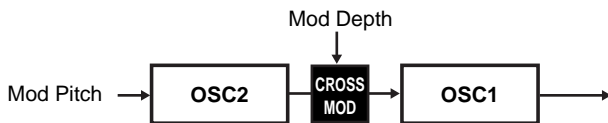

WAVE
twenty different combinations of oscillator 1 (Saw, Squ, Tri, Sin) + oscillator 2 (Saw, Squ, Tri, Sin, Ns [=Noise])

OSC EDIT1: ModDepth 0...127
Adjusts the depth of cross modulation.

OSC EDIT2: ModPitch -63...+63
Adjusts the pitch of oscillator 2 (the modulator). A value of ±63 creates a pitch difference of 2 octaves, and a value of 47 creates a pitch difference of ±1 octave. With a value of 0, the pitch is the same as oscillator 1.

VPM OSC (VPM oscillator)

The VPM (Variable Phase Modulation) oscillator type uses the output waveform of oscillator 2 (the “modulator”) to modulate the phase of oscillator 1 (the “carrier”), producing metallic-sounding overtones.

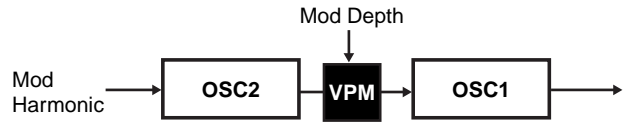

WAVE Saw, Squ, Tri, Sin
Selects the basic waveform of oscillator 1 (the carrier).

OSC EDIT1: ModDepth 0...127
Adjusts the depth of the VPM effect.

OSC Edit2: ModHarm 00.25...32.00
Specifies the pitch of oscillator 2 (the modulator) as a harmonic multiple of oscillator 1.

WS (Wave shaping)

Wave shaping creates complex waveforms by mixing two oscillators and then passing the result through a wave shaper (non-linear transformation).

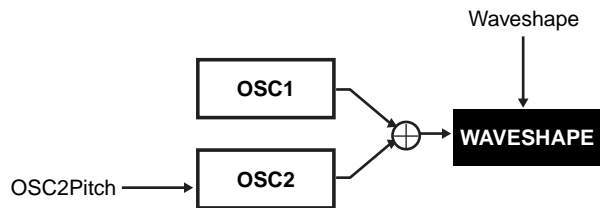

WAVE Type1, Type2
Switches the type of wave shaping effect.

OSC EDIT1: WavShape 0...127
Adjusts the depth of the wave shaping effect.

OSC EDIT2: OSC2Pch -63...+63
Adjusts the pitch of oscillator 2. A value of ±63 creates a pitch difference of ±2 octaves, and a value of 47 creates a pitch difference of ±1 octave. With a value of 0, the pitch is the same as oscillator 1.

ADDITIVE OSC (Additive oscillator)

The additive oscillator creates a waveform by adding three oscillators. This is a good way to make organ or bell sounds.

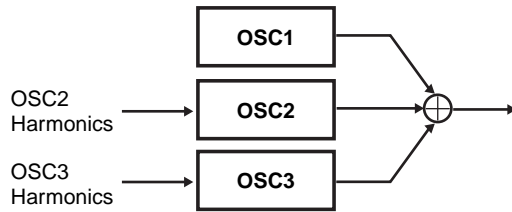

WAVE Saw, Squ, Tri, Sin
Selects the basic waveform.

OSC EDIT1: OSC2Harm 00.25...32.00
Specifies the pitch of oscillator 2 as a harmonic multiple of oscillator 1.

OSC EDIT2: OSC3Harm 00.25...32.00
Specifies the pitch of oscillator 3 as a harmonic multiple of oscillator 1.

COMB OSC (Comb oscillator)

This oscillator type contains an internal comb filter, and modifies a basic waveform by passing it through the comb filter to change the tone. By using the LFO to modulate the frequency (OSC EDIT2) of the comb filter, you can create the same result as a flanger effect.

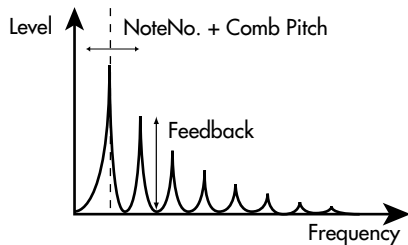

WAVE Saw, Squ, Tri, Sin, Noise
Selects the basic waveform of the oscillator.

OSC EDIT1: Feedback 0... 127
Raises the amount of feedback returned to the comb filter. As the feedback amount increases, the comb filter effect will be applied, boosting the overtones at multiples of the frequency specified by OSC EDIT2.

OSC EDIT2: CombPtch 0... 127
Adjusts the frequency that will be the axis of the comb filter. At a value of 0 this will be the basic pitch; a value of 31 is one octave higher, 63 is two octaves higher, 95 is three octaves higher, and 127 is four octaves higher.

FORMANT OSC (Formant oscillator)

The formant oscillator type can produce a sound reminiscent of a human voice. By moving the formant width (OSC EDIT1) you can change between different vowels.



WAVE (none)

OSC EDIT1: Formant 0... 127
Controls the frequency difference between the two formants. This produces a change similar to varying the shape and size of your mouth when producing "vowel" tones.

OSC EDIT2: Offset -63...+63
Moves the formant frequency components upward or downward in pitch.

NOISE OSC (Noise oscillator)

The noise oscillator contains an internal noise generator and filters, allowing you to create a variety of noise sounds. Since the filters resonate to oscillation, you can also use this to create pitched sounds.

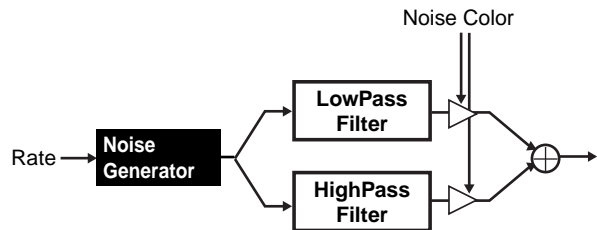

WAVE (none)

OSC EDIT1: Rate 0... 127
Adjusts the character of the source noise (the speed of the random cycle). Raising this value will slow the timing at which noise is generated.

OSC EDIT2: Color -63...+63
Adjusts the mix balance between the LPF (Low Pass Filter) and HPF (High Pass Filter) that are placed after the noise generator. With a value of -63 only the LPF is heard, and with a value of +63 only the HPF is heard.

1

2

3

4

5

6

7

8

PCM OSC+COMB

(PCM oscillator + comb filter)

This oscillator type lets you use one of the 76 PCM (sampled) waveforms as an oscillator. The wide variety of waveforms includes acoustic instruments and chords. The sound is then output through a comb filter.

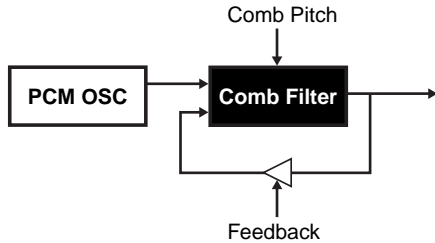

WAVE001...76

Selects the PCM waveform. For the available waveforms, refer to the PCM wave list (p.39).

OSC EDIT1: Feedback0...127

Raises the amount of feedback returned to the comb filter. As the feedback amount increases, the comb filter effect will be applied, boosting the overtones at multiples of the frequency specified by OSC EDIT2.

OSC EDIT2: CombPtch0...127

Adjusts the frequency that will be the axis of the comb filter. At a value of 0 this will be the basic pitch; a value of 31 is one octave higher, 63 is two octaves higher, 95 is three octaves higher, and 127 is four octaves higher.

PCM OSC+WS

(PCM oscillator + wave shape)

This oscillator type applies a wave shaping effect to a PCM waveform.

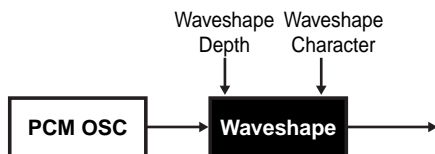

WAVE001...76

Selects the PCM waveform. For the available waveforms, refer to the PCM wave list (p.40).

OSC EDIT1: WavShape0...127

Adjusts the depth of the wave shaping effect.

OSC EDIT2: Charactr0...127

Adjusts the tonal character of the wave shaping effect.



Some synth part waves are themselves sampled chords. Of these, some arrange several chords across the keyboard as a single wave. These are called "chord splits." Synth part waves 66~72 are

chord splits. In some locations, the pitch may be discontinuous at the transition between chords. If you adjust the Transpose (p.24) or song mode Note Offset (p.68) settings, the chord or octave may be different from what you heard while creating the pattern.

AUDIO IN+COMB

(Audio in + comb filter)

This oscillator type uses the audio signal input to the audio input of the EMX-1 as an oscillator, and applies a comb filter to this signal.

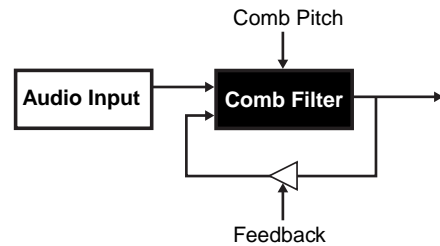

WAVE --- (none)

OSC EDIT1: Feedback0...127

Raises the amount of feedback returned to the comb filter. As the feedback amount increases, the comb filter effect will be applied, boosting the overtones at multiples of the frequency specified by OSC EDIT2.

OSC EDIT2: CombPtch0...127

Adjusts the frequency that will be the axis of the comb filter.

Drum PCM List

No.	Name	Category	No.	Name	Category	No.	Name	Category
1	BD-Dark	Kick	70	SD-Brk1		139	Bng-Slap	
2	BD-99 1							
3	BD-99 2							
4	BD-Syn1							
5	BD-Syn2							
6	BD-Syn3							
7	BD-Syn4							
8	BD-Syn5							
9	BD-Syn6							
10	BD-Syn7							
11	BD-Syn8							
12	BD-Syn9							
13	BD-Syn10							
14	BD-Dist1							
15	BD-Dist2							
16	BD-Dist3							
17	BD-Dist4							
18	BD-Dist5							
19	BD-Dist6							
20	BD-Dist7							
21	BD-Squas							
22	BD-88 1							
23	BD-88 2							
24	BD-Digi							
25	BD-DDD1							
26	BD-DDD2							
27	BD-Lynn							
28	BD-Dry1							
29	BD-Dry2							
30	BD-Dry3							
31	BD-Dry4							
32	BD-Soft							
33	BD-Hip							
34	BD-R&B							
35	BD-Jazz							
36	BD-Break							
37	BD-Ambi							
38	BD-Def							
39	BD-D&B1							
40	BD-D&B2							
41	BigBreak							
42	SD-99 1	Snare	110	HH-Syn3O		170	Guiro-S	
43	SD-99 2							
44	SD-99 3							
45	SD-99 4							
46	SD-99 5							
47	SD-88 1							
48	SD-88 2							
49	SD-88 3							
50	SD-Syn1							
51	SD-Syn2							
52	SD-77							
53	SD-Lynn							
54	SD-Disco							
55	SD-Dry1							
56	SD-Dry2							
57	SD-Dry3							
58	SD-Dry4							
59	SD-Dry5							
60	SD-Dry6							
61	SD-Ambi1							
62	SD-Ambi2							
63	SD-Ambi3							
64	SD-Picl1							
65	SD-Picl2							
66	SD-Picl3							
67	SD-Bras1							
68	SD-Bras2							
69	SD-Crckl							
71	SD-Brk2							
72	SD-Brk3							
73	SD-Brk4							
74	SD-D&B							
75	SD-Clap1							
76	SD-Clap2							
77	SD-R&B1							
78	SD-R&B2							
79	SD-R&B3							
80	SD-R&B4							
81	SD-R&B5							
82	RM-Ambi1	Rim	101	HH-99 3C		151	Timb-Hi1	
83	RM-Ambi2							
84	RM-Dry							
85	RM-DDD							
86	RM-Lynn							
87	RM-88							
88	Clp-99 1	Clap	102	HH-88 C		152	Timb-Lo1	
89	Clp-99 2							
90	Clp-88 1							
91	Clp-88 2							
92	Clp-Nois							
93	Clp-R&B1							
94	Clp-R&B2							
95	HH-99 1C	Hi Hat	103	HH-88 O		153	Timb-Lo2	
96	HH-99 1O							
97	HH-99 2C							
98	HH-99 2H							
99	HH-99 2O							
100	HH-99 3C							
101	HH-99 3O							
102	HH-88 C							
103	HH-88 O							
104	HH-Syn1C							
105	HH-Syn1H							
106	HH-Syn1O							
107	HH-Syn2C							
108	HH-Syn2O							
109	HH-Syn3C							
111	HH-Nrm1C	Ride Cymbal	112	HH-Nrm1O		154	Timb-Rim	
112	HH-Nrm1O							
113	HH-Nrm2C							
114	HH-Nrm2O							
115	HH-CrspC							
116	HH-CrspO							
117	HH-OldC							
118	HH-OldO							
119	HH-LynnC							
120	HH-LynnO							
121	Rid-99 1							
122	Rid-99 2							
123	Rid-KPR							
124	Rid-Edg1	Crash Cymbal	125	Rid-Edg2		155	Claves	
126	Rid-Jazz							
127	Crs-99 1							
128	Crs-99 2							
129	Crs-Norm							
130	Crs-Spls							
131	Tom-99	Tom	131	Tom-99		156	Cowbell	
132	Tom-88							
133	Tom-Simm							
134	Tom-NrmH							
135	Tom-NrmL							
136	Tom-NrmF							
137	Tom-Jazz							
138	Bng-Hi		Percussions	138		Bng-Hi		157
						158	MamboBel	
						159	Agogo	
						160	Triangle	
						161	Tambouri	
						162	Junk1	
						163	Junk2	
						164	SleighBl	
						165	Shaker1	
						166	Shaker2	
						167	Cabasa1	
						168	Cabasa2	
						169	Cabasa3	
						170	Guiro-S	
						171	Guiro-L	
						172	Wbl-DDDH	
						173	Wbl-DDDL	
						174	Whistle	
						175	Baya-Ghe	
						176	Baya-Mt1	
						177	Baya-Mt2	
						178	Tbla-Na	
						179	Tbla-Tin	
						180	Tbla-Mt1	
						181	Tbla-Mt2	
						182	Djmb-1a	
						183	Djmb-1b	
						184	Djmb-1c	
						185	Djmb-2a	
						186	Djmb-2b	
						187	Djmb-2c	
						188	Udu	
						189	Taiko-Op	
						190	Taiko-Rm	
						191	Tsuzumi	
						192	GtrWah	Synth Perc
						193	Zap1	
						194	Zap2	
						195	SynPerc1	
						196	SynPerc2	
						197	SynPerc3	
						198	SynPerc4	
						199	SynPerc5	
						200	SynPerc6	
						201	Rev-BD	Reverse
						202	Rev-SD1	
						203	Rev-SD2	
						204	Rev-Crsh	
						205	Scratch1	Scratch
						206	Scratch2	
						207	Scratch3	

1

2

3

4

5

6

7

8

Synth PCM List

No.	Name	Category
1	Piano	Keyboard
2	E.Piano	
3	Clav	
4	M1-Organ	
5	Organ	
6	Marimba	Mallet
7	Vibe	
8	Cymbell	
9	Flute	
10	AltoSax	Woodwind
11	M1-T.Sax	
12	Trumpet	
13	MuteTp	Brass
14	BrassEns	
15	VoiceAh	
16	M1-Choir	Choir
17	VoiceWav	
18	Violin	String
19	Strings	
20	Pizzicat	
21	F.Guitar	
22	A.Guitar	Guitar
23	MuteGtr	
24	FunkGtr	
25	Sitar	
26	A.Bass	
27	E.Bass	
28	M1-Bass	
29	PickBass	
30	SlapBass	
31	FMBass	Synth Wave
32	88Bass	
33	BoostSaw	
34	SawSqMix	
35	HPFSaw	
36	OctBass1	
37	OctBass2	
38	Saw5th	
39	Squ5th	
40	SynSin1	
41	SynSin2	
42	SynSin3	
43	SynSin4	
44	SynSin5	
45	SynWire1	
46	SynWire2	
47	Digi1	
48	Digi2	
49	Digi3	
50	Digi4	
51	SynVox1	
52	SynVox2	
53	Endless	
54	Syn-FX1	Motion
55	Syn-FX2	
56	OrchHit	Hit
57	BandHit1	
58	BandHit2	
59	DiscoHit	
60	RaveHit1	
61	RaveHit2	
62	RaveHit3	
63	RaveHit4	
64	RaveHit5	
65	RaveHit6	

No.	Name	Category
66	CH-Piano	Chord Set (Maj,min,Maj7,min7)
67	CH-M1Pia	Chord Set (Maj,min,Maj7,min7)
68	CH-EPian	Chord Set (Maj,min,Maj7,min7)
69	CH-Organ	Chord Set (Maj,min,Maj7,min7)
70	CH-Strgs	Chord Set (Maj,min,Maj7,min7)
71	CH-Gtr1	Chord Set (min,sus47,min7)
72	CH-Gtr2	Chord Set (min,min,sus4,Oct)
73	DR-BDs	Drum Set (001-041)
74	DR-SDs	Drum Set (042-094)
75	DR-CymTm	Drum Set (095-137)
76	DR-Percs	Drum Set (138-207)

Effects

Using the effects

The EMX-1 contains three separate effect processors. For each pattern, you can use up to any three of the sixteen effect types. The sound of each part can be sent to any one of the effect processors. You can also change the way in which the three effects are connected to each other, and in this way apply more than one effect to a part.

To apply an effect

1. Either begin playback, or if you are editing a synth part, turn the KEYBOARD key on (lit) so that you can play the sound.
2. Press a drum or synth part key to select the part to which you want to apply an effect.
3. In the edit section / part common area, press the FX SELECT key to select the effect processor that you want to use. Press the FX SEND key (lit) to send the sound of that part to the selected effect processor.
4. In the edit section, press the effect FX CHAIN key to select how the effects will be connected.



You can turn effects on/off individually for each part. However if two or more parts are being sent to the same effect, you cannot change the effect type or effect parameter values individually for each part.

To edit an effect

EDIT SELECT
Press this key to select the effect that you want to edit.

EFFECT TYPE
Use this knob to assign one of the 16 effect types to the currently selected effect processor.

FX EDIT1
Adjusts the character of the effect. The result will depend on the effect type.

FX EDIT2
Adjusts the character of the effect. The result will depend on the effect type.

FX CHAIN
Specifies how the effects are connected. Each time you press this, the connection will change; connections whose indicator is lit will be active.

1. In the edit section, press the effect EDIT SELECT key to select which effect processor you want to edit.
2. In the edit section, use the effect type selector to select the desired effect type.
3. Use the effect knobs and keys to edit the effect. The original value icon will light to indicate that knob positions and key settings are the same as in the unedited effect.

If you want to save the pattern with the effect edits you made here, press the WRITE/RENAME key (⇨p.64 "Saving a pattern").



The function of the knobs will differ depending on the effect type (⇨p.43 "Effect parameters").

1

2

3

4

5

6

7

8

If you have difficulty editing because a motion sequence is affecting a knob, turn off the motion sequence while you edit (⇐p.58 "Motion sequence").

Effect types

The effects of the EMX-1 can be classified into the following three groups.

1. Stereo

This group includes: CHO/FLG, PHASER, RING MOD, COMPRESSOR, DECIMATOR, EQ, LPF, HPF

note For some of these effects you can adjust the level of the direct sound.

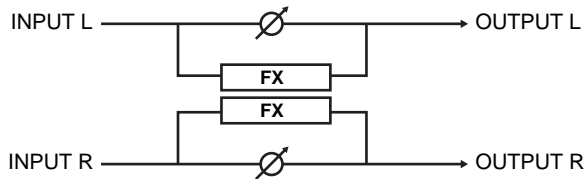

2. Mono mix

This group includes: REVERB, MOD DELAY, GRAIN SHIFTER, TALKING MOD, PITCH SHIFTER, DISTORTION

note For some of these effects you can adjust the level of the direct sound.

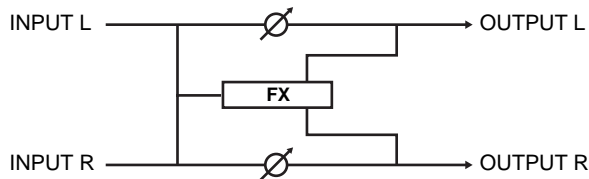

3. Stereo cross

This group includes: BPM SYNC DELAY, SHORT DELAY

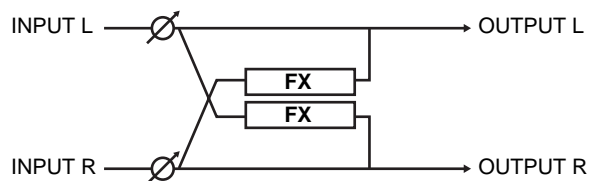

Effect parameters

REVERB (Reverb)

This effect simulates the reverberation and spatial character of a hall.

FX EDIT1: Time 0...127
Turning the knob toward the right will lengthen the reverb time.

FX EDIT2: Level 0...127
Turning the knob toward the right will increase the reverb level.

 With long reverb time settings, some input sounds or level values may cause distortion

BPM SYNC DELAY (BPM sync delay)

This is a cross delay synchronized to the BPM.

FX EDIT1: Time 1/64...1/1
Adjusts the delay time synchronized to the BPM, in note value units.

Turning the knob toward the right lengthens the delay time.

You can set this in a range from a 64th note to a whole note.

FX EDIT2: Depth 0...127

Adjusts the depth of the delay and the amount of feedback. Turning the knob toward the right makes the delayed sound louder and also increases the amount of feedback. Panning each part further left or right creates a deeper sense of spaciousness.

 The feedback sound may disappear if you turn the TIME knob or change the BPM while producing sound.

 Depending on the tempo setting, some long delay times may not be available. In this case, the delay time will be halved, and may be halved again if necessary.

 Depending on the tempo setting, some short delay times may not be available. In this case, the delay time will be doubled, and may be doubled again if necessary.

 If you lower the time value too far, the sound may distort (clip).

SHORT DELAY (Short delay)

This is a cross delay with a short delay time. It is not synchronized with the BPM.

FX EDIT1: Time 0...127
Sets the delay time.

Turning the knob toward the right lengthens the delay time. Shortening the delay time can produce a doubling effect, giving the impression that multiple instruments are playing together.

4. Pattern mode

FX EDIT2: Depth 0...127
Adjusts the depth of the delay and the amount of feedback. Turning the knob toward the right makes the delayed sound louder and also increases the amount of feedback. Panning each part further left or right creates a deeper sense of spaciousness.

 If you increase the depth excessively, the sound may distort for some time settings or input sources.

 If you lower the time value too far, the sound may distort (clip).

MOD DELAY (Modulation delay)

This is a delay that adds a chorus effect by using the LFO to sweep the delay time. This is also a tempo delay in which the delay time automatically synchronizes to the tempo.

FX EDIT1: Time 1/64...1/1
Adjusts the delay time synchronized to the tempo, in note value units.

Turning the knob toward the right lengthens the delay time.

You can set this in a range from a 64th note to a whole note.

FX EDIT2: Depth 0...127

Adjusts the depth of the delay and the amount of feedback.

Turning the knob toward the right makes the delayed sound louder and also increases the amount of feedback.

 The feedback sound may disappear if you turn the TIME knob or change the BPM while producing sound.

 Depending on the tempo setting, some long delay times may not be available. In this case, the delay time will be halved, and may be halved again if necessary.

 Depending on the tempo setting, some short delay times may not be available. In this case, the delay time will be doubled, and may be doubled again if necessary.

GRAIN SHIFTER (Grain shifter)

This effect samples an extremely brief portion of the sound at a certain interval, and repeatedly plays back this brief sample. It is effective when applied to a constantly-changing source such as Audio In.

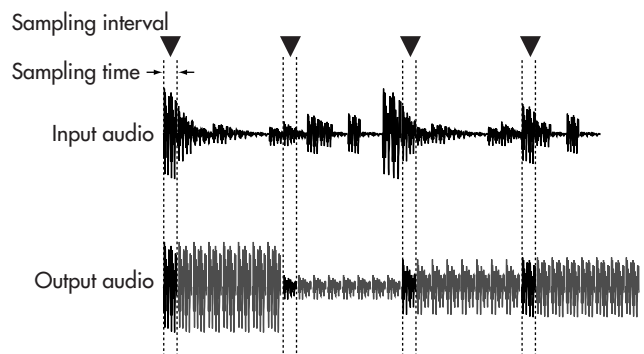

1

2

3

4

5

6



7

8

FX EDIT1: Speed 1...127

Specifies the sampling interval and the sampling time. The sampling interval is synchronized to the number of steps in the sequencer. When the BPM changes, the length per step will also change, so the sampling interval will change together with this. The following table shows how the sampling interval corresponds with the speed value.

SPEED	Sampling interval (number of steps)
0-1	128
2-5	32
6-9	16
10-13	12
14-21	8
22-25	6
26-33	4
34-37	3
38-41	8/3
42-49	2
50-53	4/3
54-83	1
84-127	9/10 ... 1/10 (in 21 steps)

-  Even if the sampling interval is in the same region, increasing the SPEED value will shorten the sampling time.
-  If the speed is set to a low value and this effect is played back continuously for an extended time, the high-frequency portion of the playback will gradually diminish, causing the tone to become softer.

FX EDIT2: Balance 0...127

Adjusts the balance of the effect sound and direct sound. Turning the knob toward the right will increase the effect sound and decrease the direct sound.

-  If the speed setting is low, the sampling interval will be long, meaning that if you play the keyboard etc. manually at a moment in which sampling is not being performed, you will not hear any sound.

CHO/FLG (Chorus/flanger)



Chorus and flanger are effects that modulate the pitch of a slightly-delayed sound and add this to the original sound to create a swirling sensation or a sense of spaciousness.

FX EDIT1: Speed 0...127

Adjusts the speed of the chorus/flanger LFO. Turning the knob toward the right will speed up the LFO.

FX EDIT2: Depth 0...127

Adjusts the depth of the chorus/flanger effect. Turning the knob toward the right will change the effect from chorus to flanger.

-  If the depth setting is too high, distortion may occur for some input sounds.
-  If you set the speed setting at 0, the LFO will stop at that position (phase). The position (phase) at which the LFO stops is not written into the pattern/song data. In addition, the state (phase) of the LFO is reset when you switch to this effect from a different effect type. This means that a pattern/song for which you selected this effect, set

the speed to 0, and wrote the settings into memory may sound differently the next time you select the pattern/song.

PHASER (Phaser)



This effect creates a sense of modulation by cyclically varying the phase of the sound and mixing this phase-shifted sound with the original sound.

FX EDIT1: Speed 0...127

Adjusts the speed of the phaser LFO. Turning the knob toward the right will speed up the LFO.

FX EDIT2: Depth 0...127

Adjusts the depth of the phaser. Turning the knob toward the right will give the sound a stronger sense of modulation.

-  If the depth setting is too high, distortion may occur for some input sounds.
-  If you set the speed setting at 0, the LFO will stop at that position (phase). The position (phase) at which the LFO stops is not written into the pattern/song data. In addition, the state (phase) of the LFO is reset when you switch to this effect from a different effect type. This means that a pattern/song for which you selected this effect, set the speed to 0, and wrote the settings into memory may sound differently the next time you select the pattern/song.

RING MOD (Ring modulator)

This effect modulates the sound to give it a metallic character or turn it into a special-effect.

FX EDIT1: OSCFreq. 0...127

Specifies the frequency used to apply modulation. Turning the knob toward the right raises the frequency.

FX EDIT2: Balance 0...127

Adjusts the balance between the effect sound and direct sound. Turning the knob toward the right increases the effect sound and decreases the direct sound.

TALKING MOD (Talking modulator)

This effect adds vowel formants to the input sound.

FX EDIT1: Formant 0...127

Specifies the formant. As you turn the knob clockwise from 0 to 127, the formant will change smoothly between [a]-[e]-[i]-[o]-[u].

FX EDIT2: Offset -63...63

Specifies the pitch of the formant frequency.

PITCH SHIFTER (Pitch shifter)

This effect modifies the pitch.

FX EDIT1: Pitch -2400...+2400

Specifies the amount of pitch change in units of cents. When the knob is in the center position, the pitch of the input sound will not be changed. Turning the knob toward the left will lower the pitch, and toward the right will raise the pitch. The range is ± 2 octaves.

FX EDIT2: Balance 0... 127

Adjusts the balance between the effect sound and direct sound. Turning the knob toward the right increases the effect sound and decreases the direct sound.

COMPRESSOR (Compressor)

A compressor boosts low-level sounds and reduces high-level sounds, decreasing variations in volume and making the sound more consistent. This compressor automatically detects the levels of the L and R input signals, and responds to the louder of the two.

FX EDIT1: Sens 0... 127

(Sensitivity)
Adjusts the sensitivity of the compressor.

FX EDIT2: Attack 0... 127

Adjusts the speed at which the compressor begins to apply. Turning the knob toward the right will slow down the attack.

DISTORTION (Distortion)

This effect drastically boosts the level to create distortion, producing a richer overtone structure.

FX EDIT1: Gain 0... 127

Adjusts the degree of distortion. Turning the knob toward the right will produce more intense distortion.

FX EDIT2: Level 0... 127

Adjusts the output level. Turning the knob toward the right will increase the output level.

DECIMATOR (Decimator)

This effect decreases the sampling frequency and bit depth to give the sound a rougher character typical of inexpensive samplers.

FX EDIT1: Freq. 0... 127

(Sampling frequency)
Turning the knob toward the right will produce a “lo-fi” sound characteristic of a lower sampling frequency, and turning it toward the left will produce a “hi-fi” sound characteristic of a higher sampling frequency.

FX EDIT2: Bit 0... 127

(Sample bit depth)
Turning the knob toward the right will produce a “lo-fi” sound characteristic of a lower bit depth, and turning it

toward the left will produce a “hi-fi” sound characteristic of a higher bit depth.

 If the input volume is very low, there may be no audio output at all.



EQ (Equalizer)

This equalizer boosts/cuts the low and high-frequency regions of the sound.

FX EDIT1: LowGain -63...63

The volume of the low-frequency region will be cut when the knob is turned toward the left, flat when the knob is in the center position, and boosted when the knob is turned toward the right.



FX EDIT2: HighGain -63...63

The volume of the high-frequency region will be cut when the knob is turned toward the left, flat when the knob is in the center position, and boosted when the knob is turned toward the right.



 For some input sounds, high gain settings may cause distortion.

LPF (Low Pass Filter)

This is a low pass filter with resonance.

FX EDIT1: Cutoff 0... 127

Adjusts the cutoff frequency of the low pass filter. Turning the knob toward the right will raise the cutoff frequency.



FX EDIT2: Resonance 0... 127

Boosts the region of the cutoff frequency, giving the sound a distinctive character. Turning the knob toward the right will increase the resonance.



 High resonance settings may cause distortion depending on the cutoff frequency and the input sound.

HPF (High Pass Filter)

This is a high pass filter with resonance.

FX EDIT1: Cutoff 0... 127

Adjusts the cutoff frequency of the high pass filter. Turning the knob toward the right will raise the cutoff frequency.



FX EDIT2: Resonance 0... 127

Boosts the region of the cutoff frequency, giving the sound a distinctive character. Turning the knob toward the right will increase the resonance.



 High resonance settings may cause distortion depending on the cutoff frequency and the input sound.



Recording a phrase

You can specify a synth sound or rhythm sound for each part, and record a phrase pattern for it.

note If you want to erase the rhythm and phrase data of each part before you create a pattern, refer to “Erasing the sequence data of a part” (p.56).

Realtime recording

This method lets you use the drum pads or the Keyboard function to record a new rhythm or phrase while you listening to the pattern.

Step recording

This method lets you use the step keys to create a sequence pattern with pattern playback stopped. You can create a pattern by inputting the pitch and note length for each step, one at a time.

Recording a phrase during playback (Realtime Recording)

You can record a rhythm pattern (using the drum part keys) or a synth part phrase (using the step keys with the Keyboard function) by pressing the keys at the timing at which you want the sound to play.

note You can also sound the metronome while you record. (p.75 “Setting the metronome”)

To record a drum part

1. Press the PATTERN key (it will light).
2. Press the [▲] cursor key until the display reads “(pattern name).” Turn the dial to select the pattern you want to record.
3. Press the REC key to enter record-ready mode. The REC key will light and the PLAY/PAUSE key will blink.
4. Recording will start when you press the PLAY/PAUSE key. The PLAY/PAUSE key will light.
5. Press the drum keys at the desired timing. The step keys will light to indicate the steps you recorded.
If you want to switch parts without recording a note, hold down the SHIFT key and press a part key.
6. The pattern will play back repeatedly. You can continue adding notes while the REC key is lit.
7. When you have finished recording, press the STOP/CANCEL key. The REC key and PLAY/PAUSE key will go dark.
Alternatively, you can press the REC key instead of pressing the STOP/CANCEL key; only the REC key will go dark, and recording will end but playback will continue.
8. If you want to name and save the pattern you finished recording, hold down the SHIFT key and press the Write key (p.64 “Saving a pattern”).

To record a synth part

1. Press the PATTERN key (it will light).
2. Press the [▲] cursor key until the display reads “(pattern name).” Turn the dial to select the pattern you want to record.
3. Select a synth part 1–5, and turn the KEYBOARD key on (lit).
4. Press the REC key to enter record-ready mode. The REC key will light and the PLAY/PAUSE key will blink.
5. Press the PLAY/PAUSE key to start the pattern. The PLAY/PAUSE key will light.

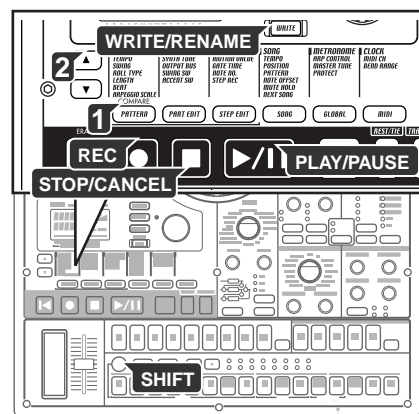

1

2

3

4

5

6

7

8

6. Use the step keys as a keyboard to record the phrase, pressing the appropriate key to enter the desired pitch at the desired time.
7. The pattern will play back repeatedly. You can continue recording while the REC key is lit.
Recording will stop when you press the STOP/CANCEL key, and the REC key and PLAY/PAUSE key will go dark. Alternatively, you can press the REC key instead of pressing the STOP/CANCEL key to stop recording but continue playback. The REC key will go dark, and the PLAY/PAUSE key will remain lit.
8. If you want to name and save the completed pattern, hold down the SHIFT key and press the Write key (see p.64 "Saving a pattern").

To record during playback

If a musical idea strikes you while a pattern is playing, you can start recording immediately, without having to stop playback.

1. Start the pattern playing.
2. Press the REC key (it will light).
3. If you want to record a drum part, press the drum part key for that part at the desired timing.
If you want to record a synth part, press the synth part key for the part you want to record, and with the KEYBOARD key turned on, play the step keys as a keyboard to enter the desired pitch at the desired time.
4. When you have finished recording, press the REC key (the key will go dark).
5. If you want to save the pattern, press the Write key (see p.64 "Saving a pattern").

To erase unwanted triggers during playback (Erase)

While playing back, you can hold down the SHIFT key, and press and hold the RESET/ERASE key to erase triggers that occur during that time for the selected part (whose key is lit).

Step recording

The step recording procedure will differ depending on whether you are creating a synth part phrase or a drum part rhythm.

- ⚠ When you press a drum part key, the Keyboard function of the step keys will be defeated, but the Keyboard function will return to its previous setting when you select a synth part once again.

To record a rhythm for a drum part

1. Press the PATTERN key (it will light).
Press the [▲] cursor key several times until the display reads "(pattern name)." Turn the dial to select the pattern you want to record.
 2. Press the drum part key of the part you want to record. (The key will light.)
 3. Use the select keys to select which area of the pattern you want to edit. The lower line of LEDs will indicate the area in which you will be editing. For example, if the pattern to be edited has a length of "2" and you wish to edit the second half of the pattern, you would use the select keys to advance the red led to the "2" position.
 4. The step keys will light to indicate the rhythm of the selected pattern. You can press the step keys to change the rhythm of the pattern. Each time you press a step key, it will alternate between on (lit) and off (dark). You can make these changes even during playback.
- ⚠ Drum parts 6A and 6B, and 7A and 7B, cannot be played simultaneously. If both 'A' and 'B' are triggered simultaneously, only 'B' (i.e., 6B or 7B) will sound.

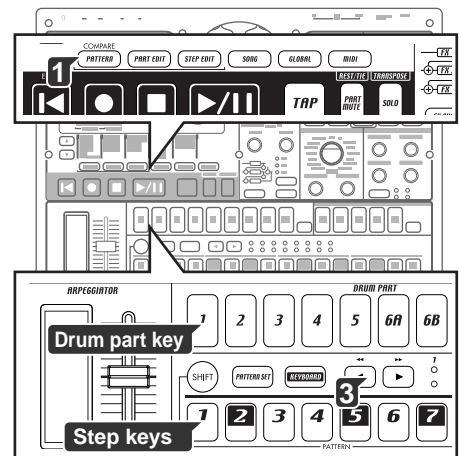

To record a phrase for a synth part

1. If the EMX-1 is playing, press the STOP/CANCEL key to stop playback.
2. Press the PATTERN key (it will light).
Press the [▲] cursor key until the display reads "(pattern name)."
Turn the dial to select the pattern that you want to record.
3. Press the synth part key of the part you want to record. (The key will light.)
4. Turn the KEYBOARD key on (lit).
5. Press the STEP EDIT key, and then press the [▼] cursor key until the display reads "Step Rec." The display will show the target step.
6. Turn the dial to select the target step at which you want to begin recording.
7. Press the REC key to enter record-ready mode.
At this time, playback will not start even if you press the PLAY key.
8. Use the step keys to input the pitches of the phrase one by one. When you input a pitch, the target step (the step to be edited) will automatically advance to the next step.
9. Recording will end when you input the last step or press the STOP/CANCEL key. (The REC key will go dark.)

To input a rest or tie

Press the REST/TIE key to input a rest.

To enter a tie, hold down the step key and press the REST/TIE key.

To move the target step

While recording, you can turn the dial to move the target step forward or backward one step at a time. You can also move between steps by holding down the SHIFT key and using the select keys.

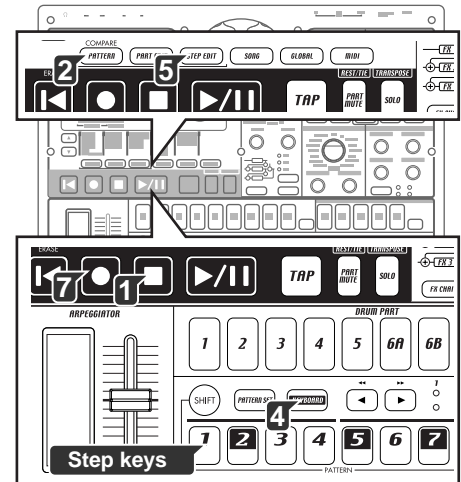

1

2

3

4

5

6

7

8

Editing sequence data

Here's how to edit patterns that you have recorded or patterns that are saved in memory.

 If you want to keep the changes you made to a pattern, you must perform the Write/Rename operation before you select another pattern or turn off the power.

Editing a phrase pattern (Note Edit)

When using Step Recording, you record the trigger and note number simultaneously, but cannot set the gate time in detail. If you want to be more precise, you can readjust the trigger or note number, and adjust the gate time. A phrase pattern for a synth part consists of the following three items of data. You can adjust each of these three items for each step.

Trigger: whether the part will sound at this step

Note number: the pitch that will be sounded

Gate time: the duration that will be sounded

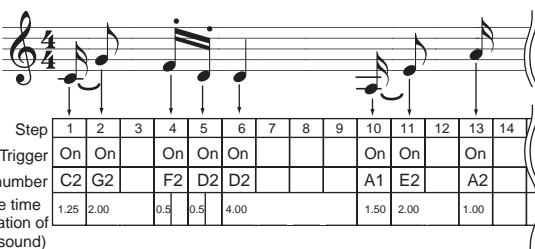

Step	1	2	3	4	5	6	7	8	9	10	11	12	13	14
Trigger	On	On		On	On	On				On	On		On	
Note number	C2	G2		F2	D2	D2				A1	E2		A2	
Gate time (duration of the sound)	1.25	2.00		0.5	0.5	4.00				1.50	2.00		1.00	

Beat : 16

Selecting the step you want to edit

First you will select the step that you want to edit. The step to which your editing will apply is called the "target step."

STEP REC 1.01...8.16

1. Press the STEP REC key (it will light).
Press the [▼] cursor key until the parameter display reads "Step Rec." The value display will show the target step.

2. Turn the dial to select the target step.
If the KEYBOARD key is off at this time, the step key that corresponds to the target step will blink.

 If the pattern length is 2 or greater, you can hold down the SHIFT key and turn the dial to advance by one unit of length.

As an alternative to using the dial, you can also select the target step in the following ways.

— Hold down the SHIFT key and press a select key to move forward or backward one step at a time.

— When the KEYBOARD key is off, you can press a step key to select the step that corresponds to that key.

 If the pattern length is 2 or greater, you can use the select keys to switch the select LEDs (red) and move the target step in units of one length.

 The maximum number of steps will depend on the length, beat, and last step setting.

 When the KEYBOARD key is on, the step keys will not indicate the target step.

Editing the trigger locations (the location of the notes)

1. Press the PATTERN key or PART EDIT key (it will light).
2. Press the synth part key that you want to edit. (The key will light.)
3. Turn the KEYBOARD key off (dark).
4. The step keys will indicate the trigger locations for the phrase pattern of the part you selected.

5. Press a step key to change the trigger setting for the corresponding location. Each time you press a step key, the trigger will be switched alternately on (lit) or off (dark).



You cannot edit the trigger locations when the STEP EDIT key is lit.

Editing the note number (pitch)

NOTE NO. C-1...G9

1. Press the STEP EDIT key (it will light).
2. Use the [▲][▼] cursor keys to select "NoteNo" in the display.
3. Press the synth part key that you want to edit. (The key will light.)
4. Turn the KEYBOARD key off (dark).
5. The step keys will indicate the trigger locations for the phrase pattern of the part you selected.
6. Press the step key for the location whose note number you want to edit (the key will blink).
7. Turn the dial to change the note number for that step. Alternatively, you can turn the KEYBOARD key on, and press a step key to specify the desired note number. If you then want to specify a different target step for editing, turn the KEYBOARD key off temporarily.



While the display indicates "Note No.," pressing the step keys will not switch triggers on/off.



Even if you edit the note number of a step whose trigger is off, it will not sound until you turn the trigger on.



If you want to transpose a part, use the Shift Note function. (p.55 "Transposing the pitch of a synth phrase part")

Editing the gate time

GATE TIME 0.25...128.0

1. Press the STEP EDIT key (it will light).
2. Use the [▲][▼] cursor keys to select "GateTime" in the display.
3. Press the synth part key that you want to edit. (The key will light.)
4. Turn the KEYBOARD key off (dark).
5. The step keys will indicate the trigger locations for the phrase pattern of the part you selected.
6. Press the step key for the location whose gate time you want to edit (the key will blink).
7. Turn the dial to change the gate time for that step. The value shown in the display is the gate time length in units of a step. For example, a gate time setting of "1.0" means that the gate time will be exactly as long as one step.



If the gate time length extends into the timing of the next note, the next note will be played legato; the oscillator, EG, and modulation will not be retriggered.



While the display indicates the gate time, pressing the step keys will not switch triggers on/off.



Even if you edit the gate time of a step whose trigger is off, it will not sound until you turn the trigger on.

1

2

3

4

5

6

7

8

Specifying the length and time signature of a pattern

Here's how the Length, Beat (time signature), and Last Step are related.

On the EMX-1, the total number of measures (or bars) in a pattern is called the "length." The number of steps (or beats) in one of these measures is designated as the "last step." The type of note that is counted as a step is called the "beat." If you select "8Tri" or "16Tri" as the beat, the last step will automatically be set to 12, meaning that step keys 13-16 will have no function. If you select "16" or "32" as the beat, the last step will be automatically set to 16. You can set any step in a pattern to be the last step.

To check the length and beat

With the pattern stopped, hold down the SHIFT key. The upper line of select LEDs (green) will indicate the current pattern length in measures, and the lower line of select LEDs (red) will indicate the beat setting.

The following diagram shows how the step keys, notes and maximum number of steps are related.

BEAT	Correspondence of step keys to notes
16 (♩ × 16) 1 2 3 4 ○ ○ ○ ○ ○ ○ ○ ○	
32 (♩ × 16) 1 2 3 4 ○ ○ ○ ○ ○ ○ ○ ○	
8Tri (♩₃ × 12) 1 2 3 4 ○ ○ ○ ○ ○ ○ ○ ○	
16Tri (♩₃ × 12) 1 2 3 4 ○ ○ ○ ○ ○ ○ ○ ○	

beat display	Note value of each step key	Pattern length (number of steps)							
		=1	=2	=3	=4	=5	=6	=7	=8
16 (♩ × 16)	16th note	16	32	48	64	80	96	112	128
32 (♩ × 16)	32nd note	16	32	48	64	80	96	112	128
8Tri (♩₃ × 12)	8th note triplet	12	24	36	48	60	72	84	96
16Tri (♩₃ × 12)	16th note triplet	12	24	36	48	60	72	84	96

Setting the length

LENGTH 1...8

1. If the EMX-1 is playing, press the STOP/CANCEL key to stop playback.
2. Press the PATTERN key (it will light).
3. Use the [▲]/[▼] cursor keys to select "length" in the parameter display.
4. Turn the dial to specify the length of the pattern in measures.
5. If you want to keep the pattern you edited, press the WRITE/RENAME key. (Ⓢp.64 "Saving a pattern")

Setting the beat

BEAT 16, 32, 8Tri, 16Tri

1. If the EMX-1 is playing, press the STOP/CANCEL key to stop playback.
2. Press the PATTERN key (it will light).
3. Use the [▲]/[▼] cursor keys to select "beat" in the parameter display.

4. Turn the dial to set the beat.
5. If you want to keep the pattern you edited, press the WRITE/RE-NAME key. (☞p.64 "Saving a pattern")

Setting the last step

You can set the "Last Step" if you need to create a pattern of an irregular time signature. For example if you want to create a pattern that contains eleven beats per measure, set Last Step to 11, so that each length of the pattern will be 11 steps.

Normally, Last Step will be 16 (it will be 16 if you have selected a 16th note or 32nd note beat), but will be 12 if you selected a beat that contains triplets, or yet a different value if you have specified an irregular time signature as described above. The step keys that lie beyond the Last Step do nothing.

LAST STEP 1...16

1. If the EMX-1 is playing, press the STOP/CANCEL key to stop playback.
2. Press the PATTERN key (it will light).
3. Hold down the SHIFT key and press step key 1. The key will blink, and the parameter display will read "LastStep."
4. Turn the dial to set the Last Step, and press step key 1 (key 1 will go dark).
If you decide to cancel without setting the Last Step, press the STOP/CANCEL key.
5. If you want to keep the pattern you edited, press the WRITE/RE-NAME key. (☞p.64 "Saving a pattern")



If you change the beat, Last Step will be reset to 16 or 12.



Last Step is a function that is unique to the EMX-1; if you are playing the EMX-1 in synchronization with an external sequencer or a different model of the Electribe series, regions where you have used an irregular time signature will not be synchronized.



If you specify a Last Step that is shorter than the original number of steps, the note data that existed beyond the last step will be masked, and will not play back. If you change the Last Step back to its previous setting, this note data will be unmasked, and will play as before.

1

2

3

4

5

6

7

8

Moving data within a pattern

MOVE DATA MOVE, REPEAT, RANDOM

Use this function to move phrase pattern or motion sequence data in units of one step.

To move data

MOVE (-7.15...+7.15)*

*The amount by which you can move steps will depend on the Length and on the Last Step setting.

Here's how to change the location at which the pattern begins.

1. If the EMX-1 is playing, press the STOP /CANCEL key to stop playback.
2. Hold down the SHIFT key and press step key 2 (MOVE DATA).
3. Verify that the display indicates "Move," and press step key 2 once again.
4. The selected part key will blink. Press the part or motion sequence keys whose data you want to move at the same time, so that these keys are blinking. You can hear the sound of a part each time you press its part key.
5. Turn the dial to set the number of steps and the direction (positive or negative) in which you want to move the data. To set the value of the digit (length) before the decimal point, hold down the SHIFT key and turn the dial.
6. Press the blinking step key 2 to execute the Move Data operation. (Key 2 will go dark.)
To cancel without executing, press the STOP/CANCEL key.

To copy data repeatedly

REPEAT 0.01...7.15*

*The maximum number of repeats will depend on the Length and the Last Step.

This operation lets you copy the specified number of steps from the beginning of the pattern to the end of the pattern for the specified number of times.

1. If the EMX-1 is playing, press the STOP /CANCEL key to stop playback.
2. Hold down the SHIFT key and press step key 2 (MOVE DATA).
3. The display indicates "Move"; turn the dial to change this to "Repeat," and then press step key 2 once again.
4. The selected part key will blink. Press the part or motion sequence keys whose data you want to copy at the same time, so that these keys are blinking. You can hear the sound of a part each time you press its part key.
5. Turn the dial to set the number of times that the data will be copied.
6. Press the blinking step key 2 to execute the Move Data operation. (Key 2 will go dark.)
To cancel without executing, press the STOP/CANCEL key.

To move data randomly

RANDOM

This operation lets you randomly rearrange the pattern data.

When you execute this, the existing steps and note data (only in the case of synth parts) will be randomly rearranged to other steps.

1. If the EMX-1 is playing, press the STOP /CANCEL key to stop playback.
2. Hold down the SHIFT key and press step key 2 (MOVE DATA).

Move Data affects the valid steps of the selected part. The valid steps are determined by the Beat Length and Last Step of each pattern.

Data that is moved beyond the ending step of a pattern will be "wrapped around" to the first step. For example if you edit a 64-step pattern by setting "Move Data" to "+5", the data of steps 60 through 64 will be wrapped around to steps 1 through 5.

Likewise, if you move data beyond the first step, it will be wrapped around to the last step.B

With a setting of 3

The data of each step will be moved three steps toward the end of the pattern.

Example: 2 → 5, 6 → 9, 10 → 13, 14 → 1

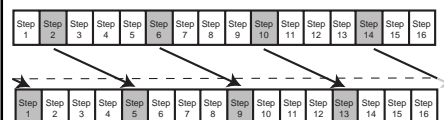

With a setting of -2

The data of each step will be moved two steps toward the beginning of the pattern.

Example: 1 → 15, 3 → 1, 6 → 4, 10 → 8, 14 → 12

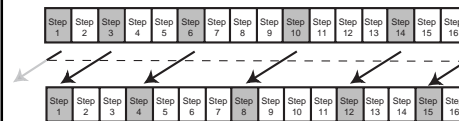

3. The display indicates "Move"; turn the dial to change this to "Random," and then press step key 2 once again.
4. The selected part key will blink. Press the part or motion sequence keys whose data you want to copy at the same time, so that these keys are blinking. You can hear the sound of a part each time you press its part key.
5. Press the blinking step key 2 to execute the Move Data operation. (Key 2 will go dark.)
To cancel without executing, press the STOP/CANCEL key.

Transposing the pitch of a synth phrase part

SHIFT NOTE SHIFT, RANDOM

Shifting the pitch of note data

SHIFT -24...+24

This operation lets you shift the pitch of the note data (i.e., transpose) for all steps in the selected synth part(s).

1. If the EMX-1 is playing, press the STOP/CANCEL key to stop playback.
2. Hold down the SHIFT key and press step key 3 (SHIFT NOTE).
3. Verify that the display indicates "Shift," and then press step key 3 once again.
4. The synth part keys will blink. Press the keys to turn off any parts that you do not want to transpose. (The part will sound at C4.)
5. A number will appear in the display. Turn the dial to specify the amount of pitch shift. ± 1 is a semitone, ± 2 is a whole step, ± 7 is a fifth, and ± 12 is an octave of pitch shift.
6. Press the blinking step key 3 to execute the Shift Note operation (key 3 will go dark). To cancel without executing, press the STOP/CANCEL key.

Randomly shifting the note data of a synth part

RANDOM.....

This operation randomly shifts the note data of all steps in the selected synth part. When you execute this, the note data of the existing steps will be randomly reassigned to the existing step locations (the original combination of notes will be maintained).

1. If the EMX-1 is playing, press the STOP/CANCEL key to stop playback.
2. Hold down the SHIFT key and press step key 3 (SHIFT NOTE).
3. The display indicates "Shift"; turn the dial to change this to "Random," and then press step key 3 once again. If you decide to cancel without making settings, press the STOP/CANCEL key.
4. The synth part keys will blink. Press the keys to turn off any parts for which you don't want to randomize the pitch. (The part will sound at C4.)
5. Press the blinking step key 3 to execute the Shift Note operation (key 3 will go dark). To cancel without executing, press the STOP/CANCEL key.

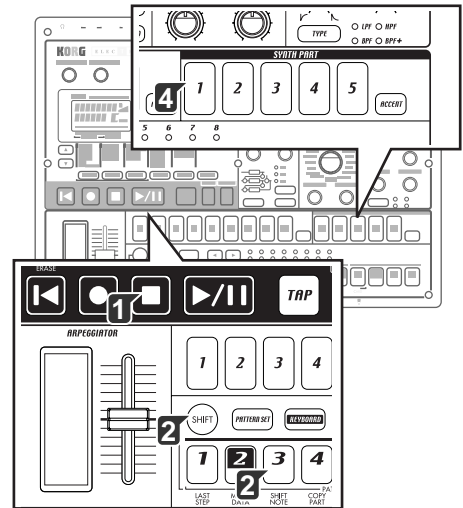
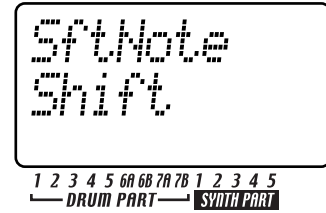

Copying a part

COPY PART

Here's how you can copy the selected part (with its sound settings and sequence data, including motion sequence) to another part.

1. If the EMX-1 is playing, press the STOP/CANCEL key to stop playback.
2. Press a part key to select a destination (copy-destination) for the part being copied (the key will light).
3. Hold down the SHIFT key and press step key 4 (Copy Part). (Key 4 will blink.) The copy-destination part key will begin blinking.
4. Use the dial to select the pattern number of the part to be copied (copy-source).
5. Press a part key to select the copy-source part. (The copy-source key will blink, and the copy-destination key will go dark.) You can hear the sound of the copy-source by pressing its part key. (Synth parts will sound at C4.)
6. Press step key 4 once again to execute the Copy Part operation. If you decide to cancel, press the STOP/CANCEL key.



When you copy between parts, only the trigger data is copied. If the copy operation would result in there being more than 24 motion sequences, the motion sequences will not be copied.

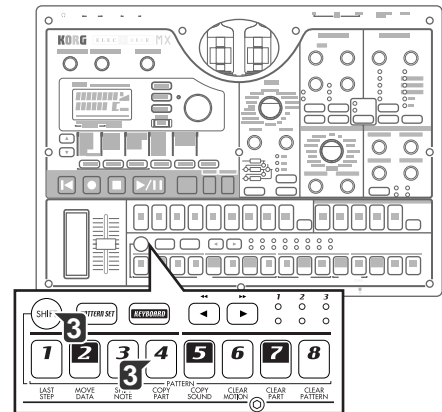

Copying only the sound of a part

COPY SOUND

Here's how you can copy only the sound settings of another part to the selected part. Step data and motion sequence data will not be copied.

1. If the EMX-1 is playing, press the STOP/CANCEL key to stop playback.
2. Press a part key to select a destination (copy-destination) for the part being copied (the key will light).
3. Hold down the SHIFT key and press step key 5 (COPY SOUND). (Key 5 will blink.) The copy-destination part key will begin blinking.
4. Use the dial to select the pattern number of the part to be copied (copy-source). You can press the SHIFT key to view the pattern name of the copy-destination.
5. Press a part key to select the copy-source part. (The copy-source key will blink, and the copy-destination key will go dark.) You can hear the sound of the copy-source by pressing its part key. (Synth parts will sound at C4.)
6. Press step key 5 once again to execute the Copy Sound operation. If you decide to cancel, press the STOP/CANCEL key.



You cannot copy sound data between a synth part and a drum part.

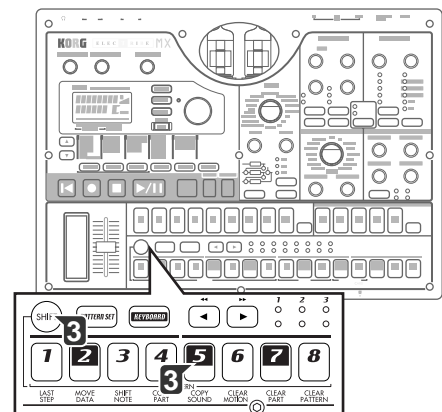

Erasing the sequence data of a part

To erase sequence data from the selected part, you can use the sixteen step keys to turn each trigger on/off independently, or use one of the following two operations.

To erase all of a part's performance data

CLEAR PART

This operation erases the rhythm or phrase pattern (trigger, note number, gate time) and motion sequence data at once.

1. If the EMX-1 is playing, press the STOP/CANCEL key to stop playback.
2. Hold down the SHIFT key and press step key 7 (CLEAR PART). (Key 7 will blink.)
3. Press the part key whose data you want to erase. You may select more than one part at this time. The selected part keys will blink. You can press a part key to hear its sound. (Synth parts will sound at C4.)
4. Press step key 7 once again to execute the Clear operation. If you decide to cancel, press the STOP/CANCEL key.



When you execute this Clear Part operation on a synth part, all steps of the phrase pattern will be set to a pitch of C4 and a gate time of "0.75".



Executing the Clear Part operation will not clear the sound settings.

To erase trigger data while recording or playing back

ERASE

1. Press the part key to select the part where you will be erasing data.
2. During playback or recording, hold down the SHIFT key, and press and hold the RESET/ERASE key to erase the data that plays back during that time.



For a synth part, this erases only the trigger data; the note number and gate time for each step will remain.

Erasing all data from a pattern

CLEAR PATTERN

This operation erases all of the data from the currently selected pattern. The sound settings of each part, the sequence data (including motion sequences), tempo, length, and beat will all be initialized.

1. If the EMX-1 is playing back, press the STOP/CANCEL key to stop playback.
2. Select the pattern that you want to erase (p.20: Selecting a pattern).
3. Hold down the SHIFT key and press step key 8 (CLEAR PATTERN). (Key 8 will blink.) At this time, you can press the SHIFT key to see the name of the pattern.
4. Press step key 8 once again to execute the Clear operation. If you decide to cancel, press the STOP/CANCEL key.

Comparing the currently-edited pattern with the saved pattern (COMPARE)

This function lets you compare the original pattern with the currently-edited pattern before you save it.

1. Hold down the SHIFT key and press the PATTERN key. The PATTERN key will blink, and the EMX-1 will be in Compare mode. (The parameter display will indicate "Compare.")
2. Press the PLAY/PAUSE key to play the original unedited pattern.
3. Press the PATTERN key. It will stop blinking, and you will return to the pattern you were editing.



You cannot switch modes or record while the Compare function is active.

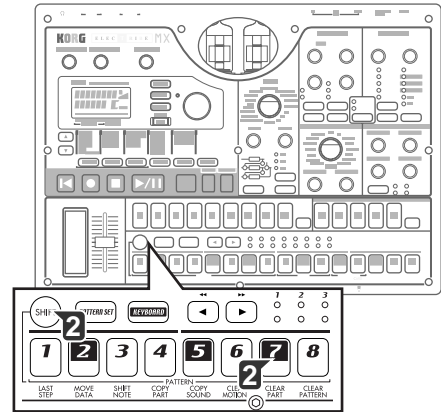

1

2

3

4

5

6

7

8

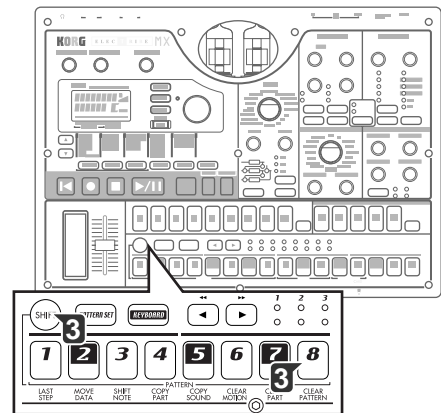

Motion sequence

What is a motion sequence?

The EMX-1 has a Motion Sequence function that lets you record and playback realtime changes made to the knobs and keys (☞“Recording a motion sequence”).

There are two types of motion sequence; one type for effects and one type for each of the parts.

The knobs and keys that can be recorded using a motion sequence are listed below. You can record a total of twenty-four effect and part motion sequences in each pattern.

Effects (FX1, FX2, FX3)

FX EDIT1, FX EDIT2

Drum parts (1-7B)

The Part Common parameters PITCH, EG TIME, PAN, LEVEL, AMP EFFECT, ROLL, FX SEND, FX SELECT; and the Modulation parameters SPEED, DEPTH, BPM SYNC, MOD TYPE, MOD DEST

Synth parts (1-5)

The Part Common parameters GLIDE, EG TIME, PAN, LEVEL, AMP EG, ROLL, FX SEND, FX SELECT; the Modulation parameters SPEED, DEPTH, MOD TYPE, MOD DEST; the Synth Oscillator parameter OSC EDIT 1, OSC EDIT 2; and the Synth Filter parameters CUTOFF, EG INT, RESONANCE, DRIVE, FILTER TYPE

Accent parts

The Part Common parameter LEVEL

Recording a motion sequence

Here’s how to record a motion sequence (knob or key movements) for a part or effect.

To record a motion sequence for a part, select the desired part, and then turn on the motion sequence key of the part common section to select either SMOOTH or TRIG HOLD.

To record a motion sequence for an effect, turn on the motion sequence key of the effect section.

In the following example we will record a motion sequence for the pitch of a drum part.



If you re-record a knob for which a motion sequence has already been recorded, the previous data will be erased.

1. In Pattern mode, select the pattern that you want to edit.
2. Press a drum part key to select the part that you want to edit.
3. Press the motion sequence key to select either SMOOTH or TRIG HOLD.
4. Press the REC key to enter record-ready mode. The REC key will light and the PLAY/PAUSE key will blink.
5. Press the PLAY/PAUSE key to start the pattern. The REC key and PLAY/PAUSE key will light.
6. Move the pitch knob as desired until the pattern completes one cycle.
7. When the pattern has played for exactly one cycle after you began moving the knob, the REC key will automatically go dark and the pattern will resume playing back, allowing you to hear the motion sequence that you recorded.



After recording a motion sequence, you can edit it by pressing the STEP EDIT key and using MOTION DEST. and MOTION VALUE. (☞p.60 “Editing motion sequence data”)

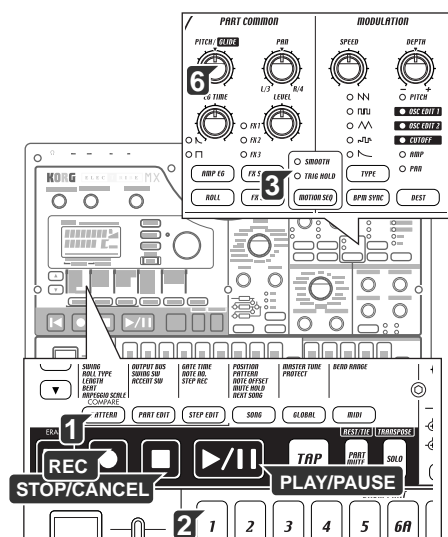

- ▶ If you press the STOP/CANCEL key to stop playback and then save the pattern as described in “Saving a pattern,” the motion sequence data you recorded will be saved together with the pattern.
- ▶ You can record a maximum of twenty-four motion sequences in each pattern.

Playing a motion sequence

You can play back a motion sequence in one of the two modes described below. The playback mode can be selected independently for each part. Effect motion sequences will always play back using the SMOOTH mode of a part motion sequence. Motion sequences for an accent part will always play back using the TRIG HOLD mode.

- ▶ AMP EG, ROLL, FX SELECT, FX SEND, MOD TYPE, MOD DEST, BPM SYNC, and SYNTH FILTER TYPE motion sequences will always play back using TRIG HOLD even if SMOOTH is selected.

SMOOTH: Knob movements will be played back smoothly, you will here the effect of the knob being turned even as a single note is sustained.

TRIG HOLD (trigger hold): Each new note being triggered will “hold” the motion sequence knob value as it was when the note was first triggered.

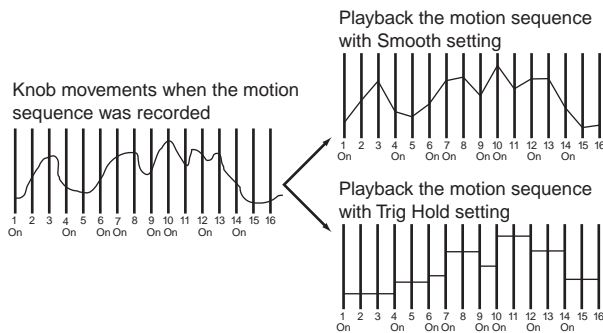

- ▶ If the motion sequence LED is dark (off), this setting does nothing.

Checking motion sequence data

Here’s how you can check and see what type of motion sequence data has been recorded. Hold down the shift key and press the motion sequence key of the part common section, and the step keys will light to indicate the motion sequence data that has been recorded. The display will indicate “FreeMot” and the number of remaining motion sequences that you can still record.

If a motion sequence is recorded for	The following key will light
Part Common section knobs	Step keys 1 and 2
Synth Filter section	Step key 3
Part Common section keys	Step key 4
Effect 1 motion sequence (Fx Edit 1 data)	Step key 5
Effect 1 motion sequence (Fx Edit 2 data)	Step key 6
Effect 2 motion sequence (Fx Edit 1 data)	Step key 7
Effect 2 motion sequence (Fx Edit 2 data)	Step key 8
Effect 3 motion sequence (Fx Edit 1 data)	Step key 9
Effect 3 motion sequence (Fx Edit 2 data)	Step key 10
Modulation knobs	Step key 11
Modulation keys	Step key 12
Synth oscillator OSC Edit 1	Step key 13
Synth oscillator OSC Edit 2	Step key 14

- ▶ You cannot check the motion sequence data during playback or recording, or while playing a pattern set.

1

2

3

4

5

6

7

8

Editing motion sequence data

Here's how you can edit motion sequence data for each part or effect. You can edit the data in units of a single step.

Selecting the motion sequence that you want to edit

MOTION DEST***

1. Select the part containing the motion sequence data that you want to edit.
2. Press the step edit key (the key will light).
3. Press the [▲] cursor key to until the display reads "MotDest."
4. Turn the dial to select a parameter for which a motion sequence has already been recorded for the currently selected part.

If you want to select a parameter for which a motion sequence has not yet been recorded for the currently selected part, hold down the shift key while you turn the dial.

note When selecting "MotDest," you can hold down the shift key and use the dial to select a parameter for which a motion sequence has not yet been recorded, and then use MOTION VALUE to edit the values.

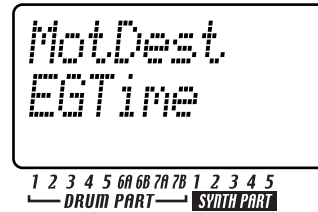





Editing motion sequence parameter values

1. Press a part key to select the part that you want to edit.
2. Press the step edit key (the key will light).
3. Use the [▲]/[▼] cursor to select "MotValue" in the display
4. The display will alternately show the name of the parameter you selected in "Selecting the motion sequence that you want to edit" (see above) and the value of that parameter.
5. Press a step key to select the step that you want to edit. If the pattern has a length of two measures or greater, use the [◀|▶] keys to display the desired step.
6. Turn the dial to edit the parameter value at that step. If you select "Disabl," the motion sequence value will not be updated at that step.



MOTION DEST	MOTION VALUE *only for synth parts
Fx1Ed1(FX1 EDIT1)	Disabl, 0...127 (depends on FX TYPE)
Fx1Ed2(FX1 EDIT2)	Disabl, 0...127 (depends on FX TYPE)
Fx2Ed1(FX2 EDIT1)	Disabl, 0...127 (depends on FX TYPE)
Fx2Ed2(FX2 EDIT2)	Disabl, 0...127 (depends on FX TYPE)
Fx3Ed1(FX3 EDIT1)	Disabl, 0...127 (depends on FX TYPE)
Fx3Ed2(FX3 EDIT2)	Disabl, 0...127 (depends on FX TYPE)
Pitch/Glide(PITCH/GLIDE*)	Disabl, -63...+63 /Disabl, 0...127
EGTime(EG TIME)	Disabl, 0...127
Pan(PAN)	Disabl, L63...R63
Level(LEVEL)	Disabl, 0...127
AmpEG(AMP EG)	Disabl, Off, On
Roll(ROLL)	Disabl, Off, On
FxSend(FX SEND)	Disabl, Off, On
FxSel(FX SELECT)	Disabl, Fx1, Fx2, Fx3
ModSpd(SPEED)	Disabl, 0...127
ModDpt(DEPTH)	Disabl, 0...127
ModTyp(TYPE)	Disab, Saw, Squ, Tri, SH, Env
ModDst(DST)	Disabl, Pitch, Amp, Pan(OSCEd1, OSCEd2, Cutoff)*
ModBPM(BPM SYNC)	Disabl, Off, On
OscEd1(OSC EDIT1*)	Disabl, (depends on OSC TYPE)
OscEd2(OSC EDIT2*)	Disabl, (depends on OSC TYPE)
Cutoff(CUTOFF*)	Disabl, 0...127
Eglnt(EG INT*)	Disabl, -63...+63
Reso(RESONANCE*)	Disabl, 0...127
Drive(DRIVE*)	Disabl, 0...127
FitTyp(TYPE*)	Disabl, LPF, HPF, BPF, BPF+

-  The motion sequence you edit will return to the state prior to editing if you switch to another pattern before you write the data. If you want to keep the edited motion sequence, execute the Write operation (⇨p.64 “Saving a pattern”).
-  You cannot use the step keys to turn steps on/off while editing a motion sequence.
-  Depending on the part, some parameters cannot be selected. The REC key will not function while you are editing a motion sequence.
-  **note** When selecting “MotDest,” you can hold down the shift key and use the dial to select a parameter for which a motion sequence has not yet been recorded, and then use MOTION VALUE to edit the values.

Erasing a motion sequence for a part or effect

CLEAR MOTION

Here’s how to erase all motion sequence data for a part or effect in a single operation.

1. If the pattern is playing, press the STOP/CANCEL key to stop playback.
 2. Hold down the shift key, and press step key 6 (CLEAR MOTION). (Key 6 will blink.)
 3. Press the motion sequence key of the part (drum, synth, accent) or effect whose motion sequence data you want to erase. (You may select more than one.) The selected key(s) will blink.
 4. Press step key 6 once again to execute the Clear operation. If you decide to cancel, press the STOP/CANCEL key.
-  This will erase all motion sequences for the selected part or effect.

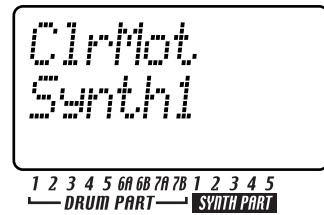

Pattern Set

What is Pattern Set?

Pattern Set is a function that lets you assign a favorite pattern to each of the sixteen step keys, and select these patterns by pressing the appropriate key. This gives you an easy way to switch between favorite patterns while performing. There are eight Pattern Groups, and each one can hold sixteen of your favorite patterns. You can also use the Chain Play function with Pattern Set to play your favorite patterns as a loop.

You can assign any pattern you choose to the pattern set (see p.63 “Assigning a pattern in the pattern set”).



You cannot use Pattern Set in Song mode.

If you switch patterns during playback, the change will occur at the end of the currently-playing pattern (see p.20 “About the timing at which patterns will change”).

Performing with a Pattern Set

When you use Pattern Set Play, operations such as the timing at which patterns change, tempo adjustments, and Reset & Play will function in the same way as in Pattern Play mode.

1. Press the PLAY/PAUSE key to begin playback.
2. By holding down the Pattern Set key and pressing a step key, you can select the pattern that is assigned to that step key.

By holding down the Pattern Set key and using the [◀][▶] select keys, you can switch to a different pattern set group. One of the lower row of select LEDs will light (red) to indicate the current pattern set group.

By holding down the shift key and pressing the Pattern Set key, you can “hold” the Pattern Set function (the key will blink). To defeat the “held” state, press the Pattern Set key once again (the key will go dark).



You cannot use Pattern Set while recording. Pattern Set will be defeated when you enter record (or record-ready) mode.



While the Pattern Set key is blinking, the step keys are used to control the Pattern Set function; this means that the Keyboard function will not be available.

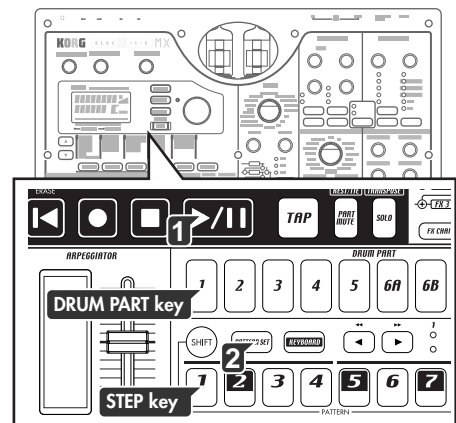

Using Chain Play with Pattern Set

This function lets you select the starting and ending pattern of the pattern set, and play these patterns as a loop. With the Pattern Set function in the “hold” state, press two step keys to specify a starting pattern and an ending pattern.

For example if patterns are assigned to the step keys as shown in the following table, you would use the procedure described below to loop the playback in the order of patterns A01, A20, B03, B04, and A51. (A01 is step key 1 and A51 is step key 5 of group 1.)

Step key	1	2	3	4	5	14	15	16
Select LED								
1	A.01	A.20	B.03	B.04	A.51	A.20	B.43	B.61
2	C.21	C.23	C.56	C.64	C.28	C.21	A.07	A.08
3	B.01	B.02	B.04	B.62	A.01	A.05	A.45	A.64
4	D.01	D.02	D.03	D.04	D.05	D.07	D.08	D.09
5	A.01	A.20	B.03	B.04	A.51	A.20	B.43	B.61
6	C.21	C.23	C.56	C.64	C.28	C.21	A.07	A.08
7	B.01	B.02	B.04	B.62	A.01	A.05	A.45	A.64
8	D.01	D.02	D.03	D.04	D.05	D.07	D.08	D.09

1. Press step key 1 of group 1 (select LED 1 lit).
2. Continue holding down step key 1, and press step key 5. Step keys 1 through 5 will be selected for chain play, and will all light.

While chain play is playing back, you can press the RESET/ERASE key to play the currently-playing pattern from its beginning.

To stop chain play, either re-select Pattern Set, or defeat "hold" for the Pattern Set function

Assigning a pattern to a Pattern Set

1. With playback stopped, hold down the Pattern Set key and press the step key to which you want to assign a pattern.
2. While holding down the Pattern Set key, use the dial to select the pattern number that you want to assign. To complete the assignment, release the Pattern Set key.
3. Continuing to hold down the Pattern Set key, press the Write key (the Write key will blink).
4. The display will ask "PtSetWr?" Use the dial to select "Yes" and press the Write key to save the data. If you decide to cancel, select "No" or press the STOP/CANCEL key.

 You will be unable to write if the Global mode Memory Protect setting (p.75 "Protecting the data in memory") is on. In this case, turn off the Global mode Memory Protect setting before you write.

 Never turn off the power while data is being written. The data may be lost if you do so.

1

2

3

4

5

6

7

8

Saving a pattern

If you want to keep a pattern that you edited or created, you must perform the Write/Rename operation explained below. When you perform the Write/Rename operation, the “Copying data within a pattern” operation will be performed automatically depending on the length of the pattern.

If you decide not to save a pattern you create

Simply switch patterns without performing the Write/Rename operation.

Saving by overwriting an existing pattern



1. Press the WRITE/RENAME key.

The parameter display will indicate “WriteTo,” and the value display will indicate “(the save-destination pattern number).” At this time you can press the SHIFT key to change the display from “(the save-destination pattern number)” to the corresponding “(six characters of the pattern name).”

To overwrite onto a different pattern

Use the dial to change the pattern number to the desired save-destination. Be sure to select a pattern number that does not contain important data you want to keep.

2. Press the WRITE/RENAME key to begin saving. The WRITE/RENAME key will light while the data is being saved, and will go dark when the operation is completed. If you decide to cancel, press the STOP/CANCEL key. When the data has been saved, the save-destination pattern number will be selected.



-  Be aware that when you write a pattern in this way, the pattern data in the save-destination will be overwritten.
-  You will not be able to write if the Global mode Memory Protect setting (p.75 “Protecting the data in memory”) is on. In this case, turn off the Global mode Memory Protect setting before you write. When shipped from the factory, memory protect is turned on.
-  Never turn off the power while data is being written into memory (i.e., while the Write/Rename key is lit). Doing so may destroy the data.

Saving a pattern under a different name

1. Hold down the shift key and press the WRITE/RENAME key. (The key will blink.) The parameter display will indicate “Rename,” and the value display will show “(six characters of the pattern name).”
2. Assign the name for the pattern that you want to save.

Use the [▲]/[▼] cursor keys to move the cursor to left or right in the parameter display, and turn the dial to edit the parameter name. You can assign a name of up to eight characters to the pattern. When you have finished assigning the name, press the WRITE/RENAME key.

3. Select the save-destination pattern number. The parameter display will indicate “WriteTo,” and the value display will indicate “(save-destination pattern number).”
4. Press the WRITE/RENAME key to begin saving the data. The WRITE/RENAME key will light while the data is being saved, and will go dark when saving is complete. If you decide to cancel, press the STOP/CANCEL key. When saving is complete, the save-destination pattern number will be selected.

-  If you saved while playing back, the playing pattern will not change.
-  If you had initiated the saving process while a pattern was playing back, and you then canceled the save operation, playback will not stop when you press the STOP/CANCEL key. Playback will stop if you press the STOP/CANCEL key once again after canceling.

Copying a pattern

You can use the Write operation to copy a pattern to a different pattern number than the currently selected program.

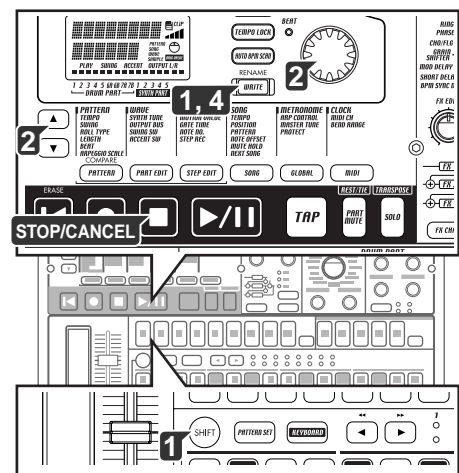
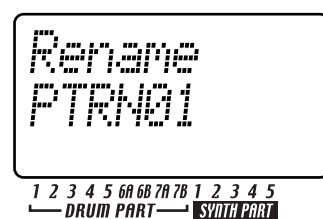
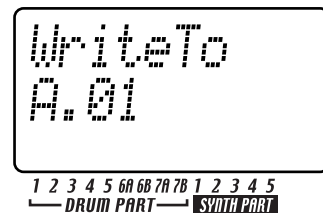

5. Song mode

Each song consists of patterns arranged in a particular playback order. You can create and store up to 64 songs in the EMX-1. In addition to the pattern playback, event recording allows you to record drum part performance, synth phrase performance, arpeggiator performance, knob movements, solo/mute operations and tempo changes into a song.

 Edited sounds cannot be stored in a song. You must use Pattern mode to edit sounds.

What is a Song?

A song is an arrangement of patterns in the desired order of playback. On the EMX-1, you can create and store up to 64 songs. In each song, you can arrange up to 256 patterns, and also record rhythms, phrases, and movements of the sound editing knobs.

What is the Position?

On the EMX-1, "position" refers to a particular place in the order of patterns that are recorded/played within a song; this is the unit by which you will edit a song.

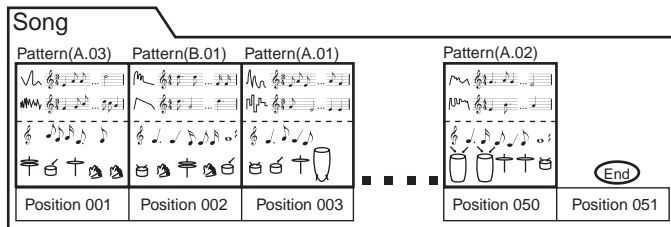

1

2

3

4

5

6

7

8

Playing a song

1. Press the SONG key. The SONG key will light.
2. Press the [▲] cursor key until the display reads “(song name).”
3. Turn the dial to select a song (S01–S64).
4. Press the PLAY/PAUSE key to play back the song (the key will light).
When the song ends, playback will stop automatically (the key will go dark).

To pause playback

Press the PLAY/PAUSE key (the key will blink).

To resume playback

Press the PLAY/PAUSE key once again (the key will light).

To stop playback

Press the STOP/CANCEL key.

Fast-forwarding or rewinding the playback

While a song is playing, you can use the select keys to fast-forward or rewind. Press the [▶] select key to fast-forward, or the [◀] select key to rewind.

 If the KEYBOARD key is on, hold down the SHIFT key and press a select key

Selecting a song

SONG S.01...S.64

Press the [▲] cursor until the display reads “(song name).” Turn the dial to select one of the sixty-four songs S01 through S64.

 You cannot change the song during playback.

Switching songs

You cannot switch the song during playback; however, you can pre-select the song number. When you select a song number during playback, that number will blink in the display.

When the currently-playing song ends, playback will stop automatically, and the number will remain lit. The newly-selected song will begin playing when you press the PLAY/PAUSE key.

To play back from the beginning of the current position or song

If you press the reset key while the song is playing back, the song will play back from the beginning of the pattern that is assigned to the current position of the song.

To continue playing another a song

( p.71 “Playing back songs in succession”)

Setting the playback tempo

TEMPO 20.0...300.00

Using the dial to set the tempo

Use the [▲]/[▼] cursor keys to select “Tempo” in the display. Turn the dial to adjust the tempo. If you want to make tempo adjustments in units below the decimal point, hold down the shift key while you turn the dial.

Using the tap tempo key to set the tempo

While a song is playing, press the tap key twice or more at the desired tempo. The interval at which you press the key will be detected, and converted into the tempo. You can use this method to set the tempo even when the EMX-1 is paused or stopped.

Locking the tempo of a song

Turn the TEMPO LOCK key on if you want to play back the song at the tempo specified by the song.

If the TEMPO LOCK key is off, the tempo will switch to the value specified by the pattern each time the position changes during song playback. However even if the position changes, the tempo will be maintained if the pattern is the same.



If you use the dial or tap tempo to change the tempo, the tempo setting saved in the song will be changed. If you have changed the tempo and then switch to a different song without writing (saving) the song whose tempo you changed, it will revert to its original tempo. If you want to keep the new tempo setting, you must Write the song.



If you use Event Recording to record tempo events, the tempo data will also be updated by those events. (☞p.72 "Event recording")



You can use the dial or tap key to set the tempo regardless of the Tempo Lock key on/off setting. (☞p.73 "Saving a song")



You can save the on/off state of the Tempo Lock key independently for each song. If you want to save the tempo you modified, perform the Write operation. (☞p.73 "Saving a song")



If you set the MIDI mode "Clock" setting to "EXT", the tempo setting of the song and the tempo events in it will be ignored.

1

2

3

4

5

6

7

8

Creating a song

You can create a song by arranging patterns in the desired order.



If while editing a song, you switch to a different song, the data you had been editing will be lost. If you want to keep the song you edited, you must perform the Write operation. (see p.73 "Saving a song")

Specifying a pattern for each position

POSITION 001...256

PATTERN A01...D64, End

Here's how to specify a pattern for each position. Make sure that the Keyboard function key is off (dark).

1. Use the [▲]/[▼] cursor keys to select "Position" in the display. Notice that the display indicates "001."
2. Press the [▼] cursor key until the display reads "Pattern."
3. Use the dial to select the pattern that you want to assign to position "001."
4. Press the select [▶] key to advance to the next position. The display will indicate "End."
5. Use the dial to select a pattern. The pattern you select here will be the pattern for position "002."
6. When you select a pattern for position "002," the next position will be "End." Continue steps 4 and 5 to input as many patterns as you need.

To play back the completed song from the beginning

Press the PLAY/PAUSE key, and then press the STOP/CANCEL key. Alternatively, use the [▲]/[▼] cursor keys to select "Position" in the display and use the dial or the select keys to set the position to "001," and then press the PLAY/PAUSE key.

You can check the patterns assigned to each position of the song, or change the pattern assigned to a certain position. Call up "Pattern" in the display and use the select keys to move backward or forward through the positions. Use the dial to change the pattern number that is displayed at each position.

Alternatively, when the display reads "Position," you can use the dial or the select keys to choose the position you want to check, and then make the display show "(pattern name)" so that you can check or edit the pattern.

Transposing the pitch of a Pattern for a specific Position

NOTE OFFSET -24...24

This lets you offset the pitch of the synth parts played by the pattern at a particular position of the song.



Note Offset merely adjusts the pitches that are played at that position of the song; it does not change the pitches within the pattern itself.

1. If the song is playing, press the STOP/CANCEL key to stop playback.
2. Use the [▲]/[▼] cursor keys to select "Position" in the display
3. Use the dial or the select keys to select the position where you want to offset the pitch.



4. Use the [▲]/[▼] cursor keys to make the display read "NoteOfs."
5. Use the dial to specify the pitch. A setting of ± 1 offsets the pitch (note) by a semitone, ± 2 by a whole step, ± 7 by a fifth, and ± 12 by one octave.

When the display reads "NoteOfs," you can select a new position by using the select keys to move the position backward or forward, step by step.



If a chord split (≅p.38) wave is selected for a part, the chord or octave may change if you adjust the Note Offset.

1

2

3

4

5

6

7

8

Editing a song

You can edit a song by inserting or deleting patterns. Knob movements and your own performance can also be added to a song.

-  If you want to keep a song that you edited, you must perform the Write operation. If you switch songs or turn off the power without writing, the song will revert to the state prior to editing.

Inserting a pattern

INSERT PATTERN

This operation lets you insert a pattern at the desired position. Subsequent patterns will move toward the end of the song.

1. If the EMX-1 is playing, press the STOP/CANCEL key to stop playback.
2. Hold down the shift key and press step key 9 (INSERT PATTERN). (Key 9 will blink.)
3. Use the dial to select the position at which you want to insert a pattern. For example if you want to insert a pattern at position 3, make the display read "003."
4. Press step key 9 once again to insert one pattern at that position (the key will go dark). If you decide to cancel the operation, press the STOP/CANCEL key.

The pattern that will be inserted will be identical to the pattern (including the note offset setting) that was previously assigned to that position. Now you can change the pattern and note number as necessary. All data following the inserted pattern will be moved one position toward the end of the song.

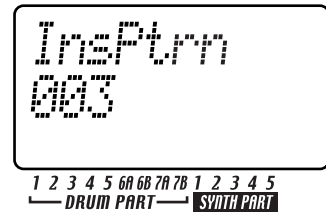

Insert a new pattern at position 3

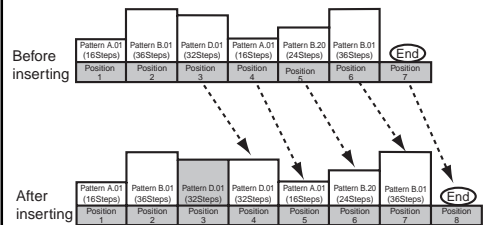

Deleting a pattern

DELETE PATTERN

This operation lets you delete the pattern from a position. Subsequent patterns will move toward the front of the song.

1. If the EMX-1 is playing, press the STOP/CANCEL key to stop playback.
2. Hold down the shift key and press step key 10 (DELETE PATTERN). (Key 10 will blink.)
3. Use the dial to select the position whose pattern you want to delete. For example if you want to delete the pattern at position 5, make the display read "005."
4. Press step key 10 once again to delete that pattern (the key will go dark).

If you decide to cancel the operation, press the STOP/CANCEL key. All data following the deleted pattern will be moved one position toward the beginning of the song.

-  When you delete a pattern, any event data (explained below) that was recorded in that location will also be deleted.

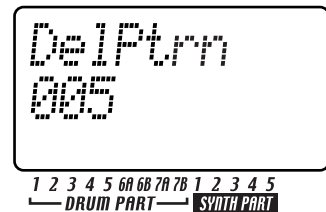

Delete the pattern at position 5

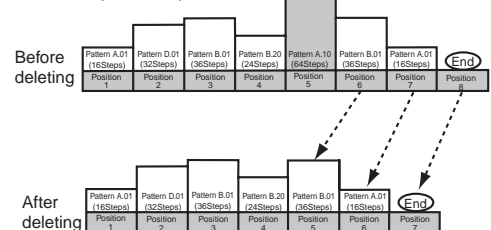

Erasing data from a song

CLEAR SONG

1. If the EMX-1 is playing, press the STOP/CANCEL key to stop playback.
2. Hold down the shift key and press step key 11 (CLEAR SONG). (Key 11 will blink.)
3. Press step key 11 once again to erase the data from the song. If you decide to cancel, press the STOP/CANCEL key.

If you erase song data by accident

Turn the dial to re-select that song without saving it, and you will revert to the data that was previously saved.

Changing the pattern in a specific position

1. If the EMX-1 is playing, press the STOP/CANCEL key to stop playback.
2. Use the [▲]/[▼] cursor keys to select "Position" in the display.
3. Use the dial to select the position whose pattern you want to change.
4. Press the [▼] cursor key until the display reads "Pattern."
5. Use the dial to select the pattern that you want to assign to that position. If you want to listen to the selected pattern to hear whether it is the one you want, press the Pattern mode key to enter Pattern mode, and play it. To return to Song mode, press the STOP/CANCEL key to stop playback and then press the Song mode key.

Maintaining the part mute settings even when the pattern changes

This function makes the song maintain the part mute settings while playback continues.

MUTE HOLD Off, On

1. Press the [▼] cursor key until the parameter display reads "MuteHold."
 2. Turn the dial to make the desired setting.
- Off: The part mute settings specified within each pattern will be applied as the position within the song changes during playback. However if you change the position but the pattern is still the same, the part mute settings will be maintained.
- On: The part mute status will not change even if the position moves to a different pattern. However at the beginning of the song the part mute status will be as specified by the pattern selected for position 1.

Playing back songs in succession

NEXT SONG Off, S.01...S.64

When a song finishes playing, this function immediately continues playback with the next specified song.

1. Press the [▼] cursor key until the parameter display reads "NextSong."
2. Turn the dial to select which song will play back following the current song. If you select Off, playback will stop when the current song finishes playing.



The NEXT SONG setting is ignored when playing back in synchronization with MIDI Clock messages sent from an external device. The EMX-1 will obey Song Select messages [F3, ss] (ss: song number) sent from the external device.

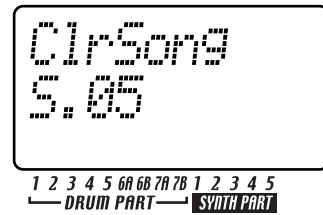

1

2

3

4

5

6

7

8

(⇒p.72 "Event recording")

Event recording

Recording song event data

In addition to letting you arrange patterns to create a song, the EMX-1's Song mode also lets you record your realtime performances using the drum pad keys, the keyboard function, the arpeggiator, and knob operations.

Recording your Song mode performance and operations in this way is referred to as Event Recording.

Event Recording can record the following six types of data (event data).

- Your performance on the drum part keys
- Your performance using the Keyboard function
- Your performance using the arpeggiator
- Your knob movements and key operations (only for the selected part)
- Solo and mute operations for the parts
- Tempo

When using Event Recording, you can record repeatedly over the same region, and layer more of the above-listed data on each "pass" of recording. Event Recording will replace (overwrite) only the previously-existing data that is the same type of event as the newly recorded data. Existing events of other types will remain.

To record using Event Recording

1. Select the song on which you want to use Event Recording.
2. Use the [▲]/[▼] cursor keys to select "Position" in the display.
3. Use the dial or the select keys to move to the position where you want to start recording.
4. Press the REC key, and then press the PLAY/PAUSE key to start Event Recording.
5. Operate the step keys or knobs etc. to record your performance.
6. Press the STOP/CANCEL key to stop Event Recording.



If the performance data of the song conflicts with event data, the event data will be given priority for playback.



Knob movements recorded in Song mode using Event Recording are played back in a way equivalent to the SMOOTH mode of a motion sequence (not TRIG HOLD mode).



If you want to save the data that was recorded by Event Recording, you must perform the Write operation.



Event data may not play back correctly if you rewind the song. If you operate an event-recorded knob during playback, event data of that knob will be cancelled until playback arrives at the next position.

To erase event data from a song

You can erase event data from a song by holding down the SHIFT key and pressing and holding the RESET/ERASE key for the region that you want to erase. All event data in that region will be erased from the song.

To check the event data in a song

When you hold down the SHIFT key and press the MOTION SEQ key of the part common section, step keys 15 and 16 will light if event data is recorded in the song, and the display will indicate "SongEvt" to show the number of events recorded in the currently selected song.



You cannot check event data in this way during playback or recording.

Saving a song

If you want to keep song data that you created, you must perform this Write/Rename operation. If you don't want to keep the song you created, simply switch songs without performing Write/Rename.

 Be aware that when you save a song, the song that had previously occupied the save-destination will be overwritten.

To simply save the song

1. Press the WRITE/RENAME key.
The parameter display will indicate "WriteTo," and the value display will indicate "(the save-destination song number)."
At this time you can press the SHIFT key to change the display from "(the save-destination song number)" to the corresponding "(six characters of the Song name)."

To overwrite onto a different song

- Use the dial to change the song number to the desired save-destination. Be sure to select a song number that does not contain important data you want to keep.
2. Press the WRITE/RENAME key to begin saving. The WRITE/RENAME key will light while the data is being saved, and will go dark when the operation is completed. If you decide to cancel, press the STOP/CANCEL key.
When the data has been saved, the save-destination song number will be selected.

To rename and save the song

1. Hold down the shift key and press the WRITE/RENAME key once (the key will blink). The parameter display will indicate "Rename," and the value display will show "(six characters of the song name)"
2. Assign a name to the song. Use the [▲]/[▼] cursor keys to move the cursor in the value display to the left or right, and turn the dial to edit the character. You can assign a name of up to eight characters to a song, however only six at a time are visible during naming. When you have finished, press the WRITE/RENAME key.
3. Select the song number where you want to save the song. The parameter display will indicate "WriteTo," and the value display will show "(the save-destination song number)." If you now press the shift key, the "(save destination song number)" will change to show "(six characters of the song name)." Turn the dial to select the song number where you want to store the song, and make sure that you will not be overwriting an important song that you want to keep.
4. Press the WRITE/RENAME key once again to begin saving the data. The key will light while the data is being saved, and will go dark when saving is completed. If you decide to cancel, press the STOP/CANCEL key.

 With the factory settings, the Memory Protect setting is turned on, so the data will not be saved. Turn the Global mode Memory Protect setting off before you execute this operation (→p.75 "Protecting the data in memory").

 Never turn off the power while data is being saved to memory (i.e., while the WRITE/RENAME key is lit). Doing so can destroy the data.



1

2

3

4

5

6

7

8



6. Global mode

In Global mode you can set parameters such as metronome settings, overall tuning, memory protect, etc. To enter Global mode, press the GLOBAL key. To exit Global mode, press a different mode key.

-  If you turn off the power without writing the settings you make in Global mode, your changes will be discarded. If you want to keep the changes you made, perform the Write operation (see p.76 "Saving your Global mode settings").

Setting the metronome

These controls allow you to specify how the metronome will operate. The metronome is convenient when you are using realtime recording to create patterns.

The metronome will sound at quarter-note intervals. Except for when you have selected the "On→3/4" setting, the sound of metronome is output from line out jacks L/R and from the headphone jack, mixed with the sound of the EMX-1's playback and audio input.

1. Press the [▲] key until the parameter display reads "Metronom."

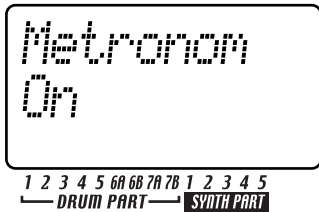

2. Turn the dial to make the desired metronome setting.

-  You cannot write the metronome setting. When the power is turned on, it will always be "Off."

METRONOME [Off, Rec0, Rec1, Rec2, On, On→3/4]



Off	The metronome will not sound.
Rec0	The metronome will sound only during recording (when REC and PLAY/CANCEL keys are lit)
Rec1	When you start recording, there will be a one-measure count before recording actually begins. The metronome will sound only during recording.
Rec2	When you start recording, there will be a two-measure count before recording actually begins. The metronome will sound only during recording.
On	The metronome will sound during playback or recording. There will be no count before recording begins.
On→3/4	During playback or recording, the metronome will be output from individual out jacks 3/4. (The metronome will not be output from the line out L/R jacks or the headphone jack.) There will be no count before recording begins.

Matching the tuning with another instrument

You can adjust the basic tuning of the EMX-1 in steps of one cent. Normally you will leave this set at "+00" (A=440 Hz). Adjust this setting if you need to match the pitch of the EMX-1 to another instrument.

Use the [▲]/[▼] cursor keys to select "MstTune" in the parameter display. Turn the dial to make the desired setting.

MASTER TUNE -50...+50

-  This value will be changed by MIDI Master Fine Tune messages received from an external device.
-  The pitch of drum parts will not change.

Protecting the data in memory

This setting lets you protect the Pattern mode and Song mode data.

Use the [▲]/[▼] cursor keys to select "Protect" in the parameter display. Turn the dial to select Off or On.

PROTECT Off, On

On	The WRITE/RENAME key will be disabled, and it will be impossible to rewrite data or receive MIDI data dumps.
Off	Edited data can be saved, and data dumps can be received.

-  With the factory settings this is turned On. The memory protect setting applies to Pattern mode, Part Edit mode, Step Edit mode, and Song mode. However, you can write your settings in Global mode and MIDI mode regardless of the memory protect setting.

Exchanging the arpeggiator functions

This setting switch the functions of the arpeggiator slider and ribbon controller.

1. Press the [▼] cursor until the display reads "ArpCntrl."
2. Turn the dial to select "Normal" or "Revers"
3. Press the Pattern key or Song key etc. to return to the previous mode.

ARP CONTROL Normal, Revers

Normal	Slider: Pitch control (synth parts) Ribbon: Gate time (synth parts) / Resolution (drum parts) + Note-on
Revers	Slider: Gate time (synth parts) / Resolution (drum parts) Ribbon: Pitch control (synth parts) + Note-on

1

2

3

4

5

6



7

8

Saving your Global mode settings

Here's how to save the settings you made in Global mode and MIDI mode. If you want to keep the changes you made, you must execute the Write operation described below. The settings you save will take effect each time you turn on the power. If you don't want to keep the changes you made, simply turn off the power without executing Write.

1. Press the Global mode or MIDI mode key.
2. Press the WRITE/RENAME key once (the key will blink). The display will ask "GloblWr?" Use the dial to select "Yes," and press the WRITE/RENAME key once again to begin saving the data. While the data is being saved, the WRITE/RENAME key will light, and will go dark when saving is completed. If you decide to cancel, select "No" or press the STOP/CANCEL key.

-  You can write Global mode and MIDI mode settings regardless of the Memory Protect setting (see above).
-  Never turn off the power while data is being saved to memory (i.e., while the WRITE/RENAME key is lit). Doing so can destroy the data.

Using SmartMedia™

You can use a SmartMedia card to save or load the EMX-1's internal data.

The EMX-1 uses 3V (3.3V) SmartMedia in a range of 4 MB–128 MB capacity.

Make sure that the SmartMedia card is oriented in the correct direction, and insert it all the way into the SmartMedia slot.

* SmartMedia™ is a registered trademark of Toshiba Corporation.

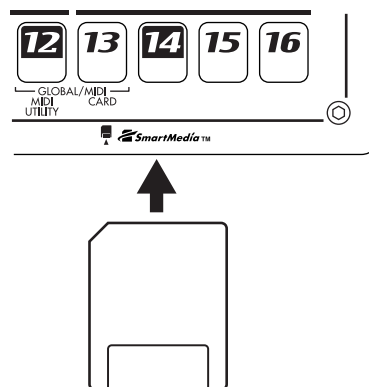

-  Never remove the card or turn off the power while the SmartMedia card is being accessed (while the card indicator is lit). Doing so may damage the card.

About cards

The EMX-1 supports 3.3V SmartMedia (or SmartMedia with ID) in a range of 4–128 MB capacities. Never use any other type of SmartMedia; the EMX-1 may stop operating if you do. If you affix a write protect label (the round silver label) to the SmartMedia, it will not be possible to write or erase the data on that card. If you want to save data by writing it to SmartMedia, you must remove the write protect label.

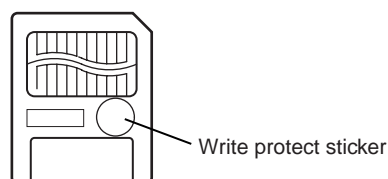

Handling precautions

- Do not bend the card, or subject it to strong impact or high temperature.
- Do not touch the electrical contacts of the card. Static charges may damage the card. When you are finished using a card, store it in its special anti-static case.

Formatting SmartMedia

Here's how to format a SmartMedia card so that it can be used by the EMX-1.

 Formatting will erase the entire contents of the SmartMedia.

1. Insert the SmartMedia into the SmartMedia slot.
2. Press the GLOBAL key (it will light).
3. Hold down the SHIFT key and press step key 13 (CARD). (Key 13 will blink.) The parameter display will read "CardMenu."
4. Turn the dial to make the value display read "Format," and press step key 13.

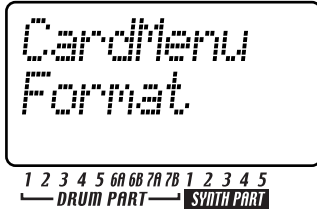

5. The parameter display will ask "Sure?" Turn the dial until the value display reads "Yes," and then press key 13 to execute formatting. If you decide to cancel, press the STOP/CANCEL key.

note While the card is being formatted, the step keys will indicate the state of progress.

6. When formatting is complete, or if you selected "No" and pressed key 13, you will return to the display prior to formatting. (Key 13 will go dark.)

 SmartMedia that was formatted on a device other than the EMX-1 may not be recognized correctly. In this case, re-format it on the EMX-1.

Saving data to SmartMedia (Save All)

Here's how you can save all of the EMX-1's pattern data, song data, and global data onto SmartMedia.

1. Insert the SmartMedia into the SmartMedia slot.
2. Press the GLOBAL key. (It will light.)
3. Hold down the Shift key and press step key 13 (CARD) (key 13 will blink). The parameter display will indicate "CardMenu."
4. The value display will indicate "Load." Turn the dial until this indicates "SaveAll," and press key 13.

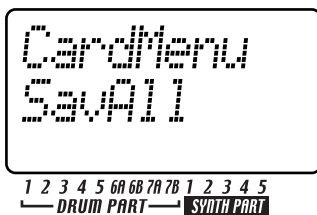



5. Assign a name to the file that you are going to save. The parameter display will indicate "Rename," and the value display will show the current data name. Use the [▲]/[▼] cursor keys to move the cursor left/right in the value display, and turn the dial to edit the character. When you are finished, press key 13.

The parameter display will ask "Sure?" and the value display will read "No." Turn the dial to change this to "Yes" and press key 13 to execute the Save operation. While the data is being saved, the step keys will indicate the state of progress. If you decide to cancel, press the STOP/CANCEL key.

 If an identically-named user file already exists on the SmartMedia, the parameter display will ask "OverWrt?" and the value display will read "No." If you turn the dial to select "Yes" and press key 13 to overwrite the data, the data that was originally on the SmartMedia will be lost, so please use caution.

 If a file or folder of the same name as the file you renamed already exists on the SmartMedia, the parameter display will indicate "FileName" and the value display will indicate "Error." Either use your computer to erase the file or folder from the SmartMedia, or change the name of the file you are attempting to save, and try again.

 You cannot save data on SmartMedia if a write-protect label is affixed to it. Remove the write protect label from the SmartMedia before you execute the Save operation.

 Never turn off the power or remove the SmartMedia while saving or formatting. Doing so may render the SmartMedia unusable.

 You will need approximately 2 megabytes of space to save one file. You cannot save data to a SmartMedia card that has less free space than this.

Loading all data from SmartMedia into the EMX-1

Here's how you can load pattern data, song data, and global data from SmartMedia into the EMX-1.

1. Insert the SmartMedia card into the SmartMedia slot.
2. Press the GLOBAL key. (It will light.)
3. Hold down the Shift key and press step key 13 (CARD) (key 13 will blink). The parameter display will indicate "CardMenu."
4. The value display will indicate "Load." Press key 13.



1

2

3

4

5

6

7

8

- The parameter display will indicate "Load" and the value display will indicate "All" Press key 13.

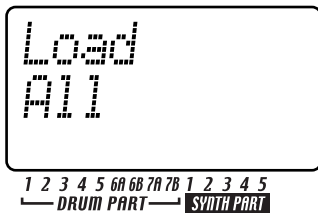

- Select the file that you want to load. The value display will indicate "LdFile," and the parameter display will show "(six characters of the filename)." Turn the dial to select the desired file, and press key 13.
- The parameter display will ask "Sure?" and the value display will read "No." Turn the dial to change this to "Yes," and press key 13 to execute the Load operation. While the data is being loaded, the step keys will indicate the state of progress. When loading is completed, the EMX-1 will enter Pattern mode with A01 selected. If you decide to cancel, press the STOP/CANCEL key.

- With the factory settings, memory protect is turned on, so you will not be able to execute this operation. Turn memory protect off before you execute the Load operation (see p.76 "Saving your Global mode settings").

Loading a single pattern from SmartMedia (Load Pattern)

- Insert the SmartMedia card into the SmartMedia slot.
- Press the GLOBAL key. (It will light.)
- Hold down the Shift key and press step key 13 (CARD) (key 13 will blink). The parameter display will indicate "CardMenu."
- The value display will indicate "Load." Press key 13.
- The parameter display will indicate "Load" and the value display will indicate "All." Turn the dial to select "1Ptrn" and then press key 13.

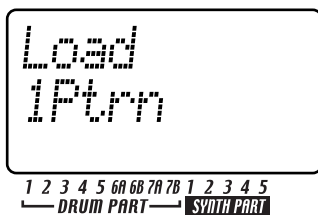

- Select the file (the filename you specified for Save All) that contains the pattern you want to load. The value display will indicate "LdFile" and the parameter display will show "(six characters of the filename)." Turn the dial to select the desired file, and then press key 13.
- Select the pattern that you want to load. The parameter display will indicate "Load" and the value display will show the "(pattern number)" (you can hold down the shift key to display the pattern name instead). Turn the dial to select the desired pattern, and press key 13 to load it.

When loading is completed, you will return to Pattern mode (key 13 will go dark, and the PATTERN key will light).

If you decide to cancel, press the STOP/CANCEL key.

- Be aware that this procedure does not save (write) the pattern into internal memory.
- With the factory settings, memory protect is turned on, so you will not be able to save data. Turn memory protect off before you execute the Write operation (see p.76 "Saving your Global mode settings").

Deleting an EMX-1 file from SmartMedia (Delete File)

Here's how a user file containing EMX-1 pattern data, song data, and global can be deleted from a SmartMedia card.

- Once a file has been deleted, it cannot be read again.

- Insert the SmartMedia card into the SmartMedia slot.
- Press the GLOBAL key. (It will light.)
- Hold down the Shift key and press step key 13 (CARD) (key 13 will blink). The parameter display will indicate "CardMenu."
- The value display will indicate "Load." Turn the dial to select "Delete" and then press key 13.
- Select the user file that you want to delete. The value display will indicate "DelDMX" and the parameter display will show "(six characters of the filename)." Turn the dial to select the file, and then press key 13.

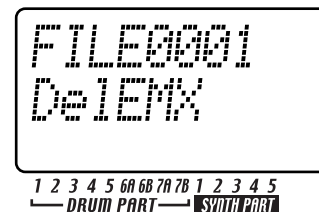

- The parameter display will ask "Sure?" and the value display will read "No." Turn the dial to change this to "Yes" and press key 13 to execute the Delete operation. While the file is being deleted, the step keys will indicate the state of progress.

- Only EMX-1 user files can be deleted by the EMX-1.

7. MIDI mode

In this mode you can set the MIDI channel, clock, and pitch bend range.

 If you want to save the settings you make in MIDI mode, you must perform the Write operation (see p.76 "Saving your Global mode settings").

About MIDI channels

Just as a television set receives only the program that is being broadcast on the channel to which it is set, a MIDI device receives only the data that is being transmitted on the channel it is set to receive. The MIDI mode MIDI Ch setting lets you set the EMX-1's transmit/receive channel independently for each synth part 1-5 and collectively for all drum parts together.

The MIDI channel for synth part 1 that you specify here will also be used to transmit and receive program changes and exclusive data ("Global MIDI channel").

Part	Channel
Synth part 1(global)	1
Synth parts 2-5	2-5
Drum parts (1-7B)	10

Using the EMX-1 as a sound module

Use a MIDI cable to connect the MIDI OUT connector of your MIDI keyboard etc. to the EMX-1's MIDI IN connector.

1. Press the MIDI key (it will light).
2. Use the [▲]/[▼] cursor keys to select "MIDI ch" in the display
3. Press the EMX-1's synth part 1 Part key, and then turn the dial to set the MIDI channel for part 1 to match the channel being transmitted by the connected MIDI keyboard or other device. (see "Setting the MIDI channel of each part")
4. When you play the connected MIDI keyboard etc., you will hear synth part 1.

If you connect a multi-track MIDI sequencer to the EMX-1 you will need to set the MIDI channel for synth parts 1-5 and for the drum parts (see "Setting the MIDI channel of each part"). Set each part to the MIDI channel of the sequencer track you want that part to play, and start your external sequencer to hear the sounds.

Setting the MIDI channel of each part

MIDI ch 1...16
 Here you can set the MIDI channel for each synth part and for the drum parts. The same MIDI channel is used for transmission and reception. The factory settings are as follows.

1. Press the MIDI key (it will light).
2. Use the [▲]/[▼] cursor keys to change the display to read "MIDI ch."
3. Press the part key for which you want to change the MIDI channel (the key will light). To change the MIDI channel for the drum parts, press any of the nine part keys (all of the drum part keys will light).
4. Turn the dial to select the channel.



MIDI Utility

Here you can make MIDI filter settings, assign drum note numbers, assign control change numbers, and transmit/receive MIDI data.

Making MIDI filter settings

MIDI FILTER
You can select which MIDI messages the EMX-1 will receive and transmit.

1. Press the MIDI key.
2. Hold down the shift key and press step key 12 (MIDI UTILITY) (key 12 will blink). The parameter display will indicate "MIDI Util."
3. Make sure that the value display indicates "Filter," and press key 12.

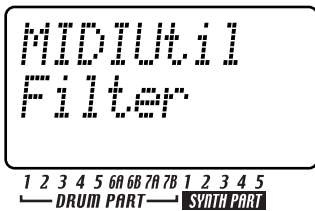

4. The parameter display will read "PCEN."

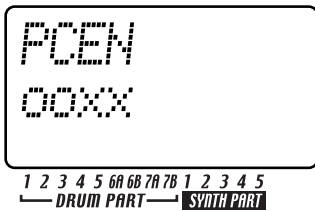

The characters "PCEN" correspond to four types of message whose status is indicated by an "O" or "X" in the value display. If you want a category of message to be transmitted/received, set its status to "O." If you don't want that category of message to be transmitted/received, set its status to "X." Turn the dial to select "O" or "X" for each category of message.

- P: Program change, bank select, and song select transmission/reception.
 - C: Control change transmission/reception.
 - E: Exclusive data transmission/reception. However while the MIDI Dump page is displayed, this data can always be received regardless of this setting.
 - N: Note message transmission/reception.
5. When you have finished making settings, press the 12 key to return to MIDI mode. (Key 12 will go dark and the MIDI mode key will light.) If you decide to cancel, press the STOP/CANCEL key or press a mode key.

Assigning the drum note numbers

DRUM NOTE NO. C-1...G9

You can assign a MIDI note number (as a note name) for each drum part. If you assign the same note number for two or more parts, those parts will sound simultaneously when controlled from an external MIDI device.

1. Press the MIDI key.
2. Hold down the shift key and press step key 12 (MIDI UTILITY) (key 12 will blink). The parameter display will indicate "MIDI Util."
3. The value display will indicate "Filter." Turn the dial to change this to "DrNote," and press key 12.



4. Press the drum part key whose note number you want to assign.
5. The parameter display will show the name of the selected drum part, and the value display will indicate the corresponding number.

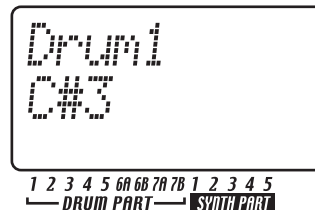



Turn the dial to select the desired note number. For each drum part that you want to assign, repeat the steps of selecting the drum part and then selecting a note number.

6. When you have finished making settings, press key 12 to return to MIDI mode. (Key 12 will go dark and the MIDI mode key will light.) If you decide to cancel, press the STOP/CANCEL key or press a mode key.

With the factory settings, the drum note numbers are assigned as follows.

Part	Note
Drum1	C2
Drum2	D2
Drum3	E2
Drum4	F2
Drum5	G2
Drum6A	F#2
Drum6B	A#2
Drum7A	C#3
Drum7B	D#3

 The correspondence between note names and note numbers may differ for devices of different manufacturers. Please check this correspondence for the device you are connecting.

 Each drum part knob can be edited using NRPN MIDI messages.

About note-on/note-off

When you press a drum part key, a note-on message of the note number assigned to each drum part key will be transmitted on the specified MIDI channel.

When you use the Keyboard function to play the step keys, a note-on message [9n, kk, vv] (n: channel, kk: note number, vv: velocity) of the note number assigned to each step key and a velocity value corresponding to the strength with which you pressed the key will be transmitted.

On the EMX-1, the vv:velocity value is adjusted by the level of each accent part. When you release a key, a note-off message [8n, kk, vv] will be transmitted. However, very few devices receive note-off velocity data, and the EMX-1 does not transmit it. When the EMX-1 receives note-on/off messages on the MIDI channel assigned for a part, that part will be sounded.

If the EMX-1's MIDI filter "N" setting is set to "x," note-on/off messages will not be transmitted or received. (p.80 "Making MIDI filter settings")

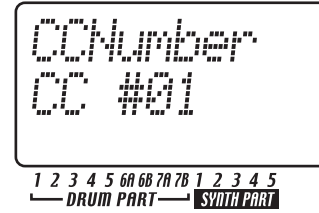

- Press step key 12 and the display will ask "Continue?" If you want to make settings for another knob, use the dial to select "Yes" and press step key 12. Then repeat steps 4 and 5.

If you are finished making settings, use the dial to select "No" and press step key 12 to return to MIDI mode.

If you decide to cancel, press the STOP/CANCEL key or press any mode key.

- Support for control change numbers will be different for each manufacturer. Refer to the manual of the device you want to connect.

Assigning a MIDI Control Change Number to a knob

#CC ASSIGN CC#000...127

You can specify the MIDI control change number assigned to each knob.

- Press the MIDI key.
- Hold down the SHIFT key and press step key 12 (MIDI UTILITY). (Key 12 will blink.) The parameter display will indicate "MIDIUtil."
- Turn the dial to change the value display to "CCAsin," and press key 12.

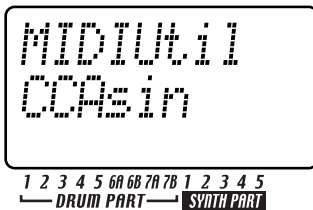

- The parameter display will read "CCAssign," and the value display will show "(the name of the corresponding knob)." Turn the dial to select the knob whose assignment you want to change, and press key 12.



- The parameter display will read "CCNumber," and the value display will show "(a control change number)." Turn the knob to select the desired control change number and press key 12.

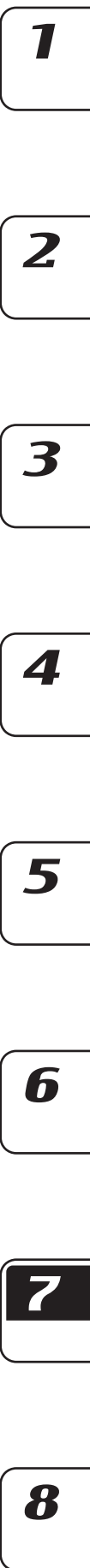

Transmitting sound settings and other data

Song, pattern, global, and MIDI settings can be transmitted from the EMX-1 as MIDI exclusive data and stored on an external device.

Transmitting/receiving a data dump

Data dumps are transmitted and received on the MIDI channel specified by the MIDI mode MIDI Ch setting. Data dumps can be transmitted manually as described below, and are also transmitted in response to a Data Dump Request message of the appropriate type.

MIDI DUMP PtBnkA...D, AllSng, Global

Transmission

Here's how to transmit an EMX-1 system exclusive data dump (pattern, song, or global mode settings) from MIDI OUT to a connected MIDI data filer or computer.

1. Connect the EMX-1's MIDI OUT connector to the MIDI IN connector of an external MIDI device that is able to receive the MIDI data dump (e.g., another EMX-1, a MIDI data filer, or a personal computer that is running a MIDI data management program).
2. Set your external MIDI device and the EMX-1 to the same MIDI channel. If you are transmitting to a MIDI data filer, you do not normally need to set the MIDI channel to match.
3. Press the MIDI key (the key will light).
4. Hold down the shift key and press step key 12 (MIDI UTILITY) (key 12 will light). The parameter display will indicate "MIDIUtil."
5. The value display will indicate "Filter." Turn the dial to change this to "Dump," and press key 12.
6. The parameter display will indicate "MIDI Dump." The value display will read "(data to be transmitted)." Turn the dial to select the data that you want to transmit.

PtBnkA: pattern bank A data (A01...64)
 PtBnkB: pattern bank B data (B01...64)
 PtBnkC: pattern bank C data (C01...64)
 PtBnkD: pattern bank D data (D01...64)
 AllSng: all song data
 Global: global data

7. Press key 12 once again to transmit the data. If you decide to cancel before you have begun transmission, press the STOP/CANCEL key.

Reception

Here's how to receive an EMX-1 system exclusive data dump from an external MIDI data filer or computer connected to the EMX-1's MIDI IN connector.

-  If the Global mode Protect setting is "On," MIDI data dump reception is disabled except when you are in Global mode.

1. Connect the MIDI OUT connector of the external MIDI device that will transmit the data dump (another EMX-1, a MIDI data filer, or a personal computer that is running a MIDI data management program) to the MIDI IN connector of the EMX-1.
2. Set your external MIDI device and the EMX-1 to the same MIDI channel (the synth part 1 setting on the EMX-1). If you are transmitting data from a data filer, use the same channel setting as when you saved the data.
3. Press the MIDI key or the GLOBAL key (the key will light).
4. Hold down the shift key and press step key 12 (MIDI UTILITY) (key 12 will light). The parameter display will indicate "MIDIUtil."
5. The value display will indicate "Filter." Turn the dial to change this to "Dump," and then press key 12.
6. The parameter display will indicate "MIDI Dump." Operate the external device to make it transmit the data dump to the EMX-1.

 For details on data dumps, refer to the EMX-1's MIDI implementation. If you wish to obtain the MIDI implementation, please contact Korg distributor.

 Do not touch the EMX-1's keys while a data dump is being executed. While you are using the Dump function, the EMX-1 can transmit or receive system exclusive data even if the MIDI FILTER parameter "E" is set to "x."

 When the EMX-1 receives a data dump, it will take up to ten seconds for the data to be written into memory (the Write/Rename key will light). Never turn off the EMX-1's power while this is occurring. Doing so may destroy the data. Also, new MIDI data cannot be received during this time. When receiving two or more data dumps into the EMX-1, you must allow an appropriate interval of time between each data dump.

Switching patterns

When you switch patterns, the EMX-1 will transmit a program change message [Cn, pp] (and Bank Select [Bn, 00, mm] (control change #00), [Bn, 20, bb] (control change #32) (mm: bank number upper byte, bb: bank number lower byte). If the EMX-1 receives a program change message on the appropriate MIDI channel, it will switch patterns within the same group (e.g., from A01 to A02). If the EMX-1 receives a bank select message, it will switch groups (e.g., from A01 to C01) so that patterns of another group can be selected. The MIDI mode MIDI Filter setting determines whether the EMX-1 will transmit and receive program changes.

Bank select		Program change	Pattern number
MSB	LSB		
00	00	0-127	A01-B64
00	01	0-127	C01-D64

Setting the pitch bend range

When the EMX-1 receives a pitch bend message [En, vv, vv] (vv, vv: lower and upper bytes of the value, together expressing a range of 16384 steps with 8192 [vv,vv=00H, 40H]), pitch bend will be applied to the synth part receiving on that channel. The bend range setting described below specifies the amount of pitch change that will actually occur in response to MIDI pitch bend messages.

Setting the pitch bend range

BEND RANGE -12...12

Here's how to specify the maximum amount of pitch change that can occur when a MIDI pitch bend message is received.

1. Press the MIDI key (the key will light).
2. Press the [▼] key to change the display to read "BendRnge."
3. Turn the dial to select the range of pitch change. A setting of ± 1 allows a semitone of change, ± 2 a whole step, ± 7 a fifth, and ± 12 one octave. For some sounds, it may not be possible to raise the pitch all the way in the specified range.

Synchronizing playback with an external MIDI device

You can synchronize the tempo of the EMX-1 to the tempo of an external MIDI device that is able to send or receive MIDI clock data.

For details on synchronization settings on your external MIDI device, refer to the manual for that device.

 We recommend that you use the EMX-1 as the master.

CLOCK Int, Ext, Auto

- Int: The EMX-1 will be the master; the external MIDI device will synchronize to it.
- Ext: The external MIDI device will be the master; the EMX-1 will synchronize to it.
- Auto: If MIDI clock messages are being received from a connected external MIDI device, the EMX-1 will automatically operate with the "Ext" setting. Otherwise it will operate with the "Int" setting.

To use the EMX-1 as the master, and synchronize an external MIDI device to it

1. Use a MIDI cable to connect the EMX-1's MIDI OUT connector to the MIDI IN connector of your external MIDI device (e.g., sequencer or sound module).
2. Press the MIDI key (it will light).
3. Press the [▲] cursor key to change the display to read "Clock."
4. Turn the dial to select "Int" (internal clock).

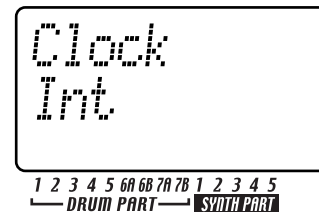

5. Make settings on your external MIDI device (slave) so that it will receive MIDI clock messages.
6. When you start playback on the EMX-1, the external MIDI device will operate in synchronization with it.

 When you use RESET/PLAY to play back from the beginning of the pattern, only the MIDI Start message will be transmitted.

To use the external MIDI device as the master, and synchronize the EMX-1 to it

1. Use a MIDI cable to connect the EMX-1's MIDI IN connector to the MIDI OUT connector of your external MIDI device (e.g., sequencer or synthesizer).
2. Press the MIDI key (it will light).
3. Press the [▲] cursor key to change the display to read "Clock."
4. Turn the dial to select "Ext" (external clock).

1

2

3

4

5

6

7

8

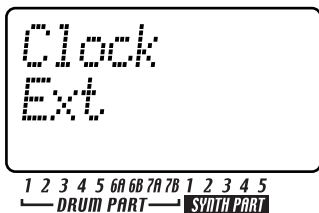

5. Make settings on your external MIDI device (master) so that it will transmit MIDI clock messages.
6. Return to Pattern mode or Song mode.
7. When you start the sequencer of your external MIDI device, the EMX-1 will playback in synchronization with it.

If MIDI clock messages are being received at the MIDI IN connector, you can press the EMX-1's PLAY/PAUSE key to make it start playing in synchronization to the tempo of your external MIDI device.

 If the EMX-1's MIDI Clock setting is "Ext" or "Auto" and it is synchronized to an external MIDI clock, it will follow the tempo of the external sequencer; you will be unable to adjust the tempo on the EMX-1.

If the EMX-1 receives a MIDI Start message while synchronized to MIDI clock, it will begin playing from the beginning of the currently-playing pattern (in the case of a song, the beginning of the pattern that was playing when the Start message was received).

Playing back in sync with other Electribe models

You can enjoy even greater possibilities by playing the EMX-1 in sync with other models in the Electribe series such as the Electribe-S (ES-1) or M (EM-1).

To make the ES-1 play in synchronization to the tempo of the EMX-1

Use a MIDI cable to connect the EMX-1's MIDI OUT connector to the ES-1's MIDI IN connector. Use audio cables to connect the ES-1's line output jacks to your mixer or powered monitor system (amplified speakers).

1. Press the MIDI key (it will light).
2. Press the [▲] cursor key to change the display to read "Clock."
3. Turn the dial of each device to set the EMX-1 to "Int" and the ES-1 to "Ext."
4. Press the EMX-1's PLAY/PAUSE key to start the pattern or song (the PLAY/PAUSE key will light). The ES-1 will play in sync with the EMX-1's tempo.

 If the MIDI channel of one of the EMX-1's parts matches the ES-1's MIDI channel, the ES-1 may sound in unison with the EMX-1. If this occurs, change the MIDI channel settings so that they do not conflict.

To make the EMX-1 and ES-1 play back the identically-numbered pattern in synchronization

1. Press the MIDI key (it will light).
2. Press the [▲] key to change the display to read "Clock."
3. Set the EMX-1 to "Int" (master) and the ES-1 to "Ext" (slave).
4. Set the EMX-1's synth part 1 and the ES-1 to the same MIDI channel.
For example, set both to "01".
5. Set the EMX-1's MIDI Filter parameter "P" to "O". Set the EMX-1's MIDI Filter parameter "N" to "X".

About the MIDI messages used for synchronization

The MIDI messages used for synchronization (Realtime Messages) are Timing Clock [F8], Start [FA], Continue [FB], and Stop [FC].

Only one master device (e.g., sequencer) in the connected system can transmit these messages; the remaining slaved devices (sequencers) will receive these messages.

Timing Clock

The slave device calculates its own tempo according to the Timing Clock messages it receives from the master device. Twenty-four Timing Clock messages are transmitted during each quarter note.

If you set the EMX-1's MIDI mode CLOCK setting to "Auto," it will act as a slave (it will receive Realtime Messages). However if the EMX-1 is not receiving any Timing Clock messages, it will operate according to its own internal clock even with the "Auto" setting.

Start

The Start message tells the slave device when to begin playing. A Start message is transmitted when you press the PLAY/PAUSE key. When a slave device receives the Start message, it will begin playing from the beginning in synchronization with the incoming Timing Clock messages.

Continue, Stop

If you press the START/PAUSE key on the master device while it is paused, the master device will transmit a Continue message. When a slave device receives the Continue message, it will resume playback from the location at which it is currently stopped. If you press the STOP key during playback, the master will transmit a Stop message. When a slave device receives the Stop message, it will stop playback.

About synchronization in Song mode

In Song mode, the EMX-1 will also transmit Song Select and Song Position Pointer messages.

Song Select

When you switch songs, a Song Select message [F3, ss] (ss: song number) will be transmitted. On the EMX-1 you can select 64 songs. If the EMX-1 receives a Song Select message when in Song mode, it will switch songs.

You can use the MIDI mode MIDI Filter settings to enable/disable transmission and reception of Song Select messages.

Song Position Pointer

If you change the song position of the master device (clock set to "Int") while the song is stopped, it will transmit a Song Position Pointer message [F2, pp, pp] (pp, pp: lower and upper bytes of the value; pp: the number of MIDI beats from the beginning (number of timing clocks / 6)).

The Song Position Pointer message indicates the location at which the sequencer is currently stopped. If the slave (clock set to "Ext" or "Auto") receives a Song Position Pointer message in Song mode, it will change its own current location (i.e., the location at which its currently selected song is stopped) to the same location as the master.

On the EMX-1 however, the length will differ for each pattern, so the master and slave will not necessarily be located at the same position.

If you change the position on the master device to make it transmit a Song Position Pointer message, and then press its START/PAUSE key, a Continue message (or a Start message if the position is 001) will be transmitted, and the song will begin playing.

If a slave receives a Continue message, it will begin playback (in synchronization to the incoming Timing Clock) from the position indicated by the Song Position Pointer message it received. This lets you playback in synchronization from the desired location in the song, just as when playing back in synchronization from the beginning.

 Song Position Pointer messages are not transmitted when you use the dial or the select keys to fast-forward or rewind during playback.

 Be aware that if you perform such operations during synchronized playback, synchronization will be lost. Also, the playback location will not change if a Song Position Pointer message is received during playback.

Editing sounds

By using MIDI exclusive data dumps you can edit all patterns or one pattern at a time. You can also use NRPN messages to edit the knobs that are valid for each part.

Editing via NRPN

NRPN (Non-Registered Parameter Number) messages are a type of message that can be freely used by any manufacturer to control the assigned parameter number. On the EMX-1, you can use control change messages to edit synth part parameters or effect section parameters, but NRPN messages are assigned to the drum parts.

To edit a drum part parameter, use NRPN (LSB) [Bn, 62, rr] and NRPN (MSB) [Bn, 63, mm] (control change #98 and 99) (rr, mm: lower and upper bytes of the parameter number) to select the desired parameter. Then use data entry (MSB) [Bn, 06, mm] and data entry (LSB) [Bn, 26, vv] (control change #6 and 38) (mm, vv: upper and lower bytes of the value, together expressing a range of 16,384 steps) to set the value.

About system exclusive messages

Since the way in which system exclusive messages are used is left completely up to the manufacturer, these messages are used mainly to transmit or receive sound parameters or editing data that is specific to a particular device. The EMX-1's system exclusive message format is [F0, 42, 3n, 69, ff, ... F7].

F0: exclusive status
42: Korg ID
3n: [n=0~F] global MIDI channel 1~16
69: the EMX-1's model ID
ff: function ID (type of message)
...
F7: end of exclusive

 Some USB-MIDI interfaces are unable to transmit or receive the EMX-1's MIDI exclusive messages.

Universal system exclusive messages

There is a special category of system exclusive message whose uses are publicly defined. These are called Universal System Exclusive messages.

The EMX-1 implements the following Universal System Exclusive messages.

—Inquiry Message Request [F0, 7E, nn, 06, 01, F7]
—Inquiry Message [F7, 7E, nn, 06, 02, (9 bytes), F7]
When the EMX-1 receives an Inquiry Message Request, it will respond by transmitting an Inquiry Message with the meaning of 'I am a Korg EMX-1 with system version ...'

- Master Fine Tuning [F0, 7F, nn, 04, 03, vv, mm, F7] (A value of 8, 192 [mm, vv=40,00] is the center position, a value of 4,096 [mm, vv=20,00] is -50 cents, and 12,288 [mm, vv=60,00] is +50 cents.)
If the EMX-1 receives this message, its "Master Tune" setting (p.75) will be adjusted.

 If you wish to obtain the "MIDI Implementation" which includes information on the MIDI Exclusive format, please contact Korg distributor.

1

2

3

4

5

6

7

8

8. Appendix

Troubleshooting

Nothing appears in the display when I press the POWER switch!

- [] Is the AC/AC power supply connected?
- [] Is the AC/AC power supply plugged into the wall?

No sound!

- [] Are your amp, mixer, or headphones connected to the correct jacks? (Can you play patterns? If so, the connections are OK.)
- [] Are you amp and/or mixer turned on, and set correctly?
- [] Is the EMX-1's master volume knob turned up?

Sound does not stop!

- [] If for some reason the sound will not stop, you can switch between Pattern mode and Song mode to stop the sound.
- [] If a note is "stuck" when you are playing the EMX-1 via MIDI, hold down the SHIFT key and press the STOP/CANCEL key to perform a MIDI Reset.
- [] When playing a pattern, the selected pattern will continue repeating. When you have finished listening to it, press the STOP/CANCEL key. (☞p.19)

The sound or operation is not the way I edited it!

- [] Did you execute the Write operation after editing? (☞p.64, 73)
After editing, you must execute the Write operation before switching songs or patterns, or before turning the power off.

Can't control the EMX-1 via MIDI!

- [] Is the MIDI cable connected correctly?

— When playing the EMX-1 from an external device

- [] Is the EMX-1 set to receive MIDI data on the channel that the external device is transmitting? (☞p.79)
- [] Is the MIDI mode MIDI Channel parameter set to the channel you want to use? (☞p.79)
- [] Are the MIDI mode MIDI Filter settings appropriate? (☞p.80)

— When playing an external device from the EMX-1

- [] Is the EMX-1 set to transmit MIDI data on the channel that the external device is receiving? (☞p.79)
- [] Are the MIDI mode MIDI Filter settings appropriate? (☞p.80)

Can't write a pattern or song!

- [] The Global mode Memory Protect setting may be turned "On." (☞p.75)

Pressing the step keys doesn't play the specified sound!

- [] Did you perform the Write operation after editing the sound of the part?
- [] Is the Keyboard switch turned on?
- [] Is a motion sequencer operating? (☞p.58)

Can't use SmartMedia™!

- [] Could the SmartMedia™ have been formatted on a device other than the EMX-1?
→ If the SmartMedia™ was formatted on a computer or digital camera, you must format it on the EMX-1 before use. (☞p.77)
- [] Is the SmartMedia™ inserted correctly?
→ Turn off the power and re-insert the SmartMedia™ correctly. (☞p.76)

Sound is distorted!

- [] Is the TUBE GAIN knob set to the minimum position?
- [] The DRIVE knob of the synth part controls the amount of distortion. (☞p.32)

1

2

3

4

5

6

7

8

Error messages

If an error message is displayed, you can clear it by pressing the STOP/CANCEL key.

Card Fmt

The SmartMedia™ could not be read.

- Use your computer or other device to back up the data on the SmartMedia™ card. Then format the SmartMedia™ on the EMX-1, rewrite the desired files to it, and access it once again from the EMX-1.

CardFull

There is insufficient free space in the EMX-1 or on SmartMedia™.

- If you want to save data, you must delete unneeded files from the SmartMedia™ card to create sufficient free space. Then write or save the data. The SmartMedia™ must have a minimum of approximately 2 MB of free space in order to save EMX-1 data.

EventOvr

You have exceeded the maximum number of events that can be recorded in a song.

- Delete unneeded song event data.

FileDelt

An error occurred while deleting a file from SmartMedia.

- Try the operation once again.

FileLoad

An error occurred while loading a file from SmartMedia™.

- Try the operation once again.

FileName

When saving to SmartMedia, an identically-named folder already exists.

- Either use your computer to delete the folder from the SmartMedia, or change the filename on the EMX-1 and save it again.

FileSave

An error occurred while saving to SmartMedia™.

- Try the operation once again.

MotSqFul

The motion sequence cannot be recorded.

- On the EMX-1, you can record a maximum of 24 motion sequences for each pattern.
Use CLEAR MOTION (⇨p.61) to delete unneeded motion sequences, and then input your data once again.

NoFiles

The SmartMedia™ does not contain any files that the EMX-1 can recognize.

- The EMX-1 can load only .EMX files.

Protect

You attempted to write the data into memory when the data protect setting was turned on.

- In Global mode, turn memory protect off.
If the write protect label is affixed to the SmartMedia™, remove it.

SongEvtnt

While writing a song to a different-numbered song, you exceeded the maximum number of events that can be recorded.

- Delete unneeded event data to free up more memory space.

Write

The data could not be written.

- Try the writing operation once again.

Restoring the factory settings

The pattern and song data with which the EMX-1 was shipped from the factory is called the “preload data.” You can load this preload data to restore the EMX-1 to its factory-set condition.

When you do this, the patterns or songs you created will be erased, and replaced by the preload data. If you want to keep the patterns or songs you created, you must save them to SmartMedia first.

1. While simultaneously holding down the Transpose key (Solo key) and the Write key, turn on the power.
2. The display will indicate “Preload,” and the PLAY/PAUSE key will blink.
3. If you want to load the preload data, press the blinking PLAY/PAUSE key.

It will take approximately 30 seconds for the data to be loaded.

If you decide to cancel before executing, press the STOP/CANCEL key.

When loading is completed the EMX-1 will be initialized, and after a few seconds will enter Pattern mode with the display indicating pattern number “A01.”



Never turn off the power while data is being loaded. Doing so may destroy the data.

Specifications

Number of parts: 16 parts (5 synth parts, 9 drum parts, 1 synth accent part, 1 drum accent part)

Memory capacity: 256 patterns, 64 songs

Effects: Three processors x 16 types

Sequences: Maximum of 128 steps per part.

Motion sequences: Total of 24 freely assignable sequences totaling

Song: Maximum of 256 patterns per song.

Maximum 20,000 events for event recording.

Connectors:**

PHONES

Phone jack: stereo

Maximum output level: 16 mW/33-ohms or more / TUBE GAIN = min

Output impedance: 33 ohms

OUTPUT (L/MONO, R)

Phone jacks: mono x 2

Maximum output level: 0 dBu or more / TUBE GAIN = min

Output impedance: 220-ohm (110-ohm at MONO)

Load impedance: 10 k-ohms or more

INDV.OUT (3, 4)

Phone jacks: mono x 2

Maximum output level: +7 dBu or more

Output impedance: 220-ohm

Load impedance: 10 k-ohms or more

INPUT (AUDIO IN)

Phone jack: mono (unbalanced)

Input impedance: 10 k-ohms (at LINE) / 910-ohm (at MIC)

Maximum input level

(at LINE): -20dBu / AUDIO IN LEVEL = max

(at MIC): -52 dBu / AUDIO IN LEVEL = max

Source impedance: 600 ohms

MIDI (IN, OUT, THRU)

5-pin DIN

SmartMedia™: 4-128 MB, 3V (3.3V)

Vacuum tube: 12AX7/ECC83 x 2

Power supply: AC9V (included AC/AC power supply)

Power consumption: 23 W

Dimensions: 358 (W) x 256 (D) x 62 (H) mm (including the rubber feet)

Weight: 3.1 kg

** Analog specifications such as output levels are measured at the point where the vacuum tubes have stabilized after power-on. These values may change due to variations in the environmental temperature.

1

2

3

4

5

6

7

8

Patrn name list

* The "O" symbol in the "Audio In" column indicates that an effect is applied to the audio input.

No.	Name	Programmer	Audio In	Tempo	Length
A01	Electro1	KORG		134	8
A02	PrgHous1	KORG		136	8
A03	HardHs1	Fernando Lopez		140	8
A04	UKHouse1	Tomoki Hirata		139	4
A05	House1	KORG		132	8
A06	GarageH1	KORG		125	8
A07	FJazz1	KORG		130	8
A08	NuSkIBr1	KORG		138	4
A09	NuSkIBr2	James Bernard	O	140	4
A10	DnB1	James Bernard		170	4
A11	DnB2	Chris Petti		174	8
A12	DnB3	KORG		177	8
A13	DnB4	Chris Petti		180	8
A14	HipHop1	David Brant		72	8
A15	HipHop2	David Brant		103	4
A16	HipHop3	David Brant	O	98	4
A17	Trance1	KORG		140	8
A18	Trance2	KORG		138	8
A19	Trance3	KORG		138	8
A20	HTrance1	James Sajeva		140	8
A21	PsyTrnc1	Fernando Lopez		138	8
A22	Techno1	KORG		132	8
A23	Techno2	James Bernard	O	130	8
A24	Minimal1	KORG		137	8
A25	2Step1	Tomoki Hirata	O	134	4
A26	2Step2	David Brant	O	134	4
A27	R&B1	David Brant		104	4
A28	R&B2	David Brant	O	95	4
A29	Funk1	KORG		109	8
A30	DownTmp1	KORG		91	8
A31	AmbiHs1	Tomoki Hirata	O	123	4
A32	IDM1	James Bernard	O	112	4
A33	Techno3	KORG	O	134	8
A34	Techno4	KORG		133	8
A35	Techno5	KORG		136	8
A36	Techno6	James Bernard	O	136	8
A37	Techno7	James Bernard	O	133	8
A38	Techno8	KORG		139	8
A39	Techno9	KORG		137	8
A40	Techno10	KORG	O	135	4
A41	Electro2	KORG		135	8
A42	Electro3	James Bernard		130	4
A43	Electro4	James Bernard		130	8
A44	Electro5	James Bernard	O	124	4
A45	Electro6	KORG		134	8
A46	IDM2	KORG	O	120	8
A47	IDM3	KORG		115	8
A48	IDM4	KORG		132	8
A49	IDM5	James Bernard	O	150	8
A50	IDM6	James Bernard		136	4
A51	IDM7	James Bernard		130	8
A52	IDM8	James Bernard	O	120	4
A53	Minimal2	James Bernard	O	140	8
A54	Minimal3	KORG		137	8
A55	Minimal4	KORG	O	135	4
A56	Minimal5	James Bernard	O	132	8
A57	Minimal6	KORG		135	8
A58	DnB5	Chris Petti		174	8
A59	DnB6	Chris Petti		176	8
A60	DnB7	KORG		173	8
A61	DnB8	KORG	O	172	8
A62	DnB9	KORG		173	8
A63	DnB10	KORG	O	176	8
A64	DnB11	James Bernard		179	8

No.	Name	Programmer	Audio In	Tempo	Length
B01	DnB12	James Bernard	O	175	8
B02	DnB13	James Bernard	O	170	4
B03	DnB14	James Bernard		175	8
B04	DnB15	KORG		174	8
B05	DnB16	KORG	O	170	8
B06	DnB17	KORG		184	8
B07	DnB18	KORG		173	8
B08	DnB19	KORG		177	8
B09	DnB20	KORG		175	8
B10	DnB21	KORG		180	8
B11	DnB22	James Bernard	O	180	8
B12	DnB23	James Bernard	O	175	8
B13	DnB24	James Bernard	O	175	8
B14	DnB25	KORG	O	175	8
B15	DnB26	KORG		175	8
B16	Trance4	KORG		142	8
B17	Trance5	KORG		142	8
B18	Trance6	KORG		135	8
B19	Trance7	James Bernard	O	140	8
B20	Trance8	KORG		141	8
B21	Trance9	KORG		137	8
B22	Trance10	KORG		138	8
B23	Trance11	KORG		136	8
B24	Trance12	KORG		142	8
B25	Trance13	KORG		143	8
B26	Trance14	KORG		135	8
B27	Trance15	KORG	O	135	8
B28	Trance16	James Sajeva		137	8
B29	HTrance2	KORG		142	8
B30	HTrance3	KORG		139	8
B31	HTrance4	KORG		138	8
B32	HTrance5	KORG		137	8
B33	PsyTrnc2	Fernando Lopez		140	4
B34	PsyTrnc3	KORG		140	8
B35	PsyTrnc4	KORG		147	8
B36	PsyTrnc5	James Bernard	O	140	8
B37	House2	Oliver Munyak		130	4
B38	House3	Tomoki Hirata	O	128	4
B39	House4	KORG		128	8
B40	House5	KORG	O	134	8
B41	House6	James Bernard	O	140	4
B42	House7	James Bernard	O	135	8
B43	House8	KORG		138	8
B44	House9	Tomoki Hirata	O	126	4
B45	House10	Tomoki Hirata		129	4
B46	GarageH2	KORG	O	124	8
B47	GarageH3	KORG		127	8
B48	GarageH4	KORG		127	8
B49	GarageH5	Oliver Munyak		126	8
B50	GarageH6	Tomoki Hirata		121	4
B51	GarageH7	Tomoki Hirata		126	4
B52	GarageH8	Tomoki Hirata		125	4
B53	UKHouse2	Tomoki Hirata		135	4
B54	UKHouse3	Tomoki Hirata	O	130	4
B55	UKHouse4	Tomoki Hirata		131	4
B56	UKHouse5	Fernando Lopez		140	4
B57	UKHouse6	Fernando Lopez		133	4
B58	PrgHous2	Tomoki Hirata	O	126	4
B59	PrgHous3	KORG		135	8
B60	PrgHous4	KORG		139	8
B61	PrgHous5	KORG		130	8
B62	HardHs2	Fernando Lopez		141	8
B63	HardHs3	Fernando Lopez	O	140	4
B64	HardHs4	KORG		154	8



8. Appendix

No.	Name	Programmer	Audio In	Tempo	Length
C01	HardHs5	KORG	O	157	8
C02	HardHs6	KORG	O	150	8
C03	Gabba1	James Sajeva	O	157	8
C04	2Step3	KORG		135	8
C05	2Step4	KORG		135	8
C06	2Step5	Tomoki Hirata		136	4
C07	2Step6	Tomoki Hirata	O	134	4
C08	2Step7	David Brant	O	132	4
C09	2Step8	David Brant	O	135	4
C10	2Step9	KORG		137	4
C11	NuSkIBr3	James Bernard	O	140	8
C12	NuSkIBr4	James Bernard		135	4
C13	NuSkIBr5	James Bernard		133	8
C14	NuSkIBr6	James Bernard		135	4
C15	NuSkIBr7	James Bernard	O	135	4
C16	NuSkIBr8	James Bernard	O	145	8
C17	NuSkIBr9	KORG	O	137	8
C18	NuSkIB10	James Bernard	O	138	4
C19	NuSkIB11	James Bernard	O	136	4
C20	NuSkIB12	James Bernard	O	135	4
C21	HipHop4	David Brant	O	74	4
C22	HipHop5	David Brant	O	99	4
C23	HipHop6	David Brant		102	4
C24	HipHop7	David Brant	O	108	4
C25	HipHop8	David Brant	O	102	4
C26	HipHop9	James Bernard	O	98	4
C27	HipHop10	James Bernard	O	80	4
C28	HipHop11	David Brant	O	101	4
C29	HipHop12	David Brant	O	106	4
C30	HipHop13	Ian Fisher	O	140	8
C31	HipHop14	Ian Fisher	O	94	4
C32	HipHop15	KORG		95	8
C33	HipHop16	James Sajeva		93	8
C34	HipHop17	James Sajeva	O	93	8
C35	HipHop18	James Sajeva		95	4
C36	HipHop19	David Brant	O	103	8
C37	HipHop20	David Brant	O	95	4
C38	HipHop21	David Brant	O	90	4
C39	R&B3	David Brant	O	85	4
C40	R&B4	David Brant		112	4
C41	R&B5	James Sajeva		125	8
C42	R&B6	James Sajeva		99	4
C43	R&B7	James Sajeva		102	8
C44	R&B8	KORG		104	8
C45	R&B9	KORG	O	125	8
C46	Funk2	James Bernard	O	110	4
C47	Funk3	David Brant		104	4
C48	Funk4	KORG		108	8
C49	FJazz2	KORG		105	8
C50	FJazz3	KORG		112	8
C51	FJazz4	KORG		106	8
C52	DownTmp2	KORG		85	8
C53	DownTmp3	KORG		78	8
C54	DownTmp4	KORG	O	80	4
C55	DownTmp5	James Bernard	O	75	4
C56	DownTmp6	Tomoki Hirata	O	77	8
C57	DownTmp7	Tomoki Hirata		76	4
C58	AmbiHs2	Tomoki Hirata		127	8
C59	AmbiHs3	Tomoki Hirata		123	8
C60	AmbiHs4	James Bernard	O	130	8
C61	AmbiHs5	James Bernard	O	130	4
C62	AmbiHs6	James Bernard	O	125	4
C63	Dub1	James Bernard	O	80	4
C64	ER-1	KORG		132	4

No.	Name	Programmer	Audio In	Tempo	Length
D01	Demo1-1	KORG		138	8
D02	Demo1-2	KORG		138	8
D03	Demo1-3	KORG		138	8
D04	Demo1-4	KORG		138	8
D05	Demo1-5	KORG		138	8
D06	Demo1-6	KORG		138	2
D07	Demo2-1	Oliver Munyak		125	8
D08	Demo2-2	Oliver Munyak		125	8
D09	Demo2-3	Oliver Munyak		125	8
D10	Demo2-4	Oliver Munyak		125	8
D11	Demo3-1	James Bernard		140	8
D12	Demo3-2	James Bernard		140	8
D13	Demo3-3	James Bernard		140	8
D14	Demo4-1	James Sajeva		102	8
D15	Demo4-2	James Sajeva		102	8
D16	Demo4-3	James Sajeva		102	8
D17	Demo4-4	James Sajeva		102	8
D18	Demo4-5	James Sajeva		102	8
D19	Demo4-6	James Sajeva		102	8
D20	Demo4-7	James Sajeva		102	8
D21	Demo4-8	James Sajeva		102	4
D22	Demo5-1	Chris Petti		180	8
D23	Demo5-2	Chris Petti		180	8
D24	Demo5-3	Chris Petti		180	8
D25	Demo5-4	Chris Petti		180	8
D26	Demo5-5	Chris Petti		180	8
D27	Demo5-6	Chris Petti		180	8
D28	Demo5-7	Chris Petti		180	8
D29	Demo6-1	Oliver Munyak		126	8
D30	Demo6-2	Oliver Munyak		126	8
D31	Demo6-3	Oliver Munyak		126	8
D32	Demo6-4	Oliver Munyak		126	8
D33	Init			120	1
D34	Init			120	1
D35	Init			120	1
D36	Init			120	1
D37	Init			120	1
D38	Init			120	1
D39	Init			120	1
D40	Init			120	1
D41	Init			120	1
D42	Init			120	1
D43	Init			120	1
D44	Init			120	1
D45	Init			120	1
D46	Init			120	1
D47	Init			120	1
D48	Init			120	1
D49	Init			120	1
D50	Init			120	1
D51	Init			120	1
D52	Init			120	1
D53	Init			120	1
D54	Init			120	1
D55	Init			120	1
D56	Init			120	1
D57	Init			120	1
D58	Init			120	1
D59	Init			120	1
D60	Init			120	1
D61	Init			120	1
D62	Init			120	1
D63	Init			120	1
D64	Init			120	1

1

2

3

4

5

6

7

8

Knob/Sw - MIDI List

PART	MIDI CH(INITIAL)	PARAMETER	CC(INITIAL)	NRPN	MOTION SEQ	SONG EVENT
SYNTH1-5	1(GLOBAL)=CH1 2=CH2 3=CH3 4=CH4 5=CH5	OSC TYPE	CC#70		X	X
		WAVE		NRPN	X	X
		SYNTH TUNE		NRPN	X	X
		OSC EDIT1	CC#14		O	O
		OSC EDIT2	CC#15		O	O
		GLIDE	CC#5		O	O
		FILTER TYPE	CC#83		O	O
		FILTER CUTOFF	CC#74		O	O
		FILTER RESONANCE	CC#71		O	O
		FILTER EG INT	CC#79		O	O
		FILTER DRIVE	CC#84		O	O
		LEVEL	CC#7		O	O
		PAN	CC#10		O	O
		EG TIME	CC#75		O	O
		AMP EG	CC#86		O	O
		ROLL	CC#85		O	O
		FX SEND	CC#91		O	O
		FX SELECT	CC#81		O	O
		MOD TYPE	CC#87		O	O
		MOD DEPTH	CC#90		O	O
		MOD SPEED	CC#89		O	O
		MOD DEST	CC#88		O	O
		MOD BPM SYNC	CC#82		O	O
PART MOTION SEQ SW	CC#80		-	O		
DRUM1-7B	1-7B=CH10	WAVE		NRPN	X	X
		PITCH		NRPN	O	O
		LEVEL		NRPN	O	O
		PAN		NRPN	O	O
		EG TIME		NRPN	O	O
		AMP EG		NRPN	O	O
		ROLL		NRPN	O	O
		FX SEND		NRPN	O	O
		FX SELECT		NRPN	O	O
		MOD TYPE		NRPN	O	O
		MOD DEPTH		NRPN	O	O
		MOD SPEED		NRPN	O	O
		MOD DEST		NRPN	O	O
		MOD BPM SYNC		NRPN	O	O
PART MOTION SEQ SW		NRPN	-	O		
SYNTH ACCENT	GLOBAL(SYNTH1)=CH1	LEVEL		NRPN	O	O
		PART MOTION SEQ SW		NRPN	-	O
DRUM ACCENT	GLOBAL(SYNTH1)=CH1	LEVEL		NRPN	O	O
		PART MOTION SEQ SW		NRPN	-	O
FX1	GLOBAL(SYNTH1)=CH1	FX TYPE	CC#12		X	O
		FX EDIT1	CC#92		O	O
		FX EDIT2	CC#93		O	O
		FX MOTION SEQ SW	CC#20		-	O
FX2	GLOBAL(SYNTH1)=CH1	FX TYPE	CC#13		X	O
		FX EDIT1	CC#94		O	O
		FX EDIT2	CC#95		O	O
		FX MOTION SEQ SW	CC#21		-	O
FX3	GLOBAL(SYNTH1)=CH1	FX TYPE	CC#24		X	O
		FX EDIT1	CC#25		O	O
		FX EDIT2	CC#26		O	O
		FX MOTION SEQ SW	CC#22		-	O
COMMON	GLOBAL(SYNTH1)=CH1	TEMPO			X	O
		SWING		NRPN	X	X
		ROLL TYPE		NRPN	X	X
		BEAT			X	X
		LENGTH			X	X
		LAST STEP			X	X
		FX CHAIN	CC#23		X	O
		MUTE STATUS		NRPN	X	O
		ACCENT STATUS			X	X
		SWING STATUS			X	X
OUTPUT BUS STATUS			X	X		

Index

- 6Tri 52
- 8Tri 52

- A** ACCENT 24
- Accent parts 22
- ADDITIVE OSC 37
- AMP EG 30
- ARP CONTROL 75
- arpeggiator 27
- ARPEGGIO SCALE 27
- Audio in 38
- AUDIO IN+COMB 38
- Auto BPM 21

- B** BEAT 52
- BEND RANGE 83
- BPF 32
- BPF+ 32
- BPM SYNC 30
- BPM SYNC DELAY 43

- C** cards 76
- CHO/FLG 44
- CHORD OSC 35
- CLEAR PART 56
- CLEAR PATTERN 56
- CLEAR SONG 71
- CLOCK 83
- COMB OSC 37
- COMPRESSOR 45
- COPY PART 55
- COPY SOUND 55
- Creating a song 68
- CROSS MOD 36
- CUTOFF 31

- D** data dump 82
- DECIMATOR 45
- Delete File 78
- DELETE PATTERN 70
- DEPTH 30
- DEST 30
- DISTORTION 45
- DRIVE 32
- DRUM NOTE NO. 80
- drum part 29
- Drum parts 22
- Drum PCM List 39
- DUAL OSC 34

- E** EDIT SELECT 41
- Editing a song 70
- Editing sequence data 50
- Editing sounds 29
- Effect parameters 43
- EFFECT TYPE 41
- Effect types 42
- Effects 41
- EG INT 31
- EG TIME 29, 32
- EQ 45
- ERASE 56
- event data 72
- Event recording 72

- F** FORMANT OSC 37
- Formatting SmartMedia ... 77
- FX CHAIN 41
- FX EDIT 41
- FX SELECT 30
- FX SEND 30

- G** GATE TIME 51
- GLIDE 32
- Global mode 75
- GRAIN SHIFTER 43

- H** HPF 32, 45

- I** INSERT PATTERN 70

- K** Keyboard function 22

- L** LAST STEP 53
- LENGTH 52
- LEVEL 30
- Load Pattern 78
- Loading a single pattern .. 78
- Loading all data 77
- LPF 32, 45

- M** MASTER TUNE 75
- metronome 75
- MIDI ch 79
- MIDI channels 79
- MIDI clock 83
- MIDI Control Change
Number 81
- MIDI DUMP 82
- MIDI FILTER 80
- MIDI mode 79
- MIDI Utility 80
- MOD DELAY 43
- Modulation 33
- MOTION DEST 60
- Motion sequence 58
- MOTION VALUE 60
- MOVE DATA 53
- multi-track 79
- MUTE HOLD 71

- N** NEXT SONG 71
- NOISE OSC 37
- NOTE NO. 51
- NOTE OFFSET 68
- note-on/note-off 81
- NRPN 85

- O** OSC EDIT 31
- OSC SYNC 36
- Oscillator type list 34
- OUTPUT BUS 26
- output bus 30

- P** PAN 29
- Part 22
- Part Common 32
- PART MUTE 23
- PATTERN 68
- Pattern 19
- pattern name 19
- Pattern Set 62
- PCEN 80
- PCM OSC+COMB 38
- PCM OSC+WS 38
- PHASER 44
- PITCH 29
- pitch bend 83
- PITCH SHIFTER 45
- Playing a motion sequence 59
- Playing a song 66
- POSITION 68
- Position 65
- PROTECT 75
- protect label 76
- Pulse 34

R	Realtime Recording	47
	Recording a motion sequence	58
	rename	73
	REPEAT	54
	RESONANCE	31
	REVERB	43
	RING MOD	35, 44
	ROLL	25, 30

W	WAVE	29, 31
	WAVE FORM	34
	WS	36

S	Saving a pattern	64
	Saving a song	73
	Saving data to SmartMedia	77
	Saving your Global mode settings	76
	Saw	34
	Selecting a song	66
	SHIFT NOTE	54
	SHORT DELAY	43
	Sin	34
	SmartMedia™	76
	SMOOTH	58
	SOLO	23
	Song	65
	TEMPO	66
	Song mode	65
	SPEED	30
	STEP REC	50
	Step recording	48
	SWING	25
	synchronization	84
	Synth filter	31
	SYNTH OSCILLATOR TYPE	31
	Synth parts	22
	Synth PCM List	40
	SYNTH TUNE	33
	system exclusive messages	85

T	TALKING MOD	44
	TAP	21
	tempo	20
	TEMPO LOCK	21, 67
	Timing Clock	84
	Transpose	24
	Tri	34
	TRIG HOLD	58
	TUBE GAIN	26
	TYPE	30

U	UNISON OSC	35
----------	------------------	----

V	VPM OSC	36
----------	---------------	----

Block diagram

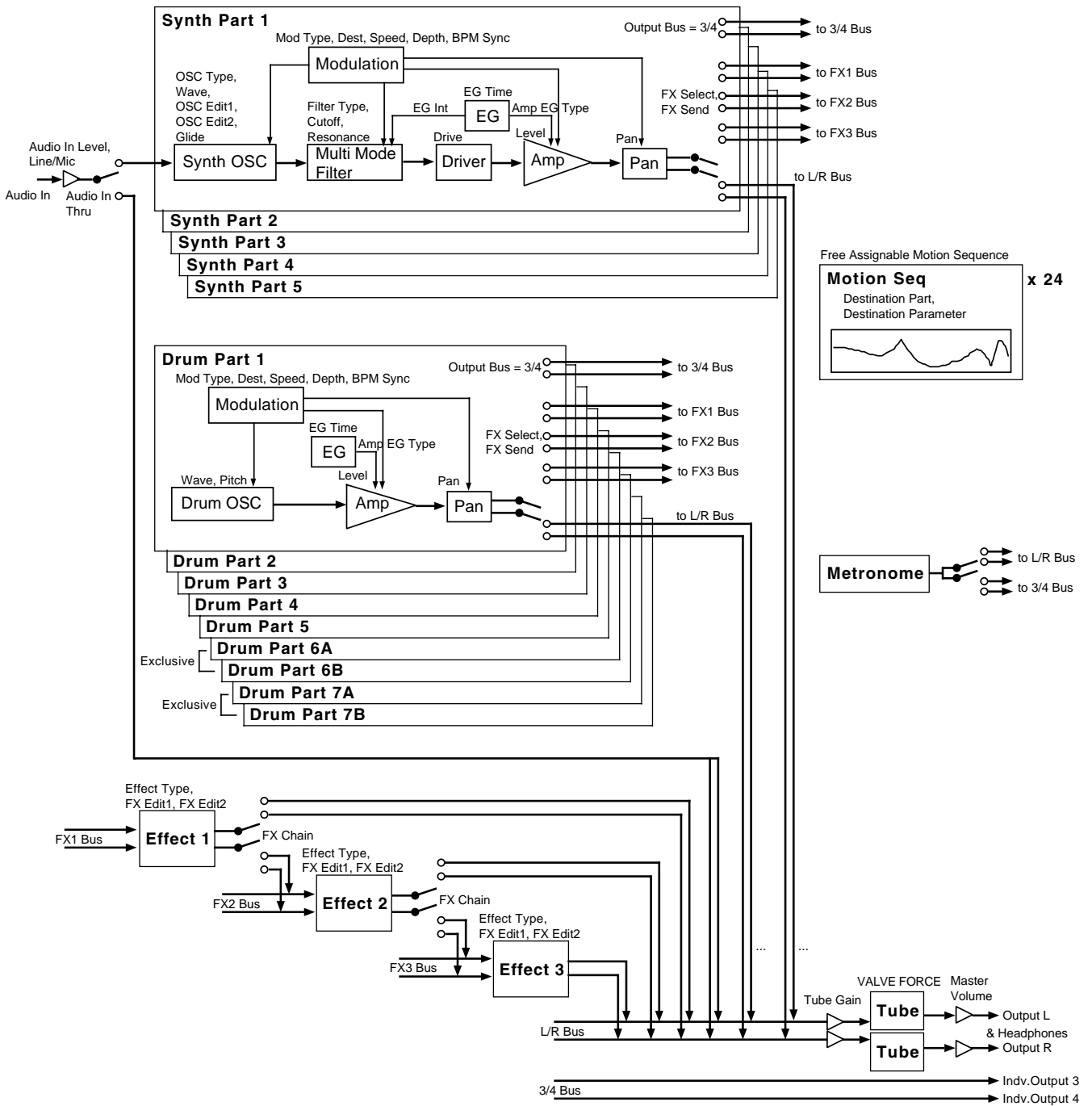

Function ...		Transmitted	Recognized	Remarks
Basic channel	Default Changed	1 – 16 1 – 16	1 – 16 1 – 16	Memorized
Mode	Default Messages Altered	×	3 ×	
Note number :	True voice	0– 127	0– 127 0– 127	
Velocity	Note ON Note OFF	○ 9n, v=30– 127 ○ 64	○ 9n, v=1– 127	Transmitted velocity is specified by Accent level *N *N
After Touch	Polyphonic Channel	× ×	× ×	
Pitch Bender		×	○	*C
Control Change	0,32 98, 99 8 121 35 0–95	○ ○ ○ × ○ ○	○ ○ ○ ○ ○ ○	Bank Select(MSB, LSB) *P NRPN(LSB, MSB) *C Data Entry(MSB) *C Reset All Controllers Data Entry(MSB) *C Panel Control(Knob, SW) *3*C
Program Change :	True#	○ 0 – 127 *****	○ 0 – 127 0 – 127	Transmitted/received in Pattern mode *P
System Exclusive		○	○	Can always be transmitted/received in the MIDI Dump page *2 *E
System Common	: Song Pos : Song Sel : Tune	○ ○ 0 – 63 ×	○ ○ 0 – 63 ×	Transmitted/received in Song mode *1 *P
System Realtime	: Clock : Commands	○ ○	○ ○	*1 *1
Aux Messages	: Local ON/OFF : All Notes OFF : Active Sense : Reset	× × ○ ×	× ○ ○ ×	
Notes	*P, *C, *E, *N: Sent and received when MIDI mode MIDI Filter (P, C, E, N) respectively are set to "O" *1: Sent but not received when Global mode Clock is "Int." When set to "Ext,"received but not sent. *2: In addition to Korg exclusive messages, also responds to Inquiry messages. *3: Contorol Change Nummbar is specified by MIDI mode "#CC ASSIGN."			

Mode 1: OMNI ON, POLY
Mode 3: OMNI OFF, POLY

Mode 2: OMNI ON, MONO
Mode 4: OMNI OFF, MONO

○ : Yes
× : No

Consult your local Korg distributor for more information on MIDI IMPLEMENTATION.

IMPORTANT NOTICE TO CONSUMERS

This product has been manufactured according to strict specifications and voltage requirements that are applicable in the country in which it is intended that this product should be used. If you have purchased this product via the internet, through mail order, and/or via a telephone sale, you must verify that this product is intended to be used in the country in which you reside.

WARNING: Use of this product in any country other than that for which it is intended could be dangerous and could invalidate the manufacturer's or distributor's warranty. Please also retain your receipt as proof of purchase otherwise your product may be disqualified from the manufacturer's or distributor's warranty.

KORG KORG INC.

15-12, Shimotakaido 1-chome, Suginami-ku, Tokyo, Japan