

DX1000

PRO MIXER

User's Manual

Version 1.1 February 2001

ENGLISH

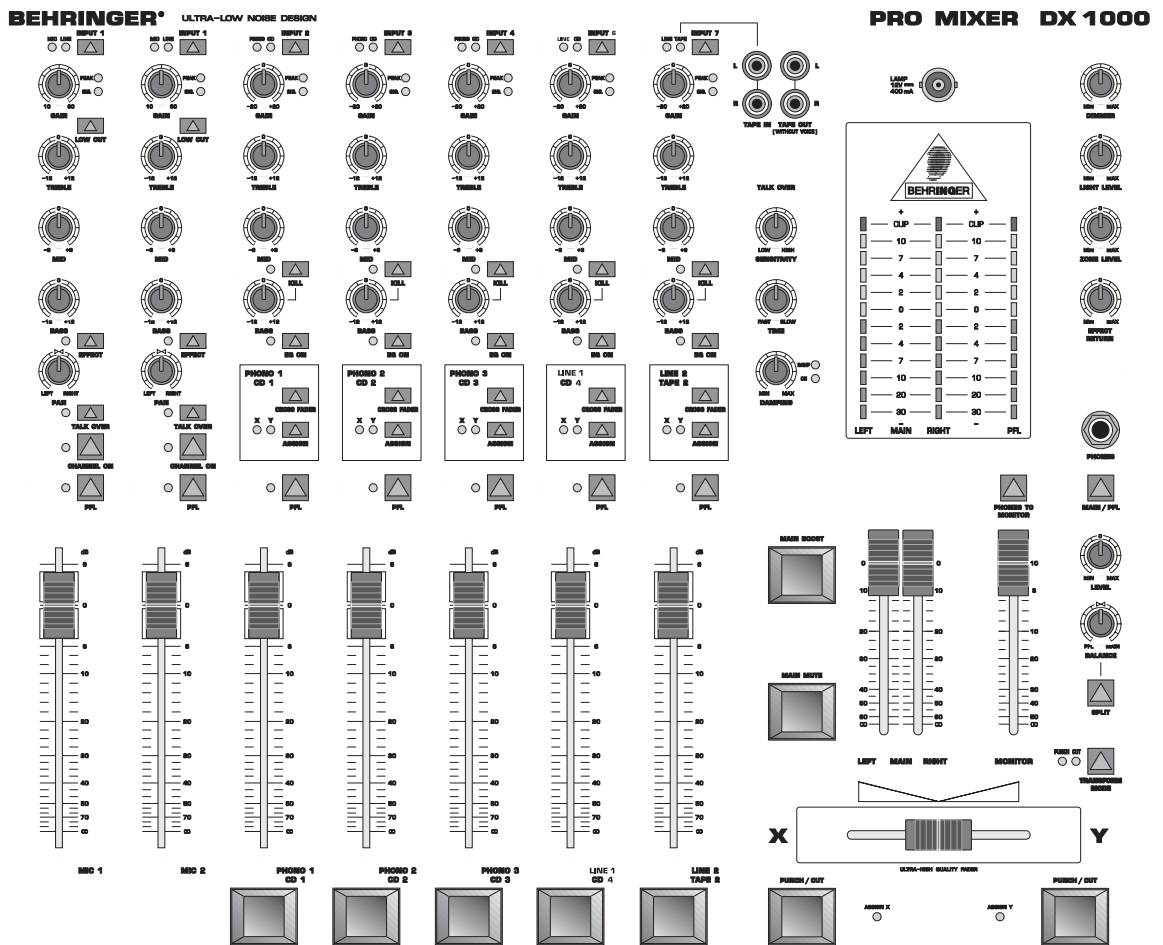

www.behringer.com

SAFETY INSTRUCTIONS

CAUTION: To reduce the risk of electric shock, do not remove the cover (or back). No user serviceable parts inside; refer servicing to qualified personnel.



WARNING: To reduce the risk of fire or electric shock, do not expose this appliance to rain or moisture.



This symbol, wherever it appears, alerts you to the presence of uninsulated dangerous voltage inside the enclosure—voltage that may be sufficient to constitute a risk of shock.



This symbol, wherever it appears, alerts you to important operating and maintenance instructions in the accompanying literature. Read the manual.

DETAILED SAFETY INSTRUCTIONS:

All the safety and operation instructions should be read before the appliance is operated.

Retain Instructions:

The safety and operating instructions should be retained for future reference.

Heed Warnings:

All warnings on the appliance and in the operating instructions should be adhered to.

Follow instructions:

All operation and user instructions should be followed.

Water and Moisture:

The appliance should not be used near water (e.g. near a bathtub, washbowl, kitchen sink, laundry tub, in a wet basement, or near a swimming pool etc.).

Ventilation:

The appliance should be situated so that its location or position does not interfere with its proper ventilation. For example, the appliance should not be situated on a bed, sofa rug, or similar surface that may block the ventilation openings: or placed in a built-in installation, such as a bookcase or cabinet that may impede the flow of air through the ventilation openings.

Heat:

The appliance should be situated away from heat sources such as radiators, heat registers, stoves, or other appliance (including amplifiers) that produce heat.

Power Source:

The appliance should be connected to a power supply only of the type described in the operating instructions or as marked on the appliance.

Grounding or Polarization:

Precautions should be taken so that the grounding or polarization means of an appliance is not defeated.

Power-Cord Protection:

Power supply cords should be routed so that they are not likely to be walked on or pinched by items placed upon or against them, paying particular attention to cords and plugs, convenience receptacles and the point where they exit from the appliance.

Cleaning:

The appliance should be cleaned only as recommended by the manufacturer.

Non-use Periods:

The power cord of the appliance should be unplugged from the outlet when left unused for a long period of time.

Object and Liquid Entry:

Care should be taken so that objects do not fall and liquids are not spilled into the enclosure through openings.

Damage Requiring Service:

The appliance should be serviced by qualified service personnel when:

- The power supply cord or the plug has been damaged; or
- Objects have fallen, or liquid has been spilled into the appliance; or
- The appliance has been exposed to rain; or
- The appliance does not appear to operate normally or exhibits a marked change in performance; or
- The appliance has been dropped, or the enclosure damaged.

Servicing:

The user should not attempt to service the appliance beyond that is described in the Operating Instructions. All other servicing should be referred to qualified service personnel.

FOREWORD

Dear Customer,

Welcome to the team of PRO MIXER users and thank you very much for expressing your confidence in BEHRINGER products by purchasing this unit.

It is one of my most pleasant tasks to write this letter to you, because it is the culmination of many months of hard work delivered by our engineering team to reach a very ambitious goal: presenting an outstanding mixer for flexible use in studios, clubs or at home. The task to develop our new PRO MIXER series certainly meant a great deal of responsibility, which we assumed by focusing on you, the discerning user and musician. It also meant a lot of work and night shifts to accomplish this goal. But it was fun, too. Developing a product usually brings a lot of people together, and what a great feeling it is when everybody who participated in such a project can be proud of what we've achieved.

It is our philosophy to share our joy with you, because you are the most important member of the BEHRINGER family. With your highly competent suggestions for new products you've greatly contributed to shaping our company and making it successful. In return, we guarantee you uncompromising quality (manufactured under ISO9000 certified management system) as well as excellent technical and audio properties at an extremely favorable price. All of this will enable you to fully unfold your creativity without being hampered by budget constraints.

We are often asked how we can make it to produce such high-grade devices at such unbelievably low prices. The answer is quite simple: it's you, our customers! Many satisfied customers means large sales volumes enabling us to get better conditions of purchase for components, etc. Isn't it only fair to pass this benefit back to you? Because we know that your success is our success, too!

I would like to thank all people whose help on "Project DX1000" has made it all possible. Everybody has made very personal contributions, starting from the designers of the unit via the many staff members in our company to you, the user of BEHRINGER products.

My friends, it's been worth the trouble!

Thank you very much,

A handwritten signature in black ink, appearing to read 'U. Behringer', with a long horizontal flourish extending to the right.

Uli Behringer

BLOCK DIAGRAM

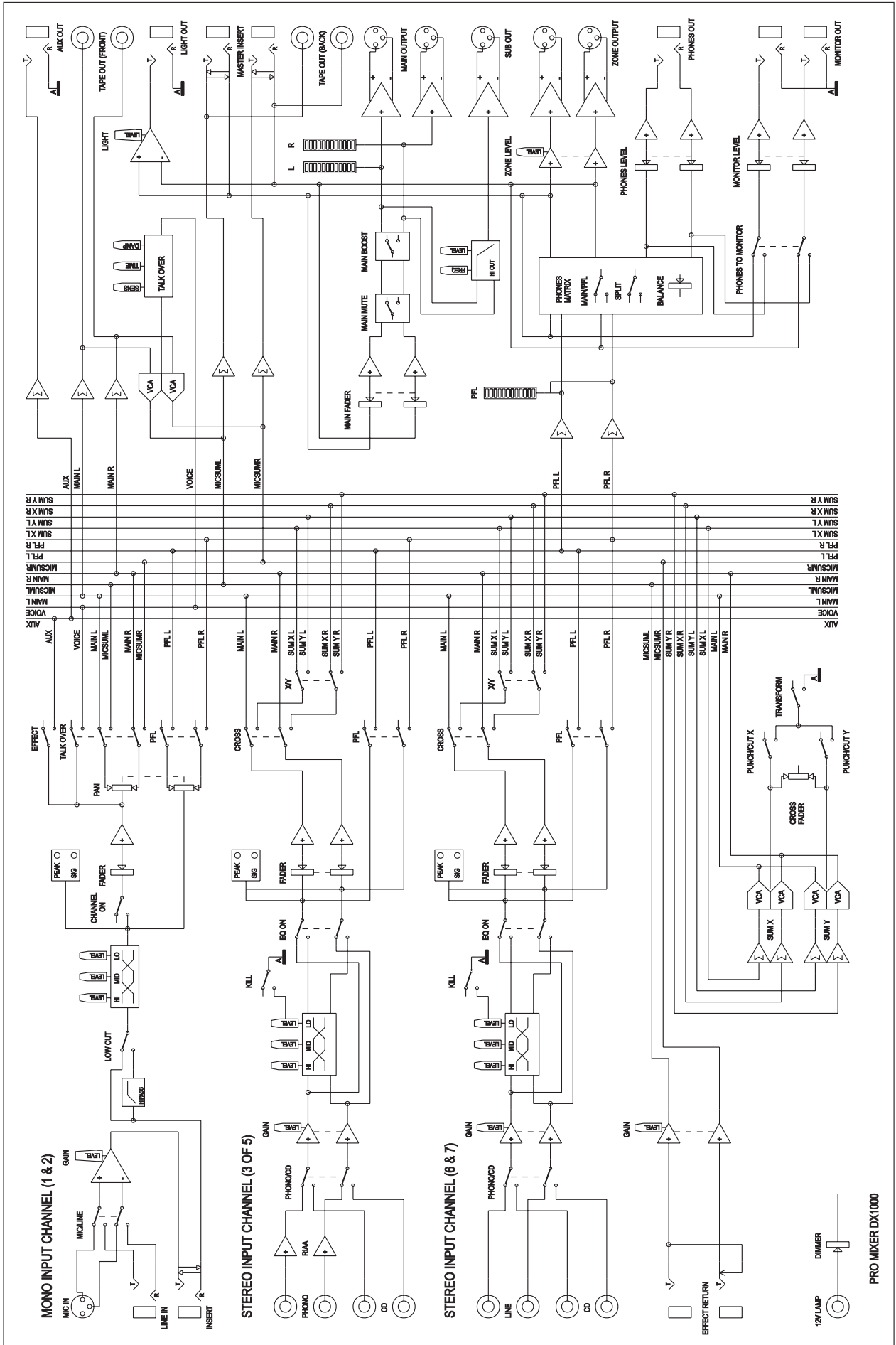

PROMIXER DX1000

PRO MIXER

Professional DJ mixer with a total of 10 stereo sources on 5 dual-input channels

- ▲ Two professional high-class microphone channels with peak indicator and effects send facility
- ▲ High-precision phono preamps for bass power and crystal clean sound
- ▲ Ultra-musical 3-band EQ with independent defeat switch on all channels
- ▲ Kill switch attenuates the bass for more creativity
- ▲ Ultra low-noise design comparable to studio-grade consoles
- ▲ Replaceable and high-quality crossfader
- ▲ Fully adjustable talkover function automatically attenuates the main output
- ▲ PFL switches on all channels with two different PFL modes
- ▲ Balance control allows you to blend between main and PFL on the phones section
- ▲ Extremely flexible, intuitive X-Y routing with status control LEDs on each channel
- ▲ Large X-Y punch and cut buttons at the crossfader for super effects such creative mixing!
- ▲ Main mute (-20 dB) and main boost buttons (+4 dB) for unlimited creativity
- ▲ Balanced main outputs on gold-plated XLR, 1/4" TRS and RCA connectors
- ▲ Additional adjustable zone output allows you to control the level of a second area or room
- ▲ Subwoofer output with adjustable x-over frequency and level control for separate bass amplification
- ▲ Remote-start buttons to start your turntables and CD players etc.
- ▲ Separate tape outputs with and without microphone signal
- ▲ BNC socket with dimmer control for 12 V gooseneck lamp (not included)
- ▲ High-quality 100-mm channel faders like those found in professional recording consoles
- ▲ Super-rugged construction ensures long life, even under the most demanding conditions
- ▲ Manufactured under the ISO9000 certified management system

TABLE OF CONTENTS

1. THE MANUAL	7
1.1 Nomenclature	7
2. PRO MIXER OVERVIEW	7
2.1 Highly accurate main and PFL peak—reading bargraph meters	8
2.2 How will <u>You</u> use your DX1000?	8
2.3 PSU (Power Supply Unit)	8
2.4 Rack mounting the DX1000	8
2.5 Warranty	8
2.6 Packing	8
3. MONO INPUT CHANNEL	9
3.1 Input selection	9
3.2 Gain setting	9
3.2.1 Quick way	9
3.2.2 Gain setting by using PFL	9
3.3 Insert point	9
3.4 Equalizer	10
3.5 Output	10
3.6 Effects	10
4. STEREO INPUT CHANNEL	10
4.1 Input selection	10
4.2 Gain setting	11
4.2.1 Quick way	11
4.2.2 Gain setting by using PFL	11
4.3 Equalizer	12
4.4 Output	12
5. TALK OVER	12
6. MASTER AUDIO OUTPUTS	13
6.1 Crossfader	13
6.2 Transforming with punch and cut	13
6.3 Main/tape outputs	14
6.4 Main boost and main mute	14
6.5 Zone	14
6.6 Effect return	14
7. HEADPHONES, MONITORS & PFL	15
7.1 Monitoring	15
7.2 Headphones—read carefully—this is tricky!	15
7.3 Permanent PFL—using PFL as a listening subgroup	15
8. SUB BASS	16
9. CONTROLLING EXTERNAL DEVICES	16
9.1 Desk lamp	16
9.2 Remote control of audio devices	16
9.3 Sound-to-light	16
10. CONNECTIONS	17
10.1 PRO MIXER DX1000 connections	17
10.2 Plug soldering guide	17
11. CROSSFADER ADJUSTMENT	19
11.1 Overlap	19
11.2 Slope	19
12. SPECIFICATIONS	20
13. WARRANTY	22

1. THE MANUAL

We know that reading manuals can be a bore, and that you are probably impatient to get started with your new DX1000 mixer, if you haven't already! It is true that with a modicum of knowledge about audio equipment you could get up and running successfully, but chances are you will not be able to exploit the full potential of your DX1000 (or yourself) until you have some of its more advanced features explained. Please, please at least read through all the text in this section, which contains important safety tips to help preserve you and your valuable equipment.

 **You'll get nowhere with your DX1000 unless it is properly connected to your music sources, power amplifiers, tape recorder etc. We strongly advise that you never use cheap connecting plugs for audio—use only gold-plated ones, as these are best at resisting corrosion. Run any mics on balanced lines to minimize unwanted interference, and check those mains plugs for loose cable clamps or electrical contacts frequently.**

Good quality plugs are extremely important, all the more so where connections are left untouched for long periods. (Unplugging leads frequently can help to keep contacts clean by mechanical abrasion). Also moisture in a humid nightclub greatly accelerates the build-up of oxide (e.g. rust) on metal contacts. For the complete wiring scheme for all inputs and outputs please refer to chapter 10 "CONNECTIONS".

 **Never patch line level devices into your highly sensitive phono inputs. Phono cartridge output is measured in millivolts. CD and tape players are of the order of magnitude of a volt. With line levels you are looking at signals 100 times more powerful than a phono pre-amplifier is designed to handle!**

 **Please always ensure that the mixer power supply is securely connected to the mixer before you turn on the mains supply. Power amps should always be turned on last of all in order to minimize switch-on thumps, which can easily damage loudspeakers. Check that there is no signal going through the DX1000 when the amps are switched on in order to avoid any sudden volume surges. It is best to turn down all output faders and rotary controls first.**

1.1 Nomenclature

This manual is a combination of figures and text. Together these precisely define and describe all the functions of your DX1000. For reasons of clarity you might find certain text or subject matter appears more than once in the manual. This means we pay a little more in printing and publishing costs, but it does mean that each section is self-contained and therefore easier for you to read.

Sometimes technical information is provided in brackets. Don't worry—you don't need to know what the figures mean in order to have success with your DX1000. This info is included for the benefit of sound engineers, not DJ's! The manual is also crammed full of creative ideas on how to play your DX1000 to full advantage. Try to read it from cover to cover at least once. Otherwise you'll never know what possibilities you might be missing out on!

 **The following operational manual will introduce you to the BEHRINGER PRO MIXER DX1000 and its various functions. After reading the manual carefully, make sure it is always on hand for future reference.**

2. PRO MIXER OVERVIEW

The DX1000 is a multi-functional stereo mixer designed for all applications where pre-recorded music is mixed and played. It is equally at home, in dance clubs, personal DJ setups and broadcast studios. It has two mono mic channels and five stereo music channels. The mic channels may be routed to the main mix directly. Music channels, on the other hand, must be assigned to one of two stereo submixes, called X and Y. A super-smooth user-definable VCA crossfader ultimately controls the blend of X and Y being sent to the main mix.

2.1 Highly accurate main and PFL peak—reading bargraph meters

The main output level is constantly monitored by a pair of highly accurate main bargraph meters [38]. In addition, all channels have PFL (Pre-Fader-Listen) [13]. This means that you can see (on a separate PFL bargraph meter) and hear (on your headphones and/or monitors) the music you are about to play without disturbing the mix—essential if you want to come in at the same level and in time with the music currently playing. All professional DJ's strive to do this, often overlapping two tracks, or slowly cross fading between them. (These and other DJ mixing tricks will be explained elsewhere in this manual.)

2.2 How will *you* use your DX1000?

Your DX1000 is a **creative instrument**. Learn to play it well. If possible, experiment with it “off-line”—before you use it in earnest in a club or studio. It offers you many creative music mixing possibilities, with its ultra DJ-friendly control surface. In addition many special features have been included to enhance the flexibility and ease of operation of your mix. For example, the adjustable TALK OVER feature can automatically and temporarily reduce the music level while you are speaking. We have given particular attention to metering your music with PFL offered on every channel. In addition all channels have signal present and overload LEDs constantly monitoring input levels. You will also see virtually every switch on your DX1000 has an associated status LED, to let you know when it is engaged. Just another way in which we try to make life easier for you, the DJ.

It is true that not all the features of the DX1000 are relevant to every application. For example the REMOTE (machine control) buttons may be extraneous to the needs of the vinyl DJ, while the EQ KILL switches might never be used in a hospital radio installation. Nonetheless the superior quality of all of the features of your DX1000 means you will never find it wanting, which ever way you use it.

2.3 PSU (Power Supply Unit)

Any amplifier circuit is limited in its transient response by the available current. Every mixer has numerous line level operational amplifiers (op-amps) inside. When being driven hard, many desks begin to show signs of stress due to power supply limitations. Not so with the PRO MIXER DX1000. The sound will always stay clean and crisp right up to the operating limits of the op-amps themselves, thanks to our generous 50 W external power supply unit.

Please connect the PSU with the PRO MIXER DX1000 PSU connector [72] on the rear panel of your mixer.

 **Do not connect the PSU to the PRO MIXER while the PSU is connected to the mains supply. Connect switched-off desk and PSU first before you connect the PSU to the mains supply.**

2.4 Rack mounting the DX1000

Your DX1000 is shipped with fixed rack ears. If you want to make your DX1000 a desktop mixer, loosen the screws from the side panels and remove the fixed rack ears (note, that there is a left and a right one).

2.5 Warranty

Please take time to have the warranty card filled out completely by your specialized dealer and return it within 14 days after the date of purchase, so as to be entitled to benefit from our extended warranty. You will find the serial number [71] of your DX1000 on the rear panel. Or use our online registration option available on the Internet at www.behringer.com.

2.6 Packing

Your BEHRINGER PRO MIXER DX1000 was carefully packed in the factory and the packaging was designed to protect the unit from rough handling. Nevertheless, we recommend that you carefully examine the packaging and its contents for any signs of physical damage, which may have occurred in transit.

 **If the unit is damaged, please do not return it to us, but notify your dealer and the shipping company immediately, otherwise claims for damage or replacement may not be granted. Shipping claims must be made by the consignee.**

3. MONO INPUT CHANNEL

Plug a mic or line source (tape, CD player etc.) into the appropriate MIC [52] or LINE [51] input. Speak or play music at typical volume to check out and set up the channel.

 **The mic pre-amps are of the same quality as those in our award-winning EURODESK studio consoles. These give an incredibly warm, clear and noiseless performance. Mic and line inputs are on balanced XLR and 1/4" jacks respectively. Balanced operation gives best noise performance. Unbalanced microphones need to have XLR pins 1 and 3 shorted. Any Line source will work perfectly well if a mono jack is used, or the ring and barrel of a TRS jack are shorted (see chapter 10 "CONNECTIONS").**

3.1 Input selection

Inputs are on the back panel. Your input source is selectable between MIC and LINE by a switch [1]. A pair of associated LEDs [2] lets you know which input is selected.

3.2 Gain setting

 **Gain is dependent on EQ. Set up your EQ before fine-tuning gain. If you re-EQ, also re-check gain.**

3.2.1 Quick way

Channel input level is continuously monitored by a pair of LEDs [3]. As long as the SIG. LED is flickering and the PEAK one isn't the gain is reasonable. Mic channel input level can be continuously adjusted by the GAIN knob [4] (from +10 to +60 dB; Mic signals are low, therefore they need to be heavily pre-amplified).

PEAK lets you know if you overload the channel (it lights at +18 dB).

 **SIG. lets you know if a signal is present (it only responds to bass frequencies). That's why you can use it to keep an eye on the beats.**

 **If you are using a mono line source in a mic channel, the gain structure is comparable to that on a stereo music channel, albeit 20 dB more sensitive. (from - 10 to + 40 dB ; = 20 dB pad on mic input)**

3.2.2 Gain setting by using PFL

Pre-Fader-Listen is the professional way to set gain. Hit the PFL button [13] to temporarily send the channel signal to the PFL bargraph meter [38]. Adjust the GAIN control until the bargraph meters are in the yellow (0 dB) but not the red (Clip). Once gain has been set for a channel, release its PFL button.

 **You will usually want to PFL only one channel at a time, otherwise the PFL meter reading will be meaningless.**

3.3 Insert point

Situated on the rear of the console, mic channels have insert points [50] on TRS jacks. (These are post-gain and pre-EQ). You can use these combined input/output sockets to put a compressor, gate or any other signal processor(s) in line with your microphone (see chapter 10 "CONNECTIONS").

 **Compressors can help even out voice volume, adding loads of energy, but they can also cause feedback problems if over-used. Noise gates shut off mics automatically when not in use—useful for keeping out music spillage which can muddy the sound of your mix. Often a compressor/gate combination is best. Check out the excellent BEHRINGER range of interactive dynamics products.**

3.4 Equalizer

The mic channel EQ section comprises three control knobs and one switch. Depressing the LOW CUT switch [5] rolls off the bass end (-18 dB/oct @ 75 Hz). We recommend using this feature with microphones to eliminate “popping” and handling noise. Where loud music is playing, LOW CUT also helps to avoid bass feedback. Separate controls cut and boost TREBLE [6], MID [7] and BASS [8] frequencies respectively. Use EQ creatively to sweeten the sound of your microphone, or defensively to help cut feedback (see below for EQ specifications).

	EQ	Frequency	Range	Centre
Treble	Shelving EQ	10 kHz	+/- 12 dB	OFF
Mid	Peaking EQ	750 Hz	+/- 9 dB	OFF
Bass	Shelving EQ	50 Hz	+/- 12 dB	OFF

Tab. 3.1: Equalizer of the mono input channels

 **If you are serious about your mic channel, and want to really kill feedback, you can patch our FEEDBACK DESTROYER PRO DSP1124P across the channel insert point at the rear of the console. It is ideal for this purpose.**

3.5 Output

Mic channel output is fed directly into the main mix, not via the X and Y subgroup channels. Level is controlled by a precision 100 mm fader [14], while stereo position is set by the PAN control [10]. The channel signal is sent to the mix by depressing the CHANNEL ON switch [12]. A LED indicator illuminates when the channel is on. (Channel on is the inverse of the more traditional channel mute found on standard recording consoles).

 **The mic channels are routed to the tape outputs [66] on the rear panel of the DX1000, but not to the tape outs [22] situated to the left of the main meters, marked “WITHOUT VOICE”.**

 **The faders used are special high-quality true-log faders. These give ultra-smooth operation even at low levels, on a par with those used in very expensive studio consoles.**

3.6 Effects

You can patch a mono or stereo outboard effects processor into your DX1000 via the effect send [53] and return [54] jacks on the back panel. Now you can effect your voice instantly simply by punching the illuminated EFFECT button [9]. The effect send level is dependent on the fader setting. Adjust the desired amount of effect (from -∞ to +30 dB) by the EFFECT RETURN knob [42] to the right of the bargraph meters.

 **Set your effects unit input level so that the input meter reading (if there is one) is healthy when you are sending a typical signal to it. Too low a level will mean too much hiss on your effects return, too high and you’ll get distortion.**

4. STEREO INPUT CHANNEL

Plug a phono (turntable) or line source (CD player etc.) into the appropriate PHONO [59] or CD [58] input. Play music at a typical volume to check out and set up the channel.



4.1 Input selection

Inputs are on the DX1000’s back panel. Your input source is selectable between a pair of stereo inputs by the switch [1] at the top of the channel strip. An associated pair of LEDs [2] lets you know which input is selected. The choice of inputs depends on which of channels 3 - 7 you are looking at. The mixer is set up as follows:

Channel	Input 1	Input 2
3	PHONO 1	CD 1
4	PHONO 2	CD 2
5	PHONO 3	CD 3
6	LINE 1	CD 4
7	LINE 2	TAPE*

Tab. 4.1: Stereo channel configuration

* Channel 7's TAPE input [57] is parallel-wired to the TAPE IN [21] on the top panel.

-  **Never patch line level devices into your highly sensitive phono inputs. Phono cartridge output is measured in millivolts. Line level signals are of the order of magnitude of a volt. With line levels you are looking at a signal up to 100 times more powerful than the phono pre-amplifier is designed to handle!**
-  **If for some reason your turntable has a built-in RIAA pre-amp, you should patch it into a line level input.**
-  **A mix could include three turntables (channels 3 - 5) and two samplers for creative DJ work, or four CD/cart players plus a stereo tape recorder for a broadcast studio. In fact *any* line level signal could be patched into *any* line-level input, so channel 7 could return an extra CD player, for example. Only the phono inputs are device-specific, being matched exactly to your cartridge response.**

4.2 Gain setting

-  **Gain is dependent on EQ. Set up your EQ before fine-tuning gain.**

4.2.1 Quick way

Channel input level is continuously monitored by a pair of LEDs [3]. PEAK lets you know if you're about to overload the channel (it lights at +18 dB). The SIG. LED only responds to bass frequencies and is perfectly suited to keep an eye on the beats. As long as the signal LED is flashing on the beat (and the peak one isn't) you can be sure the gain is reasonable. Do this for all music channels. Channel gain can be continuously adjusted by the GAIN knob [4] (from -20 to +20 dB).

-  **If you are in the habit of slamming the channel faders all the way up (+6 dB), try to keep your MAIN faders at a compensatory -6 dB to make sure you don't risk distortion. At this level PFL and MAIN meters should show the same level (check this by engaging PFL on the channel currently playing), allowing easy comparison between outgoing (playing) and incoming (cueing) tracks. Keep an eye on the output meters—red spells trouble. Remember—distortion is not volume, and any distortion introduced before the power amplifiers and speakers will worsen your sound and cause amps and speakers to clip sooner.**

4.2.2 Gain setting by using PFL

Pre-Fader-Listen is the professional way to set gain, and we always recommend you do it if you have the time. Hit the PFL button [13] to temporarily send the channel signal to the PFL meter [38]. Adjust GAIN until the PFL meter is hitting the yellow (up to +10 dB) but not the red (clip). Once gain has been set for a channel, release its PFL button.

-  **Normally you will want to PFL only one channel at a time. This might not be true if you are layering tracks, and/or using "Permanent PFL"—see the chapter 7 "HEADPHONES, MONITORS & PFL". Also note that the mono PFL meter is a sum of L and R channel signals.**

4.3 Equalizer

The channel EQ section comprises three control knobs and two switches. The EQ ON [16] switch activates the tone controls which enable cut and boost of TREBLE [6], MID [7] and BASS [8] frequencies respectively (see below for specs.) EQ can sweeten or effect a track, with the fading out and in of frequency bands being very popular. When you press the KILL switch [15] the bass EQ is set to maximum attenuation independent of the setting of the bass EQ control.

	EQ	Frequency	Range	Centre
Treble	Shelving EQ	10 kHz	+/- 12 dB	OFF
Mid	Peaking EQ	750 Hz	+/- 9 dB	OFF
Bass	Shelving EQ	50 Hz	+/- 12 dB	OFF

Tab. 4.2: Equalizer of the stereo channels

 **EQ is particularly useful if two or more music tracks are playing together, as frequencies often clash. Low frequencies in particular can phase and cancel, causing uneven bottom-end response. The trick is to cut the bass from all but one track playing. You can roll off the bass by turning BASS fully anti-clockwise.**

4.4 Output

Channel level is controlled by a precision stereo 100-mm fader [14].

 **The faders used are high-quality true-log faders. These give ultra-smooth operation even at low levels, on a par with those used in the most expensive studio consoles.**

You won't hear anything in the main mix unless the channel is switched on by depressing the CROSSFADER switch [17]. This sends the channel signal to either of two stereo submixes, which we call X and Y. The ASSIGN button [18] selects between these two submixes, and a pair of LEDs [19] clearly show you which of X or Y is currently selected per channel. The X and Y mixes are then routed to opposite ends of the main crossfader [33].

 **You can immediately tell if any channel is switched on (CROSSFADER switch depressed) by looking at the master ASSIGN X and ASSIGN Y [36] indicators situated under the crossfader.**

5. TALK OVER

Let's say you are talking over a music intro. You would almost certainly want to attenuate the music while you speak. The DX1000 talk over system does this for you—automatically. Depressing the TALK OVER button [11] on a mic channel engages the talk over system. You can leave this button down all the time—it will not affect the music unless you speak into the mic, provided you set the system up correctly. How do you do this?

If you look to the left of the main bargraph meters you will see three rotary controls and two LEDs. These are the master talk over adjustments you will want to make. Once you have set them up for your system you will probably not have to alter them unless something else is changed.

SENSITIVITY [23] sets the speech level threshold at which attenuation (also called gain reduction) kicks in once talk over is activated by a mic channel signal.

TIME [24] controls the rate at which music volume recovers after a mic channel signal has activated the automatic music level reduction process.

DAMPING [25] allows you to adjust the depth of music attenuation triggered by the mic channel signal.

To set up these controls properly, first turn DAMPING full on (MAX). Set up the gain on your mic channel using PFL. Now adjust SENSITIVITY until the music is always attenuated by a voice signal. (Attenuation is at MAX to enable you to hear this adjustment as clearly as possible.)

- ☞ **Take care to ensure that SENSITIVITY is not set too high, otherwise spill from loudspeakers into the mic could trigger the talk over system, and the music volume will just keep going up and down! (You have set up an intermittent negative feedback loop.)**

Once SENSITIVITY has been set so that talk over is only being activated by speech, it's time to fine-tune the system with the other two controls again, according to taste. Twin LEDs let you know how your talk over system is behaving. When DAMP [27] is lit, your music is being automatically attenuated. ON [26] lets you know that one or both mic channels have talk over engaged.

- ☞ **If two mics are being used, set SENSITIVITY with both mic channels switched on.**
- ☞ **Talk over could just as easily be used for MC-ing. It might not however be appropriate for rapping, which takes place alongside rather than over the music, unless the damping effect is set to be quite subtle.**

6. MASTER AUDIO OUTPUTS

6.1 Crossfader





The heart of your music mix is the horizontally-mounted ULTRA-HIGH QUALITY FADER [33], which controls the blend of the X and Y mixing channels. When set fully to the left, only X is heard in the mix, and vice versa. We know how much you rely on this, and for that reason we have not only ensured that it is incredibly durable and smooth-acting. We also allow you to tailor its response to your “feel” by means of a simple adjustment (see chapter 11 “CROSSFADER ADJUSTMENT”). The crossfader is most often used to fade one track into another during a DJ mix.

- ☞ **If you are bringing in an intro over an outro, there will be a time when you want to hear both tracks at full volume. Simply pause your crossfader in the middle position until you are ready to fade out the outgoing track.**
- ☞ **The crossfader is actually a sophisticated VCA controller. Its ultra-high quality design means that you can expect a massive 200,000 smooth operations before wear & tear even becomes a factor. And even if the fader does get something nasty poured over it by mistake (please don't do this!) the quality of your music should be unaffected. This is because no audio signal actually passes through your crossfader, unlike on many other DJ mixers.**
- ☞ **You can immediately tell if any channel is switched on (CROSSFADER switch depressed) by looking at the master ASSIGN X and ASSIGN Y indicators [36] situated under the crossfader.**

6.2 Transforming with punch and cut



Transforming is a DJ term used to describe the chopping up of sound to create dramatic effects. Traditionally this is done by rapidly moving a crossfader to give a stuttering or “gated” effect, either between two music sources, or one source and silence. Another DJ trick is to use the channel faders or channel on buttons to chop one music track over another. These methods are still valid, but if you are looking for instantaneous transforming action, check out our ergonomic alternative—a pair of big assignable PUNCH/CUT buttons. We are sure you will grow to love their speed and ease of operation.

Punch and cut are two transform modes selectable by the TRANSFORM MODE button [48]. A pair of LEDs [49] lets you know whether PUNCH or CUT is active. The X and Y PUNCH/CUT buttons [34] and [35] are ergonomically situated by the crossfader with which they are designed to work. CUT mode enables the big buttons to be used as mutes for interesting gating effects, temporarily silencing the X or Y output. In PUNCH mode the X button [34] introduces the X signal to the mix, while the Y button [35] brings in the Y signal. This means you can add in bits and beats from X on top of Y and vice versa, opening up your scope for creative mixing.

-  **This is the first time we have come across any really BIG buttons on the DX1000. At this point it's worth pointing out that all the smaller switches on your DX1000 are latching. This means they stay down until you hit them again. Big buttons are all non-latching, or momentary in operation. This means that they are only active when your finger (or other appendage) is actually holding them down, like the keys on a MIDI keyboard. These are ideal for executing transformations, as you will very quickly find as you get into using your DX1000.**
-  **Try running a rhythm track through X (crossfader fully to the left). Now use the Y button in PUNCH transform mode to manually chop in a sustained signal like orchestral music, ambient sounds, noise, whatever.**
-  **As well as using the X - Y crossfader to select / fade between X and Y you can also use it to blend X and Y together, by simply leaving it somewhere in the middle. Now you can use the big buttons in CUT mode to chop between X and Y for more creative music gating effects.**
-  **You can send more than one channel to either X, Y or both. In practice you will usually only send one at a time, but if you are layering tracks you might want to send more. Also you can crossfader between channels assigned to the same side of the crossfader using the 100 mm channel faders.**



6.3 Main/tape outputs

Level to the main outputs (Max. output +28 dBu balanced, +22 dBu unbalanced) is ultimately governed by a pair of precision 60 mm main faders [30]. This level is continuously monitored by the pair of highly accurate tri-colored bargraph meters [38] sited immediately above the output faders. The main outputs constitute a blend of X, Y and the two mic channels, all covered previously in the manual, plus the stereo effects return. The main output also feeds the tape outputs on the back of the console.

-  **The tape outputs on the top of the console are taken directly from the output of the crossfader. This mix does not include the mic channels 1 and 2.**
-  **Never connect to both sets of tape inputs/outputs (see chapter 10 "CONNECTIONS").**

6.4 Main boost and main mute

MAIN BOOST [28] and MAIN MUTE [29] are big non-latching buttons acting on the main outputs, temporarily boosting (by +4 dB) and cutting (by -20 dB) volume.

-  **Main cut could be used for audience sing-along bits. Or you could use main boost to emphasize the beats etc.**
-  **Main boost should not be applied for more than just spot effects, as you will probably stress the sound system, or simply cause the limiters to come in harder.**

6.5 Zone

The ZONE stereo output [69] is a second main mix output with its own totally independent ZONE LEVEL control [41]. This can be used for feeding the mix into a separate sound system such as DJ foldback, or another room or area in a dance club.

6.6 Effect return

A line-level stereo effect return [54] (Max. gain 30 dB) feeds directly into the mix, level being adjusted by the EFFECT RETURN knob [42]. This input is designed to accept the output from a mono or stereo effects unit (see chapter 10 "CONNECTIONS"). It could also be used to return another stereo music source such as DAT or mini disc if five stereo channels are not enough for your music needs.

7. HEADPHONES, MONITORS & PFL

7.1 Monitoring

A separate stereo MONITOR output [68] is provided. Level is controlled by a single 60 mm MONITOR stereo fader [32]. The monitor signal is taken directly from the main mix. Engaging PFL anywhere on the board changes the monitor source to PFL.

 **Main fader adjustments will *not* affect the level of the monitor output—unlike on standard recording consoles where monitor *follows* the main faders.**

7.1.1 PFL in the studio

In a studio setup, the monitor output is normally sent to an amplifier driving a pair of speakers facing the operator. (The main output might feed a tape recorder (recording studio) or transmission line (broadcast studio)). In the studio environment PFL (Pre-Fader-Listen) is the preferred way to set up an individual channel. Depressing a channel's PFL button cancels the mix from the monitor output and replaces it with that channel's signal. Now the DJ or engineer can hear in isolation what's going on in one (or more) channel(s), via headphones or the monitor speakers. During PFL channel level is sent to the PFL meter to enable accurate gain setting.

7.1.2 PFL in the club

In a club the main output would normally drive the house PA, while the monitor output could offer foldback into the DJ area, usually via a separate amp and speaker(s). In the club environment, things get messy. You can't hear any sound in isolation, either on a foldback system or headphones, because both are to some extent drowned out by the main PA system. You should, however, be able to hear the PFL signal loud enough to detect the beat, cue starts etc. What you can't do is to judge by ear exactly what level the next track will come in at. For that you must use your eyes and the highly-accurate bargraph meters.

 **PFL is in stereo: if you PFL a stereo channel you will hear it in stereo even though there is only one PFL bargraph meter. If a mono channel is PFL-ed, you will hear it according to the position of the channel PAN. This is a professional feature and called “Solo-In-Place” in big recording consoles.**

7.2 Headphones—read carefully—this is tricky!

The PHONES section lies to the far right hand side of the DX1000, below the headphones stereo jack socket [43]. LEVEL [45] controls headphones level. Right, that's the easy bit explained. Now pay attention.

OPTION 1:

The PHONES output can have as its source either PFL or Main mix selected by the MAIN/PFL switch [44]. When this switch is down, headphones follow the same logic as monitor, i.e. main mix unless any channel has PFL engaged. When it is up, headphones audition PFL **only**, i.e. if no channel's PFL is engaged, the headphones will fall silent. (NOTE: SPLIT switch is UP here)

OPTION 2:

Depressing the SPLIT switch [47] disables the PFL/MAIN switch, activating instead the BALANCE control [46]. The headphones mix is now in mono instead of stereo as previously, and BALANCE controls the blend of the PFL and MAIN mix signals. This gives you the interesting possibility of hearing both the outgoing (MAIN) and incoming (PFL) tracks simultaneously through a single output, via your headphones. The same signal can be heard at the monitor output so long as the PHONES TO MONITOR button [31], sited above the MONITOR fader, is depressed. (PHONES TO MONITOR forces the monitor output to follow the headphones.)

7.3 Permanent PFL—using PFL as a listening subgroup

We have seen that with both the PHONES TO MONITOR and PFL/MAIN switches depressed your monitor output is always looking at PFL, not switching automatically between PFL and the main mix. Now you can actually use the stereo PFL bus as a subgroup with its own stereo output (the MONITOR output).

 **Another way to keep the monitors fixed on PFL is to make sure a PFL button is always left engaged somewhere on the desk. You could simply leave a PFL button depressed on an unused, unassigned channel.**

If your channel fader is always brought up to +6 dB (i.e. full-on as per usual with you DJ types) then comparing PFL values will give a true indication of relative mix volume between tracks. Now all you have to do in order to achieve a totally professional-sounding volume-consistent mix is to adjust each successively incoming track's gain until the PFL meter is hitting 0 dB (or whatever level you think you can get away with) before you bring it in with the crossfader. It's that simple. Try it ...

8. SUB BASS

The sub bass output [63](#) on the back panel comes with two rotary controls, one for output LEVEL [62](#) (max. +22 dBu) and another for adjusting the crossover frequency of the low pass filter, X-OVER FREQ. [61](#) (low pass filter variable from 30 Hz to 200 Hz). This can be used to drive a very low frequency sound system in a studio or club to provide added bottom end.

 **Sub bass units are often useful in small studios where there is no room for large extended-range monitors in front of the mixer.**

9. CONTROLLING EXTERNAL DEVICES

9.1 Desk lamp

A connector [37](#) for an optional standard 12 V working light is offered, immediately above the bargraph meters. You should only use 5 watts lights. The intensity of this light may be turned down using a DIMMER control [39](#), depending on how much mystery you want to create in the DJ box!

9.2 Remote control of audio devices

We have not yet mentioned the big non-latching buttons [20](#) immediately below the faders on channels 3 to 7. These have nothing to do with the audio side of your desk. They are REMOTE CONTROL buttons for interfacing with certain audio sources such as CD players, CART machines etc. which have remote jacks built into them. Please refer to the manufacturer's specifications to see if your equipment conforms to this protocol. If it does, connection to the DX1000 is by simple jack leads [55](#) on the rear panel. Please ensure that your equipment's remote control output does not exceed 30 V DC/50 mA (This is unlikely!).

The advantages of REMOTE CONTROL are purely ergonomic—you don't have to stretch over the desk to bring in an audio file, jingle or music CD in on cue. For clarity of function it is best to associate each REMOTE button on the DX1000 with the device supplying audio to the stereo channel immediately above it. Otherwise things could get very confusing! Please refer to the specifications of the equipment you want to connect.

9.3 Sound-to-light

A mono audio output [60](#) is provided for connection to lighting controllers with a sound-to-light facility. Connection is via a standard 1/4" jack on the back panel. Sensitivity is conveniently adjustable from the DX1000 by the LIGHT LEVEL knob [40](#) to the left of the bargraph meters. Too high, and the lights will stay on, too low and they won't flash at all. Adjust LIGHT LEVEL until lights flash in time with the music.

10. CONNECTIONS

10.1 PRO MIXER DX1000 connections

Follow us on a walk along the rear panel of your PRO MIXER, starting left:

- 50 **Channel inserts.** For inserting into the channel signal, pre-EQ and pre-fader. Unbalanced, send and return on a single 1/4" jack socket, wired tip = send (out), ring = return (in) and sleeve = ground/screen.
- 51 **Line input.** Balanced 1/4" jack socket, wired tip = hot (+ve), ring = cold (-ve) and sleeve = ground/screen.
- 52 **Mic input.** Balanced XLR, wired pin 1 = ground/screen, 2 = hot (+ve) and 3 = cold (-ve).
- 53 **Aux send.** Unbalanced 1/4" jack socket, wired tip = signal and sleeve = ground/screen.
- 54 **Effect return.** Unbalanced 1/4" jack sockets, wired tip = signal and sleeve = ground/screen.
- 55 **Remote control.** 1/4" jack socket.
- 56 **Line Input (Input 7).** Unbalanced 1/4" jack sockets, wired tip = signal and sleeve = ground/screen.
- 57 **Tape inputs.** RCA sockets.
- 58 **CD inputs.** RCA sockets.
- 59 **Phono inputs.** RCA sockets.
- 60 **Light out.** Unbalanced 1/4" jack socket, wired tip = signal and sleeve = ground/screen.
- 63 **Subbass out.** Balanced XLR, wired pin 1 = ground/screen, pin 2 = hot (+ve) and pin 3 = cold (-ve).
- 64 **Main inserts.** For inserting into the main mix signal. Unbalanced, send and return of one channel on a single 1/4" jack socket, wired tip = send (out), ring = return (in) and sleeve = ground/screen.
- 65 **Main outputs.** Balanced 1/4" jack sockets, wired tip = hot (+ve), ring = cold (-ve) and sleeve = ground/screen.
- 66 **Tape out (with voice).** RCA sockets.
- 67 **Main outputs.** Balanced XLR, wired pin 1 = ground/screen, pin 2 = hot (+ve) and pin 3 = cold (-ve).
- 68 **Monitor outputs.** Unbalanced 1/4" jack, wired tip = signal and sleeve = ground/screen.
- 69 **Zone outputs.** Unbalanced 1/4" jack, wired tip = signal and sleeve = ground/screen.
- 70 **Monitor outputs.** Balanced XLR, wired pin 1 = ground/screen, pin 2 = hot (+ve) and pin 3 = cold (-ve).
- 72 **AC power in.** For connecting the mixer to the Power Supply Unit (PSU). Always connect the mixer and PSU before you connect the PSU to the mains supply.

And on the front panel:

- 21 **Tape in.** RCA sockets.
- 22 **Tape out (without voice).** RCA sockets.
- 43 **Phones.** 1/4" jack socket, wired tip = left signal, ring = right signal and sleeve = ground/screen.

 **Please ensure that only qualified persons install and operate the PRO MIXER DX1000. During installation and operation the user must have sufficient electrical contact to earth. Electrostatic charges might affect the operation of the PRO MIXER DX1000!**

10.2 Plug soldering guide

You will need a lot of cables for different purposes—see the following figures to make sure you have got the right ones.

Use custom-made RCA cables for all connections which use RCA sockets (centre post = signal (+ve) and sleeve = ground/screen).

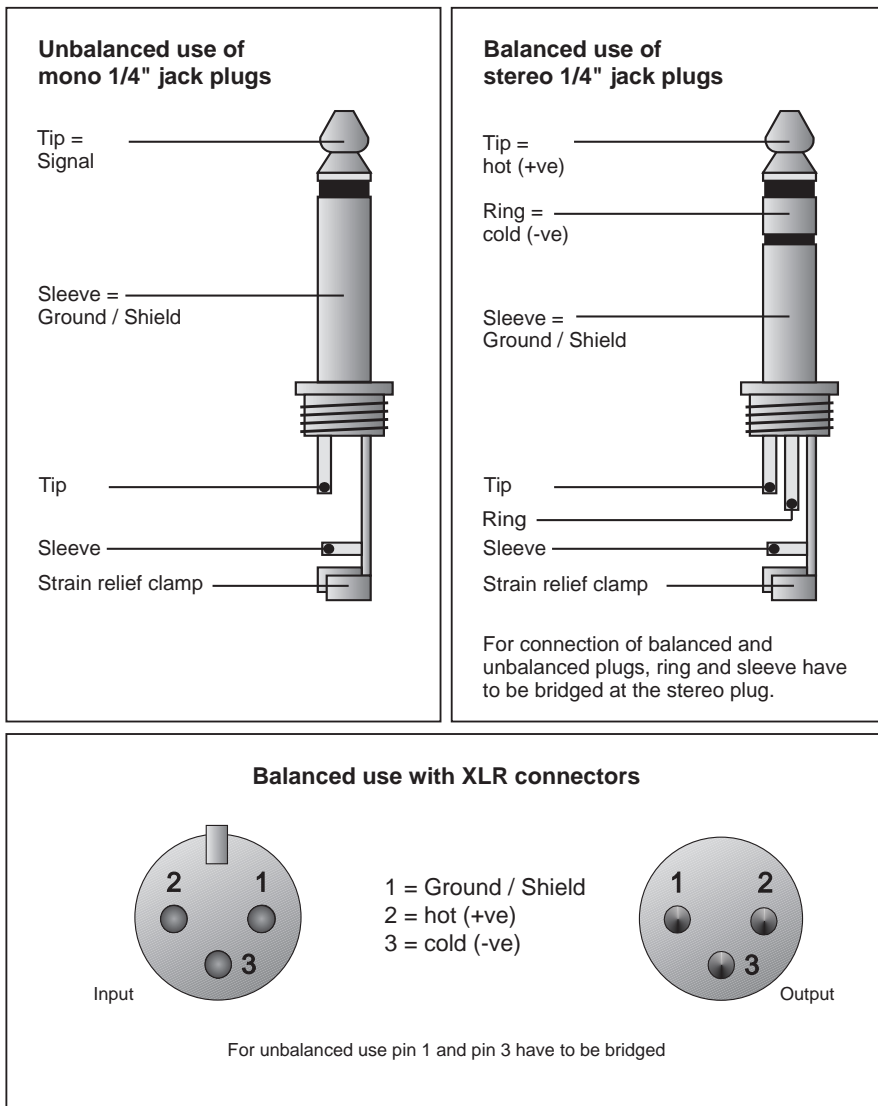

Fig. 10.1: Un-/balanced jack plugs and balanced XLR connectors

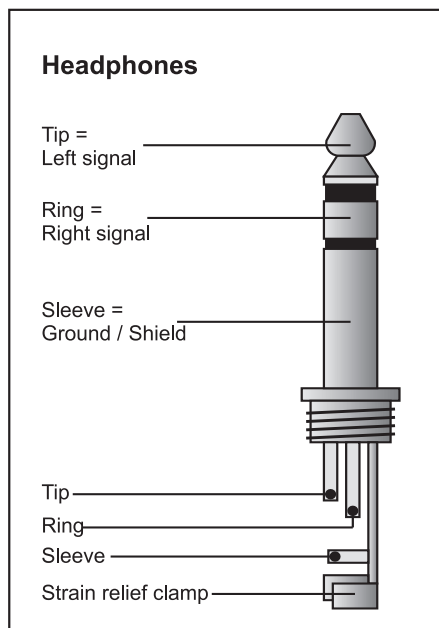

Fig. 10.2: Headphones connector

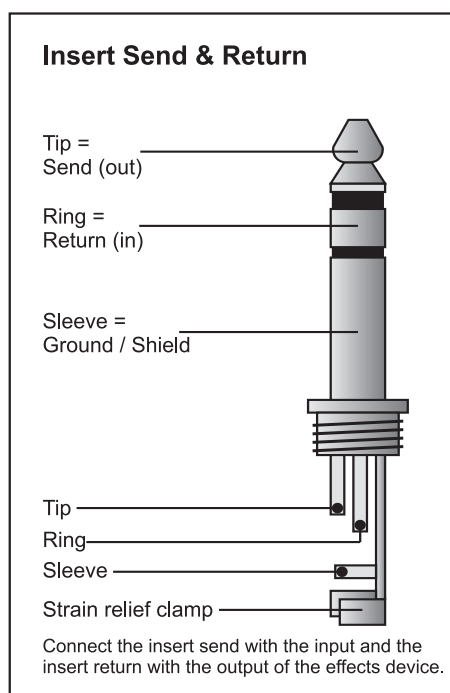



Fig. 10.3: Insert send/return plug

11. CROSSFADER ADJUSTMENT

On the main motherboard you can find two potentiometers, which you can adjust with a little screwdriver. These potentiometers are identified as OVERLAP and SLOPE. You can unscrew the bottom of your mixer to reach the main motherboard.

 **Please be aware that the BEHRINGER warranty becomes discretionary when you start disassembling your DX1000! Don't even think of it, if you make much of your warranty privileges. Sorry, but we have to mention this.**

11.1 Overlap

With the OVERLAP potentiometer (VR43) you can adjust the increase or decrease in dB, which is conducted when the crossfader is located in the middle position. Ex works this value is adjusted at -3 dB and should not be modified. This guarantees a constant volume across the entire fader path.

11.2 Slope

With the SLOPE potentiometer (VR44) you can adjust the fade over process of the both channels. Dependent on the setting of the SLOPE potentiometer there are the following volume curves:

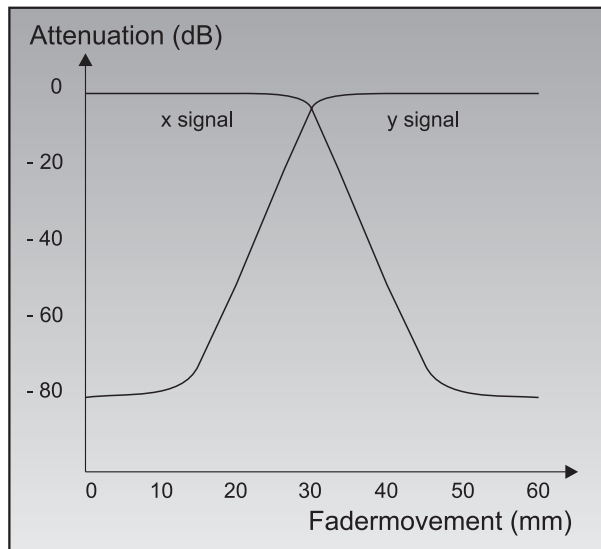

Fig. 11.1: Volume curve I (SLOPE potentiometer completely left)

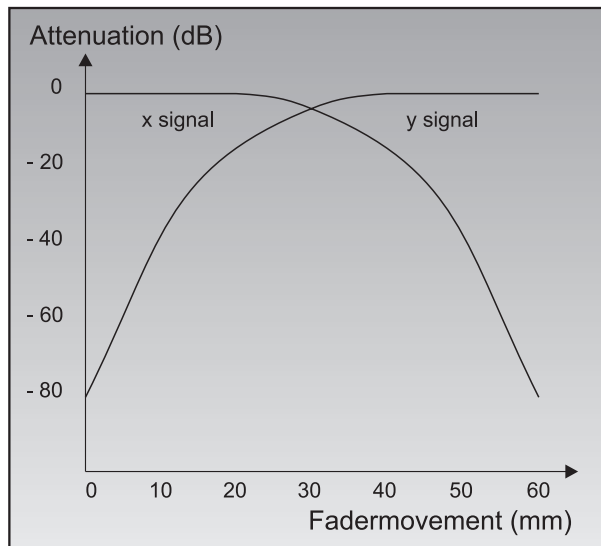

Fig. 11.2: Volume curve II (SLOPE potentiometer completely right)

12. SPECIFICATIONS

MONO INPUT CHANNELS

Mic input	Electronically balanced, discrete input configuration
Gain	+10 to +60 dB
Frequency response	10 Hz to 100 kHz, +/-3 dB
THD	0.06 % typ. @ -30 dBu, 1 kHz
Line input	
Gain	-10 dB to +40 dB
Frequency response	10 Hz to 100 kHz, +/-3 dB
THD	0.03 % typ. @ 0 dBu, 1 kHz
S/N ratio	> 80 dB, unweighted

EQ		
	Low	+/-12 dB @ 50 Hz
	Mid	+/-9 dB @ 750 Hz
	High	+/-12 dB @ 10 Hz
	Low cut	75 Hz, 18 dB/oct.
STEREO INPUT CHANNELS		
	Phono/line/CD input	unbalanced input
	Gain	
	Line/CD	+/-15 dB
	Phono	+/-15 dB (variable from +25 dB to +55 dB)
	Frequency response	
	Line/CD	10 Hz to 100 kHz, +/-3 dB
	Phono	20 Hz to 20 kHz, RIAA
	THD	
	Line/CD	0.025 % typ. @ 0 dBu, 1 kHz
	Phono	0.035 % typ. @ -30 dBu, 1 kHz
	S/N ratio	
	Line/CD	> 80 dB, unweighted
	Phono	> 70 dB, unweighted
	EQ	
	Low	50 Hz, +/-12 dB
	Mid	700Hz, +/-8 dB
	High	10 kHz, +/-12 dB
CONNECTORS		
	Master out	
	Jack	0 dB
	XLR	+6 dB
	Monitor out	
	Jack	0 dB (max. 10 dB gain)
	Zone out	
	Jack	0 dB (max. 10 dB gain)
	Insert send	0 dB
	Insert return	0 dB
	Effect send	0 dB
POWER SUPPLY		
	Mains Voltages	USA/Canada 120 V ~, 60 Hz, PSU MXUL 1 U.K./Australia 240 V ~, 50 Hz, PSU MXEU 1 Europe 230 V ~, 50 Hz, PSU MXEU 1 General Export Model 100 - 120 V ~, 200 - 240 V ~, 50 - 60 Hz
	Power supply units	
	Model MXEU 1	In: 230 V ~ / 50 Hz (250 mA) Out: 2 * 19.5 V ~ (1200 mA)
	Model MXUL 1	In: 115 V ~ / 60 Hz (500 mA) Out: 2 * 19.5 V ~ (1200 mA)
PHYSICAL		
	Dimensions (approx.)	2 3/8" / 6" (60.96 mm / 152.4 mm) * 17 1/4" (440 mm) * 14" (355.6 mm)
	Net weight (without PSU)	6.5 kg

BEHRINGER is constantly striving to maintain the highest professional standards. As a result of these efforts, modifications may be made from time to time to existing products without prior notice. Specifications and appearance may differ from those listed or illustrated.

13. WARRANTY

§ 1 WARRANTY CARD/ONLINE REGISTRATION

To be protected by the extended warranty, the buyer must complete and return the enclosed warranty card within 14 days of the date of purchase to BEHRINGER Spezielle Studiotechnik GmbH, in accordance with the conditions stipulated in § 3. Failure to return the card in due time (date as per postmark) will void any extended warranty claims.

Based on the conditions herein, the buyer may also choose to use the online registration option via the Internet (www.behringer.com or www.behringer.de).

§ 2 WARRANTY

1. BEHRINGER (BEHRINGER Spezielle Studiotechnik GmbH including all BEHRINGER subsidiaries listed on the enclosed page, except BEHRINGER Japan) warrants the mechanical and electronic components of this product to be free of defects in material and workmanship for a period of one (1) year from the original date of purchase, in accordance with the warranty regulations described below. If the product shows any defects within the specified warranty period that are not due to normal wear and tear and/or improper handling by the user, BEHRINGER shall, at its sole discretion, either repair or replace the product.

2. If the warranty claim proves to be justified, the product will be returned to the user freight prepaid.

3. Warranty claims other than those indicated above are expressly excluded.

§ 3 RETURN AUTHORIZATION NUMBER

1. To obtain warranty service, the buyer (or his authorized dealer) must call BEHRINGER (see enclosed list) during normal business hours **BEFORE** returning the product. All inquiries must be accompanied by a description of the problem. BEHRINGER will then issue a return authorization number.

2. Subsequently, the product must be returned in its original shipping carton, together with the return authorization number to the address indicated by BEHRINGER.

3. Shipments without freight prepaid will not be accepted.

§ 4 WARRANTY REGULATIONS

1. Warranty services will be furnished only if the product is accompanied by a copy of the original retail dealer's invoice. Any product deemed eligible for repair or replacement by BEHRINGER under the terms of this warranty will be repaired or replaced within 30 days of receipt of the product at BEHRINGER.

2. If the product needs to be modified or adapted in order to comply with applicable technical or safety standards on a national or local level, in any country which is not the country for which the product was originally developed and manufactured, this modification/adaptation shall not be considered a defect in materials or workmanship. The warranty does not cover any such modification/adaptation, irrespective of whether it was carried out properly or not. Under the terms of this warranty, BEHRINGER shall not be held responsible for any cost resulting from such a modification/adaptation.

3. Free inspections and maintenance/repair work are expressly excluded from this warranty, in particular, if caused by improper handling of the product by the user.

This also applies to defects caused by normal wear and tear, in particular, of faders, potentiometers, keys/buttons and similar parts.

4. Damages/defects caused by the following conditions are not covered by this warranty:

- ▲ misuse, neglect or failure to operate the unit in compliance with the instructions given in BEHRINGER user or service manuals.

- ▲ connection or operation of the unit in any way that does not comply with the technical or safety regulations applicable in the country where the product is used.

- ▲ damages/defects caused by force majeure or any other condition that is beyond the control of BEHRINGER.

5. Any repair or opening of the unit carried out by unauthorized personnel (user included) will void the warranty.

6. If an inspection of the product by BEHRINGER shows that the defect in question is not covered by the warranty, the inspection costs are payable by the customer.

7. Products which do not meet the terms of this warranty will be repaired exclusively at the buyer's expense. BEHRINGER will inform the buyer of any such circumstance. If the buyer fails to submit a written repair order within 6 weeks after notification, BEHRINGER will return the unit C.O.D. with a separate invoice for freight and packing. Such costs will also be invoiced separately when the buyer has sent in a written repair order.

§ 5 WARRANTY TRANSFERABILITY

This warranty is extended exclusively to the original buyer (customer of retail dealer) and is not transferable to anyone who may subsequently purchase this product. No other person (retail dealer, etc.) shall be entitled to give any warranty promise on behalf of BEHRINGER.

§ 6 CLAIM FOR DAMAGES

Failure of BEHRINGER to provide proper warranty service shall not entitle the buyer to claim (consequential) damages. In no event shall the liability of BEHRINGER exceed the invoiced value of the product.

§ 7 OTHER WARRANTY RIGHTS AND NATIONAL LAW

1. This warranty does not exclude or limit the buyer's statutory rights provided by national law, in particular, any such rights against the seller that arise from a legally effective purchase contract.

2. The warranty regulations mentioned herein are applicable unless they constitute an infringement of national warranty law.

The information contained in this manual is subject to change without notice. No part of this manual may be reproduced or transmitted in any form or by any means, electronic or mechanical, including photocopying and recording of any kind, for any purpose, without the express written permission of BEHRINGER Spezielle Studiotechnik GmbH.

BEHRINGER and FEEDBACK DESTROYER are registered trademarks. ALL RIGHTS RESERVED.

© 2001 BEHRINGER Spezielle Studiotechnik GmbH.

BEHRINGER Spezielle Studiotechnik GmbH, Hanns-Martin-Schleyer-Str. 36-38, 47877 Willich-Münchheide II, Germany

Tel. +49 (0) 21 54 / 92 06-0, Fax +49 (0) 21 54 / 92 06-30
