

COLORstrip™ Mini

Snapshot

Use on Dimmer	⊘
Outdoor Use	⊘
Sound Activated	✓
DMX	✓
Master/Slave	✓
Auto-ranging Power Supply	✓
Replaceable Fuse	✓
User Serviceable	⊘
Duty Cycle	⊘

USER MANUAL



3000 N 29th Ct, Hollywood, FL 33020 U.S.A.
(800) 762-1084 – (954) 929-1115
FAX (954) 929-5560
www.chauvetlighting.com



Intertek

TABLE OF CONTENTS

1. Before You Begin	3
What is included.....	3
Unpacking Instructions.....	3
AC Power.....	3
Safety Instructions	4
2. Introduction	5
Features.....	5
DMX Channel Summary	5
Product Overview.....	6
Product Dimensions.....	7
3. Setup	8
Fuse Replacement.....	8
Fixture Linking.....	8
Data Cabling	8
DMX Data Cable	8
Cable Connectors	9
3-Pin to 5-Pin Conversion Chart	9
Setting up a DMX Serial Data Link.....	9
Master/Slave Fixture Linking.....	10
Mounting	10
Orientation	10
Rigging.....	10
4. Operating Instructions	11
Using the control panel	11
Control Panel Modes & Functions.....	11
Master/Slave & Stand Alone	12
Built in programs detailed.....	12
DMX Control Mode	13
DMX Channel Values.....	14
General Troubleshooting	15
Contact Us	15
5. Appendix	16
DMX Primer	16
General Maintenance.....	17
Returns Procedure.....	17
Claims.....	17
Technical Specifications	18

1. BEFORE YOU BEGIN

What is included

- 1 x COLORstrip™ Mini
- 2 x Tall Mounting Brackets
- 2 x Short Mounting Brackets
- 1 x Power Cord
- 1 x Warranty Card
- 1 x User Manual

Unpacking Instructions

Immediately upon receiving a fixture, carefully unpack the carton, check the contents to ensure that all parts are present, and have been received in good condition. Notify the shipper immediately and retain packing material for inspection if any parts appear damaged from shipping or the carton itself shows signs of mishandling. Save the carton and all packing materials. In the event that a fixture must be returned to the factory, it is important that the fixture be returned in the original factory box and packing.

AC Power

This fixture has an auto-switching power supply that can accommodate a wide range of input voltages. The only thing necessary to do before powering on the unit is to make sure the line voltage you are applying is within the range of accepted voltages. This fixture will accommodate between 100V and 240V AC 50-60 Hz. All fixtures must be powered directly off a switched circuit and cannot be run off a rheostat (variable resistor) or dimmer circuit, even if the rheostat or dimmer channel is used solely for a 0% to 100% switch.

Warning! ***All fixtures must be connected to circuits with a suitable Earth Ground.***

Safety Instructions



Please read these instructions carefully, which includes important information about the installation, usage and maintenance of this product?

- Please keep this User Guide for future consultation. If you sell the unit to another user, be sure that they also receive this instruction booklet.
- Always make sure that you are connecting to the proper voltage, and that the line voltage you are connecting to is not higher than that stated on the decal or rear panel of the fixture.
- This product is intended for indoor use only!
- To prevent risk of fire or shock, do not expose fixture to rain or moisture. Make sure there are no flammable materials close to the unit while operating.
- Always disconnect from power source before servicing or replacing fuse and be sure to replace with same type fuse.
- Secure fixture to fastening device using a safety chain.
- Maximum ambient temperature (Ta) is 104°F (40°C). Do not operate fixture at temperatures higher than this.
- In the event of a serious operating problem, stop using the unit immediately. Never try to repair the unit by yourself. Repairs carried out by unskilled people can lead to damage or malfunction. Please contact the nearest authorized technical assistance center. Always use the same type spare parts.
- Never connect the device to a dimmer pack.
- Make sure the power cord is never crimped or damaged.
- Never disconnect the power cord by pulling or tugging on the cord.
- Avoid direct eye exposure to the light source while it is on.
- Do not daisy chain power to more than 32 units @ 120V, and 60 units @ 230V.

Caution!

There are no user serviceable parts inside the unit. Do not open the housing or attempt any repairs yourself. In the unlikely event your unit may require service, please contact CHAUVET at: 954-929-1115.

2. INTRODUCTION

Features

- 4-channel DMX-512 LED linear wash light
- Blackout/static/dimmer/strobe
- Static colors and RGB color mixing with or without DMX controller
- Built-in automated programs via Master/Slave or DMX
- Built-in sound active programs via Master/Slave or DMX

ADDITIONAL FEATURES

- Additional power output: max 32 units @ 120V
- Additional Slave output allows for color-changing runway effect (up to 31 units)

OPTIONS

- COLORstrip™ Foot Controller (LED-FS1)

DMX Channel Summary

Blackout and Static/Flashing colors		Chase Programs		RGB Mode		Color Fade Mode	
CH	DESCRIPTION	CH	DESCRIPTION	CH	DESCRIPTION	CH	DESCRIPTION
1	DMX: (000~079) Static Colors	1	DMX: (080~209) Programs 1 ~ 13	1	DMX: (210~219) RGB Color Mix	1	DMX: (220~255) Color Fade and Auto Run
2	No Function	2	Run Speed	2	Red	2	Run/Fade Speed
3	Flash Speed	3	Flash Speed	3	Green	3	No Function
4	No Function			4	Blue	4	No Function

For a detailed view of DMX values, turn to the DMX Channel Values on page 14.

Product Overview

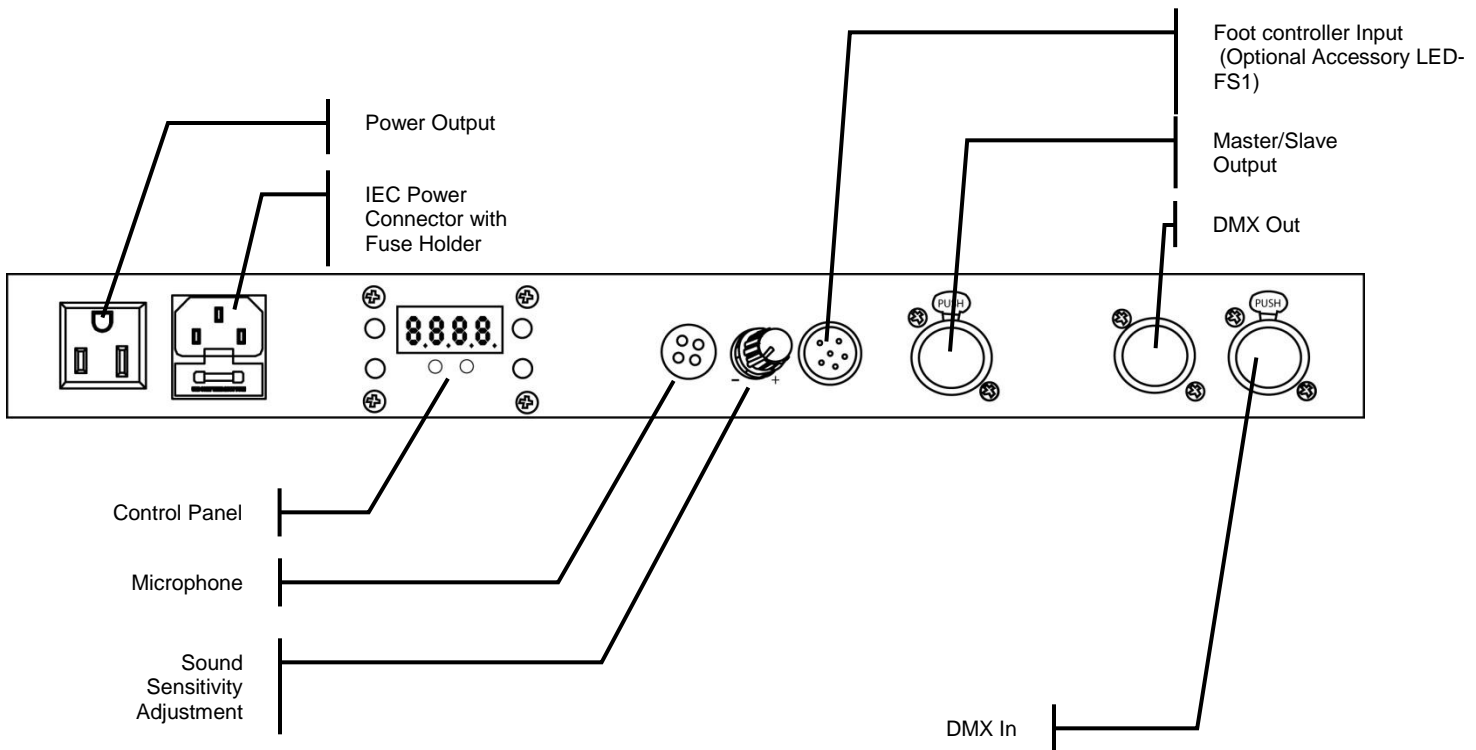
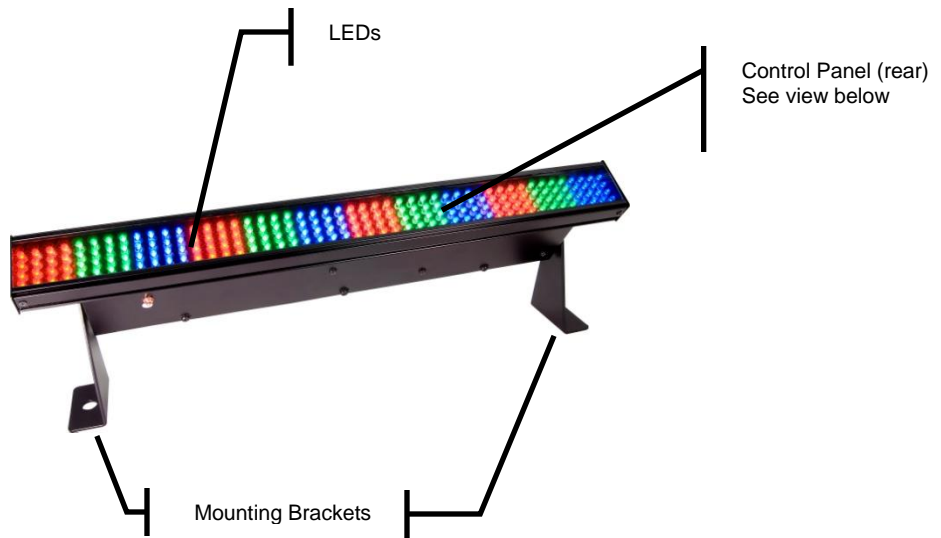

Product Dimensions

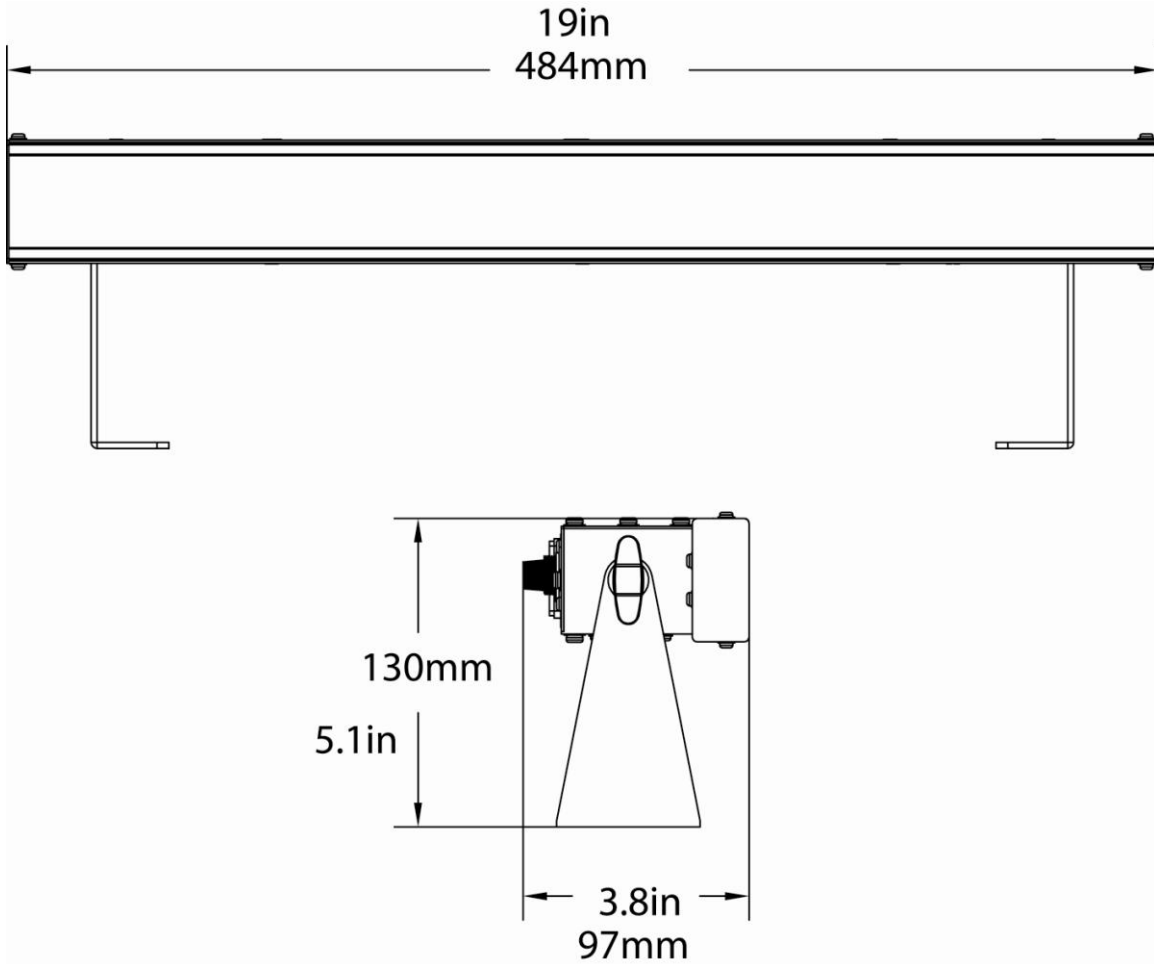

3. SETUP



Disconnect the power cord before replacing a fuse and always replace with the same type fuse.



Fuse Replacement

1. With a flat head screwdriver, wedge the fuse holder out of its housing.
2. Remove the damaged fuse from its holder and replace with exact same type fuse.
3. Insert the fuse holder back in its place, and reconnect power.

The fuse is located inside this compartment. Remove using a flat head screwdriver.

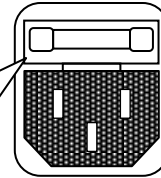

Fixture Linking

You will need a serial data link to run light shows of one or more fixtures using a DMX-512 controller or to run synchronized shows on two or more fixtures set to a Master/Slave operating mode. The combined number of channels required by all the fixtures on a serial data link determines the number of fixtures the data link can support.

Important: Fixtures on a serial data link must be daisy chained in one single line. To comply with the EIA-485 standard no more than 32 devices should be connected on one data link. Connecting more than 32 fixtures on one serial data link without the use of a DMX optically-isolated splitter may result in deterioration of the digital DMX signal.

Maximum recommended serial data link distance: 500 meters (1640 ft.)

Maximum recommended number of fixtures on a serial data link: 32 fixtures

Data Cabling

To link fixtures together you must obtain data cables. You can purchase CHAUVET-certified DMX cables directly from a dealer/distributor or construct your own cable. If you choose to create your own cable please use data-grade cables that can carry a high quality signal and are less prone to electromagnetic interference.

DMX DATA CABLE

Use a Belden© 9841 or equivalent cable which meets the specifications for EIA RS-485 applications. Standard microphone cables cannot transmit DMX data reliably over long distances. The cable must have the following characteristics:

*2-conductor twisted pair plus a shield
Maximum capacitance between conductors – 30 pF/ft.
Maximum capacitance between conductor and shield – 55 pF/ft.
Maximum resistance of 20 ohms / 1000 ft.
Nominal impedance 100 – 140 ohms*

CABLE CONNECTORS

Cablings must have a male XLR connector on one end and a female XLR connector on the other end.

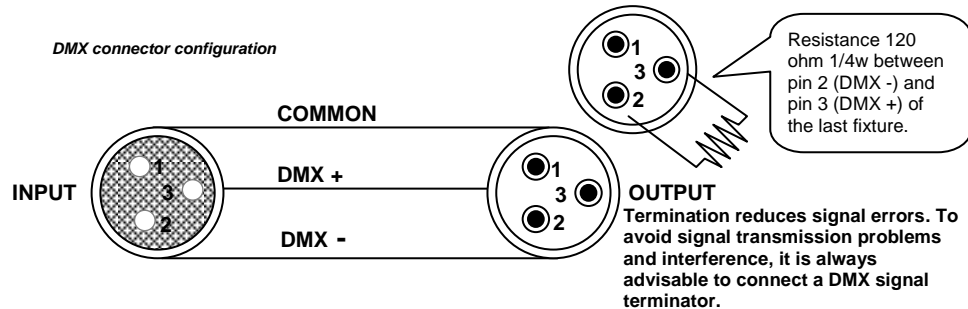

CAUTION Do not allow contact between the common and the fixture's chassis ground. Grounding the common can cause a ground loop, and your fixture may perform erratically. Test cables with an ohm meter to verify correct polarity and to make sure the pins are not grounded or shorted to the shield or each other.

3-PIN TO 5-PIN CONVERSION CHART

Note! If you use a controller with a 5 pin DMX output connector, you will need to use a 5 pin to 3 pin adapter. CHAUVET Model No: DMX5M, or DMX5F. The chart below details a proper cable conversion:

3 PIN TO 5 PIN CONVERSION CHART

Conductor	3 Pin Female (output)	5 Pin Male (Input)
Ground/Shield	Pin 1	Pin 1
Data (-) signal	Pin 2	Pin 2
Data (+) signal	Pin 3	Pin 3
Do not use		Pin 4
Do not use		Pin 5

Setting up a DMX Serial Data Link

1. Connect the (male) 3 pin connector side of the DMX cable to the output (female) 3 pin connector of the controller.
2. Connect the end of the cable coming from the controller which will have a (female) 3 pin connector to the input connector of the next fixture consisting of a (male) 3 pin connector.
3. Then, proceed to connect from the output as stated above to the input of the following fixture and so on.

CHAUVET Certified DMX Data Cables

Order Code	Description
DMX1.5	DMX Cable 1.5m/4.9ft

Universal DMX Controller

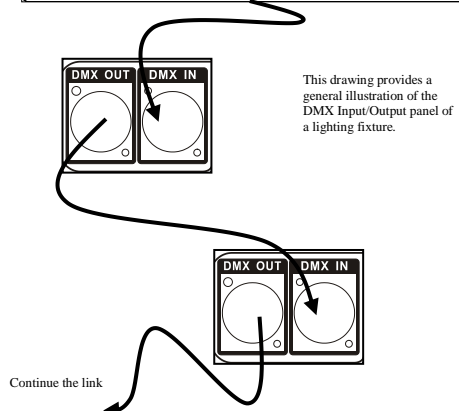
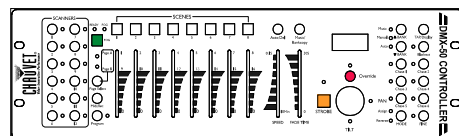

DMX4.5	DMX Cable 4.5m/14.8ft
DMX10	DMX Cable 10m/32.8ft

Master/Slave Fixture Linking

1. Connect the (male) 3 pin connector side of the DMX cable to the output (female) 3 pin connector of the first fixture.
2. Connect the end of the cable coming from the first fixture which will have a (female) 3 pin connector to the input connector of the next fixture consisting of a (male) 3 pin connector. Then, proceed to connect from the output as stated above to the input of the following fixture and so on.

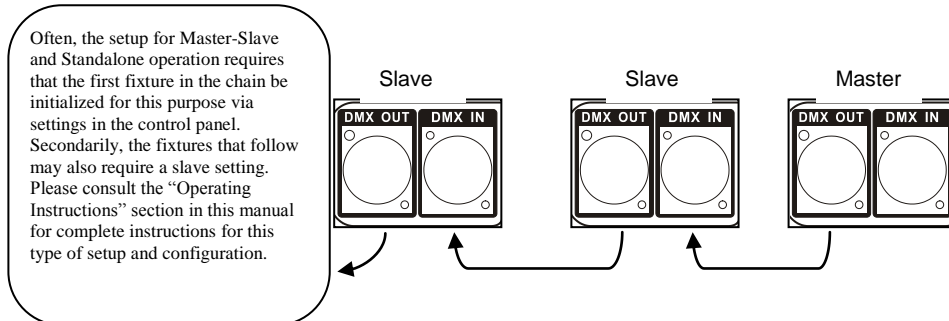

Mounting

ORIENTATION

This fixture may be mounted in any safe position.

RIGGING

Mount the fixture using, a suitable "C" or "O" type clamp. Adjust the angle of the fixture by loosening both knobs tilting the fixture. After finding the desired position, retighten both knobs.

- When selecting installation location, take into consideration fuse replacement and routine maintenance.
- 2 clamps must be used with this fixture.
- Safety cables must always be used.
- Never mount in places where the fixture will be exposed to rain, high humidity, extreme temperature changes or restricted ventilation.

Hanging Clamp

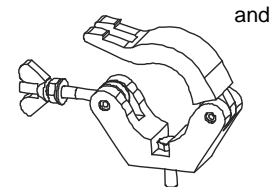

Note!
Clamp is sold separately.

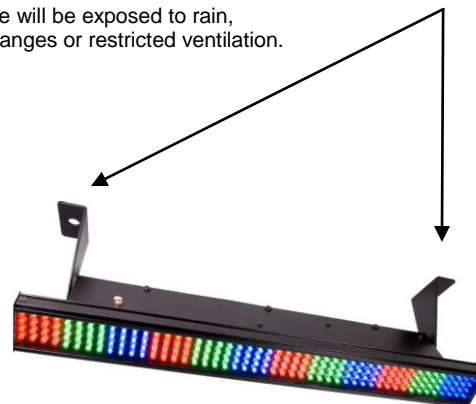

4. OPERATING INSTRUCTIONS

The COLORstrip™ Mini is a DMX-512 controllable, dimming white LED strip light fixture made up of highly efficient and super bright LEDs.

The COLORstrip™ Mini can operate in Stand-Alone, Master/Slave and via DMX-512 control utilizing 4 channels of control.

Using the control panel

1. Press the **MODE** button repeatedly to back out of a function.
2. Press the **DOWN/UP** buttons to toggle or through values that pertain to that function.
3. Press **ENTER** to enter the sub-menus.

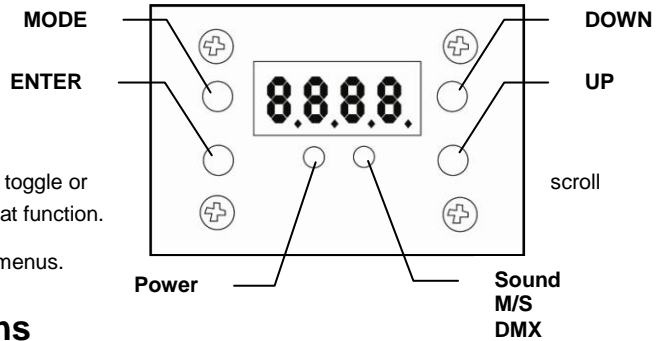

Control Panel Modes & Functions

MODE	FUNCTION	PROGRAM	FUNCTION/PROGRAM	(P) RUN SPEED	(F) FLASH SPEED	(C) COLOR	
A A C t	A 000- 023	000	Blackout				
		001	Red		000 – 100		
		002	Green		000 - 100		
		003	Blue		000 - 100		
		004	Yellow		000 - 100		
		005	Purple		000 - 100		
		006	Cyan		000 - 100		
		007	White		000 - 100		
		008	Color change 1	Automatic 000 - 050		000 - 100	
		009	Color change 2			000 - 100	
		010	Color change 3			000 - 100	
		011	Color change 4			000 - 100	
		012	Color change 5				
		013	Color change 6				
		014	Sequential Chase 1		Sound Active 051 - 100		
		015	Sequential Chase 2				
		016	Sequential Chase 3				
		017	Sequential Chase 4				
		018	Sequential Chase 5				
		019	Sequential Chase 6				
		020	Sequential Chase 7				
		021	RGB		Red (000-100)	Green (000-100)	Blue (000-100)
		022	Color Fade		000-100		
023	Automatic Program (Sound)						
	S dAd		DMX Channel Addressing				

Master/Slave & Stand Alone

The Master/Slave mode will allow you to link units in a daisy chain fashion. In this mode, the first unit in the daisy chain will command all other units following. Stand Alone can simply be achieved by setting all units to Master. They would no longer be required to be linked in series.

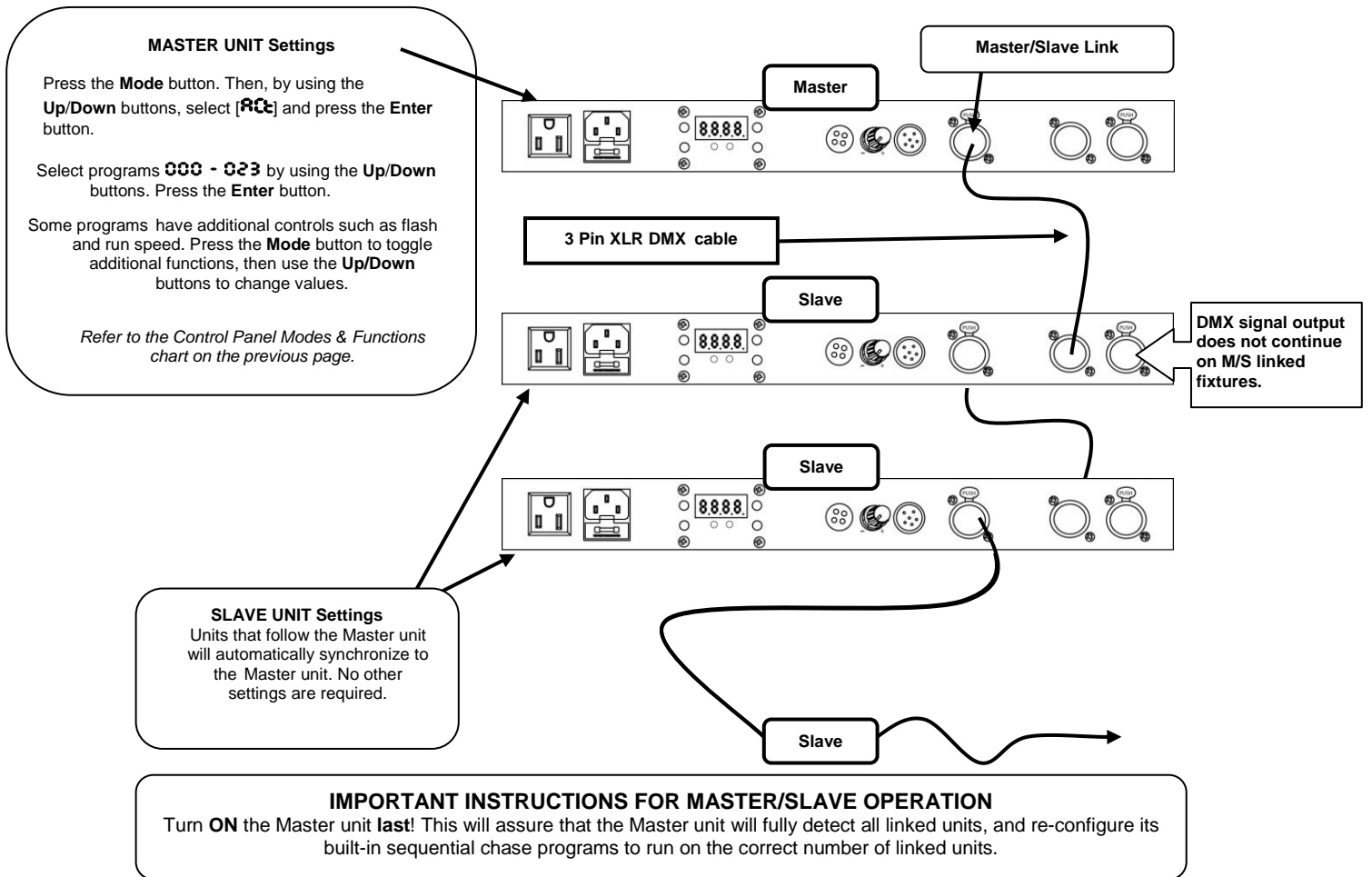

Built in programs detailed

PROGRAM	FUNCTION	OPTIONS
000	Blackout	
001-007	Solid flashing colors	F = Flash speed
008-013	Color chase programs	P = Run speed F = Flash speed
014-020	Sequential color chase patterns	Use sound sensitivity rotary knob to adjust sound level for optimum response or decrease sensitivity completely to operate in Run speed only P = Run speed
021	RGB (manual color mix)	P = Red

F = Green

C = Blue

P = Run speed

DMX Control Mode

Operating in a DMX Control mode environment gives the user the greatest flexibility, when it comes to customizing or creating a show. In this mode, you will be able to control each individual trait of the fixture and each fixture independently.

Daisy Chain Connection

1. Connect the (male) 3 pin connector side of the DMX cable to the output (female) 3 pin connector of the first fixture.
2. Connect the end of the cable coming from the first fixture which will have a (female) 3 pin connector to the input connector of the next fixture consisting of a (male) 3 pin connector. Then, proceed to connect from the output, as stated above, to the input of the following fixture and so on.

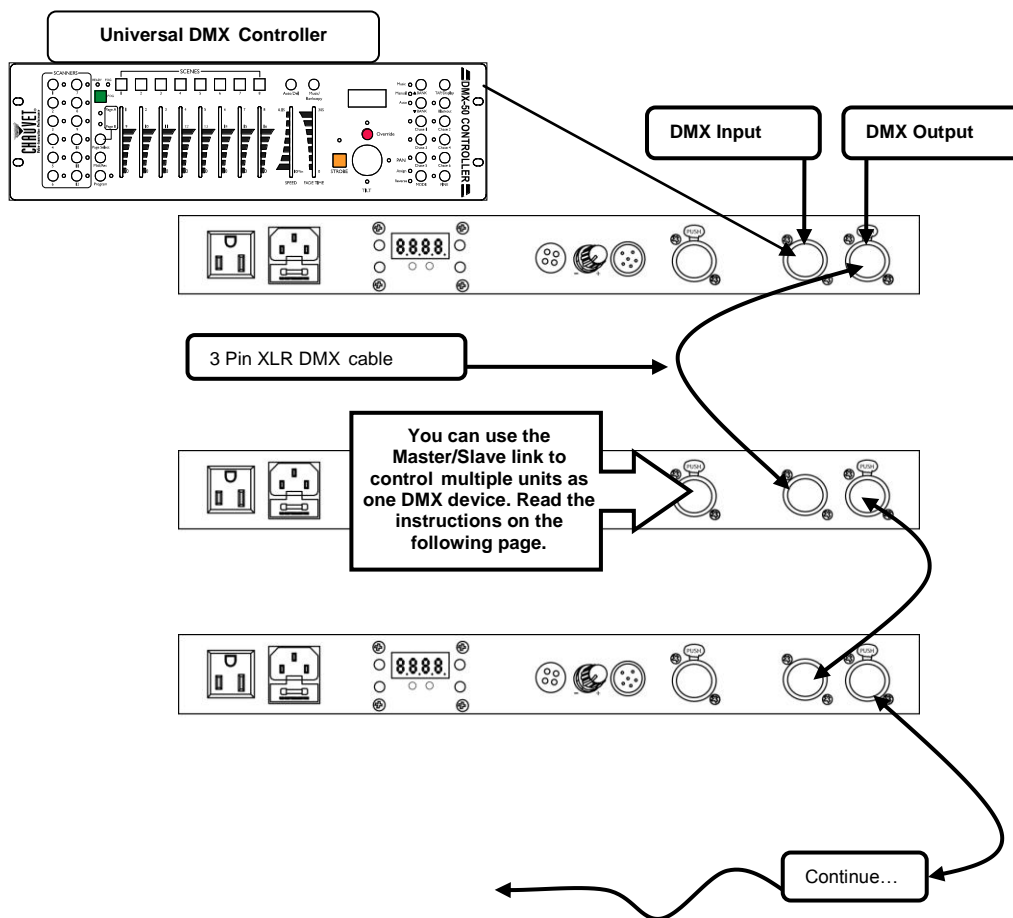

DMX mode setup

1. Press the **Mode** button, until the display reads [SYS]; then, press **Enter**.
2. Press the **Up/Down** buttons until the display reads [S dAd]; then press **Enter**.
3. Set the DMX address value by using the **Up/Down** buttons. Press **Enter**.
4. Press the **Mode** button.

5. Press **Enter** to make changes permanent.





DMX Channel Values

NOTE!

Please read all instructions carefully on fixture DMX control mode and addressing.

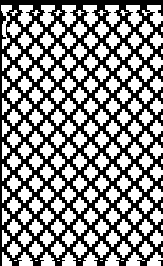
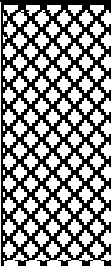
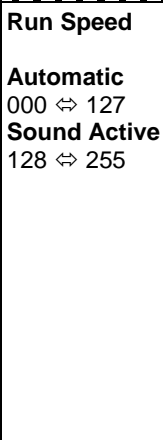
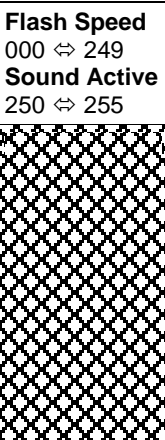
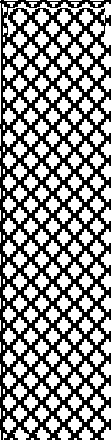
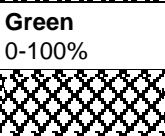
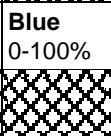
DMX channels 2, 3 and 4 functions are determined by the current settings of channel 1. For example, while Channel 1 is set between 210 and 219 the following conditions will apply;

- Channel 2 will control the red LEDs
- Channel 3 will control the green LEDs
- Channel 4 will control the blue LEDs

Channel	Value	Function	Ch 2	Ch 3	Ch 4
1	000 ⇔ 009	Static Colors Blackout Red Green Blue Yellow Magenta Cyan White		Flash Speed 000 ⇔ 249 Sound Active 250 ⇔ 255	
	010 ⇔ 019				
	020 ⇔ 029				
	030 ⇔ 039				
	040 ⇔ 049				
	050 ⇔ 059				
	060 ⇔ 069				
070 ⇔ 079					
080 ⇔ 089	Color Changes Color change 1 Color change 2 Color change 3 Color change 4 Color change 5 Color change 6				
090 ⇔ 099					
100 ⇔ 109					
110 ⇔ 119					
120 ⇔ 129					
130 ⇔ 139					
140 ⇔ 149	Sequential Color Chases Color chase 1 Color chase 2 Color chase 3 Color chase 4 Color chase 5 Color chase 6 Color chase 7				
150 ⇔ 159					
160 ⇔ 169					
170 ⇔ 179					
180 ⇔ 189					
190 ⇔ 199					
200 ⇔ 209					
210 ⇔ 219	RGB Color Mix RGB mode	Red 0-100%	Green 0-100%	Blue 0-100%	
220 ⇔ 229	Chase Fade	Fade Speed 0-100%			
230 ⇔ 255	Auto Run (sound active only)				

General Troubleshooting

Symptom	Solution(s)
Auto shut off	Check fan thermal switch reset
Breaker/Fuse keeps blowing	Check total load placed on device
Device has no power	Check for power on Mains. Check device's fuse. (internal and/or external)
Fixture is not responding	Check DMX settings for correct addressing Check DMX cables Check polarity switch settings
Fixture is on but there is no movement to the audio	Make sure you have the correct audio mode on Adjust sound sensitivity knob
Light will not come on after power failure	Some discharge lamps require a cooling off period before the electronics in the fixture can kick start it again, wait 5 to 10 minutes before powering up
Loss of signal	Use only DMX cables Install terminator Note: Keep DMX cables separated from power cables or black lights.
No light output	Check fuse Call service technician

If you still have a problem after trying the above solutions, please contact CHAUVET Technical Support at the location below.

Contact Us

World Wide

General Information

CHAUVET
3000 North 29th Court
Hollywood, FL 33020
voice: 954.929.1115
fax: 954.929.5560
toll free: 800.762.1084

Technical Support

CHAUVET
3000 North 29th Court
Hollywood, FL 33020
voice: 954.929.1115 **(Press 4)**
fax: 954.929.5560 **(Attention: Service)**

World Wide Web

www.chauvetlighting.com

5. APPENDIX

DMX Primer

There are 512 channels in a DMX-512 connection. Channels may be assigned in any manner. A fixture capable of receiving DMX 512 will require one or a number of sequential channels. The user must assign a starting address on the fixture that indicates the first channel reserved in the controller. There are many different types of DMX controllable fixtures and they all may vary in the total number of channels required. Choosing a start address should be planned in advance. Channels should never overlap. If they do, this will result in erratic operation of the fixtures whose starting address is set incorrectly. You can however, control multiple fixtures of the same type using the same starting address as long as the intended result is that of unison movement or operation. In other words, the fixtures will be slaved together and all respond exactly the same.

DMX fixtures are designed to receive data through a serial Daisy Chain. A Daisy Chain connection is where the DATA OUT of one fixture connects to the DATA IN of the next fixture. The order in which the fixtures are connected is not important and has no effect on how a controller communicates to each fixture. Use an order that provides for the easiest and most direct cabling. Connect fixtures using shielded two conductor twisted pair cable with three pin XLR male to female connectors. The shield connection is pin 1, while pin 2 is Data Negative (S-) and pin 3 is Data positive (S+). CHAUVET carries 3-pin XLR DMX compliant cables, DMX-10 (33'), DMX-4.5 (15') and DMX-1.5 (5')

General Maintenance

To maintain optimum performance and minimize wear fixtures should be cleaned frequently. Usage and environment are contributing factors in determining frequency. As a general rule, fixtures should be cleaned at least twice a month. Dust build up reduces light output performance and can cause overheating. This can lead to reduced lamp life and increased mechanical wear. Be sure to power off fixture before conducting maintenance.

Clean all glass when the fixture is cold with a mild solution of glass cleaner or Isopropyl Alcohol and a soft lint free cotton cloth or lens tissue. Apply solution to the cloth or tissue and drag dirt and grime to the outside of the lens. Gently polish optical surfaces until they are free of haze and lint.

The cleaning of external optical lenses must be carried out periodically to optimize light output. Cleaning frequency depends on the environment in which the fixture operates: damp, smoky or particularly dirty surrounding can cause greater accumulation of dirt on the unit's optics. Clean with soft cloth using normal glass cleaning fluid. Always dry the parts carefully. Clean the external optics at least every 20 days.

Returns Procedure

Returned merchandise must be sent prepaid and in the original packing, call tags will not be issued. Package must be clearly labeled with a Return Merchandise Authorization Number (RMA #). Products returned without an RMA # will be refused. Call CHAUVET and request RMA # prior to shipping the fixture. Be prepared to provide the model number, serial number and a brief description of the cause for the return. Be sure to properly pack fixture, any shipping damage resulting from inadequate packaging is the customer's responsibility. CHAUVET reserves the right to use its own discretion to repair or replace product(s). As a suggestion, proper UPS packing or double-boxing is always a safe method to use.

Note: If you are given an RMA #, please include the following information on a piece of paper inside the box:

- 1) Your name
- 2) Your address
- 3) Your phone number
- 4) The RMA #
- 5) A brief description of the symptoms

Claims

Damage incurred in shipping is the responsibility of the shipper; therefore the damage must be reported to the carrier upon receipt of merchandise. It is the customer's responsibility to notify and submit claims with the shipper in the event that a fixture is damaged due to shipping. Any other claim for items such as missing component/part, damage not related to shipping, and concealed damage, must be made within seven (7) days of receiving merchandise.

Technical Specifications

WEIGHT & DIMENSIONS

Length..... 19 in (484 mm)
Width..... 3.8 in (97 mm)
Height..... 5.1 in (130 mm)
Weight..... 3.3 lbs (1.5 kg)

POWER

Autoswitching..... 100-240VAC 50/60Hz
Fuse..... F2A 250V
Power Consumption..... 21W (0.3A) max @ 120V
Inrush Power..... 0.2A @ 120V
Power Consumption..... 23W (0.2A) max @ 230V
Inrush Power..... 0.3A @ 230V
Power Output..... 32 units max @ 120V, 60 units max @ 230V

COOLING Convection cooled

LIGHT SOURCE

LED..... 192 (64 red, 64 green, 64 blue) 100,000hrs

PHOTO OPTIC

Luminance @ 1m..... 820 lux
Beam Angle..... 37°x33°
Field Angle..... 68°x51°

THERMAL

Maximum ambient temperature..... 104°F (40°C)

CONTROL & PROGRAMMING

Data input locking 3-pin XLR male socket
Data output locking 3-pin XLR female socket
Data pin configuration pin 1 shield, pin 2 (-), pin 3 (+)
Protocols..... DMX-512 USITT
DMX Channels..... 4

ORDERING INFORMATION

COLORstrip™ Mini COLORSTRIPMINI

WARRANTY INFORMATION

Warranty 2-year limited warranty

