

Owner's Manual

PRO-EQ™
Platinum



FISHMAN®
Acoustic Power

Pro-EQ Platinum

Thank you for choosing the Fishman Pro-EQ™ Platinum. Our goal is to provide you with the finest products for amplifying your acoustic instrument - systems that simply let you sound your best. With our long-standing commitment to quality, you can feel confident that your Fishman gear will produce great sound and trouble-free performance for years to come.

*Please take a few minutes to read this guide and familiarize yourself with the pre-amp's controls. Your satisfaction is very important to us. If you have any questions, please contact us at tech@fishman.com; or by telephone at **978-988-9665**.*

DESCRIPTION

Designed in response to requests from players, this versatile preamp/EQ/DI is at home everywhere from local open mic nights to major festival stages. With its simple yet precise controls, you can quickly dial in the natural acoustic sound you're looking for; loud, clear and feedback free.

The Pro-EQ Platinum's four-band equalizer is modeled after our gig-proven Prefix™ Plus onboard preamp, with sliders that are assigned to just the right frequencies for acoustic equalization. A semi-parametric midrange control employs a "constant Q" filter for more precise and consistent tone adjustments. Also borrowed from the Prefix™ design are feedback fighting phase and notch controls.

The Pro-EQ Platinum features our exclusive "Voltage Doubler" technology, which improves both the dynamics and clarity of any pickup. Another innovation utilized in the Platinum is our Smooth™ acoustic compression circuit. This control removes the harsh percussive edge from your amplified sound when you play hard.

Sound engineers will appreciate the Pro-EQ Platinum's pro-audio features which include a balanced XLR out, an XLR pre/post EQ switch, plus optional 48-Volt phantom power operation. This means no more batteries or wall warts if your mixer has phantom power. Unique to the Pro-EQ™ Platinum is a hum-

killing ground lift switch that (unlike other acoustic preamp/DI's) works even when phantom power is applied to the preamp.

QUICK START

1. If you are using the XLR output, set the Pre / Post switch to "Post" position.
2. Adjust the Input gain so that the Clip/Low Battery light barely flashes with strong strumming.
3. Strum hard and raise the Smooth knob up until you hear the Compressor take the percussive edge off your highs.
4. Phase: Flip the Phase switch to the position that sounds best and suppresses mid-bass feedback
5. Notch: To squelch deep bass feedback, adjust the Notch dial between 1:00 and 2:30. The Notch is off in the 7:00 position.

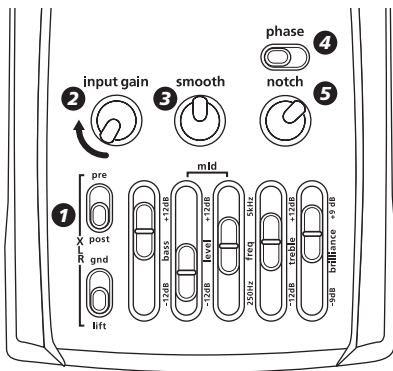

POWER

You can power the preamp three ways:

1. Nine-Volt Battery

Squeeze the two tabs on the top of the preamp together and the battery drawer will pop out. Pull out the Battery clip and snap in a fresh 9-Volt alkaline battery. You can expect 120 hours of continuous use. To conserve the battery, unplug the input of the Pro EQ Platinum when you are not using the preamp.

2. 48-Volt Phantom Power Option

Many microphone mixers can phantom power the Pro EQ Platinum through a standard XLR cable. Turn on phantom power at your mixer and connect an XLR-style microphone cable between the Pro EQ Platinum's XLR out and the mixer's input. The green "phantom" LED lights up when phantom power is supplied to the preamp. Note that the ground lift for the Platinum works even with phantom power applied to the XLR out.

No battery drain will occur when you use phantom power.

3. Nine-Volt AC Adapter Input

Use only a Fishman 910-R or Boss PSA series regulated AC adapter. If a 9-Volt battery is in the preamp, no battery drain will occur when you use an AC adapter.

INPUT

This is for all piezo and magnetic pickups (passive or active). When you plug in here, the 9-Volt battery switches on. Remember to unplug the Input Jack when you are not using the preamp, to conserve the battery's life. It is a good idea to turn down your amp or mixer's input before you plug into this input. Doing so will protect your speakers (and your ears) from loud pops.

INPUT GAIN

Use this knob to set the input level of the preamp for the strongest signal with no noise or distortion.

Adjust the input gain control so the Clip/Battery Low light faintly flashes when you strum hard. Like the trim control on a pro-audio mixer, the input gain accommodates a variety of signal levels.

Input gain is also critical for calibrating the Smooth acoustic compression circuit (see "Smooth" below).

CLIP/LOW BATTERY LED (LIGHT EMITTING DIODE)

This light has three distinct functions:

1. Power Up Indicator

The Clip/Battery Low LED will flash briefly when you first turn on the preamp. Some people ask us, "Why doesn't this light stay on, like a conventional pilot light?" Well, a steadily lit LED devours too many precious hours of battery life. By briefly flashing the light when the unit turns on, we conserve power and extend the useful life of the battery.

2. Clip Indicator / Smooth Acoustic Compression Calibration

The Clip/Low Battery LED will light brightly when the signal from your pickup overloads and distorts the input of the Pro EQ Platinum preamp.

Adjust the Input gain control until the Clip/Low Battery LED faintly flashes when you play your hardest. This will give you the cleanest signal into the preamp, with no distortion. Setting the input gain in this way is also essential for calibrating the Smooth (acoustic compression circuit).

3. Low Battery Warning

When the Clip/Low Battery LED lights steadily with no signal present, it is time to change the battery.

VOLUME

Set this as high as possible (without distorting your amp or mixer) for the cleanest signal.

SMOOTH™ ACOUSTIC COMPRESSION

Takes the percussive edge off of your high end when you play hard.

To set the Smooth control:

1. Turn the Smooth knob fully counter-clockwise.
2. Adjust the Input Gain so that the Clip/Low Battery light faintly flashes when you play your hardest.
3. Raise the Smooth knob (clockwise) just enough to take the percussive edge off your string sound as you strum hard (set the dial at about 12:00). Be aware that turning the Smooth knob up too high may kill the highs for lighter picking styles.

NOTCH AND PHASE

These controls work hand in hand to suppress two adjacent ranges of acoustic feedback. When you set them properly, you can play your instrument as loud as you like, feedback free. We use guitar as an example, but the notch filter and phase switch are compatible with all acoustic instruments.

NOTCH

Tune the Notch filter to scoop out the lowest range of feedback when you play bass notes between the open low E string and (up to and including) the fourth fret G# on the same string. This "cavity resonance" feedback can usually be squelched by setting the Notch control between 1:00 and 2:00 on the dial.

Note that for instruments that do not suffer from low frequency feedback, the notch can be defeated by moving the dial to the 7:00 position.

PHASE SWITCH

Flip the Phase switch back and forth until you find the position that sounds best and subdues mid-bass feedback. Mid-bass feedback occurs when you play bass notes above the fourth fret (G#) on the low E string.

Lower Feedback Range
(E to G#)

Upper Feedback Range
(A and above)

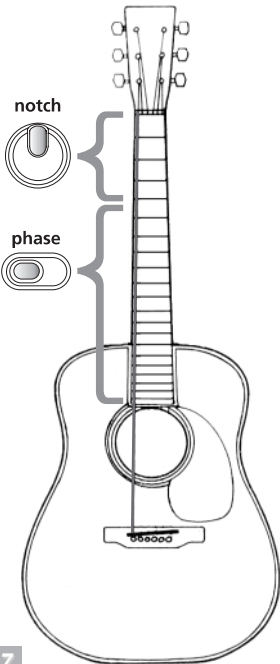

TONE CONTROLS

Note: If you make radical changes to your tone settings after you have set your input gain, re-check the Input Gain level so that the clip/low battery light faintly flashes with hard strumming. Doing so will give you the strongest possible signal with no distortion.

Bass

A Boost here will add depth and weight to the sound of an instrument with light bass response. Cut the bass a few dB to tighten up the big boomy tone of a dreadnought or jumbo guitar.

Mid EQ

Two sliders (Level and Frequency) make up the Mid control.

The Frequency slider lets you tune in on specific midrange sounds that you can boost/cut with the Level slider.

With the Mid EQ you can boost or cut a wide range of frequencies, from gutsy low midrange (250 Hz) to splashy low treble (5 kHz).

Many instruments benefit from a slight midrange cut. To cut mids:

Boost the Level control and then sweep the Frequency control until you find the band of frequencies that are brash and nasal sounding (usually around the center of the Frequency slider's travel). Then move the Level slider below its detent to taste.

Treble

A Boost here will help to "cut through the mix". Conversely, cutting the Treble will mellow and subdue your amplified tone.

Brilliance

This slider can add shimmer and sparkle to your sound.

It zeroes in on "extra crispy" high frequency tones, the realm of harmonics and acoustic string sound. Lowering the Brilliance slider will reduce excessive finger noise and fret buzz.

XLR PRE / POST SWITCH

With this switch, you can choose between two signal paths for the XLR Output.

1) Post • All controls on the Pro EQ Platinum affect the XLR output.

In the "Post" EQ position, you are in complete control of the sound going to the PA or recording console. The Post EQ setting is especially useful in venues where you want to control your volume and tone from the stage, with little or no help from a sound-person.

2) Pre • Only the Input Gain and Phase controls affect the XLR output.

Sometimes called a "direct" XLR signal. Set the switch to the "Pre" position when you wish to give a sound-person complete control of the house sound.

It is often useful to send an additional post EQ signal from the ¼" output on the Pro EQ Platinum to your stage amp or monitors, retain control of your stage sound.

GROUND LIFT (XLR)

Use this switch to eliminate AC ground loop hum in the XLR output.

This type of hum often occurs when you're plugged into more than one AC powered device. Note that unlike other manufacturer's DI/preamps, our ground lift works even with phantom power applied at the XLR output.

XLR (BALANCED) OUT

Plug a standard XLR cable from your PA or recording console into this low impedance balanced output. Note that the Pro EQ Platinum can run off 48-Volt phantom power through this output. See Power section above for phantom power operation.

OUTPUT (1/4" UNBALANCED)

Plug a standard instrument cable from this output to a stage amp or an unbalanced microphone input on a Mixer. All the Pro EQ Platinum's controls (except the XLR switches) will affect this output.

TUNER/SEND

Use this output when you need an unbalanced fixed level signal (regardless of changes in stage or house level), for an external tuner, recording device or a live radio feed. The Tuner/Send output is affected only by the Pro EQ Platinum's Input Gain control.

Using an Electronic tuner with the Tuner/Send

Run a 1/4" instrument cable from the Tuner/Send to an electronic tuner. For discrete tuning from stage, simply turn down the Volume control on the Platinum.

Make a Recording off the Tuner/Send

Use the Tuner/Send as an auxiliary unbalanced fixed level send (into a separate direct box) for recording or broadcast gear. This output will stay "live", regardless of changes to the house (XLR out, post EQ) or stage (1/4" output) levels.

SAMPLE EQ SETTINGS

Here are a few suggested settings for the Pro EQ Platinum:

Finger Style

This setting will add fullness to the bass and definition to the treble.

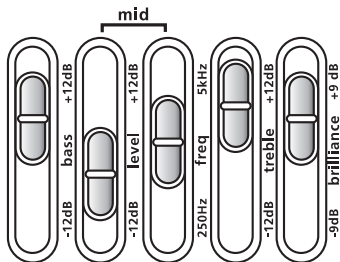

Mid Cut

To scoop out harsh midrange:

- Set the Frequency slider around the center position
- Set the Level slider to below the detent, to taste. Often the desired mid-cut will fall into the same frequency range as feedback.

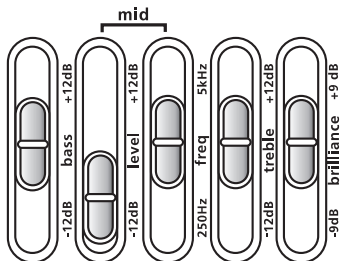

Sample EQ Settings continued from page 11

Strummer

This is a good overall setting if you mainly strum the instrument.

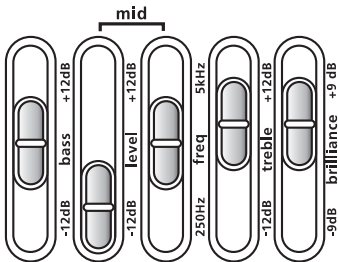

Cut through the Mix

This setting is helpful when you need to be heard through a loud band.

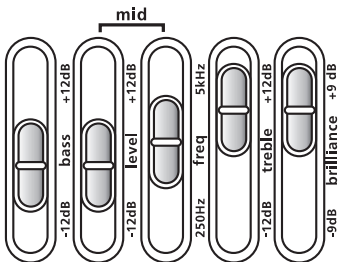

STAGE SETUP

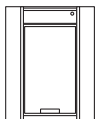

Acoustic
Guitar Amp

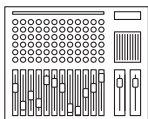

PA / Recording
Console



Tuner

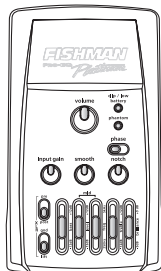
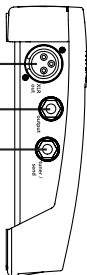

1/4" Input
Jack

BLOCK DIAGRAM

Note: This diagram is meant only to describe the signal routing for the Pro EQ Platinum and does not represent the actual electronic layout of the preamp.

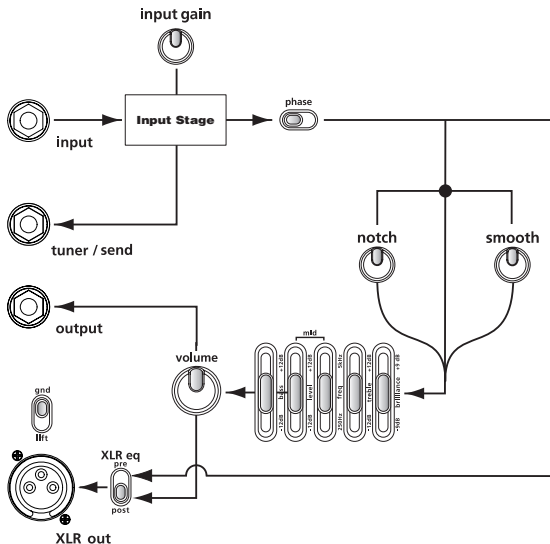

SPECIFICATIONS

Nominal Input Level	-20 dBV
Input Overload Level	+6 dBV
Input Impedance	10 M Ω

NOMINAL OUTPUT LEVELS AND IMPEDANCES

¼" Out	-23 dBV + 3 dBV (1 kW)
Tuner / Send Out	-23 dBV + 3 dBV(1 kW)
XLR Out	-32 dBV -6 dBV (600 Ω)

Bass Control Range	+/- 12 dB at 60 Hz +/- 3 dB at 350 Hz
Treble Control Range	+/- 12 dB at 10 kHz +/- 3 dB at 2.4 kHz
Mid Control Range	+/- 12 dB (adjustable from 250 Hz to 5 kHz) Q=0.5
Brilliance Control Range	+/- 9 dB at 10 kHz +/- 3 dB bandwidth 7 kHz

THD	Less than .02%, -10 dBV input
Signal to Noise Ratio	90 dB (A weighted, -10 dBV input, 2 dBV ¼"output)
Power Supply	9V alkaline battery (estimated 120 hours continuous use) Regulated FISHMAN 9V AC adapter
Current Draw	4.7 mA

All specifications subject to change without notice.

Limited Warranty

The FISHMAN PRO-EQ PLATINUM is warranted to function for a period of One (1) Year from the date of purchase. If the unit fails to function properly within the warranty period, free repair and the option of replacement or refund in the event that FISHMAN is unable to make repair are FISHMAN's only obligations. This warranty does not cover any consequential damages or damage to the unit due to misuse, accident, or neglect. FISHMAN retains the right to make such determination on the basis of factory inspection. Products returned to FISHMAN for repair or replacement must be shipped in accordance with the Return Policy, as follows. This warranty remains valid only if repairs are performed by FISHMAN. This warranty gives you specific legal rights and you may also have other rights which may vary from state to state.

Return Policy

To return products to FISHMAN TRANSDUCERS, you must follow these steps...

1. Call FISHMAN TRANSDUCERS at 978-988-9199 for a Return Authorization Number ("RAN").
2. Enclose a copy of the original Bill of Sale as evidence of the date of purchase, with the product in its original packaging and a protective carton or mailer.
3. FISHMAN TRANSDUCERS' technicians will determine whether the item is covered by warranty or if it instead has been damaged by improper customer installation or other causes not related to defects in material or workmanship.
4. Warranty repairs or replacements will be sent automatically free of charge.
5. If FISHMAN TRANSDUCERS determines the item is not covered by warranty, we will notify you of the repair or replacement cost and wait for your authorization to proceed.

FISHMAN TRANSDUCERS
340-D Fordham Road Wilmington MA 01887 USA
Phone 978-988-9199 • Fax 978-988-0770
www.fishman.com

5-00 • 009-091-001 Rev 2

FISHMAN[®]
Acoustic Power