

LC30-112

OPERATING INSTRUCTIONS - 1.2

Laney

POWER TO THE MUSIC



LANEY AMPLIFICATION

www.laney.co.uk

WARNING: When using electrical products, basic cautions should always be followed, including the following:

1. Read these instructions.
2. Keep these instructions safe.
3. Heed all warnings.
4. Follow all instructions.
5. Do not use this apparatus near water.
6. Clean only with a dry cloth.
7. Do not block any of the ventilation openings. Install in accordance with manufacturer's instructions.
8. Do not install near any heat sources such as radiators, heat registers, stoves or other apparatus (including amplifiers) that produce heat.
9. An apparatus with Class I construction shall be connected to a mains socket outlet with a protective connection. Do not defeat the safety purpose of the polarized or grounding-type plug. Do not defeat the safety purpose of the polarized or grounding-type plug. A polarized plug has two blades with one wider than the other. A grounding type plug has two blades and a third grounding plug. The wide blade or third prong is provided for your safety. If the provided plug does not fit into your outlet, consult an electrician for replacement of the obsolete outlet.
10. Protect the power cord from being walked on or pinched, particularly at plugs, convenience receptacles, and the point they exit from the apparatus.
11. Only use attachments/accessories provided by the manufacturer.
12. Use only with a cart, stand, tripod, bracket, or table specified by the manufacturer, or sold with the apparatus. When a cart is used, use caution when moving the cart/apparatus combination to avoid injury from tip-over.
13. The mains plug or appliance coupler is used as the disconnect device and shall remain readily operable. The user should allow easy access to any mains plug, mains coupler and mains switch used in conjunction with this unit thus making it readily operable. Unplug this apparatus during lightning storms or when unused for long periods of time.
14. Refer all servicing to qualified service personnel. Servicing is required when the apparatus has been damaged in any way, such as when power-supply cord or plug is damaged, liquid has been spilled or objects have fallen into the apparatus, the apparatus has been exposed to rain or moisture, does not operate normally, or has been dropped.
15. Never break off the ground pin. Connect only to a power supply of the type marked on the unit adjacent to the power supply cord.
16. If this product is to be mounted in an equipment rack, rear support should be provided.
17. Note for UK only: If the colours of the wires in the mains lead of this unit do not correspond with the terminals in your plug, proceed as follows:
 - a) The wire that is coloured green and yellow must be connected to the terminal that is marked by the letter E, the earth symbol, coloured green or coloured green and yellow.
 - b) The wire that is coloured blue must be connected to the terminal that is marked with the letter N or the colour black.
 - c) The wire that is coloured brown must be connected to the terminal that is marked with the letter L or the colour red.
18. This electrical apparatus should not be exposed to dripping or splashing and care should be taken not to place objects containing liquids, such as vases, upon the apparatus.
19. Exposure to extremely high noise levels may cause a permanent hearing loss. Individuals vary considerably in susceptibility to noise-induced hearing loss, but nearly everyone will lose some hearing if exposed to sufficiently intense noise for a sufficient time.

The U.S. Government's Occupational Safety and Health Administration (OSHA) has specified the following permissible noise level exposures: According to OSHA, any exposure in excess of the above permissible limits could result in some hearing loss. Earplugs or protectors to the ear canals or over the ears must be worn when operating this amplification system in order to prevent a permanent hearing loss, if exposure is in excess of the limits as set forth above. To ensure against potentially dangerous exposure to high sound pressure levels, it is recommended that all persons exposed to equipment capable of producing high sound pressure levels such as this amplification system be protected by hearing protectors while this unit is in operation.

Duration Per Day In Hours	Sound Level dBA, slow response
8	90
6	92
4	95
3	97
2	100
1 ½	102
1	105
½	110
¼ or less	115

ATTENTION: L'utilisation de tout a.ppareil électrique doit être soumise aux precautions d'usage incluant:

1. Lire ces instructions
2. Gardez ce manuel pour de futures références.
3. Prêtez attention aux messages de précautions de ce manuel.
4. Suivez ces instructions.
5. N'utilisez pas cette unité proche de plans d'eau.
6. N'utilisez qu'un tissu sec pour le nettoyage de votre unité.
7. N'obstruez pas les systèmes de refroidissement de votre unité et installez votre unité en fonction des instructions de ce manuel.
8. Ne positionnez pas votre unité à proximité de toute source de chaleur.
9. Un appareil avec la construction de la classe I sera relié à une sortie de douille de forces à un raccordement protecteur. Connectez toujours votre unité sur une alimentation munie de prise de terre utilisant le cordon d'alimentation fourni.
10. Protégez les connecteurs de votre unité et positionnez les cablages pour éviter toutes déconnexions accidentelles.
11. N'utilisez que des fixations approuvées par le fabriquant.
12. Lors de l'utilisation sur pied ou pole de support, assurez dans le cas de déplacement de l'ensemble enceinte/support de prévenir tout basculement interpestif de celui-ci.
13. Les forces branchent ou le coupleur d'appareils est utilisé pendant que le dispositif de débranchement et restera aisément fonctionnel. L'utilisateur devrait permettre l'accès facile à toutes les forces prise, à forces coupleur et à commutateur de forces utilisé en même temps que cette unité le rendant de ce fait aisément fonctionnel. Débranchez cet appareil pendant la foudre donne l' assaut à ou si inutilisé pendant de longues périodes.
14. Seul un technicien agréé par le fabriquant est à même de réparer/contrôler votre unité. Celle-ci doit être contrôlée si elle a subit des dommages de manipulation, d'utilisation ou de stockage (humidité,...).
15. Ne déconnectez jamais la prise de terre de votre unité.
16. Si votre unité est destinée a etre montée en rack, des supports arriere doivent etre utilisés.
17. Note pour les Royaumes-Unis: Si les couleurs de connecteurs du cable d'alimentation ne correspond pas au guide de la prise secteur, procédez comme suit:
 - a) Le connecteur vert et jaune doit être connecter au terminal noté E, indiquant la prise de terre ou correspondant aux couleurs verte ou verte et jaune du guide.
 - b) Le connecteur bleu doit être connecter au terminal noté N, correspondant à la couleur noire du guide.
 - c) Le connecteur marron doit être connecter au terminal noté L, correspondant à la couleur rouge du guide.
18. Cet équipement électrique ne doit en aucun cas être en contact avec un quelconque liquide et aucun objet contenant un liquide, vase ou autre ne devrait être posé sur celui-ci.
19. Une exposition à de hauts niveaux sonores peut conduire à des dommages de l'écoute irréversibles. La susceptibilité au bruit varie considérablement d'un individu à l'autre, mais une large majorité de la population expérimentera une perte de l'écoute après une exposition à une forte puissance sonore pour une durée prolongée.
L'organisme de la santé américaine (OSHA) a produit le guide ci-dessous en rapport à la perte occasionnée: D'après les études menées par le OSHA, toute exposition au delà des limites décrites ce-dessus entrainera des pertes de l'écoute chez la plupart des sujets. Le port de système de protection (casque, oreillette de filtrage,...) doit être observé lors de l'opération cette unité ou des dommages irréversibles peuvent être occasionnés. Le port de ces systèmes doit être observé par toutes personnes susceptibles d'être exposées à des conditions au delà des limites décrites ci-dessus.

Durée par Jour (heures)	Niveau sonore moyen (dBA)
8	90
6	92
4	95
3	97
2	100
1 ½	102
1	105
½	110
¼ ou inférieur	115

ACHTUNG: Beim Einsatz von Elektrogeräten müssen u.a. grundlegende Vorsichtsmaßnahmen befolgt werden:

1. Lesen Sie sich diese Anweisungen durch.
2. Bewahren Sie diese Anweisungen auf.
3. Beachten Sie alle Warnungen.
4. Befolgen Sie alle Anweisungen.
5. Setzen Sie dieses Gerät nicht in der Nähe von Wasser ein.
6. Reinigen Sie es nur mit einem trockenen Tuch.
7. Blockieren Sie keine der Lüftungsöffnungen. Führen Sie die Installation gemäß den Anweisungen des Herstellers durch.
8. Installieren Sie das Gerät nicht neben Wärmequellen wie Heizungen, Heizgeräten, Öfen oder anderen Geräten (auch Verstärkern), die Wärme erzeugen.
9. Ein Apparat mit Aufbau der Kategorie I wird an einen Hauptleitungseinfassungsanschluß mit einem schützenden Anschluss angeschlossen. Beeinträchtigen Sie nicht die Sicherheitswirkung des gepolten Steckers bzw. des Erdungssteckers. Ein gepolter Stecker weist zwei Stifte auf, von denen einer breiter ist als der andere. Ein Erdungsstecker weist zwei Stifte und einen dritten Erdungsstift auf. Der breite Stift bzw. der dritte Stift dient Ihrer Sicherheit. Sollte der beiliegende Stecker nicht in Ihre Steckdose passen, wenden Sie sich bitte an einen Elektriker, um die ungeeignete Steckdose austauschen zu lassen.
10. Schützen Sie das Netzkabel, sodass niemand darauf tritt oder es geknickt wird, insbesondere an Steckern oder Buchsen und ihren Austrittsstellen aus dem Gerät.
11. Verwenden Sie nur die vom Hersteller erhältlichen Zubehörgeräte oder Zubehörteile.
12. Verwenden Sie nur einen Wagen, Stativ, Dreifuß, Träger oder Tisch, der den Angaben des Herstellers entspricht oder zusammen mit dem Gerät verkauft wurde. Wird ein Wagen verwendet, bewegen Sie den Wagen mit dem darauf befindlichen Gerät besonders vorsichtig, damit er nicht umkippt und möglicherweise jemand verletzt wird.
13. Die Hauptleitungen verstopfen, oder Gerätekoppler wird während die Trennung Vorrichtung benutzt und wird bereitwillig funktionell bleiben. Der Benutzer sollte einfachen Zugang zu allen möglichen Hauptleitungen Stecker, zu den Hauptleitungen Koppler und zum Hauptleitungen Schalter erlauben, der in Verbindung mit dieser Maßeinheit benutzt wird, die folglich ihn bereitwillig funktionell bildet. Trennen Sie diesen Apparat während der Blitzstürme oder wenn unbenutzt, für lange Zeitabschnitte.
14. Lassen Sie sämtliche Wartungsarbeiten von qualifizierten Kundendiensttechnikern durchführen. Eine Wartung ist erforderlich, wenn das Gerät in irgendeiner Art beschädigt wurde, etwa wenn das Netzkabel oder der Netzstecker beschädigt wurden, Flüssigkeit oder Gegenstände in das Gerät gelangt sind, das Gerät Regen oder Feuchtigkeit ausgesetzt wurde, nicht normal rbeitet oder heruntergefallen ist.
15. Der Erdungsstift darf nie entfernt werden. Schließen Sie nur an die Stromversorgung der Art an, die am Gerät neben dem Netzkabel angegeben ist.
16. Wenn dieses Produkt in ein Geräte-Rack eingebaut werden soll, muss eine Versorgung über die Rückseite eingerichtet werden.
17. Hinweis – Nur für Großbritannien: Sollte die Farbe der Drähte in der Netzleitung dieses Geräts nicht mit den Klemmen in Ihrem Stecker übereinstimmen, gehen Sie folgendermaßen vor:
 - a) Der grün-gelbe Draht muss an die mit E (Symbol für Erde) markierte bzw. grüne oder grün-gelbe Klemme angeschlossen werden.
 - b) Der blaue Draht muss an die mit N markierte bzw. schwarze Klemme angeschlossen werden.
 - c) Der braune Draht muss an die mit L markierte bzw. rote Klemme angeschlossen werden.
18. Dieses Gerät darf nicht ungeschützt Wassertropfen und Wasserspritzern ausgesetzt werden und es muss darauf geachtet werden, dass keine mit Flüssigkeiten gefüllte Gegenstände, wie z. B. Blumenvasen, auf dem Gerät abgestellt werden.
19. Belastung durch extrem hohe Lärmpegel kann zu dauerhaftem Gehörverlust führen. Die Anfälligkeit für durch Lärm bedingten Hörverlust ist von Mensch zu Mensch verschieden, das Gehör wird jedoch bei jedem in gewissem Maße geschädigt, der über einen bestimmten Zeitraum ausreichend starkem Lärm ausgesetzt ist. Die US-Arbeitschutzbehörde (Occupational and Health Administration, OSHA) hat die folgenden zulässigen Pegel für Lärmbelastung festgelegt:

Laut OSHA kann jede Belastung über den obenstehenden zulässigen Grenzwerten zu einem gewissen Hörverlust führen. Sollte die Belastung die obenstehenden Grenzwerte übersteigen, müssen beim Betrieb dieses Verstärkungssystems Ohrenstopfen oder Schutzvorrichtungen im Gehörgang oder über den Ohren getragen werden, um einen dauerhaften Hörverlust zu verhindern. Um sich vor einer möglicherweise gefährlichen Belastung durch hohe Schalldruckpegel zu schützen, wird allen Personen empfohlen, die mit Geräten arbeiten, die wie dieses Verstärkungssystem hohe Schalldruckpegel erzeugen können, beim Betrieb dieses Geräts einen Gehörschutz zu tragen.

Dauer pro Tag in Stunden	Geräuschpegel dBA, langsame Reaktion
8	90
6	92
4	95
3	97
2	100
1 ½	102
1	105
½	110
¼ oder weniger	115

INSTRUCCIONES IMPORTANTES PARA SU SEGURIDAD - ESPAÑOL

Laney

LC30-112

CUIDADO: Cuando use productos electrónicos, debe tomar precauciones básicas, incluyendo las siguientes:



1. Lea estas instrucciones.
2. Guarde estas instrucciones.
3. Haga caso de todos los consejos.
4. Siga todas las instrucciones.
5. No usar este aparato cerca del agua.
6. Limpiar solamente con una tela seca.
7. No bloquear ninguna de las salidas de ventilación. Instalar de acuerdo a las instrucciones del fabricante.
8. No instalar cerca de ninguna fuente de calor como radiadores, estufas, hornos u otros aparatos (incluyendo amplificadores) que produzcan calor.
9. Un aparato con la construcción de la clase I será conectado con un enchufe de zócalo de las cañerías con una conexión protectora. No retire la patilla protectora del enchufe polarizado o de tipo "a Tierra". Un enchufe polarizado tiene dos puntas, una de ellas más ancha que la otra. Un enchufe de tipo "a Tierra" tiene dos puntas y una tercera "a Tierra". La punta ancha (la tercera) se proporciona para su seguridad. Si el enchufe proporcionado no encaja en su enchufe de red, consulte a un electricista para que reemplaze su enchufe obsoleto.
10. Proteja el cable de alimentación para que no sea pisado o pinchado, particularmente en los enchufes, huecos, y los puntos que salen del aparato.
11. Usar solamente añadidos/accesorios proporcionados por el fabricante.
12. Usar solamente un carro, pie, trípode, o soporte especificado por el fabricante, o vendido junto al aparato. Cuando se use un carro, tenga cuidado al mover el conjunto carro/aparato para evitar que se dañe en un vuelco. No suspenda esta caja de ninguna manera
13. Las cañerías tapan o el acoplador de la aplicación se utiliza mientras que el dispositivo de la desconexión y seguirá siendo fácilmente operable. El usuario debe permitir el acceso fácil a cualquier cañería enchufe, a las cañerías acoplador y al interruptor de las cañerías usado conjuntamente con esta unidad así que lo hace fácilmente operable. Desenchufe este aparato durante tormentas del relámpago o cuando es inusitado por periodos del tiempo largos.
14. Para cualquier reparación, acuda a personal de servicio cualificado. Se requieren reparaciones cuando el aparato ha sido dañado de alguna manera, como cuando el cable de alimentación o el enchufe se han dañado, algún líquido ha sido derramado o algún objeto ha caído dentro del aparato, el aparato ha sido expuesto a la lluvia o la humedad, no funciona de manera normal, o ha sufrido una caída.
15. Nunca retire la patilla de Tierra. Conecte el aparato sólo a una fuente de alimentación del tipo marcado al lado del cable de alimentación.
16. Si este producto va a ser enracado con más equipo, use algún tipo de apoyo trasero.
17. Nota para el Reino Unido solamente: Si los colores de los cables en el enchufe principal de esta unidad no corresponden con los terminales en su enchufe, proceda de la siguiente manera:

- a) El cable de color verde y azul debe ser conectado al terminal que está marcado con la letra E, el símbolo de Tierra (earth), coloreado en verde o en verde y amarillo.
 - b) El cable coloreado en azul debe ser conectado al terminal que está marcado con la letra N o el color negro.
 - c) El cable coloreado en marrón debe ser conectado al terminal que está marcado con la letra L o el color rojo.
18. Este aparato eléctrico no debe ser sometido a ningún tipo de goteo o salpicadura y se debe tener cuidado para no poner objetos que contengan líquidos, como vasos, sobre el aparato.

19. La exposición a altos niveles de ruido puede causar una pérdida permanente en la audición. La susceptibilidad a la pérdida de audición provocada por el ruido varía según la persona, pero casi todo el mundo perderá algo de audición si se expone a un nivel de ruido suficientemente intenso durante un tiempo determinado. El Departamento para la Salud y para la Seguridad del Gobierno de los Estados Unidos (OSHA) ha especificado las siguientes exposiciones al ruido permitibles:

De acuerdo al OSHA, cualquier exposición que exceda los límites arriba indicados puede producir algún tipo de pérdida en la audición. Protectores para los canales auditivos o tapones para los oídos deben ser usados cuando se opere con este sistema de sonido para prevenir una pérdida permanente en la audición, si la exposición excede los límites indicados más arriba. Para protegerse de una exposición a altos niveles de sonido potencialmente peligrosa, se recomienda que todas las personas expuestas a equipamiento capaz de producir altos niveles de presión sonora, tales como este sistema de amplificación, se encuentren protegidas por protectores auditivos mientras esta unidad esté operando.

Duración por Día en Horas	Nivel de Sonido dBA, Respuesta Lenta
8	90
6	92
4	95
3	97
2	100
1 ½	102
1	105
½	110
¼ o menos	115

	<p>Intended to alert the user to the presence of uninsulated 'Dangerous Voltage' within the products enclosure that may be sufficient to constitute a risk of electrical shock to persons.</p> <p>Ce symbole est utilis�e pur indiquer a l'utilisateur de ce produit de tension non-isol�ee dangereuse pouvant �tre d'intensit�e suffisante pour constituer un risque de choc electrique.</p> <p>Este simbolo tiene el proposito de alertar al usuario de la presencia de '(voltaje) peligroso' que no tiene aislamiento dentro de la caja del producto que puede tener una magnitud suficiente como para constituir riesgo de corrientazo.</p> <p>Dieses Symbol soll den Anwender vor unisolierten gefahrlichen Spannungen innerhalb des Gehauses warnen, die von Ausreichender Starke sind, um einen elektrischen Schlag verursachen zu konnen.</p>
	<p>Intended to alert the user of the presence of important operating and maintenance (Servicing) instructions in the literature accompanying the product.</p> <p>Dieses Symbol soll den Anwender vor unisolierten gefahrlichen Spannungen innerhalb des Gehauses warnen, die von Ausreichender Starke sind, um einen elektrischen Schlag verursachen zu konnen.</p> <p>Este simbolo tiene el proposito de la alertar al usuario de la presencis de instrucccones importantes sobre la operacion y mantenimiento en la literatura que viene conel producto.</p> <p>Dieses Symbol soll den Benutzer auf wichtige Instruktionen in der Bedienungsanleitung aufmerksam machen, die Handhabung und Wartung des Produkts betreffen.</p>
<p>CAUTION:</p> <p>ATTENTION:</p> <p>PRECAUCION:</p> <p>VORSICHT:</p>	<p>Risk of electrical shock - DO NOT OPEN. To reduce the risk of electrical shock, do not remove the cover. No user serviceable parts inside. Refer servicing to qualified personnel.</p> <p>Risques de choc electrique - NE PAS OUVIRIR Afin de reduire le risque de choc electrique, ne pas enlever le couvercle. Il ne se trouve a l'interieur aucune piece pouvant �tre reparee par l'utilisateur. Confier l'entretien a un personnel qualifie.</p> <p>Riesgo de corrientazo - no abra Para disminuir el riesgo de corrientazo, no abra la cubierta. No hay piezas adentro que el pueda reparar. Deje todo mantenimiento a los tecnicos calificados.</p> <p>Risiko - Elektrischer Schlag! Nicht offen! Um das Risiko eines elektrischen Schlagtes zu vermeiden, nicht die Abdeckung entfernen. Es befinden sich keine Teile darin, die vom Anwender repariert werden Konnten. Reparaturen nur von qualifiziertem Fachpersonal durchfuhren lassen.</p>
<p>WARNING:</p> <p>ADVERTISSEMENT:</p> <p>ADVERTENCIA:</p> <p>ACHTUNG:</p>	<p>To prevent electrical shock or fire hazard, do not expose this appliance to rain or moisture. Before using this appliance please read the operating instructions for further warnings.</p> <p>Afin de prevenir les risques de decharge electrique ou de feu, n'exposez pas cet appareil a la pluie ou a l'humidite. Avant d'utiliser cet appareil, lisez les advertissements supplementaires situes dans le guide.</p> <p>Para evitar corrientazos o peligro de incendio, no deja expuesto a la lluvia o humedad este aparato Antes de usar este aparato, lea mas advertencias en la guia de operacion.</p> <p>Um einen elektrischen Schlag oder Feuergefahr zu vermeiden, sollte dieses Gerat nicht dem Regen oder Feuchtigkeit ausgesetzt werden. Vor Inbetriebnahme unbedingt die Bedienungsanleitung lesen.</p>

After unpacking your amplifier check that it is factory fitted with a three pin 'grounded' (or earthed) plug. Before plugging into the power supply ensure you are connecting to a grounded earth outlet.

If you should wish to change the factory fitted plug yourself, ensure that the wiring convention applicable to the country where the amplifier is to be used is strictly conformed to. As an example in the United Kingdom the cable colour code for connections are as follows.

EARTH or GROUND GREEN/YELLOW
NEUTRAL - BLUE
LIVE - BROWN



NOTE

This manual has been written for easy access of information. The front and rear panels are graphically illustrated, with each control and feature numbered. For a description of the function of each control feature, simply check the number with the explanations adjacent to each panel.

Your Laney amplifier has undergone a thorough two stage, pre-delivery inspection, involving actual play testing.

When you first receive your Laney guitar amplifier, follow these simple procedures:

(i) Ensure that the amplifier is the correct voltage for the country it is to be used in.

(ii) Connect your instrument with a high quality shielded instrument cable. You have probably spent considerable money on your amplifier and guitar - don't use poor quality cable it won't do your gear justice.

Please retain your original carton and packaging so in the unlikely event that some time in the future your amplifier should require servicing you will be able to return it to your dealer securely packed.

Care of your Laney amplifier will prolong it's life.....and yours!

SPECIFICATIONS

Laney

LC30-112

Supply Voltage	~100V, ~120V, ~230V, ~240V 50/60Hz Factory Option	
Mains Fuse	(~220V>240V = T630mA L 250V) (~100>120V = T1.6A L 250V)	
HT Fuse	T315mA L	
Power Consumption	100W	
Output Power Rating	30W	
Loudspeaker	12" Celestion 8 Ohms	
Loudspeaker outputs	Extension speaker socket	(Minimum 8 Ohm Impedance)
Features	Pure Class A Valve tone	
	4xEL84 Power Tubes	(Matched Quad Set TAD)
	4x12AX7/ECC83 Preamp tubes	(TAD)
	Hi & Lo Gain Inputs	
	FX Loop with Switchable Level & By-pass	
Footswitchable	Channel and Reverb	(FS2 Optional)
Reverb	Digital Reverb	
EQ	Passive Bass, Middle and Treble	(Separate EQ for Clean and Drive)
	Bright Switch	
	Modern Switch	
Input Impedance	1MΩ/47pF	
Size (H*W*D)	451*558*278 (Base)	
Unit Weight	20Kg	

This product conforms to the requirements of the following European Regulations, Directives & Rules:-
CE Mark (93/68/EEC), Low Voltage (72/23/EEC), EMC (2004/108/EEC),
RoHS (EU2002/95/EC), WEEE (EU2002/96/EC)



In order to reduce environmental damage, at the end of its useful life, this product must not be disposed of along with normal household waste to landfill sites. It must be taken to an approved recycling centre according to the recommendations of the WEEE (Waste Electrical and Electronic Equipment) directive applicable in your country.

Dear Player,

Thank you very much for purchasing your new Laney product and becoming part of the worldwide Laney family. Each and every Laney unit is designed and built with the utmost attention to care and detail, so I trust yours will give you many years of enjoyment.

Laney products have a heritage which stretches back to 1967 when I first began building valve amplifiers in my parent's garage.

Since then we have moved on from strength to strength developing an extensive range of guitar, bass, public address and keyboard amplification products along with a list of Laney endorsees that includes some of the world's most famous and respected musicians.

At the same time we believe we have not lost sight of the reason Laney was founded in the first place - a dedication to building great sounding amplification for working musicians.

Warm Regards,

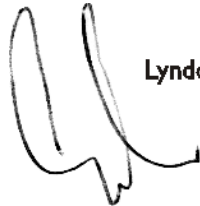
A handwritten signature in black ink, appearing to read 'Lyndon Laney', written in a cursive style.

Lyndon Laney CEO



The LC30-112's 30W Class A output stage oozes classic, warm tube tones: The harder you drive it, the better it sounds. Plus with enough gain for contemporary tones, it also has a mean, spiteful side to it as well – making it ideal for any style of playing. Perfect for studio and practice use, but also equally at home or on stage by itself or plugged into a Laney extension cabinet, the sound will blow you away.

Your LC30-112 should give you years of trouble-free amplification, however please take time to read this manual and familiarise yourself with the controls as it will allow you to get the best from your amplifier. We hope you enjoy using your LC30-112 as much as we enjoyed designing and making it.

Best wishes from all at Laney

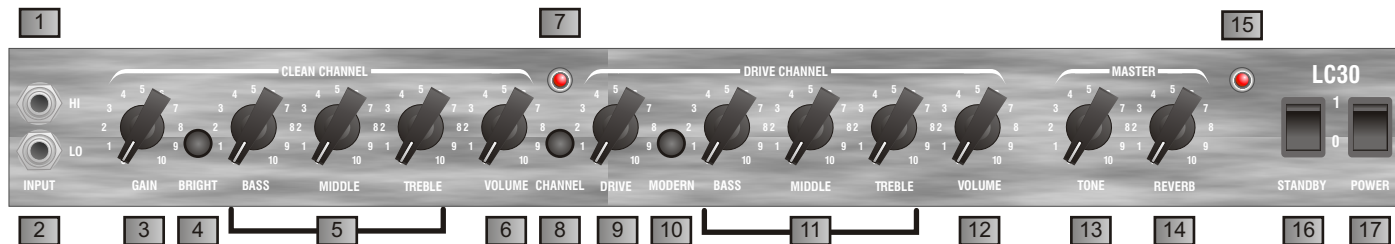

- 1 **HI INPUT:** 'Hi' stands for high gain. This input is designed for the connection of low output level guitars making it well suited for guitars with single coiled or low gain humbucker type pickups. Use of high gain pickups in this input may drive the preamp too hard causing a "mushy" sound. Only use good quality guitar cable.
- 2 **LO INPUT:** 'Lo' stands for low gain. This input is attenuated down approximately 50% from the Hi input and is designed for high output level guitars. It is useful in obtaining output that is "tight" not "mushy" from high gain humbucker type pickups. Only use good quality guitar cable.
- 3 **GAIN:** Sets the level of tube preamplifier Gain or how dirty your sound is. This control should be used in conjunction with the Volume control, setting low levels of gain with high levels of volume will give the cleanest preamplifier sound with tube output stage overdrive at high volume settings. Setting a medium gain level and medium volume will give a nice crisp tone with just a little break up and warmth, again with the ability to drive the output stage at higher volume settings. Setting a high level on the gain control and a low setting on the volume will give you a nice blues tone, with the ability to again drive the output tubes at higher volume settings. Having set the gain and volume controls to your desired sound try backing off your guitar volume and tone controls for lots of other cool sounds. Good tube amplifiers have the unique ability to produce a wide range of sounds by using only your guitar controls, playing weight and style.
- 4 **BRIGHT:** Adds brightness and life to the treble frequencies of your guitar when on the clean channel. The switch has more effect at low Gain Volume control settings. Use in conjunction with the Treble and Tone controls for optimum performance.
- 5 **BASS, MIDDLE, TREBLE:** These are a traditional set of passive tone controls for the clean channel. Passive controls have the advantage of always sounding musical at any of their settings mainly due to their unique interactive nature. This gives players a more natural set of tools to create their ideal sound. (Try them all set at midway (5) as a good starting point).
- 6 **VOLUME:** Sets how loud the clean channel is. Try cranking it up a little to drive the power tubes harder for that real retro sound and feel that only a quality tube amplifier can deliver. Now use your guitar volume to control the amount of distortion.

- 7 **CHANNEL SWITCH:** Switch in to enable the 'Drive' channel. (This switch must be in the disengaged position in order for the drive to be switched remotely via a foot switch.)
- 8 **DRIVE LED:** This led will illuminate when the Drive channel is activated with the Drive switch (8) or an optional Laney FS2 remote footswitch.
- 9 **DRIVE:** Sets the level of tube preamplifier drive or how dirty your sound is. This control should be used in conjunction with the Drive Volume (12) Setting low levels of gain with high levels of volume will give a clean preamplifier sound with tube output stage overdrive. Setting a medium drive level and medium Drive Volume will give a nice crisp bluesy tone, again with the ability to drive the output stage at higher Drive Volume settings. Setting a high level on the Drive control and a low setting on the Drive Volume will give you a punchy hard rock tone, with the ability to again drive the output tubes at higher Drive volume settings. Having set the Drive and Drive Volume controls to your desired sound try backing off your guitar volume and tone controls for lots of other cool sounds. Good tube amplifiers have the unique ability to produce a wide range of sounds by using only your guitar controls, playing weight and style.
- 10 **MODERN:** The modern switch applies a degree of compression & bass lift to the signal, providing massive smooth sustain.
- 11 **BASS, MIDDLE, TREBLE:** These are a traditional set of passive tone controls for the Drive channel and work in a similar way as those for the clean channel, except that they operate post distortion giving a wider range of distorted tone.
- 12 **DRIVE VOL:** Sets how loud the 'Drive' channel is. It is useful to experiment with drive levels and drive volumes. If you want a very open, warm and semi overdriven sound try reducing the amount of drive and increasing the drive volume. This reduces pre-amp gain but pushes the power amp section and makes it work harder giving you a very desirable level of power amp distortion which is a very pleasing "retro" style sound.
- 13 **STONE:** The tone control works in a similar fashion to the Tone control you probably have on your guitar except that it uniquely works at the other end of the amplification chain. This has the ability to not only control the overall top end response but also reduce upper end harmonics on the output stage and preamplifier overdrive sounds. This will give you bright cutting sounds at high settings and smooth rounded sounds at lower settings. (Midway (5) is a good starting point)
- 14 **REVERB:** Controls how loud the built in reverb sounds.
- 15 **POWER LED:** This led will be lit when the amplifier is switched on. **(Always switch off and disconnect the power cord when not in use)**
- 16 **STANDBY:** Disconnects the main HT voltage from the tubes but keeps the tubes warm so that they are ready to go instantly. Switch off for short breaks when you don't want to wait for the tubes to warm up again.
- 17 **POWER:** Main power switch for the unit. Tube amplifiers take between 30 seconds and 2 minutes to warm up and be ready to play after switching on, this is normal. Use in conjunction with the standby switch.

Spare power fuse
included in the tray.



- 1 **POWER INLET SOCKET:** Connect to your power source. Make sure the specified voltage is correct for your country!
- 2 **POWER FUSE:** This drawer contains the main safety fuse for the unit. The fuse protects the AC power to the amplifier. **USE ONLY THE CORRECT SIZE AND RATING OF FUSE AS SPECIFIED ON THE PANEL.** If a fuse blows or fails and a replacement of the same size and rating is installed and it in turn blows, the amplifier has suffered a malfunction internally and needs immediate service from a qualified technician. **DO NOT TRY USING A FUSE OF HIGHER RATING.** Using a fuse that is too large in current rating may cause serious, irreparable damage to the amplifier and presents a serious fire hazard. The mains fuse ratings are detailed in the specs section on page 7 of this manual
- 3 **HT FUSE:** This fuse protects the DC power to the tubes within the amplifier. **USE ONLY THE CORRECT SIZE AND RATING FUSE AS SPECIFIED ON THE PANEL.** If a fuse blows or fails and a replacement of the same size and rating is installed and it in turn blows, the amplifier has suffered a malfunction, at this point check the output tubes and replace faulty ones if required. Should tubes not be the problem the amplifier should be checked out by a qualified technician. Do not try using a fuse of greater value. Using a fuse that is too large in current rating may cause serious, irreparable damage to the amplifier. Fuses are designed to protect, do not take chances.
- 4 **SERIAL NO:** Displays the model and serial number of the unit.
- 5 **EFFECTS LOOP: SEND/LINE OUT:** Connect the input of your external effect to this socket. All of the signal leaves the amplifier via the 'Send' socket to be processed and comes back from the effects via the 'Return' socket. This socket can also be used to control another LC30-112 amplifier connected to this socket via its own return socket. Some Effects are better

suited to being between the guitar and amplifier input - these are foot pedal types / distortion / wah wah pedals etc. Rack mount effects will work better in the FX loop on the amplifier rear. Stomp boxes are normally designed for small signals such as a guitar output whereas rack mount FX are designed for the higher signal level obtained from an FX send. This socket can also be used as a Line Level Out.

- 6 BY-PASS/LEVEL SWITCH:** This switch allows the effects loop to be by-passed if not in use, it also gives you the option of running the FX loop at 0dB (750mV) or at -10dB (250mV) to suit your processor.
- 7 EFFECTS LOOP: RETURN:** Connect the output from your external effects to this socket. The effects loop allows you to connect external effects such as tremolo's, chorus and delays to your amplifier. All of the signal leaves the amplifier via the `Send` socket and comes back from the effects via the `Return` socket. Use the output level control on your FX to control how loud the FX return signal sounds. This is an insert type control, therefore you need to set the Dry/ Wet mix in your FX processor.
- 8 FOOTSWITCH SOCKET:** Provided for the connection of a Laney FS2 footswitch (optional) .This allows you to remotely switch between the clean/drive channel and & switch the built in reverb On/Off.
- 9 INTERNAL CABINET:** The internal loudspeaker is connected by a 1/4" (6.3mm) jack to this socket. With no extension cabinet connected ensure that the impedance selector switch (6) is set to 8 ohms. In use your LC30-112 should always have a speaker connected otherwise you risk damaging the LC30-112's output transformer.
- 10 IMPEDANCE SELECTOR SWITCH:** This optimises the LC30-112's output for 4 or 8-16 ohm loads. When using with the 'on board' speaker set to it 8 ohms. If using an 8-16 ohm extension cabinet at the same time as the onboard speaker, set the switch to 4 ohms. If you set it wrong it will reduce the life of your output tubes and won't sound as good.
- 11 EXTENSION CABINET:** Use to connect an 8-16 ohm extension cabinet. Please note mismatched impedance will reduce the amplifiers performance and in some cases may cause damage to your amplifier. Try the LC30-112 into a Laney extension cabinet - you will be amazed what this baby cranks out.

Laney

QUICK START SETTINGS - *suggestions only, experiment!*

CLEAN

Diagram showing the control panel for the Clean Channel. The Gain knob is turned to 0. The Bright knob is turned to 10, with an arrow pointing to it and the word "ON" above. The Bass, Middle, and Treble knobs are all turned to 5. The Volume Channel knob is turned to 10. The Drive knob is turned to 0. The Modern knob is turned to 0. The Bass, Middle, and Treble knobs for the Drive Channel are all turned to 5. The Volume knob is turned to 10. The Tone knob is turned to 10. The Reverb knob is turned to 0. The Standby and Power buttons are shown on the right.

CLEAN CRUNCH

Diagram showing the control panel for the Clean Crunch setting. The Gain knob is turned to 3. The Bright knob is turned to 10. The Bass knob is turned to 3. The Middle knob is turned to 7. The Treble knob is turned to 3. The Volume Channel knob is turned to 7. The Drive knob is turned to 0. The Modern knob is turned to 0. The Bass, Middle, and Treble knobs for the Drive Channel are all turned to 5. The Volume knob is turned to 10. The Tone knob is turned to 10. The Reverb knob is turned to 0. The Standby and Power buttons are shown on the right.

BLUES LEAD

Diagram showing the control panel for the Blues Lead setting. The Gain knob is turned to 3. The Bright knob is turned to 10. The Bass knob is turned to 3. The Middle knob is turned to 7. The Treble knob is turned to 3. The Volume Channel knob is turned to 7. The Drive knob is turned to 0. The Modern knob is turned to 0. The Bass knob is turned to 3. The Middle knob is turned to 7. The Treble knob is turned to 3. The Volume knob is turned to 10. The Tone knob is turned to 10. The Reverb knob is turned to 0. The Standby and Power buttons are shown on the right.

ROCK LEAD

Diagram showing the control panel for the Rock Lead setting. The Gain knob is turned to 3. The Bright knob is turned to 10. The Bass knob is turned to 3. The Middle knob is turned to 7. The Treble knob is turned to 3. The Volume Channel knob is turned to 7. The Drive knob is turned to 0. The Modern knob is turned to 0. The Bass knob is turned to 3. The Middle knob is turned to 7. The Treble knob is turned to 3. The Volume knob is turned to 10. The Tone knob is turned to 10. The Reverb knob is turned to 0. The Standby and Power buttons are shown on the right.

Suggested starting point, adjust Tone to individual taste

USER SETTINGS - Store your own cool sounds

Laney

LC30-112

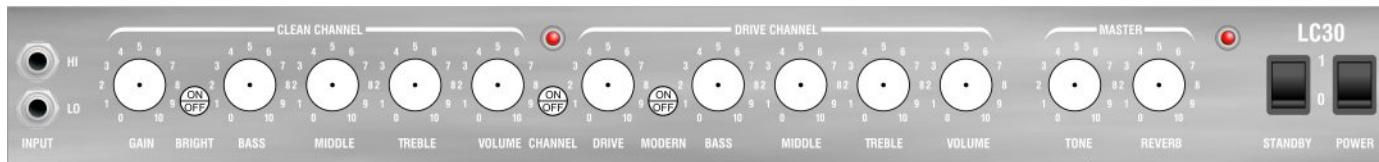

- **Tube amplifiers;** generally sound much warmer/sweeter than solid state transistor amplifiers but they also need a little more respect due to the fragile glass tubes themselves. The LC30-112 uses top quality tubes, which should give you years of trouble free service, however like all tube amps; it is important to treat it with a certain amount of care.
- **Tubes are fragile glass components;** they can easily be damaged if thrown in and out of vehicles,
- **Make sure the impedance;** of your cabinets matches the setting on your amplifier. Improper impedance matching will result in reduced output power output and compromised sound at best and amplifier failure/premature tube failure at worst.
- **Allow the amplifier;** to warm up to room temperature before switching it on, The sudden thermal shock generated can crack the cold glass tube housing plus any moisture is bad news around high voltage electronics.
- **Allow the amplifier;** to cool down after playing before moving. Hot tubes are more susceptible to damage than cool ones. Use good quality loudspeaker leads, cheap leads are often not up to the job of handling the large requirements for loudspeakers and can often short out.
- **Tube amplifiers;** don't like running into an open circuit. A tube's life expectancy is based upon a number of factors which include operating temperature, how hard and how often it is played, vibration due to travel etc. Tubes should be changed in your amplifier if you notice any change in your amplifier's performance etc. They need not be changed at any regular interval.
- **Typical problems;** with preamp tubes can be a crackly noise, hiss, hum and microphony. The preamp tubes can safely be changed with no action required if they fail or reduce in performance. Typical output tube problems can be blown HT fuse; sound lacking in punch, sound lacks extreme highs or lows and low level hum. The Output tubes can be replaced singularly if you replace them with the exact same type AND grade as factory fitted otherwise they should be replaced as a quad set. See the diagram following to see how to check the tube grade fitted. Exact replacement preamp tubes and matched sets of output tubes are available from Laney via your dealer.
- **To change a tube;** switch off the unit and unplug from the mains supply. Wait for the tubes to cool down. Lay amplifier down on its front face and remove the protective grille held in place with four screws. You should now be able to access the underside of the amplifier chassis. Preamp tubes are protected with a screen can, to remove; gently twist the screen can anti clockwise and then pull up. The tube can then be gently pulled out. Take care when pushing the new tube in to make sure the pins are all aligned properly. Output tubes have a spring retainer which must be pulled away before the tube will come out.
- **Amplifier connection;** In order to avoid damage, it is advisable to establish and follow a pattern for turning on and off your equipment. With all system parts connected, effects processors etc. **BEFORE** turning on your guitar amplifier. Many products have large transient surges at turn on and off which can cause damage to your speakers. By turning on your guitar amplifier **LAST** and making sure its Volume controls are set to minimum any transients from other equipment will not reach

your loudspeakers. Wait until all system parts have stabilised; usually a couple of seconds. Similarly when turning off your system always turn down the Volume controls on your guitar amplifier and then turn off its power before turning off other equipment.

- **Servicing:** The user should not attempt to service these products. Refer all servicing to qualified service personnel.



V1	RT030	ECC83 Hi Grade	005570
V2,3	RT003	ECC83 Select	005548
V4	NN003	ECC83	005548
V5,6,7,8	EL83M	EL84 Matched Quad Set	005562

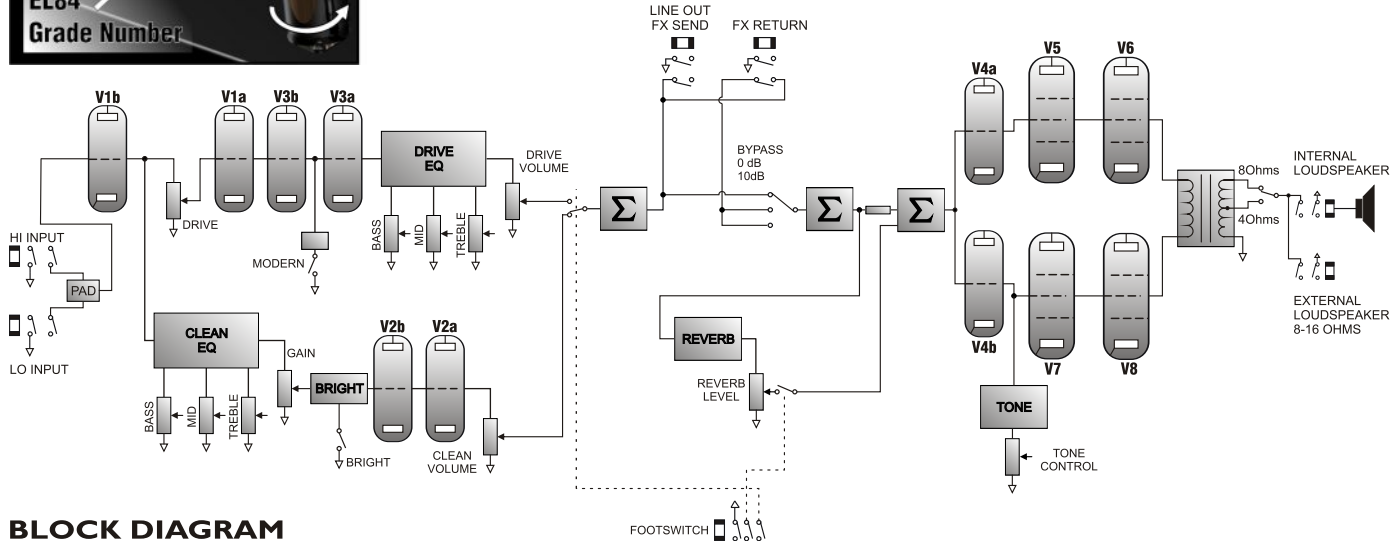
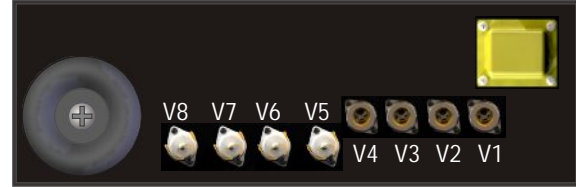

BLOCK DIAGRAM

Laney

LC30-112 SAMPLE SYSTEMS

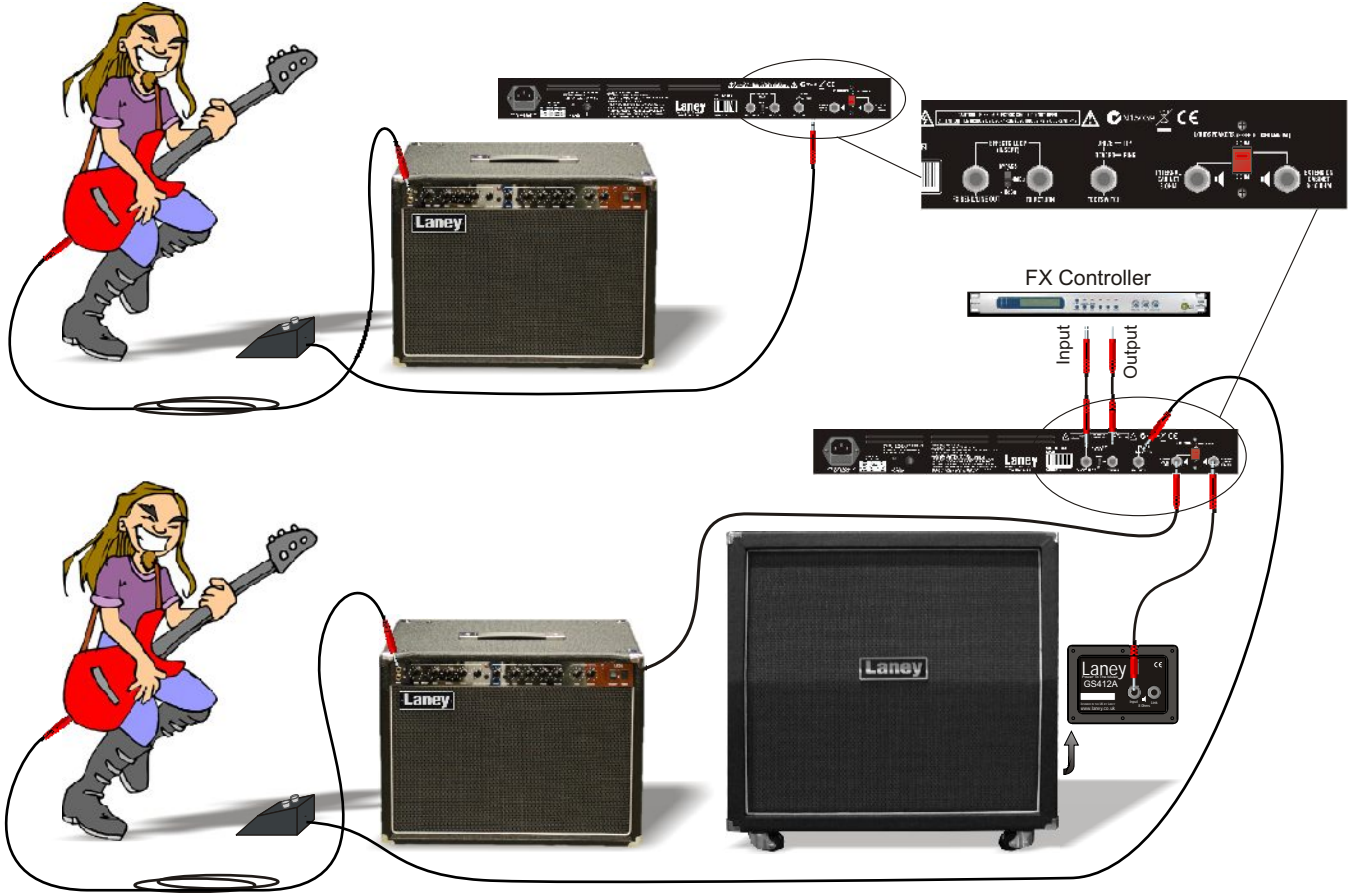



LANEY AMPLIFICATION
www.laney.co.uk

In the interest of continued product development, Laney reserves the right to amend product specification without prior notification.