

**DIGITAL MIXING STUDIO****01X****Owner's Manual****CAUTION**

- Before using the 01X, be sure to read "PRECAUTIONS" on pages 4 – 5.

**Application Index** → Page 10**Troubleshooting** → Page 144

The included CD-ROMs contain supplementary software (page 9) and the following manuals.

- Studio Manager Owner's Manual (PDF)
- SQ01 V2 for Windows online manual
- 01X Channel Module Owner's Manual (PDF)
- Pitch Fix Owner's Manual (PDF)
- Vocal Rack Owner's Manual (PDF)
- Final Master Owner's Manual (PDF)
- TWE Owner's Manual (PDF)
- Multi Part Editor for MOTIF-RACK Owner's Manual (PDF)

For details, refer to the separate Installation Guide.

# SPECIAL MESSAGE SECTION

This product utilizes batteries or an external power supply (adapter). DO NOT connect this product to any power supply or adapter other than one described in the manual, on the name plate, or specifically recommended by Yamaha.

**WARNING:** Do not place this product in a position where anyone could walk on, trip over, or roll anything over power or connecting cords of any kind. The use of an extension cord is not recommended! If you must use an extension cord, the minimum wire size for a 25' cord (or less) is 18 AWG. NOTE: The smaller the AWG number, the larger the current handling capacity. For longer extension cords, consult a local electrician.

This product should be used only with the components supplied or; a cart, rack, or stand that is recommended by Yamaha. If a cart, etc., is used, please observe all safety markings and instructions that accompany the accessory product.

## SPECIFICATIONS SUBJECT TO CHANGE:

The information contained in this manual is believed to be correct at the time of printing. However, Yamaha reserves the right to change or modify any of the specifications without notice or obligation to update existing units.

This product, either alone or in combination with an amplifier and headphones or speaker/s, may be capable of producing sound levels that could cause permanent hearing loss. DO NOT operate for long periods of time at a high volume level or at a level that is uncomfortable. If you experience any hearing loss or ringing in the ears, you should consult an audiologist. IMPORTANT: The louder the sound, the shorter the time period before damage occurs.

Some Yamaha products may have benches and / or accessory mounting fixtures that are either supplied with the product or as optional accessories. Some of these items are designed to be dealer assembled or installed. Please make sure that benches are stable and any optional fixtures (where applicable) are well secured BEFORE using. Benches supplied by Yamaha are designed for seating only. No other uses are recommended.

## NOTICE:

Service charges incurred due to a lack of knowledge relating to how a function or effect works (when the unit is operating as designed) are not covered by the manufacturer's warranty, and are therefore the owners responsibility. Please study this manual carefully and consult your dealer before requesting service.

## ENVIRONMENTAL ISSUES:

Yamaha strives to produce products that are both user safe and environmentally friendly. We sincerely believe that our products and the production methods used to produce them, meet these goals. In keeping with both the letter and the spirit of the law, we want you to be aware of the following:

## Battery Notice:

This product MAY contain a small non-rechargeable battery which (if applicable) is soldered in place. The average life span of this type of battery is approximately five years. When replacement becomes necessary, contact a qualified service representative to perform the replacement.

This product may also use "household" type batteries. Some of these may be rechargeable. Make sure that the battery being charged is a rechargeable type and that the charger is intended for the battery being charged.

When installing batteries, do not mix batteries with new, or with batteries of a different type. Batteries MUST be installed correctly. Mismatches or incorrect installation may result in overheating and battery case rupture.

## Warning:

Do not attempt to disassemble, or incinerate any battery. Keep all batteries away from children. Dispose of used batteries promptly and as regulated by the laws in your area. Note: Check with any retailer of household type batteries in your area for battery disposal information.

## Disposal Notice:

Should this product become damaged beyond repair, or for some reason its useful life is considered to be at an end, please observe all local, state, and federal regulations that relate to the disposal of products that contain lead, batteries, plastics, etc. If your dealer is unable to assist you, please contact Yamaha directly.

## NAME PLATE LOCATION:

The name plate is located on the rear of the product. The model number, serial number, power requirements, etc., are located on this plate. You should record the model number, serial number, and the date of purchase in the spaces provided below and retain this manual as a permanent record of your purchase.

Model \_\_\_\_\_

Serial No. \_\_\_\_\_

Purchase Date \_\_\_\_\_

# PLEASE KEEP THIS MANUAL

92-BP (rear)

## FCC INFORMATION (U.S.A.)

**1. IMPORTANT NOTICE: DO NOT MODIFY THIS UNIT!**

This product, when installed as indicated in the instructions contained in this manual, meets FCC requirements. Modifications not expressly approved by Yamaha may void your authority, granted by the FCC, to use the product.

**2. IMPORTANT:** When connecting this product to accessories and/or another product use only high quality shielded cables. Cable/s supplied with this product **MUST** be used. Follow all installation instructions. Failure to follow instructions could void your FCC authorization to use this product in the USA.

**3. NOTE:** This product has been tested and found to comply with the requirements listed in FCC Regulations, Part 15 for Class "B" digital devices. Compliance with these requirements provides a reasonable level of assurance that your use of this product in a residential environment will not result in harmful interference with other electronic devices. This equipment generates/uses radio frequencies and, if not installed and used according to the instructions found in the users manual, may cause interference harmful to the operation of other electronic devices. Compliance with FCC regula-

tions does not guarantee that interference will not occur in all installations. If this product is found to be the source of interference, which can be determined by turning the unit "OFF" and "ON", please try to eliminate the problem by using one of the following measures:

Relocate either this product or the device that is being affected by the interference.

Utilize power outlets that are on different branch (circuit breaker or fuse) circuits or install AC line filter/s.

In the case of radio or TV interference, relocate/reorient the antenna. If the antenna lead-in is 300 ohm ribbon lead, change the lead-in to co-axial type cable.

If these corrective measures do not produce satisfactory results, please contact the local retailer authorized to distribute this type of product. If you can not locate the appropriate retailer, please contact Yamaha Corporation of America, Electronic Service Division, 6600 Orangethorpe Ave, Buena Park, CA90620

The above statements apply **ONLY** to those products distributed by Yamaha Corporation of America or its subsidiaries.

\* This applies only to products distributed by YAMAHA CORPORATION OF AMERICA.

(class B)

# PRECAUTIONS

## PLEASE READ CAREFULLY BEFORE PROCEEDING

\* Please keep this manual in a safe place for future reference.



## WARNING

Always follow the basic precautions listed below to avoid the possibility of serious injury or even death from electrical shock, short-circuiting, damages, fire or other hazards. These precautions include, but are not limited to, the following:

### Power supply/AC power adaptor

- Only use the voltage specified as correct for the instrument. The required voltage is printed on the name plate of the instrument.
- Use the specified adaptor (PA-300 or an equivalent recommended by Yamaha) only. Using the wrong adaptor can result in damage to the instrument or overheating.
- Check the electric plug periodically and remove any dirt or dust which may have accumulated on it.
- Do not place the AC adaptor cord near heat sources such as heaters or radiators, and do not excessively bend or otherwise damage the cord, place heavy objects on it, or place it in a position where anyone could walk on, trip over, or roll anything over it.

### Do not open

- Do not open the instrument or attempt to disassemble the internal parts or modify them in any way. The instrument contains no user-serviceable parts. If it should appear to be malfunctioning, discontinue use immediately and have it inspected by qualified Yamaha service personnel.

### Water warning

- Do not expose the instrument to rain, use it near water or in damp or wet conditions, or place containers on it containing liquids which might spill into any openings.
- Never insert or remove an electric plug with wet hands.

### Fire warning

- Do not put burning items, such as candles, on the unit. A burning item may fall over and cause a fire.

### If you notice any abnormality

- If the AC adaptor cord or plug becomes frayed or damaged, or if there is a sudden loss of sound during use of the instrument, or if any unusual smells or smoke should appear to be caused by it, immediately turn off the power switch, disconnect the adaptor plug from the outlet, and have the instrument inspected by qualified Yamaha service personnel.

## CAUTION

Always follow the basic precautions listed below to avoid the possibility of physical injury to you or others, or damage to the instrument or other property. These precautions include, but are not limited to, the following:

### Power supply/AC power adaptor

- When removing the electric plug from the instrument or an outlet, always hold the plug itself and not the cord.
- Unplug the AC power adaptor when not using the instrument, or during electrical storms.
- Do not connect the instrument to an electrical outlet using a multiple-connector. Doing so can result in lower sound quality, or possibly cause overheating in the outlet.

### Location

- Do not expose the instrument to excessive dust or vibrations, or extreme cold or heat (such as in direct sunlight, near a heater, or in a car during the day) to prevent the possibility of panel disfiguration or damage to the internal components.
- Do not use the instrument in the vicinity of a TV, radio, stereo equipment, mobile phone, or other electric devices. Otherwise, the instrument, TV, or radio may generate noise.
- Do not place the instrument in an unstable position where it might accidentally fall over.
- Before moving the instrument, remove all connected adaptor and other cables.
- Do not place objects in front of the instrument's air vent, since this may prevent adequate ventilation of the internal components, and possibly result in the instrument overheating.

### Connections

- Before connecting the instrument to other electronic components, turn off the power for all components. Before turning the power on or off for all components, set all volume levels to minimum. Also, be sure to set the volumes of all components at their minimum levels and gradually raise the volume controls while playing the instrument to set the desired listening level.

### Maintenance

- When cleaning the instrument, use a soft, dry cloth. Do not use paint thinners, solvents, cleaning fluids, or chemical-impregnated wiping cloths.

### Handling caution

- Do not insert a finger or hand in any gaps on the instrument.
- Never insert or drop paper, metallic, or other objects into the gaps on the panel or keyboard. If this happens, turn off the power immediately and unplug the power cord from the AC outlet. Then have the instrument inspected by qualified Yamaha service personnel.
- Do not place vinyl, plastic or rubber objects on the instrument, since this might discolor the panel or keyboard.
- Do not rest your weight on, or place heavy objects on the instrument, and do not use excessive force on the buttons, switches or connectors.
- Do not operate the instrument for a long period of time at a high or uncomfortable volume level, since this can cause permanent hearing loss. If you experience any hearing loss or ringing in the ears, consult a physician.

### Saving data

#### Saving and backing up your data

- Any edited data (see page 36) that is left un-stored will be lost if you turn off the power to the instrument. Save the data to the Library memory (see pages 50 and 54).

Saved data may be lost due to malfunction or incorrect operation. Save important data to your computer.

Never attempt to turn off the power while data is being written to internal memory (while a "Please keep power on..." message is shown). Turning the power off in this state results in loss of all user data.

If you feel any resistance when moving one of the faders, you should stop moving it. Never force a fader if it shows signs of resistance; doing so may damage the device.

XLR-type connectors are wired as follows (IEC60268 standard): pin 1: ground, pin 2: hot (+), and pin 3: cold (-).

Yamaha cannot be held responsible for damage caused by improper use or modifications to the instrument, or data that is lost or destroyed.

Always turn the power off when the instrument is not in use.

Even when the power switch is in the "STANDBY" position, electricity is still flowing to the instrument at the minimum level. When you are not using the instrument for a long time, make sure you unplug the AC power adaptor from the wall AC outlet.



## Introduction

*Congratulations and thank you for purchasing the Yamaha 01X Digital Mixing Studio.*

*The 01X is a full-featured music production tool that effectively gives you three sophisticated, comprehensive devices in one easy-to-use package — convenient remote control over your computer-based DAW (digital audio workstation) via mLAN connection (FireWire/i.Link/IEEE 1394), digital audio mixing with 24-bit/96kHz sound quality, and full audio/MIDI interfacing with your computer environment via the mLAN connection. With its wealth of built-in effects and advanced functions — not to mention its transparent, seamless blend of software and hardware — the 01X is an excellent control console for recording with an audio/MIDI sequencer, and is ideal for virtually any music creation/production application.*

*In order to get the most out of your new 01X and its sophisticated functions, we suggest you read through this manual thoroughly. Also keep it in a safe, convenient place so that you can regularly refer to it when necessary.*

### Accessories (Check to see that you have everything listed here.)

- AC Adaptor: PA-300
- CD-ROM x 2
- Installation Guide
- Owner's Manual
- mLAN cable
- Quick Reference for Playback/Recording
- User's Card (containing the serial number for the included Plug-in software effects)

#### ● Included CD-ROMs

These CD-ROMs contain special software for use with this instrument. They include the SQ01 (V2), a full-featured audio/MIDI sequencer/mixer for comprehensive music production, Studio Manager, which gives you comprehensive and intuitive mixer editing tools, and Multi Part Editor for MOTIF-RACK editing the Mixing parameters of Songs and Patterns of the Yamaha MOTIF-RACK. Included also are plug-in software effects that provide effect processing using the processing power of your computer.

For details, see the separate Installation Guide or the online manuals included with the software.

# About This Manual

This manual consists of the following sections.

## **Before Using (page 14)**

Use this section to find out about all of the buttons, controls and connectors of the 01X. It also explains how to set up the instrument and connect external equipment.

## **Basics Section (page 25)**

This section provides an overview of the main functions and features of the 01X and introduces you to the basic operating conventions.

## **Getting Started (page 43)**

This section explains how to use the basic functions of the 01X.

## **Reference (page 84)**

This is the 01X encyclopedia. It explains all functions and parameters including the Remote functions.

## **Appendix (page 115)**

This section contains various important lists such as the EQ Library list, Dynamics Library list, Effect Parameter list, and MIDI Implementation Chart.

This section also contains detailed information on the 01X such as MIDI, Display Messages, Troubleshooting and Specifications.

## **Installation Guide (separate booklet)**

Refer to this for instructions on installing the included software programs (on the CD-ROM) to your computer. This also contains necessary system requirements for the 01X and supplementary software, mLAN setup, Remote Control Setup, as well as information how to play the demo song, and computer software that can be controlled from the 01X.

- *Copying of commercially available music sequence data and/or digital audio files for any purpose other than your own personal use, is strictly prohibited.*
- *This product incorporates and bundles computer programs and contents in which Yamaha owns copyrights or with respect to which it has license to use others' copyrights. Such copyrighted materials include, without limitation, all computer software, styles files, MIDI files, WAVE data and sound recordings. Any unauthorized use of such programs and contents outside of personal use is not permitted under relevant laws. Any violation of copyright has legal consequences. DON'T MAKE, DISTRIBUTE OR USE ILLEGAL COPIES.*
- *The illustrations and screen displays as shown in this owner's manual are for instructional purposes only, and may appear somewhat different from those on your instrument.*
- *Most of the computer display examples in this owner's manual are taken from the English version OS/software.*
- *The name "mLAN" and its logo (  ) are trademarks of Yamaha Corporation.*
- *The company names and product names in this Owner's Manual are the trademarks or registered trademarks of their respective companies.*

## The 01X — What it is and what it can do

### **Powerful, multi-faceted digital mixer, computer audio recording interface, and control surface—all in one**

The 01X is actually several full-featured high-end digital devices in one compact, easy-to-use package. It serves as a flexible 28-channel (maximum) digital mixer for recording in home and project studios, and even live applications. It's also a 24-bit audio front-end for your computer, for high-resolution recording and playback of your sequencer/DAW tracks. It gives you full transport and mixing control from the panel of most major sequencer/DAW software, and provides several bundled software tools—including the virtual console Studio Manager, and the Channel Module—for getting the absolute most out of your computer connection. Best of all, it can perform all of these tasks simultaneously, or at the flick of a switch. Let's take a closer look.

### **Recording/mixdown console**

As a mixer for recording purposes, the 01X is simple and compact, yet comprehensive in its mixing power. It has eight hardware inputs, with two XLR-connector mic/line inputs and an alternate Hi-Z input on channel 8 for guitar or bass. With an mLAN inputs/outputs, you can have up to 24 input channels (actually 28, including the stereo ins).

The fully digital 01X also features built-in compression/dynamics processing and EQ—independent for all channels—and two effects blocks. What's more, each processing section has its own set of Library presets, letting you instantly call up the appropriate settings for your current application.

Highly portable, the versatile 01X is also ideal for mobile recording applications—even in multi-channel full band setups. With the mLAN connection and the audio interface features (see below), all you need is a laptop computer and the 01X—and you've got a full-featured recording studio you can take on the road.

### **Audio/MIDI interface for computer**

The 01X also functions as a sophisticated high-quality audio front-end for your computer. Simply connect a standard IEEE 1394 (FireWire/i.Link) cable for high-speed data transfer and easy operation with IEEE 1394-capable (mLAN compatible) computer. This gives you high-resolution 24-bit audio, with the sampling rate switchable between 44.1 kHz, 48kHz, 88.2kHz (Macintosh only) and 96kHz.

The 01X is also a multi-port MIDI interface for your computer, with two sets of MIDI terminals on the rear panel. The mLAN interface also handles MIDI, giving you five independent MIDI ports (page 95).

### **Remote control surface for computer sequencers and digital audio workstations (DAWs)**

More than just a conventional mixer, the 01X is also a convenient, comprehensive control surface for your sequencer or DAW application. It features tape recorder style transport controls, window navigation buttons, and allows you to use the faders, knobs and channel buttons for mixing your sequencer tracks in real time. Which means you have full automation control over your mix—and can even change and automate EQ and effect settings for each track. Most major DAW applications and MIDI/audio sequencers are supported, including Cubase SX/SL, Nuendo, Logic, SONAR, and Digital Performer.

The 01X is a perfect hybrid of the analog and digital—you get the benefits of clean digital sound, yet you still have physical knobs, sliders and switches to touch, giving you hands-on control. You'll find these features useful as creative composing and arranging tools as well—for example, in programming mutes and fades on the fly as the tracks play back.



## Powerful software applications

Included with your 01X are a variety of useful plug-ins and software programs to help you get the most out of the mixer and your computer music system.

### • **01X Channel Module**

This plug-in software provides at-a-glance control over all Dynamics and EQ processing for an 01X channel. It lets you call up Dynamics and EQ Library presets from the computer, tweak them using the intuitive controls and comprehensive displays, save your custom settings, and import/export settings to and from the connected 01X. In this way, you can set and use the Channel Module to process your sequencer tracks on the computer, and export the settings to the 01X—using the hardware processing on the mixer to save processing power on your computer.

### • **Plug-in Effects**

Use these powerful tools in your sequencer or DAW for recording, processing, editing and mastering:

Vocal Rack — Multi-effect processor perfect for recording vocals

Pitch Fix — Comprehensive, “fix-it-in-mix” pitch editing for vocals

Final Master — Mastering effect w/multi-band compressor, limiter, and soft-clip feature

### • **Studio Manager for 01X**

This stand-alone virtual mixer software is a convenient direct link between the 01X and your computer. Utilizing the mLAN connection, it provides virtual channel strips for all 01X channels— with faders, pan controls and real-time stereo metering—and lets you see all your Dynamics and EQ edits on the monitor.

### • **SQ01 V2 (Windows only)**

This is the latest version of Yamaha’s powerful audio/MIDI sequencer, featuring a new Audio Mixer window. The SQ01 V2 lets you easily record, edit and play back your own songs on computer, and provides a seamless environment for the included Plug-in software (as well as third-party plug-ins).

### • **TWE Wave Editor (Windows only)**

This audio editing software is comprehensive, yet simple and easy to use—giving you the tools to change, enhance and transform your audio recordings.

### • **Multi Part Editor for MOTIF-RACK (Windows only)**

This convenient software allows you to edit the Mixing parameters (including effects) of the MOTIF-RACK from your computer, when using the MOTIF-RACK as a multi-timbral tone generator.

# Application Index

This convenient, easy-to use index is divided into general categories to help you when you want to find information on a specific topic or function. For information on the electronic owner's manuals (PDF), refer to the separate Installation Guide.

## ■ Installation/Normal Settings

- Uninstall (removing the installed application) ..... (Installation Guide)
- Necessary Software (Drivers/Applications) Installation ..... (Installation Guide)
- Selecting the IEEE 1394 card (when multiple cards are installed) ..... mLAN Driver Setup (Installation Guide)
- Listening to Demo songs ..... (Installation Guide)
- Settings for Remote Control
  - Cubase/Nuendo ..... (page 66)
  - SQ01/Logic/SONAR/Digital Performer ..... (Installation Guide)
  - 01X ..... REMOTE SELECT (page 87)
- Switches between automatic/manual setting of mLAN wordclock. .... W.CLK SELECT (page 92)
- Setting the sampling frequency (frequency of the wordclock) (when mLAN is used) ..... Auto Connector (Installation Guide)

## ■ Accessory software and mLAN related settings.

- Determining the number of mLAN audio transmission/reception channels. .... Auto Connector (Installation Guide)
- Setting the sampling frequency (frequency of the wordclock) (when mLAN is used) ..... Auto Connector (Installation Guide)
- Determining the speed at which settings are changed when new wordclock is received. .... Auto Connector → Setup (mLAN Transition Speed) (Installation Guide)
- Quits/enables mLAN network in Windows ..... Task bar → mLAN icon → OFF (Installation Guide)
- Determining the latency (how quickly the data is processed).
  - Basic settings made in mLAN Driver ..... mLAN Driver Setup → Latency (Installation Guide)
  - Settings made in relevant application ..... ASIO mLAN Control Panel → Preferred Buffer Size (Installation Guide)
- Determining the audio driver (ASIO/WDM) used with mLAN ..... mLAN Driver Setup → Mode (Installation Guide)
- Checking the reception condition of mLAN (from 01X to computer) ..... mLAN Driver Setup → Status/Information (Installation Guide)
- Using the same 01X EQ and Dynamics effects from the computer, using the computer's processing power. .... 01X Channel Module (01X Channel Module Owner's Manual; PDF)

## ■ Frequent settings for Recording/Playing back

- Determining the number of mLAN audio transmission/reception channels. .... Auto Connector (Installation Guide)
- Setting the sampling rate (wordclock) when using mLAN. .... Auto Connector (Installation Guide)
- Determining the latency (how quickly the data is processed).
  - Basic settings made in mLAN Driver ..... mLAN Driver Setup → Latency (Installation Guide)
  - Settings made in relevant application ..... ASIO mLAN Control Panel → Preferred Buffer Size (Installation Guide)
- Determining the audio driver (ASIO/WDM) used with mLAN ..... mLAN Driver Setup → Mode (Installation Guide)
- Monitoring/outputting the DAW (digital audio workstation) sound from the 01X.
  - Outputting the sound via internal mixer (input module) of the 01X ..... MONITOR (page 96)
  - Outputting the sound separate from the internal mixer of the 01X (using the monitor input) ..... MONITOR (page 96)
- Recording individual input channels of the 01X to the DAW. .... OUTPUT PATCH (mLAN OUT CHANNEL) (page 90)
- Recording a mix of the input channels of the 01X to the DAW. .... OUTPUT PATCH (mLAN OUT CHANNEL) (page 90)
- Recording channels of the 01X dry and unprocessed, or recording with EQ and Dynamics processing. .... DIRECT OUT POSITION (page 91)
- Connecting the DAW or MIDI sequencer by MIDI. .... (page 95)

## ■ Adjusting the recording level

- Adjusting the gain of the analog input ..... Gain knob (pages 16, 43)
- Checking the input signal for clipping ..... Switching the meter display. (INPUT METER POINT=PRE EQ) (page 46)
- Controlling the volume digitally (with the 01X faders) ..... DIRECT OUT POSITION (page 91)

## ■ Editing the song/data from the computer/DAW

- Editing the pitch of the vocal. .... Pitch Fix (Pitch Fix Owner's Manual; PDF)
- Controlling the Pitch Fix plug-in effect via MIDI data from the host application. (Using MIDI to change the pitch of a vocal or to switch scenes.) ..... (Pitch Fix Owner's Manual; PDF)
- Using multi-effects in vocal recording. .... Vocal Rack (Vocal Rack Owner's Manual; PDF)
- Using multi-effects in mastering. .... Final Master (Final Master Owner's Manual; PDF)
- Editing and viewing the 01X settings on the computer ..... Studio Manager (Studio Manager Owner's Manual; PDF)
- Saving the 01X's settings to a computer ..... Studio Manager (Studio Manager Owner's Manual; PDF)
- Transferring settings between the 01X Channel Module and the Studio Manager. .... Studio Manager 01X Channel Module (01X Channel Module Owner's Manual; PDF)

## ■ Saving data

- Backing up system data ..... BACKUP ([SHIFT]+[UTILITY] (page 86)
- Saving/recalling/deleting groups of programmed settings (Library) ..... LIBRARY (page 36)
- Using the channel Library. .... [SHIFT] + [SELECTED CHANNEL] (page 103)
- Saving the 01X's settings to a computer ..... Studio Manager (Studio Manager Owner's Manual; PDF)

## ■ Protecting data from accidental loss

- Setting a Scene so that data cannot be deleted/edited (Scene Protect). .... PROTECT (page 86)
- Specifying a certain channel to not be affected by recalling a Scene (Recall Safe). .... RECALL SAFE (page 86)
- Specifying the stereo channel to not be affected by recalling a Scene (Recall Safe). .... RECALL SAFE (page 86)

## ■ Entering data

- Entering characters (Library name settings) ..... Title Edit (page 41)

## ■ Resetting parameters (Initializing)

- Resetting the 01X to its default settings (Factory Set) ..... Factory Set (page 42)
- Initializing Scene parameters ..... Scene Library → recalling Library #00 (page 85)
- Initializing INPUT PATCH/OUTPUT PATCH parameters ..... Input/Output Patch Library → recalling Library #00 (pages 89, 91)
- Initializing Channel parameters ..... Channel Library → recalling Library #00 or #01 (page 103)

## ■ mLAN

- Switches between automatic/manual setting of mLAN wordclock. .... W.CLK SELECT (page 92)
- Setting the sampling rate (wordclock).
  - When the 01X is the master ..... mLAN AUTO W.CLK (mLAN AUTO Wordclock) (page 92)
  - When using mLAN ..... Auto Connector (Installation Guide)

## ■ Remote Control

- Selecting the DAW/sequencer to be remotely controlled. .... REMOTE SELECT (page 87)
- Emulating touch-sensitive fader control.
  - Continuing automation recording even after fader movement is stopped. .... REMOTE AUTOMATION SETUP/[SEL] (pages 15, 17, 88)
  - Starting automation recording before fader is moved. .... [AUTO EDIT]/[SEL] (pages 15, 17, 88)
- Setting the time that the 01X "waits" before turning off fader recording.  
(Can also be set to no "time-out", or constant recording.) ..... REMOTE AUTOMATION SETUP (page 88)
- Remote control of the Multi-Part Editor, by using the [SHIFT] + [REMOTE] buttons. .... [SHIFT]+[REMOTE] (pages 37, 87)
- Switching between remote control and internal mixer operation. .... Modes (Mode List) (page 37)

## ■ Miscellaneous operations

- Speeding up adjustment of numeric values when using the knobs. .... [SHIFT]+Channel knob (page 17)
- Switching (exchanging) the functions of the channel faders and knobs. .... [FLIP] (page 19)
- Assigning the function of the channel knob to the fader as well. .... [SHIFT]+[FLIP] (page 19)
- Assigning control of the fader operation and settings to odd/even channel pairs (setting one channel controls the other). .... CH PAIR (page 102)
- Assigning fader operations in groups. .... FADER GROUP (page 101)
- Assigning [ON] button operations in groups. .... MUTE GROUP (page 101)
- Switching between soloing of multiple channels or a single selected channel. .... SOLO MODE (page 96)

## ■ Display

- Toggling among the different display indications for the meter and parameter/value displays. .... [SHIFT]+[NAME/VALUE] (page 46)
- Determining the time the parameter value remains displayed (when NAME/VALUE is set to "NAME"). .... PARAM DISP TIME (page 95)
- Determining whether the channel level is shown or not when a fader is moved. .... FADER LEVEL DISP (page 95)
- Switching the display indication between channels/parameters/values and only values. .... [NAME/VALUE] (page 17)
- Switching between level meter display of the pre-fader signal or post-fader. .... (page 46)
- Determining whether a confirmation prompt appears or not for store/recall operations. .... STORE/RECALL CONFIRMATION (page 95)

## ■ Input

- Assigning the input signals (from MIC/LINE INPUT, DIGITAL STEREO IN terminals) to the input channels on the mixer. .... INPUT PATCH (INI-8) (page 88)
- Assigning the input signals (from MIC/LINE INPUT, DIGITAL STEREO IN terminals and Effects 1/2) to the stereo input channels on the mixer. .... INPUT PATCH (ST1/2) (page 89)
- Switching the phase setting of an input channel. .... PHASE (page 99)

## ■ Output

- Outputting only the DAW's stereo output to Monitor Out or headphones..... MONITOR (pages 37, 96)
- Outputting only the stereo output of the 01X to Monitor Out or headphones..... MONITOR (pages 37, 96)
- Assigning the stereo bus, Rec bus and Aux bus signals to the desired mLAN outputs..... OUTPUT PATCH (mLAN OUT CHANNEL) (page 90)
- Selecting which signals (stereo bus, Rec bus, Aux bus 1/2 or Aux bus 3/4) are to be output via the DIGITAL STEREO OUT terminal..... OUTPUT PATCH (DIGI. ST/AUX OUT PORT) (page 91)
- Selecting which signals (stereo bus, Rec bus, Aux bus 1/2 or Aux bus 3/4) are to be output via the STEREO/AUX OUT terminals..... OUTPUT PATCH (DIGI. ST/AUX OUT PORT) (page 91)
- Directly outputting the input channel signals 1-8 and 9-24 (mLAN) via the output terminals/channels..... OUTPUT PATCH (mLAN OUT CHANNEL)/(DIGI. ST/AUX OUT PORT) (pages 90, 91)
- Selecting which signal is to be used for Direct Out: pre-EQ, pre-fader, or post-fader..... OUTPUT PATCH (DIRECT OUT POSITION) (page 91)

## ■ Digital In/Out

- Enabling/disabling cascade connection of the DIGITAL IN to the stereo bus..... D.IN ST-BUS CASCADE (page 93)
- Setting the attenuation level when connecting the DIGITAL IN to the stereo bus..... D.IN ST-BUS CASCADE ATT (page 93)
- Enabling/disabling conversion of the sampling rate of the signal received at DIGITAL IN..... SRC (Sampling rate converter) (page 93)
- Enabling/disabling dithering of the digital audio (intentionally adding noise to minimize effects of quantization noise)..... D.OUT DITHER (page 93)

## ■ Program Change and MIDI

- Enabling/disabling remote control (including Program Change) over the Multi-Part Editor..... SHIFT+REMOTE FUNCTION (page 87)
- Setting the MIDI send/receive channels for Program Change..... MIDI CHANNEL (page 94)
- Determining whether Program Change messages are transmitted/received or not..... PROGRAM CHANGE (page 94)
- Setting a specific Program Change number to be transmitted when a Scene is recalled..... PROGRAM CHANGE ASSIGN TABLE (page 94)
- Using incoming Program Change messages to change Scenes..... PROGRAM CHANGE ASSIGN TABLE (page 94)

## ■ Others

- Distinguishing among different 01X units when using Studio Manager..... STUDIO MANAGER ID (page 94)
- Enabling/disabling SCMS (Serial Copy Management System)..... DIGITAL OUT COPYRIGHT (page 95)
- Using the oscillator signal and changing its waveform..... OSCILLATOR (page 93)
- Setting the stereo pan position..... PAN (page 99)
- Adjusting the send level..... SEND (page 100)
- Setting the transmission position (pre/post) of the signal sent to AUX..... AUX 1 - 4 PREPOST (page 100)
- Using effects..... EFFECT (page 102)
- Inserting an effect in the channel signal path..... EFFECT PATCH (page 102)
- Bypassing the effect..... BYPASS (page 102)
- Determining whether or not the input channel signal is sent to the Rec bus and stereo bus..... RECBUS/ST-BUS (page 99)

## ■ Reference materials

- Remote Functions..... Remote Function List (page 84)
- Display indications..... Mode selection and Display indications (page 38)
- Checking the list of available EQ, Dynamics and Effect programs and their parameters..... Parameter List (page 115)
- Checking the signal flow of the 01X..... Block Diagram (End of manual)
- Understanding the indications in the block diagram..... (page 28)
- Using the SQ01 online manual..... (Installation Guide)
- System requirements for the accessory applications..... (Installation Guide)
- Checking the compatible DAW software..... (Installation Guide)
- Checking words and terminology used with the 01X..... 01X Terminology (page 14)
- Memory structure of the Libraries..... (page 36)
- Checking information on the mLAN MIDI ports..... mLAN MIDI INFORMATION (page 95)

## ■ Quick solutions

- Meaning of the display messages..... (page 143)
- Troubleshooting..... (page 144)

# Table of Contents

## Before Using **14**

<b>01X Terminology</b> .....	14
<b>Controls and Connectors</b> .....	16
<b>Connections</b> .....	23
<b>Setting Up</b> .....	24

## Basics Section **25**

<b>Overview of the 01X</b> .....	25
Mixer .....	27
Internal effects 1/2 .....	31
Remote Control .....	32
mLAN Interface .....	33
<b>Application examples</b> .....	34
1) Recording mixer and monitor mixer .....	34
2) Digital mixer function .....	35
3) Recording mixer, monitor mixer — with use of 01X Channel Module software and Studio Manager .....	35
<b>Memory (Library) Structure</b> .....	36
<b>Basic Operations</b> .....	37
Modes .....	37
Mode selection and display indications .....	38
Layer selection/Channel selection .....	40
Entering Characters (Title Edit) .....	41
Factory Set (Restore Factory Defaults) .....	42

## Getting Started **43**

<b>Mixing Tutorial</b> .....	46
Setting input levels and viewing the meters .....	46
Applying EQ .....	48
Using Mute (On/Off) / Solo .....	51
Using Dynamics — applying compression, etc. ....	52
Dynamics Library .....	54
Pairing channels .....	54
Panning .....	55
Using the Internal Effects .....	56
Using external effects .....	60
Input and Output Patching .....	61
Groups .....	64
Creating and Recalling Scenes .....	65

<b>Recording/Playback/Remote Control</b> .....	66
Setting up .....	66
Working in the Project window .....	73
Working in the Mixer window .....	75
Working in an Editor window .....	76
Automation .....	77
Editing EQ settings .....	79
Editing Effect settings .....	80
Other control features .....	82

## Reference **84**

<b>Function Tree/Function List</b> .....	84
<b>Remote Function List</b> .....	104
SQ01 V2 .....	104
LOGIC .....	106
Cubase/NUENDO .....	108
SONAR .....	110
Digital Performer .....	112

## Appendix **115**

<b>Parameter Lists</b> .....	115
Preset EQ Library .....	115
Preset EQ Parameters/Values .....	116
EQ Parameters .....	117
Preset Dynamics Library .....	118
Preset Dynamics Parameters/Values (fs=44.1kHz) .....	119
Dynamics Parameters .....	121
Preset Effects Library .....	125
Effects Parameters .....	126
Scene Memory to Program Change Table .....	138
Input Patch Parameters .....	139
Initial Input Patch Settings .....	139
Output Patch Parameters .....	140
Initial Output Patch Settings .....	140
<b>MIDI Data Format</b> .....	141
<b>MIDI Implementation Chart</b> .....	142
<b>Display Messages</b> .....	143
<b>Troubleshooting</b> .....	144
<b>Specifications</b> .....	149
<b>Index</b> .....	151

## 01X Terminology

### Digital Mixing Terms

#### ■ Attenuator (ATT)

After A/D conversion, input signals (pre-EQ level) can be attenuated using this control. This is used mainly in the EQ section to prevent the signal from clipping and to adjust the level so that fader of each channel can be operated around 0dB. (See page 98.)

#### ■ AUX

Stands for “auxiliary.” These are alternate signal output destinations used to feed the two internal effects of the 01X or an external effect processor.

#### ■ Buses

A signal route that mixes the signals from multiple channels and send them to an output jack or internal effect input is called a “bus.”

Unlike channels, which handle only a single signal, a bus can combine multiple signals into one or two, and send them to a destination. (This comes from the common meaning of the word, a vehicle to carry many passengers simultaneously.) The 01X’s mixer section lets you use the following buses.

##### ● Stereo buses L/R

This mixes the input signals to stereo, and sends them via the stereo output channel to the rear panel jacks (for example, STEREO/AUX OUT/mLAN) as selected by Output Patch.

##### ● AUX buses 1 through 4

These combine the signals from the channel inputs, stereo input and mLAN inputs, and send them to the rear panel jacks (for example, STEREO/AUX OUT/mLAN) as selected by Output Patch. AUX bus 3/4 can be also used to input the signals to built-in effects 1 and 2.

##### ● REC bus L/R

These combine the signals from the channel inputs, stereo input and mLAN inputs, and send them via the REC bus output channel to the rear panel jacks (for example, STEREO/AUX OUT/mLAN) as selected by Output Patch.

#### ■ Channel

A signal routing unit through which a sound that is input to the mixer section is adjusted by volume and pan and then output. The mixer section of the 01X provides a total of 28 channels including the Stereo Inputs for the outputs of the two effects.

#### ■ Jitter

When digital audio signals are transferred, the wordclock (page 23) of the devices must match. If this wordclock is not generated accurately, a type of noise called jitter will occur. Less variation in the wordclock rate compared to a perfectly accurate square wave (i.e., a more stable clock) will mean less jitter and better audio quality.

#### ■ Library

This is a memory location for storing individual settings, such as those of Scene, EQ or Dynamics. The 01X has separate Libraries for Scene, EQ, Dynamics, effects, channels, input patch and output patch. Each Library is stored (saved) to internal memory. The 01X also includes many convenient presets in the Libraries for instant use in different recording and mixing applications.

#### ■ Nominal level

The “nominal level” referred to on a mixer or recorder indicates the standard level setting for that device. When all parameters are set to the nominal level, the audio quality will be the closest to the specifications given in the catalog.

#### ■ Scenes

A “Scene” is a program containing mixing settings and internal effect parameter settings for all channels, and is stored to internal memory in the Scene Library.



## Remote Control Terms

### ■ Automation

A function by which adjustments of mixer parameters via the knobs and faders are recorded in real time, and are exactly reproduced during playback.

The 01X works in tandem with DAW (digital audio workstation) software such as SQ01, Cubase SX/SL, etc.-- recording operations on the DAW software by using the Remote Control function, and features synchronized operation of the mixer functions on the DAW and fader operations on the 01X. The particular methods of recording automation data differ depending on the DAW. The following terms are examples from the SQ01.

#### ● Touch

Only data of fader or knob operations is recorded.

#### ● Latch

Fader and knob operations are recorded from the start until the song stops.

### ■ Bank

This refers to a group of channels that can be simultaneously controlled from the panel. This is the DAW equivalent for mixing “layers” in the Internal mode. Groups of eight channels on the DAW software can be selected for mixing, just as the layer groups 1 - 8, 9 - 16, and 17 - 24 are selected on the 01X. For details, refer to the Remote Function List on page 104.

### ■ Moving faders

This describes faders that automatically move to recorded positions as they are recalled—for example, when selecting a different mixing layer channel group or recalling a Scene from memory. On the 01X, all nine faders (including the ST channel) are moving faders. This is very convenient, since the faders move according to the parameter changes during automation playback, providing visual confirmation of the mixdown status. (Also called “motorized faders.”)

### ■ Touch-in/Touch-out

In automation, the initial movement of a fader is referred to as “touch-in,” while the releasing of the fader is called “touch-out.” The 01X registers touch-in when a fader starts moving, and registers touch-out not at the physical release of the fader but after the elapsed “Timeout” time (page 88). The [SEL] button flashes when touch-in starts (when automation recording is active). You can manually touch-out or stop recording automation before the “Timeout” by pressing the [SEL] button. It is also possible to start touch-in manually without moving the fader, by pressing the [SEL] button when the [AUTO EDIT] button is ON.

# Controls and Connectors

## Top Panel

NOTE

- For details on the functions in the Remote mode, see the Remote Function List (page 104).
- Depending on your particular DAW, not all control features may be implemented, and some buttons may be assigned different functions. Refer to the owner's manual of your particular DAW for specific instructions and setups.
- Remote control is only possible when the version of your particular DAW application and operating system conforms to the system requirements (Refer to the separate Installation Guide.)

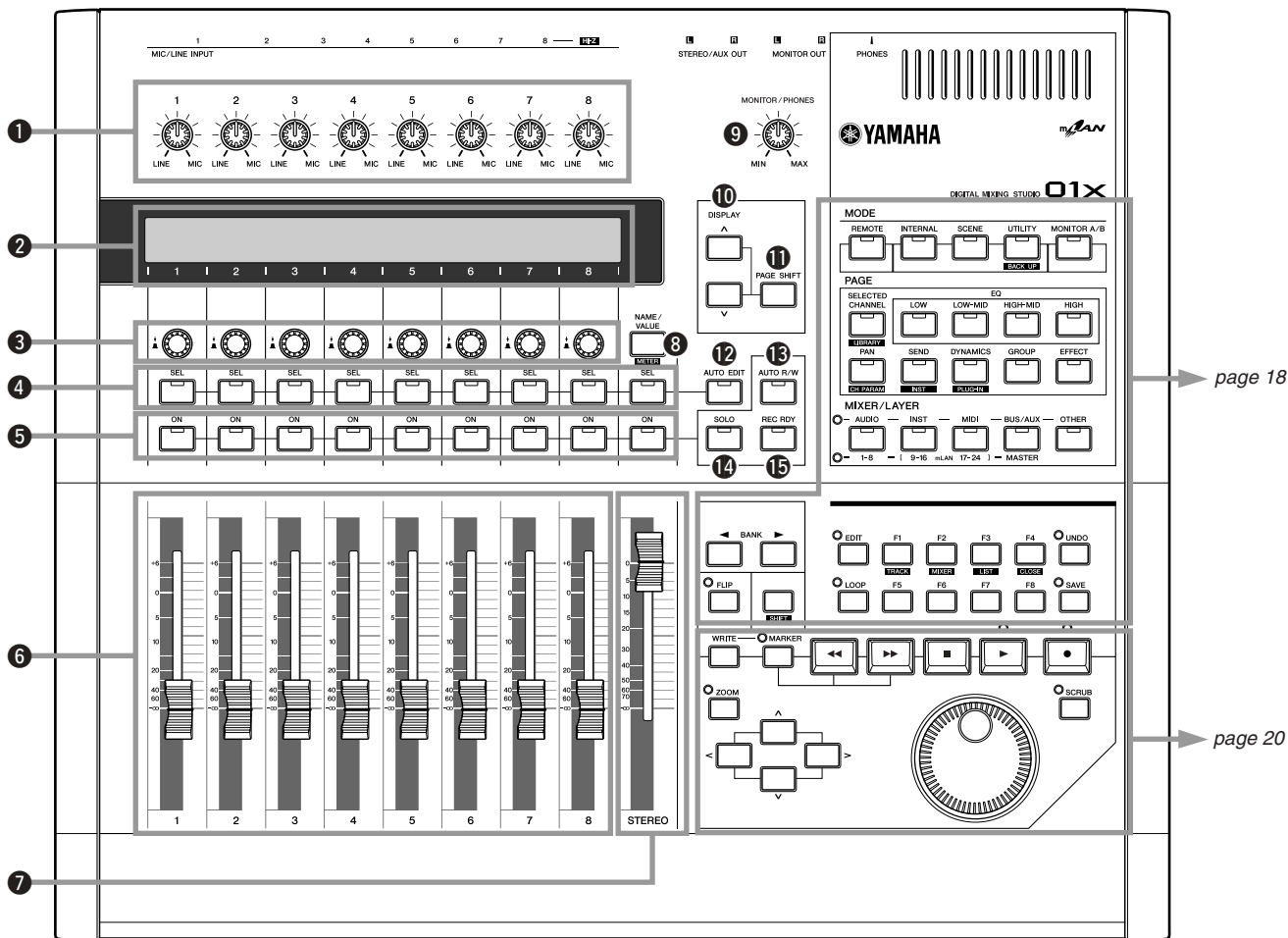

page 18

page 20

### Channel Module/Stereo/Display...

#### 1 Gain knob

These adjust the input sensitivity (level of head amp) of each MIC/LINE INPUT over a range of +4 dB to -46 dB. These are always set to control the level of the MIC/LINE inputs 1 - 8 regardless of the MIXER/LAYER selection. The settings cannot be stored (saved) as a Scene Library.

#### 2 Display

This backlit LCD (liquid crystal display) displays various information for operation of the 01X or DAW (digital audio workstation). In most of the displays, this indicates the functions and parameter values assigned to the channel knob directly beneath the indication in the display. When using the Remote mode, this conveniently allows you to set parameters on the software without having to check your computer screen. The indicated information differs according to the setting of the [NAME/VALUE] button and the condition of the [SELECTED CHANNEL] button (page 19).

### 3 Channel knobs

These knobs mainly control the parameter settings/values respectively assigned to them. They are also used to execute (YES) or cancel (NO) operation when a confirmation message appears (page 143). By simultaneously holding down the [SHIFT] button and turning the desired knob, you can quickly make broad value changes.

### 4 [SEL] buttons

When the [SELECTED CHANNEL] button (page 19) is on, these buttons enable you to select desired channels. The [SEL] button indicator for the currently selected channel lights up. The channel selected by each [SEL] button depends on the layer selected in the MIXER/LAYER section (page 40). When a fader has been assigned to a Group (page 101), the Group assignment can be temporarily released by simultaneously holding down the [SEL] button and moving the fader. In the Remote mode, the [SEL] button flashes during automation touch-in. You can manually activate touch-out by pressing the [SEL] button while it is flashing. The button can also be used to start touch-in manually when the [AUTO EDIT] button is ON.

### 5 [ON] buttons

These buttons turn the selected channels on or off. The actual function differs depending on the status of the [AUTO R/W] button, [SOLO] button or [REC RDY] button (13, 14, 15).

### 6 Channel faders

Depending on the settings of the MIXER/LAYER section (page 40), these motorized faders adjust either the input level of each channel or the output level of the AUX/REC buses. By setting the Fader Touch Timeout parameter (page 88) to an appropriate value, a touch-out function for the faders can be emulated. See also 12[AUTO EDIT] button).

### 7 Stereo fader

This motorized fader adjusts the final output level of the Stereo Out. By setting the Timeout parameter (page 88) to an appropriate value, a touch-out function for the faders can be emulated. See also 12[AUTO EDIT] button).

### 8 [NAME/VALUE] button

Switches the display type between a channel/parameter/value multi-function display or one that shows only the parameter values. By holding down the [SHIFT] button and pressing the [NAME/VALUE] button, you can also enable and change the meter display (page 46).

### 9 MONITOR/PHONES knob

Adjusts the level of the signal that is output from the MONITOR OUT jacks and PHONES jack.



- You can monitor the output directly (monitor cascade) through the connected speaker system/headphones (according to the [MONITOR A/B] setting), if the stereo master output of the DAW is set to the last two available channels (the last two numbered channels specified with mLAN Auto Connector; refer to the separate Installation Guide).

### 10 DISPLAY [^/∨] (Up/Down) buttons

For selecting the various display pages in order, as indicated in the Function Tree (page 84).

### 11 [PAGE SHIFT] button

Holding down the [PAGE SHIFT] button and pressing the DISPLAY [^/∨] (Up/Down) buttons allows you to jump to certain pages (such as the first in a particular parameter category). (See the Reference section for details.)

### 12 [AUTO EDIT] (Automation Edit) button

When this button is set to on in the remote mode, you can manually activate touch-in (page 15) by using the [SEL] button on each channel.

### 13 [AUTO R/W] (Automation Read/Write) button

When this button is set to on in the Remote mode, you can switch the automation mode (page 15) by using the [ON] button of each channel.

### 14 [SOLO] button

When this button is set to on, you can solo individual channels by using the corresponding [ON] buttons. Solo can be turned on for just one or any number of channels as desired by pressing the appropriate [ON] buttons (5).

### 15 [REC RDY] (Record Ready) button

When this button is set to on in the remote mode, you can switch Record Ready for the desired channel on/off by using the corresponding [ON] button.

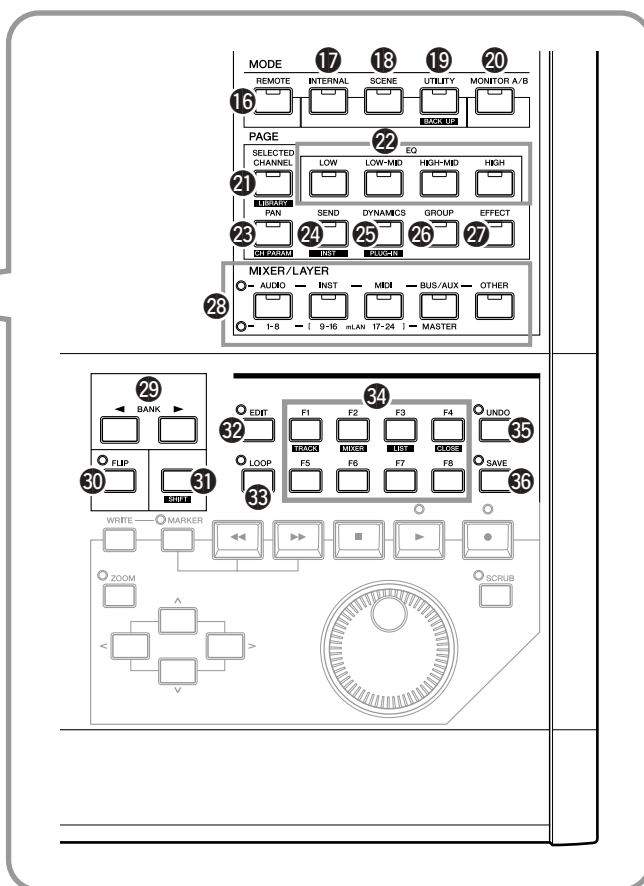
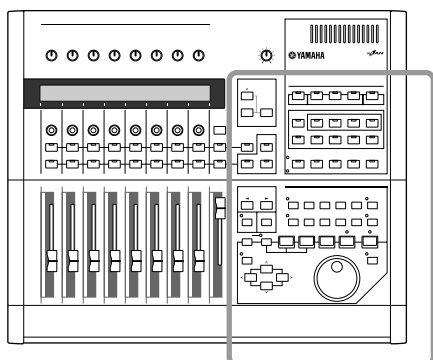

## MODE

### 16 [REMOTE] button

This button selects the Remote mode, enabling you to control DAW (digital audio workstation) software on a connected computer (page 23). In this condition, the MIXER/LAYER buttons (page 19) function according to their upper names ([AUDIO], [INST], [MIDI], [BUS/AUX], [OTHER]).

### 17 [INTERNAL] button

This button selects the Internal mode, enabling normal internal operation of the 01X (pages 37, 85). In this condition, the MIXER/LAYER buttons (page 19) function according to their lower names.

### 18 [SCENE] button

This button selects the Scene mode, enabling you to store and recall Scenes (page 85).

### 19 [UTILITY] button

This button selects the UTILITY mode, enabling you to set the global settings for the entire system (page 86). Pressing [UTILITY] from any of the Utility pages automatically calls up the Menu Select display (page 87).

### 20 [MONITOR A/B] button

This indicates (and can be used to set) the balance between the levels of the stereo output of the internal mixer and the stereo output from the DAW software to the monitor out/headphones. Pressing the switch alternates between the two settings: A (lamp is lit) and B (lamp is off). The setting can be changed by holding the [MONITOR A/B] button and turning the appropriate knob ([5] or [7]).

**PAGE****21 [SELECTED CHANNEL] button**

This button switches between the Selected Channel mode (the lamp lights) and Multi Channel mode (the lamp is off).

- **Selected Channel mode**

In this mode, the display shows several parameters (or functions) for a single, selected channel--selected by pressing the [SEL] button (page 17).

- **Multi Channel mode**

In this mode, the display shows a single parameter (or function) for all eight channels in the selected layer.

**22 [EQ] buttons**

These buttons call up the display for the EQ settings of each channel (page 96). The attenuation for each Input Channel can also be adjusted in each page (in the Selected Channel mode).

**23 [PAN] button**

This button calls up the display for the pan settings of each channel (page 99).

**24 [SEND] button**

This button calls up the display for the AUX Send settings of each channel (page 100).

**25 [DYNAMICS] button**

This button calls up the display for the Dynamics settings of each channel (page 100). The parameters can be set in the Selected Channel mode; the Multi Channel mode has only Dynamics on/off switches.

**26 [GROUP] button**

This button calls up the display for assigning multiple channels to fader or mute groups, and for pairing adjacent faders (page 101).

**27 [EFFECT] button**

This button calls up the display for the effect settings of each channel (page 102).

**MIXER/LAYER****28 MIXER/LAYER buttons**

In the Internal mode, these are used to switch among input layers (page 40). In the Remote mode, they are used to switch among banks (page 15).

**BANK/FLIP/SHIFT****29 BANK [◀/▶] (Left/Right) buttons**

These buttons are used to select the next/previous layer (page 40) or bank (page 15), in groups of eight channels.

**30 [FLIP] button**

When this button is set to on, the functions of the channel knobs and the channel faders are switched. To set both the faders and the channel knobs to control the channel knob function, simultaneously hold down the [SHIFT] button and turn this button on (the lamp flashes).

**31 [SHIFT] button**

This button is used in combination with other buttons to select alternate functions and operations.

**Remote Control Buttons**

The functions of these buttons may differ depending on your particular software. Refer to the Remote Function List (page 104)

**32 [EDIT] button****33 [LOOP] button****34 [F1] - [F8] (Function 1 - 8) buttons****35 [UNDO] button****36 [SAVE] button**

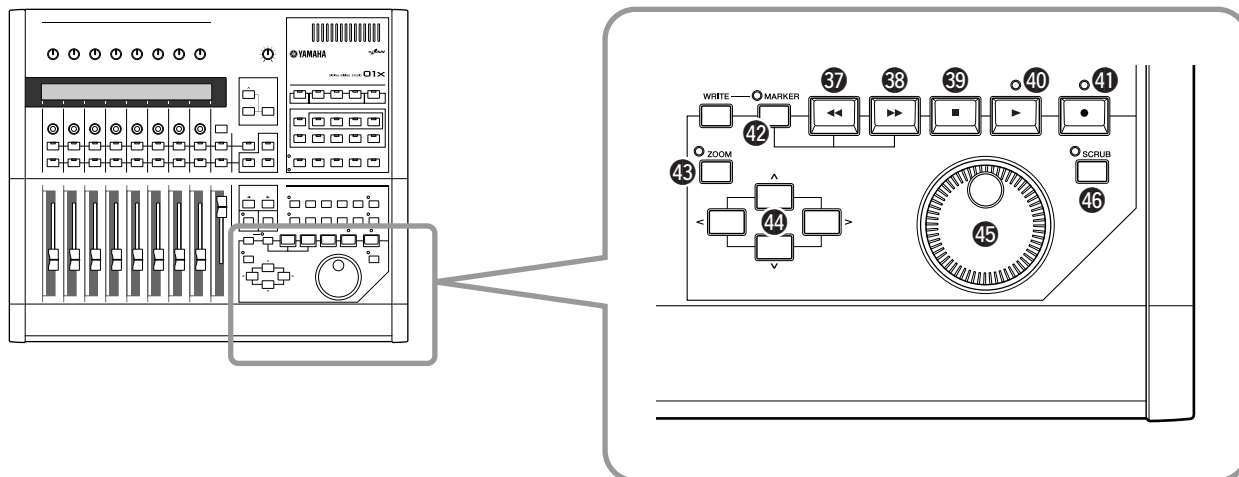

## Transport Buttons

These buttons are used primarily for controlling song playback/recording on your DAW software. They also let you control the software no matter which mode is selected, Remote or Internal. The functions are the same as the transport buttons in the software (page 104). On the SQ01 for example, the buttons function as follows.

### 37 [◀◀] (Rewind) button

Causes the song location to rewind.

### 38 [▶▶] (Forward) button

Causes the song location to fast forward.

### 39 [■] (Stop) button

Stops playback or recording of the song. By connecting an optional Foot Switch (page 23), you can also control this by foot.

### 40 [▶] (Play) button

Starts song playback. If the Record button is On, recording will begin. By connecting an optional Foot Switch (page 23), you can also control this by foot.

### 41 [●] (Record) button

Enables recording standby. Pressing this again cancels recording standby.

### 42 [MARKER] button

To enter a marker at a selected location in the song, turn this button on and press the [WRITE] button.

- Move to the next marker location by using [MARKER] and the [▶▶] (Forward) button.
- Move to the previous marker location by using [MARKER] and the [◀◀] (Rewind) button.
- To delete a marker, move to the location of the marker and press the [MARKER] and [WRITE] button again.

### 43 [ZOOM] button

When the 01X is set to Remote mode, this button turns Zoom on and off.

### 44 Cursor [◀/▶/▲/▼] (Left/Right/Up/Down) buttons

For moving the cursor and navigating in the DAW display.

### 45 Dial (Rotary Encoder)

Moves the song position (pointer/line).

### 46 [SCRUB] button

When this is set to on, the dial can be used for the Scrub function.



## Rear Panel

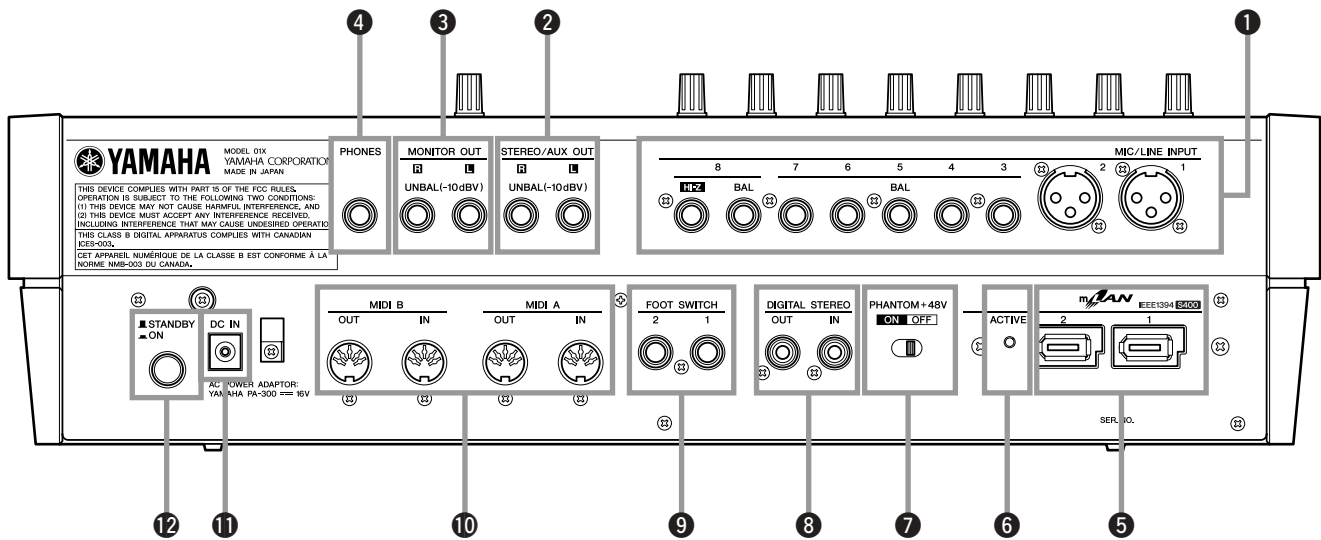

## 1 MIC/LINE INPUT

### • MIC/LINE INPUT (XLR) jacks 1/2

These are XLR-3-31 type balanced input jacks. The nominal input level is -46 to +4 dB. Mics, direct boxes, or line level devices with balanced output jacks can be connected here. Each jack corresponds to AD1 and AD2 of the Input Patch settings (pages 27, 61, 88). The pin configuration is shown below.

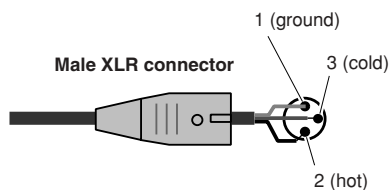

### • MIC/LINE INPUT (TRS phone) jacks 3 through 8 (BAL)

These are TRS phone type 1/4" input jacks (balanced). The nominal input level is -46 to +4 dB. Devices such as synthesizers or rhythm machines with unbalanced outputs can also be connected here. Each jack corresponds to AD3 through AD8 of the Input Patch settings (pages 27, 61, 88). The pin configuration is shown below.

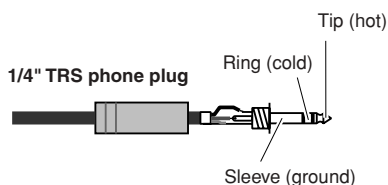

### • Using Phase Reverse

On some audio devices, the hot and cold pin placement of the connector may be reversed (compared to the conventional configuration). In this condition, the audio may sound "squashed" or unnatural (out of phase) when heard in stereo. When using such devices, set the Phase parameter (page 99) to Reverse.

### • MIC/LINE INPUT jack 8 (HI-Z)

This is a high impedance 1/4" phone input jack (unbalanced). The nominal input level is -46 to +4dB. An instrument with high output impedance such as an electric guitar or bass with passive-type pickups can be connected here. This jack corresponds to AD8 of the Input Patch settings (pages 27, 61, 88).

## 2 STEREO/AUX OUT jacks

These are 1/4" phone output jacks (unbalanced) that output the signals of the stereo bus, rec bus or AUX bus 1/2.

## 3 MONITOR OUT jacks

These are 1/4" phone output jacks (unbalanced) for connection to your monitor setup, such as a stereo system or powered speakers.

## 4 PHONES jack

This is a 1/4" TRS phone output jack for connecting a set of stereo headphones for monitoring.

**5 mLAN (IEEE 1394) connectors 1/2**

For connecting mLAN devices or IEEE 1394-compatible (FireWire/i.Link) devices via standard IEEE 1394 (6-pin) cables. The operation is identical no matter which terminal is used, mLAN 1 or mLAN 2. If the target device has a 4-pin connector, use a commercially available 4-pin to 6-pin IEEE 1394 cable. Avoid creating a connection “loop (page 147)” when connecting the devices.

**● mLAN benefits**

“mLAN” is a digital network designed for musical applications. It uses and extends the industry standard IEEE 1394 high performance serial bus.

- Only one type of cable is needed, in contrast to the multiple varieties required by conventional systems.
- MIDI and audio signal flow can be routed freely without being limited by the actual cable configuration. Signal flow between devices can be changed without having to physically reconnect the devices.
- Cables can be connected and disconnected without turning off the power (hot pluggable).
- The isochronous data transfer used by IEEE 1394 is a transfer method that guarantees the right to transmit or receive data at fixed intervals (125 microseconds). This is ideal for transfer of realtime data such as audio.

**6 ACTIVE lamp**

This lights to indicate the 01X functions as an mLAN device. Even if an mLAN cable is not connected, this lamp stays lit. If an error occurs during mLAN operation, the light turns off.

**7 PHANTOM +48V switch**

This switch supplies phantom power to MIC/LINE (XLR) jacks 1 and 2. Turn this switch on if you are using condenser microphones requiring external +48V power with MIC/LINE INPUT (XLR) jacks 1 and 2.

**⚠ CAUTION**

- Make sure to turn this switch off if a device not requiring an external power supply is connected to the INPUT (XLR) jacks 1 or 2.
- If phantom power is turned on, power will be supplied to both INPUT (XLR) jacks 1 and 2.

**8 DIGITAL STEREO IN/OUT jack**

This is a coaxial jack (phono connectors) for digital input/output of stereo signals. They conform to the IEC-60958 consumer format. For digital audio transfer, use an RCA pin cable.

**9 FOOT SWITCH jacks 1/2**

Optional foot switches (Yamaha FC4/FC5) can be connected here to control transport operations such as start/stop. For example, when using remote control with the SQ01, FOOT SWITCH 1 can be used to turn the [▶] (Play) button on/off, while FOOT SWITCH 2 can be used to control on/off of the [●] (Record) button.

**NOTE**

- The appropriate operation may not work if you use a foot switch other than the Yamaha FC4/FC5 (or equivalent).

**10 MIDI A IN/OUT terminals  
MIDI B IN/OUT terminals**

These terminals are for connection to external MIDI devices. They allow you to transfer MIDI data between an mLAN-connected computer and MIDI devices connected to the 01X, making the 01X a convenient dual-port MIDI interface for your computer. The MIDI A terminal corresponds to mLAN MIDI port 2, and the MIDI B terminal device corresponds to mLAN MIDI port 3 (page 95).

**11 DC IN terminal**

Connect the AC adaptor (PA-300) to this terminal.

**⚠ WARNING**

- Do not attempt to use an AC adaptor other than the Yamaha PA-300 or an equivalent recommended by Yamaha. The use of an incompatible adaptor may cause irreparable damage to the 01X, and may even pose a serious shock hazard! ALWAYS UNPLUG THE AC ADAPTOR FROM THE AC POWER OUTLET WHEN THE 01X IS NOT IN USE.

**12 STANDBY/ON switch**

This switches the power between ON and STANDBY (off).

**⚠ CAUTION**

- Make sure to follow the procedures described in the “Setting Up” section (page 24) when turning the power of the 01X on or off.
- Even when the switch is in the “STANDBY” position, electricity is still flowing to the instrument at a minimum level. When not using the 01X for an extended period of time, be sure to unplug the AC power adaptor from the wall AC outlet.

# Connections

- CAUTION** • Before connecting the 01X to other electronic components, turn off the power to all the components. Before turning the power on or off to all components, set all volume levels to minimum (0). Otherwise, electrical shock or damage to the components may occur.

The following diagram shows a typical example of connections to the 01X. Connect your microphones, instruments, and external devices as shown in this diagram.

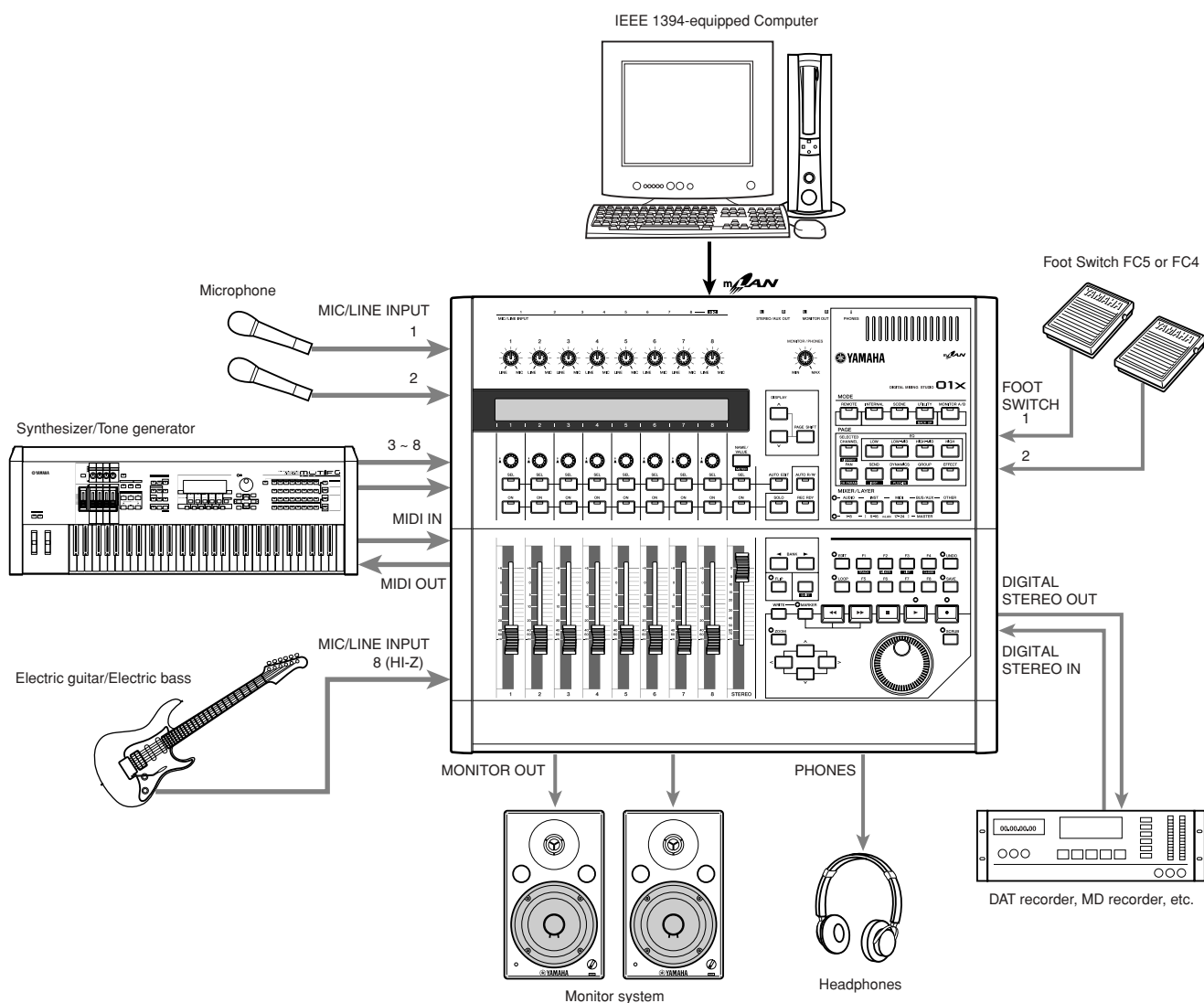

## ● Wordclock

Digital audio equipment must be synchronized when digital audio signals are transferred from one device to another. Even if both devices use identical sampling rates, digital signals may not transfer correctly, or audible noise or unwanted clicks may occur if the digital audio processing circuits inside each digital audio device are not synchronized with each other. Wordclocks are signals that enable digital audio processing circuits to synchronize with each other. In a typical digital audio system, one device operates as the wordclock master, transmitting wordclock signals, and the other devices operate as wordclock slaves, synchronizing to the wordclock master. If you are digitally connecting the 01X to other equipment, you must decide which device to use as the wordclock master and which devices to use as slaves, then set up all the devices accordingly. The 01x can be used as the wordclock master running at either 44.1 kHz, 48kHz, 88.2 kHz (Macintosh only), or 96 kHz, or slaved to an external wordclock source. When mLAN is used, the 01X's mLAN Auto Wordclock must be set to ENABLE (page 92).

## NOTE

- For information on installing the mLAN driver and connecting the 01X to your computer via mLAN as well as information on necessary system requirements, refer to the separate Installation Guide.

# Setting Up

## Power Supply

Make sure that the 01X's [STANDBY/ON] switch is set to the STANDBY (off) position.

- ① Connect one end of the AC cable to the PA-300.
- ② Connect the PA-300's DC plug to the 01X's DC IN terminal on the rear panel.
- ③ Connect the other end (normal AC plug) to the nearest electrical outlet.

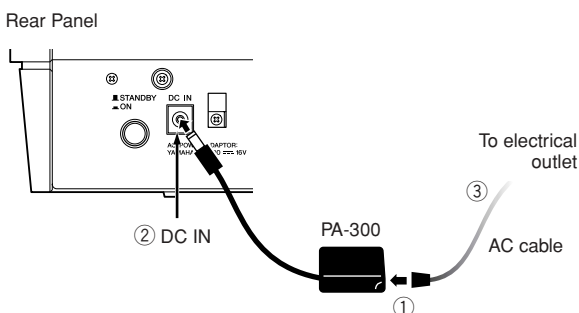

**NOTE**

- When unplugging the AC Adaptor, disconnect it in reverse order from that above.

**WARNING**

- Do not attempt to use an AC adaptor other than the Yamaha PA-300 or an equivalent recommended by Yamaha. The use of an incompatible adaptor may cause irreparable damage to the 01X, and may even pose a serious shock hazard! ALWAYS UNPLUG THE AC ADAPTOR FROM THE AC POWER OUTLET WHEN THE 01X IS NOT IN USE.

**CAUTION**

- Even when the switch is in the "STANDBY" position, electricity is still flowing to the instrument at a minimum level. When not using the 01X for an extended period of time, be sure to unplug the AC power adaptor from the wall AC outlet.

## Power-on Procedure

Once you've made all the necessary connections (page 23) between your 01X and any other devices, make sure that all volume settings are turned down all the way to zero, then turn on the every device in your setup in the order of MIDI masters (senders), MIDI slaves (receivers), then audio equipment (mixers, amplifiers, speakers, etc.). This ensures smooth signal flow from the first device to the last (first MIDI, then audio).

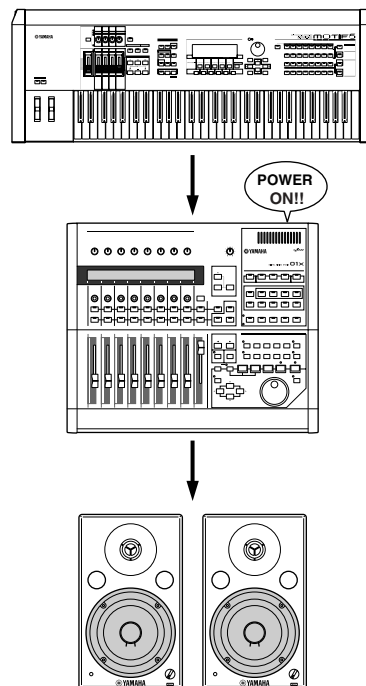

**NOTE**

- Before beginning installation of mLAN Driver for Windows, switch off the power to the 01X (see the separate Installation Guide).
- When powering down the setup, first turn down the volume for each audio device, then switch off each device in the reverse order (audio devices first, then MIDI).
- Be sure to restart your DAW after restarting the 01X (turning the power off and on again) or switching the DAW in the Remote Select menu (page 87). (This applies when using SQ01, Cubase/Nuendo or Digital Performer.)

## Turning on the 01X

**CAUTION**

- Before you switch your 01X on or off, turn down the volume of any connected audio equipment.

- ① Press the [STANDBY/ON] switch. A splash screen is displayed. The Internal mode (Home) screen appears next.

■ STANDBY  
■ ON



- ② Raise the sound system volume to a reasonable level.

- ③ Turn the 01X's MONITOR/ PHONES knob clockwise to set an appropriate volume level.

MONITOR / PHONES

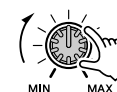

# Basics Section

## Overview of the 01X

This section gives you an overview of the 01X's features. The following diagram shows the various component sections or "blocks" of the 01X: mixer, effects and remote control. It also indicates the mLAN interface capabilities, both audio and MIDI.

### Signal flow between the 01X and the DAW on the computer

#### ● When using a DAW other than SQ01 V2

- \*1 On Macintosh, MIDI data is transferred between the drivers and the applications by using OMS (Open Music System).
- \*2 Windows only.
- \*3 Figures in parentheses indicate the number of available channels when the wordclock is set to 88.2kHz or 96kHz.

- \*4 You can monitor the output directly (monitor cascade) through the connected speaker system/headphones (according to the [MONITOR A/B] setting), if the stereo master output of the DAW is set to the last two available channels (the last two numbered channels specified with mLAN Auto Connector; refer to the separate Installation Guide).

### Computer

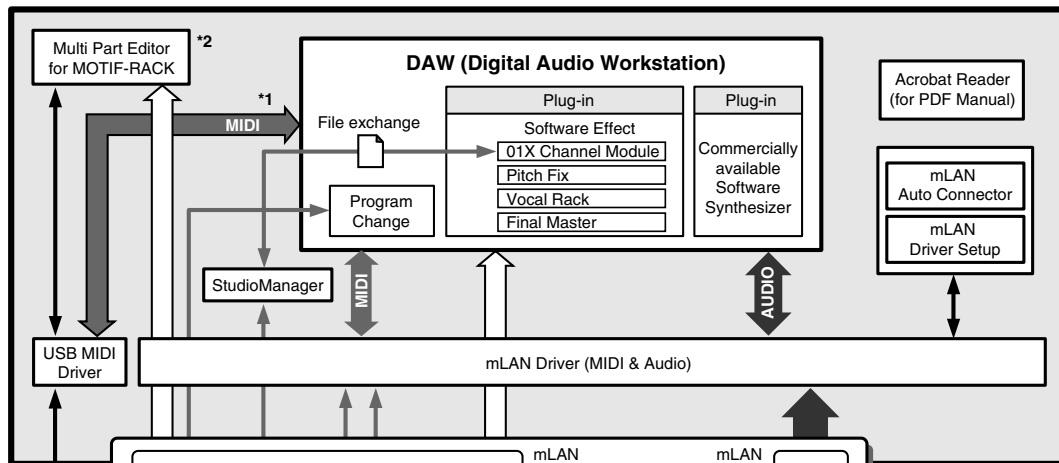

### 01X

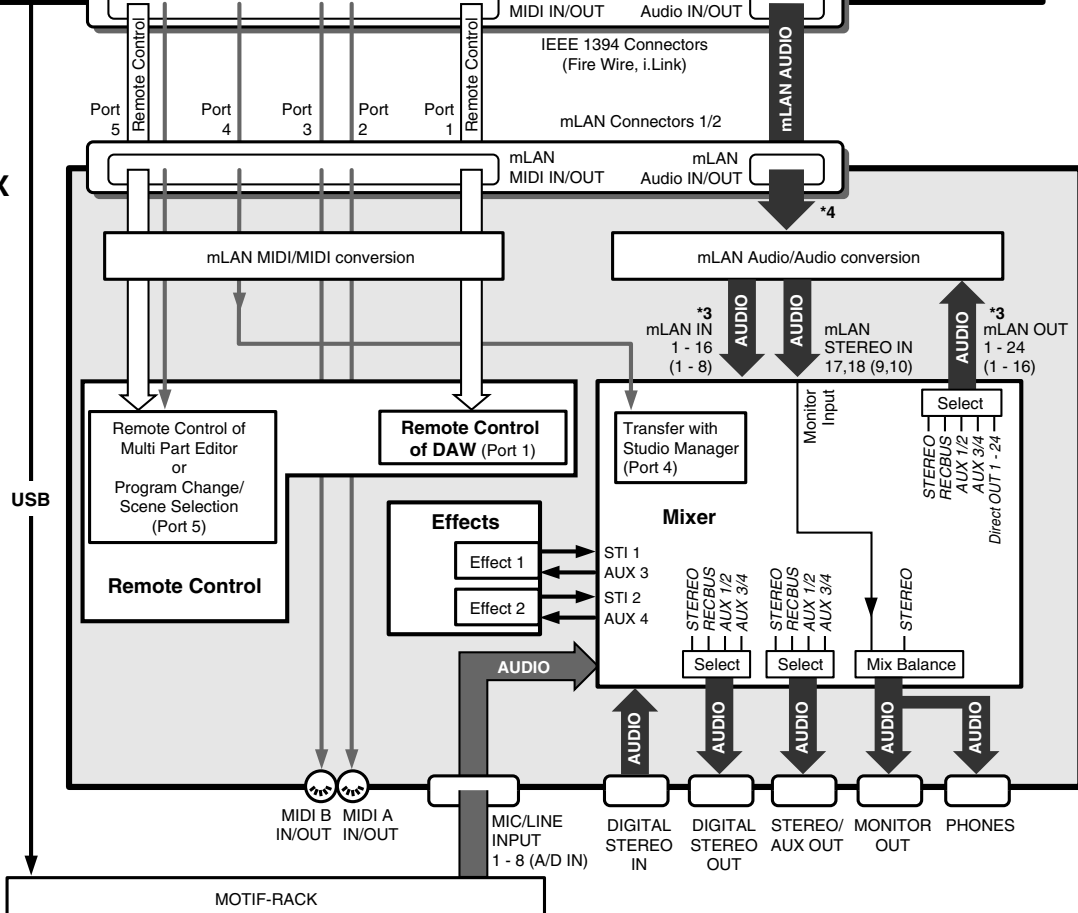

- When using the included SQ01 V2



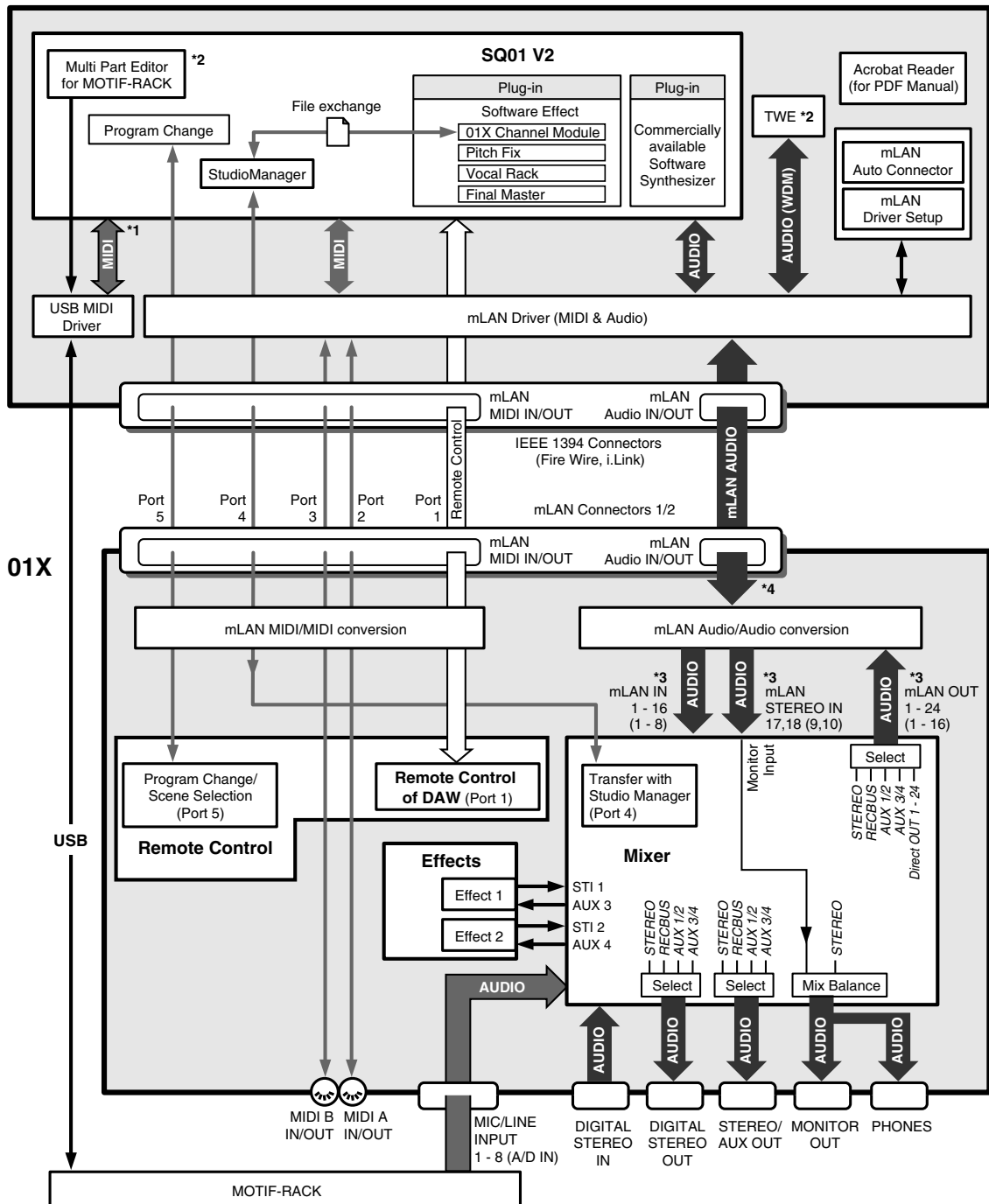







Computer





# Mixer

## ● Symbol Indications

-  ..... Amplifier stage
-  ..... Value change via knob
-  ..... Value change via fader
-  ..... On/off switch, button
-  ..... Phase
-  ..... Connected
-  ..... Unconnected
-  ..... AD (Analog/Digital) converter
-  ..... DA (Digital/Analog) converter
-  ..... Sampling rate converter

\* Switches or faders connected with dotted line mean the setting/value for one is linked to the other.

### NOTE

- For information on the entire signal flow of the 01X, refer to the Block Diagram (at the end of this owner's manual).

## Input patch

Getting Started (page 61)  
Reference (page 88)

The Input Patch section allows assignment of input signals to input channels 1 through 8 and stereo input channels (STI) 1/2. The following types of input signals can be selected.

- MIC/LINE INPUT 1-8
- DIGITAL STEREO IN
- EFFECT(FX)1/2  
(Return signals from internal effects 1/2; ST IN only)

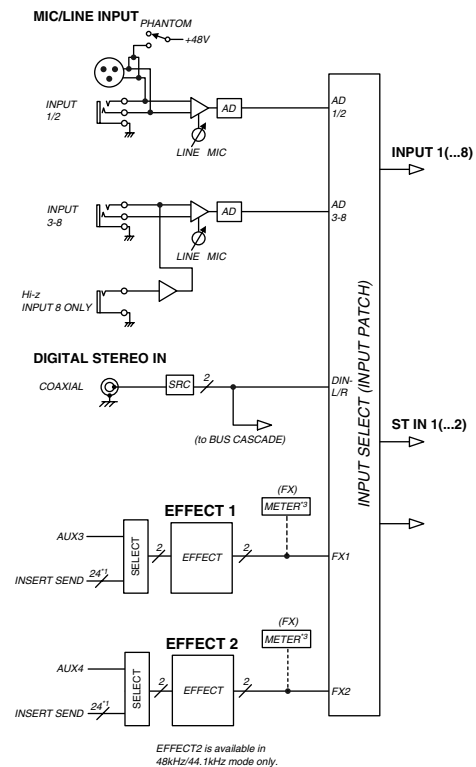

\*1 Wordclock 96kHz/88.2kHz : 16  
\*3 Studio Manager only

## Input channel

### ● Input channels 1 through 8

These are monaural input channels used mainly for input of microphones or line-level instruments. The signals that are input to input channels 1 through 8 pass through an attenuator, phase switch, 4-band EQ, and dynamics processor, and are sent to the stereo bus, AUX buses 1 through 4 and Rec bus. Input channels 1 through 8 also have a direct output (DIRECT OUT), which allows them to be sent directly from mLAN outputs.

### ● Input channels 9 through 24 (mL1 through mL16)

These are input channels for the signal from mLAN IN. Each of these channels is structured the same as the input channels. When the 01X is set to 88.2kHz (Macintosh only)/96kHz operation, mLAN input (from computer to the 01X) is limited to 8 channels (9-16: mL1-mL8).



- Faders and most parameters of adjacent odd-even channels are linked for stereo operation (page 102).

### ● 01X Channel Module

The included “01X Channel Module” is a special plug-in effect that reproduces the Dynamics and four-band EQ processing of these input channels using the processing power of your computer (refer to the separate Installation Guide). You can use the 01X Channel Module on your DAW independently from the 01X. For example when recording, you can apply Dynamics and EQ to the 01X’s monitor sound only and record dry to the DAW, then play back the track, processing it with the 01X Channel Module as needed — all without the 01X. (Refer to the “DIRECT OUT POSITION” on page 91 and the 01X Channel Module PDF manual.)

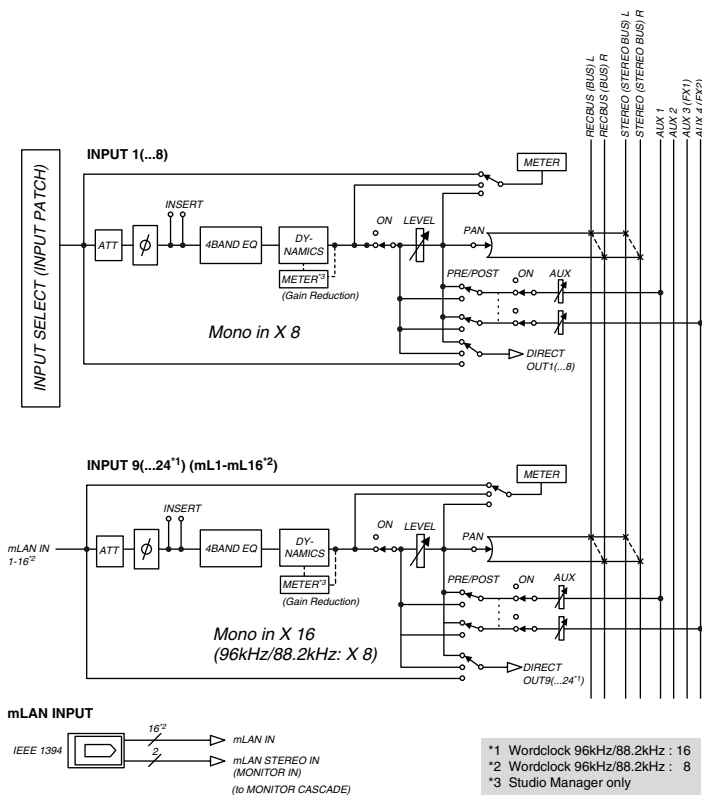

## Stereo input channels 1/2

These are stereo input channels used mainly for inputting the return signal from internal effects 1/2. However, the input signal assignment can be changed in the input patch section, allowing these to be used as additional input channels.

The level (return level) of the stereo input channels can be controlled by using the channel faders 7 (for Effect 1) and 8 (for Effect 2) when [MASTER] layer in the MIXER/LAYER is selected in Internal mode.

### ● Differences from input channels

- Stereo
- No dynamics processor
- No direct output

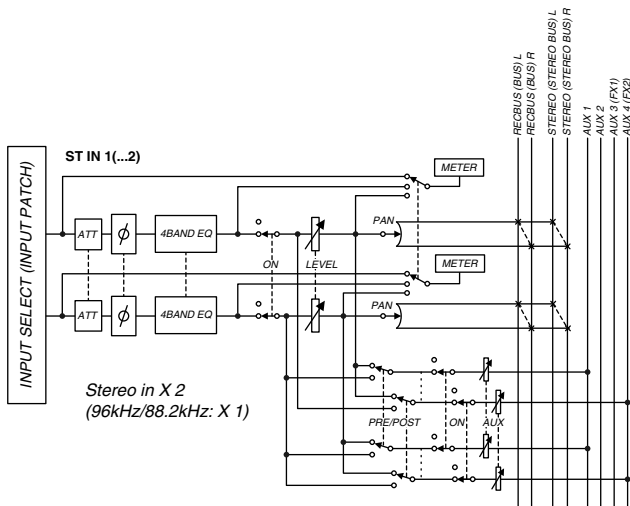

### ⚠ CAUTION

- When using an internal effect via the Aux Send, do NOT turn up the send level to the corresponding AUX bus for the channel to which the effect return signal is routed. Doing so will result in loud feedback, and may damage your equipment. For example, when the 01X is in the default condition, AUX 3 is routed to the input of internal effect 1, and the L/R signals of the ST IN channel 1 are routed to the output. If you turn up the send level of ST IN channel 1 to AUX 3, a feedback loop is created.

### NOTE

- Since stereo input channels 1/2 are stereo, adjacent odd-numbered/even-numbered signals will be assigned to them when MIC/LINE inputs are selected as the input signals. Also, if DIGITAL STEREO IN is selected, both L and R signals will be assigned.

## Digital cascade connection

The input signal from the rear panel DIGITAL STEREO IN connector can be cascade-connected directly to the stereo bus, instead of being routed through the input patch section and patched to an input channel. This is convenient when you want to link an external digital mixer or similar device with the mixer section of the 01X. (Refer to the “Digital In Stereo Bus Cascade” on page 93.)

## Oscillator

The 01X contains an oscillator that allows you to select either sine wave (100Hz, 1kHz, 10kHz) or white noise. The oscillator signal can be sent to rec bus, AUX buses 1 through 4, or the stereo bus. (Refer to the “Oscillator” on page 93.)

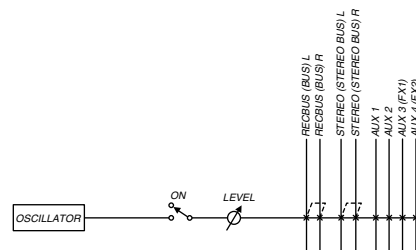

## Output channel

### ● Stereo output channel

This is a stereo output channel that processes the signals sent from each channel to the stereo bus. Stereo faders control the level of these outputs. It provides a 4-band EQ and dynamics processor identical to those provided on the input channels. The output signal of the stereo output channel is sent via the output patch section to the various output jacks, and is also simultaneously output to the MONITOR OUT jacks and PHONES jack.

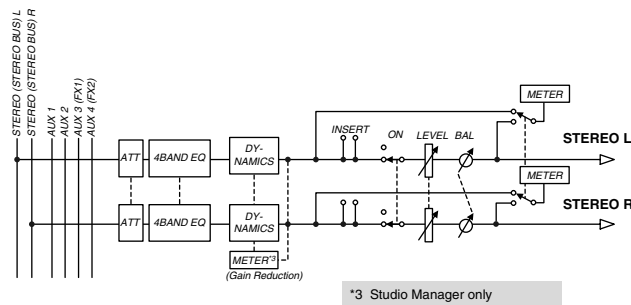

### ● Rec bus output channel

This is a stereo output channel that processes the signals sent from each channel to the rec bus. It provides a four-band EQ and dynamics processor identical to those provided on the input channels. The output signal of the rec bus channel is sent via the master level/output patch section to the various output jacks.

The master level of the rec bus can be controlled by using the channel 1 fader when [MASTER] layer in the MIXER/LAYER is selected in Internal mode.

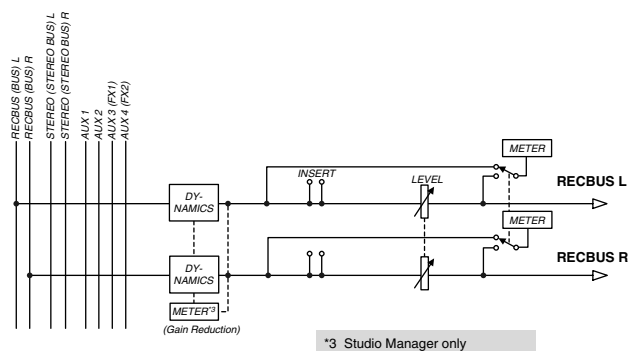

### ● AUX buses 1 through 4

The signals sent from each channel to AUX buses 1–6 pass through a master level, and are sent to the output patch section.

The master level of AUX buses 1 through 4 can be controlled by using the channel faders 3 through 6 when [MASTER] layer in the MIXER/LAYER is selected in Internal mode.

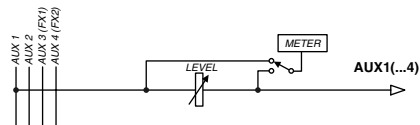

Getting Started (page 62)  
Reference (page 90)

## Output patch

Output Patch is the section where output signals are assigned to mLAN channels 1/2 through 23/24, DIGITAL STEREO OUT jack, and STEREO/AUX OUT jack. The following output signals can be selected.

- Stereo bus (The output signal of the stereo bus routed through the stereo output channel.)
- Rec bus
- AUX bus 1/2
- AUX bus 3/4

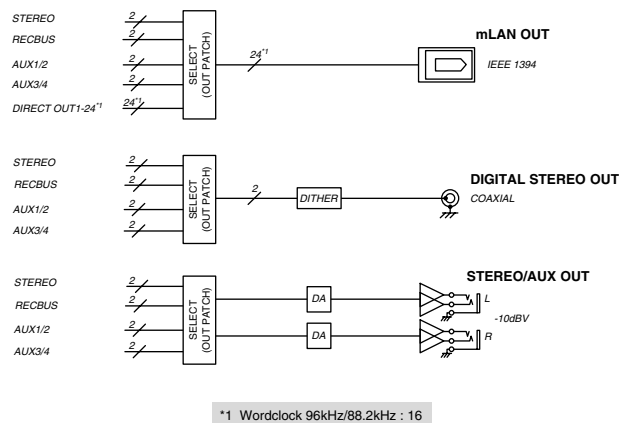

### NOTE

- In general, these output signals can be assigned to any output jack or output channel. For the STEREO OUT jacks and DIGITAL STEREO OUT jacks, two adjacent odd-numbered/even-numbered signals will always be assigned.
- The direct out setting for a specific channel is cancelled if the corresponding output channel is assigned to stereo bus, rec bus or AUX buses (page 90).

## Monitor output/headphone output

For monitoring purposes, the 01X provides MONITOR OUT jacks and a PHONES jack. The MONITOR OUT jacks and PHONES jack always output the same signal, and is linked to the level adjustment. You can monitor the output directly (monitor cascade) through the connected speaker system/headphones (according to the [MONITOR A/B] setting), if the stereo master output of the DAW is set to the last two available channels (the last two numbered channels specified with mLAN Auto Connector; refer to the separate Installation Guide). (Refer to “Monitor” on page 96.)

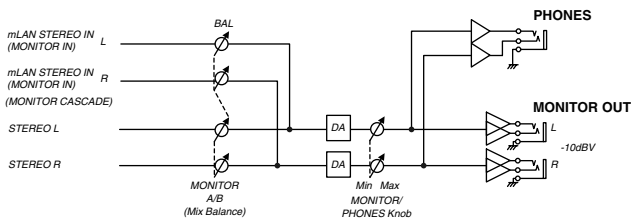

## Internal effects 1/2

The two built-in effect units deliver a wide variety of effects including spatial-type effects such as reverb and delay, modulation type effects such as chorus and flanger, and guitar-type effects such as distortion and amp simulation. These effects can be used via Aux send (the level corresponds to the master level of the stereo input channels), or inserted into a desired channel.

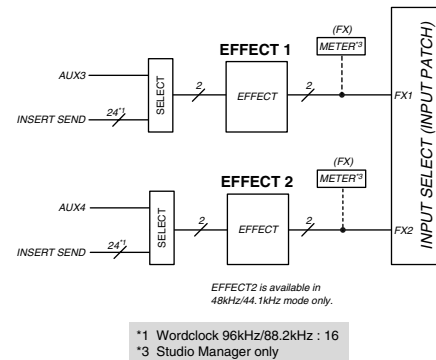

\*1 Wordclock 96kHz/88.2kHz : 16  
\*3 Studio Manager only

### NOTE

- If 88.2kHz/96kHz operation is enabled, only one internal effect block is available (Effect 1/Aux 3).
- For details about each Effect Type, refer to page 125; for details about each Effect Parameter, refer to page 126.
- For an application example showing how to use the effects, see page 57.

## Remote Control

With mLAN MIDI transfer, the 01X can be used to control DAW (digital audio workstation) software, such as Cubase SX and Logic, as well as the Multi Part Editor for Yamaha MOTIF ES or MOTIF-RACK program (contained on the included CD-ROM). This powerful feature lets you control software programs by using knobs, faders and buttons on the panel of the 01X, rather than your computer's mouse and keyboard.

- Because of the bi-directional data flow between the 01X and the computer, the changes you make to levels and parameter values are immediately mirrored in the LCD of the 01X — giving you intuitive and instant editing in real time, without having to check the computer display.

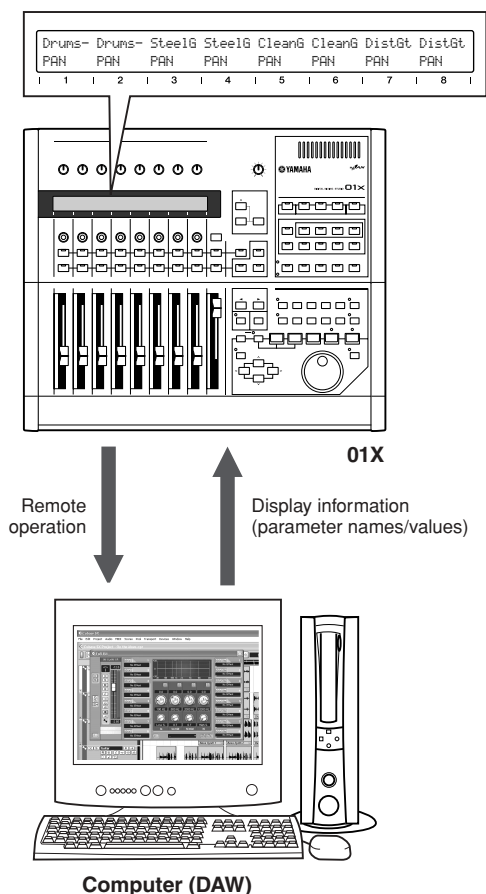

- Since control of the DAW mixer channels and 01X channels is simultaneous and bi-directional, you can record level changes in the song data and have them reflected automatically in the 01X faders, providing full mixer automation.

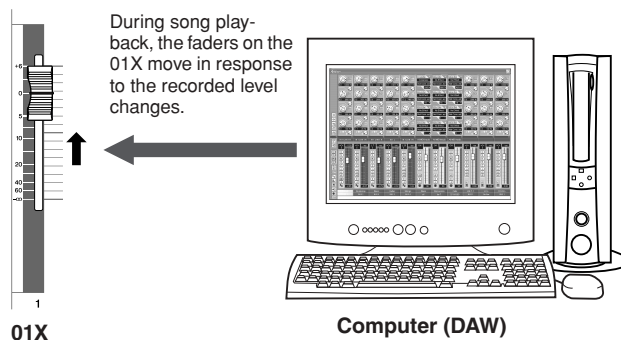
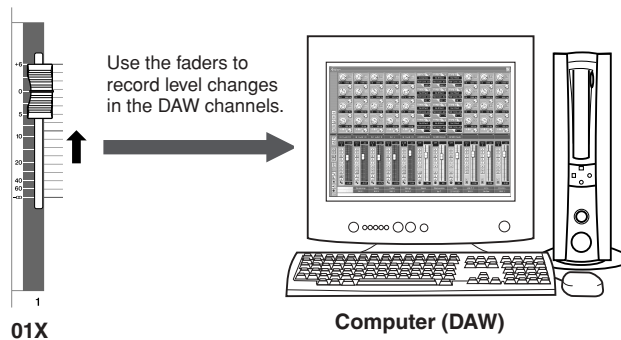

**NOTE**

- For details on the functions in the Remote mode, see the Remote Function List (page 104).
- Depending on your particular DAW, not all control features may be implemented, and some buttons may be assigned different functions. Refer to the owner's manual of your particular DAW for specific instructions and setups.
- Remote control is only possible when the version of your particular DAW application and operating system conforms to the system requirements. For details, refer to the separate Installation Guide.
- For information on the necessary setup for Remote Control, refer to page 66 (Cubase SX/SL) or the "Demo Song Playback" in the separate Installation Guide (other than Cubase SX/SL).



## mLAN Interface

---

The mLAN interface of the 01X also lets you connect MIDI or audio devices that do not have mLAN connectors or capability. The following conversion is possible:

- mLAN MIDI signal to/from MIDI signal (2 ports)  
(mLAN MIDI IN/OUT Port 2/3 of mLAN connectors to/from MIDI IN/OUT A/B jack)
- mLAN audio signal to/from analog audio signal
- mLAN audio signal to/from digital audio signal
- Analog audio signal to/from digital audio signal

## Application examples

The 01X is one of the most versatile recording mixers available. Its all-in-one, fully digital operation makes it ideal for songwriters, producers, project studios, home recording, and virtually all post-production applications. Here are some of the ways you can set up and use the 01X in your own system.

### 1) Recording mixer and monitor mixer

In this application example, vocals and instruments can be recorded to computer while monitoring playback of MIDI tone generators with the 01X.

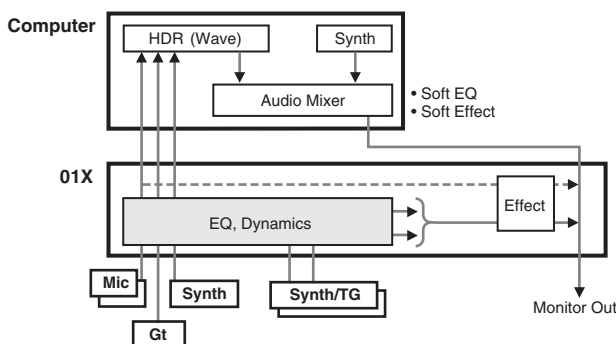

Here, the sequencer data drives the MIDI instruments which come in stereo via two input channels and are processed with Dynamics, EQ and effects as needed. The signal is then routed to the MONITOR OUT bus for monitoring. Vocals, guitar and keyboard are input to the other channels and are sent (after Dynamics and EQ processing) directly to the computer.

This setup lets you record instruments in real time to existing sequence data, while hearing the previously recorded MIDI tracks. Any audio tracks and plug-in synthesizers, etc. can also be monitored.

### Remote control features

Control your computer's audio/MIDI sequencer from the 01X while tracking, alternately switching between INTERNAL and REMOTE as needed. The 01X also gives you control over the audio mixer in the sequencer (including the plug-in instruments), as well as detailed parameter control over the plug-in effects.

### Recording mixer features

Naturally, the 01X gives you simultaneous eight-channel input with full mixing control—level adjustment, Dynamics, and four-band EQ. Using the Channel Module software on your computer gives you onscreen display and control of level, Dynamics, and the four-band EQ.

This application also takes advantage of the flexible routing options, letting you set up a separate stereo bus and recording bus. Moreover, the individual vocals and instruments are recorded directly to computer as 24-bit digital audio data—at up to 96kHz sampling rate, if desired.\*

\* When the 01X is set to 88.2kHz/96kHz operation, mLAN transmission (from the computer) is limited to eight channels and only one internal effect block can be used.

### Monitor mixer features

Another huge benefit of this setup is that the mixer inputs recorded to the computer can be monitored directly from the 01X—complete with all Dynamics, EQ and effect processing. You can also monitor the audio tracks on the computer with 01X effect processing as well, via the input channels or the DIGITAL IN terminal.

## 2) Digital mixer function

Here, the 01X functions simultaneously as a front-end/ audio interface for a computer system as well as a fully digital mixer for your sequencer audio tracks.

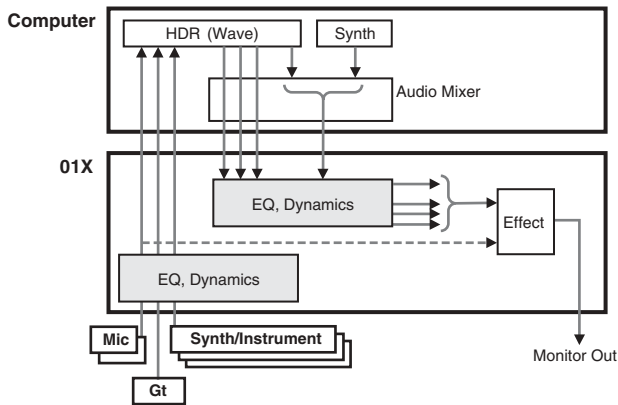

With the mLAN connection, this system allows you to route up to sixteen independent audio channels (plus the two-channel stereo master) from the computer to the input channels of the 01X, and have the eight rear-panel inputs available for your vocals and other instruments. Naturally, all Dynamics, EQ and effect processing are available for this 24-channel setup. Finally, you can also use this same configuration for mixdown—returning the entire sound with processing to the computer for mastering.

## 3) Recording mixer, monitor mixer — with use of 01X Channel Module software and Studio Manager

This advanced hardware/software hybrid system combines the conveniences of computer-based mixing/processing with the intuitive control surface and digital processing of the 01X.

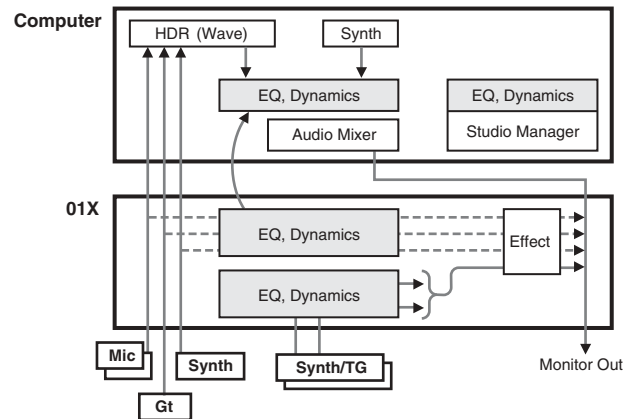

In this application, the 01X Channel Module plug-in and the Studio Manager software (both included with the 01X) are used to link mixing and processing operations between the 01X and your computer. The result is a transparent, exceptionally easy-to-use hardware/software combination.

The panel controls on the 01X and the controls of Studio Manager on the computer are linked directly—adjusting a parameter on one changes that of the other. The Studio Manager has conventional channel strips that you can control from the 01X. It also has special windows for the Dynamics processing, EQ, and effects. The EQ window, for example, features a frequency response graph that changes as you make the settings—very intuitive and very easy.

With this configuration, you can use the channel processing on the 01X to hear the intended final sound, but record dry to computer.

The 01X Channel Module plug-in can be used afterwards to actually process the recorded sound as you wish. Moreover, you can copy settings from Studio Manager to the 01X Channel Module and adjust/tweak the mix using the Channel Module plug-in. Settings you've made or changed in the Channel Module can also be transferred back to Studio Manager.

# Memory (Library) Structure

The 01X features several libraries (internal memory) that enable you to store Scene, Input Patch, Output Patch and other data. You can also quickly recall this data from the libraries to restore previous parameter values. Furthermore, the Backup function lets you save your data including the Utility settings. The 01X offers the following libraries:

## Library

**Scene : 100** page 85

Default settings 00	01	...	99
------------------------	----	-----	----

**EQ : 200** page 99

01	...	40	41	...	200
----	-----	----	----	-----	-----

**Input Patch : 33** page 89

Default settings 00	01	...	32
------------------------	----	-----	----

**Dynamics : 128** page 100

01	...	40	41	...	128
----	-----	----	----	-----	-----

**Output Patch : 33** page 91

Default settings 00	01	...	32
------------------------	----	-----	----

**Effect 1/2 : 128** page 103  
(Settings that apply to both 1 and 2 effect units)

01	...	43	44	...	128
----	-----	----	----	-----	-----

**Channel : 129** page 103

Default settings (-∞dB) 00	Default settings (Nominal level : 0dB) 01	02	...	128
----------------------------------	---	----	-----	-----

Preset  
 Destination for Store operation

## System Backup

**Backup : 1** page 86

Utility	+ The current Scene, Channel, EQ, Dynamics, Effect, Input Patch, Output Patch
Monitor settings	

**NOTE**

The 01X Utility and Monitor settings are lost when the power is turned off, unless System Backup is performed. In order to ensure the settings here are effective the next time you turn the 01X on, perform System Backup by holding [SHIFT] and pressing [UTILITY] (page 86).

mLAN ↕ Settings are compatible. (See the Studio Manager PDF manual.)

\* For details about each Preset Library parameter, refer to the Appendix section.

**Studio Manager**

↕ Settings are compatible. (See the 01X Channel Module PDF manual.)

**01X Channel Module**

# Basic Operations

In this section, you'll learn about the structure of the modes of the 01X, its panel display indications and its fundamental operations.

## Modes

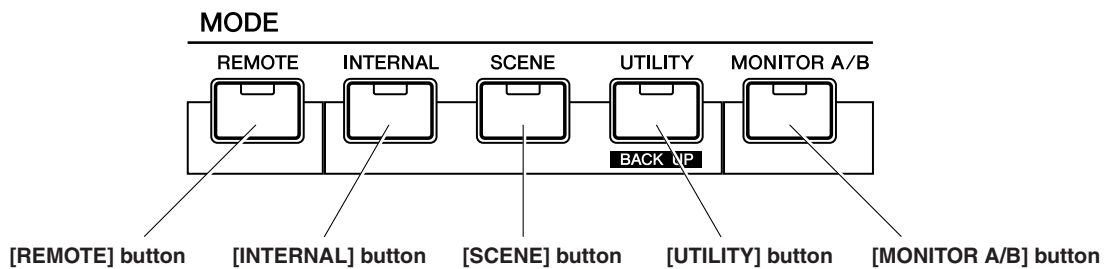

Mode		LED	Operation/Settings	Selected Channel	Selecting a mode (example)	Display Indications (page 38)	Related pages	
REMOTE Mode	GENERAL (SQ01)	[REMOTE] lights	Remote Control of the computer software (DAW). * For specific information on each of the DAW selections, see page 87.	—	[REMOTE]	A	104	
	LOGIC	[REMOTE] lights			[REMOTE]		106	
	CUBASE	[REMOTE] lights			[REMOTE]		108	
	SONAR	[REMOTE] lights			[REMOTE]		110	
	DIGITAL PERFORMER	[REMOTE] lights			[REMOTE]		112	
	Multi Part Editor (Stand Alone)	[REMOTE] flashes			[SHIFT]+[REMOTE] (To exit from the Remote mode for Multi Part Editor, press only [REMOTE].)		87	
INTERNAL Mode	HOME	[INTERNAL] lights	Adjusts the input level for the currently selected channels in the MIXER/LAYER. Each channel's level value/level meter is displayed. To set the nominal level, press the appropriate channel knob. To set the default value, simultaneously hold down the [SHIFT] button and press the appropriate channel knob.	—	[INTERNAL]	B	—	
		[SCENE] unlights						
		[UTILITY] unlights						
	SCENE	[SCENE] lights	Scene settings (Saving or recalling the mixer/effect parameters)	—	[SCENE]	C	85	
	UTILITY	[UTILITY] lights	Global settings for the entire system/remote control.	—	[UTILITY]	D	86	
	MONITOR	[MONITOR] lights / unlights	Switches between Monitor A and B. To sets the output balance between the DAW audio and the audio of the 01X itself, hold down the [MONITOR] button and turn knob [5] (for A) or [7] (for B).These settings can also be made in the Monitor display of Utility mode.	—		E	96	
	PAGE	EQ	[EQ LOW] lights	EQ settings	Yes	[INTERNAL] → [EQ LOW]	F	96
			[EQ LOW-MID] lights			[INTERNAL] → [EQ LOW-MID]		97
			[EQ HIGH-MID] lights			[INTERNAL] → [EQ HIGH-MID]		97
			[EQ HIGH] lights			[INTERNAL] → [EQ HIGH]		98
		PAN	[PAN] lights	PAN settings	Yes	[INTERNAL] → [PAN]	99	
		DYNAMICS	[DYNAMICS] lights	DYNAMICS settings	Yes	[INTERNAL] → [DYNAMICS]	100	
		SEND	[SEND] lights	AUX sends settings	Yes	[INTERNAL] → [SEND]	100	
GROUP	[GROUP] lights	GROUP settings	Yes	[INTERNAL] → [GROUP]	101			
EFFECT	[EFFECT] lights	EFFECT settings	—	[INTERNAL] → [EFFECT]	G	102		
LIBRARY	SCENE	[(SCENE) lights]	Save (store) each Library data.	—	[SCENE] → DISPLAY [^]	H	85	
	INPUT PATCH	([(UTILITY) lights]			[UTILITY] → Channel knob 2 → DISPLAY [^/v]		89	
					[UTILITY] → Channel knob 2 → DISPLAY [^/v]		91	
	EQ	[EQ LOW] lights [EQ LOW-MID] lights [EQ HIGH-MID] lights [EQ HIGH] lights			Yes (SELECTED CHANNEL only)		[INTERNAL] → [SELECTED CHANNEL] → [EQ] → DISPLAY [v]	99
	DYNAMICS	[(SELECTED CHANNEL] lights [DYNAMICS] lights)					[INTERNAL] → [SELECTED CHANNEL] → [DYNAMICS] → DISPLAY [v]	100
	EFFECT	[(EFFECT] lights)					[INTERNAL] → [EFFECT] → DISPLAY [^/v]	103
	CHANNEL	[SELECTED CHANNEL] flashes					[SHIFT] + [SELECTED CHANNEL]	103

Before Using

Basics Section

Getting Started

Reference

Appendix

# Mode selection and display indications

Before Using

Basics Section

Getting Started

Reference

Appendix

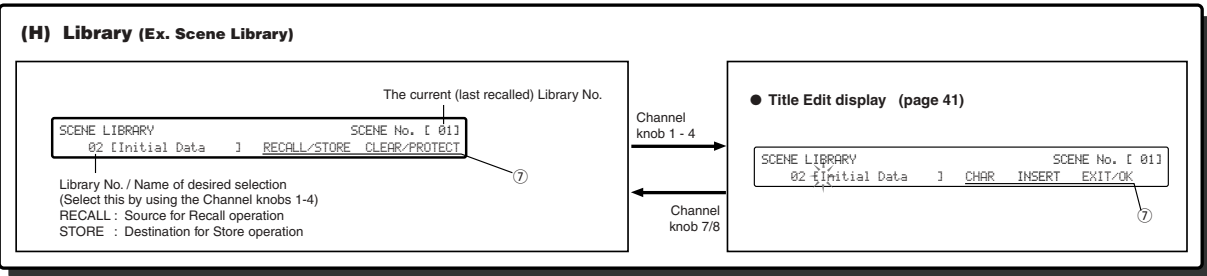
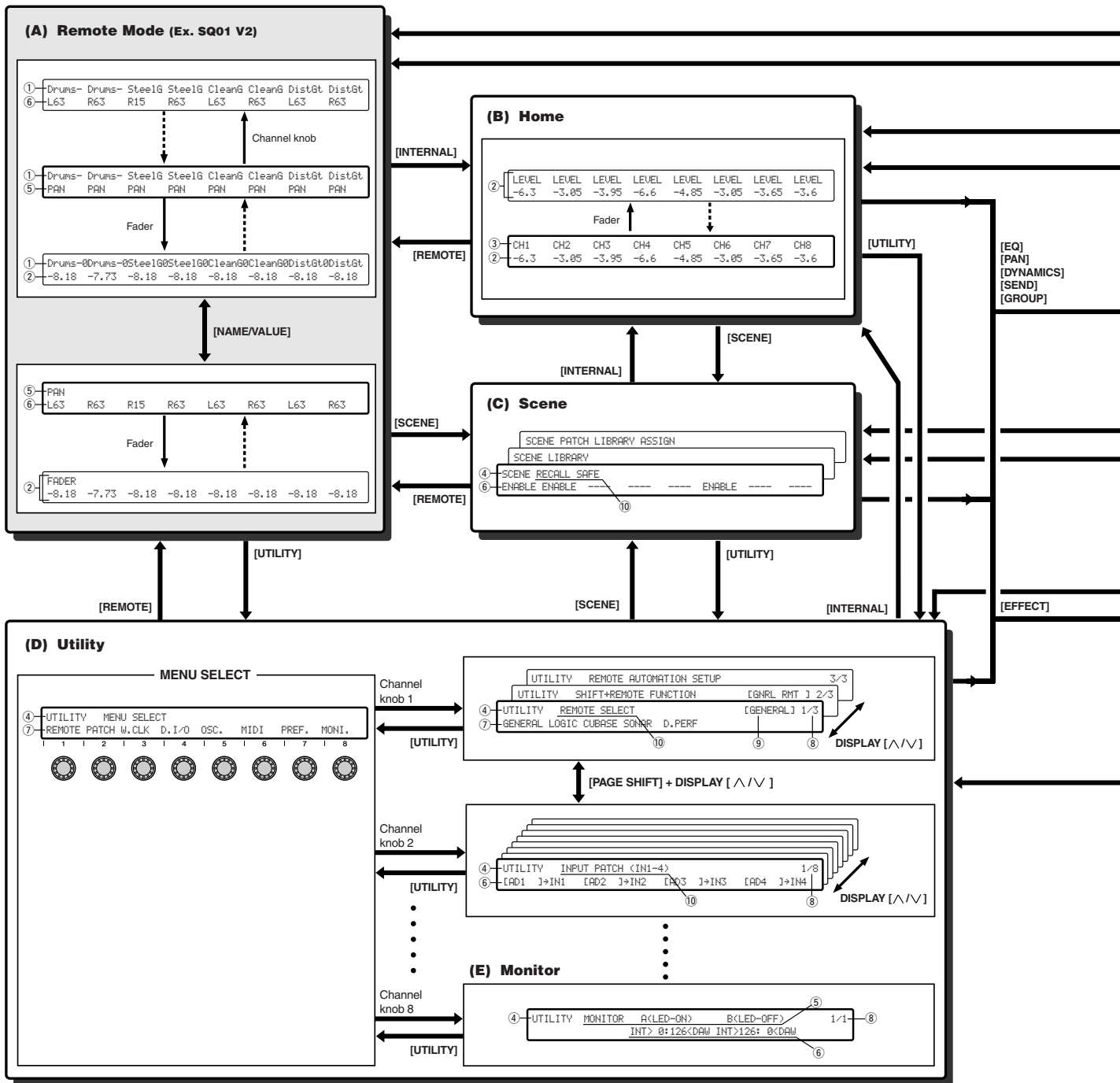



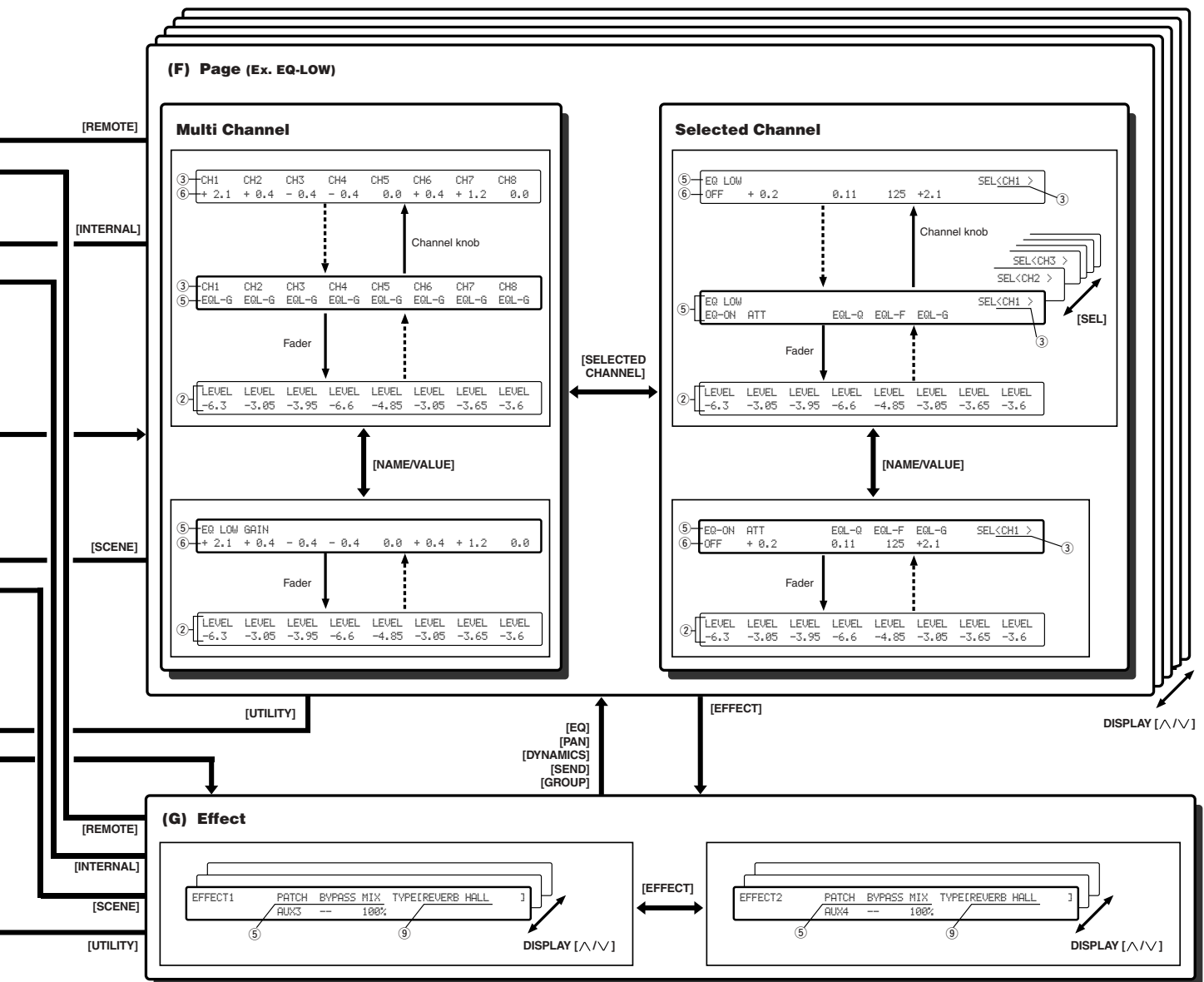

- ① Channel Module Name (Part/Track Name)
- ② Level (adjusted via Channel faders)
- ③ Channel (channel name) or selected channel (channel name) assigned to the respective module
  - CH1-8 : Input Channlel 1-8
  - mL1-16 : Input Channel 9-24 (mLAN Input Channel 1-16)
  - BUS : REC Bus
  - AUX1-4 : AUX Bus 1-4
  - ST1/2 : Stereo Input Channel 1/2
- ④ Mode
- ⑤ Parameter/function name
- ⑥ Settings (selected by turning channel knobs)
- ⑦ Function or operation (selected by pressing channel knobs)
- ⑧ Page number
- ⑨ Currently selected settings
- ⑩ Display name

**NOTE**

- For information about UTILITY OSC. ASSIGN display, also see page 93.
- Channel name can be edited by using the Studio Manager. (Refer to the PDF manual.)

## Layer selection/Channel selection

The Input Channels and Output Channels are arranged into layers, as illustrated below. There are four layers altogether.

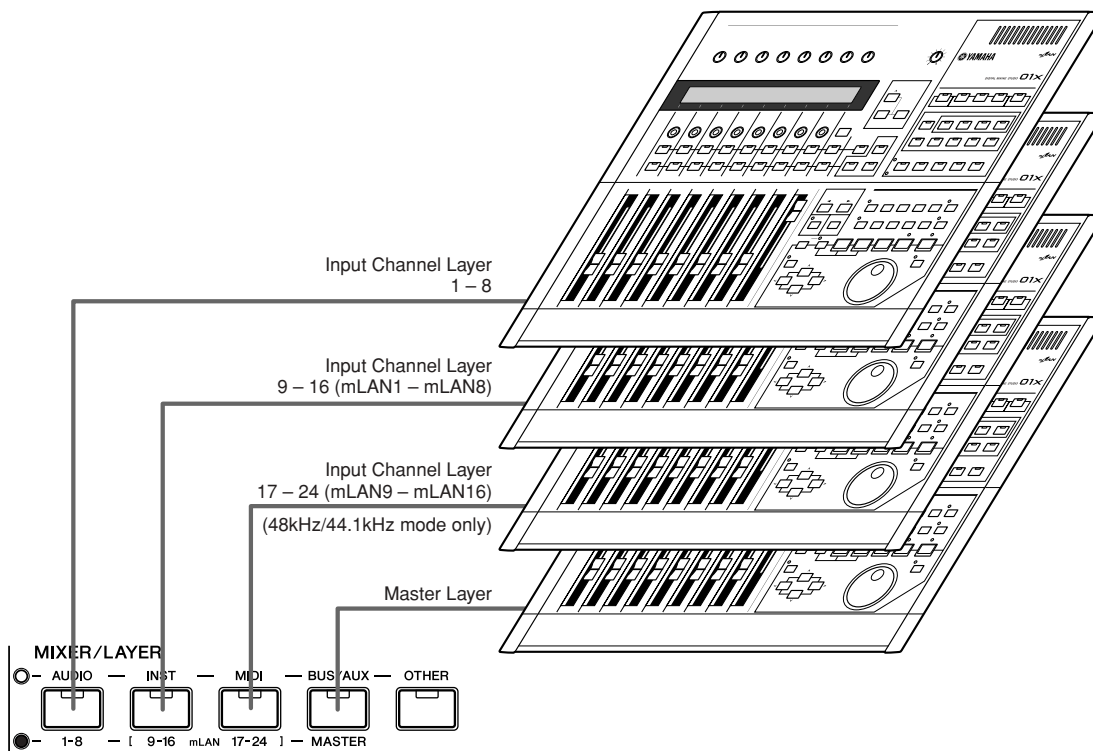

The currently selected layer determines the function of the channel strip, [SEL] buttons, [ON] buttons, and faders. Use the LAYER buttons to select a layer you wish to edit using the channel strip controls. The following table shows the layers that you can access using the LAYER buttons, and the parameters you can control using the channel strips on each layer.

LAYER buttons	Channel Strips	Display	Channels can be operated
[1-8] lights	1-8	CH1-CH8	Input Channels 1-8
[9-16] lights	1-8	mL1-mL8	Input Channels 9-16 (mLAN1-mLAN8)
[17-24] lights	1-8	mL9-mL16	Input Channels 17-24 (mLAN9-mLAN16)
[MASTER] lights	1	BUS	REC Bus Out master
	3-6	AUX1-4	AUX Bus 1-4 masters
	7/8	ST1/2	Stereo Inputs 1/2 (Stereo Input 2 is 48kHz/44.1kHz mode only)

**NOTE**

- The STEREO [SEL] button, [ON] button, and STEREO fader always control the Stereo Out signal, regardless of the Layer settings.

### ● Selected Channel mode

To select a channel on the 01X, press the corresponding [SEL] button. The channel is selected and the [SEL] button lamp lights up.

### ● Stereo Input Channel

For stereo input channels, you can set the left and right panpots individually. Repeatedly pressing the STEREO [SEL] button toggles between the left and right channels.

- L- : indicates the left channel pan settings of the stereo input channel.
- R- : indicates the right channel pan settings of the stereo input channel.

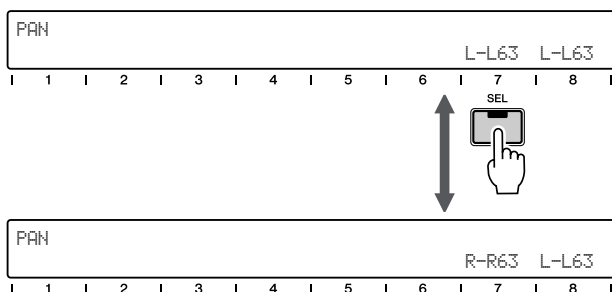

## Entering Characters (Title Edit)

You can freely name the stored Library. The following data types can be named.

- Scene Library (page 85)
- Input Patch Library (page 89)
- Output Patch Library (page 91)
- EQ Library (page 99)
- Dynamics Library (page 100)
- Effect Library (page 103)
- Channel Library (page 103)

The instructions below apply to naming of any of the Libraries.

#### NOTE

- Library titles are named after the Libraries themselves have been stored.
- This operation only saves the data of the Library name. Other setting data is not saved until you actually store the Library (pages 50, 54).

- ① Turn any of the channel knobs [1]- [4] to select the desired Library number for naming.
- ② Press any of the channel knobs [1]- [4] to edit the first position of the name. The first character of the name flashes.

#### NOTE

- To cancel the operation, press channel knob [7] (EXIT).

- ③ Turn any of the channel knobs [2] - [4] to move the cursor to the desired position.

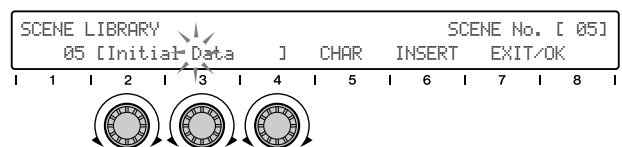

#### NOTE

- Keep in mind that turning channel knob [1] exits from the title edit operation.

- ④ Enter the letters, numbers, or symbols by turning the channel knob [5].

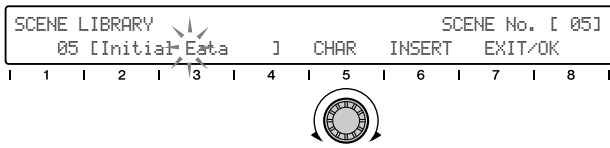

- ⑤ Turn any of the channel knobs [2] - [4] to move the cursor to the position of the next character.
- ⑥ Enter the other characters, by repeating steps ④ - ⑤ above.

**Insertion/Deletion of Characters**  
 Channel knob [6] is assigned to Insertion (INSERT) and Deletion (DELETE). Turn the channel knob [6] to select the Insertion (INSERT) or Deletion (DELETE) function.

To insert/delete a particular character, move the cursor to the desired position (in steps ③ and ⑤ above) and press channel knob [6]. Note that the DELETE operation does not delete the character before the cursor, but the flashing character on the cursor.

- ⑦ After entering the characters, press channel knob [8](OK) to execute the operation.

**CAUTION**

- Never attempt to turn off the power while data is being written to Flash ROM (while an “EXECUTING BACKUP. PLEASE KEEP POWER ON...” message is shown). Turning the power off in this state results in loss of all user data and may cause the system to freeze (due to corruption of data in the Flash ROM).

## Factory Set (Restore Factory Defaults)

This let you restore the 01X’s default settings. Once you edit any settings, the corresponding factory defaults will be overwritten and lost. Use the procedure below to restore the factory default settings.

**CAUTION**

- When you restore the factory default settings, all the settings for the all the Libraries and Utility will be overwritten with the factory defaults. Make sure you are not overwriting any important data. You should backup any important data to your computer beforehand by using Studio Manager. (For more details on using Studio Manager, see page 47 and the Studio Manager PDF manual.)

- ① Turn the power of the 01X off. Then, while holding down the [SCENE] and [UTILITY] buttons, turn the power back on. The display prompts you for confirmation.

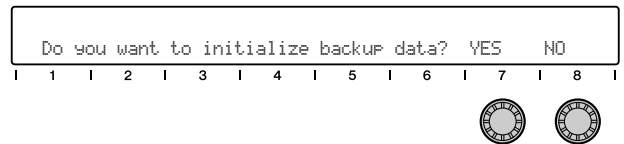
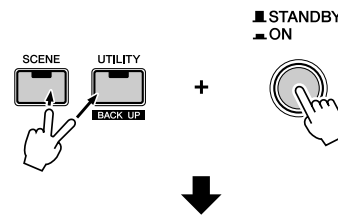

**NOTE**

- To cancel the operation, press channel knob [8] (NO).

- ② Press channel knob [7] (YES) to execute the operation.

**CAUTION**

- Never attempt to turn off the power while data is being written to Flash ROM (while an “Initializing backup data, please keep power on...” message is shown). Turning the power off in this state results in loss of all user data and may cause the system to freeze (due to corruption of data in the Flash ROM).

# Getting Started

## ■ Sound Mixing 101: The Fundamentals

Mixing is a skill, but it's also an art. Making a good recording and creating a good mix is more than simply plugging in a microphone and moving a couple of faders. In this section, you'll learn some of the basics of mixing, from setting up to tips on how to use effects and how to use the 01X to create a well-balanced mix.

For absolute mixing neophytes, this is an invaluable guide to the mixing/recording process. Even experienced pros may find it useful as a refresher course, since it may help to jog your memory on certain points. For all 01X users, it shows you concisely how to get the most out of this versatile console.

## ■ Before Recording:

### ● Reset all controls

Very simple. Call up Scene (Library) number 00, which instantly returns all settings to their zero or default values. However, make sure to manually reset all Gain knobs for the MIC/LINE INPUTs and turn the MONITOR/PHONES level down.

### ● Connect your sources (page 21)

Plug in your microphones, keyboards, guitars and whatever to the rear panel, but make sure you use the right connector for each. Inputs 1 and 2 feature balanced XLR connectors for microphones, with a phantom power switch. Inputs 3 to 8 are TRS balanced phone jacks for line sources, such as keyboards and tone generators. There's even a Hi-Z input on channel 8 for connecting an electric guitar or bass.

### ● Set up your monitor

If you're monitoring via headphones or the monitor outputs, turn up the MONITOR/PHONES knob. (Make sure you've set up a suitable amp/speaker system, too.) Set the STEREO fader to or near the maximum of 0 dB. The 01X features two selectable (and adjustable) monitor settings, switchable with the [MONITOR A/B] button or from the Utility mode — allowing you to toggle monitoring between the DAW's sound via mLAN or the internal sounds (pages 72, 96).

### ● Optimize the input levels (page 46)

This is a crucial operation, so take time and care in getting these levels right. Listen to each channel separately, and use the GAIN knobs (the top knobs on the console) to optimize the input signal level. In general, set the channel fader to around 0 dB, and while singing into the microphone or playing the instrument, slowly bring up the GAIN knob so that the sound is loud but not distorting. You can visually monitor this with the meters in the display of 01X and Studio Manager. (For details, see page 9 and the Studio Manager PDF manual.)

- **Clean up sounds**

Garbage in usually means garbage out. So make sure your source sounds are as clean and noise-free as possible. Use quality cabling, check microphone placement, turn off the air conditioner or anything else causing hum, patch in a noise gate, or change the pickups in your guitar if necessary.

- **Apply EQ (page 48)**

If you can't eliminate noise problems at the source, you can use the EQ on the 01X at this stage to cut it or minimize it. The EQ library (page 99) contains several preset programs for reducing hum, hiss, and noise. If you're after a natural sound, go back to the last step—it's always better to try to correct the sound source itself rather than correcting with EQ. You'll probably need to readjust the EQ when listening to all sounds in the mix, anyway.

- **Apply compression (page 52)**

If your vocalist is alternately too loud and too soft, or the bass fluctuates too wildly in level, or the guitar doesn't have enough presence—compression may be the answer. The Dynamics library contains a wide variety of preset programs for correcting, smoothing or enhancing the sound during recording, or after.

## ■ **After Recording:**

- **Set up stereo pairs (page 54)**

This links adjacent input channels (1 and 2, 3 and 4, etc.)—making it easy to unify level settings for both channels, as well as EQ, Dynamics, and other settings (except pan and phase).

- **Pan the sounds (page 55)**

Not only does panning allow you to create a more interesting stereo sound field, it lets you create more sonic space for each instrument in the mix. There are no hard and fast guidelines here, but generally pan to center the bass (which is non-directional anyway) and the lead vocal. Anything you've tracked in stereo should obviously be panned hard left and right (such as keyboards, overhead mics on drums, etc.).

- **Balance levels**

Now you're ready for the main task in mixdown—setting levels for each channel and getting the optimum balance. You may want to start with all faders at about 0 dB, and work down from there. In other words, DECREASE the level of backing instruments and backing vocals until they blend well with the lead vocals and solo instruments. Start loud and get softer—that's better than engaging in an ever-escalating battle of the faders.

- **Apply EQ—again (page 48)**

Now that all instruments can be heard together, you may need to redo some of your earlier EQ adjustments. EQ is an effective way to clean up a mix and keep certain instruments from clashing and muddying the sound. For example, you may want to cut the bass of a keyboard to leave more room for the bass guitar. On the other hand, you can trim the high-end from the bass so that it doesn't get in the way of the drums and percussion. Also make sure that the overall sound is tonally balanced—the low, mid, and high bands of the audio spectrum should contain an equal amount of sound energy.



### ● Use Solo and Mute (page 51)

When several instruments are mixed, it can be difficult to make individual judgments about them. Solo allows you to listen to channels in isolation, while Mute (on/off) lets you turn off channels you don't want to hear.

### ● Apply effects (page 56)

There's so much you can do right inside the 01X itself—with the two built-in effects units—we won't even scratch the surface here. For example, apply reverb to add ambience, use a short delay to "double" an instrument or vocal, use chorus to fatten a sound, or put distortion on a guitar track. The sky's the limit, and if you need more effects, you can patch in your own external processors (page 60).

### ● Fader groups and Mute groups (page 64)

The four fader groups of the 01X allow you to control several faders at the same time using just one fader. This can be used to create submixes within the main mix—allowing you to easily adjust all drum levels, keyboard levels, or vocal levels. The 01X also has four mute groups as well, letting you instantly turn several channels on or off together.

### ● Scenes (page 65)

This powerful feature, sometimes called 'snapshot automation,' lets you save all settings in a mix and call them up whenever you need them. Not only is it ideal for instantly switching between different projects and songs, it allows you to create mixing templates for different recording applications, and even set up different trial mixes for a single song and later choose the best one.

### ● Computer recording and sequencing

The 01X is especially versatile in a sequencing environment. With the digital output, you can record up to 24-bit/96 kHz audio to your computer (page 72). With the maximum 24 inputs (28, including the aux stereo inputs), you've got plenty of mixing space for your computer's audio outs, plus your MIDI instruments (page 67). And with the comprehensive control surface (page 104), you can control virtually all important operations on your favorite sequencer—right from the 01X.

---

That just about covers mixing basics and some of the more important features of the 01X. Although not a complete guide to audio mixing, it should be enough to get you started. For more information, check out the publications in your local music bookstore, or try a good technical bookstore. Best yet, search the Internet — you'll find it a wonderful resource for recording and mixing.

Now, go on and explore the rest of the Guided Tour, including the page references given above.

# Mixing Tutorial

**NOTE**

- The example displays are generally taken from the Value mode.
- Be sure to enter the INTERNAL mode before you start the following tutorial.

## Setting input levels and viewing the meters

Setting the input levels is a straightforward process, but we've included two separate sets of instructions here. The first involves only the 01X, while the second shows how to use your computer and the included Studio Manager software to set levels. With Studio Manager, you can see the levels big and bright on your computer monitor—plus have intuitive control over Dynamics processing and EQ as well. (For more details on using Studio Manager, see page 9 and the Studio Manager PDF manual.)

### On the 01X

- 1 Set all level controls to minimum.  
Make sure that the gain knob for the channel is set to LINE and the channel fader and STEREO fader are at minimum.
- 2 Connect the input source(s).
- 3 Turn on the meters.  
Enable metering by holding down the [SHIFT] button and pressing the [METER] ([NAME/VALUE]) button.
- 4 Play the source and slowly bring up the levels, starting with the gain.  
Adjust the gain, then the STEREO master fader, and finally the channel fader. Make sure that the level is enough to make the meter bar move, but not so much that the meter bar is pinned to the right.

**● Adjust the level carefully so that the input level is not distorting.**

When "PRE-EQ" is selected as the INPUT METER POINT (see the illustration at right), the over indication of the meter indicates that distortion is occurring because the input gain is too high. This can be used to check for clipping of the input signal, even though there is no clipping indicator. If this input is too high, turn the gain knob slightly to the left or adjust the output volume of the input source.

- Indicates input level for the input channels (Vertically).

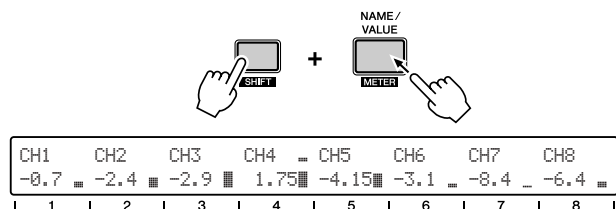

- Indicates input level for the stereo master output.

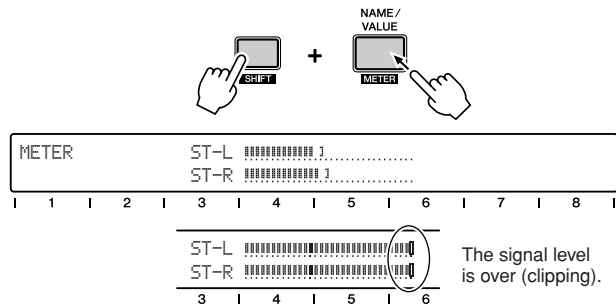

- Indicates input level for the input channels (horizontally).

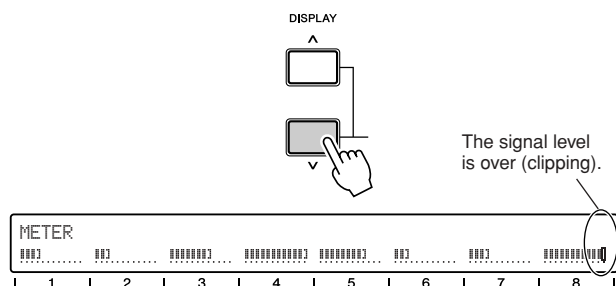

- Selects the Input/Output Meter Point, or pre-EQ (Input meter only), pre-fader or post-fader by using the channel knobs [1] and [4]. To turn the Peak Hold function on or off, use channel knob [7].

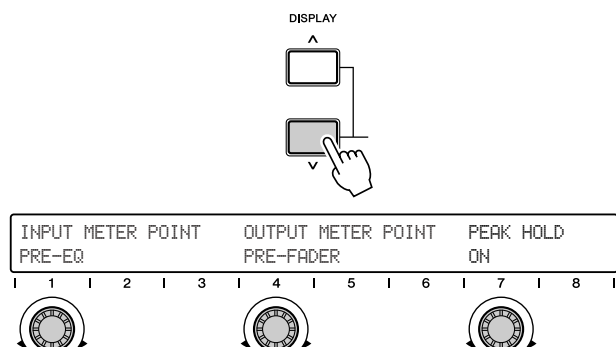

## With Studio Manager

- ① Follow the basic procedure above, or at least the first two steps—setting the controls to minimum and connecting the source(s).
- ② Make sure that the mLAN connection with your computer is active. For instructions on installing the mLAN driver and connecting the 01X to your computer via mLAN, refer to page 22 and the separate Installation Guide.
- ③ Start Studio Manager.



**NOTE**

- To use Studio Manager with the 01X, the mLAN port must be set to 4. (See page 95.)

- ④ Studio Manager automatically detects the connected 01X and after a short pause prompts you to select the type of link (synchronization) for your computer and the 01X.

Click on “Console → PC” here.

- ⑤ Set the levels on the 01X. Follow the same procedure as you did in step 4 in the previous instructions.

You can use the software controls to adjust the level (with the exception of the gain). Notice that the faders on the 01X move when you move the software faders.

## Applying EQ

EQ stands for “equalizer” or “equalization” and lets you change the tonal characteristics of the audio. The 01X is equipped with a four-band sweepable parametric EQ, for maximum versatility and control.

### ● EQ Tips

Keep in mind, EQ has three main uses in recording and mixing:

- **Optimizing the sound for recording** — reducing unwanted noise and hum, compensating for poor frequency response, reducing leakage between instruments, etc.
- **Optimizing the balance in mixdown** — cutting the low frequencies in a keyboard part to have it blend better with a bass part, etc.
- **Applying special effects or enhancements** — such as creating a ‘telephone’ voice, or boosting the bass on a vocal to make it sound richer.

You may need to use EQ to get a good sound in recording. However, remember that some anomalies and deficiencies in the sound can be corrected at the source (e.g., changing microphone placement or microphones, etc.).

Also, it’s tempting to use EQ liberally during mixdown. However, applying a lot of EQ boost may cause distortion—especially if done on several channels at once. Moreover, using too much EQ can make a mix sound muddy or strident.

The moral of this story is: EQ can be overdone, so use it sparingly.

## ■ Operation

- ① Select the desired channel by pressing the corresponding [SEL] button.
- ② Press the desired EQ button: [LOW], [LOW-MID], [HIGH-MID], [HIGH].

This calls up the corresponding EQ parameters. The four EQ bands are set by default to the following central frequencies:

LOW : 125 Hz  
 LOW-MID : 1.0 kHz  
 HIGH-MID : 4.0 kHz  
 HIGH : 10.0 kHz

- ③ Press [SELECTED CHANNEL] to switch between the Single Channel and Multi Channel modes. Which you select depends on your preferences or the application at hand.

The Selected Channel mode lets you see and edit all EQ parameters for the selected channel.



EQ-ON	ATT	EQHM-Q	EQHM-F	EQHM-G	SEL<CH1 >
ON	0.0	0.70	4.00k	0.0	
1	2	3	4	5	6
7	8				

The Multi Channel mode, on the other hand, lets you see and edit one selected parameter for all channels.



EQ HIGH-MID GAIN								
+ 3.0	- 1.1	- 2.1	+ 4.0	+ 2.2	- 0.3	- 1.1	+ 6.2	
1	2	3	4	5	6	7	8	

For instructions on selecting the Display Modes, refer to page 38.

- ④-a From the Selected Channel mode, adjust the desired EQ parameter by turning the corresponding knob.

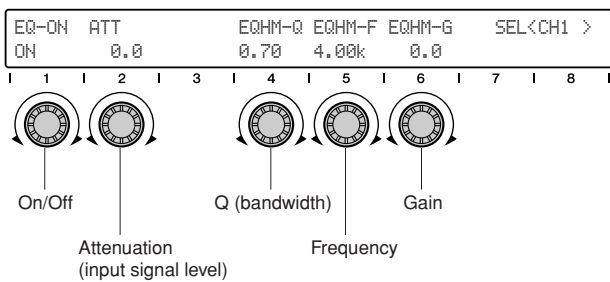

- ④-b From the Multi Channel mode, press the same EQ button (as in step 2 above) repeatedly to select the desired parameter. Adjust the parameter for each channel with the corresponding knob.

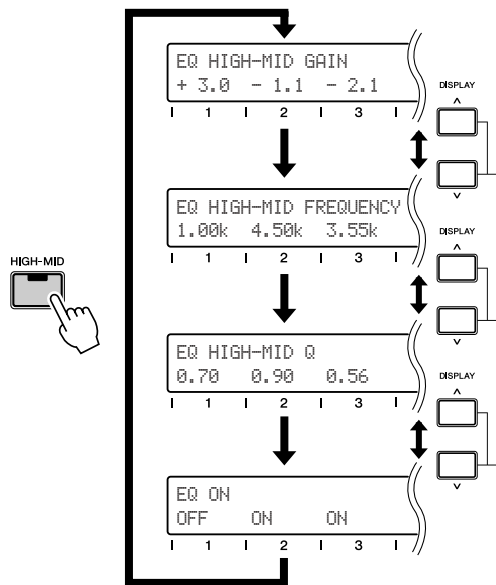

- If the current Display Mode doesn't show the parameter values, you can easily check each by pressing the [NAME/VALUE] button.

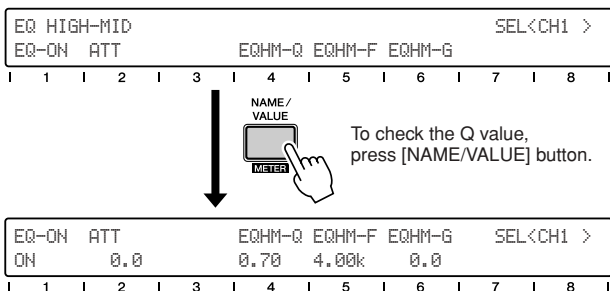

● EQ parameters/ranges

**Gain**

Determines the amount of level boost or cut in the signal at the frequency specified below.

Range: -18.0 — +18

**Frequency**

Determines the central frequency at which the signal is boosted or cut.

Range: 21.2 Hz — 20.0 kHz

**Q**

Determines the bandwidth of the EQ processing. The larger the value, the greater the range of affected frequencies (around the central frequency); the smaller the value, the narrower the frequency range.

Range/Settings: 10.0 (wide) — 0.10 (narrow)  
L.SHL, HPF (LOW band only)  
H.SHL, LPF (HIGH band only)



- For details on the Range/Settings, see pages 96, 117.



- By using the included Studio Manager software, you can view and edit all EQ parameters graphically. (See the Studio Manager PDF manual.)

### ● Hints on using EQ

- In general, cut rather than boost. For example, if you want to make a sound brighter, try cutting the bass first. This will not only emphasize the higher frequencies, overall it will give you a cleaner mix.
- We recommend that you use the HPF on every sound source in your mix, except for kick drum, bass guitar and synth bass. This will take out those bass frequencies you don't need to hear, and give the ones you want to hear more sonic room—and make them sound more crisp and punchy.
- You might also want to do the opposite — put LPF on bass sounds to cut out unnecessary highs. Be careful to use your ears, though. You may rob a great sounding bass of its character by doing this (for example, slap bass or standup acoustic bass).
- Here's an engineering trick you may want to try. If there is some sound in a recorded track that bothers you, such as a buzz or a high-pitched whistle-like noise, you may be able to eliminate it with the careful use of EQ. Set Q to a relatively narrow value (0.80 or less) and boost the Gain at or near the maximum. Then, with the track playing, slowly adjust the Frequency value until the offending sound is heard loud and clear. Now, reduce the Gain until the noise disappears and the track sounds the way you want it.  
  
You can also use this trick— especially with the mid frequencies—to improve any instrument or vocal track that doesn't sound quite right (but you're not sure why).
- Remember that the frequency parameter for all of the EQ bands is FULLY adjustable. This means you can use the 'LOW' EQ band as a second HIGH EQ, or vice versa—or even use all four bands on the high frequencies.

## EQ Library

The four-band EQ gives you comprehensive control over the tonal quality of the sound, yet unless you have a lot of mixing experience, you may be unsure just how and when to use EQ.

This is where the EQ Library comes in handy. It gives you forty different preset EQ settings for a variety of common recording applications. These include specific instruments—even specific drums, such as bass drum and snare—as well as vocal applications and various guitar sounds.

Pick a preset that comes closest to your particular application and see if it works. If it needs tweaking, change the settings until you get the sound you want — you can then save your custom settings to one of the available memory space (see pages 36, 54).

The 01X features a variety of Libraries — Dynamics, Scene, Patch, Channel and Effect — containing custom settings for the mixer. The operations (selecting presets, editing, saving, etc.) are the same for all the Libraries. For details, see page 54.



## Using Mute (On/Off) / Solo

Mute and Solo are two simple yet important functions in monitoring your mixes. When you have guitars, vocals, drums, bass, horns and keyboards coming into the mixer through eight, sixteen or twenty-four channels—it's crucial that you be able to isolate each signal and listen to it, with or without the others.

Mute lets you turn off a channel, allowing you to hear what the rest of the mix sounds like without it. Solo works the opposite way—letting you instantly turn off all channels except the selected one, allowing you to hear that channel all by itself.

Remember that both Mute and Solo can be used with several channels, not just one. (The Solo function depends on the SOLO MODE setting; page 96.) In other words, you can solo two channels, to hear how they sound separate from the mix, and hear how they sound together. Or if you have drums on three different channels, you can mute all three to hear a drum-less mix. Moreover, you can use Mute with the Group feature (page 101) to instantly mute several grouped channels all at the same time.



- If while mixing you cannot hear one or more channels, make sure you haven't inadvertently used Mute or Solo. For a quick visual check, make sure that all channel LEDs are lit and that the [SOLO] button is off.

## Mute

### ■ Operation

- ① Make sure that the [SOLO] button lamp is off. Press [SOLO] if necessary to turn it off.
- ② Press the [ON] button of the desired channel. The lamp turns off, indicating the channel is muted. Continue to mute other channels as desired in the same way.
- ③ To un-mute the channel, press the [ON] button again.

## Solo

### ■ Operation

- ① Press the [SOLO] button. The lamp lights, and the [ON] button lamps all flash.
- ② Press the [ON] button of the desired channel. All other channels are muted (their lamps turn off), except the selected channel. Continue to add other channels to the solo as desired in the same way.



- You can select the Solo Mode (single channel or multiple channel) that suits your purpose or application (page 96).
- ③ To cancel the Solo function for the channel, press the [ON] button again.

## Using Dynamics — applying compression, etc.

The Dynamics effects of the 01X provide useful, powerful ways to process the sound, both during and after recording. They can be used to tame excessively wild sounds or expand and enhance less lively sounds.

### ● About Dynamics and Compression

Of all the aspects of modern music production, compression is one of the least understood. This is mainly because the sonic results are so subtle and hard to distinguish.

Compression is a type of dynamics (loudness) processing, and affects the dynamic range of a signal—in other words, the difference between the softest and loudest sounds of the signal. Other dynamics processors include gates, expanders and limiters.

A compressor “squeezes” the dynamic range of a sound—making the soft parts louder and the loud parts softer. For this reason, it is ideal for smoothing out wild fluctuations in level, such in a vocalist who both whispers and screams in the same song. Once the audio is compressed, the level can be raised, so that the loud parts are as loud as before (or even louder), and the soft parts can be clearly heard (including your vocalist’s breathing).

Since a smoother dynamic range is easier to record, you’ll probably want to apply compression while recording. Don’t overdo it, though. You should only apply compression to the source enough to tame the levels, keeping the sound relatively natural and uncolored. Process it later after it’s recorded, if necessary.

Compression also can be used to change and enhance certain sounds—such as putting a mean attack on a wimpy snare drum, adding crunch, bite and sustain to a mild-mannered electric guitar, or making a soft lead vocal sound urgent and up-close.



- For the most natural, transparent sound, use compression on individual instruments rather than the overall mix. The effects will be less audible.

### ■ Operation

- ① Select the desired channel by pressing the corresponding [SEL] button.
- ② Press the [DYNAMICS] button.
- ③ Press [SELECTED CHANNEL] to switch between the Single Channel and Multi Channel modes.

The Selected Channel mode lets you see and edit all Dynamics parameters for the selected channel.

DYN-ON	THRESH	RATIO	ATTACK	RELEASE	GAIN	KNEE	
OFF	- 8.0	2.5:1	60ms	229ms	0.0	2	
1	2	3	4	5	6	7	8

The Multi Channel mode, on the other hand, is for viewing and changing the on/off status of Dynamics for all channels.

DYNAMICS							
OFF	ON	ON	OFF	OFF	OFF	OFF	
1	2	3	4	5	6	7	8

- ④ From the Selected Channel mode, press the [DYNAMICS] button to select the desired displays. The first contains the Dynamics parameters; the second contains the Dynamics library (page 54).

### ● Example — Compressor

\* Dynamics Parameter page (See pages 118 – 124.)

DYN-ON	THRESH	RATIO	ATTACK	RELEASE	GAIN	KNEE	
OFF	- 8.0	2.5:1	60ms	229ms	0.0	2	
1	2	3	4	5	6	7	8

Threshold      Ratio      Attack      Release      Gain      Knee

\* Dynamics Library page (See pages 100, 118.)

DYNAMICS LIBRARY						SEL<CH1 >	
* 01	[Comp	]	RECALL/STORE	/CLEAR			
1	2	3	4	5	6	7	8

- ⑤ Adjust the desired Dynamics parameter by turning the corresponding knob.

## ● Compressor parameters/ranges

### Threshold

Determines the amount of signal necessary to trigger compression. Any signal softer than this level passes through unprocessed, while signals louder than the Threshold are compressed at the specified Ratio (below).

Range: -54.0 — 0.0

### Ratio

Determines the amount of compression, or the change in output relative to the change in input. A 1:1 ratio represents no compression or normal (unity) gain—output is the same as input. A 2:1 ratio means that for a 10dB change in input level, the output changes only by 5dB. Higher ratios obviously result in greater level “squashing.” For vocals, piano and bass, a range between 2:1 and 6:1 is commonly used. Greater ratios are used on drums and guitars and for special effects.

Range: 1:1 — ∞ :1

### Attack

Determines the amount of time before compression is applied to the signal. The smaller the value, the faster the compression is applied.

Range: 0 — 120 ms

### Release

Determines the amount of time before the compression effect returns to normal (unity) gain.

Range: 5 ms — 42.3 sec

### Gain

Determines the level of the compressed signal. Since compression reduces the overall level, use this to raise the level appropriately.

Range: 0.0 — +18.0

### Knee

Determines how abruptly or smoothly compression is applied. Keep in mind that this is related to yet different from Attack (above). The “Hard” (hard-knee) setting abruptly, while the settings 1 to 5 give smoother, logarithmic increases in processing (soft-knee)—resulting a more natural and less obvious compression.

Range: Hard, 1 — 5



- For details on the Dynamics parameters including other Dynamics types, see pages 121–124.

## ● About Compression settings

Keep in mind that all of these settings interact with one another. This is another one of the reasons compression is widely misunderstood and misapplied.

Attack and Release are particularly interdependent. Fast Attack settings allow you to compress transients and initial peaks in the sound. Different Release times allow you to create sustain effects and make the tails of individual notes louder.

For example, if you want the compressor to do its work and get out of the way quickly, set both fast Attack and Release times. For a guitar solo sound that seems to sustain forever, use a moderate Attack time with a long Release. Note that if Release is too short, you may get an unnatural pumping or “breathing” sound. If it’s too long, the compressor may not return to normal in time to properly “catch” the next high-level signal.

Since compression is a subtle effect, it may take time to learn how to use it properly. Make sure to play with the on/off controls, switching the compression in and out to hear how it changes the sound. Listen especially for how the compressed and uncompressed sounds “sit” in the mix, and use the effect judiciously to get the balance right.

## Dynamics Library

Here is another handy feature of the 01X that puts the real-world experience of professional engineers to work for you. The Dynamics Library contains forty different dynamics processing presets for a variety of common recording applications, such as compressing drums, guitar and vocals. It also includes some expansion presets for enhancing the dynamics of certain types of sound.

Select preset for your specific application or instrument and change the settings if needed. Remember you can save your original settings as a User preset (see page 36).

### ■ Operation

- ① Press [SELECTED CHANNEL] to call up the Single Channel display.  
The button lights.
  - ② Select the desired channel by pressing the corresponding [SEL] button.
  - ③ Press the [DYNAMICS] button twice to call up the Dynamics Library.
  - ④ Select the desired preset with knob 1.  
For a full list of the available Dynamics Library presets, see page 118.
  - ⑤ Press RECALL (knob 5) then YES (knob 8) to call up the selected preset.  
For details on using Recall, as well as Store and Clear in the same menu, see page 100.
- Use the preset as is on the channel or change the settings as desired.



• Make sure to turn DYN (Dynamics) on (with knob 1), otherwise you won't be able to hear any change in the sound.

## Pairing channels

This convenient function lets you link two adjacent channels as a stereo pair—ideal for stereo sources, such as a synthesizer, rhythm machine or CD player. This links the faders and most of the mix parameters for the channels, including EQ, Dynamics, Group assignments and Effects. (Parameters not affected by pairing include Input Patch, Pan and Phase.)

- ① Hold down the [SEL] button of one of the channels and simultaneously press the [SEL] button of the channel next to it.  
Notice that this only works for 'logical' odd/even pairs. For example, channels 3 and 4 are a logical pair, but 4 and 5 are not. As a result, holding down the [SEL] button for channel 4 and pressing that of channel 5 has no effect.



### Stereo sources

- When connecting stereo sources, keep this logical system in mind. Always connect the left signal to an odd-numbered input (1, 3, 5, 7) and its right counterpart to the adjacent even-numbered input (2, 4, 6, 8).

- ② Select the control assignment for the pair by pressing the appropriate knob.

DYN-ON	THRESH	RATIO	ATTACK	RELEAS	GAIN	KNEE
CH1 +CH2	CH1 +CH2	RESET-BOTH	CANCEL			
1	2	3	4	5	6	7
8						

Copies the odd channel parameter values to the even channel.

Copies the even channel parameter values to the odd channel.

Notice that when you move one of the faders, the other moves with it. Also, any mix settings you make for one channel are automatically made for the other channel as well.

### ⚠ CAUTION

#### Don't move both faders!

- Be careful to only move one fader in a channel pair. Moving both at the same time may damage the motors.



### To cancel the pair assignment:

- Simply repeat step 1 above, then at the "RELEASE PAIR?" prompt, press knob 8 (YES).

## Panning

Pan lets you set where the audio of a channel appears in the stereo image. Normally, if you've connected a stereo source to two adjacent channels—for example channels 1 and 2—you'll want to set channel 1 hard left and channel 2 hard right, to preserve the original stereo image. Other channels can be directed left, center or right—or anywhere in between—as desired.

### ■ Operation

- ① Select the desired channel by pressing the corresponding [SEL] button.
- ② Press the [PAN] button.
- ③ Press [SELECTED CHANNEL] to switch between the Single Channel and Multi Channel modes. Which you select depends on your preferences or the application at hand.

The Selected Channel mode lets you see and edit all Pan parameters for the selected channel.

PAN	REC BUS	ST-BUS	PHASE	ON/OFF	LEVEL
CENTER	--	ON	NORMAL	ON	-2.8
1	2	3	4	5	6
7	8				

The Multi Channel mode, on the other hand, lets you see and edit one selected parameter for all channels.

PAN	R03	CENTER	CENTER	L03	L19	R11	R05
1	2	3	4	5	6	7	8

- ④-a From the Selected Channel mode, adjust the desired Pan parameter by turning the corresponding knob.

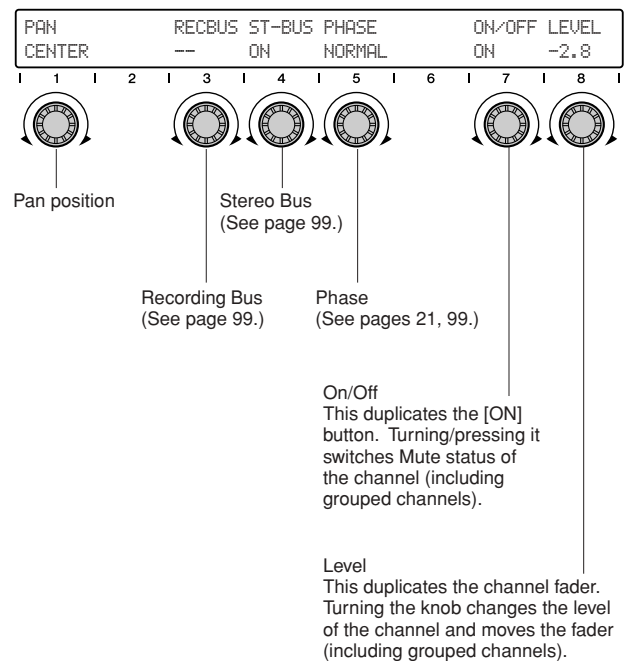

The Recording Bus, Stereo Bus and Phase parameters do not concern us now in Panning. If you're interested, see the page references given.

④-b From the Multi Channel mode, press the [PAN] button, repeatedly if necessary, to select the Pan parameter.

Adjust the parameter for each channel with the corresponding knob.

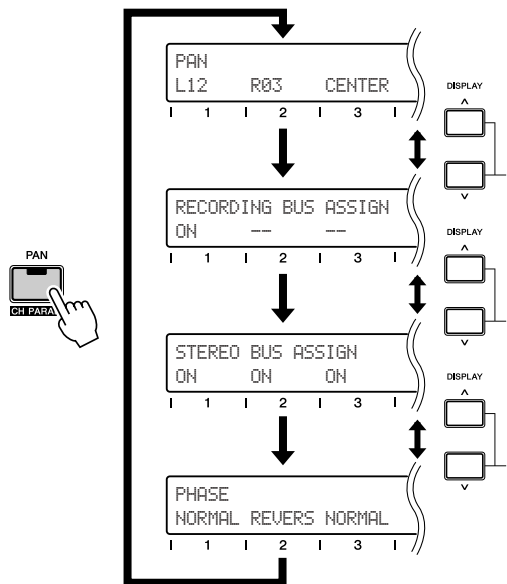

**HINT**

- If the current Display Mode doesn't show the parameter values, you can easily check each by pressing the [NAME/VALUE] button.

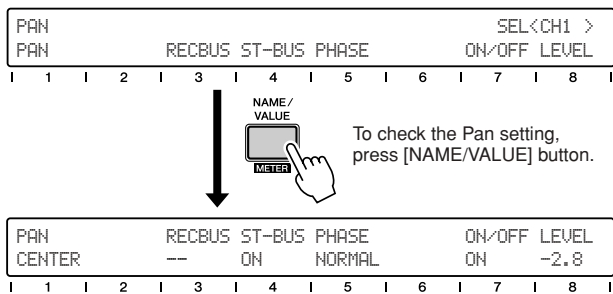

## Using the Internal Effects

With fully digital four-band EQ and Dynamics processors on every input channel, there's an enormous amount of recording and mixing flexibility in this console. The 01X doesn't stop there, however. It also features two independent effect blocks—again fully digital and fully integrated.

Setting up and using the internal effects is essentially a three stage process:

- 1) Set up the effect send routing
- 2) Select the effect type and edit it (if needed)
- 3) Set the master return level and adjust the send level for each channel

Once you've determined what effects to use and how to route them, step 3 is all you need to worry about during a mix session. Applying the effect to a channel is a simple matter of adjusting the channel send control.

In this section, we'll take you through a simple and common example, one you're likely to use in your own mixes—applying a global reverb effect to the individual channels.

## 1) Effect send routing

The 01X features four separate effect send routings: AUX 1, AUX 2, AUX 3 and AUX 4. AUX 1 and 2 are used only for external routing (to your favorite outboard effects, for example). AUX 3 and 4 are used for the two internal effect blocks, and those are the ones we'll cover here.

Here, you'll route Effect 1 to the AUX 3 bus and set an appropriate level for the effect.



- If 88.2kHz/96kHz operation (page 92) is enabled, only one internal effect block is available (Effect 1/Aux 3).

### ■ Operation

- 1 Press the [EFFECT] button.

The button toggles between EFFECT 1 and EFFECT 2. Select EFFECT 1 here (press DISPLAY [^] (Up) button if necessary).

EFFECT1	PATCH	BYPASS	MIX	TYPE	REVERB	HALL	]
	AUX3	--	100%				

- 2 Make sure that Patch is set to AUX 3, Bypass is off (--), and Mix is set to 100%.

These are the default settings for Effect 1 (Effect 2 is set to AUX 4), so you may not need to change them.

EFFECT1	PATCH	BYPASS	MIX	TYPE	REVERB	HALL	]
	AUX3	--	100%				



**Patch**  
This determines where the sound of Effect 1 will be sent in the mix. Although this is normally set to AUX 3, you can also use it as a channel insert effect (directly inserting the effect to a single channel, before the EQ and Dynamics processing), or directly to the stereo buses.

**Mix**  
This determines the amount of the effect in the mix. Generally, this should be set at or near 100%. You can control how much effect each channel has with the channel send level below.

**Bypass**  
Turns the effect sound on or off. (Remember that Bypass ON means the effect sound is off; to hear the effect sound, use the "--" setting.) Use this to listen to the mix with or without the effect.

## 2) Effect type and parameters

The Reverb Hall type is selected by default. There are several other reverb types among the presets; you may want to explore these as well.

### ■ Operation

- 1 Call up the Effect 1 Library page.

From the Effect display pages (press [EFFECT] if necessary), use the DISPLAY [^/∨] (Up/Down) buttons to call up Effect 1 Library.

EFFECT1	LIBRARY	TYPE	REVERB	HALL	]
*	01	[Reverb Hall	]	RECALL/STORE	/CLEAR



#### Using the DISPLAY [^/∨] (Up/Down) buttons

- This is the last page of the Effect 1 pages, and you'll probably have to press the DISPLAY [∨] (Down) button five times to get there. You can also hold down [PAGE SHIFT] and press the DISPLAY [∨] (Down) button to jump through the 'top' pages in each group—in which case, you can get to the Library page in two DISPLAY [∨] (Down) button presses.

- 2 Select the desired effect type.

Use knob 1 to select the type, then press RECALL (knob 5) followed by YES (knob 8) to actually call it up. There are 43 different preset effect types (see the list on page 125). There's also memory space in the Library for 85 of your own custom settings (page 36).



③ Edit the effect if desired.

Press the DISPLAY [^] (Up) button repeatedly to step back through the effect parameter pages—Reverb Hall has four of them. (To jump directly to the ‘top’ page, hold down [PAGE SHIFT] and press the DISPLAY [^] (Up) button.)

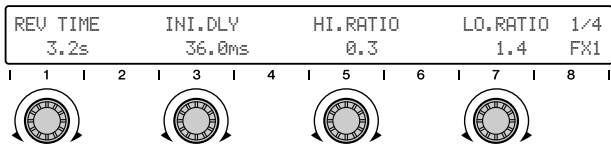

This is the first parameter page for Reverb Hall. Use knobs 1, 3, 5, and 7 to edit the four parameters here.

■ No sound?

Edit away, but keep in mind that you won’t be able to hear any changes to your edits unless one or more of input channels are sent to the effect, and you set the return levels properly (see the section below). For a list of the parameters in each effect type, see page 125.

3) Return and send levels

The final step is actually two-fold:

1. Set the amount of effect signal you want returned to the stereo mix.
2. Adjust the amount of effect you want to apply to each channel.

Once you’ve done that, you may want to go back to the section above and tweak the effect settings or even select a different effect type.

We’ll assume in these instructions that the [SELECTED CHANNEL] button isn’t lit—in other words, you’ll be viewing/editing all channels at once.

■ Operation

- ① Press the [MASTER] button in the MIXER/LAYER section.

This selects the Master mixer (for the stereo master output). The faders may move to reflect the Master settings.

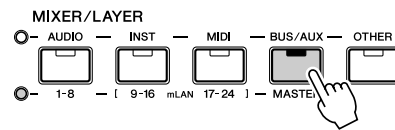

- ② Raise faders 7 (for Effect 1) and 8 (for Effect 2) to around 0 dB.

When the Master mixer is active, these faders control the AUX 3/4 Return level regardless of the currently selected page.

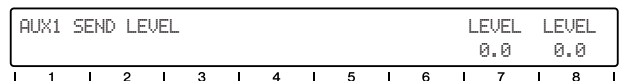

Adjusts the Stereo input 2 level.

Adjusts the Stereo input 1 level.

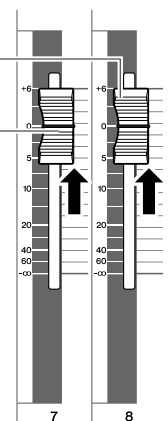

NOTE

- Don’t use knobs 7 or 8 here (AUX SEND 3 or 4) — you may get a howling noise! These control the stereo AUX Send level and could set up an undesired feedback loop.

- ③ Press the [SEND] button (several times, if necessary) to call up the AUX 3 display below.

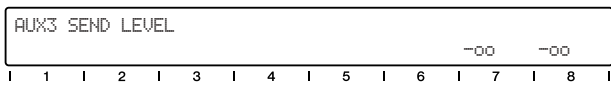

- ④ Go back to the input channels—press the MIXER/LAYER [1-8] button.

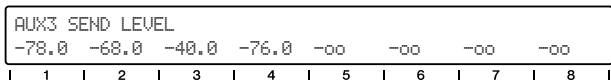
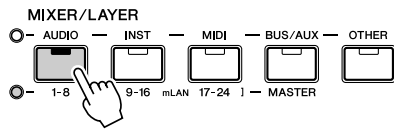

- ⑤ Adjust the send level for the desired channel with the corresponding channel knob.

While you're adjusting this, listen to the change in the sound. If you need to, go back to steps 2 and 3 above and adjust the Return level to an appropriate value.

Remember that you can also select the other channels (mLAN inputs 9 - 16, and 17 - 24) by pressing the appropriate button in the MIXER/LAYER section. (For more about the mLAN inputs, see page 28.)



- For step 5, try pressing the [FLIP] button and using the faders to adjust the send levels instead of the knobs. (See page 19.)



- If you have little experience in mixing and using effects, you should keep in mind that the settings you make in each section above are interrelated—especially the Mix, Aux Return and Channel Send levels. If any of these are set to  $-\infty$ , you may not hear any effect sound.

## Using external effects

With all of the EQ, Dynamics and Effect processing available within the 01X itself, you can do all your recording and mixing without ever having the need for an external effect unit. Still you may have a favorite reverb, delay or other effect device that you'd love to patch into the system. Here's how to do it:

### ■ Operation

① Connect the STEREO/AUX OUT jacks to the inputs on your effect unit (Fig. 1).

If the effect unit has only one input, use just one of the outputs on the 01X, or use a Y-adaptor to sum the stereo signals to mono (Fig. 2).

If your effect device has digital inputs you may want to use these instead (to avoid sound degradation). Connect the DIGITAL STEREO OUT jack on the 01X to the digital input on the device (Fig. 3).

[Fig. 1]

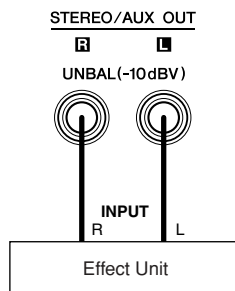

[Fig. 2]

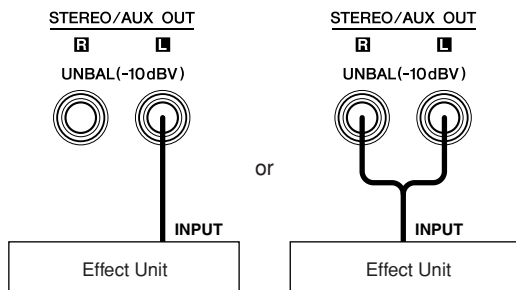

[Fig. 3]

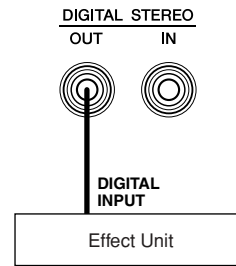

- ② Connect the output(s) of the effect unit to the MIC/LINE input(s) on the 01X.  
  
Again, if you are using a digital effect device, connect the digital output on the device to the DIGITAL STEREO IN jack on the 01X.
- ③ Route the desired channel(s) for applying effects to AUX 1 or 2.  
You should also set the send levels (see page 100).
- ④ Route AUX 1 or 2 to the appropriate output(s)—DIGITAL STEREO or STEREO/AUX in the OUTPUT PATCH page of the UTILITY mode (see page 91).

**NOTE**

• Make sure that the input channels from the effect unit are NOT routed to AUX 1 or 2! Feedback may result.

- ⑤ Set the levels of the input channels.

## Input and Output Patching

With all its ins and outs, the 01X is an exceptionally flexible mixer, adaptable to a wide range of applications and setups. The key to tapping into all that flexibility and power is in the Patch parameters. These let you manage your ins and outs internally, within the 01X, and even let you store your often used routings to the Patch Libraries. Here are some examples to get you started.

### Routing the digital stereo input to two channel inputs

The 01X is an all-digital mixer, with all internal processing done digitally. If you have a digital source you want to record or mix—such as a CD/MD player or DAT deck—it only makes sense to keep it in the digital realm throughout the recording/mixing session.

Naturally, you can apply EQ, Dynamics and effects to the audio, and you can also route it to the digital output (page 91) so that it stays in pristine digital form—even after leaving the 01X.

To do this, you'll need to connect the source and route it to the desired channel inputs.

To digitally connect the 01X to external devices, you must specify the wordclock source for the system. For details, see pages 23 and 92.

As you'll see below, the hardware inputs 1 - 8 are assigned to the same numbered channel inputs by default. Normally, you won't need to change these. However, here we'll set the digital stereo input to feed input channels 3 and 4.

### ■ Operation

- ① Connect the digital source to the DIGITAL STEREO IN jack on the rear panel.  
The digital connectors on the 01X are S/PDIF; make sure the source you are connecting is the same.
- ② Call up the Utility mode by pressing the [UTILITY] button.
- ③ Press knob 2 to call up the Patch parameters.
- ④ Select page 1 or 2 with the DISPLAY [ $\wedge$ / $\vee$ ] (Up/Down) buttons.  
Page 1 contains Input Patch settings for channel inputs 1 - 4, while page 2 contains inputs 5 - 8.

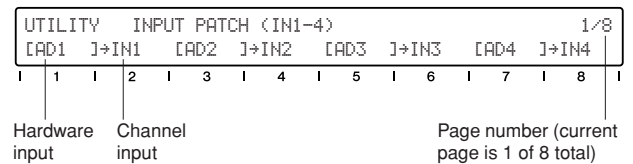

- ⑤ Use the odd numbered knobs to change the input routing for the corresponding channels.  
If you want to have the digital stereo signal routed to channels 3 and 4, select page 1 and use knob 5 to select “DIN-L” (digital in left) and knob 7 to select “DIN-R” (digital in right).

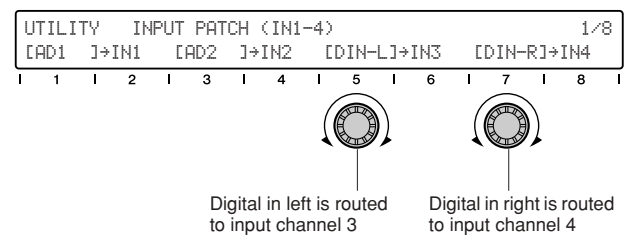

If you intend to use this routing frequently (or even just occasionally), you should save it to the Input Patch Library so that you can call it up whenever you need it. (See page 89.)

## Routing audio to the digital stereo output

In the section above you learned how to route digital audio into the 01X.

In this section, we'll see how to send it back out again.

One common routing would be to send the entire stereo mix to the digital output for recording. Another would be to use the digital output as an aux stereo send for external effects.

### ■ Operation

- ① Connect the digital source to the DIGITAL STEREO OUT jack on the rear panel.  
If you are using the digital output as an aux send, make sure your external effect processor has an appropriate digital input. If you are recording the stereo mix, use the digital input on your recorder (DAT deck, etc.). As above, the 01X connectors are S/PDIF; make sure the device you are connecting has the same.

- ② Call up the Utility mode by pressing the [UTILITY] button.
- ③ Press knob 2 to call up the Patch parameters.
- ④ Select page 6 with the DISPLAY [^/∨] (Up/Down) buttons.  
Page 6 contains Output Patch settings for the DIGITAL STEREO OUT and STEREO/AUX OUT jacks.

UTILITY	OUTPUT PATCH	(DIGI. ST/AUX OUT PORT)	6/8
[ST-BUS]→D.OUT	[ST-BUS]→ST/AUX OUT		

1 | 2 | 3 | 4 | 5 | 6 | 7 | 8 |

DIGITAL STEREO OUT      STEREO/AUX OUT      Page number (current page is 6 of 8 total)

- ⑤ Use knob 1 to change the assignment to the DIGITAL STEREO OUT jack.  
If you want to use the digital output as an aux send, set this to "AUX1/2."

UTILITY	OUTPUT PATCH	(DIGI. ST/AUX OUT PORT)	6/8
[AUX1/2]→D.OUT	[ST-BUS]→ST/AUX OUT		

1 | 2 | 3 | 4 | 5 | 6 | 7 | 8 |



Using the Aux 1/2 sends for external effects lets you retain the Aux 3/4 sends for the internal effects. You'll also need to make other settings, such as routing the external effect signal back into the 01X (page 88). For more details on using external effects, see page 60.

If you want to send the stereo mix to the digital output for recording, set this to "RECBUS."

UTILITY	OUTPUT PATCH	(DIGI. ST/AUX OUT PORT)	6/8
[RECBUS]→D.OUT	[ST-BUS]→ST/AUX OUT		

1 | 2 | 3 | 4 | 5 | 6 | 7 | 8 |



Make sure to save your important Patch setups to the Output Patch Library so that you can call them up in the future. (See page 91.)

## Routing audio to specific mLAN outputs

You can use the following operation to send audio buses to specific mLAN output pairs. For example, you can direct the two Aux Out pairs (AUX 1/2, AUX 3/4) to separate mLAN outputs. You can route the stereo bus and the record bus (REC Bus) to independent mLAN outputs from this page as well. Keep in mind, this all happens digitally over the high-speed IEEE 1394 (Firewire/i.Link) connection, letting you directly feed digital audio to an mLAN-equipped device. For more information about mLAN and related applications, see page 22 and the separate Installation Guide.

### ■ Operation

- ① Make sure your computer (mLAN device) is properly connected to the 01X and configured for operation. For details on using mLAN, see page 66 and the separate Installation Guide.
- ② Call up the Utility mode by pressing the [UTILITY] button.
- ③ Press knob 2 to call up the Patch parameters.
- ④ Select page 5 with the DISPLAY [^/∨] (Up/Down) buttons. Page 5 contains four Output Patch sources: Stereo Bus, Recording Bus, Aux Bus 1/2, and Aux Bus 3/4.

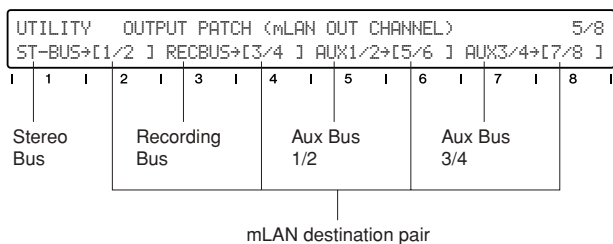

- ⑤ Use the even numbered knobs to change the mLAN output channel pair for each audio bus. For example, to send the Aux 1/2 signals to mLAN channels 9 and 10, turn knob 6 until “9/10” is selected for the Aux 1/2 setting.

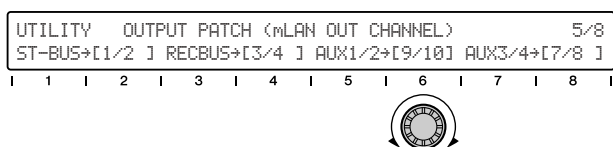

If desired, save this setting also to the Output Patch Library for future recall. (See page 91.)

## Storing your custom patch setups

Once you create a Patch setup, you’ll probably want to save it for future use. That’s what the Input and Output Patch Libraries are for. They let you store your custom Input and Output settings, so that the next time you have a same or similar recording situation, you can appropriately reconfigure the entire console with just a few button presses.

### ■ Operation

- ① Call up the Utility mode by pressing the [UTILITY] button.
- ② Press knob 2 to call up the Patch parameters.
- ③ Use the DISPLAY [^/∨] (Up/Down) buttons to select the Library page. The Input Patch Library is on Page 4, while the Output Patch Library is on Page 8.

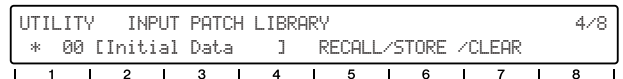

- ④ Use knob 1 to select the desired Library preset number.
- ⑤ Press STORE (knob 6) followed by YES (knob 8) to save the settings to the selected number.
- ⑥ Name your new Library preset. For details on naming, see page 41.

## Groups

You can use the Group features to make mixdown chores easier. For example, if you assign all of your drum channels to the same Fader Group, you can adjust the levels of all the drums together just by moving one of the faders. What's more, the relative balance of all channels is preserved—even when fading out!

Channels can also be put in Mute Groups, letting you instantly turn all assigned channels on/off. And remember that Fader Groups and Mute Groups are completely independent—any channel can be assigned to either or both.

## Fader Groups

Channels assigned to the same fader Group can all be changed together simultaneously, simply by adjusting the fader of one of the assigned channels.

### ■ Operation

- 1 Press the [GROUP] button, repeatedly if necessary, to call up the Group Enable display.

```
GROUP ENABLE    FADER<A-D>/MUTE<E-H>
A-ENA B-ENA C-ENA D-ENA E-ENA F-ENA G-ENA H-ENA
| 1 | 2 | 3 | 4 | 5 | 6 | 7 | 8 |
```

- 2 Make sure that the Groups you intend to assign are all enabled.  
The four fader Groups are labeled A, B, C and D. If necessary, use the corresponding knobs (1 - 4) to set the desired Groups to “ENA” (enable).

- 3 Press the [GROUP] button again (twice) to call up the Fader Group display.

```
FADER GROUP
GRP-A GRP-A GRP-B GRP-B GRP-C ---- GRP-C ----
| 1 | 2 | 3 | 4 | 5 | 6 | 7 | 8 |
```

- 4 Assign each channel to the desired Group (A - D) by using the corresponding channel knob.  
If the channel is one of a pair, the setting will automatically be made for both channels.



• The Pair setting (described on page 54) can also be set from the CHANNEL PAIR display in the Group pages here. (For details, see page 102.)

## Mute Groups

Channels assigned to the same Mute Group can all be turned on and off together simultaneously, simply by pressing the [ON] button of one of the assigned channels.

### ■ Operation

- 1 Press the [GROUP] button, repeatedly if necessary, to call up the Group Enable display.

```
GROUP ENABLE    FADER<A-D>/MUTE<E-H>
A-ENA B-ENA C-ENA D-ENA E-ENA F-ENA G-ENA H-ENA
| 1 | 2 | 3 | 4 | 5 | 6 | 7 | 8 |
```

- 2 Make sure that the Groups you intend to assign are all enabled.  
The four Mute Groups are labeled E, F, G and H. If necessary, use the corresponding knobs (5 - 8) to set the desired Groups to “ENA” (enable).

- 3 Press the [GROUP] button repeatedly to call up the Mute Group display.

```
FADER GROUP
GRP-A GRP-A GRP-B GRP-B GRP-C ---- GRP-C ----
| 1 | 2 | 3 | 4 | 5 | 6 | 7 | 8 |
```

- 4 Assign each channel to the desired Group (E - H) by using the corresponding channel knob.  
If the channel is one of a pair, the setting will automatically be made for both channels.



- The Group function can be a handy arranging tool or even a composition technique—particularly with looped-based music or long repeating sections. Assign similar tracks to the same groups, and make sure one of each group is represented on the current set of channels (ex., 1 - 8). Then work the four ‘master’ faders and [ON] buttons while the music is playing, and create an arrangement in real time.
- Four is a good number for surround. Use Groups to create and preview a surround sound mix. Assign the four groups separately to your front stereo pair, rear stereo pair, center channel, and subwoofer signals.



## Creating and Recalling Scenes

Scenes are digital “snapshots” of your mixing work. They allow you to save all settings in a mix—including EQ, Dynamics, Effects, Groups, and more—and call them up instantly whenever you need them. There are 99 Scene memory locations for your custom mixes, and if you need more, you can save them to your computer by using the Studio Manager. (See page 9 and Studio Manager PDF manual.)

Scenes are a great way to avoid ‘reinventing the wheel.’ Once you’ve got a perfect mix of a certain set of instruments for a certain type of music—ideal compression and EQ for bass and drums, delay and reverb just right on the vocals—save it! The next time you do a song in the same style with the same instruments, simply call up your template and you’re ready to go. You can also use Scenes to create alternate mixes of the same song, listening back to each in turn and choosing the best one.



**Make your life easier—coordinate the Scenes with your sequencer songs. Here are some tips to get you started.**

- Make sequencer templates for often-used song styles and instrument combinations and create Scenes to match these templates.
- Use MIDI to control the 01X. If you make mixing changes within a song, you can record program change messages in your sequencer tracks and have each Scene change called up automatically as the song plays. (See pages 87, 94.)

### ■ Operation

- ① Make all the desired mixer settings.

Virtually every setting you make on the mixer can be stored to a Scene. This includes the channel [ON] buttons, the level settings (including the fader positions), EQ, Pan, Aux Send levels, Dynamics, Effects, Group Fader and Mute assignments, Input/Output Patch settings and channel pairs. (For a detailed list of Scene data, see page 85.)

#### **⚠ CAUTION**

- Remember that Scene data does not include the GAIN knob settings. If you’ve made any changes to these, you will have to reset them manually. For this reason, it may be a good idea to keep notes on those settings—for example, writing them down as clock settings to indicate the dial position (10:00, 12:00, 2:00, etc.).

- ② Press the [SCENE] button to call up the Scene Library.

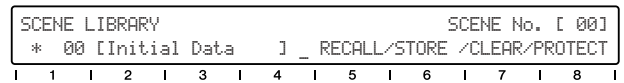

- ③ Select the desired Scene number: 01 - 99. Scene 00 is reserved for resetting the entire console to the default settings, and cannot be overwritten.



- If an asterisk (\*) is shown to the left of the Scene number, write-protect is enabled and the data cannot be stored to that number. Select a different number, or disable the write-protect by pressing PROTECT (knob 8).

- ④ Press STORE (knob 6) to store your settings to the selected Scene number.

- ⑤ Name the Scene.

You can give a descriptive, unique name to the Scene, of up to sixteen characters in length. (For instructions on naming, see page 41.)

#### **⚠ CAUTION**

- When recalling Scenes, keep in mind that volume levels may change suddenly as channels are turned on and faders moved. Unless you know exactly what changes are coming, it’s best to turn down the MONITOR OUT control and any connected amplifier/speaker system—to avoid damage to your ears and your equipment!

## Recording/Playback/Remote Control

You've seen how the 01X is a full-featured stand-alone mixer and an exceptionally versatile front-end mixer for recording and mixdown with a computer system. In this section, you'll discover that it's also a convenient, comprehensive control surface for your audio sequencer or DAW (digital audio workstation).

The 01X gives you tape recorder style transport controls, a wealth of buttons for navigating and controlling your song, and most importantly, lets you use the faders, knobs and channel buttons ([SEL] buttons and [ON] buttons) for mixing your sequencer tracks in real time. Full automation — with moving faders — is implemented, and you can even change and automate EQ and effect settings for each track. In short, the 01X provides a completely transparent hardware link with your computer-based music production.

Templates are included for most major DAW applications and MIDI/audio sequencers, including Cubase SX/SL, Nuendo, Logic, SONAR, and Digital Performer. Naturally, the Yamaha SQ01 V2 is supported as well.

Throughout this section, we've used Cubase SX for the examples, but most or all of these control features are available for the other supported sequencers as well. If you're familiar with the concepts and basic functions covered here, and are aware how they apply to your own particular sequencer, you should have no problem learning from these instructions, no matter what sequencer you use.

### NOTE

- Keep in mind that not all control features are implemented on all of the compatible software programs. For example, the Scrub function is not available for Cubase SX/SL, but it can be used with Logic, SONAR, and Digital Performer.
- Remote control is only possible when the version of your particular DAW application and operating system matches the system requirements. For details, see the separate Installation Guide.
- The latest information can be found at the website below.  
<http://www.yamahasynth.com>

## Setting up

Open or record a song in Cubase SX, and as you read through this section, try out the controls with the song. (Ideally, the song should have several tracks of audio and/or MIDI data.)

### Install the mLAN driver and connect your computer to the 01X

For details on setting up your computer and DAW application for use with the 01X, see the separate Installation Guide.

Here, we'll show you how to set up Cubase SX for mLAN connection with the 01X.

### • Remote control setup

Before you can use the 01X with Cubase SX, you'll need to specify the particular hardware control set that Cubase recognizes.

- ① From the Devices menu, select "Device Setup..."
- ② Click on the Add/Remove tab.

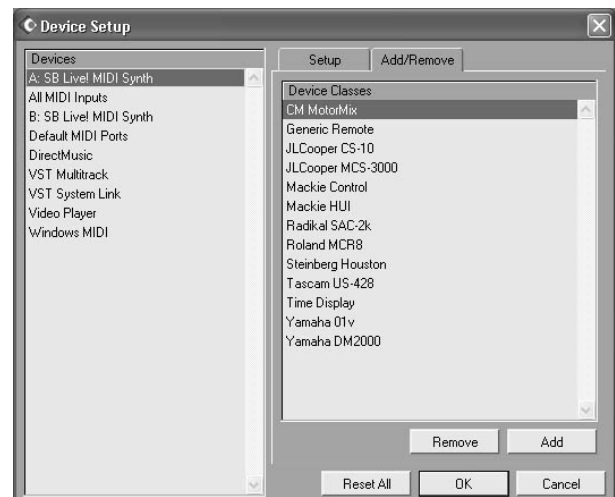

- ③ Select “Mackie Control” (or “Yamaha 01X”) from the list and click Add.

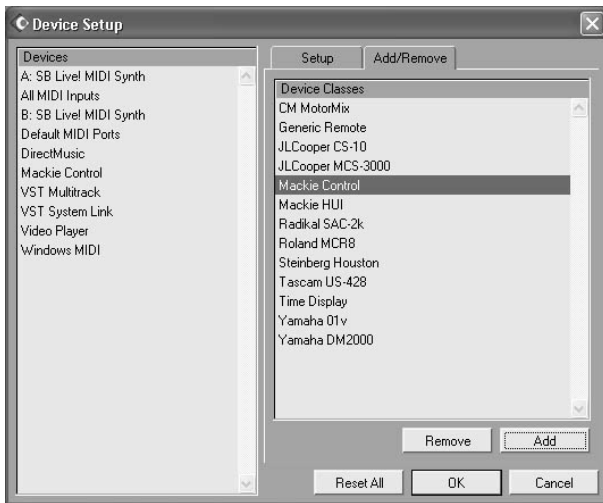

- ④ Select “Mackie Control” from the “Devices” list, then click on the setup tab.
- ⑤ Set the MIDI Input and Output ports. Select the unnumbered mLAN MIDI port; this corresponds to Port 1 for the remote control functions.
- ⑥ Click OK to finish.

**NOTE**

- For details on which mLAN MIDI port numbers are available for the 01X, see page 95.

### • MIDI and audio setup

Since mLAN serves not only as a control surface for Cubase SX but also as a MIDI and audio interface, you’ll need to make the appropriate MIDI and audio settings in Cubase SX.

#### MIDI setup

- ① From the Devices menu, select “Device Setup...”
- ② Select “Default MIDI Ports” from the list.
- ③ Click on the Setup tab (if necessary).
- ④ Set the MIDI Input and Output ports.

Click on the arrow to call up the pop-up menu. If you wish to use the 01X as a MIDI interface as well, using the separate MIDI A or B terminal on the rear panel, set these to mLAN MIDI Port 2 or 3. You can also select a USB MIDI port here, depending on your computer and the particular USB device you are using.

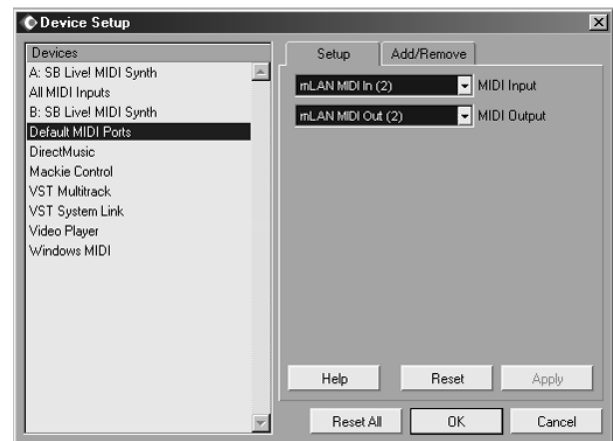

**NOTE**

- For details on which mLAN MIDI port numbers are available for the 01X, see page 95.

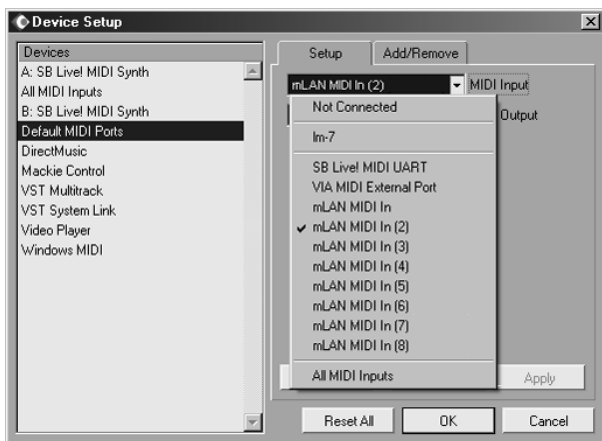

**NOTE**

- Do not select the unnumbered mLAN MIDI port; this corresponds to Port 1 and is reserved for the remote control functions.

- 5 Select “All MIDI Inputs” from the list at left.
- 6 From the Setup tab, disable mLAN MIDI In Ports 1 and 4 - 8.

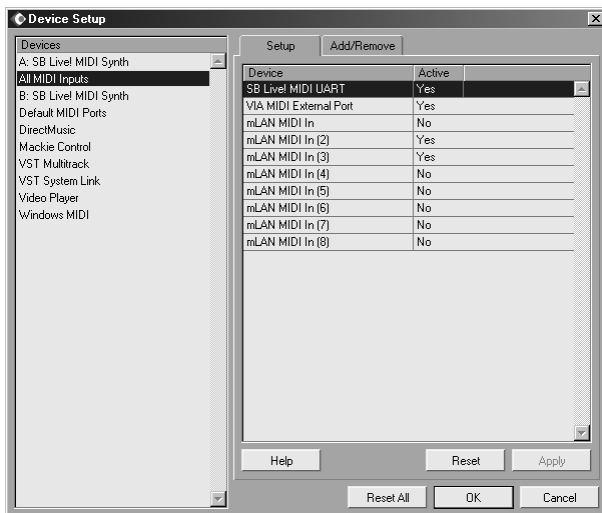

Port 1 is the unnumbered selection. Make sure the settings correspond to the example above. Ports 2 and 3 should remain active (“Yes”), while Ports 1 and 4 - 8 should be inactive (“No”).

- 7 Click OK to finish.

**Audio setup**

- 1 From the Devices menu, select “Device Setup...”
- 2 Select “VST Multitrack” from the list.

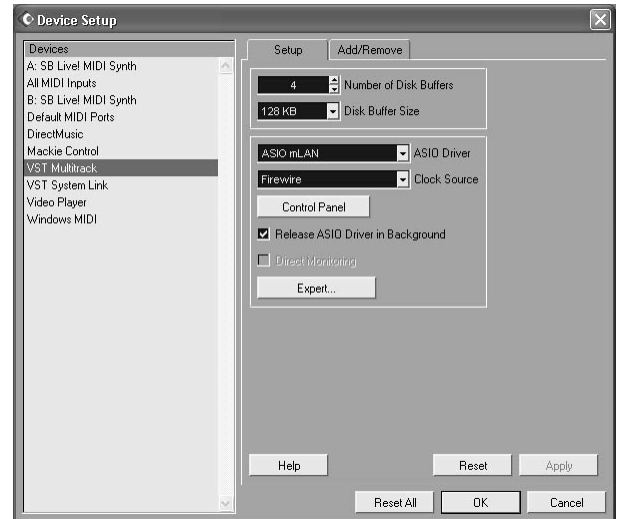

- 3 Click on the Setup tab (if necessary).
- 4 Specify the ASIO Driver. Click on the arrow to call up the pop-up menu. Select “ASIO mLAN” from the list.

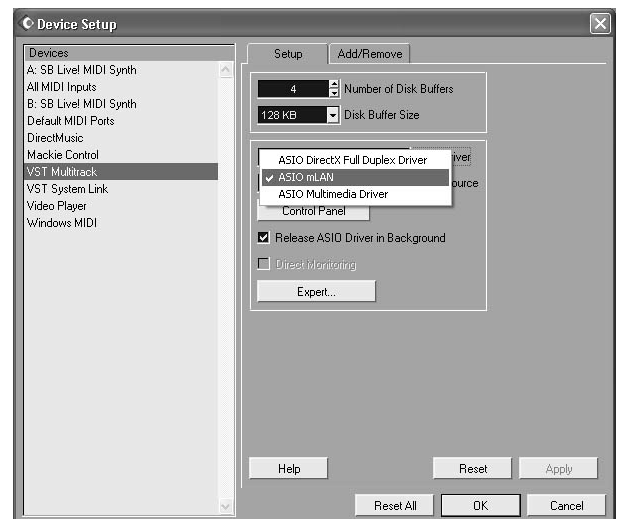

- ⑤ If desired, click the Control Panel button and adjust the latency (Preferred Buffer Size).  
For details on setting the latency, refer to the separate Installation Guide.
- ⑥ Click OK to finish.

## ASIO Driver Setup

- ① From the Devices menu, select “VST Inputs.”

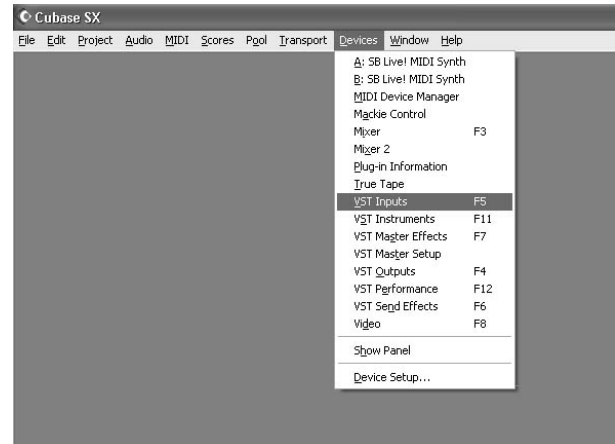

- ② Activate all the inputs you intend to use.  
Click on the [power] button to activate a desired input. Up to 24 inputs (refer to the mLAN Auto Connector explanation of the separate Installation Guide) can be activated simultaneously.

### NOTE

- The channel numbers that are actually in effect mirror the settings of mLAN Auto Connector (see the separate Installation Guide).

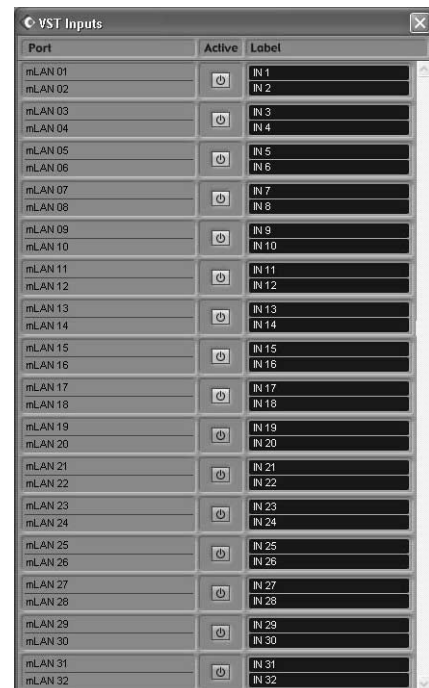

### NOTE

- When the 01X is set to 96kHz/88.2kHz operation, mLAN output (from 01X to the computer) is limited to 16 channels. In this case, the maximum number of input channels that can be activated is 16.

- ③ From the Devices menu, select “VST Outputs.”
- ④ Activate all the outputs buses you intend to use. Click on the [power] button to activate a desired bus. (Bus 1 is on by default and doesn’t have such a button.) Up to nine buses can be activated. In these instructions, we’ll use the simplest routing system—only using Bus 1—so leave all the other buses off. (For instructions on how to use multiple buses and multiple mLAN channels, see the box below.)

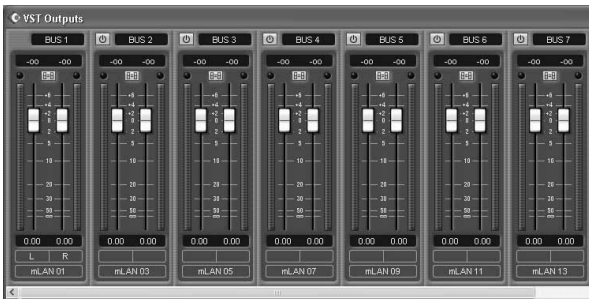

- ⑤ From the Devices menu, select “Mixer.”
- ⑥ Make sure all audio tracks are set to Bus 1. (This does not apply to MIDI tracks.) First, make sure the tracks are set to full width. Click on the leftmost down arrow and select “Wide” from the pop-up menu.

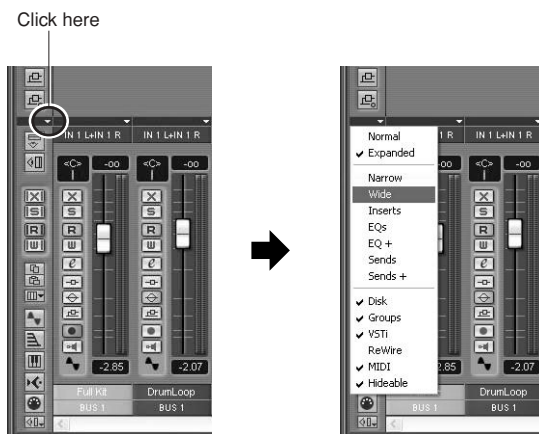

If any track is not set to Bus 1, click the [Bus] box at the bottom of the channel strip, and select Bus 1 from the pop-up menu.

- ⑦ Click the Show Master button (shown below) to display the stereo master output channel strip.



- ⑧ Set the master outputs to the last two available channels (the last two numbered channels specified with mLAN Auto Connector; refer to the separate Installation guide). For example, when you’ve specified sixteen channels with mLAN Auto Connector, at the bottom of the fader and select “mLAN 15.”

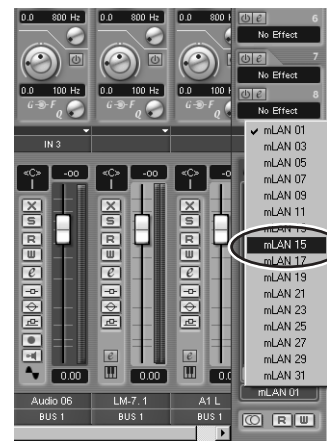

In this setup, all tracks are set to Bus 1 (the default) and Bus 1 is routed to the mLAN master outputs.

**NOTE**

- It is possible to monitor without decreasing the number of input channels (faders) by using the monitor input function of 01X (direct monitor).
- When you are using WDM and ASIO simultaneously, refer to Mode (page 12) in the separate Installation Guide.

- ⑨ On the 01X, press the [MONITOR A/B] button so that the lamp lights. This enables monitoring of the master outputs from the DAW/computer. Keep in mind that this monitor setting can be changed (page 96). The instructions here apply when the default setting is used.



### ● Using multiple mLAN channels

In the instructions above, all tracks were routed to a single mLAN output pair. Here, we'll see how to assign audio tracks to different buses (and hence, separate mLAN output pairs).

- 1 From the Devices menu, select "VST Outputs."
- 2 Activate all the the output buses you intend to use. Click on the "power" button to activate a desired bus. (Bus 1, the master bus, is on by default and doesn't have such a button.) Up to nine buses can be activated.

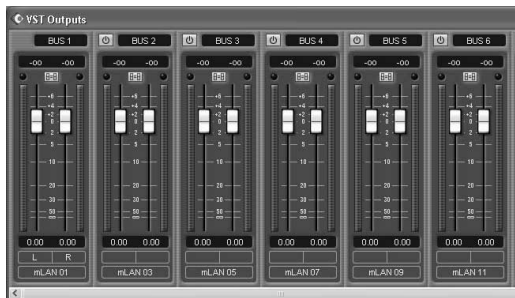

- 3 From the Devices menu, select "Mixer."
- 4 Make the desired track/bus assignments. Click the [Bus] box at the bottom of the channel strip of the audio track, and select the desired bus from the pop-up menu.

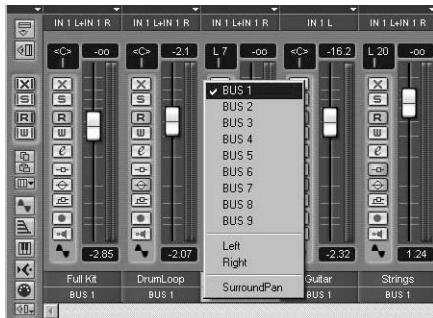

- 5 Set the 01X to Internal operation by pressing the [INTERNAL] button (the lamp lights).

- 6 Enable Monitor B. (Press the [MONITOR A/B] button so that the lamp is off.)

This enables monitoring of the individual mLAN outputs from the DAW/computer. It also enables you to independently mix and process the individual DAW audio tracks from the 01X.

Keep in mind that this monitor setting can be changed (page 96). The instructions here apply when the default setting is used.

- 7 Use the MIXER/LAYER buttons on the 01X to select the appropriate mLAN output group. Press the [INST] (9-16; mL1-8) button to select mLAN channels 9 - 16, and press [MIDI] (17-24; mL9-16) button to select mLAN channels 17 - 24.



- 8 Use the appropriate faders to set the levels. The mLAN outputs from the DAW/computer are now routed to the input channels of the 01X (channels 9 - 24), and can be processed and mixed along with channels 1 - 8.

#### NOTE

- When inputting stereo signals, use odd/even input channels in stereo pair configuration (for example, 9 and 10). (See page 102.)



## ● Recording audio

In this section, you'll learn how to record an audio input signal from the 01X to the computer.

- 1 Connect the instrument or microphone to the 01X and set the level(s).  
Make sure the 01X is set to Internal mode (press the [INTERNAL] button so that it lights). Also, set the [MONITOR A/B] switch to monitor the 01X sound. (In the default condition, the button lamp should be off.) For details on setting up the 01X for recording, see page 68.
- 2 In Cubase SX, enable the inputs you intend to use. From the Devices menu, select "VST Inputs," and click on the "power" buttons for the appropriate inputs. Refer to the section "Setting input levels and viewing the meters" on page 46, for details on setting the input level to avoid distortion.

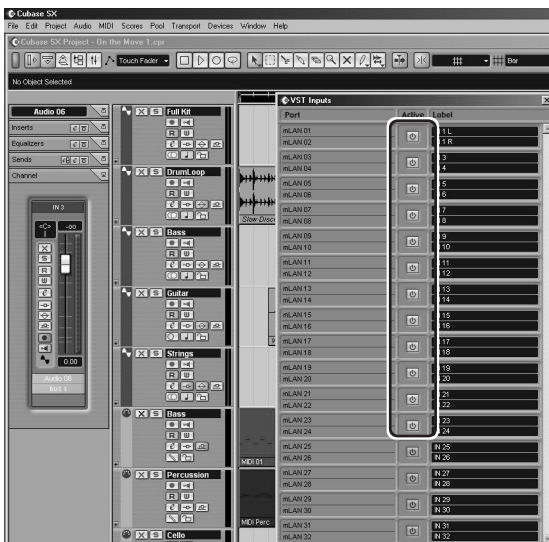

- 3 Set up Cubase SX for recording an audio track.  
Use an existing audio track in the song or create a new audio track if necessary.
- 4 Enable the desired input for the track.  
Click on the Input box at the top of the channel fader and select the desired channel from the pop-up menu.

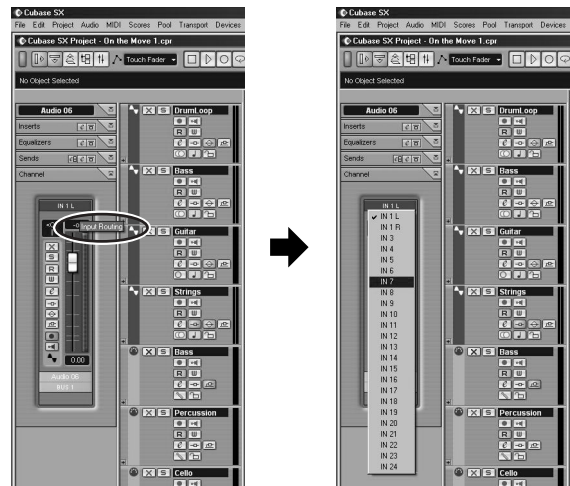

Also, set the desired output bus. If you are using the same output scheme as the simple one described on page 69, set this (or keep it set) to Bus 1.

- 5 For optimum ease in monitoring the input signal during recording and playback, set the Internal/DAW Monitor balance on the 01X to equal (63/63).

To do this, simultaneously hold down the [MONITOR A/B] and press knob 5. (This sets the MONITOR A setting.) Then during recording and playback, press the [MONITOR A/B] button so that MONITOR A is active (the lamp lights).

- 6 Select the track to be recorded and record as usual from Cubase SX.  
After recording, play back the song/track. If you've made the proper setting in step #5 above, you should be able to hear the new track without having to change the Monitor setting for the track.

## Select the Remote setting to match your sequencer

- ① Make sure your computer is on and the mLAN driver is active.  
Refer to the explanation in the separate Installation Guide.
- ② Press the [UTILITY] button.
- ③ Press knob 1 to select the REMOTE SELECT page.
- ④ Select the appropriate sequencer.  
Since we'll be using Cubase SX throughout these examples, press knob 3 (CUBASE/NUENDO). If you are using another sequencer, press the appropriate knob.
- ⑤ Press knob 8 (YES) to actually change the setting.

## Enable the Remote mode and start up your sequencer

- ① Enable the Remote mode.  
Press the [REMOTE] button. The 01X is set to standby.

```
REMOTE MODE <CUBASE/NUENDO>
```

```
1 | 2 | 3 | 4 | 5 | 6 | 7 | 8 |
```

For details on how to start up each DAW application for Remote Control, see the separate Installation Guide.

- ② Start your sequencer program.  
Once your sequencer is up and running and a song has been loaded, the 01X reads the data of the song (track names, level/pan settings, etc.) and reconfigures the entire mixer accordingly. This means that the faders may move into position and the track names (up to six characters) appear in the display.

```
Pan          Pan Left-Right      Page:01/02
FullKi DrumLo Bass Guitar String Bass Percus Cello
```

```
1 | 2 | 3 | 4 | 5 | 6 | 7 | 8 |
```

## Working in the Project window

In Cubase SX, make sure the Project window is on top. This is the main working area in the sequencer and shows all tracks from top to bottom. You can call this up from the 01X by holding [SHIFT] and pressing [TRACK (F1)].



Notice that the names of the first eight tracks appear in the display.

```
Pan          Pan Left-Right      Page:01/02
FullKi DrumLo Bass Guitar String Bass Percus Cello
```

```
1 | 2 | 3 | 4 | 5 | 6 | 7 | 8 |
```

If there are more than eight tracks in your song, use the BANK [◀▶] (Left/Right) buttons to call up and display the other tracks (in banks of eight).

## Using the transport controls

These buttons let you control Cubase in the same way as using a tape recorder.

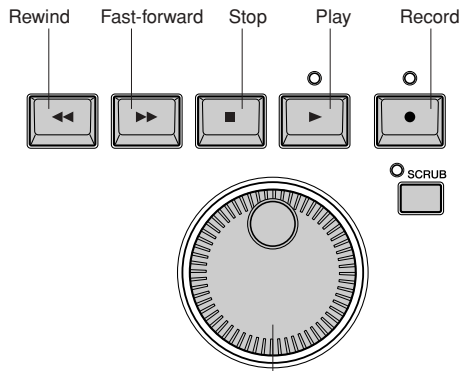

**Dial**  
This is like a jog/shuttle wheel on a video deck, and gives you an even faster way to move the song position in the window.

No matter what window is active, you can use these to control song playback/recording and navigate through the song. Also keep in mind that all of your computer shortcut keys are active if you want to use them—even while using the 01X as a remote control.

## Using markers

Hold down [MARKER] and use the [◀◀] (rewind)/[▶▶] (fast-forward) buttons. If you've set up markers in the song, these can be used to jump among the marker points.

### ● Previous marker

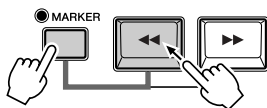

### ● Next marker

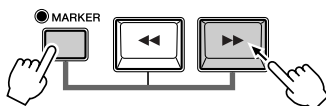

## Programming markers

If you haven't set up a marker or want to program a new one, you can do this from the 01X, too. Move to the desired song position, then press the [WRITE] button. A new marker is set for the current position.

## Cycle playback

In Cubase SX, you can loop playback between the left and right locators. To turn this on/off, press the [LOOP] button.

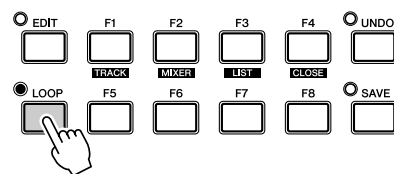

## Selecting and arming tracks

There are two ways (below) to select a track remotely. Notice that selecting a track also automatically arms (enables) it for recording.

### ● Use the [^/∨] (Up/Down) cursor buttons.

Press these to select the previous or next track in the Project window. (Note that the track is highlighted in Cubase SX, and the corresponding channel [SEL] button on the 01X lights.) These buttons serve the same function as the up/down keys on your computer keyboard.

### ● Press the [SEL] button of the appropriate track.

Use the BANK [◀/▶] (Left/Right) buttons if necessary to select the desired 'bank' of eight tracks, then press the appropriate [SEL] button.

## Zoom

The Zoom controls are another navigation convenience. No longer do you have to mouse with the zoom sliders or the magnifying glass tool or use the Zoom submenu in the sequencer. You'll soon appreciate how easy it is to navigate through your song and change the views of your song data — right from the O1X.

In the Project window for example, you may want to zoom out vertically and see more tracks at a time. Or you may want to zoom in horizontally and see more detail in a few number of measures. Zooming in and out can also help you in the Sample Editor, letting you examine details in the wave or seeing the 'entire picture' as needed.

- 1 To use Zoom, simultaneously hold down the [ZOOM] button and press one of the cursor buttons to zoom in and out, vertically or horizontally, as desired.

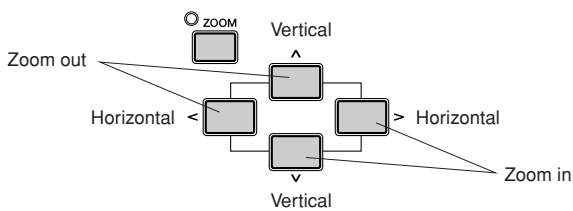

- 2 Zoom can be used in the main Project view, or in any of the editors.

## Working in the Mixer window

### Mixer control — using the faders and knobs

- 1 Hold down [SHIFT] and press the [MIXER (F2)] button to call up the Mixer window.

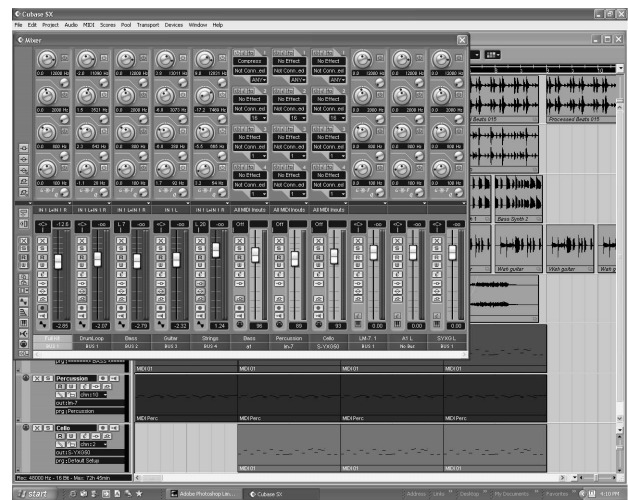

- 2 While the song is playing, move one of the faders. Notice that the corresponding channel fader in Cubase SX moves as well.

#### NOTE

- The response of the fader in the display is immediate, but you might hear a delay between a fader move and the resulting change in sound. For details on optimizing your system and minimizing latency, refer to the documentation of your sequencer.

- 3 Turn the knob on the channel to adjust the pan setting.

#### HINT

##### Flip

- Even though the knob is an intuitive, natural control for adjusting pan, you may want to use the fader instead. To do this, press the [FLIP] button (the LED lights). This "flips" the assignment of the faders and the knobs — letting you control pan with the faders and volume with the knobs. The Flip feature works in any parameter page that has both fader and knob controls.

## Using Mute/Solo

First make sure the [AUTO R/W], [SOLO] and [RECORDY] buttons are off, and use the BANK [◀/▶] (Left/Right) buttons (if needed) to call up the desired set of tracks on the 01X.

- **To Mute a track:**

Press the [ON] button of the channel you want to mute (or un-mute).

- **To Solo a track:**

First press the [SOLO] button (the button lights), then press the [ON] button of the channel you want to solo.

## Working in an Editor window

For this section, you should have one or more MIDI tracks, and preferably at least one drum or percussion track in your song. Here, you'll learn how to call up the Editor window for a part and use the 01X to navigate and make simple changes.

### MIDI parts — Key Editor window

- ① Use the [^/∨] (Up/Down) cursor buttons to select one of the MIDI tracks in the song.  
For this example, we'll select a drum track.
- ② Use the [</>] (Left/Right) cursor buttons to select a part in the track.  
These buttons let you jump between the Track list and the event display (showing the recorded parts). Notice that as you press the buttons, each successively selected part is highlighted.

**NOTE** 

- Once you've selected a part in this way, you can also move vertically through the parts of other tracks by using the [^/∨] (Up/Down) cursor buttons.

- ③ Press the [EDIT] button.  
This calls up the Editor window for the selected part — in this case, the Key Editor window.
- ④ Use the [</>] (Left/Right) cursor buttons to select notes in the part.  
Each press of a button not only selects the previous/next note, it plays it as well, letting you check the sound.
- ⑤ Use the [^/∨] (Up/Down) cursor buttons to move the note up or down in pitch.  
This is a convenient and quick way to change the pitch of individual notes. It's also especially useful in drum tracks, letting you hear the change in sound as you make it.
- ⑥ To close the Editor, hold down [SHIFT] and press [CLOSE (F4)].  
Alternately, you could call up another window (using the [TRACK] or [MIXER] buttons), if you want to keep the Editor window active in the background.

## Audio parts — Sample Editor window

You can also call up the Sample Editor window for audio parts in the same way. Use the cursor buttons as described above to select the desired audio part, then press the [EDIT] button to call up the Sample Editor.



- Although all transport controls function normally, no actual wave editing can be done from the 01X panel. Also, keep in mind that the [SCRUB] button is not implemented for Cubase SX remote control.

## Automation

### Continuous automation — using Auto Read/Write

This is one of the most powerful of the control surface features of the 01X. Not only does it let you automate your sequencer mixes in coordination with the 01X, all physical fader moves are completely automated as well, moving along with the song playback.

The following is a brief explanation on how to use the 01X to record and play back volume automation on a specific track. Except where indicated, all control/button references are to the 01X panel.



#### What parameters can I automate?

- All automation parameters available for a track are directly controllable from the 01X. In Cubase SX, click the small [+] button (Show/Hide Automation) at the bottom left of the track to display the automation track(s). Then click on the arrow button next to the current parameter (at top right) to show available parameters. Then click on "More..." from the menu to display the Add Parameter list. You can control any and all of these track parameters from the 01X!



## ■ Operation

- ① Select the desired channel/track.  
Press the appropriate [SEL] button or use the [^/∨] (Up/Down) cursor buttons.
- ② Activate Read/Write automation.  
Press [AUTO R/W] (the button lights), then press the [ON] button of the channel, repeatedly if necessary, until both “R” (Read) and “W” (Write) are on in Cubase SX.

Keep in mind that while the [AUTO R/W] button is lit, all channel [ON] buttons are used for Automation Read/Write. (If you want to mute channels with the [ON] buttons, turn [AUTO R/W] off.)

You can also switch the Read/Write status for all tracks simultaneously. With [AUTO R/W] on, hold down the [SHIFT] button and press the [ON] button of one of the eight input channels.

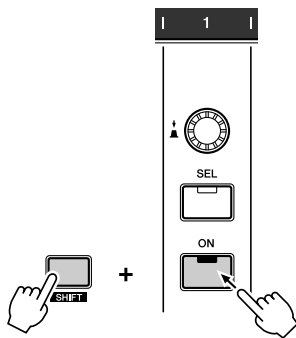

Each press of the button toggles among the settings, and the button lights to indicate the Read/Write status:

- Off — Both Read and Write are off.
- Red — Write is enabled.
- Orange — Both Read and Write are enabled.
- Green — Read is enabled.

- ③ Display the Volume parameter for the track.  
This step isn't necessary for writing, but it conveniently lets you see the changes you make in Cubase SX — as you make them. Click the small [+] button (Show/Hide Automation) at the bottom left of the track, then select Volume at the top right.
- You can display other parameters in the same way (such as Pan), and have them all shown at the same time.
- ④ Start playback.

- ⑤ Move the fader to change the volume.  
As soon as you move the fader, automation is recorded. You'll see in the Cubase SX display that any volume automation recorded previously is replaced with your current moves. Keep in mind that you can also adjust the pan setting at the same time by using the channel knob.

If you want, you can record automation for any of the other parameters. For example, pressing one of the EQ buttons calls up the EQ parameters, from which you can change (and write) settings. (See page 79.) Just remember to select the desired parameter page BEFORE starting playback in step 3 above.

- ⑥ As soon as you're finished recording and while the [SEL] button is flashing, press the [SEL] button of the channel to stop Write automation of the fader. If any previous automation data exists past this point, it will be kept. This lets you punch-in and punch-out fader moves (or, more accurately, “touch-in” and “touch-out”), and maintain the previous fader settings before and after the latest changes.

### NOTE

#### About touch-in and touch-out

- Moving a fader during automation-write automatically sends data (touch-in), but stopping the fader at a point does not instantly stop the data write process (touch-out). If you are using a mouse to move the faders, the computer will recognize when you stop (when the mouse button is released). With the O1X controls, the computer has no idea when you release the fader, so you'll need to “tell” it when you want to stop (by pressing the [SEL] button above). Alternately, you could just do nothing and after a certain amount of time, the O1X will tell the computer to stop writing. The Fader Touch Timeout parameter (page 88) sets the amount of time of fader inaction before writing is stopped. When the [SEL] button is flashing, pressing the [SEL] button stops data writing before Timeout elapses.

- ⑦ Stop playback.
- ⑧ Activate Read automation.  
With [AUTO R/W] on (the button is lit), press the [ON] button of the channel, repeatedly if necessary, until only “R” (Read) is on in Cubase SX.
- ⑨ Play back the section to hear the newly edited changes.



## Editing EQ settings

In this section, we'll be making edits to individual tracks again — but this time from the Channel Settings window. This window not only has a volume fader and pan control, it also features a complete EQ control window, and gives you basic controls for all your effects. Keep in mind that EQ can only be used on audio tracks.

- 1 Call up the Project window.
- 2 Select the desired audio track.  
Do this within Cubase SX or press the [SEL] button of the corresponding channel.
- 3 Click on the “e” button in the selected track box.  
This calls up the Channel Settings window for the channel.



Naturally, you can use the corresponding fader and knob on the 01X here to control volume and pan, respectively.



- Notice that you can select different tracks here by pressing the appropriate [SEL] button — without having to leave the Channel Settings window.
- You can also select plug-in instrument channels for EQ processing. (See the Hint, “Controlling effects for plug-in instruments” on page 81.)

- 4 Press one of the EQ buttons to call up EQ control.  
Pressing any one of the EQ buttons will call up the same menu.

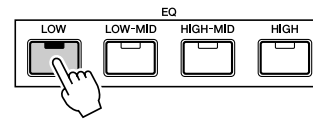

Freq1	Gain1	Freq2	Gain2	Freq3	Gain3	Freq4	Gain4
EQ's		Full Kit					Page:01/02
1	2	3	4	5	6	7	8

- 5 Use the DISPLAY [^/∨] (Up/Down) buttons to change display pages.  
Page 1 contains the Frequency and Gain knobs for bands 1 - 4, and Page 2 contains the Enable (on/off) and Q (bandwidth) controls.

Freq1	Gain1	Freq2	Gain2	Freq3	Gain3	Freq4	Gain4
EQ's		Full Kit					Page:01/02
1	2	3	4	5	6	7	8

Enabl1	Q1	Enabl2	Q2	Enabl3	Q3	Enabl4	Q4
EQ's		Full Kit					Page:02/02
1	2	3	4	5	6	7	8

- 6 Adjust the parameters.  
Use the knobs to change the settings, or turn [FLIP] on and use the faders.  
Notice the EQ response curve in the window, and watch how it mirrors the changes you make. If the curve does not change, make sure you've enabled the EQ band in display Page 2 (or in Cubase SX).

### NOTE

- Any changes you make from your computer keyboard or mouse will automatically be reflected in the 01X as well — in other words, the values will change, and if FLIP is on, the faders will move.

## Editing Effect settings

The 01X can also be used to edit the plug-in effects in Cubase SX.

Using the 01X to control the effects in Cubase SX is essentially a three-stage operation: 1) setting up, 2) adjusting the send levels, and 3) changing the effect settings.

### 1) Setup

- 1) Select an audio track and call up the Channel Settings window.

Click on the track, then click the “e” button in the track’s box.

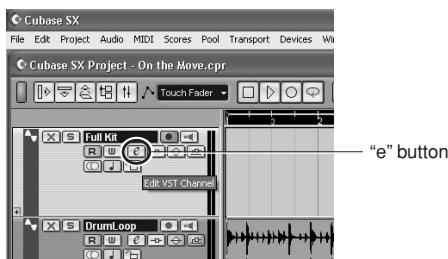

Insert Effects      EQ controls      Send Effects

- 2) Select the desired effects.  
Do this within Cubase. Press [F6] for the Send Effects, or press [F7] for the Master Effects, then click the black box in the effect slot to call up the pop-up menu of the effect types and select the desired effect. Also, click the ‘power’ button to turn on the effect and click the “e” (Edit) button to call up the edit window for the effect.



On/off ('power') button

**NOTE**

- The Master Effects apply to the overall mix, and do not appear in the Channel Settings window.
- You can also turn on the effect from the 01X in the Send parameters (see below).

## 2) Adjust the send levels

- 1 Select the desired audio channel.

Use the [SEL] buttons (and the BANK [◀/▶] (Left/Right) buttons, if necessary). Note that the display windows in Cubase SX change as well — letting you directly select the Channel Settings window for any track.



- Only audio channels can be controlled from the 01X. MIDI channels (and MIDI effects) can be called up, but effect control is not implemented. However, keep in mind that you CAN control EQ and effects of the plug-in instruments (see below).



### Controlling effects for plug-in instruments

- Even though the plug-in instruments (plug-in synthesizers, drum machines, samplers, etc.) are technically MIDI instruments, their audio signals are fair game for processing with the EQ and effects. To control these from the 01X, use the BANK [◀/▶] (Left/Right) buttons (if necessary) and the [SEL] buttons to select the appropriate plug-in audio channel. (Make sure NOT to select the normal MIDI track channel here.)

- 2 Call up the Send parameters by pressing the [SEND] button.

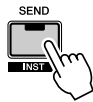

- 3 From Page 1, use the knobs to adjust the effect send level for each effect (1 - 8).

Level1	Level2	Level3	Level4	Level5	Level6	Level7	Level8
FX Send			Full Kit				Page:01/04
1	2	3	4	5	6	7	8

- 4 If necessary, turn the desired effect on or off.

Call up Page 2 of the Send parameters with the DISPLAY [^/∨] (Up/Down) buttons, then use the corresponding knob to turn the effect (1 - 8) for the channel on or off.

FX0n1	FX0n2	FX0n3	FX0n4	FX0n5	FX0n6	FX0n7	FX0n8
FX Send			Full Kit				Page:02/04
1	2	3	4	5	6	7	8

Select other pages in the Send parameters with the DISPLAY [^/∨] (Up/Down) buttons and make the appropriate settings as needed:

- Page 3: Pre/Post
- Page 4: FX bus

## 3) Change the effect settings

- 1 Press the [EFFECT] button.

Each press of the [EFFECT] button toggles between MFX (Master) and FX (Send).

- 2 Use the channel 1 knob to select the desired effect, 1 - 8.

The effect name is shown at the top of the LCD. If the effect slot has no effect, “Off No Effect” is shown.

- 3 Use the DISPLAY [^/∨] (Up/Down) buttons to select the effect parameter pages.

Some effects have few pages (3 or 4), others have many. (Step Filter has a total of 68!)

FX#1	On Karlette	Page:01/07
Send FX1		
1	2	3
4	5	6
7	8	

- 4 Use the knobs to adjust the parameters.



- You can also select plug-in instrument channels for audio processing (EQ, and effects). (See the Hint above, “Controlling effects for plug-in instruments.”)
- For ease in editing, you may want to call up the particular effect edit window so that you can see the parameters in Cubase SX as you tweak them. For the Send Effects, click the appropriate “e” button in the right column of effects in the Channel Settings window. For the Master Effects, press F6, then click the appropriate “e” button.

## Other control features

### Using the Function buttons

The eight Function buttons [F1] - [F8] provide a powerful and versatile way to customize DAW control and streamline your recording, editing and mixing work. Just as with the Key Commands, these buttons can be assigned to any desired function, operation or command. Used in conjunction with the [SHIFT] button, you can program up to thirteen different key commands for instant, one-touch control from the 01X. What's more, the two FOOT SWITCH jacks can also be assigned, letting you control two separate functions with connected footswitches.



#### ● Assigning the Function buttons

- 1 From the Devices menu, select "Device Setup..."
- 2 Select "Mackie Control" from the list.

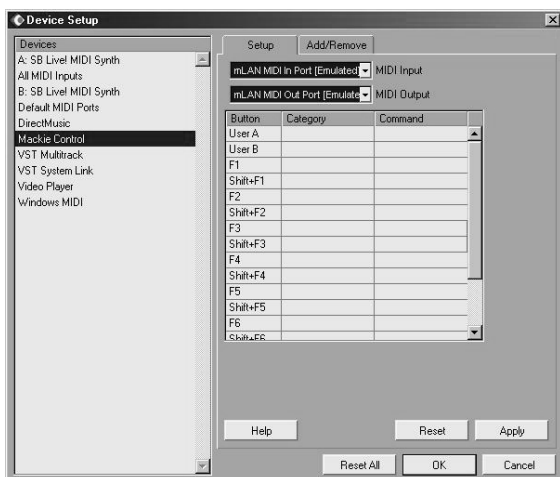

- 3 In the chart next to the button you wish to assign, click the Category cell. From the pop-up menu, select the desired Category.

For details on the available Categories and Commands, refer to the Cubase SX documentation.

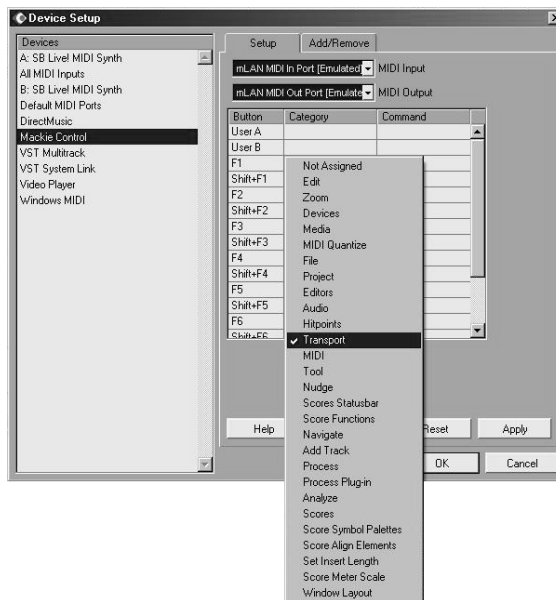

- 4 Next, click the Command cell for the button, and select the desired Command from the pop-up menu.
- 5 Repeat steps 3 and 4 above to program the other Function buttons and their [SHIFT] combinations. Also, program the footswitches if desired (User A and B correspond to FOOT SWITCH jacks A and B, respectively.)

#### NOTE

- The [SHIFT] combinations with [F1], [F2] and [F4] are reserved for other functions (TRACK, MIXER and CLOSE), and cannot be programmed.

- 6 Click [Apply] to enter the settings, then click [OK].

## Undo

---

The [UNDO] button performs the same function as Undo in the sequencer — allowing you to cancel the last edit made and restore the previous condition of the song.

You can also execute Redo from the 01X. Simply hold down the [SHIFT] button and press [UNDO]. The last edit you made will be repeated, cancelling the just-made Undo.

## Saving your song

---

You can also conveniently save your song from the 01X panel, by simply pressing the [SAVE] button.



- For more information on the Remote Functions, refer to the Remote Function List (page 104).

# Reference

## Function Tree/Function List

This chart shows the names, ranges and explanations of all settable parameters in the Internal mode, listed in order according to the function tree. These parameters can be set not only from the 01X itself, but also conveniently from a computer—using the included software program “Studio Manager” (see separate Installation Guide and PDF documentation).

- Operation procedures for calling up each parameter display are indicated in the chart ([button] → [button]).
- For information on the Display Indication and mode selection, see pages 37, 38.
- For information on the Remote mode, see page 104. For information on the “Home” operation, see page 37.
- To restore the default value of the selected parameter, simultaneously hold down the [SHIFT] button and press the appropriate channel knob ([1] – [8]).

### ⚠ CAUTION

- **Never attempt to turn off the power while data is being written to Flash ROM (while an “EXECUTING BACKUP. PLEASE KEEP POWER ON...” message is shown). Turning the power off in this state results in loss of all user data and may cause the system to freeze (due to corruption of data in the Flash ROM).**

### Chart Indications

The example below shows and describes the various indications in the Reference chart.

\* These indications are for example purposes only, and differ from the actual chart.

Knob	Function name/ settings	Explanation	Prompt	Related pages	Block diagram
SCENE MODE [SCENE] → DISPLAY [^/∨] (or [SCENE] → [SCENE] → [SCENE])					
1 SCENE LIBRARY [PAGE SHIFT] + DISPLAY [^/∨]					
①	00 – 99 (Library number)	Determines the Library number. Preset Scene numbers and write-protected Scenes are indicated by asterisks (*) in the display and cannot be changed. Library number 00 is read-only and contains the default settings for all parameters. By using Recall (below) to call up this Scene, you can restore all 01X settings to their initial default state. This Scene can also be called up via an external MIDI device by sending an appropriate program change message (according to the setting in Program Change Assign Table; see page 94).	No	36 65	①
① – ⑧ (⑥)	-18.0dB – +18.0dB	Adjusts the gain level. When Q is set to HPF, this turns the filter on or off. Pressing the [EQ LOW] and [EQ HIGH] buttons simultaneously resets all band parameters (gain, frequency and Q) for the selected channel.	Yes		②

A: These pages can be selected by using the DISPLAY [^/∨] buttons.

[PAGE SHIFT] + DISPLAY [^/∨] ..... Shows the pages (such as the first in a particular parameter category) that can be jumped to by holding down the [PAGE SHIFT] button and pressing DISPLAY [^] or [∨].

B: Indicates the channel knob button to be used. For circled numbers (ex., ①), turn the knob to change the parameter. For boxed numbers (ex., ①), press the knob to change the parameter. In some cases, both operations can be used. The knob indicated in parentheses is used to change the parameter when the SELECTED CHANNEL lamp is lit.

C: Display indication (parameter ranges/settings).

D: Indicates whether a confirmation prompt is used or not. If “No” is shown here, the setting made takes place immediately. For certain parameters, the confirmation prompt can be enabled or disabled as desired; see page 95.

E: Indicates page numbers for relevant operations and details regarding the parameter.

F: Indicates the portion in the Block Diagram (at the end of the manual) to which the parameter applies.

## ■ INTERNAL MODE [INTERNAL]

Knob	Function name/ settings	Explanation	Prompt	Related pages	Block diagram
<b>SCENE MODE [SCENE] → DISPLAY [^/√] (or [SCENE] → [SCENE] → [SCENE])</b>					
<b>1 SCENE LIBRARY</b>					
① – ④	00 – 99 (Library number)	Determines the Library number. Preset Scene numbers and write-protected Scenes are indicated by asterisks (*) in the display and cannot be changed (see “Protect” on page 86). Library number 00 is read-only and contains the default settings for all parameters. By using Recall (below) to call up this Scene, you can restore all 01X settings to their initial default state. This Scene can also be called up via an external device by sending an appropriate program change message (according to the setting in Program Change Assign Table; see page 94).	No	36 65	
① – ④	(Title Edit)	Determines the title (name) of the Library Scene (page 36).		41	
⑤	RECALL	For calling up the selected Scene. When recalling a Scene, the corresponding MIDI program change message is transmitted (page 94). The confirmation prompt can be turned on/off as desired. (See “Recall Confirmation” on page 95.)	Yes	65	
⑥	STORE	<p>For saving 01X settings collectively as a <b>Scene</b>. A Scene contains mixing settings and internal effect parameter settings for all channels, and is stored to internal memory in the Scene Library. Up to 99 Scenes can be stored. The confirmation prompt can be turned on/off as desired. (See “Store Confirmation” on page 95.)</p> <p><b>NOTE</b></p> <ul style="list-style-type: none"> <li>You can turn write-protect on for specific important Scenes that you wish to keep from inadvertently overwriting or deleting. (See “Protect” on page 86.)</li> </ul> <p><b>CAUTION</b></p> <ul style="list-style-type: none"> <li>Any and all data in the destination Scene will be lost when executing Store. Make sure to save and archive important data to computer using the Studio Manager program (page 9).</li> </ul> <p>Parameters stored in a Scene:</p> <ul style="list-style-type: none"> <li>All channel fader settings (level)</li> <li>Send level from each channel to Aux Outs 1 – 4</li> <li>Aux Outs 1 – 4, Level settings for Rec bus</li> <li>[ON] button settings for all channels</li> <li>Phase settings for all channels</li> <li>Attenuation settings for all channels</li> <li>Dynamics settings for all channels (excepting Stereo In)</li> <li>EQ settings for all channels</li> <li>Pan settings for all channels</li> <li>Bus Out settings for all channels</li> <li>Fader group and Mute group settings</li> <li>Pair settings for all channels</li> <li>Effect type and parameter settings for Effects 1 and 2</li> <li>Library number of currently used Input Patch Scene</li> <li>Library number of currently used Output Patch Scene</li> </ul> <p><b>NOTE</b></p> <ul style="list-style-type: none"> <li>If changes made to the Input Patch or Output Patch settings are not stored to the Patch Library, Patch settings may not be appropriate when calling up the stored Scene. This applies also when changing the Input Patch/Output Patch data assigned to the Scene after the Scene has been stored.</li> </ul>	Yes	65	



Knob	Function name/ settings	Explanation	Prompt	Related pages	Block diagram
[7]	CLEAR	<p>This deletes the selected Scene.</p> <p><b>NOTE</b></p> <ul style="list-style-type: none"> <li>You can turn write-protect on for specific important Scenes that you wish to keep from inadvertently overwriting or deleting. (See "Protect" below.)</li> </ul>	Yes	65	
[8]	PROTECT	<p>This turns <b>write-protect</b> on for Scenes that you wish to keep from inadvertently overwriting or deleting. The protected Scenes are indicated by asterisks (*) in the display and cannot be selected for the Store destination or Clear source.</p>	Yes		
<b>2 PATCH LIBRARY ASSIGN</b>					
[6] / [8]	IN-PATCH (Input Patch) 00 – 32  OUT-PATCH (Output Patch) 00 – 32	<p>This determines the Library numbers of the specific Input Patch and Output Patch settings you wish to recall with the Scene. Select the desired number by turning the appropriate channel knob, [6] or [8]. (The display indication flashes.) To revert to the original value without changing it, hold down [SHIFT] and press the knob. To actually assign the desired number, press the knob. The Patch assignments are stored with the Scene.</p>	No	88 90	
<b>3 RECALL SAFE</b>					
[1] – [8]	ENABLE ---- (disable)	<p>This function allows you to exempt certain channels from being changed when recalling a Scene. Set the channel(s) you wish to keep unchanged to "ENABLE." To set the stereo master channel, press the [SEL] button of the STEREO channel and press knob [8]. (To return to normal selection, press any one of the channel [SEL] buttons.) The Recall Safe settings are stored with the Scene.</p> <p>The parameters affected by Recall Safe are: channel fader (level), channel on/off, pan, EQ, Dynamics, Aux Send on/off, Aux Send Pre/Post, and Aux Send level.</p>	No		
<b>UTILITY MODE [UTILITY]</b>					
<b>BACKUP [SHIFT] + [UTILITY]</b>					
[7]	NO	<p>This operation saves the current settings of the 01X to internal memory so that when the device is turned on again, all previous settings are restored automatically.</p> <p>The following settings are NOT memorized by Backup:</p> <ul style="list-style-type: none"> <li>The parameter display status (NAME/VALUE setting or meter indication)</li> <li>The channel display status (Selected Channel or Multi Channel)</li> <li>The Flip status</li> <li>Remote mode status and all Remote mode settings</li> </ul>	Yes		
[8]	YES	<p><b>CAUTION</b></p> <ul style="list-style-type: none"> <li>Parameters that cannot be stored in Libraries and parameters that you have not yet saved can be memorized by the Backup function. If not memorized, they will be lost when turning off the power. Make sure to save or back up important data.</li> </ul> <p><b>CAUTION</b></p> <ul style="list-style-type: none"> <li>Any and all previous backup data will be lost when executing Backup. Make sure to save and archive important data to computer using the Studio Manager program (page 9).</li> </ul>	Yes		

Knob	Function name/ settings	Explanation	Prompt	Related pages	Block diagram
<b>MENU SELECT [UTILITY] (or [UTILITY] in Utility mode)</b>					
[1]	REMOTE	Pressing this jumps to the first page of the Remote Control menu (see below).	No		
[2]	PATCH	Pressing this jumps to the first page of the Patch menu (page 88).	No		
[3]	W.CLK (Wordclock)	Pressing this jumps to the first page of the Wordclock menu (page 92).	No		
[4]	DIO (Digital In/Out)	Pressing this jumps to the first page of the Digital In/Out menu (page 93).	No		
[5]	OSC (Oscillator)	Pressing this jumps to the first page of the Oscillator menu (page 93).	No		
[6]	MIDI	Pressing this jumps to the first page of the MIDI menu (page 94).	No		
[7]	PREFER (Preference)	Pressing this jumps to the first page of the Preference menu (page 95).	No		
[8]	MON (Monitor)	Pressing this jumps to the page of the Monitor menu (page 96).	No		
<b>REMOTE [UTILITY] → Channel knob 1</b>					
<b>1 REMOTE SELECT</b>			<b>[PAGE SHIFT] + DISPLAY [^/∨]</b>		
[1]	GENERAL	Selects the Yamaha sequencer software SQ01 for remote control.	Yes	104	
[2]	LOGIC	Selects the sequencer software Logic for remote control.	Yes	106	
[3]	CUBASE	Selects the sequencer software Cubase/Nuendo for remote control.	Yes	108	
[4]	SONAR	Selects the sequencer software SONAR for remote control.	Yes	110	
[5]	DP (Digital Performer)	Selects the sequencer software Digital Performer for remote control.	Yes	112	
<b>2 SHIFT + REMOTE FUNCTION</b>					
[2] / [3]	GENERAL REMOTE	The 01X lets you maintain Remote Control over a selected sequencer over mLAN Port 1, yet still be able to switch to General Remote mode for controlling Yamaha software (such as the SQ01 and the Multi Part Editor) over mLAN MIDI Port 5. To switch to General Remote control, hold down [SHIFT] and press the [REMOTE] button (the lamp flashes). To return to normal Remote Control, press the [REMOTE] button again (the lamp stays lit).	Yes		
[4] / [5]	NO ASSIGN	If you wish to enable selection of Scenes via program change messages (see “Program Change Assign Table” on page 94), use knob 4 or 5 in this page to turn the “NO ASSIGN” setting on. To turn on GENERAL REMOTE, use knob 2 or 3.	Yes	94	

Knob	Function name/ settings	Explanation	Prompt	Related pages	Block diagram
<b>3 REMOTE AUTOMATION SETUP</b>					
⑦	FADER TOUCH TIMEOUT 100 msec – ∞	Determines the amount of time that the 01X “waits” for fader movement before turning off automation recording. This can be set over a range of 100 ms – 5000 ms, in 100 ms units. When a fader has not been moved for more than the time set here, the 01X stops writing automation data. (This is also referred to as “touch-out”; see page 15.) The [SEL] button flashes while automation writing is active (touch-in). When this parameter is set to “∞” (infinity), there is no “time out” and writing continues indefinitely. You can manually stop automation writing by pressing the [SEL] button when it is flashing (page 17).	No	15	
<b>PATCH [UTILITY] → Channel knob 2</b>					
<b>1 INPUT PATCH (IN1-4) (Input Channels 1 – 4) [PAGE SHIFT] + DISPLAY [^/∨]</b>					
<b>2 INPUT PATCH (IN5-8) (Input Channels 5 – 8)</b>					
①	NONE/AD1 – 8/ DIN-L/DIN-R → IN1 – 8	<p>Determines the input signal routing for input channels 1 – 8. This allows you to route a specific hardware source (MIC/LINE INPUTS 1 – 8, or DIGITAL STEREO IN L/R) to a desired channel input. Turning the knob immediately changes the routing. The settings “AD1” – “AD8” correspond to MIC/LINE INPUTS 1 – 8, while “DIN-L” and “DIN-R” correspond to the DIGITAL STEREO IN signals. To disable input for the desired channel, select “NONE.”</p> <ul style="list-style-type: none"> <li>As the default setting, MIC/LINE INPUTS 1 – 8 are assigned to input channels 1 – 8, respectively.</li> <li>The same input signal can be simultaneously routed to several different input channels.</li> <li>The Input Patch settings made here can be stored to the Input Patch Library (page 89).</li> </ul>	No	27 61	③
③			No		
⑤			No		
⑦			No		

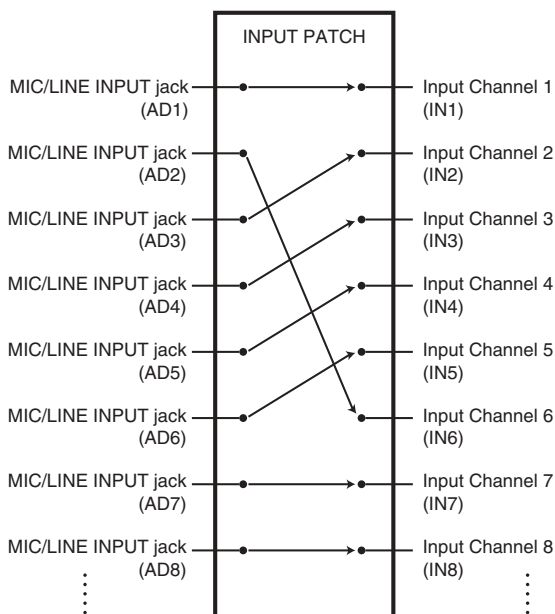

Knob	Function name/ settings	Explanation	Prompt	Related pages	Block diagram
<b>3 INPUT PATCH (ST1/2) (Input Channel Stereo 1/2)</b>					
①	NONE, AD1/2 – AD7/8, D.IN/FX1 → ST11	Determines the input signal routing for Stereo Input channels (STI1/2). The settings “FX1” and “FX2” correspond to the outputs of internal effects. The settings “AD1/2” – “AD7/8” correspond to MIC/LINE INPUTS 1 – 8, while “DIN” corresponds to the DIGITAL STEREO IN signals. Turning the knob immediately changes the routing. To disable input for the desired channel, select “NONE.”  <ul style="list-style-type: none"> <li>• The same input signal can be simultaneously routed to several different input channels.</li> <li>• The Input Patch settings made here can be stored to the Input Patch Library (see below).</li> </ul>	No	27 61	④
③	NONE, AD1/2 – AD7/8, D.IN/FX2 → ST12 (44.1kHz/48kHz mode only)		No		
<b>4 INPUT PATCH LIBRARY</b>					
① – ④	00 – 32 (Library number)	Determines the Library number. Preset Patch numbers are indicated by asterisks (*) in the display and cannot be changed. Library number 00 is read-only and contains the default settings for the Patch. By using Recall (below) to call up this Patch, you can restore Input Patch settings to their initial default state.	No		
① – ④	(Title Edit)	Determines the title (name) of the Patch Library.	No		
⑤	RECALL	For calling up the selected Patch. The confirmation prompt can be turned on/off as desired. (See “Recall Confirmation” on page 95.)	Yes	54	
⑥	STORE	An Input Patch is stored to internal memory in the Input Patch Library. Up to 32 Input Patch can be stored. The confirmation prompt can be turned on/off as desired. (See “Store Confirmation” on page 95.)  <b>⚠ CAUTION</b> <ul style="list-style-type: none"> <li>• <i>Any and all data in the Store destination will be lost when executing the Store operation. Make sure to save and archive important data to computer using the Studio Manager program (page 9).</i></li> </ul>	Yes	65	
⑦	CLEAR	This deletes the selected Input Patch.	Yes		

Knob	Function name/ settings	Explanation	Prompt	Related pages	Block diagram																				
<b>5 OUTPUT PATCH (mLAN OUT CHANNEL)</b>																									
②	ST-BUS → 1/2 – 23/24 (17/18 – 23/24 are available in 48kHz/44.1kHz mode only)	<p>The 01X's Stereo Out, Rec Bus Out, Aux Out 1 through 4 signals can be patched to any mLAN output channels by using these Output Patch parameters (also see page 30). Turning the knob immediately changes the routing. The same output signal cannot be simultaneously routed to multiple mLAN output channels. In the default settings, the direct out signal of the input channel is assigned to the corresponding mLAN output channel.</p>	No	8 30 62																					
④	RECBUS → 1/2 – 23/24 (17/18 – 23/24 are available in 48kHz/44.1kHz mode only)		No	8 30 62																					
⑥	AUX1/2 → 1/2 – 23/24 (17/18 – 23/24 are available in 48kHz/44.1kHz mode only)	<ul style="list-style-type: none"> <li>The direct out setting for a specific channel (see chart below) is cancelled if the corresponding output channel is assigned to a bus here.</li> </ul> <p><b>Direct out settings (when Stereo Out, Rec Bus Out and Aux Out are not assigned to an mLAN pair)</b></p> <table border="1"> <thead> <tr> <th>Hardware Input</th> <th>mLAN Output Channel</th> </tr> </thead> <tbody> <tr> <td>AD1</td> <td>mL1</td> </tr> <tr> <td>:</td> <td>:</td> </tr> <tr> <td>AD8</td> <td>mL8</td> </tr> <tr> <td>mL1</td> <td>mL9</td> </tr> <tr> <td>:</td> <td>:</td> </tr> <tr> <td>mL8</td> <td>mL16</td> </tr> <tr> <td>mL9</td> <td>mL17</td> </tr> <tr> <td>:</td> <td>:</td> </tr> <tr> <td>mL16</td> <td>mL24</td> </tr> </tbody> </table> <p>Wordclock = 48kHz/44.1kHz only</p>	Hardware Input	mLAN Output Channel	AD1	mL1	:	:	AD8	mL8	mL1	mL9	:	:	mL8	mL16	mL9	mL17	:	:	mL16	mL24	No	8 30 62	②③
Hardware Input	mLAN Output Channel																								
AD1	mL1																								
:	:																								
AD8	mL8																								
mL1	mL9																								
:	:																								
mL8	mL16																								
mL9	mL17																								
:	:																								
mL16	mL24																								
⑧	AUX3/4 → 1/2 – 23/24 (17/18 – 23/24 are available in 48kHz/44.1kHz mode only)	<ul style="list-style-type: none"> <li>The Output Patch settings made here can be stored to the Output Patch Library (page 91).</li> </ul>	No	8 30 62																					

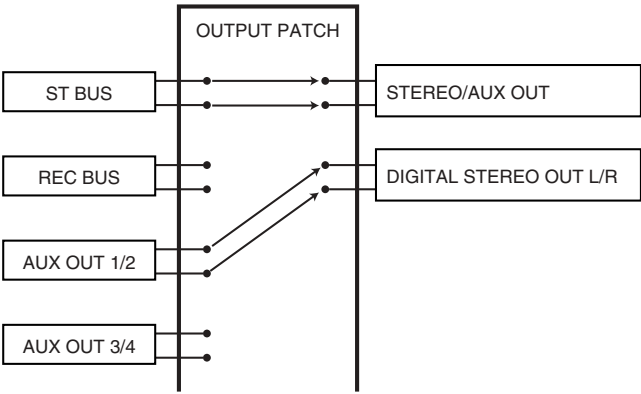
Knob	Function name/ settings	Explanation	Prompt	Related pages	Block diagram
<b>6 OUTPUT PATCH (DIGI. ST/AUX OUT PORT)</b>					
①	ST-BUS, RECBUS, AUX1 – 4 → D. OUT (Digital Out)	<p>The 01X's Stereo Bus Out, Rec Bus Out, Aux Out 1 through 4 signals can be patched to any output jacks by using these Output Patch parameters (also see page 30). Select the signals for Digital Out or STEREO AUX/OUT here. Turning the knob immediately changes the routing.</p> <p><b>NOTE</b></p> <ul style="list-style-type: none"> <li>To set stereo pairs for AUX 1 – 4, simultaneously hold down the [SEL] button corresponding to one of the desired AUX numbers and press the [SEL] button of the intended pair (odd/even numbers). This links the parameters and lets you use the AUX outs in stereo (page 102).</li> </ul> 	No	30 62	24
④	ST-BUS, RECBUS, AUX1 – 4 → ST/AUXOUT	<ul style="list-style-type: none"> <li>The same output signal can be simultaneously routed to multiple output channels/jacks.</li> <li>The Output Patch settings made here can be stored to the Output Patch Library (page 91).</li> </ul>	No		25
<b>7 OUTPUT PATCH (DIRECT OUT POSITION)</b>					
⑦ / ⑧	PRE EQ PRE FADER POST FADER	<p>Determines the Direct Out signal source position for mLAN Out from the following three options.</p> <ul style="list-style-type: none"> <li>PRE EQ: Immediately before Input Channel EQ</li> <li>PRE FADER: Immediately before Input Channel fader</li> <li>POST FADER: Immediately after Input Channel fader</li> </ul>	No	28	15
<b>8 OUTPUT PATCH LIBRARY</b>					
①	00 – 32 (Library number)	Determines the Library number. Preset Patch numbers are indicated by asterisks (*) in the display and cannot be changed. Library number 00 is read-only and contains the default settings for the Patch. By using Recall (below) to call up this Patch, you can restore Output Patch settings to their initial default state.	No		
① – ④	(Title Edit)	Determines the title (name) of the Patch Library (page 41).	No	41	
⑤	RECALL	For calling up the selected Patch. The confirmation prompt can be turned on/off as desired. (See “Recall Confirmation” on page 95.)	Yes	54	

Knob	Function name/ settings	Explanation	Prompt	Related pages	Block diagram
[6]	STORE	An Output Patch is stored to internal memory in the Output Patch Library. Up to 32 Output Patches can be stored. The confirmation prompt can be turned on/off as desired. (See “Store Confirmation” on page 95.)  <b>⚠ CAUTION</b> • Any and all data in the Store destination will be lost when executing the Store operation. Make sure to save and archive important data to computer using the Studio Manager program (page 9).	Yes	65	
[7]	CLEAR	This deletes the selected Output Patch.	Yes		
<b>W.CLK (Wordclock) [UTILITY] → Channel knob 3</b>					
<b>1 mLAN AUTO W.CLK (mLAN Auto Wordclock)</b>			<b>[PAGE SHIFT] + DISPLAY [^/√]</b>		
[1]	ENABLE	When “ENABLE” is selected, the 01X automatically switches its wordclock status to master or slave, depending on the setting of the connected computer. The current status is shown at the top right of the display. The indication “**kHz” is shown when the system is “unlocked” (no signal present). When the 01X is set to “master” (either automatically or manually), use the next page, W.CLK SELECT, to specify the wordclock setting. When the 01X is set to “slave,” the wordclock is set automatically to “mLAN.”	Yes	23	
[2]	DISABLE	• When mLAN is used, make sure to set this to “ENABLE.” Select the wordclock (sample rate) with the Auto Connector application. (Refer to the separate Installation Guide.)	Yes		
<b>2 W.CLK SELECT (Wordclock Select)</b>					
[1]	INTERNAL (Internal clock)	<b>⚠ CAUTION</b> • Changing the wordclock settings on any of the devices in your digital audio system may produce noise in some of the devices For this reason, make sure to turn down the level of your amp/speaker system to avoid damage to your speakers (and ears).  With this setting, the 01X uses its own internal clock. Press the appropriate knob (below) to enter the display for selecting the desired sampling frequency. If you set this to “INT96kHz/88.2kHz” when the current layer is 17 – 24 (mLAN), layer 1 – 8 is automatically called up and channel 1 becomes the currently selected channel. These settings are not available when wordclock is set to “EXT-mLAN.”	No	23	
	[1] INT44.1kHz [3] INT48kHz [5] INT88.2kHz [7] INT96kHz	Determines the frequency of the wordclock (sampling rate).	Yes		
[3]	EXT-D.IN (External clock: digital in)	With this setting, the 01X is used as the wordclock master (page 23) by synchronizing to the signal received via STEREO DIGITAL IN. This setting is not available when wordclock is set to “EXT-mLAN.” The following indications may appear in the display.  EXT-D.IN: Can be used. xEXT-D.IN: System is “unlocked” (no signal present). Cannot be selected. *EXT-D.IN: Cannot be synchronized because of some error (phase difference, etc.)	Yes	23	
[5]	EXT-mLAN (External clock: mLAN)	This is for display purposes only and cannot be changed.  EXT-mLAN: This (external mLAN) is the currently-selected wordclock source. xEXT-mLAN: System is “unlocked” (no signal present). *EXT-mLAN: Cannot be synchronized because of some error (phase difference, etc.)	No	23	



Knob	Function name/ settings	Explanation	Prompt	Related pages	Block diagram
<b>DIO (Digital In/Out) [UTILITY] → Channel knob 4</b>					
<b>1 D.IN ST-BUS CASCADE (Digital In Stereo Bus Cascade)</b>			<b>[PAGE SHIFT] + DISPLAY [^/∨]</b>		
5	ON/OFF	Determines whether cascade connection to the stereo bus is enabled or not for the external device connected to the DIGITAL STEREO IN terminal.	No		16
6	ATT (Attenuate)	This control is used to attenuate Cascade Input signals.	No		17
7	SRC (Sampling rate converter)	Turns the sampling rate converter for DIGITAL STEREO IN on and off.	No		2
<b>2 D.OUT DITHER (Digital Out Dither)</b>					
4 / 5	OFF 16bit 20bit 24bit	When digital audio is transferred to lower-resolution systems, truncated bits may generate undesirable noise. To cancel the audible effect of this noise, a small complement of noise is intentionally added to the digital outputs. This process is called “ <b>dithering</b> .” On the 01X, you can dither the Digital Stereo Out. For example, you can apply dithering to the 01X stereo mix data and record to a 16-bit DAT recorder. Dithering is effective only when the resolution of the receiving device is lower than that of the 01X. The sound quality may be less than optimum if this is not set properly.	No		26
<b>OSC (Oscillator) [UTILITY] → Channel knob 5</b>					
<b>1 OSCILLATOR</b>			<b>[PAGE SHIFT] + DISPLAY [^/∨]</b>		
5	ON/OFF	The 01X features an Oscillator you can use for sound check and testing purposes. This turns the Oscillator on or off.  <b>⚠ CAUTION</b> • <i>To prevent any sudden tone bursts in your monitors or headphones, set the LEVEL parameter to minimum (-96dB) before turning on the Oscillator.</i>	No		19
6	LEVEL -96dB – 0dB	Determines the Oscillator output level.	No		20
7	WAVEFORM	Select the Oscillator waveforms: SINE 100Hz, SINE 1kHz, SINE 10kHz or WHITE NOISE.	No		18
<b>2 OSC. ASSIGN (Oscillator Assign)</b>					
1	RECBUS	Determines the transmission destination of the Oscillator. The selected bus is indicated in brackets (for example: <RECBUS>).	No		22
3 – 6	AUX1 – 4		No		
8	ST-BUS		No		

Knob	Function name/ settings	Explanation	Prompt	Related pages	Block diagram
<b>MIDI [UTILITY] → Channel knob 6</b>					
<b>1 STUDIO MANAGER ID</b>			<b>[PAGE SHIFT] + DISPLAY [^/∨]</b>		
⑦	1 – 8	Determines the Studio Manager ID. This number must match the Console Device ID of the Studio Manager (page 9) when transferring the data.	No		
<b>2 MIDI CHANNEL</b>					
⑤	TX CH (Transmit Channel) 1 – 16	Determines the MIDI Transmit channel for transmitting MIDI (program change) messages.	No	87	
⑥	RX CH (Receive Channel) 1 – 16	Determines the MIDI Receive channel for receiving MIDI (program change) messages.	No	87	
<b>3 PROGRAM CHANGE</b>					
⑤	TX ON/OFF (Transmit On/Off)	Enables (ON) or disables (OFF) transmission of Program Change messages from the 01X. (Also see “Program Change Assign Table” below.)	No	87	
⑥	RX ON/OFF (Receive On/Off)	Enables (ON) or disables (OFF) reception of Program Change messages on the 01X from an external device. (Also see “Program Change Assign Table” below.)	No	87	
⑦	OMNI ON/OFF	Determines whether program change messages are received over all MIDI channels or not. (Also see “Program Change Assign Table” below.)	No	87	
<b>4 PROGRAM CHANGE ASSIGN TABLE</b>					
②	PGM (Program Change Number) 1 – 128	<p>This determines the assignment of program change number to Scene number. In other words, it allows you to specify which MIDI program change number (sent via an external device) selects which Scene on the 01X. When a Scene is recalled on the 01X, the Program Change number assigned to that Scene is transmitted. Program change messages are sent and received over mLAN Port 5.</p> <ul style="list-style-type: none"> <li>• Make sure to set the SHIFT + REMOTE function to “NO ASSIGN” when transmitting/receiving program change data.</li> <li>• Scenes 01 – 99 are assigned by default to program change numbers 1 – 99 in order, and Scene 00 (initial setting) is assigned to program change number 100.</li> <li>• These program change/Scene number assignments can be stored to external devices (such as a computer) by using the included Studio Manager software.</li> <li>• When the same Scene is assigned to more than one program change number, the lowest program change number takes precedence.</li> </ul>	No	87	
④	SCENE (Scene Number) NO ASSIGN/00 – 99		No	87	
⑧	INIT (Initialize)	Initializes or resets the Scene/Program Change assignments to their default values.	Yes		

Knob	Function name/ settings	Explanation	Prompt	Related pages	Block diagram
<b>5 mLAN MIDI INFORMATION</b>					
[1]	1 : GENERAL 1 : LOGIC 1 : CUBASE 1 : SONAR 1 : DP (DIGITAL PERFORMER)	This page is for display only and the parameters cannot be changed here. This display shows the settings for each mLAN port. The 01X features five independent MIDI ports, and the assigned functions are shown here. The settings made in "Remote Select" (page 87) are mirrored here for Port 1, and the settings made in SHIFT + REMOTE function are mirrored here for Port 5.  1: Remote control of DAW software 2: Direct mLAN connection to MIDI A terminal 3: Direct mLAN connection to MIDI B terminal 4: Data transfer with Studio Manager software 5: SCENE-CTR setting.....For recalling Scenes via program change messages from an external device, and for transmitting Program Change messages from the 01X GNRL-RMT .....For remote control of Multi Part Editor software	No		
[2]	2 : MIDI-A		No		
[3]	3 : MIDI-B		No		
[4]	4 : STUDIO.M (Studio Manager)		No		
[5]	5 : SCENE-CTR (Scene Control) 5 : GNRL-RMT (General-Remote)		No		
<b>PREFER (Preference) [UTILITY] → Channel knob 7</b>					
<b>1 STORE/RECALL CONFIRMATION</b>			<b>[PAGE SHIFT] + DISPLAY [^/√]</b>		
[4]	ON/OFF	Determines whether a confirmation prompt is shown or not for the Store and Recall operations. When this is set to "OFF," the corresponding operation is executed immediately without confirmation.	No		
[8]	ON/OFF		No		
<b>2 DIGITAL OUT COPYRIGHT</b>					
[8]	ON/OFF	This setting specifies whether SCMS (Serial Copy Management System) copy protect data will be enabled (ON) or not (OFF) for the digital signal output from the DIGITAL STEREO OUT jack. Even if this is set to ON, it will be possible to digitally record onto a DAT/MD recorder connected to the DIGITAL STEREO OUT jack, but it will not be possible to make second-generation digital copies.	No		
<b>3 DISPLAY SETTINGS</b>					
[4]	PARAM DISP TIME (Parameter Display Time) 1 – 5sec	When "Name/Value" (page 17) is set to "NAME," this determines the amount of time the currently adjusted parameter value is shown in the display. When Fader Level Display (below) is set to on, this also determines the time the Level display is shown.	No	38	
[8]	FADER LEVEL DISP (Fader Level Display)	Determines whether the Level value is shown or not when a channel fader is moved.	No	38	

Knob	Function name/ settings	Explanation	Prompt	Related pages	Block diagram
<b>4 SOLO MODE</b>					
⑦ / ⑧	MIX SOLO/ LAST SOLO	When using the Solo function with the [ON] button ([SOLO] button is on), this determines whether multiple channels can be soloed (MIX SOLO) or only the last selected channel is soloed (LAST SOLO).	No		
<b>5 SOLO SAFE</b>					
① – ⑧	ENABLE	Input Channels can be configured individually so that they are not muted when other Input Channels are soloed (Solo Safe function). Signals from Input Channels that are set to ENABLE are always fed to the Stereo bus, regardless of the channels' Solo function status.	No		
<b>MON (Monitor) [UTILITY] → Channel knob 8</b>					
<b>1 MONITOR (Monitor Mix Balance) [PAGE SHIFT] + DISPLAY [^/∨]</b>					
④	A (LED-ON) "INT>0: 126<DAW" – "INT>126: 0<DAW"	The audio signals of the last two available channels (the last two numbered channels specified with mLAN Auto Connector; refer to the separate Installation Guide) from the DAW which are input to the 01X mLAN channels 17/18 (or 9/10 when set to 96kHz/88.2kHz operation) are output directly to the monitor/headphones output without processing. The settings here let you set the output balance between the DAW audio and the audio of the 01X itself, and let you switch between two of these assignments using the [MONITOR] button —Monitor A (the lamp lights) or Monitor B (the lamp is off). These settings can also be made by holding the [MONITOR] button and turning the knob [5] (for A) or [7] (for B).  INT> 0: 126<DAW ..... 100% DAW audio (no audio from internal mixer) INT>126: 0<DAW ..... 100% internal mixer audio (no audio from DAW)  • Pressing the knob sets the balance to 50%-50% • To restore the default setting (shown above), simultaneously hold down [SHIFT] and press the corresponding knob.	No	37	②⑦
⑥	B (LED-OFF) "INT>0: 126<DAW" – "INT>126: 0<DAW"				
<b>PAGE [INTERNAL] → ([SELECTED CHANNEL] → [SEL]) → [EQ] / [PAN] / [SEND] / [DYNAMICS] / [GROUP] / [EFFECT]</b>					
<b>EQ LOW [INTERNAL] → ([SELECTED CHANNEL]) → [EQ LOW]</b>					
<b>EQ LOW GAIN/EQL-G [PAGE SHIFT] + DISPLAY [^/∨]</b>					
① – ⑧ (⑥)	-18.0dB – +18.0dB	Adjusts the gain level. When Q is set to HPF, this turns the filter on or off. Pressing the [EQ LOW] and [EQ HIGH] buttons simultaneously resets all band parameters (gain, frequency and Q) for the selected channel.	No		
<b>EQ LOW FREQUENCY/EQL-F</b>					
① – ⑧ (⑤)	21.2Hz – 20.0kHz	Adjusts the frequency.	No		
<b>EQ LOW Q/EQL-Q</b>					
① – ⑧ (④)	HPF, 10.0 – 0.10, L.SHELF	Determines the bandwidth of the EQ processing. When Q is set to HPF, the gain control turns the filter on or off.	No		

Knob	Function name/ settings	Explanation	Prompt	Related pages	Block diagram
<b>EQ ON/OFF</b>					
① – ⑧ (1)	ON/OFF	Turns the EQ on or off. The LOW-band EQ functions as a high-pass filter when the Q parameter is set to HPF. It functions as a shelving-type EQ when the Q parameter is set to L.SHELF. The L and R settings of the ST IN channel's EQ are linked together.	No		7
<b>ATT (Attenuate) (Selected Channel only)</b>					
(2)	- 96.0dB – +12.0dB	Determines the amount of pre-EQ signal attenuation in dB.	No		5
<b>■ EQ LIBRARY (Selected Channel only)</b> (This can be called up by pressing the same EQ button twice in a row. For example: [EQ LOW] → [EQ LOW])					
		See EQ High (page 98)	No		
<b>EQ LOW-MID [INTERNAL] → ([SELECTED CHANNEL]) → [EQ LOW-MID]</b>					
<b>EQ LOW-MID GAIN/EQLM-G</b> <span style="float: right;">[PAGE SHIFT] + DISPLAY [^/∨]</span>					
① – ⑧ (6)	-18.0dB – +18.0dB	Adjusts the gain level. Pressing the [EQ LOW] and [EQ HIGH] buttons simultaneously resets all band parameters (gain, frequency and Q) for the selected channel.	No		
<b>EQ LOW-MID FREQUENCY/EQML-F</b>					
① – ⑧ (5)	21.2Hz – 20.0kHz	Adjusts the frequency.	No		
<b>EQ LOW Q/EQL-Q</b>					
① – ⑧ (4)	10.0 – 0.10	Determines the bandwidth of the EQ processing.	No		
<b>EQ ON/OFF</b>					
① – ⑧ (1)	ON/OFF	Turns the EQ on or off. The L and R settings of the ST IN channel's EQ are linked together.	No		7
<b>ATT (Attenuate) (Selected Channel only)</b>					
(2)	- 96.0dB – +12.0dB	Determines the amount of pre-EQ signal attenuation in dB.	No		5
<b>■ EQ LIBRARY (Selected Channel only)</b> (This can be called up by pressing the same EQ button twice in a row. For example: [EQ LOW] → [EQ LOW])					
		See EQ High (page 98)	No		
<b>EQ HIGH-MID [INTERNAL] → ([SELECTED CHANNEL]) → [EQ HIGH-MID]</b>					
<b>EQ HIGH-MID GAIN/EQHM-G</b> <span style="float: right;">[PAGE SHIFT] + DISPLAY [^/∨]</span>					
① – ⑧ (6)	-18.0dB – +18.0dB	Adjusts the gain level. Pressing the [EQ LOW] and [EQ HIGH] buttons simultaneously resets all band parameters (gain, frequency and Q) for the selected channel.	No		

Knob	Function name/ settings	Explanation	Prompt	Related pages	Block diagram
<b>EQ HIGH-MID FREQUENCY/EQHL-F</b>					
① – ⑧ (⑤)	21.2Hz – 20.0kHz	Adjusts the frequency.	No		
<b>EQ LOW Q/EQL-Q</b>					
① – ⑧ (④)	10.0 – 0.10	Determines the bandwidth of the EQ processing.	No		
<b>EQ ON/OFF</b>					
1 – 8 (1)	ON/OFF	Turns the EQ on or off. The L and R settings of the ST IN channel's EQ are linked together.	No		7
<b>ATT (Attenuate) (Selected Channel only)</b>					
(2)	- 96.0dB – +12.0dB	Determines the amount of pre-EQ signal attenuation in dB.	No		5
<b>■ EQ LIBRARY (Selected Channel only)</b> (This can be called up by pressing the same EQ button twice in a row. For example: [EQ LOW] → [EQ LOW])					
		See EQ High (see below)	No		
<b>EQ HIGH [INTERNAL] → ([SELECTED CHANNEL]) → [EQ HIGH]</b>					
<b>EQ HIGH GAIN/EQH-G</b> <span style="float: right;">[PAGE SHIFT] + DISPLAY [^/∇]</span>					
① – ⑧ (⑥)	-18.0dB – +18.0dB	Adjusts the gain level. When Q is set to LPF, this turns the filter on or off. Pressing the [EQ LOW] and [EQ HIGH] buttons simultaneously resets all band parameters (gain, frequency and Q) for the selected channel.	No		
<b>EQ HIGH FREQUENCY/EQH-F</b>					
① – ⑧ (⑤)	21.2Hz – 20.0kHz	Adjusts the frequency.	No		
<b>EQ HIGH Q/EQH-Q</b>					
① – ⑧ (④)	LPF, 10.0 – 0.10, H.SHELF	Determines the bandwidth of the EQ processing. When Q is set to LPF, the gain control turns the filter on or off.	No		
<b>EQ ON/OFF</b>					
1 – 8 (1)	ON/OFF	Turns the EQ on or off. The HIGH-band EQ functions as a low-pass filter when the Q parameter is set to LPF. It functions as a shelving-type EQ when the Q parameter is set to H.SHELF. The L and R settings of the ST IN channel's EQ are linked together.	No		7
<b>ATT (Attenuate) (Selected Channel only)</b>					
(2)	- 96.0dB – +12.0dB	Determines the amount of pre-EQ signal attenuation in dB.	No		5

Knob	Function name/ settings	Explanation	Prompt	Related pages	Block diagram
<b>■ EQ LIBRARY (Common to 4 bands) (Selected Channel only)</b> <span style="float: right;">[PAGE SHIFT] + DISPLAY [^/∨]</span> (This can be called up by pressing the same EQ button twice in a row. For example: [EQ LOW] → [EQ LOW])					
① – ④	01 – 200 (Library number)	Determines the Library number. Preset EQ numbers (01 – 40; see page 115) are indicated by asterisks (*) in the display and cannot be changed.	No	36	
① – ④	(Title Edit)	Determines the title (name) of the EQ Library.	No	41	
⑤	RECALL	For calling up the selected EQ Library. The confirmation prompt can be turned on/off as desired. (See “Recall Confirmation” on page 95.)	Yes	54	
⑥	STORE	EQ settings are stored to internal memory in the EQ Library. Up to 160 settings can be stored. The confirmation prompt can be turned on/off as desired. (See “Store Confirmation” on page 95.)  <b>⚠ CAUTION</b> • Any and all data in the Store destination will be lost when executing the Store operation. Make sure to save and archive important data to computer using the Studio Manager program (page 9).	Yes	65	
⑦	CLEAR	This deletes the selected EQ Library.	Yes		
<b>PAN [INTERNAL] → ([SELECTED CHANNEL]) → [PAN]</b>					
<b>PAN/BALANCE</b> <span style="float: right;">[PAGE SHIFT] + DISPLAY [^/∨]</span>					
① – ⑧ (①)	L63 – CENTER – R63	Enables adjustment of the pan setting of the signals routed from the Input Channels to the Stereo Bus. Pressing the [SEL] button of ST IN channels repeatedly toggles between the left and right channels, for independent operation. You can also apply the pan setting to a pair of Bus channels. When the Stereo Out (ST) is selected, it is used to set the balance.	No		⑪
<b>RECBUS (REC bus assign)</b> <span style="float: right;">[PAGE SHIFT] + DISPLAY [^/∨]</span>					
① – ⑧ (③)	ON/--	When this is set to on, the corresponding input channel signal is sent to the Rec Bus.	No		⑳
<b>ST-BUS (Stereo bus assign)</b> <span style="float: right;">[PAGE SHIFT] + DISPLAY [^/∨]</span>					
① – ⑧ (④)	ON/--	When this is set to on, the corresponding input channel signal is sent to the Stereo Bus.	No		⑳
<b>PHASE</b> <span style="float: right;">[PAGE SHIFT] + DISPLAY [^/∨]</span>					
① – ⑧ (⑤)	NORMAL/REVERS	Switch the corresponding Input Channel <b>phase</b> . NORMAL indicates normal phase, and REVERS indicates reversed phase. You can set the phase separately for ST IN channel L/R or each channel in a channel pair. Pressing the [SEL] buttons repeatedly toggles between L and R.	No	21	⑥
<b>ON/OFF (Selected Channel only)</b>					
⑦	ON/OFF	Determines whether the channel is on or off. The channel is muted with the Off setting. This works in unison with the [ON] button on the panel.	No		⑨
<b>LEVEL (Selected Channel only)</b>					
⑧	-∞ – +6.0 (BUS/AUX/ST: -∞ – +0.0)	Enables adjustment of the input level of the Input Channel signal and the output level of the Output Channel. When the channel knob 8 is pressed, the level is set to nominal (0dB). This works in unison with the channel fader on the panel.	No		⑩



Knob	Function name/ settings	Explanation	Prompt	Related pages	Block diagram																																			
<b>SEND [INTERNAL] → ([SELECTED CHANNEL]) → [SEND]</b>																																								
<b>SEND 1 – 4 (AUX Send Level 1 – 4) [PAGE SHIFT] + DISPLAY [^/∇]</b>																																								
① – ⑧ (②/⑥)	-∞ – +6.0	<p>Determines the Aux Send level of the Input Channels. When the channel knob is pressed, the level is set to nominal (0dB).</p> <p><b>NOTE</b></p> <ul style="list-style-type: none"> <li>To assign a pair, simultaneously press and hold down the [SEL] button for one AUX bus and press the [SEL] button of the adjacent AUX (paired numbers should be odd/even and in order). (See page 102.)</li> </ul> <p><b>CAUTION</b></p> <ul style="list-style-type: none"> <li>When using an internal effect via the Aux Send, do NOT turn up the send level to the corresponding AUX bus for the channel to which the effect return signal is routed. Doing so will result in loud feedback, and may damage your equipment. For example, when the 01X is in the default condition, AUX 3 is routed to the input of internal effect 1, and the L/R signals of the ST IN channel 1 are routed to the output. If you turn up the send level of ST IN channel 1 to AUX 3, a feedback loop is created.</li> </ul>	No		14																																			
<b>AX 1 – 4-PP/AUX 1 – 4PREPOST (AUX1 – 4 PRE/POST)</b>																																								
① – ⑧ (③/⑦)	PRE/POST	Determines the Aux Sends signal source points. The PRE sends pre-fader signals, and the POST sends post-fader signals.	No		12																																			
<b>ON/OFF (Selected Channel only)</b>																																								
(①/⑤)	ON/OFF	Determines whether Aux Send is on or off. The channel is muted with the Off setting.	No		13																																			
<b>DYNAMICS [INTERNAL] → ([SELECTED CHANNEL]) → [DYNAMICS]</b>																																								
<b>ON/OFF [PAGE SHIFT] + DISPLAY [^/∇]</b>																																								
① – ⑧ (①)		<p>Determines whether Dynamics is on or off. Parameters depend on the Dynamics Types selected in the Library as follows. Dynamics is not available for the ST IN channels.</p> <table border="1"> <thead> <tr> <th>Dynamics Type</th> <th>Compressor/ Expander</th> <th>Compander</th> <th>Gate Ducking</th> <th>Knob</th> </tr> </thead> <tbody> <tr> <td>Parameter 1</td> <td>THRESH</td> <td>THRESH</td> <td>THRESH</td> <td>3</td> </tr> <tr> <td>Parameter 2</td> <td>RATIO</td> <td>RATIO</td> <td>RANGE</td> <td>4</td> </tr> <tr> <td>Parameter 3</td> <td>ATTACK</td> <td>ATTACK</td> <td>ATTACK</td> <td>5</td> </tr> <tr> <td>Parameter 4</td> <td>RELEASE</td> <td>RELEASE</td> <td>DECAY</td> <td>6</td> </tr> <tr> <td>Parameter 5</td> <td>GAIN</td> <td>GAIN</td> <td>HOLD</td> <td>7</td> </tr> <tr> <td>Parameter 6</td> <td>KNEE</td> <td>WIDTH</td> <td>KEY-IN</td> <td>8</td> </tr> </tbody> </table>	Dynamics Type	Compressor/ Expander	Compander	Gate Ducking	Knob	Parameter 1	THRESH	THRESH	THRESH	3	Parameter 2	RATIO	RATIO	RANGE	4	Parameter 3	ATTACK	ATTACK	ATTACK	5	Parameter 4	RELEASE	RELEASE	DECAY	6	Parameter 5	GAIN	GAIN	HOLD	7	Parameter 6	KNEE	WIDTH	KEY-IN	8	No		8
Dynamics Type	Compressor/ Expander	Compander	Gate Ducking	Knob																																				
Parameter 1	THRESH	THRESH	THRESH	3																																				
Parameter 2	RATIO	RATIO	RANGE	4																																				
Parameter 3	ATTACK	ATTACK	ATTACK	5																																				
Parameter 4	RELEASE	RELEASE	DECAY	6																																				
Parameter 5	GAIN	GAIN	HOLD	7																																				
Parameter 6	KNEE	WIDTH	KEY-IN	8																																				
<b>Parameters 1 – 6 (Selected Channel only)</b>																																								
(③ – ⑧)		For adjusting the Dynamics parameters 1 through 6 individually.	No																																					
<b>DYNAMICS LIBRARY (Selected Channel only) [PAGE SHIFT] + DISPLAY [^/∇]</b>																																								
① – ④	01 – 128	Determines the Library number. Preset Dynamics numbers are indicated by asterisks (*) in the display and cannot be changed.	No	118																																				
[1] – [4]	(Title Edit)	Determines the title (name) of the Dynamics Library.	No	41																																				

Knob	Function name/ settings	Explanation	Prompt	Related pages	Block diagram
5	RECALL	For calling up the selected Dynamics effect. The confirmation prompt can be turned on/off as desired. (See “Recall Confirmation” on page 95.)	Yes	54	
6	STORE	Dynamics settings are stored to internal memory in the Dynamics Library. Up to 88 Dynamics settings can be stored. The confirmation prompt can be turned on/off as desired. (See “Store Confirmation” on page 95.)  <b>⚠ CAUTION</b> • <i>Any and all data in the Store destination will be lost when executing the Store operation. Make sure to save and archive important data to computer using the Studio Manager program (page 9).</i>	Yes	65	
7	CLEAR	This deletes the selected EQ Library.	Yes		
<b>GROUP [INTERNAL] → ([SELECTED CHANNEL]) → [GROUP]</b>					
<b>FADER GROUP/FD-GRP</b> <span style="float: right;"><b>[PAGE SHIFT] + DISPLAY [^/∨]</b></span>					
① – ⑧ (①)	GRP-A/B/C/D	Input Channel or Output Channel faders (the level controls) can be grouped. There are four (A through D) Channel fader groups. When channel faders are grouped, operating one of them enables you to control the level of the other grouped faders while maintaining the relative level differences.  • If you add one channel from a pair to a group, the pair partner is automatically added to the group. • You can also select a channel on another Layer by switching Layers. • You can temporarily disable a Fader group in order to make adjustments to individual faders by operating the fader while holding down its [SEL] button.	No		
<b>MUTE GROUP/MT-GRP</b> <span style="float: right;"><b>[PAGE SHIFT] + DISPLAY [^/∨]</b></span>					
① – ⑧ (②)	GRP-E/F/G/H	Input Channel or Output Channel [ON] buttons can be grouped. There are four (E through H) Channel Mute groups. When channel [ON] buttons are grouped, pressing any one of them turns the [ON] buttons for all the grouped channels on or off. A mute group can include On channels and Off channels at the same time, which turn off or on respectively when you press any one of the grouped [ON] buttons.  • If you add one channel from a pair to a group, the pair partner is automatically added to the group. • You can also select a channel on another Layer by switching Layers. • If you wish to turn a subset of the grouped channels on or off, first turn ENABLE (below) off, or remove the channels you wish to turn on or off from the group.	No		
<b>GROUP ENABLE</b> <span style="float: right;"><b>[PAGE SHIFT] + DISPLAY [^/∨]</b></span>					
① – ⑧	ENA/---	This parameter enables (ENA) or disables (---) the Groups. When the group is set to disable (---), the corresponding group is temporarily cancelled.	No		

Knob	Function name/ settings	Explanation	Prompt	Related pages	Block diagram
<b>CH PAIR (Channel Pair)</b> <span style="float: right;"><b>[PAGE SHIFT] + DISPLAY [^/∨]</b></span>					
① – ⑧ ④	PAIRED/----	<p>Faders and most parameters of adjacent odd-even channels or Aux buses are linked for stereo operation. When the channels are linked, the message “PAIRED” appears. Pairs can also be assigned by simultaneously holding down the [SEL] button of one channel/bus and pressing the [SEL] button of the adjacent channel/bus (odd/even numbers). After selecting the desired channel/bus, you can copy and link parameter values for the odd channels to the even channels by using channel knobs 1/2. To copy and link parameter values for the even channels to the odd channels, use channel knobs 3/4. Use channel knobs 5/6 to assign the two selected channels as a pair and reset both to their initial default values. The ST IN channels 1/2 cannot be assigned to a pair with any other channel.</p> <ul style="list-style-type: none"> <li>If you add one channel from a pair to a group, the pair partner is automatically added to the group.</li> </ul> <p>The linked parameters are as follows: Attenuator, EQ, Dynamics, Channel on/off, Level, Groups, Solo Safe, Recall Safe, Solo, Aux Send on/off, Aux Send Pre/Post, Aux Send level</p>	Yes		
<b>EFFECT [INTERNAL] → [EFFECT] (EFFECT1) → [EFFECT] (EFFECT2) → [EFFECT] (EFFECT1)</b>					
<b>EFFECT1/2 PATCH/BYPASS/MIX/TYPE (Effect 2 is 48kHz/44.1kHz mode only)</b> <span style="float: right;"><b>[PAGE SHIFT] + DISPLAY [^/∨]</b></span>					
③	AUX3/4, CH1 – 8, mL1 – 16 (mL9 – 16 are 48kHz/ 44.1kHz mode only), BUS, STEREO	<p>Determines the signals to be fed to the effects processors. If you select AUX 3/4 and select STI (stereo in channel) 1/2 for the output destination (and if FX1/FX2 are selected for the stereo input channel 1/2; page 89), this can be used as a conventional effect send/return. If you select a particular channel, such as the input channels, REC bus, stereo out, it can be used as an insertion effect.</p> <ul style="list-style-type: none"> <li>If effects are inserted in channels, you cannot use those effects via Aux Sends or insert them into other channels.</li> <li>The number of inputs and outputs available for each effect varies depending on the type of effect programs recalled.</li> </ul> <p><b>⚠ CAUTION</b></p> <ul style="list-style-type: none"> <li><i>When using an internal effect via the Aux Send, do NOT turn up the send level to the corresponding AUX bus for the channel to which the effect return signal is routed. Doing so will result in loud feedback, and may damage your equipment. For example, when the 01X is in the default condition, AUX 3 is routed to the input of internal effect 1, and the L/R signals of the ST IN channel 1 are routed to the output. If you turn up the send level of ST IN channel 1 to AUX 3, a feedback loop is created.</i></li> </ul>	No		①
④	BYPASS	Determines whether or not effects can be bypassed.	No		
⑤	MIX	When set to 0%, only the dry signal is heard. When set to 100%, only the wet signal is heard. To mix the effects sound returned via the Aux Sends with the original dry sound, set the effect’s MIX BALANCE parameter to 100% (only the effects sound will be output).	No		
⑥	TYPE	Indicates the currently-selected effect type. You cannot change the effects type on this page. To change the effects type, recall a program that uses the desired effects type from the Effects library (see below).	No		

Knob	Function name/ settings	Explanation	Prompt	Related pages	Block diagram
<b>1 – 7 EFFECT1/2 PARAMETER (Effect 2 is 48kHz/44.1kHz mode only)</b>			<b>[PAGE SHIFT] + DISPLAY [^/∨]</b>		
[1] – [4]	(Effect Parameters)	Determines the effect parameters. Parameters depend on the Effect Types selected in the Library (see the Effect Library List).	No	126	
<b>EFFECT1/2 LIBRARY</b>			<b>[PAGE SHIFT] + DISPLAY [^/∨]</b>		
① – ④	01 – 128 (Library number)	Determines the Library number. Preset Effect numbers (01 – 43; see page 125) are indicated by asterisks (*) in the display and cannot be changed.	No	125	
[1] – [4]	(Title Edit)	Determines the title (name) of the Effect Library.	No	41	
[5]	RECALL	For calling up the selected Effect Library. The confirmation prompt can be turned on/off as desired. (See “Recall Confirmation” on page 95.)	Yes	54	
[6]	STORE	Effect settings are stored to internal memory in the Effect Library. Up to 85 settings (common to Library 1 and 2) can be stored. The confirmation prompt can be turned on/off as desired. (See “Store Confirmation” on page 95.)  <b>⚠ CAUTION</b> • <i>Any and all data in the Store destination will be lost when executing the Store operation. Make sure to save and archive important data to computer using the Studio Manager program (page 9).</i>	Yes	65	
[7]	CLEAR	This deletes the selected Effect Library.	Yes		
<b>CHANNEL LIBRARY [SHIFT] + [SELECTED CHANNEL]</b>					
① – ④	00 – 128 (Library number)	Determines the Library number. Preset Channel numbers are indicated by asterisks (*) in the display and cannot be changed.  The following presets are available. • 00 Reset (-∞dB): This preset memory resets all parameters of the currently-selected channel to their initial values and sets the channel fader level to -∞dB. • 01 Reset (0dB): This preset memory resets all parameters of the currently-selected channel to their initial values and sets the channel fader level to 0dB (i.e., nominal).	No	36	
[1] – [4]	(Title Edit)	Determines the title (name) of the Effect Library. The category (IN/BUS/AUX/ST) is shown following the name, for all Library Scenes, excepting presets.	No	41	
[6]	RECALL	For calling up the selected Library. The Libraries that can be recalled from the channel Library are limited to ones whose category is the same as the currently selected channel. For example, you can recall Input Channel settings to Input Channels, but not to Aux Out 1 through 4, with the exception that memories #0 and #1 can be recalled to any channels.	Yes	54	
[7]	STORE	Channel settings are stored to internal memory in the Channel Library. Up to 127 settings can be stored. The confirmation prompt can be turned on/off as desired. (See “Store Confirmation” on page 95.)  <b>⚠ CAUTION</b> • <i>Any and all data in the Store destination will be lost when executing the Store operation. Make sure to save and archive important data to computer using the Studio Manager program (page 9).</i>	Yes	65	
[8]	CLEAR	This deletes the selected Channel Library.	Yes		

## Remote Function List



- For information and instructions on setting up the 01X for remote control, refer to the Getting Started and the section “Demo Song Playback/Remote Control Setup” in the separate Installation Guide booklet.
- For information on the Remote functions of the Multi Part Editor, refer to the Multi Part Editor owner's manual (PDF file).
- If necessary, set the display language for the DAW software to English (especially if letters are not displayed correctly). Refer to the owner's manual of your particular DAW for details.
- Depending on the specifications of the particular DAW, there may be a time lag in transmitting control data, and as a result, the parameter value indications and LED indications on the 01X may not match the indications in the DAW. If this happens, refresh the display by operating a knob or the BANK buttons. (Depending on the particular DAW, refreshing the indications in this way may not be possible.)

■ **SQ01 V2:** (In the Track View window, select “Remote Control” from the Setup menu and set the Mode to “01X.”) On the 01X, set Remote Select (page 87) in the Utility mode to “GENERAL.”

Button	Function	LED	Notes (page 114)
<b>In all modes:</b>			
[SHIFT]+[INTERNAL]	Exits from Remote mode, then starts Studio Manager.	—	
[NAME/VALUE]	Changes the indication of the parameter name and its value.	—	
[SHIFT]+[NAME/VALUE]	Changes the meter display mode.	—	
DISPLAY [ ^ / √ ]	Changes the parameter to be edited.	—	
[SEL] (when [SEL] lamp flashes)	Fader touch-out (page 15)	flashes → goes out	
[SEL] (when [AUTO EDIT] lamp is on)	Fader touch-in (page 15)	flashes	
[ON] (in normal status)	Turns each channel off or on (mutes/unmutes the signal).	lights/goes out	*1
[SHIFT]+ [ON] of the Master Channel (in normal status)	This sets all channels to the same off/on (mute/unmute) status as the master channel. Pressing it again turns all channels on or off simultaneously. (Applies to the Channel Module and Software Synthesizer Module.)	lights/goes out	
[SHIFT] + [ON] of each channel (in normal status)	This sets all channels (excepting the master channel) to the same off/on (mute/unmute) status as the channel whose button was pressed. Pressing it again turns all channels (excepting the master channel) on or off simultaneously. (Applies to the Channel Module and Software Synthesizer Module.)	lights/goes out	*1
[ON] (when [SOLO] lamp is on)	Turns the Solo function of each channel on or off. (Applies to the Channel Module/Software Synthesizer Module.)	lights/goes out	*2
[SHIFT]+[ON] (when [SOLO] lamp is on)	This sets all channels (excepting the master channel) to the same Solo status as the channel whose [ON] button was pressed. Pressing it again turns Solo for all channels (excepting the master channel) on or off simultaneously. (Applies to the Channel Module and Software Synthesizer Module.)	lights/goes out	*2
[ON] ([AUTO R/W] lights)	This switches the automation status for each channel in order: Off (unlit), Read (green), Touch (orange) and Latch (red).	lights/goes out	
[SHIFT]+[ON] ([AUTO R/W] lights)	This sets all channels to the same automation status as the channel whose [ON] button was pressed. The settings are changed in order: Off (unlit), Read (green), Touch (orange) and Latch (red).	lights/goes out	
[AUTO EDIT]	Changes the function of the [SEL] button to the touch-in function. This button flashes during automation touch-in.	lights	
[SOLO]	Changes the function of the [ON] button to the Solo function.	lights	
[SHIFT]+[SOLO]	Determines the Solo/Mute settings of the selected tracks.	—	
[SHIFT]+[REC RDY]	Determines the recording on or off settings of the selected tracks.	—	
[AUTO R/W]	Changes the function of the [ON] button to the AUTO R/W function.	lights	
[AUDIO]	Starts the Audio Mixer or moves the Audio Mixer Window to the front of the computer screen. This button operation applies to the channel module.	lights	
[INST]	Starts the Audio Mixer or moves the Audio Mixer Window to the front of the computer screen. This button operation applies to the Software Synthesizer module.	lights	
[MIDI]	Starts the MIDI Editor (such as the Multi Part Editor) or moves it to the front of the computer screen.	lights	*3
[BUS/AUX]	Displays the AUX/BUS window or brings it to the front of the computer screen (when the Audio Mixer is active).	lights	
[OTHER]	Starts the Audio Mixer or brings it to the front of the computer screen. This operation applies to the Effect module.	lights	*4
BANK [ ◀ ▶ ]	Scrolls through the track indication every eight channels.	—	

Button	Function	LED	Notes (page 114)
[F8] ([SAVE] flashes)	This cancels the Save operation, when the final confirmation for Save appears ([SAVE] flashes).	—	
[SHIFT]+[F1]	Brings the Track View window to the front of the computer screen. (This operation applies to the current song.)	—	
[SHIFT]+[F2]	Displays the Mixer window (Audio Mixer/Multi Part Editor) or brings it to the front of the computer screen.	—	
[SHIFT]+[F3]	Displays the List window or brings it to the front of the computer screen.	—	
[SHIFT]+[F4]	Closes the current window.	—	
[SHIFT]+[F5]	Displays the Piano Roll window or brings it to the front of the computer screen.	—	
[SHIFT]+[F6]	No function	—	
[SHIFT]+[F7]	Starts the TWE (Wave Editor).	—	
[SHIFT]+[F8]	Alternately hides/shows the Transport window (Transport Bar/Location Bar/Record).	—	
[UNDO]	Executes the Undo operation.	—	
[SHIFT]+[UNDO]	Executes the Redo operation.	—	
[SAVE]	When the lamp lights, press this so that the lamp flashes. Press this again to execute the Save operation (lamp turns off). Press [F8] to cancel it.	lights/flashes	
[MARKER]+[WRITE]	Enters/clears a Marker at the current song position.	—	
[◀◀]	Press briefly to move back one measure at a time, or hold to continuously rewind.	—	
[MARKER]+[◀◀]	Moves the song position to the previous Marker.	—	
[▶▶]	Press briefly to move forward one measure at a time, or hold to continuously fast-forward.	—	
[MARKER]+[▶▶]	Moves the song position to the next Marker.	—	
[■]	Press to stop recording or playback. Pressing this when playback is stopped goes to the top of the song.	—	
[▶]	Press to start playback from the current point.	lights	
FOOT SWITCH 1	Playback/Stop	—	
[●] or FOOT SWITCH 2	Press this to enter/exit from the Recording Standby. The [▶] (Play) and [●] (Rec) lamp are turned on during recording.	lights	
[ZOOM]	Turns Zoom on and off.	lights	
Cursor [^] ([ZOOM] goes out)	Moves the cursor (indicating the current track) up.	—	
Cursor [v] ([ZOOM] goes out)	Moves the cursor (indicating the current track) down.	—	
Cursor [<] ([ZOOM] goes out)	Selects the previous block.	—	
Cursor [>] ([ZOOM] goes out)	Selects the next block.	—	
Cursor [^/v/</>] ([ZOOM] lights)	Zooms in/out in the active Track View and Piano Roll Window.	—	
Dial	Moves the song position. (See “SCRUB” below.)	—	
[SCRUB]	Determines how the Scrub function is applied when using the dial. When this is set to on, Scrub moves according to the Grid position in the Track View window. When set to off, it moves in measures.	lights/goes out	
<b>PAN mode [PAN]</b>		lights	
Knobs 1 – 8 (turning)	Edits the Pan (on page 1).	—	
Knobs 1 – 8 (turning)	Edits the Input level (on page 2).	—	
[SHIFT]+Knobs 1 – 8 (pressing)	Resets the edited parameter to the default value (CENTER/0.00).	—	
<b>AUX SEND mode [SEND] (Not available when the AUX/BUS window is active.)</b>		lights	
Knobs 1 – 8 (turning)	Edits the AUX Send Level.	—	
[SHIFT]+Knobs 1 – 8 (pressing)	Resets the edited parameter to the default value (-∞).	—	
<b>EFF SEND mode [EFFECT] (Not available when the AUX/BUS window is active.)</b>		lights	
Knobs 1 – 8	Edits the Effect Send Level.	—	
[SHIFT]+Knobs 1 – 8	Resets the edited parameter to the default value (-∞).	—	
<b>No function</b>			
[REC RDY] [LOOP] [EDIT] [FLIP]			

■ **LOGIC:** On the 01X, set Remote Select (page 87) in the Utility mode to “LOGIC.”

Button	Function	LED	Notes (page 114)
<b>In all modes:</b>			
[NAME/VALUE]	Changes the indication of the parameter name and its value.	—	
[SHIFT]+[NAME/VALUE]	Changes the meter display mode.	—	
[PAGE SHIFT]+DISPLAY [^/∨] Cursor [^/∨] (Multi Channel View) (Parameters other than PAN/NSTRUMENT mode)	Changes the Slot number.	—	
[SHIFT]+[REMOTE]	Enters the mode for Multi Part Editor Remote operation. Press [REMOTE] button to cancel the mode.	flashes	*5
[SEL] (in normal status)	Selects a channel.	lights/goes out	*1, 2
[SEL] ([SEL] flashes)	Fader touch-out (page 15)	flashes → goes out	
[SEL] ([AUTO EDIT] lights)	Fader touch-in (page 15)	flashes	
[ON] (in normal status)	Turns each channel off or on (mutes/unmutes the signal).	lights/goes out	*1, 2
[SHIFT]+[ON] (in normal status)	Turns all the channels on.	lights	*1, 2, 6, 7
[ON] ([SOLO] lights)	Sets Solo for each channel to on or off.	lights/goes out	*2
[SHIFT]+[ON] ([SOLO] lights)	Sets Solo for all channels to off (excepting the master channel).	goes out	*2
[ON] ([REC RDY] lights)	Sets the REC RDY of each channel to on or off.	lights/goes out	*2
[SHIFT]+[ON] ([REC RDY] lights)	Sets REC RDY for all channels to off (excepting the master channel).	goes out	*2
[ON] ([AUTO R/W] lights)	Switches the automation status of the selected channel (only that channel) in order: Latch, Touch, Read and Off.	lights/goes out	*2
[SHIFT]+[ON] ([AUTO R/W] lights)	Switches the automation status (Read/Off) of all channels.	lights/goes out	*2, 7, 8
[AUTO EDIT]	Changes the function of the [SEL] button to the touch-in function. This button flashes during automation touch-in.	lights	
[SOLO]	Changes the function of the [ON] button to the Solo function.	lights	
[REC RDY]	Changes the function of the [ON] button to the REC RDY function.	lights	
[AUTO R/W]	Changes the function of the [ON] button to the AUTO R/W function.	lights	
[AUDIO]	Makes the Global View mode active and displays the Audio track with the Multi Channel view. Pressing this again restores the normal track display.	lights	*9
[INST]	Makes the Global View mode active and displays the Audio Instrument track with the Multi Channel view. Pressing this again restores the normal track display.	lights	*9
[MIDI]	Makes the Global View mode active and displays the MIDI track with the Multi Channel view. Pressing this again restores the normal track display.	lights	*9
[BUS/AUX]	Makes the Global View mode active and displays the AUX object, BUS object, AUDIO OUTPUT object with the Multi Channel view. Pressing this alternates among the following displays, in order: Bus Track, Aux Track, Output Track and Normal Track.	lights	*9
[OTHER]	Makes the Global View mode active and displays the AUDIO INPUT object with the Multi Channel view. Pressing this again restores the normal track display.	lights	*9
BANK [◀▶]	Scrolls through the track indication every eight channels.	—	
[SHIFT]+BANK [◀▶]	Scrolls through the track indication channel-by-channel.	—	
[FLIP]	Exchanges the functions between the Channel Knobs and the Faders.	lights	
[SHIFT]+[FLIP]	Assigns the function of the Channel Knob to the Fader.	flashes	
[EDIT]	Turns Nudge on or off.	lights/goes out	
[SHIFT]+[EDIT]	Enters the Nudge Option mode.	—	
[LOOP]	Turns Loop on or off.	lights/goes out	
[SHIFT]+[LOOP]	Enters the Cycle Option mode.	—	
[F1] – [F7]	Calls up Screen Sets 1 – 7.	—	
[SHIFT]+[F1]	Brings the Track View window to the front of the computer screen.	—	
[SHIFT]+[F2]	Displays the Mixer window	—	
[SHIFT]+[F3]	Displays the List window.	—	
[SHIFT]+[F4]	Closes the current window.	—	
[SHIFT]+[F5]	Displays the Piano Roll window.	—	
[SHIFT]+[F6]	Displays the Score window	—	
[SHIFT]+[F7]	Displays the Audio window	—	
[SHIFT]+[F8]	Shows the Transport Bar.	—	
[UNDO]	Executes the Undo operation.	—	
[SHIFT]+[UNDO]	Executes the Redo operation.	—	

Before Using

Basics Section

Getting Started

Reference

Appendix



Button	Function	LED	Notes (page 114)
[SAVE]	Executes the Save operation.	lights	
[MARKER]	Turns the Marker on or off.	—	
[SHIFT]+[MARKER]	Enters the Marker Option mode.	—	
[◀◀]	Press to continuously rewind. Press repeatedly to rewind more quickly. When the Marker is turned on, this operation moves the song position to the previous Marker. When Nudge is turned on, this operation moves the current object.	—	
[▶▶]	Press to continuously fast-forward. Press repeatedly to fast-forward more quickly. When the Marker is turned on, this operation moves the song position to the next Marker. When Nudge is turned on, this operation moves the current object.	—	
[■]	Press to stop recording or playback. Pressing this when playback is stopped goes to the top of the song.	—	
[▶]	Press to start playback.	lights	
[●]	Press this to start recording. The [▶] (Play) and [●] (Rec) lamp are turned on during recording.	lights	
[ZOOM]	Turns Zoom on and off.	lights	
FOOT SWITCH 1	Playback/Stop	—	
FOOT SWITCH 2	Punch-in/Punch-out	—	
Dial	Scrub playback./Moves the song position. (See “SCRUB” below.)	—	
[SCRUB]	Turns Scrub on and off. When Scrub is on, the dial can be used for Scrub playback. When Scrub is off, the dial is used to move the song position.	lights	
<b>PAN mode</b> [PAN] (Multi Channel View) [PAN] → [PAN] (Track Parameter View of PAN/SURROUND)		lights	*28
DISPLAY [^ / √] Cursor [< / >] (Multi Channel View)	Changes the parameter to be edited.	—	
Knobs 1 – 8 (turning/turning → pressing)	Edits the parameter. Tweak the Knob to select “Pan” or “Surround” so that the Pan/Surround indication flashes, then press the Knob to actually select either of them.	—	
Knobs 1 – 8 (pressing) (Parameters other than Mode selection)	Resets the edited parameter to the default value.	—	
<b>EQ mode</b> [EQ LOW]/[EQ LOW-MID]/[EQ HIGH-MID]/[EQ HIGH] (Multi Channel View) [EQ LOW] → [EQ LOW]/[EQ LOW-MID] → [EQ LOW-MID]/[EQ HIGH-MID] → [EQ HIGH-MID]/[EQ HIGH] → [EQ HIGH] (Track Parameter View)		lights	*10, 28
DISPLAY [^ / √] Cursor [< / >] (Multi Channel View)	Changes the parameter to be edited.	—	
DISPLAY [^ / √] Cursor [< / >] (Track Parameter View)	Switches between EQ1/2 and EQ3/4.	—	
Knobs 1 – 8 (turning)	For editing parameters.	—	
Knobs 1 – 8 (pressing) (when the edited parameter is Type)	Turns the EQ bypass on or off.	—	
Knobs 1 – 8 (pressing) (when the edited parameter is other than Type)	Resets the parameter value to its default.	—	
<b>SEND mode</b> [SEND] (Multi Channel View) [SEND] → [SEND] (Track Parameter View)		lights	*11, 28
DISPLAY [^ / √] Cursor [< / >] (Multi Channel View)	Changes the parameter to be edited.	—	
DISPLAY [^ / √] Cursor [< / >] (Track Parameter View)	Switches between SEND 1/2 and SEND 3/4.	—	
Knobs 1 – 8 (turning/turning → pressing)	For editing parameters. When setting the Send destination, turn the knob to select it on Track Parameter View (indication flashes), then press the knob to actually enter the selected setting.	—	
Knobs 1 – 8 (pressing) (when the edited parameter is Send Level)	Reset the parameter value to the default.	—	
Knobs 1 – 8 (pressing) (when the edited parameter is PRE/POST or Mute)	Changes the setup.	—	
<b>PLUG-IN mode</b> [SHIFT]+[PLUG-IN] (Multi Channel View) [SHIFT]+[PLUG-IN] → [SHIFT]+[PLUG-IN] (Track Parameter View)		lights	*28
Knobs 1 – 8 (turning → pressing)	Turn the knob to select the desired Plug-in for insertion (indication flashes), then press the knob to actually enter the selected setting.	—	
Knobs 1 – 8 (pressing) (Knob to which the Plug-in is assigned)	Calls up the parameter page and displays the Editor window on Logic.	—	
Knobs 1 – 8 (turning) (Parameter page)	For editing parameters.	—	

Button	Function	LED	Notes (page 114)
Knobs 1 – 8 (pressing) (Parameter page)	Reset the parameter value to the default. (Some parameters cannot be reset.)	—	
DISPLAY [^ / √] Cursor [< / >] (Parameter page)	Changes the page. (Page is displayed at the right of the LCD.)	—	
[SHIFT]+[PLUG-IN]	Return to the PLUG-IN mode from PLUG-IN parameter pages.	—	
<b>INSTRUMENT mode</b> [SHIFT]+[INST] (Multi Channel View) [SHIFT]+[INST] → [SHIFT]+[INST] (Track Parameter View)		lights	*28
Knobs 1 – 8 (turning → pressing)	Turn the knob to select the desired instrument for insertion (indication flashes), then press the knob to actually enter the selected setting.	—	
Knobs 1 – 8 (pressing) (Knob to which the Instrument is assigned)	Calls up the parameter page and displays the Editor window on Logic.	—	
Knobs 1 – 8 (turning) (Parameter page)	For editing parameters.	—	
Knobs 1 – 8 (pressing) (Parameter page)	Reset the parameter value to the default. (Some parameters cannot be reset.)	—	
DISPLAY [^ / √] Cursor [< / >] (Parameter page)	Changes the page. (Page is displayed at the right of the LCD.)	—	
[SHIFT]+[INST]	Return to the INSTRUMENT mode.	—	
<b>No function</b>			
[WRITE]			

■ **Cubase/NUENDO:** On the 01X, set Remote Select (page 87) in the Utility mode to “CUBASE.”

Button	Function	LED	Notes (page 114)
<b>In all modes:</b>			
[NAME/VALUE]	Changes the indication of the parameter name and its value.	—	
DISPLAY [^ / √]	Calls up the next/previous page.	—	
[SHIFT]+DISPLAY [^]	Calls up the first page.	—	
[SHIFT]+DISPLAY [∨]	Calls up the last page.	—	
[SHIFT]+[REMOTE]	Enters the mode for Multi Part Editor Remote operation. Press [REMOTE] button to cancel the mode.	flashes	*5
[SEL] (in normal status)	Selects a channel.	lights/goes out	*2
[SEL] ([SEL] flashes)	Fader touch-out (page 15)	flashes → goes out	
[SEL] ([AUTO EDIT] lights)	Fader touch-in (page 15)	flashes	
[ON] (in normal status)	Turns each channel off or on (mutes/unmutes the signal)	lights/goes out	*2
[SHIFT]+[ON] (in normal status)	Turns all the channels on.	lights	*2, 12, 13
[ON] ([SOLO] lights)	Sets Solo for each channel to on or off.	lights/goes out	*2
[SHIFT]+[ON] ([SOLO] lights)	Sets Solo for all channels to off.	lights/goes out	*2, 12
[ON] ([REC RDY] lights)	Sets the REC RDY of each channel to on or off.	lights/goes out	*2
[ON] ([AUTO R/W] lights)	Switches the automation status of the selected channel (only that channel) in order: Off, Read and Read + Write.	lights/goes out	*14
[SHIFT]+[ON] ([AUTO R/W] lights)	Switches the automation status of all channels in order: Off, Read, Read + Write, Write (or Off, Write, Write + Read, Read).	lights/goes out	*2, 14
[AUTO EDIT]	Changes the function of the [SEL] button to the touch-in function. This button flashes during automation touch-in.	lights	
[SOLO]	Changes the function of the [ON] button to the Solo function.	lights	
[REC RDY]	Changes the function of the [ON] button to the REC RDY function.	lights	
[AUTO R/W]	Changes the function of the [ON] button to the AUTO R/W function.	lights	
BANK [◀/▶]	Scrolls through the track indication every eight channels.	—	
[SHIFT]+BANK [◀/▶]	Scrolls through the track indication channel-by-channel.	—	
[FLIP]	Exchanges the functions between the Channel Knobs and the Faders.	lights	
[EDIT]	Opens the Edit window for the currently selected block (AUDIO/MIDI).	—	
[LOOP]	Turns Loop on or off.	lights/goes out	
[F1] – [F8]	[F1] – [F8] as defined in Cubase/Nuendo.	—	
[SHIFT]+[F1]	Brings the Track View window to the front of the computer screen.	—	

Button	Function	LED	Notes (page 114)
[SHIFT]+[F2]	Starts the Mixer View window./Brings the Mixer View window to the front of the computer screen.	—	
[SHIFT]+[F3]	[SHIFT]+[F3] as defined in Cubase/Nuendo.	—	
[SHIFT]+[F4]	Closes the current window.	—	*16
[SHIFT]+[F5]	[SHIFT]+[F5] as defined in Cubase/Nuendo.	—	
[SHIFT]+[F6]	[SHIFT]+[F6] as defined in Cubase/Nuendo.	—	
[SHIFT]+[F7]	[SHIFT]+[F7] as defined in Cubase/Nuendo.	—	
[SHIFT]+[F8]	[SHIFT]+[F8] as defined in Cubase/Nuendo.	—	
[GROUP]+[F1] – [F8]	Corresponds to 1 – 8 of the Channel View on the Mixer Window.	—	
[UNDO]	Executes the Undo operation.	—	
[SHIFT]+[UNDO]	Executes the Redo operation	—	
[SAVE]	Executes the Save operation.	—	
[SHIFT]+[SAVE]	Executes the Revert operation, restoring the status that was saved last.	—	*25
[WRITE]	Enters a Marker at the current song position.	—	
[◀◀]	Hold to continuously rewind.	—	
[SHIFT]+[◀◀]	Moves the song position to the top of the song.	—	
[MARKER]+[◀◀]	Moves the song position to the previous Marker.	—	
[▶▶]	Hold to continuously fast-forward.	—	
[SHIFT]+[▶▶]	Moves the song position to the end of the song.	—	
[MARKER]+[▶▶]	Moves the song position to the next Marker.	—	*15
[■]	Press to stop recording or playback. Pressing this when playback is stopped goes to the song location at which the song playback started at last time.	—	
[▶]	Press to start playback.	lights	*39
[●]	Press this to start song recording. The [▶] (Play) and [●] (Rec) lamp are turned on during recording.	lights	
[ZOOM]+Cursor [^ / \ < / >]	Zoom	—	
FOOT SWITCH 1	USER A as defined in Cubase/NUENDO	—	
FOOT SWITCH 2	USER B as defined in Cubase/NUENDO	—	
[SCRUB] (NUENDO only)	Turns Scrub on and off. When Scrub is on, the dial can be used for Scrub playback. When Scrub is off, the dial is used to move the song position.	lights	
<b>PAN mode [PAN] (MULTI CHANNEL only)</b>			
Knobs 1 – 8	For editing parameters.	—	
FOOT SWITCH 2	USER B as defined in Cubase/NUENDO	—	
<b>EQ mode [EQ LOW]/[EQ LOW-MID]/[EQ HIGH-MID]/[EQ HIGH] (SELECTED CHANNEL only)</b>			
Knobs 1 – 8	For editing parameters.	—	
<b>SEND mode [SEND] (SELECTED CHANNEL only)</b>			
Knobs 1 – 8	For editing parameters.	—	
<b>PLUG-IN mode [SHIFT]+[PLUG-IN] (SELECTED CHANNEL only)</b>			
Knob 1 (on page 1 only)	Changes the Slot Number.	—	
Knob 2 (on page 1 only)	Turns the Effects on or off.	—	
Knobs 3 – 5 (on page 1 only)	Selects an Effect Type.	—	*17, 30
Knobs 1 – 8 (turning) (on page 2 and later)	Edits each of the parameters	—	
<b>SEND EFFECT mode [EFFECT]/MASTER EFFECT mode EFFECT] → [EFFECT] (Global mode only)</b>			
Knob 1 (on page 1 only)	Changes the Slot Number	—	
Knob 2 (on page 1 only)	Turns the Effects on or off.	—	*29
Knobs 1 – 8 (on page 2 and later)	Edits each of the parameters	—	*18, 29
<b>INSTRUMENT mode [SHIFT]+[SEND] (Global mode only)</b>			
Knob 1 (on page 1 only)	Changes the Slot Number.	—	
Knob 2 (on page 1 only)	Turns the software tone generator on or off.	—	
Knobs 1 – 8 (on page 2 and later)	Edits each of the parameters.	—	*18
<b>No function</b>			
[AUDIO] [INST] [MIDI] [BUS/AUX] [OTHER]			

■ **SONAR:** On the 01X, set Remote Select (page 87) in the Utility mode to “SONAR.”

Button	Function	LED	Notes (page 114)
<b>In all modes:</b>			
[NAME/VALUE]	Changes the indication of the parameter name and its value.	—	
[SHIFT]+[NAME/VALUE]	Turns the Meter indication on or off.	—	*19
DISPLAY [^/√] (Multi Channel)	Changes the parameter to be edited via a Knob in order one by one.	—	
[PAGE SHIFT]+DISPLAY [^/√] (Multi channel)	Changes the parameters to be edited via a Knob in groups of eight.	—	
DISPLAY [^/√] (SELECTED CHANNEL)	Changes the indicated parameter in order one by one.	—	
[PAGE SHIFT]+DISPLAY [^/√] (SELECTED CHANNEL)	Changes the indicated parameters in groups of eight.	—	
[SHIFT]+[REMOTE]	Enters the mode for Multi Part Editor Remote operation. Press [REMOTE] button to cancel the mode.	flashes	*5
[SEL] (in normal status)	Selects a channel.	lights/goes out	*2
[SEL] ([SEL] flashes)	Fader touch-out (page 15)	flashes → goes out	
[SEL] ([AUTO EDIT] lights)	Fader touch-in (page 15)	flashes	
[ON] (in normal status)	Turns each channel off or on (mutes/unmutes the signal).	lights/goes out	*2, 32
[SHIFT]+[ON] (in normal status)	Turns all channels on.	lights	*2, 32
[ON] ([SOLO] lights)	Sets Solo for each channel to on or off.	lights/goes out	*2
[SHIFT]+[ON] ([SOLO] lights)	Sets Solo for all channels to off.	goes out	*2
[ON] ([REC RDY] lights)	Sets the REC RDY of each channel to on or off.	lights/goes out	*2
[SHIFT]+[ON] ([REC RDY] lights)	Sets the REC RDY of all channels to off.	goes out	*2
[AUTO EDIT]	Changes the function of the [SEL] button to the touch-in function. This button flashes during automation touch-in.	lights	
[SOLO]	Changes the function of the [ON] button to the Solo function.	lights	
[REC RDY]	Changes the function of the [ON] button to the REC RDY function.	lights	
[AUTO R/W]+[ON]	This arms or activates fader automation.	lights	*2
[AUTO R/W]+Knob	This arms or activates the parameters assigned to the respective knobs. (This is not indicated on the 01X.)	—	
[AUDIO]	Assigns a Track to a Fader.	—	
[INST]	Assigns a Track to a Fader.	—	
[MIDI]	Assigns a Track to a Fader.	—	
[BUS/AUX]	Assigns an AUX BUS to a Fader.	—	
[OTHER]	Assigns output level adjustment of the Virtual Main Bus to the Faders.	—	
BANK [◀▶]	Scrolls through the track indication every eight channels.	—	
[SHIFT]+BANK [◀▶]	Scrolls through the track indication channel-by-channel.	—	
[FLIP]	Assigns the functions of the Channel Knobs to the Faders.	flashes	
[FLIP] → [FLIP]	Switches the functions of the Channel Knobs and the Faders.	lights	
[EDIT]	Switches the current window.	—	
[LOOP]	Sets Loop to on or off.	lights/goes out	
[F1] – [F8]	[F1] – [F8] as defined in SONAR.	—	
[SHIFT]+[F1]	The same as [F1] as defined in SONAR.	—	
[SHIFT]+[F2]	The same as [F2] as defined in SONAR.	—	
[SHIFT]+[F3]	The same as [F3] as defined in SONAR.	—	
[SHIFT]+[F4]	Closes the current window.	—	
[SHIFT]+[F5]	The same as [F5] as defined in SONAR.	—	
[SHIFT]+[F6]	The same as [F6] as defined in SONAR.	—	
[SHIFT]+[F7]	The same as [F7] as defined in SONAR.	—	
[SHIFT]+[F8]	The same as [F8] as defined in SONAR.	—	
[UNDO]	Executes the Undo operation.	—	
[SHIFT]+[UNDO]	Executes the Redo operation.	—	
[SAVE]	Executes the Save operation.	—	
[WRITE]	Opens the window for entering the Marker to the current song position.	—	
[MARKER]	Turns the Marker on or off.	—	
[◀◀]	Reverse (or Rewind). When the Marker is turned on, this operation moves the song position to the previous Marker.	—	*33
[SHIFT]+[◀◀]	Moves the song position to the top of the song. When the Marker is turned on, this operation opens the window for entering the Marker.	—	

Before Using

Basics Section

Getting Started

Reference

Appendix

Button	Function	LED	Notes (page 114)
[▶▶]	Forward (or Fast Forward). When the Marker is turned on, this operation moves the song position to the next Marker.	—	*33
[SHIFT]+[▶▶]	Moves the song position to the end of the song. When the Marker is turned on, this operation opens the window for entering the Marker.	—	
[■]	Stops recording or playback.	—	
[▶]	Press to start playback.	lights	*33
[●]	Press this to start song recording. The [▶] (Play) and [●] (Rec) lamp are turned on during recording.	lights	
[SHIFT]+[●]	Starts recording automation. The [▶] button lights while data is being recorded.	—	
[ZOOM]	Turns Zoom on and off.	lights	
FOOT SWITCH 1	Foot SW A as defined in SONAR.	—	
FOOT SWITCH 2	Foot SW B as defined in SONAR.	—	
Dial	Controls one of these three functions: Scrub, moving of the song position, or data entry.	—	
[SCRUB]	Turns Scrub on and off. When Scrub is on, the dial can be used for Scrub playback. When Scrub is off, the dial is used to move the song position.	lights/goes out	*20
[SHIFT]+[SCRUB]	Activates data entry for the dial.	flashes	
<b>TRACK mode</b>	<b>[SHIFT]+[PAN] (Track Parameter mode)</b> <b>[SHIFT]+[PAN] → [SHIFT]+[PAN] (Selected Channel mode)</b>	lights	
Knobs 1 – 8 (turning)	For editing parameters.	—	*18
Knobs 1 – 8 (pressing)	For editing parameters./Resets the parameter value to its default. *22	—	
<b>PAN mode</b>	<b>[PAN]</b> <b>[PAN] → [PAN] (Selected Channel mode of PAN/SURROUND)</b>	lights	
Knobs 1 – 8 (turning)	For editing parameters.	—	*18
Knobs 1 – 8 (pressing)	For editing parameters./Resets the parameter value to its default. *22	—	
<b>SEND mode</b>	<b>[SEND]</b> <b>[SEND] → [SEND] (Selected Channel mode)</b>	lights	*31
Knobs 1 – 8 (turning)	For editing parameters.	—	*18
Knobs 1 – 8 (pressing)	For editing parameters./Resets the parameter value to its default. *22	—	
<b>PLUG-IN mode</b>	<b>[SHIFT]+[PLUG-IN]</b> <b>[SHIFT]+[PLUG-IN] → [SHIFT]+[PLUG-IN] (Selected Channel mode)</b>	lights	*21
[SHIFT]+DISPLAY [^/√]	Changes the Plug-in number.	—	*11
Knobs 1 – 8 (turning)	For editing parameters.	—	*18, 34
Knobs 1 – 8 (pressing)	For editing parameters./Resets the parameter value to its default. *22	—	*34
<b>EQ mode</b>	<b>[EQ LOW]/[EQ LOW-MID]/[EQ HIGH-MID]/[EQ HIGH]</b> <b>[EQ LOW]/[EQ LOW-MID]/[EQ HIGH-MID]/[EQ HIGH] →</b> <b>[EQ LOW]/[EQ LOW-MID]/[EQ HIGH-MID]/[EQ HIGH] (Selected Channel mode)</b> <b>(in the Selected Channel mode) [EQ LOW]/[EQ LOW-MID]/[EQ HIGH-MID]/[EQ HIGH] (Band mode)</b>	lights	
Knobs 1 – 8 (Band mode)	For editing each frequency band.	—	
Faders (Band mode)	For editing the gain of each Band.	—	
[SHIFT]+DISPLAY [^/√]	Changes the EQ number.	—	*11
<b>DYNAMICS (Compressor) mode</b>	<b>[DYNAMICS]</b> <b>[DYNAMICS] → [DYNAMICS] (Selected Channel mode)</b>	lights	
[SHIFT]+DISPLAY [^/√]	Changes a DYN number.	—	*11
Knobs 1 – 8 (turning)	For editing parameters.	—	*18
Knobs 1 – 8 (pressing)	For editing parameters./Resets the parameter value to its default. *22	—	

■ **Digital Performer:** On the 01X, set Remote Select (page 87) in the Utility mode to “DP”

Button	Function	LED	Notes (page 114)
<b>In all modes:</b>			
[SHIFT]+[PAN]	Calls up the Mode list display.	—	
[SHIFT]+[NAME/VALUE]	Turns the Meter indication on or off.	—	
[SHIFT]+[REMOTE]	Enters the mode for Multi Part Editor Remote operation. Press [REMOTE] button to cancel the mode.	flashes	*5
[SEL] (in normal status)	Selects a channel.	lights/goes out	*2
[SHIFT]+[SEL] (in normal status)	Selects multiple channels.	lights/goes out	*2
[SEL] ([SEL] flashes)	Fader touch-out (page 15)	flashes → goes out	
[SEL] ([AUTO EDIT] lights)	Fader touch-in (page 15)	flashes	
[ON] (in normal status)	Turns each channel off or on (mutes/unmutes the signal).	lights/goes out	*2
[ON] ([SOLO] lights)	Sets Solo for each channel to on or off.	lights/goes out	*2
[ON] ([REC RDY] lights)	Sets the REC RDY of each channel to on or off.	lights/goes out	*2
[AUTO EDIT]	Changes the function of the [SEL] button to the touch-in function. This button flashes during automation touch-in.	lights	
[SOLO]	Changes the function of the [ON] button to the Solo function.	lights	
[REC RDY]	Changes the function of the [ON] button to the REC RDY function.	lights	
[AUTO R/W] (while being pressed)	Indicates the automation condition of the channel in the LCD. • READ..... Automation = TOUCH • READ..... Automation = LATCH	lights	*38
[AUTO R/W]+[SEL]	Switches the automation Read function on/off, and changes automation mode to Touch.	lights	*36
[GROUP] (while being pressed)	Indicates the Group to which the fader is assigned.	—	
[GROUP] and the currently lit [SEL]	Releases the Group assignment.	—	
[SHIFT]+[GROUP]	Assigns the selected channels to a Group.	—	
[AUDIO]/[INSTRUMENT]/[MIDI]/[BUS/AUX]/[OTHER]	Displays the Mixer window	—	
BANK [◀▶]	Scrolls through the track indication every eight channels.	—	
[SHIFT]+BANK [◀▶]	Scrolls through the track indication channel-by-channel.	—	
[LOOP]	Turns Loop on or off.	—	
[F1] – [F8]	No function	—	
[SHIFT]+[F1]	Displays the Track Overview.	—	
[SHIFT]+[F2]	Displays the Mixer window	—	
[SHIFT]+[F3]	Displays the Event List window for the selected channel.	—	*23
[SHIFT]+[F4]	Closes the current window.	—	
[SHIFT]+[F5]	Displays the MIDI Edit window.	—	*23, 24
[SHIFT]+[F6]	Displays the Sequencer Editor window.	—	
[SHIFT]+[F7]	Displays the Soundbites window.	—	
[SHIFT]+[F8]	No function	—	
[UNDO]	Executes the Undo operation.	—	
[SHIFT]+[UNDO]	Executes the Redo operation.	—	
[SAVE]	When the lamp lights, press this so that the lamp flashes. Press this again to execute the Save operation (lamp turns off).	lights → flashes → goes out	
[MARKER]	Turns the Marker on or off.	—	
[SHIFT]+[MARKER]	Opens the Marker Option window.	—	
[◀◀]	Press to continuously rewind. Press again to rewind more quickly. When the Marker is turned on, this operation moves the song position to the previous Marker.	—	
[SHIFT]+[◀◀]	Moves the song position to the top of the song.	—	
[▶▶]	Press to continuously fast-forward. Press again to fast-forward more quickly. When the Marker is turned on, this operation moves the song position to the next Marker.	—	
[■]	Stops recording or playback.	—	
[▶]	Press to start playback.	lights	
[●]	Press this to start song recording. The [▶] (Play) and [●] (Rec) lamp are turned on during recording.	lights	
[ZOOM]	Switches between Scroll (lamp lights), Zoom (lamp is off), and Nudge (lamp flashes).	goes out → lights → flashes	
FOOT SWITCH 1	Controls the function set in the Preferences in Digital Performer.	—	
FOOT SWITCH 2	Controls the function set in the Preferences in Digital Performer.	—	
[SCRUB]	Turns Scrub on and off. When turned on, you can use the dial to move the song position.	lights	*25

Button	Function	LED	Notes (page 114)
<b>PAN mode [PAN] ( or [SHIFT]+[PAN] → Knob)</b>		lights	*26
Knobs 1 – 8 (turning)	For editing parameters.	—	
Knobs 1 – 8 (pressing) (Surround Audio Channel)	Enters the PANNER Effect Edit mode. Press the [EDIT] button to return to the PAN mode.	—	
[SHIFT]+Knobs 1 – 8 (pressing)	Resets the edited parameter to the default value (center).	—	
[FLIP]	Switches the functions of the Channel Knobs and the Faders.	lights	*37
[PAN] in the PAN mode	Turns the Meter on or off.	—	
<b>SndVal mode [SEND] ( or [SHIFT]+[PAN] → Knob)</b>			*26
Knobs 1 – 8 (turning)	For editing parameters.	—	
DISPLAY [^/∨] Cursor [^/∨]	Changes the Send number.	—	*11
Knobs 1 – 8 (pressing)	Sets Mute to on or off.	—	
[SHIFT]+Knobs 1 – 8 (pressing)	Resets the parameter value to the default (0 dB).	—	
[FLIP]	Switches the functions of the Channel Knobs and the Faders.	lights	*37
[SEND] in the SndVal mode	Turns the Meter on or off.	—	
<b>SndOut mode [SHIFT]+[PAN] → Knobs</b>			
DISPLAY [^/∨] Cursor [^/∨]	Changes the Send number.	—	*11
Knobs 1 – 8 (turning)	Selects the bus for each Send of the track.	—	
Knobs 1 – 8 (pressing) (except when selecting a bus)	Switches between Send PRE and POST.	—	*26
<b>Input mode [SHIFT]+[PAN] → Knob</b>			
Knobs 1 – 8 (turning)	Selects an input bus for a track.	—	
<b>Output mode [SHIFT]+[PAN] → Knob</b>			
Knobs 1 – 8 (turning)	Selects an output bus for a track.	—	
<b>Effect mode [SHIFT]+[DYNAMICS] ( or [SHIFT]+[PAN] → Knob)</b>		[DYNAMICS] lights	*34
Knobs 1 – 8 (turning)	Selects a Plug-in Effect for each track.	—	
DISPLAY [^/∨] Cursor [^/∨]	Changes the Effect Number.	—	*11, 35
Knobs 1 – 8 (pressing)	Turns the Effect Bypass on or off. When the bus is turned on, X is indicated above the Effect name.	—	*19
[EQ LOW]/[EQ LOW-MID]/ [EQ HIGH-MID]/[EQ HIGH] +Knobs 1 – 8 (pressing)	Assigns the Parametric EQ to the corresponding track.	—	
[EDIT] (when any track is selected)	Enters the Plug-in Effect Edit mode. Press [EDIT] again to exit from the Edit mode.	lights/goes out	*21, 27, 35
<b>Effect Edit mode [SHIFT]+[PAN] → Knob</b>		[DYNAMICS] [EDIT] lights	*34
Knobs 1 – 8 (turning)	For editing parameters.	—	
DISPLAY [^/∨] Cursor [^/∨]	Changes an Effect Number.	—	*11
Cursor [</>]	Calls up the Effect of a different track.	—	
[SHIFT]+BANK [◀/▶]	Changes the parameters to be edited with the Knobs in order one by one.	—	
BANK [◀/▶]	Changes the parameters to be edited with the Knobs in groups of eight.	—	
[FLIP]	Switches the functions of the Channel Knobs and the Faders.	lights	*37
<b>Prefs mode [SHIFT]+[PAN] → Knob</b>		[DYNAMICS] [EDIT] lights	
Knobs 1 – 8 (pressing)	<ul style="list-style-type: none"> <li>LvlMtr..... Turns the Meter indication on or off. (the same as [SHIFT]+[NAME/VALUE])</li> <li>SrlTks ..... Determines whether the displayed tracks of the 01X and those of the mixing board in Digital Performer are synchronized or not.</li> <li>FtSwtc..... Switches between the footswitch assignments: PLAY/REC, or F5/F6 (on computer keyboard).</li> </ul>	—	
<b>No function</b>			
[WRITE] [F1] – [F8] [SHIFT]+[F8]			



- \*1 The normal condition is when the [AUTO R/W], [SOLO] and [REC RDY] button lamps are off.
- \*2 Not used or operable for the Master channel.
- \*3 The Multi Part Editor must be selected as the MIDI editor in SQ01 V2. (This is done from the Track view window by selecting [Set] → [Remote Control].)
- \*4 Only PAN is available in the R settings.
- \*5 The “GNRL RMT” (General Remote) setting must be selected, with the SHIFT + REMOTE function in Utility (page 87).
- \*6 The mute of the Master channel will be released.
- \*7 This does not reflect on the LED of the Master channel.
- \*8 When the [AUTO R/W] button is lit, the [ON] button of only the selected channel is lit.
- \*9 The LED lights when the appropriate track/object is shown in the Global View mode.
- \*10 When EQ 1 – 4 are being edited, the LED of each EQ button ([LOW], [LOW-MID], [HIGH-MID], [HIGH]) is lit. When the Track Parameter view is active, all four EQ buttons are lit.
- \*11 The following are not displayed on the 01X: Track, Slot, Plug-in, EQ, DYN, Send, and Effect number.
- \*12 This sometimes does not function in Nuendo.
- \*13 This does not function when a channel is being soloed.
- \*14 When the [AUTO R/W] button is lit, the [ON] button of only the selected channel is lit.
- \*15 This sometimes does not function in Cubase.
- \*16 Error messages may appear, depending on the MIDI-related settings.
- \*17 When the effect type to be assigned is changed, you may have to change the slot numbers, or you may have to return after moving temporarily to another page, in order to display the page number correctly.
- \*18 The editable parameters (numbers) differ depending on the assigned effect and the sound source of the software.
- \*19 This may not function depending on the particular version of the DAW software.
- \*20 The song position bar and playback position may sometimes not be synchronized while the scrub function is being used.
- \*21 Depending on the effect type, there are some effects whose parameters cannot be edited.
- \*22 This is ignored for parameters whose default values are not set.
- \*23 This is invalid in the Effect mode and Effect Edit mode.
- \*24 The MIDI Edit window of the top TRACK in the Track View window opens.
- \*25 This sometimes may not function properly.
- \*26 The edited data does not appear in the 01X display.
- \*27 The plug-in effect must be selected.
- \*28 Do not use any of the Remote Control functions while the DAW is executing some operation or performing some calculation/processing (for example, when a progress bar is being displayed, etc.). This may result in the LEDs not being lit correctly.
- \*29 Depending on the particular DAW software, turning the effects on/off and changing the effect type may be possible only from the computer.
- \*30 If the effect type cannot be changed by remote operation (when a message in the DAW software indicates you are attempting to apply an invalid effect, such as applying a mono effect for a stereo connection), you should change the effect from the computer.
- \*31 If you cannot control the level remotely after adding a MIDI track, adjust it once from the computer and try again.
- \*32 During automation, the LEDs may not light correctly.
- \*33 If the Scrub function does not work properly when it is on, turn it off.
- \*34 The particular plug-in effect you are using must be compatible with the Remote function.
- \*35 When the number of available pages is reduced when changing effects, make sure to select a valid page number for the new effect by using the DISPLAY [^/∨] (Up/Down) buttons beforehand.
- \*36 Even if you keep pressing the [SEL] button while holding down the [AUTO R/W] button, it will be ineffective from the second time. Press the [SEL] button after pressing the [AUTO R/W] button again.
- \*37 Do not use the Master STEREO fader while the Flip function is active.
- \*38 Make sure to use the Latch mode when recording mute on/off data to automation.
- \*39 When playing back song data for the first time after starting Cubase, the automation data and audio data may not be synchronized. Stop playback once and try playing back again.

# Appendix

## Parameter Lists

### ■ Preset EQ Library

No.	Preset Name	Description
1	Bass Drum 1	Emphasizes the low range of a bass drum and the attack created by the beater.
2	Bass Drum 2	Creates a peak around 80 Hz, producing a tight, stiff sound.
3	Snare Drum 1	Emphasizes “snappy” and rimshot sounds.
4	Snare Drum 2	Emphasizes various ranges for that classic rock snare drum sound.
5	Tom-tom 1	Emphasizes the attack of tom-toms, and creates a long, “leathery” decay.
6	Cymbal	Emphasizes the attack of crash cymbals, extending the “sparkling” decay.
7	High Hat	Use on a tight high-hat, emphasizing the mid to high range.
8	Percussion	Emphasizes attack and adds clarity to the high-range of instruments, such as shakers, cabasas, and congas.
9	E. Bass 1	Produces a tight electric bass sound by cutting very low frequencies.
10	E. Bass 2	Unlike preset 9, this preset emphasizes the low range of an electric bass.
11	Syn. Bass 1	Use on a synth bass with emphasized low range.
12	Syn. Bass 2	Emphasizes the attack that is peculiar to synth bass.
13	Piano 1	Makes pianos sound brighter.
14	Piano 2	Used in conjunction with a compressor, this preset emphasizes the attack and low range of pianos.
15	E. G. Clean	Use for line-level recording of an electric or semi-acoustic guitar to get a slightly harder sound.
16	E. G. Crunch 1	Adjusts the tonal quality of a slightly distorted guitar sound.
17	E. G. Crunch 2	A variation on preset 16.
18	E. G. Dist. 1	Makes a heavily distorted guitar sound clearer.
19	E. G. Dist. 2	A variation on preset 18.
20	A. G. Stroke 1	Emphasizes the bright tones of acoustic guitars.

No.	Preset Name	Description
21	A. G. Stroke 2	A variation on preset 20. You can also use it with an acoustic-electric nylon string guitar.
22	A. G. Arpeg. 1	Ideal for arpeggio playing on acoustic guitars.
23	A. G. Arpeg. 2	A variation on preset 22.
24	Brass Sec.	Use with trumpets, trombones, or saxes. When used with a single instrument, try adjusting the HIGH or HIGH-MID frequency.
25	Male Vocal 1	An EQ template for male vocals. Try adjusting the HIGH or HIGH-MID parameters according to the voice quality.
26	Male Vocal 2	A variation on preset 25.
27	Female Vo. 1	An EQ template for female vocals. Try adjusting the HIGH or HIGH-MID parameters according to the voice quality.
28	Female Vo. 2	A variation on preset 27.
29	Chorus&Harmo	An EQ template for brightening choruses.
30	Total EQ 1	Use on a stereo mix during mixdown. Sounds even better when used with a compressor.
31	Total EQ 2	A variation on preset 30.
32	Total EQ 3	A variation on preset 30. Can also be used with paired Input or Output Channels.
33	Bass Drum 3	A variation on preset 1, with low and mid range reduced.
34	Snare Drum 3	A variation on preset 3, creating a thicker sound.
35	Tom-tom 2	A variation on preset 5, emphasizing the mid and high ranges.
36	Piano 3	A variation on preset 13.
37	Piano Low	Emphasizes the low range of pianos recorded in stereo.
38	Piano High	Emphasizes the high range of pianos recorded in stereo.
39	Fine-EQ Cass	Add clarity when recording to or from cassette tape.
40	Narrator	Ideal for recording narration.

■ Preset EQ Parameters/Values

No.	Title	Parameter				
		LOW	LOW-MID	HIGH-MID	HIGH	
01	Bass Drum 1		PEAKING	PEAKING	PEAKING	H.SHELF
		G	+3.5 dB	-3.5 dB	0.0 dB	+4.0 dB
		F	100 Hz	265 Hz	1.06 kHz	5.30 kHz
		Q	1.2	10	0.9	—
02	Bass Drum 2		PEAKING	PEAKING	PEAKING	LPF
		G	+8.0 dB	-7.0 dB	+6.0 dB	ON
		F	80 Hz	400 Hz	2.50 kHz	12.5 kHz
		Q	1.4	4.5	2.2	—
03	Snare Drum 1		PEAKING	PEAKING	PEAKING	H.SHELF
		G	-0.5 dB	0.0 dB	+3.0 dB	+4.5 dB
		F	132 Hz	1.00 kHz	3.15 kHz	5.00 kHz
		Q	1.2	4.5	0.11	—
04	Snare Drum 2		L.SHELF	PEAKING	PEAKING	PEAKING
		G	+1.5 dB	-8.5 dB	+2.5 dB	+4.0 dB
		F	180 Hz	335 Hz	2.36 kHz	4.00 kHz
		Q	—	10	0.7	0.1
05	Tom-tom 1		PEAKING	PEAKING	PEAKING	PEAKING
		G	+2.0 dB	-7.5 dB	+2.0 dB	+1.0 dB
		F	212 Hz	670 Hz	4.50 kHz	6.30 kHz
		Q	1.4	10	1.2	0.28
06	Cymbal		L.SHELF	PEAKING	PEAKING	H.SHELF
		G	-2.0 dB	0.0 dB	0.0 dB	+3.0 dB
		F	106 Hz	425 Hz	1.06 kHz	13.2 kHz
		Q	—	8	0.9	—
07	High Hat		L.SHELF	PEAKING	PEAKING	H.SHELF
		G	-4.0 dB	-2.5 dB	+1.0 dB	+0.5 dB
		F	95 Hz	425 Hz	2.80 kHz	7.50 kHz
		Q	—	0.5	1	—
08	Percussion		L.SHELF	PEAKING	PEAKING	H.SHELF
		G	-4.5 dB	0.0 dB	+2.0 dB	0.0 dB
		F	100 Hz	400 Hz	2.80 kHz	17.0 kHz
		Q	—	4.5	0.56	—
09	E. Bass 1		L.SHELF	PEAKING	PEAKING	H.SHELF
		G	-7.5 dB	+4.5 dB	+2.5 dB	0.0 dB
		F	35.5 Hz	112 Hz	2.00 kHz	4.00 kHz
		Q	—	5	4.5	—
10	E. Bass 2		PEAKING	PEAKING	PEAKING	H.SHELF
		G	+3.0 dB	0.0 dB	+2.5 dB	+0.5 dB
		F	112 Hz	112 Hz	2.24 kHz	4.00 kHz
		Q	0.1	5	6.3	—
11	Syn. Bass 1		PEAKING	PEAKING	PEAKING	H.SHELF
		G	+3.5 dB	+8.5 dB	0.0 dB	0.0 dB
		F	85 Hz	950 Hz	4.00 kHz	12.5 kHz
		Q	0.1	8	4.5	—
12	Syn. Bass 2		PEAKING	PEAKING	PEAKING	H.SHELF
		G	+2.5 dB	0.0 dB	+1.5 dB	0.0 dB
		F	125 Hz	180 Hz	1.12 kHz	12.5 kHz
		Q	1.6	8	2.2	—

No.	Title	Parameter				
		LOW	LOW-MID	HIGH-MID	HIGH	
13	Piano 1		L.SHELF	PEAKING	PEAKING	H.SHELF
		G	-6.0 dB	0.0 dB	+2.0 dB	+4.0 dB
		F	95 Hz	950 Hz	3.15 kHz	7.50 kHz
		Q	—	8	0.9	—
14	Piano 2		PEAKING	PEAKING	PEAKING	H.SHELF
		G	+3.5 dB	-8.5 dB	+1.5 dB	+3.0 dB
		F	224 Hz	600 Hz	3.15 kHz	5.30 kHz
		Q	5.6	10	0.7	—
15	E. G. Clean		PEAKING	PEAKING	PEAKING	H.SHELF
		G	+2.0 dB	-5.5 dB	+0.5 dB	+2.5 dB
		F	265 Hz	400 Hz	1.32 kHz	4.50 kHz
		Q	0.18	10	6.3	—
16	E. G. Crunch 1		PEAKING	PEAKING	PEAKING	PEAKING
		G	+4.5 dB	0.0 dB	+4.0 dB	+2.0 dB
		F	140 Hz	1.00 kHz	1.90 kHz	5.60 kHz
		Q	8	4.5	0.63	9
17	E. G. Crunch 2		PEAKING	PEAKING	PEAKING	H.SHELF
		G	+2.5 dB	+1.5 dB	+2.5 dB	0.0 dB
		F	125 Hz	450 Hz	3.35 kHz	19.0 kHz
		Q	8	0.4	0.16	—
18	E. G. Dist. 1		L.SHELF	PEAKING	PEAKING	H.SHELF
		G	+5.0 dB	0.0 dB	+3.5 dB	0.0 dB
		F	355 Hz	950 Hz	3.35 kHz	12.5 kHz
		Q	—	9	10	—
19	E. G. Dist. 2		L.SHELF	PEAKING	PEAKING	H.SHELF
		G	+6.0 dB	-8.5 dB	+4.5 dB	+4.0 dB
		F	315 Hz	1.06 kHz	4.25 kHz	12.5 kHz
		Q	—	10	4	—
20	A. G. Stroke 1		PEAKING	PEAKING	PEAKING	H.SHELF
		G	-2.0 dB	0.0 dB	+1.0 dB	+4.0 dB
		F	106 Hz	1.00 kHz	1.90 kHz	5.30 kHz
		Q	0.9	4.5	3.5	—
21	A. G. Stroke 2		L.SHELF	PEAKING	PEAKING	H.SHELF
		G	-3.5 dB	-2.0 dB	0.0 dB	+2.0 dB
		F	300 Hz	750 Hz	2.00 kHz	3.55 kHz
		Q	—	9	4.5	—
22	A. G. Arpeg. 1		L.SHELF	PEAKING	PEAKING	PEAKING
		G	-0.5 dB	0.0 dB	0.0 dB	+2.0 dB
		F	224 Hz	1.00 kHz	4.00 kHz	6.70 kHz
		Q	—	4.5	4.5	0.12
23	A. G. Arpeg. 2		L.SHELF	PEAKING	PEAKING	H.SHELF
		G	0.0 dB	-5.5 dB	0.0 dB	+4.0 dB
		F	180 Hz	355 Hz	4.00 kHz	4.25 kHz
		Q	—	7	4.5	—
24	Brass Sec.		PEAKING	PEAKING	PEAKING	PEAKING
		G	-2.0 dB	-1.0 dB	+1.5 dB	+3.0 dB
		F	90 Hz	850 Hz	2.12 kHz	4.50 kHz
		Q	2.8	2	0.7	7

Before Using

Basics Section

Getting Started

Reference

Appendix

No.	Title	Parameter				
			LOW	LOW-MID	HIGH-MID	HIGH
25	Male Vocal 1		PEAKING	PEAKING	PEAKING	PEAKING
		G	-0.5 dB	0.0 dB	+2.0 dB	+3.5 dB
		F	190 Hz	1.00 kHz	2.00 kHz	6.70 kHz
		Q	0.11	4.5	0.56	0.11
26	Male Vocal 2		PEAKING	PEAKING	PEAKING	H.SHELF
		G	+2.0 dB	-5.0 dB	-2.5 dB	+4.0 dB
		F	170 Hz	236 Hz	2.65 kHz	6.70 kHz
		Q	0.11	10	5.6	—
27	Female Vo. 1		PEAKING	PEAKING	PEAKING	PEAKING
		G	-1.0 dB	+1.0 dB	+1.5 dB	+2.0 dB
		F	118 Hz	400 Hz	2.65 kHz	6.00 kHz
		Q	0.18	0.45	0.56	0.14
28	Female Vo. 2		L.SHELF	PEAKING	PEAKING	H.SHELF
		G	-7.0 dB	+1.5 dB	+1.5 dB	+2.5 dB
		F	112 Hz	335 Hz	2.00 kHz	6.70 kHz
		Q	—	0.16	0.2	—
29	Chorus & Harmo		PEAKING	PEAKING	PEAKING	PEAKING
		G	-2.0 dB	-1.0 dB	+1.5 dB	+3.0 dB
		F	90 Hz	850 Hz	2.12 kHz	4.50 kHz
		Q	2.8	2	0.7	7
30	Total EQ 1		PEAKING	PEAKING	PEAKING	H.SHELF
		G	-0.5 dB	0.0 dB	+3.0 dB	+6.5 dB
		F	95 Hz	950 Hz	2.12 kHz	16.0 kHz
		Q	7	2.2	5.6	—
31	Total EQ 2		PEAKING	PEAKING	PEAKING	H.SHELF
		G	+4.0 dB	+1.5 dB	+2.0 dB	+6.0 dB
		F	95 Hz	750 Hz	1.80 kHz	18.0 kHz
		Q	7	2.8	5.6	—
32	Total EQ 3		L.SHELF	PEAKING	PEAKING	H.SHELF
		G	+1.5 dB	+0.5 dB	+2.0 dB	+4.0 dB
		F	67 Hz	850 Hz	1.90 kHz	15.0 kHz
		Q	—	0.28	0.7	—

No.	Title	Parameter				
			LOW	LOW-MID	HIGH-MID	HIGH
33	Bass Drum 3		PEAKING	PEAKING	PEAKING	PEAKING
		G	+3.5 dB	-10.0 dB	+3.5 dB	0.0 dB
		F	118 Hz	315 Hz	4.25 kHz	20.0 kHz
		Q	2	10	0.4	0.4
34	Snare Drum 3		L.SHELF	PEAKING	PEAKING	PEAKING
		G	0.0 dB	+2.0 dB	+3.5 dB	0.0 dB
		F	224 Hz	560 Hz	4.25 kHz	4.00 kHz
		Q	—	4.5	2.8	0.1
35	Tom-tom 2		L.SHELF	PEAKING	PEAKING	H.SHELF
		G	-9.0 dB	+1.5 dB	+2.0 dB	0.0 dB
		F	90 Hz	212 Hz	5.30 kHz	17.0 kHz
		Q	—	4.5	1.2	—
36	Piano 3		PEAKING	PEAKING	PEAKING	H.SHELF
		G	+4.5 dB	-13.0 dB	+4.5 dB	+2.5 dB
		F	100 Hz	475 Hz	2.36 kHz	10.0 kHz
		Q	8	10	9	—
37	Piano Low		PEAKING	PEAKING	PEAKING	H.SHELF
		G	-5.5 dB	+1.5 dB	+6.0 dB	0.0 dB
		F	190 Hz	400 Hz	6.70 kHz	12.5 kHz
		Q	10	6.3	2.2	—
38	Piano High		PEAKING	PEAKING	PEAKING	PEAKING
		G	-5.5 dB	+1.5 dB	+5.0 dB	+3.0 dB
		F	190 Hz	400 Hz	6.70 kHz	5.60 kHz
		Q	10	6.3	2.2	0.1
39	Fine-EQ Cass		L.SHELF	PEAKING	PEAKING	H.SHELF
		G	-1.5 dB	0.0 dB	+1.0 dB	+3.0 dB
		F	75 Hz	1.00 kHz	4.00 kHz	12.5 kHz
		Q	—	4.5	1.8	—
40	Narrator		PEAKING	PEAKING	PEAKING	H.SHELF
		G	-4.0 dB	-1.0 dB	+2.0 dB	0.0 dB
		F	106 Hz	710 Hz	2.50 kHz	10.0 kHz
		Q	4	7	0.63	—

### ■ EQ Parameters

	LOW/HPF	LOW-MID	HIGH-MID	HIGH /LPF
Q	0.1–10.0 (41 points) low shelving HPF	0.1–10.0 (41 points)		0.1–10.0 (41 points) high shelving LPF
F	21.2 Hz–20 kHz (1/12 oct step)			
G	±18 dB (0.1 dB step) HPF: on/off	±18 dB (0.1 dB step)		±18 dB (0.1 dB step) LPF: on/off

## ■ Preset Dynamics Library

No.	Preset Name	Type	Description
1	Comp	COMP	Compressor for reducing the overall volume level. Use it on the stereo output during mixdown, or with paired Input or Output Channels.
2	Expand	EXPAND	Expander template.
3	Compander (H)	COMPAND-H	Hard-kneed compressor template.
4	Compander (S)	COMPAND-S	Soft-kneed compressor template.
5	A. Dr. BD	COMP	Compressor for use with acoustic bass drum.
6	A. Dr. BD	COMPAND-H	Hard-kneed compander for use with acoustic bass drum.
7	A. Dr. SN	COMP	Compressor for use with acoustic snare drum.
8	A. Dr. SN	EXPAND	Expander for use with acoustic snare drum.
9	A. Dr. SN	COMPAND-S	Soft-kneed compander for use with acoustic snare drum.
10	A. Dr. Tom	EXPAND	Expander for use with acoustic tom toms, which automatically reduces the volume when the tom toms are not played, improving mic separation.
11	A. Dr. OverTop	COMPAND-S	Soft-kneed compander for emphasizing the attack and ambience of cymbals recorded with overhead mics. It automatically reduces the volume when the cymbals are not played, improving mic separation.
12	E. B. Finger	COMP	Compressor for leveling the attack and volume of a finger-picked electric bass guitar.
13	E. B. Slap	COMP	Compressor for leveling the attack and volume of a slapped electric bass guitar.
14	Syn. Bass	COMP	Compressor for controlling or emphasizing the level of a synth bass.
15	Piano1	COMP	Compressor for brightening the tonal color of a piano.
16	Piano2	COMP	A variation on preset 15, using a deep threshold to change the overall attack and level.
17	E. Guitar	COMP	Compressor for electric guitar "cutting" or arpeggio-style backing. The sound color can be varied by playing different styles.
18	A. Guitar	COMP	Compressor for acoustic guitar "stroke" or arpeggio-style backing.
19	Strings1	COMP	Compressor for use with strings.
20	Strings2	COMP	A variation on preset 19, intended for violas or cellos.

No.	Preset Name	Type	Description
21	Strings3	COMP	A variation on preset 20, intended for string instruments with a very low range, such as cellos or contrabass.
22	BrassSection	COMP	Compressor for brass sounds with a fast and strong attack.
23	Syn. Pad	COMP	Compressor for musical instruments that feature gentle sounds which, depending on the tones, could diffuse, such as synth pad. Intended to prevent diffusion of the sound.
24	SamplingPerc	COMPAND-S	Compressor for making sampled percussion sound like real acoustic percussion.
25	Sampling BD	COMP	A variation on preset 24, intended for sampled bass drum sounds.
26	Sampling SN	COMP	A variation on preset 25, intended for sampled snare drum sounds.
27	Hip Comp	COMPAND-S	A variation on preset 26, intended for sampled loops and phrases.
28	Solo Vocal1	COMP	Compressor for use with main vocals.
29	Solo Vocal2	COMP	A variation on preset 28.
30	Chorus	COMP	A variation on preset 28, intended for choruses.
31	Click Erase	EXPAND	Expander for removing a click track that may bleed through from a musician's headphones.
32	Announcer	COMPAND-H	Hard-kneed compander for reducing the level of the music when an announcer speaks.
33	Limiter1	COMPAND-S	A soft-kneed compander with a slow release.
34	Limiter2	COMP	A "peak-stop" compressor.
35	Total Comp1	COMP	Compressor for reducing the overall volume level. Use it on the stereo output during mixdown, or with paired Input or Output Channels.
36	Total Comp2	COMP	A variation on preset 35, but with more compression.
37	Gate	GATE	Gate template
38	Ducking	DUCKING	Ducking template
39	A. Dr. BD	GATE	Gate preset for use with acoustic bass drums
40	A. Dr. SN	GATE	Gate preset for use with acoustic snare drums

## ■ Preset Dynamics Parameters/Values (fs=44.1kHz)

No.	Title	Type	Parameter	Value	No.	Title	Type	Parameter	Value
1	Comp	COMP	Threshold (dB)	-8	11	A. Dr. OverTop	COMPAND-S	Threshold (dB)	-24
			Ratio ( :1)	2.5				Ratio ( :1)	2
			Attack (ms)	60				Attack (ms)	38
			Out gain (dB)	0.0				Out gain (dB)	-3.5
			Knee	2				Width (dB)	54
			Release (ms)	250				Release (ms)	842
2	Expand	EXPAND	Threshold (dB)	-23	12	E. B. Finger	COMP	Threshold (dB)	-12
			Ratio ( :1)	1.7				Ratio ( :1)	2
			Attack (ms)	1				Attack (ms)	15
			Out gain (dB)	3.5				Out gain (dB)	4.5
			Knee	2				Knee	2
			Release (ms)	70				Release (ms)	470
3	Compander (H)	COMPAND-H	Threshold (dB)	-10	13	E. B. Slap	COMP	Threshold (dB)	-12
			Ratio ( :1)	3.5				Ratio ( :1)	1.7
			Attack (ms)	1				Attack (ms)	6
			Out gain (dB)	0.0				Out gain (dB)	4.0
			Width (dB)	6				Knee	hard
			Release (ms)	250				Release (ms)	133
4	Compander (S)	COMPAND-S	Threshold (dB)	-8	14	Syn. Bass	COMP	Threshold (dB)	-10
			Ratio ( :1)	4				Ratio ( :1)	3.5
			Attack (ms)	25				Attack (ms)	9
			Out gain (dB)	0.0				Out gain (dB)	3.0
			Width (dB)	24				Knee	hard
			Release (ms)	180				Release (ms)	250
5	A. Dr. BD	COMP	Threshold (dB)	-24	15	Piano1	COMP	Threshold (dB)	-9
			Ratio ( :1)	3				Ratio ( :1)	2.5
			Attack (ms)	9				Attack (ms)	17
			Out gain (dB)	5.5				Out gain (dB)	1.0
			Knee	2				Knee	hard
			Release (ms)	58				Release (ms)	238
6	A. Dr. BD	COMPAND-H	Threshold (dB)	-11	16	Piano2	COMP	Threshold (dB)	-18
			Ratio ( :1)	3.5				Ratio ( :1)	3.5
			Attack (ms)	1				Attack (ms)	7
			Out gain (dB)	-1.5				Out gain (dB)	6.0
			Width (dB)	7				Knee	2
			Release (ms)	192				Release (ms)	174
7	A. Dr. SN	COMP	Threshold (dB)	-17	17	E. Guitar	COMP	Threshold (dB)	-8
			Ratio ( :1)	2.5				Ratio ( :1)	3.5
			Attack (ms)	8				Attack (ms)	7
			Out gain (dB)	3.5				Out gain (dB)	2.5
			Knee	2				Knee	4
			Release (ms)	12				Release (ms)	261
8	A. Dr. SN	EXPAND	Threshold (dB)	-23	18	A. Guitar	COMP	Threshold (dB)	-10
			Ratio ( :1)	2				Ratio ( :1)	2.5
			Attack (ms)	0				Attack (ms)	5
			Out gain (dB)	0.5				Out gain (dB)	1.5
			Knee	2				Knee	2
			Release (ms)	151				Release (ms)	238
9	A. Dr. SN	COMPAND-S	Threshold (dB)	-8	19	Strings1	COMP	Threshold (dB)	-11
			Ratio ( :1)	1.7				Ratio ( :1)	2
			Attack (ms)	11				Attack (ms)	33
			Out gain (dB)	0.0				Out gain (dB)	1.5
			Width (dB)	10				Knee	2
			Release (ms)	128				Release (ms)	749
10	A. Dr. Tom	EXPAND	Threshold (dB)	-20	20	Strings2	COMP	Threshold (dB)	-12
			Ratio ( :1)	2				Ratio ( :1)	1.5
			Attack (ms)	2				Attack (ms)	93
			Out gain (dB)	5.0				Out gain (dB)	1.5
			Knee	2				Knee	4
			Release (ms)	749				Release (ms)	1.35 S

No.	Title	Type	Parameter	Value
21	Strings3	COMP	Threshold (dB)	-17
			Ratio ( :1)	1.5
			Attack (ms)	76
			Out gain (dB)	2.5
			Knee	2
			Release (ms)	186
22	BrassSection	COMP	Threshold (dB)	-18
			Ratio ( :1)	1.7
			Attack (ms)	18
			Out gain (dB)	4.0
			Knee	1
			Release (ms)	226
23	Syn. Pad	COMP	Threshold (dB)	-13
			Ratio ( :1)	2
			Attack (ms)	58
			Out gain (dB)	2.0
			Knee	1
			Release (ms)	238
24	SamplingPerc	COMPAND-S	Threshold (dB)	-18
			Ratio ( :1)	1.7
			Attack (ms)	8
			Out gain (dB)	-2.5
			Width (dB)	18
			Release (ms)	238
25	Sampling BD	COMP	Threshold (dB)	-14
			Ratio ( :1)	2
			Attack (ms)	2
			Out gain (dB)	3.5
			Knee	4
			Release (ms)	35
26	Sampling SN	COMP	Threshold (dB)	-18
			Ratio ( :1)	4
			Attack (ms)	8
			Out gain (dB)	8.0
			Knee	hard
			Release (ms)	354
27	Hip Comp	COMPAND-S	Threshold (dB)	-23
			Ratio ( :1)	20
			Attack (ms)	15
			Out gain (dB)	0.0
			Width (dB)	15
			Release (ms)	163
28	Solo Vocal1	COMP	Threshold (dB)	-20
			Ratio ( :1)	2.5
			Attack (ms)	31
			Out gain (dB)	2.0
			Knee	1
			Release (ms)	342
29	Solo Vocal2	COMP	Threshold (dB)	-8
			Ratio ( :1)	2.5
			Attack (ms)	26
			Out gain (dB)	1.5
			Knee	3
			Release (ms)	331
30	Chorus	COMP	Threshold (dB)	-9
			Ratio ( :1)	1.7
			Attack (ms)	39
			Out gain (dB)	2.5
			Knee	2
			Release (ms)	226

No.	Title	Type	Parameter	Value
31	Click Erase	EXPAND	Threshold (dB)	-33
			Ratio ( :1)	2
			Attack (ms)	1
			Out gain (dB)	2.0
			Knee	2
			Release (ms)	284
32	Announcer	COMPAND-H	Threshold (dB)	-14
			Ratio ( :1)	2.5
			Attack (ms)	1
			Out gain (dB)	-2.5
			Width (dB)	18
			Release (ms)	180
33	Limiter1	COMPAND-S	Threshold (dB)	-9
			Ratio ( :1)	3
			Attack (ms)	20
			Out gain (dB)	-3.0
			Width (dB)	90
			Release (ms)	3.91 s
34	Limiter2	COMP	Threshold (dB)	0
			Ratio ( :1)	∞
			Attack (ms)	0
			Out gain (dB)	0.0
			Knee	hard
			Release (ms)	319
35	Total Comp1	COMP	Threshold (dB)	-18
			Ratio ( :1)	3.5
			Attack (ms)	94
			Out gain (dB)	2.5
			Knee	hard
			Release (ms)	447
36	Total Comp2	COMP	Threshold (dB)	-16
			Ratio ( :1)	6
			Attack (ms)	11
			Out gain (dB)	6.0
			Knee	1
			Release (ms)	180
37	Gate	GATE	Threshold (dB)	-26
			Range (dB)	-56
			Attack (ms)	0
			Hold (ms)	2.56
			Decay (ms)	331
38	Ducking	DUCKING	Threshold (dB)	-19
			Range (dB)	-22
			Attack (ms)	93
			Hold (ms)	1.20 S
			Decay (ms)	6.32 S
39	A. Dr. BD	GATE	Threshold (dB)	-11
			Range (dB)	-53
			Attack (ms)	0
			Hold (ms)	1.93
			Decay (ms)	400
40	A. Dr. SN	GATE	Threshold (dB)	-8
			Range (dB)	-23
			Attack (ms)	1
			Hold (ms)	0.63
			Decay (ms)	238



## ■ Dynamics Parameters

<b>Compressor</b>	Threshold	-54 dB–0 dB (0.1 dB step)
	Ratio (x :1)	x=1, 1.1, 1.3, 1.5, 1.7, 2, 2.5, 3, 3.5, 4, 5, 6, 8, 10, 20, ∞ (16 points)
	Out gain	0 dB to +18 dB (0.1 dB step)
	Knee	Hard, 1, 2, 3, 4, 5 (6 points)
	Attack	0 ms–120 ms (1 ms step)
	Release	6 ms–46.1 s (160 points) @ 44.1 kHz
		5 ms–42.3 s (160 points) @ 48 kHz
3 ms–23.0 s (160 points) @ 88.2 kHz		
3 ms–21.2 s (160 points) @ 96 kHz		
<b>Expander</b>	Threshold	-54 dB to 0 dB (0.1 dB step)
	Ratio (x :1)	x=1, 1.1, 1.3, 1.5, 1.7, 2, 2.5, 3, 3.5, 4, 5, 6, 8, 10, 20, ∞ (16 points)
	Out gain	0 dB to +18 dB (0.1 dB step)
	Knee	Hard, 1, 2, 3, 4, 5 (6 points)
	Attack	0 ms–120 ms (1 ms step)
	Release	6 ms–46.1 s (160 points) @ 44.1 kHz
		5 ms–42.3 s (160 points) @ 48 kHz
3 ms–23.0 s (160 points) @ 88.2 kHz		
3 ms–21.2 s (160 points) @ 96 kHz		
<b>Compander H</b>	Threshold	-54 dB to 0 dB (0.1 dB step)
	Ratio (x :1)	x=1, 1.1, 1.3, 1.5, 1.7, 2, 2.5, 3, 3.5, 4, 5, 6, 8, 10, 20 (15 points)
	Out gain	-18 dB to 0 dB (0.1 dB step)
	Width	1 dB–90 dB (1 dB step)
	Attack	0 ms–120 ms (1 ms step)
	Release	6 ms–46.1 s (160 points) @ 44.1 kHz
		5 ms–42.3 s (160 points) @ 48 kHz
3 ms–23.0 s (160 points) @ 88.2 kHz		
3 ms–21.2 s (160 points) @ 96 kHz		
<b>Compander S</b>	Threshold	-54 dB to 0 dB (0.1 dB step)
	Ratio (x :1)	x=1, 1.1, 1.3, 1.5, 1.7, 2, 2.5, 3, 3.5, 4, 5, 6, 8, 10, 20 (15 points)
	Out gain	-18 dB to 0 dB (0.1 dB step)
	Width	1 dB–90 dB (1 dB step)
	Attack	0 ms–120 ms (1 ms step)
	Release	6 ms–46.1 s (160 points) @ 44.1 kHz
		5 ms–42.3 s (160 points) @ 48 kHz
3 ms–23.0 s (160 points) @ 88.2 kHz		
3 ms–21.2 s (160 points) @ 96 kHz		
<b>Ducking</b>	Threshold	-54 dB–0 dB (0.1 dB step)
	Range	-70 dB–0 dB (1 dB step)
	Attack	0 ms–120 ms (1 ms step)
	Hold	0.02 ms–2.13 s (216 points) @ 44.1 kHz
		0.02 ms–1.96 s (216 points) @ 48 kHz
		0.01 ms–1.07 s (216 points) @ 88.2 kHz
		0.01 ms–980 ms (216 points) @ 96 kHz
Decay	6 ms–46.1 s (160 points) @ 44.1 kHz	
	5 ms–42.3 s (160 points) @ 48 kHz	
	3 ms–23.0 s (160 points) @ 88.2 kHz	
	3 ms–21.2 s (160 points) @ 96 kHz	
<b>Gate</b>	Threshold	-54 dB–0 dB (0.1 dB step)
	Range	-70 dB–0 dB (1 dB step)
	Attack	0 ms–120 ms (1 ms step)
	Hold	0.02 ms–2.13 s (216 points) @ 44.1 kHz
		0.02 ms–1.96 s (216 points) @ 48 kHz
		0.01 ms–1.07 s (216 points) @ 88.2 kHz
		0.01 ms–980 ms (216 points) @ 96 kHz
Decay	6 ms–46.1 s (160 points) @ 44.1 kHz	
	5 ms–42.3 s (160 points) @ 48 kHz	
	3 ms–23.0 s (160 points) @ 88.2 kHz	
	3 ms–21.2 s (160 points) @ 96 kHz	

## Explanations for Dynamics Parameters

### Compressor

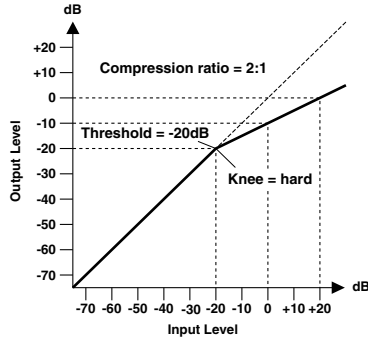

A compressor provides a form of automatic level control. By attenuating high levels, thus effectively reducing the dynamic range, the compressor makes it much easier to control signals and set appropriate fader levels. Reducing the dynamic range also means that recording levels can be set higher, therefore improving the signal-to-noise performance.

#### ● Compressor (CMP) parameters:

**Threshold (THRESH)** determines the level of input signal required to trigger the compressor. Signals at a level below the threshold pass through unaffected. Signals at and above the threshold level are compressed by the amount specified using the Ratio parameter.

**Ratio** controls the amount of compression — the change in output signal level relative to change in input signal level. With a 2:1 ratio, for example, a 10 dB change in input level (above the threshold) results in a 5 dB change in output level. For a 5:1 ratio, a 10 dB change in input level (above the threshold) results in a 2 dB change in output level.

**Attack** controls how soon the signal is compressed once the compressor has been triggered. With a fast attack time, the signal is compressed almost immediately. With a slow attack time, the initial transient of a sound passes through unaffected.

**Release** determines how soon the compressor returns to its normal gain once the trigger signal level drops below the threshold. If the release time is too short, the gain will recover too quickly causing level pumping — noticeable gain fluctuations. If it is set too long, the compressor may not have time to recover before the next high level signal appears, and it will be compressed incorrectly.

**Out Gain (GAIN)** sets the compressor's output signal level. Compression tends to reduce the average signal level. Out Gain can be used to counter this level reduction and set an appropriate level for the next stage in the audio path.

**Knee** sets the transition of the signal at the threshold. With a hard knee, the transition between uncompressed and compressed signal is immediate. With the softest knee, knee5, the transition starts before the signal reaches the threshold and gradually ends above the threshold.

### Expander

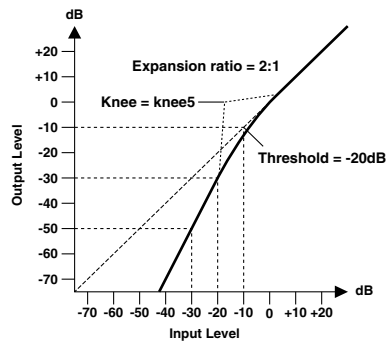
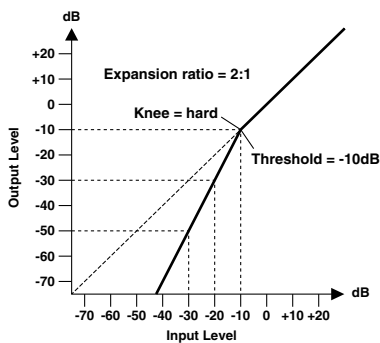

An expander is another form of automatic level control. By attenuating the signal below the threshold, the expander reduces low-level noise and effectively increases the dynamic range of the recorded material.

### ● Expander (EXP) parameters:

**Threshold (THRESH)** determines the level of input signal required to trigger the expander. Signals above the threshold pass through unaffected. Signals at and below the threshold level are attenuated by the amount specified using the Ratio parameter.

**Ratio** controls the amount of expansion — the change in output signal level relative to change in input signal level. With a 2:1 ratio, for example, a 5 dB change in input level (below the threshold) results in a 10 dB change in output level. For a 5:1 ratio, a 2 dB change in input level (below the threshold) results in a 10 dB change in output level.

**Attack** controls how soon the signal is expanded once the expander has been triggered. With a fast attack time, the signal is expanded almost immediately. With a slow attack time, the initial transient of a sound passes through unaffected.

**Release** determines how soon the expander returns to its normal gain once the trigger signal level drops below the threshold.

**Out Gain (GAIN)** sets the expander's output signal level.

**Knee** sets the transition of the signal at the threshold. With a hard knee, the transition between unexpanded and expanded signal is immediate. With the softest knee, *knee5*, the transition starts before the signal reaches the threshold and gradually ends above the threshold.

## Compander

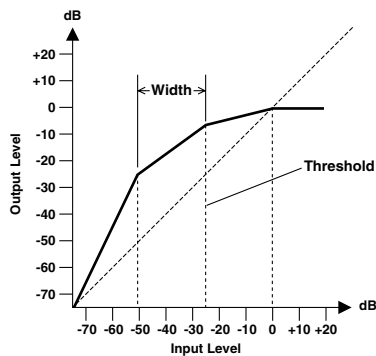

A compander is a compressor-expander — a combination of signal compression and expansion. The compander attenuates the input signal above the threshold as well as the level below the width. For very dynamic material, this program allows you to retain the dynamic range without having to be concerned with excessive output signal levels and clipping. This functions as a limiter when the input level exceeds 0 dB.

### ● CompanderH (CPH) and CompanderS (CPS) parameters:

**Threshold (THRESH)** determines the level of input signal required to trigger the compander. Signals above the threshold pass through unaffected. Signals at and below the threshold level are attenuated by the amount specified using the Ratio parameter.

**Ratio** controls the amount of companding — the change in output signal level relative to change in input signal level. With a 2:1 ratio, for example, a 10 dB change in input level (above the threshold) results in a 5 dB change in output level. The hard compander (CPH) has a fixed ratio of 5:1 for expansion and the soft compander (CPS) has a fixed ratio of 1.5:1 for expansion.

**Attack** controls how soon the signal is companded once the compander has been triggered. With a fast attack time, the signal is companded almost immediately. With a slow attack time, the initial transient of a sound passes through unaffected.

**Release** determines how soon the compander returns to its normal gain once the trigger signal level drops below the threshold.

**Out Gain (GAIN)** sets the compander's output signal level. Since the gain or level of the sound increases depending on the Threshold and Ratio settings, use this to adjust the overall sound output.

**Width** is used to determine the distance, in decibels, between the expander and the compressor. With a width of 90 dB, the expander is effectively switched off and the compander is simply a compressor-limiter. With a smaller width (30 dB) and a high threshold (0 dB), the compander is an expander-compressor-limiter.

## Gate and Ducking

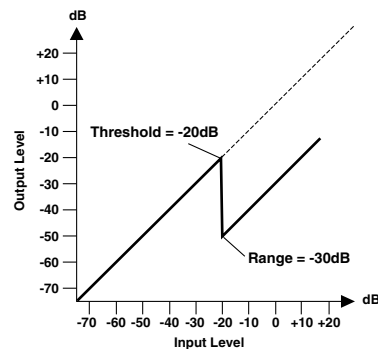
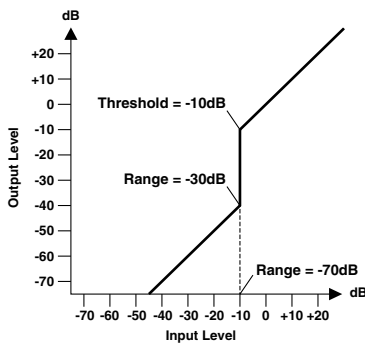

A gate, or noise gate is an audio switch used to mute signals below a set threshold level. It can be used to suppress background noise and hiss from valve (tube) amps, effects pedals, and microphones.

Ducking is used to automatically reduce the levels of one signal when the level of a source signal exceeds a specified threshold. It is used for voice-over applications where, for example, level of background music is automatically reduced, allowing an announcer to be heard clearly.

### ● Gate (GAT) and Ducking (DUK) parameters:

**Threshold (THRESH)** sets the level at which the gate closes, cutting off the signal. Signals above the threshold level pass through unaffected. Signals at or below the threshold cause the gate to close.

For ducking, trigger signal levels at and above the threshold level activate ducking, and the signal level is reduced to a level set by the Range parameter.

The trigger signal is determined using the **KEY-IN** parameter.

**Range** controls the level to which the gate closes. It can be used to reduce the signal level rather than cut it completely. At a setting of  $-70$  dB, the gate closes completely when the input signal falls below the threshold. At a setting of  $-30$  dB, the gate only closes so far allowing an attenuated signal through. At a setting of  $0$  dB, the gate has no effect. When signals are gated abruptly, the sudden cutoff can sound odd.

For ducking, a setting of  $-70$  dB causes the signal to be virtually cutoff. At a setting of  $-30$  dB the signal is ducked by  $30$  dB. At a setting of  $0$  dB, the duck has no effect.

**Attack** determines how fast the gate opens when the signal exceeds the threshold level. Slow attack times can be used to remove the initial transient edge of percussive sounds. Too slow an attack time makes some signals sound backwards.

For ducking, this controls how soon the signal is ducked once the duck has been triggered. With a fast attack time, the signal is ducked almost immediately. With a slow attack time, ducking fades the signal. Too fast an attack time may sound abrupt.

**Hold** sets how long the gate stays open or the ducking remains active once the trigger signal has fallen below the threshold level.

**Decay** controls how fast the gate closes once the hold time has expired. A longer decay time produces a more natural gating effect, allowing the natural decay of an instrument to pass through.

For ducking, this determines how soon the ducker returns to its normal gain after the hold time has expired.

## ■ Preset Effects Library

### ● Reverbs

No.	Preset Name/ Types	Description
1	Reverb Hall	Concert hall reverberation simulation with gate
2	Reverb Room	Room reverberation simulation with gate
3	Reverb Stage	Reverb designed for vocals, with gate
4	Reverb Plate	Plate reverb simulation with gate
5	Early Ref.	Early reflections without the subsequent reverb
6	Gate Reverb	Gated early reflections
7	Reverse Gate	Gated reverse early reflections

### ● Delays

No.	Preset Name/ Types	Description
8	Mono Delay	Simple mono delay
9	Stereo Delay	Simple stereo delay
10	Mod.delay	Simple repeat delay with modulation
11	Delay LCR	3-tap (left, center, right) delay
12	Echo	Stereo delay with crossed left/right feedback

### ● Modulation-based Effects

No.	Preset Name/ Types	Description
13	Chorus	Chorus
14	Flange	Flanger
15	Symphonic	Proprietary Yamaha effect that produces a richer and more complex modulation than normal chorus
16	Phaser	16-stage stereo phase shifter
17	Auto Pan	Auto-panner
18	Tremolo	Tremolo
19	HQ.Pitch	Mono pitch shifter, producing stable results
20	Dual Pitch	Stereo pitch shifter
21	Rotary	Rotary speaker simulation
22	Ring Mod.	Ring modulator
23	Mod.Filter	Modulated filter

### ● Guitar Effects

No.	Preset Name/ Types	Description
24	Distortion	Distortion
25	Amp Simulate	Guitar amp simulation

### ● Dynamic Effects

No.	Preset Name/ Types	Description
26	Dyna.Filter	Dynamically controlled filter
27	Dyna.Flange	Dynamically controlled flanger
28	Dyna.Phaser	Dynamically controlled phase shifter

### ● Combination Effects

No.	Preset Name/ Types	Description
29	Rev+Chorus	Reverb and chorus in parallel
30	Rev->Chorus	Reverb and chorus in series
31	Rev+Flange	Reverb and flanger in parallel
32	Rev->Flange	Reverb and flanger in series
33	Rev+Sympho.	Reverb and symphonic in parallel
34	Rev->Sympho.	Reverb and symphonic in series
35	Rev->Pan	Reverb and auto-pan in series
36	Delay+ER.	Delay and early reflections in parallel
37	Delay->ER.	Delay and early reflections in series
38	Delay+Rev	Delay and reverb in parallel
39	Delay->Rev	Delay and reverb in series
40	Dist->Delay	Distortion and delay in series

### ● Others

No.	Preset Name/ Types	Description
41	Multi.Filter	3-band parallel filter (24 dB/octave)
42	Stereo Reverb	Stereo reverb
43	M.Band Dyna.	3-band dynamics processor

## ■ Effects Parameters

### ● REVERB HALL, REVERB ROOM, REVERB STAGE, REVERB PLATE

One input, two output hall, room, stage, and plate reverb simulations, all with gates.

Parameter	Range	Description
REV TIME	0.3–99.0 s	Reverb time
INI. DLY	0.0–500.0 ms	Initial delay before reverb begins
HI. RATIO	0.1–1.0	High-frequency reverb time ratio
LO. RATIO	0.1–2.4	Low-frequency reverb time ratio
DIFF.	0–10	Reverb diffusion (left–right reverb spread)
DENSITY	0–100%	Reverb density
E/R DLY	0.0–100.0 ms	Delay between early reflections and reverb
E/R BAL.	0–100%	Balance of early reflections and reverb (0% = all reverb, 100% = all early reflections)
HPF	THRU, 21.2 Hz–8.00 kHz	High-pass filter cutoff frequency
LPF	50.0 Hz–16.0 kHz, THRU	Low-pass filter cutoff frequency
GATE LVL	OFF, –60 to 0 dB	Level at which gate kicks in
ATTACK	0–120 ms	Gate opening speed
HOLD	*1	Gate open time
DECAY	*2	Gate closing speed

\*1. 0.02 ms–2.13 s (fs=44.1 kHz), 0.02 ms–1.96 s (fs=48 kHz), 0.01 ms–1.06 s (fs=88.2 kHz), 0.01 ms–981 ms (fs=96 kHz)

\*2. 6 ms–46.0 s (fs=44.1 kHz), 5 ms–42.3 s (fs=48 kHz), 3 ms–23.0 s (fs=88.2 kHz), 3 ms–21.1 s (fs=96 kHz)

### ● EARLY REF.

One input, two output early reflections.

Parameter	Range	Description
TYPE	S-Hall, L-Hall, Random, Revers, Plate, Spring	Type of early reflection simulation
ROOMSIZE	0.1–20.0	Reflection spacing
LIVENESS	0–10	Early reflections decay characteristics (0 = dead, 10 = live)
INI. DLY	0.0–500.0 ms	Initial delay before reverb begins
DIFF.	0–10	Reflection diffusion (left–right reflection spread)
DENSITY	0–100%	Reflection density
ER NUM.	1–19	Number of early reflections
FB.GAIN	–99 to +99%	Feedback gain
HI. RATIO	0.1–1.0	High-frequency feedback ratio
HPF	THRU, 21.2 Hz–8.00 kHz	High-pass filter cutoff frequency
LPF	50.0 Hz–16.0 kHz, THRU	Low-pass filter cutoff frequency

### ● GATE REVERB, REVERSE GATE

One input, two output early reflections with gate, and early reflections with reverse gate.

Parameter	Range	Description
TYPE	Type-A, Type-B	Type of early reflection simulation
ROOMSIZE	0.1–20.0	Reflection spacing
LIVENESS	0–10	Early reflections decay characteristics (0 = dead, 10 = live)
INI. DLY	0.0–500.0 ms	Initial delay before reverb begins
DIFF.	0–10	Reflection diffusion (left–right reflection spread)
DENSITY	0–100%	Reflection density
ER NUM.	1–19	Number of early reflections
FB.GAIN	–99 to +99%	Feedback gain
HI. RATIO	0.1–1.0	High-frequency feedback ratio
HPF	THRU, 21.2 Hz–8.00 kHz	High-pass filter cutoff frequency
LPF	50.0 Hz–16.0 kHz, THRU	Low-pass filter cutoff frequency

### ● MONO DELAY

One input, two output basic repeat delay.

Parameter	Range	Description
<b>DELAY</b>	0.0–2730.0 ms	Delay time
<b>FB. GAIN</b>	–99 to +99%	Feedback gain (plus values for normal-phase feedback, minus values for reverse-phase feedback)
<b>HI. RATIO</b>	0.1–1.0	High-frequency feedback ratio
<b>HPF</b>	THRU, 21.2 Hz–8.00 kHz	High-pass filter cutoff frequency
<b>LPF</b>	50.0 Hz–16.0 kHz, THRU	Low-pass filter cutoff frequency

### ● STEREO DELAY

Two input, two output basic stereo delay.

Parameter	Range	Description
<b>DELAY L</b>	0.0–1350.0 ms	Left channel delay time
<b>DELAY R</b>	0.0–1350.0 ms	Right channel delay time
<b>FB. G L</b>	–99 to +99%	Left channel feedback (plus values for normal-phase feedback, minus values for reverse-phase feedback)
<b>FB. G R</b>	–99 to +99%	Right channel feedback (plus values for normal-phase feedback, minus values for reverse-phase feedback)
<b>HI. RATIO</b>	0.1–1.0	High-frequency feedback ratio
<b>HPF</b>	THRU, 21.2 Hz–8.00 kHz	High-pass filter cutoff frequency
<b>LPF</b>	50.0 Hz–16.0 kHz, THRU	Low-pass filter cutoff frequency

### ● MOD. DELAY

One input, two output basic repeat delay with modulation.

Parameter	Range	Description
<b>DELAY</b>	0.0–2725.0 ms	Delay time
<b>FB. GAIN</b>	–99 to +99%	Feedback gain (plus values for normal-phase feedback, minus values for reverse-phase feedback)
<b>HI. RATIO</b>	0.1–1.0	High-frequency feedback ratio
<b>FREQ.</b>	0.05–40.00 Hz	Modulation speed
<b>DEPTH</b>	0–100%	Modulation depth
<b>WAVE</b>	Sine, Tri	Modulation waveform
<b>HPF</b>	THRU, 21.2 Hz–8.00 kHz	High-pass filter cutoff frequency
<b>LPF</b>	50.0 Hz–16.0 kHz, THRU	Low-pass filter cutoff frequency

### ● DELAY LCR

One input, two output 3-tap delay (left, center, right).

Parameter	Range	Description
<b>DELAY L</b>	0.0–2730.0 ms	Left channel delay time
<b>DELAY C</b>	0.0–2730.0 ms	Center channel delay time
<b>DELAY R</b>	0.0–2730.0 ms	Right channel delay time
<b>FB. DLY</b>	0.0–2730.0 ms	Feedback delay time
<b>LEVEL L</b>	–100 to +100%	Left channel delay level
<b>LEVEL C</b>	–100 to +100%	Center channel delay level
<b>LEVEL R</b>	–100 to +100%	Right channel delay level
<b>FB. GAIN</b>	–99 to +99%	Feedback gain (plus values for normal-phase feedback, minus values for reverse-phase feedback)
<b>HI. RATIO</b>	0.1–1.0	High-frequency feedback ratio
<b>HPF</b>	THRU, 21.2 Hz–8.00 kHz	High-pass filter cutoff frequency
<b>LPF</b>	50.0 Hz–16.0 kHz, THRU	Low-pass filter cutoff frequency



### ● ECHO

Two input, two output stereo delay with crossed feedback loop.

Parameter	Range	Description
DELAY L	0.0–1350.0 ms	Left channel delay time
DELAY R	0.0–1350.0 ms	Right channel delay time
FB.DLY L	0.0–1350.0 ms	Left channel feedback delay time
FB.DLY R	0.0–1350.0 ms	Right channel feedback delay time
FB. G L	–99 to +99%	Left channel feedback gain (plus values for normal-phase feedback, minus values for reverse-phase feedback)
FB. G R	–99 to +99%	Right channel feedback gain (plus values for normal-phase feedback, minus values for reverse-phase feedback)
L->R FBG	–99 to +99%	Left to right channel feedback gain (plus values for normal-phase feedback, minus values for reverse-phase feedback)
R->L FBG	–99 to +99%	Right to left channel feedback gain (plus values for normal-phase feedback, minus values for reverse-phase feedback)
HI. RATIO	0.1–1.0	High-frequency feedback ratio
HPF	THRU, 21.2 Hz–8.00 kHz	High-pass filter cutoff frequency
LPF	50.0 Hz–16.0 kHz, THRU	Low-pass filter cutoff frequency

### ● CHORUS

Two input, two output chorus effect.

Parameter	Range	Description
FREQ.	0.05–40.00 Hz	Modulation speed
AM DEPTH	0–100%	Amplitude modulation depth
PM DEPTH	0–100%	Pitch modulation depth
MOD. DLY	0.0–500.0 ms	Modulation delay time
WAVE	Sine, Tri	Modulation waveform
LSH F	21.2 Hz–8.00 kHz	Low shelving filter frequency
LSH G	–12.0 to +12.0 dB	Low shelving filter gain
EQ F	100 Hz–8.00 kHz	EQ (peaking type) frequency
EQ G	–12.0 to +12.0 dB	EQ (peaking type) gain
EQ Q	10.0–0.10	EQ (peaking type) bandwidth
HSH F	50.0 Hz–16.0 kHz	High shelving filter frequency
HSH G	–12.0 to +12.0 dB	High shelving filter gain

### ● FLANGE

Two input, two output flange effect.

Parameter	Range	Description
FREQ.	0.05–40.00 Hz	Modulation speed
DEPTH	0–100%	Modulation depth
MOD. DLY	0.0–500.0 ms	Modulation delay time
FB. GAIN	–99 to +99%	Feedback gain (plus values for normal-phase feedback, minus values for reverse-phase feedback)
WAVE	Sine, Tri	Modulation waveform
LSH F	21.2 Hz–8.00 kHz	Low shelving filter frequency
LSH G	–12.0 to +12.0 dB	Low shelving filter gain
EQ F	100 Hz–8.00 kHz	EQ (peaking type) frequency
EQ G	–12.0 to +12.0 dB	EQ (peaking type) gain
EQ Q	10.0–0.10	EQ (peaking type) bandwidth
HSH F	50.0 Hz–16.0 kHz	High shelving filter frequency
HSH G	–12.0 to +12.0 dB	High shelving filter gain

### ● SYMPHONIC

Two input, two output symphonic effect.

Parameter	Range	Description
FREQ.	0.05–40.00 Hz	Modulation speed
DEPTH	0–100%	Modulation depth
MOD. DLY	0.0–500.0 ms	Modulation delay time
WAVE	Sine, Tri	Modulation waveform
LSH F	21.2 Hz–8.00 kHz	Low shelving filter frequency
LSH G	–12.0 to +12.0 dB	Low shelving filter gain
EQ F	100 Hz–8.00 kHz	EQ (peaking type) frequency
EQ G	–12.0 to +12.0 dB	EQ (peaking type) gain
EQ Q	10.0–0.10	EQ (peaking type) bandwidth
HSH F	50.0 Hz–16.0 kHz	High shelving filter frequency
HSH G	–12.0 to +12.0 dB	High shelving filter gain

### ● PHASER

Two input, two output 16-stage phaser.

Parameter	Range	Description
FREQ.	0.05–40.00 Hz	Modulation speed
DEPTH	0–100%	Modulation depth
FB. GAIN	–99 to +99%	Feedback gain (plus values for normal-phase feedback, minus values for reverse-phase feedback)
OFFSET	0–100	Lowest phase-shifted frequency offset
PHASE	0.00–354.38 degrees	Left and right modulation phase balance
STAGE	2, 4, 6, 8, 10, 12, 14, 16	Number of phase shift stages
LSH F	21.2 Hz–8.00 kHz	Low shelving filter frequency
LSH G	–12.0 to +12.0 dB	Low shelving filter gain
HSH F	50.0 Hz–16.0 kHz	High shelving filter frequency
HSH G	–12.0 to +12.0 dB	High shelving filter gain

### ● AUTO PAN

Two input, two output autopanner.

Parameter	Range	Description
FREQ.	0.05–40.00 Hz	Modulation speed
DEPTH	0–100%	Modulation depth
DIR.	*1	Panning direction
WAVE	Sine, Tri, Square	Modulation waveform
LSH F	21.2 Hz–8.00 kHz	Low shelving filter frequency
LSH G	–12.0 to +12.0 dB	Low shelving filter gain
EQ F	100 Hz–8.00 kHz	EQ (peaking type) frequency
EQ G	–12.0 to +12.0 dB	EQ (peaking type) gain
EQ Q	10.0–0.10	EQ (peaking type) bandwidth
HSH F	50.0 Hz–16.0 kHz	High shelving filter frequency
HSH G	–12.0 to +12.0 dB	High shelving filter gain

\*1. L<->R, L->R, L<-R, Turn L, Turn R

### ● TREMOLO

Two input, two output tremolo effect.

Parameter	Range	Description
FREQ.	0.05–40.00 Hz	Modulation speed
DEPTH	0–100%	Modulation depth
WAVE	Sine, Tri, Square	Modulation waveform
LSH F	21.2 Hz–8.00 kHz	Low shelving filter frequency
LSH G	–12.0 to +12.0 dB	Low shelving filter gain
EQ F	100 Hz–8.00 kHz	EQ (peaking type) frequency
EQ G	–12.0 to +12.0 dB	EQ (peaking type) gain
EQ Q	10.0–0.10	EQ (peaking type) bandwidth
HSH F	50.0 Hz–16.0 kHz	High shelving filter frequency
HSH G	–12.0 to +12.0 dB	High shelving filter gain

### ● HQ. PITCH

One input, two output high-quality pitch shifter.

Parameter	Range	Description
PITCH	-12 to +12 semitones	Pitch shift
FINE	-50 to +50 cents	Pitch shift fine
DELAY	0.0–1000.0 ms	Delay time
FB. GAIN	-99 to +99%	Feedback gain (plus values for normal-phase feedback, minus values for reverse-phase feedback)
MODE	1–10	Pitch shift precision

### ● DUAL PITCH

Two input, two output pitch shifter.

Parameter	Range	Description
PITCH 1	-24 to +24 semitones	Channel #1 pitch shift
FINE 1	-50 to +50 cents	Channel #1 pitch shift fine
PITCH 2	-24 to +24 semitones	Channel #2 pitch shift
FINE 2	-50 to +50 cents	Channel #2 pitch shift fine
LEVEL 1	-100 to +100%	Channel #1 level (plus values for normal phase, minus values for reverse phase)
PAN 1	L63 to R63	Channel #1 pan
LEVEL 2	-100 to +100%	Channel #2 level (plus values for normal phase, minus values for reverse phase)
PAN 2	L63 to R63	Channel #2 pan
DELAY 1	0.0–1000.0 ms	Channel #1 delay time
FB. G 1	-99 to +99%	Channel #1 feedback gain (plus values for normal-phase feedback, minus values for reverse-phase feedback)
DELAY 2	0.0–1000.0 ms	Channel #2 delay time
FB. G 2	-99 to +99%	Channel #2 feedback gain (plus values for normal-phase feedback, minus values for reverse-phase feedback)
MODE	1–10	Pitch shift precision

### ● ROTARY

One input, two output rotary speaker simulator.

Parameter	Range	Description
ROTATE	STOP, START	Rotation stop, start
SPEED	SLOW, FAST	Rotation speed (see SLOW and FAST parameters)
SLOW	0.05–10.00 Hz	SLOW rotation speed
FAST	0.05–10.00 Hz	FAST rotation speed
DRIVE	0–100	Overdrive level
ACCEL	0–10	Acceleration at speed changes
LOW	0–100	Low-frequency filter
HIGH	0–100	High-frequency filter

### ● RING MOD.

Two input, two output ring modulator.

Parameter	Range	Description
SOURCE	OSC, SELF	Modulation source: oscillator or input signal
OSC FREQ	0.0–5000.0 Hz	Oscillator frequency
FM FREQ.	0.05–40.00 Hz	Oscillator frequency modulation speed
FM DEPTH	0–100%	Oscillator frequency modulation depth

### ● MOD. FILTER

Two input, two output modulation filter.

Parameter	Range	Description
FREQ.	0.05–40.00 Hz	Modulation speed
DEPTH	0–100%	Modulation depth
PHASE	0.00–354.38 degrees	Left-channel modulation and right-channel modulation phase difference
TYPE	LPF, HPF, BPF	Filter type: low pass, high pass, band pass
OFFSET	0–100	Filter frequency offset
RESO.	0–20	Filter resonance
LEVEL	0–100	Output level

### ● DISTORTION

One input, two output distortion effect.

Parameter	Range	Description
DST TYPE	DST1, DST2, OVD1, OVD2, CRUNCH	Distortion type (DST = distortion, OVD = overdrive)
DRIVE	0–100	Distortion drive
MASTER	0–100	Master volume
TONE	–10 to +10	Tone
N. GATE	0–20	Noise reduction

### ● AMP SIMULATE

One input, two output guitar amp simulator.

Parameter	Range	Description
AMP TYPE	*1	Guitar amp simulation type
DST TYPE	DST1, DST2, OVD1, OVD2, CRUNCH	Distortion type (DST = distortion, OVD = overdrive)
DRIVE	0–100	Distortion drive
MASTER	0–100	Master volume
BASS	0–100	Bass tone control
MIDDLE	0–100	Middle tone control
TREBLE	0–100	High tone control
CAB DEP	0–100%	Speaker cabinet simulation depth
EQ F	100–8.00 kHz	Parametric equalizer frequency
EQ G	–12.0 to +12.0 dB	Parametric equalizer gain
EQ Q	10.0–0.10	Parametric equalizer bandwidth
N. GATE	0–20	Noise reduction

\*1. STK-M1, STK-M2, THRASH, MIDBST, CMB-PG, CMB-VR, CMB-DX, CMB-TW, MINI, FLAT

### ● DYNA. FILTER

Two input, two output dynamically controlled filter.

Parameter	Range	Description
SENSE	0–100	Sensitivity
DIR.	UP, DOWN	Upward or downward frequency change
DECAY	*1	Filter frequency change decay speed
TYPE	LPF, HPF, BPF	Filter type
OFFSET	0–100	Filter frequency offset
RESO.	0–20	Filter resonance
LEVEL	0–100	Output Level

\*1. 6ms – 46.0s (fs=44.1kHz), 5ms – 42.3s (fs=48kHz), 3ms – 23.0s (fs=88.2kHz), 3ms – 21.1s (fs=96kHz)

### ● DYNA. FLANGE

Two input, two output dynamically controlled flanger.

Parameter	Range	Description
SENSE	0–100	Sensitivity
DIR.	UP, DOWN	Upward or downward frequency change
DECAY	*1	Decay speed
OFFSET	0–100	Delay time offset
FB.GAIN	–99 to +99%	Feedback gain (plus values for normal-phase feedback, minus values for reverse-phase feedback)
LSH F	21.2 Hz–8.00 kHz	Low shelving filter frequency
LSH G	–12.0 to +12.0 dB	Low shelving filter gain
EQ F	100 Hz–8.00 kHz	EQ (peaking type) frequency
EQ G	–12.0 to +12.0 dB	EQ (peaking type) gain
EQ Q	10.0–0.10	EQ (peaking type) bandwidth
HSH F	50.0 Hz–16.0 kHz	High shelving filter frequency
HSH G	–12.0 to +12.0 dB	High shelving filter gain

\*1. 6ms – 46.0s (fs=44.1kHz), 5ms – 42.3s (fs=48kHz), 3ms – 23.0s (fs=88.2kHz), 3ms – 21.1s (fs=96kHz)

### ● DYNA. PHASER

Two input, two output dynamically controlled phaser.

Parameter	Range	Description
SENSE	0–100	Sensitivity
DIR.	UP, DOWN	Upward or downward frequency change
DECAY	*1	Decay speed
OFFSET	0–100	Lowest phase-shifted frequency offset
FB.GAIN	–99 to +99%	Feedback gain (plus values for normal-phase feedback, minus values for reverse-phase feedback)
STAGE	2, 4, 6, 8, 10, 12, 14, 16	Number of phase shift stages
LSH F	21.2 Hz–8.00 kHz	Low shelving filter frequency
LSH G	–12.0 to +12.0 dB	Low shelving filter gain
HSH F	50.0 Hz–16.0 kHz	High shelving filter frequency
HSH G	–12.0 to +12.0 dB	High shelving filter gain

\*1. 6ms – 46.0s (fs=44.1kHz), 5ms – 42.3s (fs=48kHz), 3ms – 23.0s (fs=88.2kHz), 3ms – 21.1s (fs=96kHz)

### ● REV+CHORUS

One input, two output reverb and chorus effects in parallel.

Parameter	Range	Description
REV TIME	0.3–99.0 s	Reverb time
INI. DLY	0.0–500.0 ms	Initial delay before reverb begins
HI. RATIO	0.1–1.0	High-frequency reverb time ratio
DIFF.	0–10	Spread
DENSITY	0–100%	Reverb density
HPF	THRU, 21.2 Hz–8.00 kHz	High-pass filter cutoff frequency
LPF	50.0 Hz–16.0 kHz, THRU	Low-pass filter cutoff frequency
REV/CHO	0–100%	Reverb and chorus balance (0% = all reverb, 100% = all chorus)
FREQ.	0.05–40.00 Hz	Modulation speed
AM DEPTH	0–100%	Amplitude modulation depth
PM DEPTH	0–100%	Pitch modulation depth
MOD. DLY	0.0–500.0 ms	Modulation delay time
WAVE	Sine, Tri	Modulation waveform

### ● REV->CHORUS

One input, two output reverb and chorus effects in series.

Parameter	Range	Description
REV TIME	0.3–99.0 s	Reverb time
INI. DLY	0.0–500.0 ms	Initial delay before reverb begins
HI. RATIO	0.1–1.0	High-frequency reverb time ratio
DIFF.	0–10	Spread
DENSITY	0–100%	Reverb density
HPF	THRU, 21.2 Hz–8.00 kHz	High-pass filter cutoff frequency
LPF	50.0 Hz–16.0 kHz, THRU	Low-pass filter cutoff frequency
REV.BAL	0–100%	Reverb and chorused reverb balance (0% = all chorused reverb, 100% = all reverb)
FREQ.	0.05–40.00 Hz	Modulation speed
AM DEPTH	0–100%	Amplitude modulation depth
PM DEPTH	0–100%	Pitch modulation depth
MOD. DLY	0.0–500.0 ms	Modulation delay time
WAVE	Sine, Tri	Modulation waveform

### ● REV+FLANGE

One input, two output reverb and flanger effects in parallel.

Parameter	Range	Description
REV TIME	0.3–99.0 s	Reverb time
INI. DLY	0.0–500.0 ms	Initial delay before reverb begins
HI. RATIO	0.1–1.0	High-frequency reverb time ratio
DIFF.	0–10	Spread
DENSITY	0–100%	Reverb density
HPF	THRU, 21.2 Hz–8.00 kHz	High-pass filter cutoff frequency
LPF	50.0 Hz–16.0 kHz, THRU	Low-pass filter cutoff frequency
REV/FLG	0–100%	Reverb and flange balance (0% = all reverb, 100% = all flange)
FREQ.	0.05–40.00 Hz	Modulation speed
DEPTH	0–100%	Modulation depth
MOD. DLY	0.0–500.0 ms	Modulation delay time
FB. GAIN	–99 to +99%	Feedback gain (plus values for normal-phase feedback, minus values for reverse-phase feedback)
WAVE	Sine, Tri	Modulation waveform

### ● REV->FLANGE

One input, two output reverb and flanger effects in series.

Parameter	Range	Description
REV TIME	0.3–99.0 s	Reverb time
INI. DLY	0.0–500.0 ms	Initial delay before reverb begins
HI. RATIO	0.1–1.0	High-frequency reverb time ratio
DIFF.	0–10	Spread
DENSITY	0–100%	Reverb density
HPF	THRU, 21.2 Hz–8.00 kHz	High-pass filter cutoff frequency
LPF	50.0 Hz–16.0 kHz, THRU	Low-pass filter cutoff frequency
REV.BAL	0–100%	Reverb and flanged reverb balance (0% = all flanged reverb, 100% = all reverb)
FREQ.	0.05–40.00 Hz	Modulation speed
DEPTH	0–100%	Modulation depth
MOD. DLY	0.0–500.0 ms	Modulation delay time
FB. GAIN	–99 to +99%	Feedback gain (plus values for normal-phase feedback, minus values for reverse-phase feedback)
WAVE	Sine, Tri	Modulation waveform

### ● REV+SYMPHO.

One input, two output reverb and symphonic effects in parallel.

Parameter	Range	Description
REV TIME	0.3–99.0 s	Reverb time
INI. DLY	0.0–500.0 ms	Initial delay before reverb begins
HI. RATIO	0.1–1.0	High-frequency reverb time ratio
DIFF.	0–10	Spread
DENSITY	0–100%	Reverb density
HPF	THRU, 21.2 Hz–8.00 kHz	High-pass filter cutoff frequency
LPF	50.0 Hz–16.0 kHz, THRU	Low-pass filter cutoff frequency
REV/SYM	0–100%	Reverb and symphonic balance (0% = all reverb, 100% = all symphonic)
FREQ.	0.05–40.00 Hz	Modulation speed
DEPTH	0–100%	Modulation depth
MOD. DLY	0.0–500.0 ms	Modulation delay time
WAVE	Sine, Tri	Modulation waveform

### ● REV->SYMPHO.

One input, two output reverb and symphonic effects in series.

Parameter	Range	Description
REV TIME	0.3–99.0 s	Reverb time
INI. DLY	0.0–500.0 ms	Initial delay before reverb begins
HI. RATIO	0.1–1.0	High-frequency reverb time ratio
DIFF.	0–10	Spread
DENSITY	0–100%	Reverb density
HPF	THRU, 21.2 Hz–8.00 kHz	High-pass filter cutoff frequency
LPF	50.0 Hz–16.0 kHz, THRU	Low-pass filter cutoff frequency
REV.BAL	0–100%	Reverb and symphonic reverb balance (0% = all symphonic reverb, 100% = all reverb)
FREQ.	0.05–40.00 Hz	Modulation speed
DEPTH	0–100%	Modulation depth
MOD. DLY	0.0–500.0 ms	Modulation delay time
WAVE	Sine, Tri	Modulation waveform

### ● REV->PAN

One input, two output reverb and autopan effects in parallel.

Parameter	Range	Description
REV TIME	0.3–99.0 s	Reverb time
INI. DLY	0.0–500.0 ms	Initial delay before reverb begins
HI. RATIO	0.1–1.0	High-frequency reverb time ratio
DIFF.	0–10	Spread
DENSITY	0–100%	Reverb density
HPF	THRU, 21.2 Hz–8.00 kHz	High-pass filter cutoff frequency
LPF	50.0 Hz–16.0 kHz, THRU	Low-pass filter cutoff frequency
REV.BAL	0–100%	Reverb and panned reverb balance (0% = all panned reverb, 100% = all reverb)
FREQ.	0.05–40.00 Hz	Modulation speed
DEPTH	0–100%	Modulation depth
DIR.	*1	Panning direction
WAVE	Sine, Tri, Square	Modulation waveform

\*1. L<->R, L->R, L<-R, Turn L, Turn R



### ● DELAY+ER.

One input, two output delay and early reflections effects in parallel.

Parameter	Range	Description
DELAY L	0.0–1000.0 ms	Left channel delay time
DELAY R	0.0–1000.0 ms	Right channel delay time
FB. DLY	0.0–1000.0 ms	Feedback delay time
FB. GAIN	–99 to +99%	Feedback gain (plus values for normal-phase feedback, minus values for reverse-phase feedback)
HI. RATIO	0.1–1.0	High-frequency feedback ratio
HPF	THRU, 21.2 Hz–8.00 kHz	High-pass filter cutoff frequency
LPF	50.0 Hz–16.0 kHz, THRU	Low-pass filter cutoff frequency
DLY/ER	0–100%	Delay and early reflections balance (0% = all delay, 100% = all early reflections)
TYPE	S-Hall, L-Hall, Random, Revers, Plate, Spring	Type of early reflection simulation
ROOMSIZE	0.1–20.0	Reflection spacing
LIVENESS	0–10	Early reflections decay characteristics (0 = dead, 10 = live)
INI. DLY	0.0–500.0 ms	Initial delay before reverb begins
DIFF.	0–10	Spread
DENSITY	0–100%	Reverb density
ER NUM.	1–19	Number of early reflections

### ● DELAY->ER.

One input, two output delay and early reflections effects in series.

Parameter	Range	Description
DELAY L	0.0–1000.0 ms	Left channel delay time
DELAY R	0.0–1000.0 ms	Right channel delay time
FB. DLY	0.0–1000.0 ms	Feedback delay time
FB. GAIN	–99 to +99%	Feedback gain (plus values for normal-phase feedback, minus values for reverse-phase feedback)
HI. RATIO	0.1–1.0	High-frequency feedback ratio
HPF	THRU, 21.2 Hz–8.00 kHz	High-pass filter cutoff frequency
LPF	50.0 Hz–16.0 kHz, THRU	Low-pass filter cutoff frequency
DLY.BAL	0–100%	Delay and early reflected delay balance (0% = all early reflected delay, 100% = all delay)
TYPE	S-Hall, L-Hall, Random, Revers, Plate, Spring	Type of early reflection simulation
ROOMSIZE	0.1–20.0	Reflection spacing
LIVENESS	0–10	Early reflections decay characteristics (0 = dead, 10 = live)
INI. DLY	0.0–500.0 ms	Initial delay before reverb begins
DIFF.	0–10	Spread
DENSITY	0–100%	Reverb density
ER NUM.	1–19	Number of early reflections

### ● DELAY+REV

One input, two output delay and reverb effects in parallel.

Parameter	Range	Description
DELAY L	0.0–1000.0 ms	Left channel delay time
DELAY R	0.0–1000.0 ms	Right channel delay time
FB. DLY	0.0–1000.0 ms	Feedback delay time
FB. GAIN	–99 to +99%	Feedback gain (plus values for normal-phase feedback, minus values for reverse-phase feedback)
DELAY HI	0.1–1.0	Delay high-frequency feedback ratio
HPF	THRU, 21.2 Hz–8.00 kHz	High-pass filter cutoff frequency
LPF	50.0 Hz–16.0 kHz, THRU	Low-pass filter cutoff frequency
DLY/REV	0–100%	Delay and reverb balance (0% = all delay, 100% = all reverb)
REV TIME	0.3–99.0 s	Reverb time
INI. DLY	0.0–500.0 ms	Initial delay before reverb begins
REV HI	0.1–1.0	High-frequency reverb time ratio
DIFF.	0–10	Spread
DENSITY	0–100%	Reverb density

### ● DELAY->REV

One input, two output delay and reverb effects in series.

Parameter	Range	Description
DELAY L	0.0–1000.0 ms	Left channel delay time
DELAY R	0.0–1000.0 ms	Right channel delay time
FB. DLY	0.0–1000.0 ms	Feedback delay time
FB. GAIN	–99 to +99%	Feedback gain (plus values for normal-phase feedback, minus values for reverse-phase feedback)
DELAY HI	0.1–1.0	Delay high-frequency feedback ratio
HPF	THRU, 21.2 Hz–8.00 kHz	High-pass filter cutoff frequency
LPF	50.0 Hz–16.0 kHz, THRU	Low-pass filter cutoff frequency
DLY.BAL	0–100%	Delay and delayed reverb balance (0% = all delayed reverb, 100% = all delay)
REV TIME	0.3–99.0 s	Reverb time
INI. DLY	0.0–500.0 ms	Initial delay before reverb begins
REV HI	0.1–1.0	High-frequency reverb time ratio
DIFF.	0–10	Spread
DENSITY	0–100%	Reverb density

### ● DIST->DELAY

One input, two output distortion and delay effects in series.

Parameter	Range	Description
DST TYPE	DST1, DST2, OVD1, OVD2, CRUNCH	Distortion type (DST = distortion, OVD = overdrive)
DRIVE	0–100	Distortion drive
MASTER	0–100	Master volume
TONE	–10 to +10	Tone control
N. GATE	0–20	Noise reduction
DELAY	0.0–2725.0 ms	Delay time
FB. GAIN	–99 to +99%	Feedback gain (plus values for normal-phase feedback, minus values for reverse-phase feedback)
HI. RATIO	0.1–1.0	High-frequency feedback ratio
FREQ.	0.05–40.00 Hz	Modulation speed
DEPTH	0–100%	Modulation depth
DLY.BAL	0–100%	Distortion and delay balance (0% = all distortion, 100% = all delayed distortion)

### ● MULTI FILTER

Two input, two output 3-band multi-filter (24 dB/octave).

Parameter	Range	Description
TYPE 1	HPF, LPF, BPF	Filter 1 type: high pass, low pass, band pass
TYPE 2	HPF, LPF, BPF	Filter 2 type: high pass, low pass, band pass
TYPE 3	HPF, LPF, BPF	Filter 3 type: high pass, low pass, band pass
FREQ. 1	28.0 Hz–16.0 kHz	Filter 1 frequency
FREQ. 2	28.0 Hz–16.0 kHz	Filter 2 frequency
FREQ. 3	28.0 Hz–16.0 kHz	Filter 3 frequency
LEVEL 1	0–100	Filter 1 level
LEVEL 2	0–100	Filter 2 level
LEVEL 3	0–100	Filter 3 level
RESO. 1	0–20	Filter 1 resonance
RESO. 2	0–20	Filter 2 resonance
RESO. 3	0–20	Filter 3 resonance

## ● ST REVERB

Two input, two output stereo reverb.

Parameter	Range	Description
REV TIME	0.3–99.0 s	Reverb time
REV TYPE	Hall, Room, Stage, Plate	Reverb type
INI. DLY	0.0–100.0 ms	Initial delay before reverb begins
HI. RATIO	0.1–1.0	High-frequency reverb time ratio
LO. RATIO	0.1–2.4	Low-frequency reverb time ratio
DIFF.	0–10	Reverb diffusion (left–right reverb spread)
DENSITY	0–100%	Reverb density
E/R BAL.	0–100%	Balance of early reflections and reverb (0% = all reverb, 100% = all early reflections)
HPF	THRU, 21.2 Hz–8.00 kHz	High-pass filter cutoff frequency
LPF	50.0 Hz–16.0 kHz, THRU	Low-pass filter cutoff frequency

## ● M.BAND DYNA.

Two input, two output 3-band dynamics processor, with individual solo and gain reduction metering for each band. (The meter function is for Studio Manager only.)

Parameter	Range	Description
LOW GAIN	–96.0 to +12.0 dB	Low band level
MID GAIN	–96.0 to +12.0 dB	Mid band level
HI. GAIN	–96.0 to +12.0 dB	High band level
PRESENCE	–10 to +10	For positive values, the threshold of the high band is lowered and the threshold of the low band is increased. For negative values, the opposite will occur. When set to 0, all three bands are affected the same.
CMP. THRE	24.0 to 0.0 dB	Compressor threshold
CMP. RAT	1:1 to 20:1	Compressor ratio
CMP. ATK	0–120 ms	Compressor attack
CMP. REL	*1	Compressor release time
CMP. KNEE	0–5	Compressor knee
LOOKUP	0.0–100.0 ms	Lookup delay
CMP. BYP	OFF, ON	Compressor bypass
L-M XOVR	21.2 Hz–8.00 kHz	Low/mid crossover frequency
M-H XOVR	21.2 Hz–8.00 kHz	Mid/high crossover frequency
SLOPE	–6 to –12 dB	Filter slope
CEILING	–6.0 to 0.0 dB, OFF	Specifies the maximum output level
EXP. THRE	–54.0 to –24.0 dB	Expander threshold
EXP. RAT	1:1 to ∞:1	Expander ratio
EXP. REL	*1	Expander release time
EXP. BYP	OFF, ON	Expander bypass
LIM. THRE	–12.0 to 0.0 dB	Limiter threshold
LIM. ATK	0–120 ms	Limiter attack
LIM. REL	*1	Limiter release time
LIM. BYP	OFF, ON	Limiter bypass
LIM. KNEE	0–5	Limiter knee
SOLO LOW	OFF, ON	If this is on, only the low-frequency band will be output.
SOLO MID	OFF, ON	If this is on, only the mid-frequency band will be output.
SOLO HIGH	OFF, ON	If this is on, only the high-frequency band will be output.

\*1. 6ms – 46.0s (fs=44.1kHz), 5ms – 42.3s (fs=48kHz), 3ms – 23.0s (fs=88.2kHz), 3ms – 21.1s (fs=96kHz)

■ Scene Memory to Program Change Table

Program Change No.	Initial Scene No.	User Scene No.	Program Change No.	Initial Scene No.	User Scene No.	Program Change No.	Initial Scene No.	User Scene No.
1	01		44	44		87	87	
2	02		45	45		88	88	
3	03		46	46		89	89	
4	04		47	47		90	90	
5	05		48	48		91	91	
6	06		49	49		92	92	
7	07		50	50		93	93	
8	08		51	51		94	94	
9	09		52	52		95	95	
10	10		53	53		96	96	
11	11		54	54		97	97	
12	12		55	55		98	98	
13	13		56	56		99	99	
14	14		57	57		100	00	
15	15		58	58		101	—	
16	16		59	59		102	—	
17	17		60	60		103	—	
18	18		61	61		104	—	
19	19		62	62		105	—	
20	20		63	63		106	—	
21	21		64	64		107	—	
22	22		65	65		108	—	
23	23		66	66		109	—	
24	24		67	67		110	—	
25	25		68	68		111	—	
26	26		69	69		112	—	
27	27		70	70		113	—	
28	28		71	71		114	—	
29	29		72	72		115	—	
30	30		73	73		116	—	
31	31		74	74		117	—	
32	32		75	75		118	—	
33	33		76	76		119	—	
34	34		77	77		120	—	
35	35		78	78		121	—	
36	36		79	79		122	—	
37	37		80	80		123	—	
38	38		81	81		124	—	
39	39		82	82		125	—	
40	40		83	83		126	—	
41	41		84	84		127	—	
42	42		85	85		128	—	
43	43		86	86				

Before Using

Basics Section

Getting Started

Reference

Appendix

## ■ Input Patch Parameters

\* Each display may differ depending on the channel name (Studio Manager) settings.

: Disabled when Wordclock is set to 96kHz/88.2kHz.

### ● INPUT PATCH (IN1-8)

Display	Description (Input)
NONE	NONE
AD1	MIC/LINE INPUT (AD IN) 1
AD2	MIC/LINE INPUT (AD IN) 2
AD3	MIC/LINE INPUT (AD IN) 3
AD4	MIC/LINE INPUT (AD IN) 4
AD5	MIC/LINE INPUT (AD IN) 5
AD6	MIC/LINE INPUT (AD IN) 6
AD7	MIC/LINE INPUT (AD IN) 7
AD8	MIC/LINE INPUT (AD IN) 8
DIN-L	DIGITAL STEREO IN L
DIN-R	DIGITAL STEREO IN R

### ● INPUT PATCH (STI1-2)

Display	Description (Input)
NONE	NONE
AD1/2	MIC/LINE INPUT (AD IN) 1/2
AD3/4	MIC/LINE INPUT (AD IN) 3/4
AD5/6	MIC/LINE INPUT (AD IN) 5/6
AD7/8	MIC/LINE INPUT (AD IN) 7/8
D.IN	DIGITAL STEREO IN (L&R)
FX1	EFFECT1 (for STI1)
FX2	EFFECT2 (for STI2)

### ● EFFECT PATCH

Display	Description
AUX3	AUX3 (for EFFECT1)
AUX4	AUX4 (for EFFECT2)
CH1	InsertOut-CH1
CH2	InsertOut-CH2
CH3	InsertOut-CH3
CH4	InsertOut-CH4
CH5	InsertOut-CH5
CH6	InsertOut-CH6
CH7	InsertOut-CH7
CH8	InsertOut-CH8
mL1 (CH9)	InsertOut-mL1 (CH9)
mL2 (CH10)	InsertOut-mL2 (CH10)
mL3 (CH11)	InsertOut-mL3 (CH11)
mL4 (CH12)	InsertOut-mL4 (CH12)
mL5 (CH13)	InsertOut-mL5 (CH13)
mL6 (CH14)	InsertOut-mL6 (CH14)
mL7 (CH15)	InsertOut-mL7 (CH15)
mL8 (CH16)	InsertOut-mL8 (CH16)
mL9 (CH17)	InsertOut-mL9 (CH17)
mL10 (CH18)	InsertOut-mL10 (CH18)
mL11 (CH19)	InsertOut-mL11 (CH19)
mL12 (CH20)	InsertOut-mL12 (CH20)
mL13 (CH21)	InsertOut-mL13 (CH21)
mL14 (CH22)	InsertOut-mL14 (CH22)
mL15 (CH23)	InsertOut-mL15 (CH23)
mL16 (CH24)	InsertOut-mL16 (CH24)
BUS	InsertOut-REC BUS L&R
STEREO	InsertOut-STEREO BUS L&R

## ■ Initial Input Patch Settings

\* Each display may differ depending on the channel name (Studio Manager) settings.

: Disabled when Wordclock is set to 96kHz/88.2kHz.

### ● INPUT CHANNEL

1	AD1
2	AD2
3	AD3
4	AD4
5	AD5
6	AD6
7	AD7
8	AD8

### ● STEREO INPUT CHANNEL

STI1 (L&R)	FX1 (L&R)
STI2 (L&R)	FX2 (L&R)

### ● EFFECT PATCH

FX1 (EFFECT1)	AUX3
FX2 (EFFECT2)	AUX4

### ● CHANNEL NAME

	CHANNEL ID	SHORT	LONG
CH1	CH1	CH1	CH1
CH2	CH2	CH2	CH2
CH3	CH3	CH3	CH3
CH4	CH4	CH4	CH4
CH5	CH5	CH5	CH5
CH6	CH6	CH6	CH6
CH7	CH7	CH7	CH7
CH8	CH8	CH8	CH8
ST IN1	STI1	STI1	STEREO IN1
ST IN2	STI2	STI2	STEREO IN2

## ■ Output Patch Parameters

\* Each display may differ depending on the channel name (Studio Manager) settings.  
 [ ] : Disabled when Wordclock is set to 96kHz/88.2kHz.

### ● mLAN OUT (Output)

Display	Description
--	NONE
1/2	mLAN Out 1/2
3/4	mLAN Out 3/4
5/6	mLAN Out 5/6
7/8	mLAN Out 7/8
9/10	mLAN Out 9/10
11/12	mLAN Out 11/12
13/14	mLAN Out 13/14
15/16	mLAN Out 15/16
17/18	mLAN Out 17/18
19/20	mLAN Out 19/20
21/22	mLAN Out 21/22
23/24	mLAN Out 23/24

### ● D.OUT, ST/AUX OUT (Output)

Display	Description
ST-BUS	Stereo Bus
RECBUS	REC Bus
AUX1/2	AUX Bus 1/2
AUX3/4	AUX Bus 3/4

## ■ Initial Output Patch Settings

\* Each display may differ depending on the channel name (Studio Manager) settings.  
 [ ] : Disabled when Wordclock is set to 96kHz/88.2kHz.

### ● DIGITAL STEREO OUT, STEREO/AUX OUT

D.OUT	ST-BUS
ST/AUX OUT	ST-BUS

### ● mLAN OUT

ST-BUS	--
RECBUS	--
AUX1/2	--
AUX3/4	--

### ● CHANNEL NAME

	CHANNEL ID	SHORT	LONG
AUX1	AUX1	AUX1	AUX1
AUX2	AUX2	AUX2	AUX2
AUX3	AUX3	AUX3	AUX3
AUX4	AUX4	AUX4	AUX4
BUS	BUS	BUS	BUS
STEREO	ST	ST	STEREO

### ● mLAN DIRECT OUT : When ST-BUS/RECBUS/AUX1-4 is unassigned to mLAN Out.

Direct Out 1/2	mLAN Out 1/2 (Fixed)
Direct Out 3/4	mLAN Out 3/4 (Fixed)
Direct Out 5/6	mLAN Out 5/6 (Fixed)
Direct Out 7/8	mLAN Out 7/8 (Fixed)
Direct Out 9/10	mLAN Out 9/10 (Fixed)
Direct Out 11/12	mLAN Out 11/12 (Fixed)
Direct Out 13/14	mLAN Out 13/14 (Fixed)
Direct Out 15/16	mLAN Out 15/16 (Fixed)
Direct Out 17/18	mLAN Out 17/18 (Fixed)
Direct Out 19/20	mLAN Out 19/20 (Fixed)
Direct Out 21/22	mLAN Out 21/22 (Fixed)
Direct Out 23/24	mLAN Out 23/24 (Fixed)

# MIDI Data Format

## 1. Ports

The mLAN MIDI ports 1, 4 and 5 are used to communicate via MIDI with the 01X. The mLAN MIDI ports 2 and 3 are connected directly to the MIDI-A and MIDI-B terminals of the 01X and do not communicate via MIDI with the 01X.

## 2. Function Outline

MIDI is used with the 01X for the following purposes/programs.

- Studio Manager
- Controlling the DAW software
- Controlling the Multi Part Editor
- Recalling preset Library Scenes (via program change messages)

The port-related functions are assigned to specific ports as indicated in the chart below.

mLAN MIDI Port	Function
mLAN-MIDI-1	Remote control (Mode can be selected.)
mLAN-MIDI-2	Direct connection to MIDI-A terminal
mLAN-MIDI-3	Direct connection to MIDI-B terminal
mLAN-MIDI-4	Studio Manager
mLAN-MIDI-5	Remote control (Mode is fixed to "GENERAL." This is used for control of the Multi Part Editor, or for recalling Library Scenes by program change messages. Selection between the two is done from the Utility menu.)

## 3. Data Format

The MIDI format to be used for each function is shown below. The explanations here pertain only to changing 01X Scenes via the mLAN MIDI Port 5.

Function	Format	
Remote Control	GENERAL	01X Remote General format
	LOGIC	Special format
	CUBASE	Special format
	SONAR	Special format
	DIGITAL PERFORMER	Special format
Studio Manager	Special format	
Recalling of Library Scenes	Program Change messages	

### 3.1 Channel Messages

Command	rx/tx	function
Cn PROGRAM CHANGE	rx/tx	For switching the Library Scene memory

### 3.2 System Common Messages

No relevant messages.

### 3.3 System Real-time Messages

Command	rx/tx	function
FE ACTIVE SENSING	rx	For checking MIDI cable connection
FF RESET	rx	Clear the running status

### 3.4 System Exclusive Messages

No relevant messages.

## 4. Format Details

### 4.1 Program Change

These messages are effective only when the SHIFT + REMOTE function is set to "NO ASSIGN" (SCENE CTL).

< Receiving >

Data is received when PROGRAM CHANGE RX is on and the receive channel settings match. However, when OMNI is set to on, reception is enabled regardless of the channel settings. Upon reception, Library Scenes are recalled according to the settings of the Program Change Assign Table.

< Transmitting >

When PROGRAM CHANGE TX is on, recalling a Library Scene transmits data via the set transmit channel, according to the settings of the Program Change Assign Table.

```
STATUS 1100nnnn Cn Program change
DATA 0nnnnnnn nn Program number (0-127)
```

### 4.2 Active Sensing (FE)

< Receiving >

If no Active Sensing messages are received within 400 ms, MIDI communications are initialized, such as clearing the Running Status.

```
STATUS 11111110 FE Active sensing
```

### 4.3 System Reset (FF)

< Receiving >

Upon reception, this initializes MIDI communications, such as clearing the Running Status.

```
STATUS 11111111 FF System reset
```



YAMAHA [DIGITAL MIXING STUDIO]  
Model:01X

MIDI Implementation Chart

Date : May/28,2003  
Version : 1.0

Before Using

Basics Section

Getting Started

Reference

Appendix

Function...	Transmitted	Recognized	Remarks
Basic Default Channel Changed	1 - 16 1 - 16	1 - 16 1 - 16	Memorized Memorized
Mode Default Messages Altered	x x *****	OMNI off/OMNI on x x	Memorized
Note Number : True voice	x *****	x x	
Velocity Note ON Note OFF	x x	x x	
After Touch Key's Ch's	x x	x x	
Pitch Bend	x	x	
Control 0-95,102-119 Change	x	x	
Prog Change : True #	o 0 - 127 *****	o 0 - 127 0-99	Assignable
System Exclusive	x	x	
: Song Pos. Common : Song Sel. : Tune	x x x	x x x	
System : Clock Real Time : Commands	x x	x x	
Aux : Local ON/OFF Mes- : All Notes OFF sages : Active Sense : Reset	x x x x	x x o o	
Notes	mLAN-MIDI-5 Port & NO ASSIGN(SCENE CTL) Mode Only		

Mode 1 : OMNI ON , POLY      Mode 2 : OMNI ON , MONO      o : Yes  
Mode 3 : OMNI OFF, POLY      Mode 4 : OMNI OFF, MONO      x : No

## Display Messages

Messages	Information
<b>*** SURE?</b>	This prompt asks if you want to execute the operation, or change the setting (Final confirmation).
<b>---- (Channel number “flashes” alternately with “----”)</b>	These channels cannot be used while 01X is set to 96kHz/88.2kHz operation.
<b>Do you want to initialize backup data?</b>	This prompt asks if you want to initialize the backup data (page 86).
<b>ERROR: Backup Data Crashed!! Do you want to initialize backup data?</b>	Because the power was turned off while data was being written to Flash ROM (during a “Please keep power on” message), the backup data must be initialized (page 86). The prompt asks if you want to initialize the backup data.
<b>EXECUTING BACKUP. PLEASE KEEP POWER ON...</b>	Never attempt to turn off the power while data is being written to Flash ROM. Turning the power off in this state results in loss of all user data and may cause the system to freeze (due to corruption of data in the Flash ROM).
<b>INCORRECT WORDCLOCK!</b>	An inappropriate wordclock is being received from the connected device to which you are synchronizing (page 92).
<b>Initializing backup data, please keep power on ...</b>	The Factory Set operation is being executed. Never attempt to turn off the power while data is being written to Flash ROM. Turning the power off in this state results in loss of all user data and may cause the system to freeze (due to corruption of data in the Flash ROM).
<b>LIBRARY: CATEGORY CONFLICT!</b>	The channel categories (e.g., Input , Aux Out, etc.) of the original recall/store destination do not match (page 103).
<b>LIBRARY: FOR EFFECT1 ONLY!</b>	Not available for Effect 2
<b>LIBRARY: INVALID CHANNEL!</b>	You can recall or store settings for this channel.
<b>LIBRARY: NO DATA!</b>	The selected region does not contain data.
<b>LIBRARY: PROTECTED!</b>	Can't save, erase, or edit the title because the song is protected.
<b>LIBRARY: READ ONLY!</b>	Can't save, erase, or edit the title because the song is read-only.
<b>mLAN MASTER NOW!</b>	This operation cannot be performed because the 01X is in mLAN Master mode (page 92).
<b>mLAN SLAVE NOW!</b>	This operation cannot be performed because the 01X is in mLAN Slave mode (page 92).
<b>MLAN1/4/5: TX BUFFER FULL! MLAN1/4/5: RX BUFFER FULL!</b>	Failed to process the MIDI data because too much data was received/transmitted at once.
<b>NOT AUTO WORDCLOCK MODE NOW!</b>	The mLAN auto wordclock setting is invalid (page 92).
<b>NOT DEFINED.</b>	Not available for this channel.
<b>RELEASE PAIR?</b>	This prompt asks if you want to release the pair setting (page 102).
<b>SYSTEM BACKUP OK?</b>	This prompt asks if you want to execute System Backup (page 86).
<b>UNLOCK (NO SIGNAL) NOW!</b>	This cannot be selected as the wordclock source (page 92).

# Troubleshooting

No sound? Wrong sound? When a problem like this occurs, please check the following points before assuming that the product is faulty. In many cases you'll find the solution to your problem here. If the problem persists, then contact your Yamaha dealer or service center.

## ■ No sound, or sound is too faint.

- Are speakers or headphones connected correctly? ..... page 23
- Is your amp and other external devices turned on?
- Is the signal from the external device being input? ..... page 46
- The connection cable from the external device may be broken.
- Is the MONITOR A/B switch setting appropriate? ..... page 96
- Is the sound level balance of MONITOR appropriate? ..... page 16
- Is the level setting of MONITOR/PHONES knob appropriate? ..... page 17
- The GAIN may be set to an extremely low value. ....pages 16, 46
- Is the fader of the input channel or stereo input channel or stereo output channel raised to an appropriate level? Is the channel turned on? ..... page 99
- Is the input/output patching set correctly?.....pages 88, 90, 91
- Is the wordclock setting correct for both the 01X and the external device(s)? ..... page 92, "Settings by mLAN Auto Connector" (Installation Guide)
- Is the attenuator of the EQ raised? .....pages 97, 98
- The EQ gain may be set to an extremely low value. ....pages 96, 97, 98
- The dynamics processor may be set to an extreme threshold or ratio. ....pages 100,122
- If you are connecting an electric guitar, is it connected to the Hi-Z jack? ..... page 21
- (When using SQ01) Make sure that "Disable Audio" (select [Audio] from the [Setup] menu in the Track View window) is off (unchecked). ..... SQ01 Online Manual
- (When using SQ01) When the application is closed in the condition that the sampling wave frequency of SQ01 is set to 48kHz, then is connected with the mLAN Auto Connector with a setting other than 48kHz, a message appears when starting SQ01 indicating that the audio device cannot be used. Make sure to set "Disable Audio" to off (select [Audio] from the [Setup] menu in the Track View window). ..... SQ01 Online Manual
- Are all the level settings (of any tone generators, playback devices and the application itself) appropriate?
- (When wordclock is set to 96kHz/88.2kHz) Make sure that input channels 17 – 24 (mL9 – mL16) or stereo input channel 2 are not used.
- (For Windows) Is mLAN (mLAN Driver) set to "ON"? From the taskbar, right click on the mLAN Manager (mLAN icon).
- Is the mLAN Audio setup appropriate? ..... Installation Guide
- Are the other settings of mLAN appropriate? ..... ("The mLAN connection does not work." below)

## ■ Sound is distorted.

- Is the [GAIN] control set correctly? .....pages 1, 46
- The connection cable from the external device may be broken.
- The fader of the input channel or stereo input channel or stereo output channel may be raised excessively..... page 99
- The EQ attenuator may be set to an excessive level.....pages 97, 98
- The EQ gain may be excessively high.....pages 96, 97, 98
- Is the wordclock setting correct for both the 01X and the external device(s)? ..... page 92, "Settings by mLAN Auto Connector" (Installation Guide)
- An effect such as Distortion or Amp Simulate may be in use. .... page 102
- Did you record at an appropriate level?

Before Using

Basics Section

Getting Started

Reference

Appendix

**■ Noise is produced.**

- Is the latency setting of the mLAN Driver appropriate? ..... “mLAN Driver Setup”, “ASIO mLAN Control Panel” (Installation Guide)
- (For Windows) In the BIOS settings, set Hyper Threading to off.
- Is the wordclock setting correct for both the 01X and the external device(s)? ..... page 92, “Settings by mLAN Auto Connector” (Installation Guide)
- Is an unsynchronized signal being input?..... page 92
- Is the dither setting appropriate? ..... page 93
- The oscillator may be functioning..... page 93
- If the speed of your computer’s hard disk is slow, problems may occur during recording and playback.
- If you connect/disconnect the LAN, USB or the cables to the mini jacks terminals on the Macintosh you are using when using mLAN, some noise may be caused and/or data may be cut off. Make sure that you do not insert or unplug ant connections when using mLAN.
- Is the number of audio channels appropriate? The amount of audio channels that can be used simultaneously differs depending on the computer capacity and speed..... page 92, “Settings by mLAN Auto Connector” (Installation Guide)
- Is the sampling rate (wordclock) appropriate? A high sampling rate can be the cause of the noise depending on the computer capacity and speed..... page 92, “Settings by mLAN Auto Connector” (Installation Guide)
- Are there any noise-producing devices (such as those containing power inverters, etc.) near the cables? Move all cables away from any possible noise sources.
- Is the mLAN cable damaged? Old cables and thin cables can be the cause of noise. Make sure to use the included mLAN cable or any other high-quality cable with the same thickness.
- When using the mLAN driver, make sure to turn off or disable any background applications (for example, virus scanning software or auto backup routines). Otherwise, noise may result due to instability of the driver operation. When not using the mLAN driver (it can be set to OFF from mLAN Manager), you can turn on or enable the above-mentioned software again.

**■ Sound recorded via the digital input sounds grainy.**

- Is the dither setting appropriate? ..... page 93

**■ Signal from the INPUT 8 jack is too loud.**

- A conventional line-level signal may be connected to the Hi-Z jack..... page 21

**■ Not all tracks will record/play back.**

- Is the number of channels for mLAN audio receiving/sending (set on the mLAN Auto Connector) appropriate?..... Installation Guide

**■ Can’t save to a library.**

- Is the scene library protected? ..... page 86
- It is not possible to save to the factory-preset libraries. .... page 36

**■ Can’t reproduce a scene.**

- One or more channels may be set to Recall Safe. .... page 86

**■ The volume of a particular channel increases or decreases.**

- Are the dynamics processor settings appropriate? .....pages 100, 122
- Automation (Automix) may have been recorded. .... page 15

**■ Level does not change even when moving the fader.**

- Have the appropriate mode and layer been selected?.....pages 37, 40
- Make sure the fader is not set to PRE FADER in the AUX settings. .... page 100
- Has the FLIP function been turned on?..... page 19
- Make sure that the signal routing of the audio is not set to PRE FADER or PRE EQ in the direct out configuration. .... page 91

- **Faders move to the lowest/Highest position on their own.** ..... page 15

  - Automation (Automix) may have been recorded. .... page 15
  
- **Meters move even though the faders are lowered.** ..... page 91

  - The direct out setting may be PRE EQ or PRE FADER. .... page 91
  - The meter display may be set to PRE FADER. .... page 46
  
- **The channels selected by the [ON] button and [SEL] button are not correct.** ..... page 40

  - Is the proper layer selected? ..... page 40
  
- **Can't recall a channel library.** ..... page 103

  - The settings that can be recalled from the channel library are limited to the library of the same category. .... page 103
  
- **Can't exchange MIDI/program change data.** ..... page 95

  - Has the port number been set correctly? ..... page 95
  - Has the SHIFT+REMOTE FUNCTION parameter been set correctly? ..... page 87
  - Are the MIDI cables connected correctly?
  - A MIDI cable may be broken.
  - Is the power turned on for the transmitting and receiving devices?
  - Is the on/off setting of program change reception/transmission appropriate? ..... page 94
  - Do the channel settings match for the transmitted and receiving devices? ..... page 94
  - Is a scene assigned to the program change number being transmitted? ..... page 94
  
- **Pairing was specified, but the signal is monaural.** ..... pages 99, 102

  - Is the odd-numbered channel panned far left and the even-numbered channel panned far right? ..... pages 99, 102
  
- **Pairing was specified, but the signal phase does not match.** ..... page 102

  - Even when channels are paired, the phase setting is not linked. .... page 102
  
- **Automation (Automix) cannot be stopped.** ..... page 88

  - Has the REMOTE AUTOMATION SETUP parameter been set to correctly? ..... page 88
  
- **Can't use the internal effects.** ..... page 102

  - Effect BYPASS may be turned ON. .... page 102
  - Are the level of STEREO IN 1, 2 faders raised? ..... page 99
  - EFFECT PATCH may be set to insertion (each channel). .... page 102
  - It is not possible to insert one effect into multiple channels. .... page 102
  - 019. HQ. Pitch can be used only with EFFECT 1.
  - When the sampling rate is 96kHz/88.2kHz, only Effect 1 can be used.
  
- **Can't use SOLO.** ..... page 96

  - The channel may be set to Solo Safe. .... page 96
  
- **Fader groups and mute groups don't work.** ..... page 101

  - In the Fader Group page and Mute Group page, check that grouping is set to ENABLE. .... page 101

■ **The pitch is wrong.**

- Is the 01X operating on the same sampling frequency as the synchronized external device?..... page 92, “Settings by mLAN Auto Connector” (Installation Guide)
- Is the master device operating in a stable way?
- Is an effect such as HQ.Pitch or Dual Pitch selected?..... page 102

■ **The layer of 17-24 (mLAN9-16) cannot be used.**

- When the sampling rate is set to 96kHz/88.2kHz, the layer of 17 – 24 (mLAN) can not be selected..... page 40

■ **Cannot edit with Studio Manager.**

- Has the STUDIO MANAGER ID been set correctly?..... page 94
- Is Port 4 (Studio Manager) selected for Studio Manager data transmission/reception? ..... Studio Manager Owner’s Manual (PDF)

■ **The Remote Control or Automation features do not work.**

- Is the correct DAW software selected in Remote Select? ..... page 87
- Are the mLAN settings correct?..... Installation Guide
- Are settings on the DAW correct?..... page 67, Installation Guide
- Is Port 1 selected for mLAN MIDI transmission/reception?..... page 67, Installation Guide

■ **Cannot change the wordclock.**

- Set this with the mLAN Auto Connector when using mLAN..... “Settings by mLAN Auto Connector” (Installation Guide)
- Is the mLAN Auto Wordclock (AUTO W.CLK) setting appropriate? ..... page 92

■ **Cannot install the driver.**

- Is the mLAN cable properly connected? Check the connection; disconnect the mLAN cable once, then insert it again.

■ **The mLAN connection does not work.**

- Has the driver been installed?..... Installation Guide
- Is the mLAN cable properly connected? Check the connection; disconnect the mLAN cable once, then insert it again.
- (For Windows) Is mLAN set to “ON”? From the taskbar, right click on the mLAN Manager icon. .... Installation Guide
- (For Windows) When adding a new IEEE 1394 card, right click on the mLAN Manager icon in the taskbar and select “ON.” ..... Installation Guide
- Is the ACTIVE lamp on the rear panel of the 01X lit (in blue)? If it is not lit, check the followings:
- In mLAN Driver Setup (from taskbar, right click on the mLAN Manager icon, then “Driver Setup”), is the Status indicator blue? If not, restart the 01X and re-enable connection by using mLAN Auto Connector. .... Installation Guide
- Is mLAN AUTO W.CLK (Auto Wordclock) on the 01X set to “ENABLE”?..... page 92
- Has connection been enabled with mLAN Auto Connector? Re-enable connection if necessary..... “Settings by mLAN Auto Connector” (Installation Guide)
- Have you changed the device? Even if the model is the same, if the actual device is different, it is necessary to re-enable connection by using Auto Connector..... “Settings by mLAN Auto Connector” (Installation Guide)
- Is there a loop connection? Check the cabling and make sure none of the devices are connected in a loop.

Example of loop connection

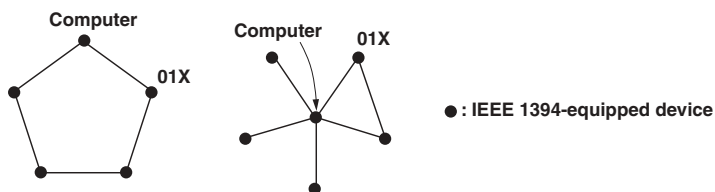

- There may be a limit on the IEEE 1394 interface of your computer as to the number of ports that can be used simultaneously. Check how many ports can be used simultaneously.
- Turn off all devices on the mLAN network (except the computer) and re-connect each device one-by-one until the device causing the problem is found.
- (For Windows) (When removing the mLAN bus from the [Safely Remove Hardware] setting of the task bar.) Restart the computer when using mLAN again.
- With Macintosh notebook computers such as the iBook and PowerBook, always first connect the 01X and mLAN cable then turn on the power of the 01X, before starting up the computer.

■ **The mLAN Driver (MIDI/Audio) is not detected from the application (DAW, audio sequencer, etc.).**

- (For Windows) Is mLAN (mLAN Driver) set to “ON”? From the taskbar, right click on the mLAN Manager (mLAN icon). ..... “mLAN Manager” (Installation Guide)
- Is the 01X properly connected to the computer by an mLAN cable, and is the power turned on? (Try starting the mLAN Auto Connector and “connect” again.) ..... “Settings by mLAN Auto Connector” (Installation Guide)
- With Macintosh notebook computers such as the iBook and PowerBook, always first connect the 01X and mLAN cable then turn on the power of the 01X, before starting up the computer.
- Are the mLAN settings correct? ..... (“The mLAN connection does not work.” above)

■ **The computer operation is sluggish.**

- Decrease the number of audio channels to be used by the mLAN Auto Connector. .... Installation Guide
- Increase the latency value. .... Installation Guide
- (For Macintosh) Operation may become sluggish when resuming a dual processor computer from a sleep or suspended condition. Restart the computer.
- (For Windows) Refer to “Hints when handling audio data.” ..... Installation Guide
- (For Windows) This problem can sometimes be solved by setting Hyper Threading to “Disable.”
- (For Windows) When not using mLAN, right click on the mLAN Manager icon in the task bar and select “OFF” (close mLAN).

■ **Cannot close the applications or shut down the computer (operating system).**

■ **Cannot change the mLAN settings.**

■ **Cannot uninstall (remove) Install mLAN for 01X (mLAN driver) or mLAN Tools 2.0.**

- (For Windows) Is the mLAN (WDM) driver selected as the default audio device for the system? ..... Installation Guide
  - Select [Start] → [Control Panel] → [Sounds and Audio Devices] → [Voice].  
Make sure that something other than “mLAN Audio 01” is selected for the “Voice playback” and “Voice recording” settings.
  - Select [Start] → [Control Panel] → [Sounds and Audio Devices] → [Audio].  
Make sure that something other than “mLAN Audio 01” is selected for the “Sound playback” and “Sound recording” settings.
- (For Windows) Select [Start] → [Control Panel] → [Sounds and Audio Devices] → “Sounds” tab, and select “No sounds” in the “Sound scheme” box, then execute again.
- If you cannot quit mLAN (by selecting “OFF” after right clicking the mLAN icon in the task bar), end the processes listed below manually. ([Ctrl] + [Alt] + [Delete] → “Processes” tab → select process → [End process]) When finished, start mLAN Manager to change the mLAN settings again.
  - mLANVDevice.exe
  - mLANTFamily.exe
  - mLANSoftPH.exe
  - mLANManager.exe
- (When a message such as “file cannot be found” appears when uninstalling:) Try executing the installation once more, then uninstall again. .... Installation Guide

■ **(For Windows) The mLAN Manager (mLAN icon in the task bar) has disappeared.**

- Select [Start] → [(All) Programs] → [Startup] (or [mLAN Tools]) → [mLAN Manager] ..... Installation Guide



# Specifications

## ■ General Specifications

<b>Sampling Frequency</b>	Internal, External	Normal rate: 44.1 kHz (-10 %) – 48 kHz (+6 %) Double rate: 88.2 kHz (-10 %) – 96 kHz (+6 %)
<b>Frequency Response</b>	44.1 kHz, 48 kHz	20 Hz – 20 kHz
	88.2 kHz, 96 kHz	20 Hz – 40 kHz
<b>Total Harmonic Distortion</b>	Less than 0.02 %	0 +1/-3dB, MIC/LINE IN to STEREO OUT (48 kHz) 0 +1/-3dB, MIC/LINE IN to STEREO OUT (96 kHz)
<b>Dynamic Range</b>	103 dB	1kHz, LINE IN to STEREO OUT LINE IN to STEREO OUT
<b>Noise level</b>	-105 dBV	
<b>Crosstalk</b>	70 dB	
<b>DA converter</b>	24 bit Linear, 128 times oversampling (44.1, 48 kHz)/64 times over sampling (88.2, 96 kHz)	
<b>AD converter</b>	24 bit Linear, 128 times oversampling (44.1, 48 kHz)/64 times over sampling (88.2, 96 kHz)	
<b>Internal Signal Processing</b>	32 bit (Accumulator 58 bit)	

Number of memories	Preset Area	User Area
Scene Library	1	99
Channel Library	2	127
EQ Library	40	160
Dynamics Library	40	88
Effect 1/2 Library	43	85
Input Patch Library	1	32
Output Patch Library	1	32

Mixer Functions		28 ch Digital Mixing (44.1, 48 kHz)/18 ch Digital Mixing (88.2, 96 kHz)
Input	MIC/LINE Input	8 ch (with 1 channel switchable to HI-Z Input)
	mLAN Input	16 ch (44.1 kHz, 48 kHz)/8ch (88.2 kHz, 96 kHz)
	mLAN Stereo Input (mLAN Monitor Input)	2 ch (Stereo one system) is cascade-connected to the Monitor Out (The Mix Balance between mLAN Monitor Input and Stereo Output can be adjusted)
	Stereo Input	Stereo; two systems (combined use with Effect return) (44.1 kHz, 48 kHz) Stereo one system (88.2 kHz, 96 kHz)
	Digital Input	Stereo; one system
	Digital Cascade Input	Stereo; one system is cascade-connected to the Stereo Bus (with attenuator)
Oscillator		Sine (100 Hz, 1 kHz, 10 kHz) / Noise, 0 dB – -96 dB (1 dB step) Can be output to Stereo Bus, Rec Bus, Aux 1 – 4
Output	Stereo Bus	2 ch (Stereo one system)
	Rec Bus	2 ch (Stereo one system)
	Aux Bus	2 ch (Sends 1, 2)
	Effect Bus	2 ch (Sends 3, 4; combined use with Aux 3, 4)
	Direct Output	24 ch (mLAN output from Input Module x 24) (44.1 kHz, 48 kHz) / 16 ch (88.2 kHz, 96 kHz)
Effector		2 units (43 preset types) (44.1 kHz, 48 kHz)/1 unit (88.2 kHz, 96 kHz)
Channel Module	MIC/LINE Input mLAN Input	24 systems (A/D Input x 8 ch, mLAN Input x 16) (44.1 kHz, 48 kHz) / 16 systems (A/D Input x 8 ch, mLAN Input x 8) (88.2 kHz, 96 kHz) Attenuator, Phase, Insert, 4-Band EQ, Dynamics, Aux Send 1 – 4, Level, Pan
	Stereo Input	Two systems (44.1 kHz, 48 kHz)/One system (88.2 kHz, 96 kHz) Attenuator, Phase, 4-Band EQ, Aux Send 1 - 4, Level, Pan
Output Module	Stereo Output	Attenuator, 4-Band EQ, Dynamics, Insert, Level, Pan balance
	Rec Bus Output	Dynamics, Insert, Level
	Aux 1 – 4 Output	Level

Interface Functions		
mLAN	Audio I/F	18 ch Input / 24 ch Output (44.1 kHz, 48 kHz), 10 ch Input / 16 ch Output (88.2 kHz, 96 kHz)
	MIDI I/F	5 ports Input / 5 ports Output (for DAW, MIDI-A, MIDI-B, Studio Manager and Program Change Control)

## ■ Input/Output Specifications

Analog Input	Connector	Input level		
		Nominal	Max. before clip	Input Impedance
MIC/LINE INPUT 1, 2	XLR type, Balanced, +48 V +3 V/-3 V Phantom	-46 dB – +4 dB	+18 dB	3 kΩ
MIC/LINE INPUT 3 – 8	TRS Phone, Balanced	-46 dB – +4 dB	+18 dB	3 kΩ
MIC/LINE INPUT Hi-Z	Phone, Unbalanced	-46 dB – +4 dB	+18 dB	500 kΩ

Analog Output	Connector	Output level		
		Nominal	Max. before clip	Actual Load Impedance
MONITOR OUT (L, R)	Phone, Unbalanced	-10 dBV	+4 dBV	10 kΩ
STEREO/AUX OUT (L, R)	Phone, Unbalanced	-10 dBV	+4 dBV	10 kΩ
PHONES	TRS Phone, Unbalanced		100 mW + 100 mW (40 Ω load)	8 – 40 Ω

Digital Input/Output	Connector	Format	Recommended output level	Other details
DIGITAL IN, OUT	RCA PIN	IEC-60958 Consumer use	0.5 Vpp/75 Ω	SRC On/Off is possible on the input side, Dither On/Off possible on the output side
MIDI IN, OUT A/B	DIN (5 pin)	MIDI	–	–
mLAN 1/2	IEEE 1394 (6 pin)	IEEE 1394/FireWire	–	–

FOOT SWITCH 1/2	PHONE
-----------------	-------

## ■ Control

Analog Section	Input Gain	LINE/MIC Gain Knob 1 – 8 (+4 dB – -46 dB)
	Monitor Volume	MONITOR/PHONES Knob
	Phantom Switch	PHANTOM (+48 V) ON-OFF (rear panel)
	Power Switch	STANDBY/ON switch (rear panel)
Faders	Faders 1 – 8, STEREO Fader 60 mm motorized, 0 – -132 – -∞dB	
Knobs/Dial	Channel knobs 1 – 8 (Data Entry) Rotary Encoder Dial (Song Position)	
Panel Switches	MODE	INTERNAL, REMOTE, SCENE, UTILITY [BACK UP], MONITOR
	PAGE	SELECTED CHANNEL [LIBRARY], EQ-LOW, EQ-LOW-MID, EQ-HIGH-MID, EQ-HIGH, PAN [CH PARAM], SEND [INST], DYNAMICS [PLUG-IN], GROUP, EFFECT
	MIXER/LAYER	AUDIO/1-8, INST/9-16(mLAN), MIDI/17-24(mLAN), BUS-AUX/MASTER, OTHER
	FUNCTION	F1 [TRACK], F2 [MIXER], F3 [LIST], F4 [CLOSE], F5, F6, F7, F8
	DISPLAY	UP, DOWN, DISPLAY SHIFT, NAME/VALUE [METER]
	BANK	<, >
	CHANNEL	SEL 1 – 8, STEREO SEL, ON 1 – 8, SOLO, REC RDY, AUTO EDIT, AUTO R/W
	TRANSPORT	REWIND, FORWARD, STOP, PLAY, RECORD, LOOP, MARKER, MARKER-WRITE
	CURSOR	UP, DOWN, LEFT, RIGHT, ZOOM
Others	EDIT, UNDO, SAVE, FLIP, SHIFT, SCRUB	
Display	LCD	55 x 2 character LCD (backlit)

## ■ Others

Supplied Accessories	Power Adaptor (PA-300), Owner's Manual set, CD-ROM x 2, mLAN (IEEE 1394) cable
Power Consumption	21 W
Dimensions	453(W) x 391(D) x 116(H) mm (including channel knobs' height)
Weight	6.2 kg
Operating free-air temperature range	10 – 35°C

\* Specifications and descriptions in this owner's manual are for information purposes only. Yamaha Corp. reserves the right to change or modify products or specifications at any time without prior notice. Since specifications, equipment or options may not be the same in every locale, please check with your Yamaha dealer.

# Index

## Numerics

01X Channel Module (Basics Section) .....28

## A

About This Manual .....7  
Accessories .....6  
ACTIVE lamp .....22  
Application examples (Basics Section) .....34  
Application Index .....10  
ASIO Driver Setup .....69  
ASIO mLAN .....68  
Attack (Companer) .....123  
Attack (Compressor) .....122  
Attack (Expander) .....123  
Attack (Gate and Ducking) .....124  
Attenuator (ATT) (01X Terminology) .....14  
Audio setup .....68  
AUTO EDIT (Automation Edit) button .....17  
AUTO R/W (Automation Read/Write) button .....17  
Automation (01X Terminology) .....15  
Automation (Getting Started) .....77  
AUX (01X Terminology) .....14  
AUX 1 – 4PREPOST .....100  
AUX buses 1 through 4 (01X Terminology) .....14  
AUX Send Level 1 – 4 .....100  
AX 1 – 4 PP .....100

## B

BACKUP .....86  
BALANCE .....99  
Bank (01X Terminology) .....15  
BANK ◀/▶ (Left/Right) buttons .....19  
Basic Operations (Basics Section) .....37  
Buses (01X Terminology) .....14  
BYPASS .....102

## C

CD-ROM .....6  
Channel (01X Terminology) .....14  
Channel faders .....17  
Channel knobs .....17  
CHANNEL LIBRARY .....103  
Channel Pair .....102  
Chart Indications .....84  
Clipping .....46  
Companer .....123  
Compression .....52  
Compressor .....122  
Connections .....23  
Console .....94  
Controls and Connectors .....16  
Cubase (Remote Function List) .....108  
Cursor </>/^/∨ (Left/Right/Up/Down) buttons .....20  
Cycle playback .....74

## D

D.IN ST-BUS CASCADE (Digital In Stereo Bus Cascade) .....93  
D.OUT DITHER (Digital Out Dither) .....93  
DAW .....6  
DC IN terminal .....22  
Decay (Gate and Ducking) .....124  
Device ID .....94  
Dial (Rotary Encoder) .....20  
Digital cascade connection (Basics Section) .....29  
Digital In Stereo Bus Cascade .....93  
Digital In/Out .....93  
DIGITAL OUT COPYRIGHT .....95  
Digital Out Dither .....93  
Digital Performer (Remote Function List) .....112  
DIGITAL STEREO IN/OUT jack .....22  
DIO (Digital In/Out) .....93  
Direct out settings .....90  
Display .....16  
DISPLAY ^/∨ (Up/Down) buttons .....17  
Display Indications (Basics Section) .....38  
Display Messages .....143  
DISPLAY SETTINGS .....95  
Dithering .....93  
Ducking .....124  
DYNAMICS .....100  
Dynamics .....52  
DYNAMICS button .....19  
DYNAMICS LIBRARY .....100  
Dynamics Library .....118  
Dynamics Parameters .....122  
Dynamics Parameters/Values .....119

## E

EDIT button .....19  
EFFECT .....102  
EFFECT button .....19  
EFFECT PATCH .....139  
Effect send routing .....57  
Effect type and parameters .....57  
EFFECT1/2 BYPASS .....102  
EFFECT1/2 LIBRARY .....103  
EFFECT1/2 MIX .....102  
EFFECT1/2 PARAMETER .....103  
EFFECT1/2 PATCH .....102  
EFFECT1/2 TYPE .....102  
Effects Library .....125  
Effects Parameters .....126  
Entering Characters (Basics Section) .....41  
EQ (EQ Tips) .....48  
EQ buttons .....19  
EQ HIGH .....98  
EQ HIGH-MID .....97  
EQ LIBRARY .....99  
EQ Library .....115  
EQ LOW .....96  
EQ LOW-MID .....97  
EQ Parameters/Values .....116  
Expander .....122  
External effects .....60

**F**

F1 - F8 (Function 1 - 8) buttons .....	19
Factory Set (Restore Factory Defaults) (Basics Section) .....	42
FADER GROUP .....	101
Fader Groups .....	64
FADER LEVEL DISP .....	95
Fader Level Display .....	95
FADER TOUCH TIMEOUT .....	88
Final Master .....	9
FLIP button .....	19
FOOT SWITCH jacks 1/2 .....	22
Forward ►► button .....	20
Function buttons .....	82
Function List .....	84
Function Tree .....	84

**G**

GAIN (Compander) .....	123
GAIN (Compressor) .....	122
GAIN (Expander) .....	123
Gain knob .....	16
Gate .....	124
GENERAL REMOTE .....	87
GROUP .....	64, 101
GROUP button .....	19

**H**

Hold (Gate and Ducking) .....	124
HOME (Basics Section) .....	37

**I**

Initialize → Factory Set (Basics Section) .....	42
Input and Output Patching .....	61
Input channel (Basics Section) .....	28
Input patch (Basics Section) .....	27
INPUT PATCH (IN1-4) (Input Channels 1 – 4) .....	88
INPUT PATCH (IN5-8) (Input Channels 5 – 8) .....	88
INPUT PATCH (ST1/2) (Input Channel Stereo 1/2) .....	89
INPUT PATCH LIBRARY .....	89
INTERNAL button .....	18
Internal Effects .....	56
Internal effects 1/2 (Basics Section) .....	31
INTERNAL MODE .....	85

**J**

Jitter (01X Terminology) .....	14
--------------------------------	----

**K**

KEY-IN (Gate and Ducking) .....	124
Knee (Compressor) .....	122
Knee (Expander) .....	123

**L**

LAST SOLO .....	96
Latch .....	15
Layer selection/Channel selection (Basics Section) .....	40
LEVEL (channel) .....	99
Library .....	54
Library (01X Terminology) .....	14
Library Structure (Basics Section) .....	36
LOGIC (Remote Function List) .....	106
LOOP button .....	19
Loop connection .....	147

**M**

MARKER button .....	20
Markers .....	74
Memory (Library) Structure (Basics Section) .....	36
MENU SELECT .....	87
Meter .....	46
MIC/LINE INPUT .....	21
MIC/LINE INPUT (TRS phone) jacks 3 through 8 (BAL) .....	21
MIC/LINE INPUT (XLR) jacks 1/2 .....	21
MIC/LINE INPUT jack 8 (HI-Z) .....	21
MIDI .....	94, 95
MIDI A IN/OUT terminals, MIDI B IN/OUT terminals .....	22
MIDI and audio setup .....	67
MIDI CHANNEL .....	94
MIDI Data Format .....	141
MIDI Implementation Chart .....	142
MIDI Receive channel .....	94
MIDI setup .....	67
MIDI Transmit channel .....	94
MIX SOLO .....	96
Mixer control — using the faders and knobs .....	75
MIXER/LAYER buttons .....	19
Mixing Tutorial .....	46
mLAN (IEEE 1394) connectors 1/2 .....	22
mLAN AUTO W.CLK (mLAN Auto Wordclock) .....	92
mLAN Auto Wordclock .....	92
mLAN MIDI INFORMATION .....	95
mLAN OUT CHANNEL .....	90
Mode selection and display indications (Basics Section) .....	38
Modes (Basics Section) .....	37
MON (Monitor) .....	96
Monitor .....	96
MONITOR (Monitor Mix Balance) .....	96
MONITOR A/B button .....	18
Monitor Mix Balance .....	96
MONITOR OUT jacks .....	21
Monitor output/headphone output (Basics Section) .....	31
MONITOR/PHONES knob .....	17
Moving faders (01X Terminology) .....	15
Multi Channel mode .....	19
Multi Part Editor .....	9, 95
MUTE GROUP .....	101
Mute Groups .....	64
Mute/Solo .....	76

- N**
- NAME/VALUE button ..... 17
  - Nominal level (01X Terminology) ..... 14
  - NUENDO (Remote Function List) ..... 108
- O**
- ON buttons ..... 17
  - ON/OFF (channel) ..... 99
  - OSC (Oscillator) ..... 93
  - OSC. ASSIGN (Oscillator Assign) ..... 93
  - OSCILLATOR ..... 93
  - Oscillator ..... 93
  - Oscillator (Basics Section) ..... 29
  - Oscillator Assign ..... 93
  - Out Gain (Compander) ..... 123
  - Out Gain (Compressor) ..... 122
  - Out Gain (Expander) ..... 123
  - Output channel (Basics Section) ..... 30
  - Output patch (Basics Section) ..... 30
  - OUTPUT PATCH (DIGI. ST/AUX OUT PORT) ..... 91
  - OUTPUT PATCH (DIRECT OUT POSITION) ..... 91
  - OUTPUT PATCH (mLAN OUT CHANNEL) ..... 90
  - OUTPUT PATCH LIBRARY ..... 91
  - Output Patching ..... 61
  - Overview of the 01X (Basics Section) ..... 25
- P**
- PAGE ..... 96
  - PAGE SHIFT button ..... 17
  - PAIR ..... 102
  - Pairing channels ..... 54
  - PAN ..... 99
  - PAN button ..... 19
  - Panning ..... 55
  - PARAM DISP TIME ..... 95
  - Parameter Display Time ..... 95
  - Parameter Lists ..... 115
  - Parameters 1 – 6 ..... 100
  - PATCH ..... 88
  - PATCH LIBRARY ASSIGN ..... 86
  - PEAK HOLD ..... 46
  - PHANTOM +48V switch ..... 22
  - PHASE ..... 99
  - Phase ..... 99
  - PHONES jack ..... 21
  - Pitch Fix ..... 9
  - Play ► button ..... 20
  - Playback ..... 66
  - POST (Aux Send) ..... 100
  - POST FADER ..... 91
  - Power Supply ..... 24
  - Power-on Procedure ..... 24
  - PRE (Aux Send) ..... 100
  - PRE EQ ..... 91
  - PRE FADER ..... 91
  - PREFER (Preference) ..... 95
  - Preference ..... 95
  - Preset Dynamics Library ..... 118
  - Preset Dynamics Parameters/Values ..... 119
  - Preset Effects Library ..... 125
  - Preset EQ Library ..... 115
  - Preset EQ Parameters/Values ..... 116
  - PROGRAM CHANGE ..... 94
  - Program change ..... 87
  - PROGRAM CHANGE ASSIGN TABLE ..... 94
  - Programming markers ..... 74
- R**
- Range (Gate and Ducking) ..... 124
  - Ratio (Compander) ..... 123
  - Ratio (Compressor) ..... 122
  - Ratio (Expander) ..... 123
  - REC bus assign ..... 99
  - REC bus L/R (01X Terminology) ..... 14
  - REC RDY (Record Ready) button ..... 17
  - RECALL SAFE ..... 86
  - RECBUS (REC bus assign) ..... 99
  - Record ● button ..... 20
  - Recording ..... 66
  - Release (Compander) ..... 123
  - Release (Compressor) ..... 122
  - Release (Expander) ..... 123
  - REMOTE ..... 87
  - REMOTE AUTOMATION SETUP ..... 88
  - REMOTE button ..... 18
  - Remote Control ..... 66
  - Remote control setup ..... 66
  - Remote Function List ..... 104
  - REMOTE SELECT ..... 87
  - Reset → Factory Set (Basics Section) ..... 42
  - Restore Factory Defaults (Basics Section) ..... 42
  - Rewind ◀◀ button ..... 20
- S**
- Sampling rate converter ..... 93
  - SAVE button ..... 19
  - Saving your song ..... 83
  - Scene ..... 85
  - SCENE button ..... 18
  - SCENE LIBRARY ..... 85
  - Scenes ..... 65
  - Scenes (01X Terminology) ..... 14
  - SCMS ..... 95
  - SCRUB button ..... 20
  - SEL buttons ..... 17
  - Select the Remote setting to match your sequencer ..... 73
  - SELECTED CHANNEL button ..... 19
  - Selected Channel mode ..... 19
  - Selecting and arming tracks ..... 74
  - SEND ..... 100
  - SEND 1 – 4 (AUX Send Level 1 – 4) ..... 100
  - SEND button ..... 19
  - Serial Copy Management System ..... 95
  - Serial number ..... 6
  - SHIFT + REMOTE FUNCTION ..... 87
  - SHIFT button ..... 19
  - Signal flow between the 01X and  
the DAW on the computer (Basics Section) ..... 25
  - Solo ..... 51
  - SOLO button ..... 17
  - SOLO MODE ..... 96
  - SOLO SAFE ..... 96
  - SONAR (Remote Function List) ..... 110
  - Specifications ..... 149

SQ01 V2 .....	9
SQ01 V2 (Remote Function List) .....	104
STANDBY/ON switch .....	22
ST-BUS (Stereo bus assign) .....	99
Stereo bus assign .....	99
Stereo buses L/R (01X Terminology) .....	14
Stereo fader .....	17
Stereo input channels 1/2 (Basics Section) .....	29
STEREO/AUX OUT jacks .....	21
Stop ■ button .....	20
STORE/RECALL CONFIRMATION .....	95
Studio Manager .....	9
STUDIO MANAGER ID .....	94
Symbol Indications (Basics Section) .....	27

**T**

Table of Contents .....	13
Terminology .....	14
The 01X — What it is and what it can do .....	8
THRESH (Compander) .....	123
THRESH (Compressor) .....	122
THRESH (Expander) .....	123
THRESH (Gate and Ducking) .....	124
Threshold (Compander) .....	123
Threshold (Compressor) .....	122
Threshold (Expander) .....	123
Threshold (Gate and Ducking) .....	124
Title Edit (Basics Section) .....	41
Top Panel .....	16
Touch .....	15
Touch-in/Touch-out (01X Terminology) .....	15
Transport .....	74
Troubleshooting .....	144
Turning on the 01X .....	24
TWE Wave Editor .....	9

**U**

Undo .....	83
UNDO button .....	19
Using Mute (On/Off) .....	51
UTILITY button .....	18
UTILITY MODE .....	86

**V**

Vocal Rack .....	9
------------------	---

**W**

W.CLK (Wordclock) .....	92
W.CLK SELECT (Wordclock Select) .....	92
WAVEFORM .....	93
WHITE NOISE .....	93
Width (Compander) .....	123
Wordclock .....	92
Wordclock Select .....	92
Working in an Editor window .....	76
Working in the Mixer window .....	75
Working in the Project window .....	73
Write-protect .....	86

**Z**

Zoom .....	75
ZOOM button .....	20

# Block Diagram

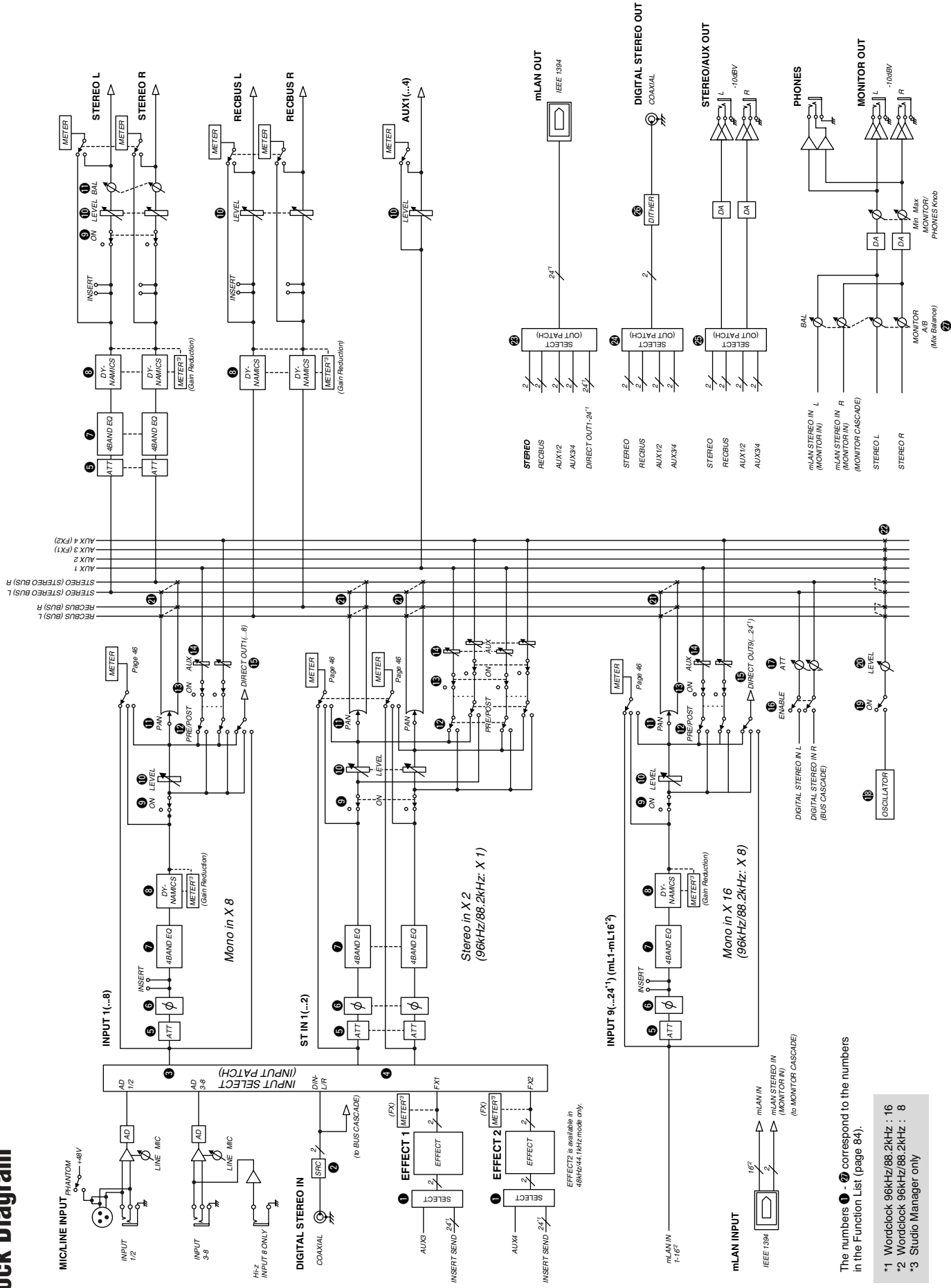

The numbers 1 - 27 correspond to the numbers in the Function List (page 84).

- \*1 Wordclock 96kHz/88.2kHz : 16
- \*2 Wordclock 96kHz/88.2kHz : 8
- \*3 Studio Manager only



For details of products, please contact your nearest Yamaha representative or the authorized distributor listed below.

Pour plus de détails sur les produits, veuillez-vous adresser à Yamaha ou au distributeur le plus proche de vous figurant dans la liste suivante.

Die Einzelheiten zu Produkten sind bei Ihrer unten aufgeführten Niederlassung und bei Yamaha Vertragshändlern in den jeweiligen Bestimmungsländern erhältlich.

Para detalles sobre productos, contacte su tienda Yamaha más cercana o el distribuidor autorizado que se lista debajo.

## NORTH AMERICA

### CANADA

**Yamaha Canada Music Ltd.**  
135 Milner Avenue, Scarborough, Ontario,  
M1S 3R1, Canada  
Tel: 416-298-1311

### U.S.A.

**Yamaha Corporation of America**  
6600 Orangethorpe Ave., Buena Park, Calif. 90620,  
U.S.A.  
Tel: 714-522-9011

## CENTRAL & SOUTH AMERICA

### MEXICO

**Yamaha de Mexico S.A. De C.V.,  
Departamento de ventas**  
Javier Rojo Gomez No.1149, Col. Gpe Del  
Moral, Deleg. Iztapalapa, 09300 Mexico, D.F.  
Tel: 55-5804-0600

### BRAZIL

**Yamaha Musical do Brasil LTDA.**  
Av. Rebouças 2636, São Paulo, Brasil  
Tel: 011-3085-1377

### ARGENTINA

**Yamaha Music Latin America, S.A.  
Sucursal de Argentina**  
Viamonte 1145 Piso2-B 1053,  
Buenos Aires, Argentina  
Tel: 1-4371-7021

### PANAMA AND OTHER LATIN AMERICAN COUNTRIES/ CARIBBEAN COUNTRIES

**Yamaha Music Latin America, S.A.**  
Torre Banco General, Piso 7, Urbanización Marbella,  
Calle 47 y Aquilino de la Guardia,  
Ciudad de Panamá, Panamá  
Tel: +507-269-5311

## EUROPE

### THE UNITED KINGDOM

**Yamaha-Kemble Music (U.K.) Ltd.**  
Sherbourne Drive, Tilbrook, Milton Keynes,  
MK7 8BL, England  
Tel: 01908-366700

### IRELAND

**Danfay Ltd.**  
61D, Sallynoggin Road, Dun Laoghaire, Co. Dublin  
Tel: 01-2859177

### GERMANY

**Yamaha Music Central Europe GmbH**  
Siemensstraße 22-34, 25462 Rellingen, Germany  
Tel: 04101-3030

### SWITZERLAND/LIECHTENSTEIN

**Yamaha Music Central Europe GmbH,  
Branch Switzerland**  
Seefeldstrasse 94, 8008 Zürich, Switzerland  
Tel: 01-383 3990

### AUSTRIA

**Yamaha Music Central Europe GmbH,  
Branch Austria**  
Schleiergasse 20, A-1100 Wien, Austria  
Tel: 01-60203900

### THE NETHERLANDS

**Yamaha Music Central Europe,  
Branch Nederland**  
Clarissenhof 5-b, 4133 AB Vianen, The Netherlands  
Tel: 0347-358 040

## BELGIUM/LUXEMBOURG

**Yamaha Music Central Europe GmbH,  
Branch Belgium**  
Rue de Geneve (Genevastraat) 10, 1140 - Brussels,  
Belgium  
Tel: 02-726 6032

## FRANCE

**Yamaha Musique France**  
BP 70-77312 Marne-la-Vallée Cedex 2, France  
Tel: 01-64-61-4000

## ITALY

**Yamaha Musica Italia S.P.A.  
Combo Division**  
Viale Italia 88, 20020 Lainate (Milano), Italy  
Tel: 02-935-771

## SPAIN/PORTUGAL

**Yamaha-Hazen Música, S.A.**  
Ctra. de la Coruna km. 17, 200, 28230  
Las Rozas (Madrid), Spain  
Tel: 91-639-8888

## GREECE

**Philippos Nakas S.A. The Music House**  
147 Skiathou Street, 112-55 Athens, Greece  
Tel: 01-228 2160

## SWEDEN

**Yamaha Scandinavia AB**  
J. A. Wettergrens Gata 1  
Box 30053  
S-400 43 Göteborg, Sweden  
Tel: 031 89 34 00

## DENMARK

**YS Copenhagen Liaison Office**  
Generatorvej 8B  
DK-2730 Herlev, Denmark  
Tel: 44 92 49 00

## FINLAND

**F-Musiikki Oy**  
Kluuvikatu 6, P.O. Box 260,  
SF-00101 Helsinki, Finland  
Tel: 09 618511

## NORWAY

**Norsk filial av Yamaha Scandinavia AB**  
Grini Næringspark 1  
N-1345 Østerås, Norway  
Tel: 67 16 77 00

## ICELAND

**Skifan HF**  
Skeifan 17 P.O. Box 8120  
IS-128 Reykjavik, Iceland  
Tel: 525 5000

## OTHER EUROPEAN COUNTRIES

**Yamaha Music Central Europe GmbH**  
Siemensstraße 22-34, 25462 Rellingen, Germany  
Tel: +49-4101-3030

## AFRICA

**Yamaha Corporation,  
Asia-Pacific Music Marketing Group**  
Nakazawa-cho 10-1, Hamamatsu, Japan 430-8650  
Tel: +81-53-460-2312

## MIDDLE EAST

### TURKEY/CYPRUS

**Yamaha Music Central Europe GmbH**  
Siemensstraße 22-34, 25462 Rellingen, Germany  
Tel: 04101-3030

### OTHER COUNTRIES

**Yamaha Music Gulf FZE**  
LB21-128 Jebel Ali Freezone  
P.O.Box 17328, Dubai, U.A.E.  
Tel: +971-4-881-5868

## ASIA

### THE PEOPLE'S REPUBLIC OF CHINA

**Yamaha Music & Electronics (China) Co.,Ltd.**  
25/F., United Plaza, 1468 Nanjing Road (West),  
Jingan, Shanghai, China  
Tel: 021-6247-2211

### HONG KONG

**Tom Lee Music Co., Ltd.**  
11/F., Silvercord Tower 1, 30 Canton Road,  
Tsimshatsui, Kowloon, Hong Kong  
Tel: 2737-7688

### INDONESIA

**PT. Yamaha Music Indonesia (Distributor)  
PT. Nusantik**  
Gedung Yamaha Music Center, Jalan Jend. Gatot Sub-  
roto Kav. 4, Jakarta 12930, Indonesia  
Tel: 21-520-2577

### KOREA

**Yamaha Music Korea Ltd.**  
Tong-Yang Securities Bldg. 16F 23-8 Yoido-dong,  
Youngdungpo-ku, Seoul, Korea  
Tel: 02-3770-0660

### MALAYSIA

**Yamaha Music Malaysia, Sdn., Bhd.**  
Lot 8, Jalan Perbandaran, 47301 Kelana Jaya,  
Petaling Jaya, Selangor, Malaysia  
Tel: 3-78030900

### PHILIPPINES

**Yupangco Music Corporation**  
339 Gil J. Puyat Avenue, P.O. Box 885 MCPO,  
Makati, Metro Manila, Philippines  
Tel: 819-7551

### SINGAPORE

**Yamaha Music Asia Pte., Ltd.**  
No.11 Ubi Road 1, No.06-02,  
Meiban Industrial Building, Singapore  
Tel: 747-4374

### TAIWAN

**Yamaha KHS Music Co., Ltd.**  
3F, #6, Sec.2, Nan Jing E. Rd. Taipei.  
Taiwan 104, R.O.C.  
Tel: 02-2511-8688

### THAILAND

**Siam Music Yamaha Co., Ltd.**  
891/1 Siam Motors Building, 15-16 floor  
Rama 1 road, Wangmai, Pathumwan  
Bangkok 10330, Thailand  
Tel: 02-215-2626

### OTHER ASIAN COUNTRIES

**Yamaha Corporation,  
Asia-Pacific Music Marketing Group**  
Nakazawa-cho 10-1, Hamamatsu, Japan 430-8650  
Tel: +81-53-460-2317

## OCEANIA

### AUSTRALIA

**Yamaha Music Australia Pty. Ltd.**  
Level 1, 99 Queensbridge Street, Southbank,  
Victoria 3006, Australia  
Tel: 3-9693-5111

### NEW ZEALAND

**Music Houses of N.Z. Ltd.**  
146/148 Captain Springs Road, Te Papapa,  
Auckland, New Zealand  
Tel: 9-634-0099

### COUNTRIES AND TRUST

### TERRITORIES IN PACIFIC OCEAN

**Yamaha Corporation,  
Asia-Pacific Music Marketing Group**  
Nakazawa-cho 10-1, Hamamatsu, Japan 430-8650  
Tel: +81-53-460-2312

SY33

**HEAD OFFICE** Yamaha Corporation, Pro Audio & Digital Musical Instrument Division  
Nakazawa-cho 10-1, Hamamatsu, Japan 430-8650  
Tel: +81-53-460-2445

This document is printed on chlorine free (ECF) paper with soy ink.

Yamaha Web Site (English only)  
<http://www.yamahasynth.com>

Yamaha Manual Library  
<http://www2.yamaha.co.jp/manual/english/>



U.R.G., Pro Audio & Digital Musical Instrument Division, Yamaha Corporation  
© 2003 Yamaha Corporation

WB29310 312POCP2.3-02B0 Printed in Japan